

JLDUOS705

Built-under double oven

Instruction manual

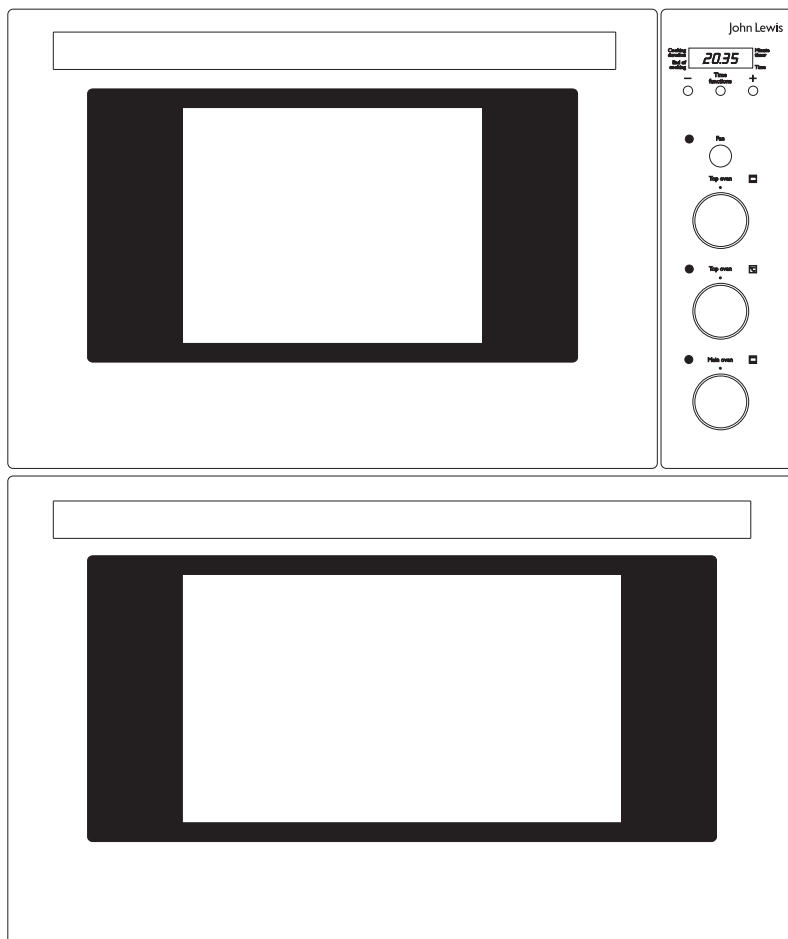

John Lewis

Important Safety Information

It is most important that this instruction manual should be retained with the appliance for future reference. Should the appliance be sold or transferred to another owner, or should you move house and leave the appliance, always ensure that the manual is supplied with the appliance in order that the new owner can get to know the functioning of the appliance and the relevant warnings.

These warnings have been provided in the interest of safety. You **MUST** read them carefully before use or installation by a qualified person. If you are unsure of the meanings of these warnings contact the John Lewis branch from which you purchased the appliance.

Installation

- The appliance must be installed according to the instructions supplied. The installation work must be undertaken by a qualified electrician or competent person.
- The appliance must be installed in an adequately ventilated room.
- It is imperative that the appliance is left in the base to protect both the appliance and the floor.
- This appliance is heavy and care must be taken when moving it.
- Do not attempt to lift or move this appliance by the handles.
- All packaging, both inside and outside the appliance must be removed before the appliance is used.
- It is dangerous to alter the specifications or modify the appliance in any way.
- After installation please dispose of the packaging with due regard for safety and the environment. Your local authority can arrange this.

Child Safety

- Do not allow children to play with any part of the packaging.
- Do not allow children to sit or climb on the drop down doors.
- This appliance is designed to be operated by adults. Young children must not be allowed to tamper with the controls or play near or with the appliance.
- **CAUTION:** Accessible parts may be hot when the grill is in use. Young children should be kept away.

Use

- This appliance is not intended to be operated by means of an external timer or separate remote control system.
- This appliance has been designed for domestic use to cook edible foodstuffs only and must not be used for any other purposes.
- Take great care when heating fats and oils as they will ignite if they become too hot.
- Never place plastic or any other material which may melt in or on the oven.
- Do not leave the grill pan handle in position when grilling as it will become hot.

- Always support the grill pan when it is in the withdrawn or partially withdrawn position.
- Always use oven gloves to remove and replace the grill pan handle when grilling.
- Always use oven gloves to remove and place food in the oven.
- During use the appliance becomes hot. Care should be taken to avoid touching heating elements inside the oven.
- Ensure that all vents are not obstructed to ensure ventilation of the oven cavity.
- Never line any part of the appliance with foil.
- Always stand back from the appliance when opening the doors to allow any build up of steam or heat to release.
- **Never leave the appliance unattended when the oven door is open.**
- Do not place sealed cans or aerosols inside the oven. They may explode if they are heated.
- Ensure that all control knobs are in the OFF position when not in use.
- Do not stand on the appliance or on the open oven doors.
- Do not hang towels, dishcloths or clothes from the appliance or its handles.
- Do not use this appliance if it is in contact with water. Never operate it with wet hands.

Maintenance and Cleaning

- **For hygiene and safety reasons this appliance should be kept clean at all times. A build-up of fats or other foodstuffs could result in a fire especially in the grill pan.**
- Do not leave the cookware containing foodstuffs, e.g. fat or oil in the appliance in case it is inadvertently switched on.
- Always allow the appliance to cool before switching off at the wall prior to carrying out any cleaning / maintenance work.
- Only clean this appliance in accordance with the instructions given in this manual.
- Never use steam or high pressure steam cleaners to clean the appliance.

Service

- The appliance should be serviced by an authorised Service Engineer and only genuine approved spare parts should be used.

Contents

For the User

Important Safety Information	2
Description of the Appliance	4
The Control Panel	10
When the Oven is first Installed	11
Rating Plate	11
Preparing to Use Your Appliance	11
When First Switching On	11
The Cooling Fan for the Controls	11
Control Panel Indicator Neon(s)	11
Condensation and Steam	11
Cookware	11
Grill and Oven Furniture	11
Electronic Timer	12
Dual Grill	15
How to use the Dual Grill	15
Things to Note	15
The Grill Pan and Handle	15
Hints and Tips	16
Grilling Chart	16
Fan Assisted Top Oven	17
How to use the Fan Assisted Top Oven	17
Things to Note	17
To Fit the Top Oven Shelf	17
Hints and Tips	18
Conventional Top Oven	19
How to use the Conventional Top Oven	19
Things to Note	19
To Fit the Top Oven Shelf	19
Hints and Tips	20
Cooking Chart - Conventional and Fan Assisted Oven	21
Thermal Grilling in the Top Oven	22
How to use Thermal Grill in the Top Oven	22
Things to Note	22
Hints and Tips	23
Thermal Grilling Chart	23
Defrost in the Top Oven	24
How to use Defrost in the Top Oven	24
Things to Note	24
Hints and Tips	24
Main Fan Oven	25
How to use the Main Fan Oven	25
Things to Note	25
To Fit the Main Fan Oven Shelves	26
Hints and Tips	26
Main Fan Oven Cooking Chart	27
Roasting Chart	28
Defrost in the Main Oven	29
How to use Defrost in the Main Oven	29
Things to Note	29
Hints and Tips	29

Cleaning the Oven	30
Cleaning Materials	30
External Cleaning	30
How to Remove and Replace the Wirework Runners	30
Cleaning Inside the Ovens	31
Hints and Tips	31
Cleaning the Door(s)	32
Cleaning the Shelves, Wirework Runners and Grill/Oven Furniture	33
How to Replace the Oven Light	33
Something Not Working	34
Repairs – After Sales Service	35

For the Installer

Installation	5
Technical Data	5
Electrical Connection	5
Things to Note	6
How to Finish Unpacking	7
To Remove Cover of Mains Terminal	7
Connecting to the Mains Terminal	8
Checking Electrical Connections	8
Connecting to a Hob or Cooker Point	8
Building In	9

Guide to use the Instruction Manual

The following symbols will be found in the text to guide you throughout the instructions:



Safety Instructions



Step by step instructions for an operation



Hints and Tips



Environmental Information



Environmental Information

The symbol  on the product or on its packaging indicates that this product may not be treated as household waste. Instead it shall be handed over to the applicable collection point for the recycling of electrical and electronic equipment. By ensuring this product is disposed of correctly, you will help prevent potential negative consequences for the environment and human health, which could otherwise be caused by inappropriate waste handling of this product. For more detailed information about recycling of this product, please contact your local city office, your household waste disposal service or the shop where you purchased the product.

Description of the Appliance

- 1 Electronic Timer
- 2 Top Oven/Grill
- 3 Control Panel
- 4 Main Oven

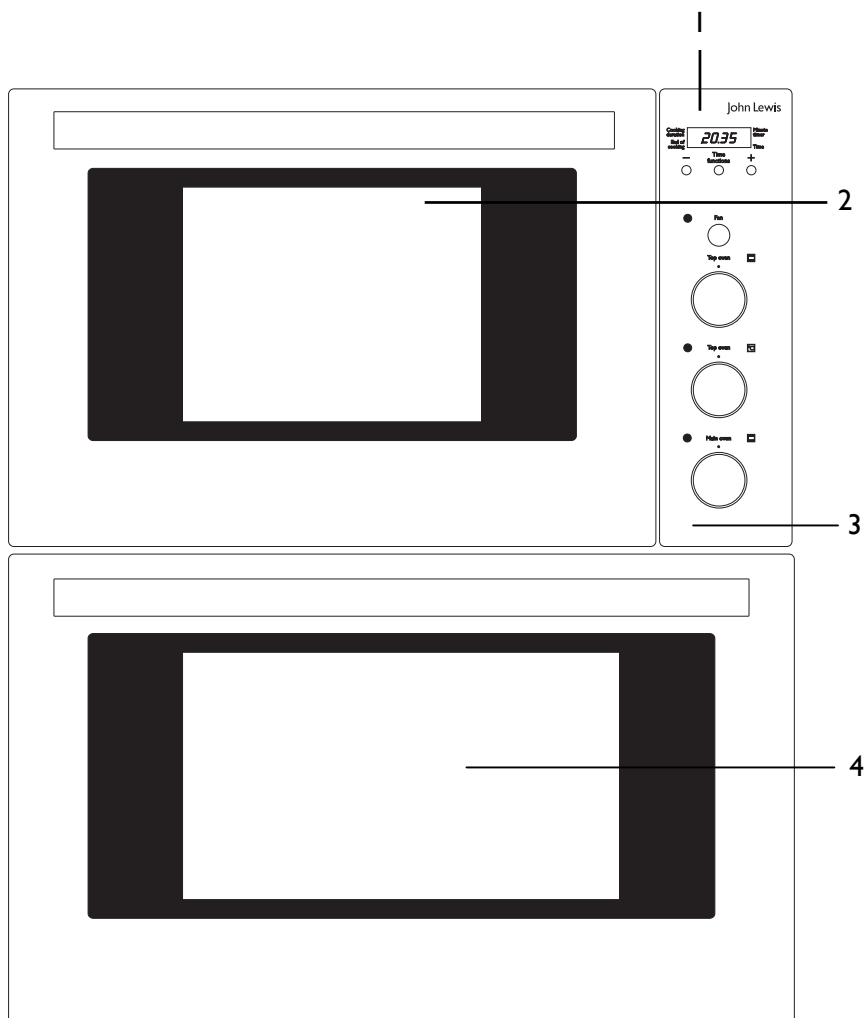

Your built-under appliance comprises of a conventional oven and dual grill in the top compartment. The main fan oven can be automatically controlled by the electronic timer.

Installation

Technical Data

Voltage:	230-240 Volts AC 50Hz
Wattage:	5.0-5.5kW
Height:	720 mm
Width:	593 mm
Depth:	585 mm
(excluding handles and knobs)	
Weight:	52kg

CE This appliance complies with:
 European Council Directive
 73/23/EEC.
 EMC Directive 89/336/EEC.
 CE Marking Directive 93/68/EEC.
 Energy Label Directive 2002/40/EC.

Electrical Connection

 THIS OVEN MUST BE EARTHED

Electrical Requirements

This appliance must be installed by a qualified electrician/competent person. Safety may be impaired if installation is not carried out in accordance with these instructions.

Do not remove the screws from the earth tab extending from the oven mains terminal block (Fig. 1).

Before connecting the appliance make sure that the voltage of your electricity supply is the same as that indicated on the rating plate. This is situated on the lower front frame of the appliance and can be seen upon opening the door. Alternatively the rating plate may also be found on the back or top of some models (where applicable).

Do not alter the electrical circuitry of this appliance.

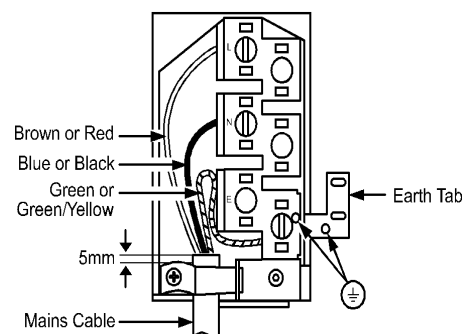

Fig. 1

Electrical Connection

The cable used to connect the oven to the electrical supply must comply to the specifications given below.

Connection Via	Min. size Cable/flex	Cable/flex type	Fuse
• Cooker Control Circuit	6mm ²	PVC/PVC twin and earth	35 A (min)

By connecting the appliance to a cooker point having a double pole isolating switch providing at least 3mm contact separation in all poles and protected with a fuse or miniature circuit breaker at your mains fuse box.

If you wish to connect an oven and a hob to a cooker point you can, by connecting the oven and hob separately to the cooker point. See Fig. 2.

NOTE: It is good practice to :

Fit an Earth Leakage Circuit Breaker to your house wiring.

Wire your appliance to the latest IEE regulations.

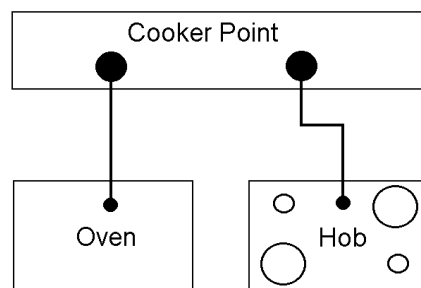

Fig. 2

Things to Note

- This appliance is designed to be fitted between cabinets with the recommended dimensions as shown in Fig. 3 & 4.
- If there is an existing housing unit it must be removed.
- The dimensions given provide adequate air circulation around the unit within the cabinet, ensuring compliance with BS EN60-335.
- This appliance must not be installed on a wooden base board.
- Enquiries regarding the installation of the cooker point, if required, should be made to your Regional Electricity Company to ensure compliance with their regulations.
- The cooker point should be within 2m of the appliance to make it accessible to switch off the appliance in case of an emergency.
- To protect the hands, wear gloves when lifting the oven into its housing.



Do not lift the appliance by the handles.

Note: House Circuit

Earth leakage / continuity tests must be carried out before the appliance is connected to the mains supply and re-checked after fitting.

- Make sure the space between the cabinets is the correct size for the appliance to be fitted (Ref. Fig. 5 & 6).
- The plinth board spanning the space into which the appliance is to be installed should be removed.
- If the size between adjacent cabinets is 605-610mm, then the cabinets should be modified so that the recommended dimension of at least 600-605mm is maintained.
- The adjacent cabinets must be stable and firmly secured to the wall or floor. If necessary, make arrangements to ensure the work surface below which the oven will rest is level.
- Drill two pilot screw holes into the sides of the adjacent cabinets, in the positions indicated by Fig. 5.
- Fit the appliance mounting brackets using the two holes indicated in Fig.7 to the adjacent cabinets (Ref. Fig.5 & 6).
- Check that the mounting brackets are level. They can be adjusted if necessary by using the extra holes at the ends of the brackets. Once the brackets are level, drill a pilot hole through the central hole in the bracket and fit the remaining screw.

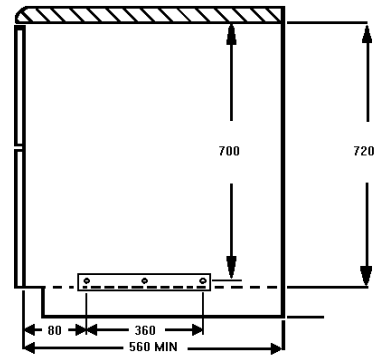

Fig. 3

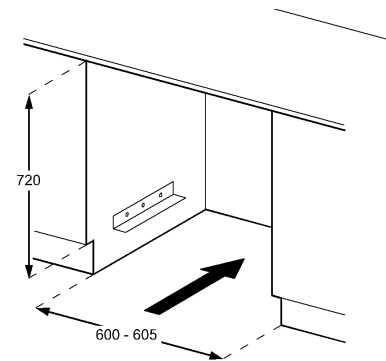

Fig. 4

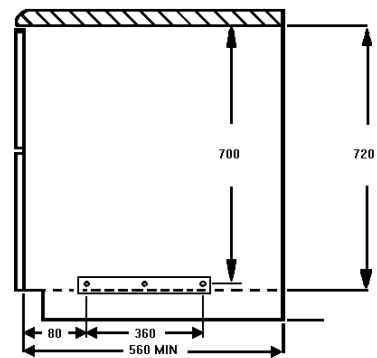

Fig. 5

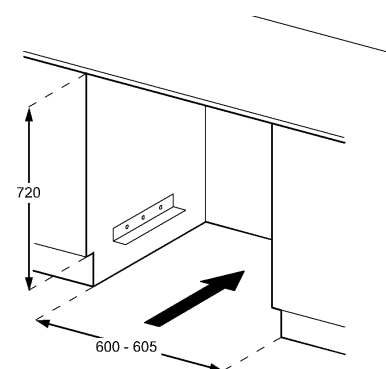

Fig. 6

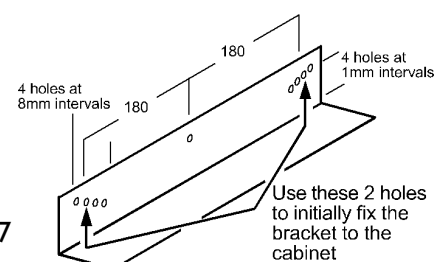

Fig. 7

How to Finish Unpacking

- Place packed appliance next to the space in which it will be installed.
- Remove the appliance packing except for bottom tray which should be left in position until the appliance is ready to be fitted into its cabinet.

NOTE: It is imperative that the appliance is left in the base to protect both the appliance and the floor.

- Ensure the owner is given these operating instructions.



Important: Switch off at mains, miniature circuit breaker and if appropriate, remove fuse before commencing any electrical work.

To Remove Cover of Mains Terminal

From the rear of the appliance, remove mains input terminal cover to gain access to terminal block.

- First remove retaining screw with pozidrive screwdriver. See Fig. 8.
- Prise cover loose using screwdriver in position (1) then lever off with screwdriver in position (2) at either side. See Fig. 9.
- Lift cover and remove screw from cable clamp. See Fig. 10.

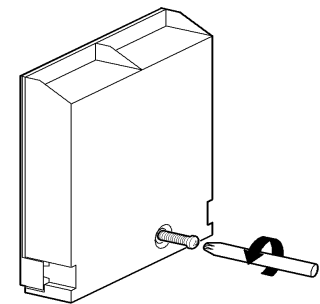

Fig. 8

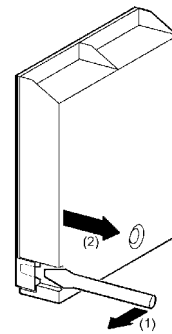

Fig.9

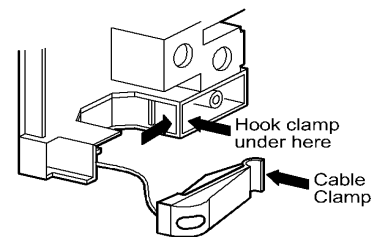



Fig.10

Connecting to the Mains Terminal

 **Warning:** This appliance must be earthed.

- We recommend you use a new length of 6mm² twin core and earthed cable to ensure your safety.
- Make connection as shown in Fig.11 by proceeding as follows:-
- Preform wires to the appropriate shape to suit fitting into the mains terminal block.
- Strip inner insulation on wires using wirestrippers.
- Twist the bared wires using pliers.
- Cut bared wires 10mm away from the end of the inner insulation. Where uninsulated Earth wires are used ensure they are suitably sheathed to leave 10mm bare wire fit into the terminal.
- Clamp bare wires into the relevant terminal and check they are held by tugging each one in turn.
- Clamp the mains cable securely ensuring 5mm of the outer insulation is inside the terminal block and that the wires are not taugt but not so slack as to cause any fouling. See Fig. 11.
- Connect the remaining end of the mains cable to the cooker point / junction box.
- Place fuse / miniature circuit breaker in circuit and switch on at mains.

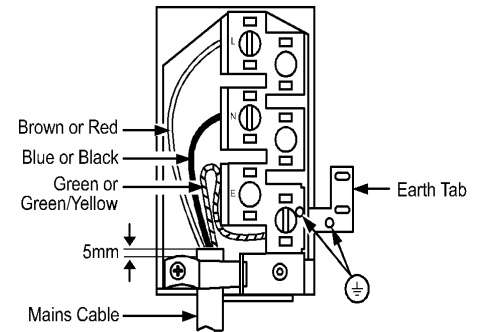

Fig. 11

Checking Electrical Connections

- Correct electrical connection can be confirmed when switching on the appliance as the timer will be flashing.

Note: House Circuit

Earth leakage / continuity tests must be carried out before the appliance is connected to the mains supply and re-checked after fitting.

Connecting to a Hob or Cooker Point

- Either follow in general terms the instructions for connecting to the terminal block or refer to the hob suppliers installation instructions.

 **Feed the cable through the cabinet and arrange to route the cable away from the appliance, which may become hot.**

Building In



IMPORTANT: Ensure that the oven is switched off at the wall before any further work is carried out.

- Position the appliance in front of the cabinet. See Fig. 12.
- Take out all oven furniture before installation to reduce the weight you need to lift. The oven door should be taped up to keep it closed.
- To place the appliance into the space between cabinetry follow the procedure below:
- **N.B. Two people will be required to carry out the lifting procedure.**



Warning: Do not attempt to lift this appliance by the handle(s).

- Each person should squat either side of the appliance.
- Tilt the appliance so that your hands can support the underside of the appliance.
- Keeping your back straight, raise the appliance to the correct height by straightening at the knees.
- Rest the rear underside of the appliance on the mounting brackets while your hands support the front.
- The appliance can be pushed fully into the space. Take care to avoid damaging the mains lead.
- Ensure the appliance is central and level.
- When the appliance is fully housed, screw the stability screws (supplied with the appliance) into the underside of the work surface in the positions indicated (see Fig. 13), taking care not to distort the trim. It is advisable to turn each screw alternatively to avoid damaging the trim.
- Place the heat deflector flush with the edge of the work surface with the cork spacers up over (see Fig.14) and screw into position using the screws supplied with the appliance. Failure to do this may cause damage to the underside of the work surface.
- Replace the plinth board.
- Switch on the appliance and refer the user to the operating instructions.

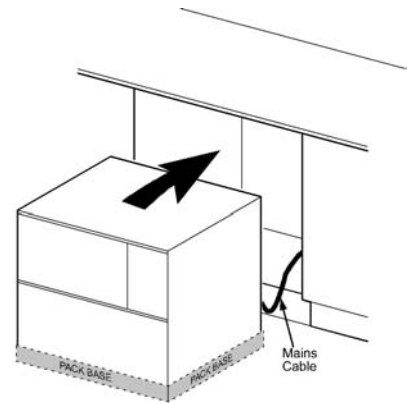

Fig. 12

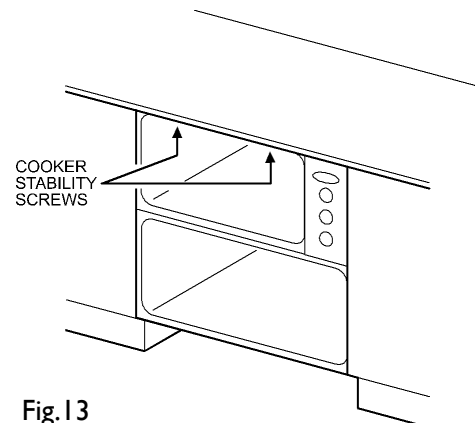

Fig. 13

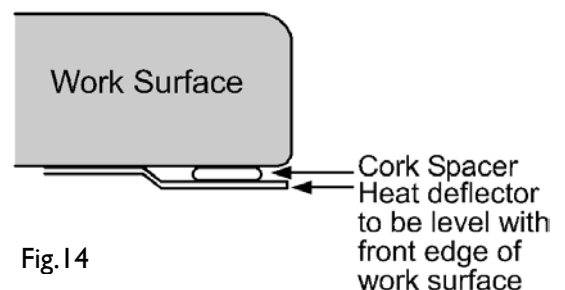
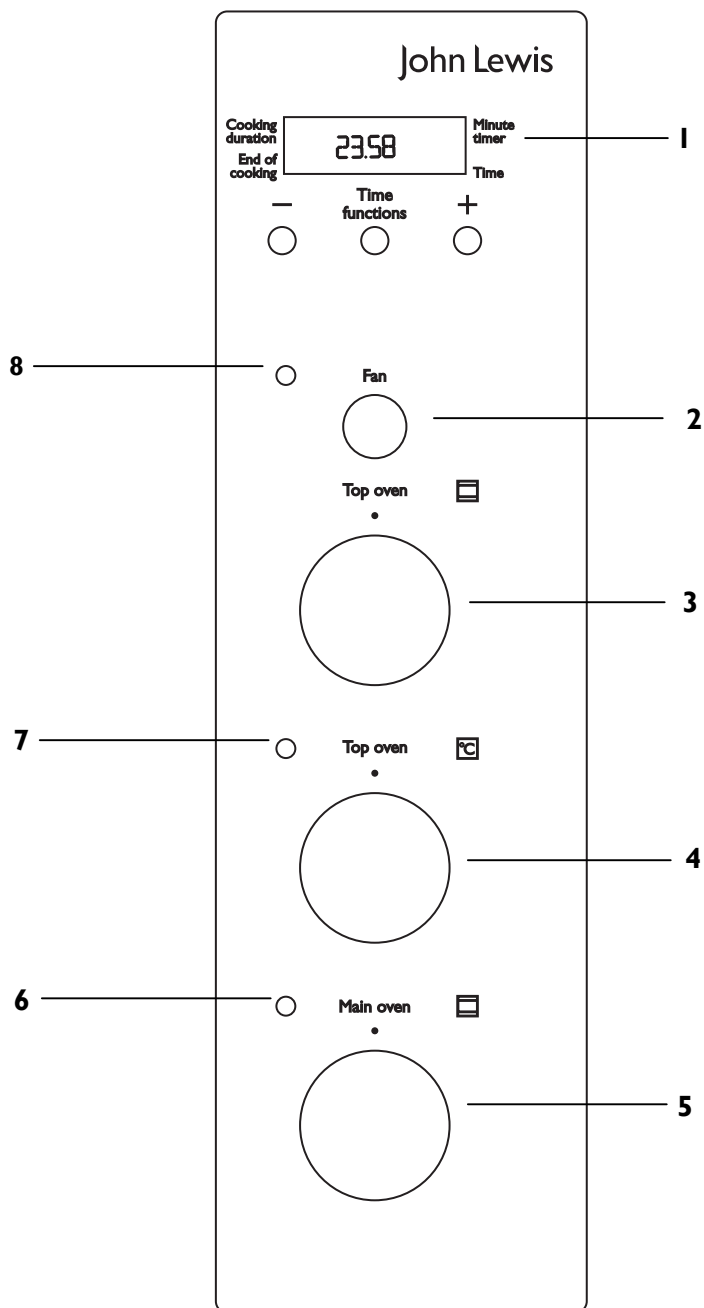



Fig. 14

The Control Panel



- 1 Electronic Timer
- 2 Fan Selector button for Top Oven
- 3 Top Oven/Grill Selector control
- 4 Top Oven/Grill Temperature Control
- 5 Main Oven Temperature Control
- 6 Main Oven Indicator Neon
- 7 Top Oven/Grill Indicator Neon
- 8 Fan Selector Indicator Neon

When the oven is first installed

 Remove **all packaging**, both inside and outside the oven including the advertising labels and any protective film, before using the oven.

Rating Plate

This is situated on the lower front frame of the appliance and can be seen upon opening the door. Alternatively the rating plate may also be found on the back or top of some models (where applicable). The appliance must be protected by a suitably rated fuse or circuit breaker. The rating of the appliance is given on the rating plate.

Do not remove the rating plate from the appliance as this may invalidate the guarantee.

Preparing to use your Appliance

Wipe over the base of the oven(s) with a soft cloth and hot soapy water and wash the furniture before use. We suggest that you run the oven elements for 10 – 15 minutes at 220°C to burn off any residue from their surfaces. The procedure should be repeated with the grill for approximately 5 – 10 minutes. During this period an odour may be emitted, it is therefore advisable to open a window for ventilation.

When first switching on

The oven has a 24 hour clock. When the oven is first switched on at the wall the electronic display will automatically show 12.00, and the 'Time' indicator neon will also flash.

The Cooling Fan for the Controls

The cooling fan comes on immediately when the grill is switched on and after a short time when the oven is in use. It runs on after the controls are switched off until the appliance has cooled. During the initial period the cooling fan may turn ON and OFF, this is quite normal.

 **Always allow the cooling fan to cool the appliance down before switching off at the wall prior to carrying out any cleaning or maintenance work.**

Control Panel Indicator Neon(s)

The indicator neon will operate when the grill (where applicable) or oven(s) is switched on. The indicator neon will glow. It may turn on and off during use to show that the setting is being maintained.

If the neon does not operate as the instructions indicate the controls have been incorrectly set. Return all controls to zero and reset following the instructions for the required setting.

Condensation and Steam

When food is heated it produces steam similar to a boiling kettle. The vents allow some of this steam to escape. However, always stand back from the appliance when opening the door(s) to allow any build up of steam or heat to release.

If the steam comes into contact with a cool surface on the outside of the appliance, e.g. a trim, it will condense and produce water droplets. This is quite normal and is not caused by a fault on the appliance. To prevent discolouration, regularly wipe away condensation and also soilage from surfaces.

Cookware

Baking trays, dishes etc., should not be placed directly against the grid covering the fan at the back of the oven.

Important!

Do not use baking trays larger than 30cm x 35cm (12" x 14") as they will restrict the circulation of heat and may affect performance.

Grill and Oven Furniture

The following items have been supplied with the appliance.

1 grill pan

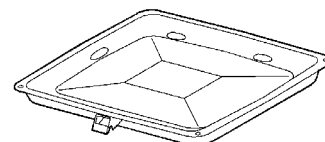

1 grill pan handle

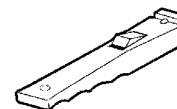

1 grill pan grid

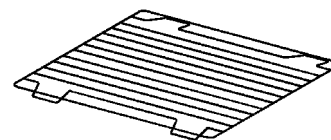

1 straight shelf (for grilling and Top Oven cooking)

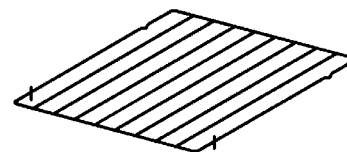

2 straight shelves (for Main Oven cooking)

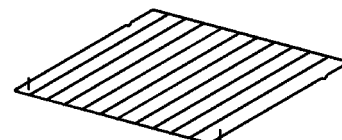

Electronic Timer

KEY

- A Cooking Duration
- B End of cooking
- C Minute Timer
- D Time
- E Decrease Control
- F Time functions
- G Increase Control

Important!

The time of day must be set before the main oven will operate manually.

How to set the Time of Day

The oven has a 24 hour clock.

When the electricity supply is first switched ON, the display will show 12.00 and the 'Time' indicator neon will flash as Fig. 1.

To set the correct time press the increase control button (+) and if necessary, the decrease control button (-) until the correct time on the 24 hour clock is reached, e.g. 10.00am as Fig.2. The 'Time' indicator neon will flash for 5 seconds and then go out.

Important! The increase and decrease control buttons operate slowly at first, and then more rapidly. They should be pressed separately.

How to set the Minute Timer

The 'Minute timer' gives an audible reminder at the end of any period of cooking. This cooking period may be up to 2 hrs 30 mins. It is not part of the automatic control.

To set, press the Time Functions control button until the 'Minute Timer' indicator neon is illuminated the display reads 0.00 as Fig.3.

To set the correct time duration depress the increase control (+) until the display indicates the interval to be timed, e.g. 1hr 45 mins as Fig. 4. If necessary depress the decrease control (-) to achieve the correct time interval.

Important! This must be completed within 5 seconds of first pressing the Selector Control button.

During the operation of the 'Minute Timer', the remaining time period will be shown in the display. The 'Minute timer' will sound intermittently for up to 2 minutes at the end of the timed period. The sound can be stopped by pressing any button.

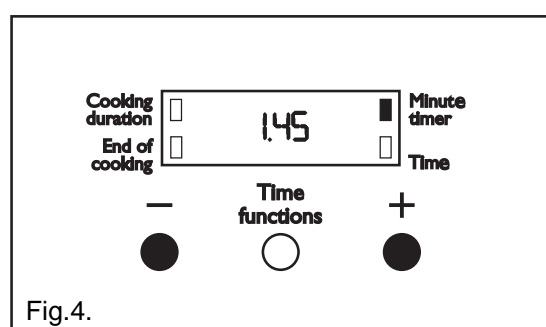
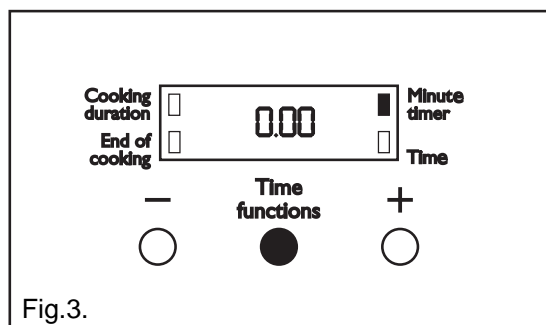
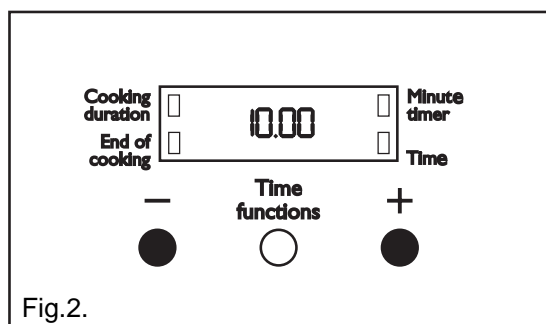
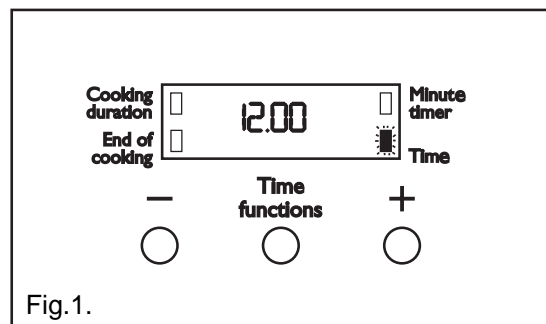
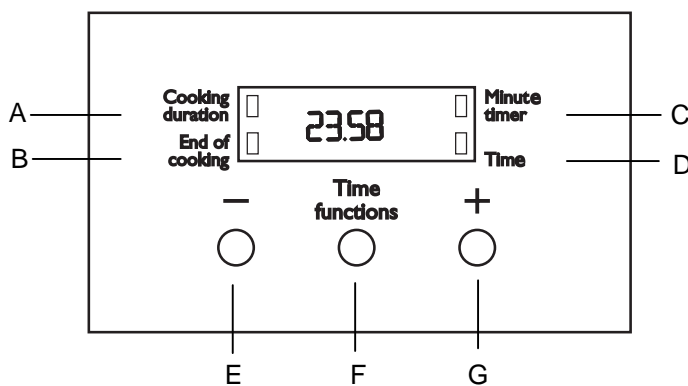

To cancel the Minute Timer

If you change your mind and want to cancel the 'Minute Timer', press the Time Functions control button until the 'Minute Timer' indicator neon flashes and then the decrease control (-) until 0.00 shows in the display as Fig. 5. The 'Minute Timer' indicator neon will continue to flash for a few seconds and then return to the time of day.

Setting the Oven Timer Control

The main oven only can be automatically timed. When using the timer control for the very first time, it is advisable to let it operate while you are at home. The displays can be checked to show that it is operating correctly and you will feel confident to leave a meal to cook automatically in the future.

A) To set the Timer to switch on and off Automatically

- 1) Ensure the electricity supply is switched ON and that the correct time of day is displayed, e.g. 9.am. as Fig. 6.
- 2) Place food in the oven.
- 3) To set the length of cooking time, press the Time Functions control button until the 'Cooking Duration' indicator neon is illuminated. Press the increase control (+) until the required length of cooking time is displayed, e.g. 2 hrs 15 mins as Fig. 7. If necessary depress the decrease control (-) until the correct time interval is achieved. The maximum cooking time is 10 hours.
- 4) Release the buttons. The 'Cooking Duration' indicator neon will be illuminated.

Remember, this must be completed within 5 seconds of first pressing the Selector Control button.

- 5) To set the 'End of cooking'. Press the Time Functions control button until the 'End of cooking' indicator neon flashes. Press the increase control (+) until the required stop time is displayed, e.g. 12.15 p.m. as Fig. 8. If necessary depress the decrease control (-) until the correct time interval is achieved.
- 6) Release the buttons. The time of day will be displayed after 5 seconds. The 'Cooking duration' and 'End of cooking' indicator neons will be illuminated. The 'End of cooking' must not be more than 23 hours 59 minutes from the time of day. For example, if the time of day is 09.00 a.m., the latest 'End of cooking' would be 08.59 a.m. the next day.
- 7) Set the main oven control to the required temperature. The oven indicator neon should be OFF.

Important! When the automatic timed period starts, the oven indicator neon will glow. It may turn on and off during use to show that the setting is being maintained.

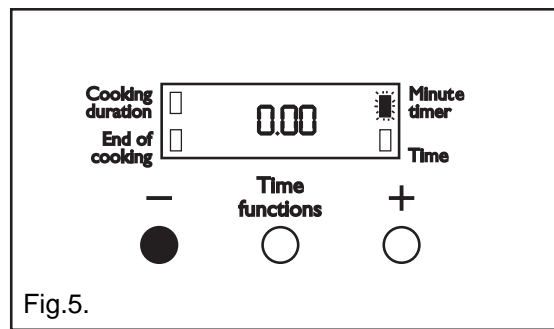

Fig.5.

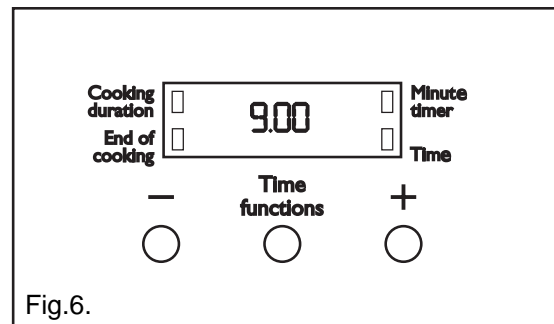

Fig.6.

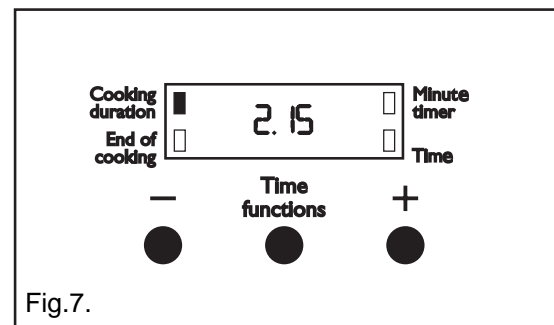

Fig.7.

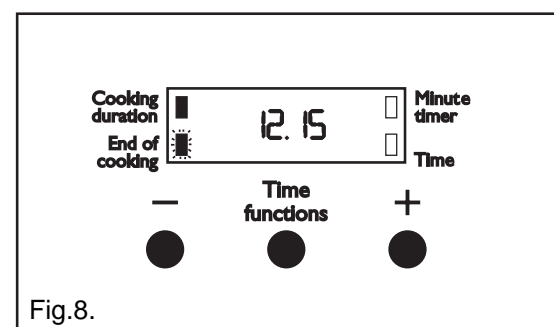

Fig.8.

B) To set the Timer to switch off only

- 1) Ensure the electricity supply is switched ON and that the correct time of day is displayed, e.g. 10.00am as Fig. 9.
- 2) Place food in the oven.
- 3) To set the length of cooking time, press the Time functions control button until the 'Cooking duration' indicator neon is illuminated. Press the increase control (+) until the required length of cooking time is displayed, e.g. 2 hrs 15 mins as Fig. 10. Depress the decrease control (-) if necessary.
- 4) Release the buttons. The 'Cooking duration' indicator neon will illuminate and the time of day will be displayed after 5 seconds.
- 5) Set the oven temperature. The oven indicator neon should be ON.
- 6) To check the 'End of cooking' during the cooking period, simply press the Time functions control button once and the remaining time will be displayed, as Fig. 11.

To Cancel an Automatic Programme

- 1) To cancel an automatic programme press the Time functions control button until the 'Cooking duration' indicator neon flashes. Press the decrease control (-) until the display reads 0.00 as Fig. 12.
- 2) Release the buttons. The 'Cooking duration' indicator neon will flash and after 5 seconds return to the time of day.
- 3) Turn off the oven controls.

To Return the Appliance to Manual

At the end of a timed cooking period, the indicator neon will flash and an alarm will sound for up to 2 minutes.

- 1) To stop the sound press any of the three buttons, as Fig. 13.
- 2) The display will return to the time of day.
- 3) Turn off the oven controls.

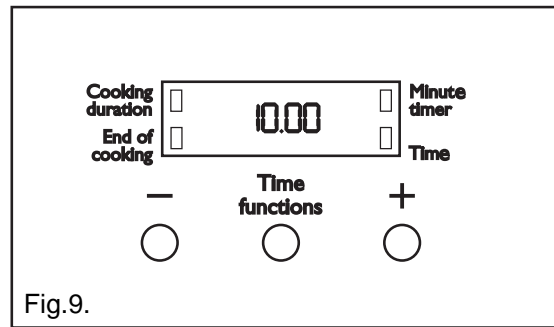

Fig.9.

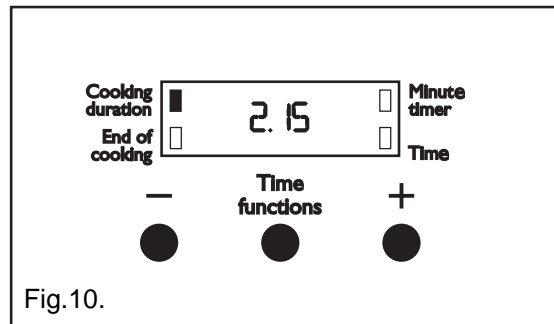

Fig.10.

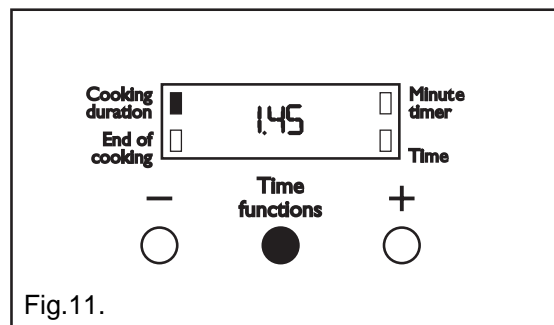

Fig.11.

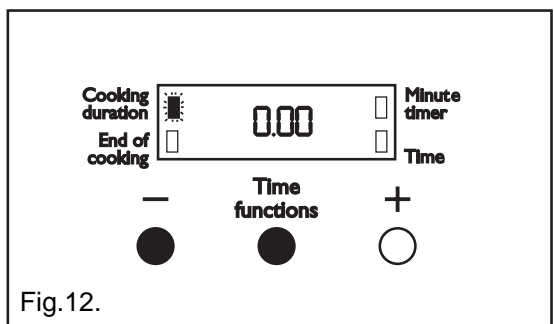

Fig.12.

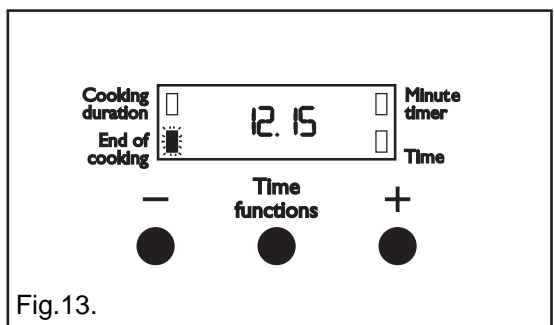

Fig.13.

Dual Grill

CAUTION – Accessible parts may be hot when the grill is in use. Young children should be kept away.

The grill is a dual circuit grill which means that the full area of the grill can be used, or for economy purposes, the centre section only can be used when cooking smaller quantities of food.

How to use the Dual Grill

- Push out and turn the top oven/grill selector to full grill. ▼▼▼
- Push out and turn the top oven/grill selector to centre section only. ▼▼
- Turn the top oven/grill temperature control knob to the right as far as it will go. This is the hottest setting.
- To use the grill at lower settings, turn the temperature control knob to 100°C or 150°C.

Things to Note

- The oven light will illuminate.
- The indicator neon will glow. It may turn ON and OFF during use to show that the setting is being maintained.
- The cooling fan for the controls may operate after a time.
- We recommend using the grill pan on the shelf in positions 3 or 5.
- The grill may be used with the door open or with the door closed.

Ensure the grill pan is properly located.

The Grill Pan and Handle

The grill pan has a removable handle.

To insert the handle, press the button on the handle with the thumb and pivot slightly upwards inserting the lip into the widest part of the bracket. Move the handle towards the left, lower into position and release the button.

Ensure the handle is properly located.

To remove the handle, press the button on the handle with the thumb and pivot the handle slightly upwards and towards the right to remove from the bracket.

Protect your hands when removing the grill pan handle. Always remove the grill pan handle during grilling.

To check the progress of the food being grilled, the grill pan should be withdrawn on the shelf to attend to food during cooking.

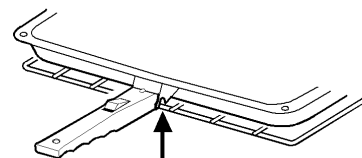
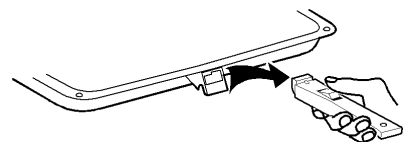
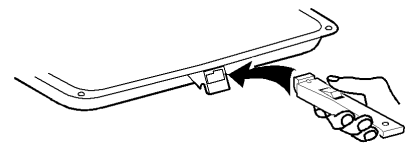
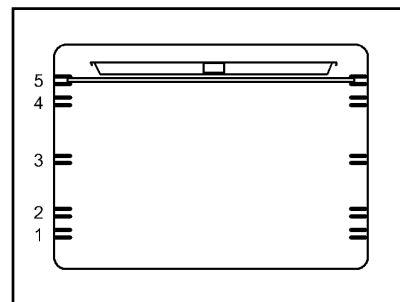
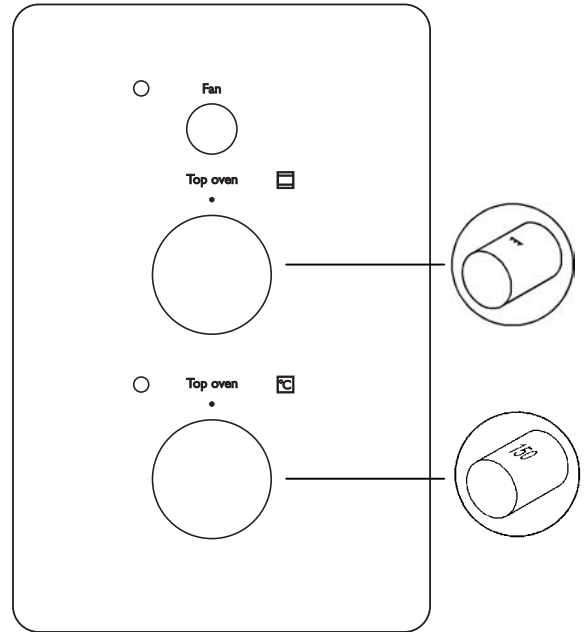

i Hints and Tips

- Most foods should be placed on the grid in the grill pan to allow maximum circulation of air to lift the food out of the fats and juices.
- Adjust the grid and grill pan runner position to allow for different thicknesses of food. Position the food close to the element for faster cooking and further away for more gentle cooking.
- Food should be thoroughly dried before grilling to minimise splashing. Brush lean meats and fish lightly with a little oil or melted butter to keep them moist during cooking.
- Accompaniments such as tomatoes and mushrooms may be placed around the outer edges or underneath the grid when grilling meats.
- When toasting bread, we suggest that the top runner position is used with the grid in its 'high' position.
- When using the centre section grill, ensure food is placed centrally on the grilling grid directly beneath the grill element.
- Preheat the grill on full setting for a few minutes to seal meat or for toasting. Adjust the heat setting and the shelf position as necessary during cooking.
- The food should be turned over during cooking as required

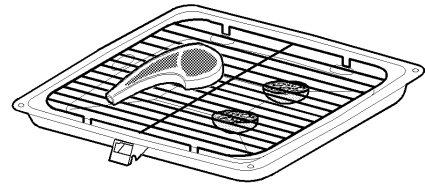

Grilling Chart

TYPE OF DISH	Level	Cooking time (minutes)
Bacon Rashers	Adjust	5 - 6
Beefburgers	grill	10 - 15
Chicken Joints	setting	30 - 40
Chops – Lamb	and	15 - 20
Pork	grill	20 - 30
Fish – Whole Trout/Mackerel	pan	15 - 25
Fillets - Plaice/Cod	grid	10 - 15
Kebabs	to	20 - 30
Kidneys – Lamb/Pig	suit	8 - 12
Liver – Lamb/Pig	different	10 - 20
Sausages	thicknesses	20 - 30
Steaks – Rare	of	6 - 12
Medium	food	12 - 16
Well Done		14 - 20
Toasted Sandwiches		3 - 4

The times quoted above are given as a guide and should be adjusted to suit personal taste.

Fan Assisted Top Oven

The top oven is the smaller of the two ovens.

It is heated by elements in the top and bottom of the oven and a fan. It is designed for cooking smaller quantities of food. It gives especially good results if used to cook fruit cakes, sweet and savoury flans or quiche.

The top oven is also ideal for use as a warming compartment to warm dishes and keep food hot. Use the lowest setting on the top oven temperature control.

How to use the Fan Assisted Top Oven

- Push in the Fan Selector button.
- Push out and turn the top oven/grill selector to top oven. 
- Push out and turn the top oven/grill temperature control to the required setting.

Things to Note

- The oven light will illuminate.
- The fan selector neon will illuminate.
- The indicator neon will glow. It may turn ON and OFF during use to show that the setting is being maintained.
- The cooling fan for the controls may operate after a time.
- The oven fan will operate.

 **Do not place dishes, tins and trays directly on the oven base as it becomes very hot and damage will occur.**

To fit the Top Oven Shelf

The shelf should be fitted with the straight rods uppermost on the frame and the forms towards the back of the oven.

To remove a shelf slide the shelf towards you until the shelf stop is reached. Tilt shelf up at the front so that the stops clear the side supports. Lift shelf clear. To install a shelf, reverse the above steps. Each shelf position has an upper and lower support wire, ensure the shelf is placed between these two support wires.

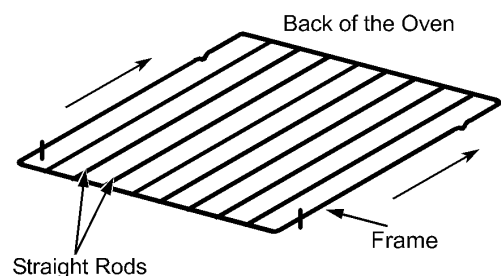
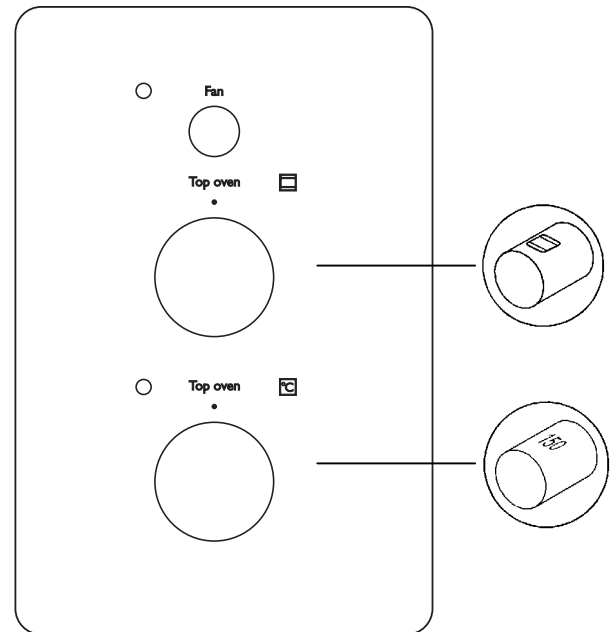

i Hints and Tips

- Use the top oven when you want to warm plates. Use the lowest setting on the second oven temperature control.
- There should always be at least 2.5cm (1") between the top of the food and the grill element. This gives best cooking results and allows room for rise in yeast mixtures, Yorkshire puddings etc. When cooking cakes, pastry, scones bread etc., place the tins or baking trays centrally on the shelf.
- Ensure that food is placed centrally on the shelf and there is sufficient room around the baking tray or dish to allow for maximum circulation.
- Where a degree of evenness in baking is required, it may be necessary to interchange food during cooking.
- Where a larger quantity of food is to be cooked we recommend you use the main oven.
- Place dishes on a suitably sized baking tray on the shelf to prevent spillage onto the oven base and to help reduce cleaning.
- The material and finish of the baking tray and dishes used affect base browning. Enamelware, dark, heavy or non-stick utensils increase base browning. Shiny aluminium or polished steel trays reflect the heat away and give less base browning.
- Do not use the grill pan as a baking tray as this will increase base browning of the food.
- Because of the smaller cooking space and lower temperatures, shorter cooking times are sometimes required. Be guided by the recommendations in the cooking chart.
- Do not place baking trays directly on the oven base as it interferes with the oven air circulation and can lead to base burning; use the lower shelf position.
- For economy leave the door open for the shortest possible time, particularly when placing food into a pre-heated oven.

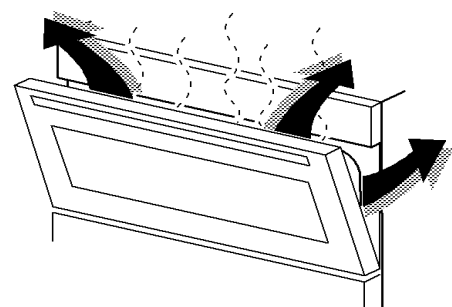
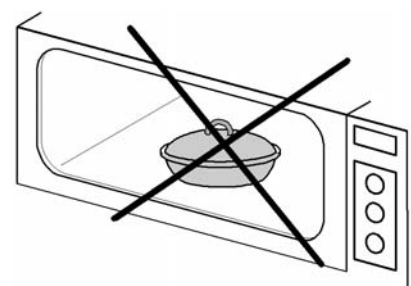
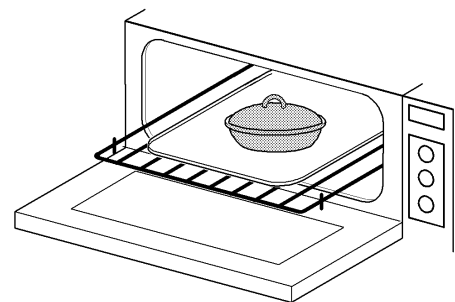
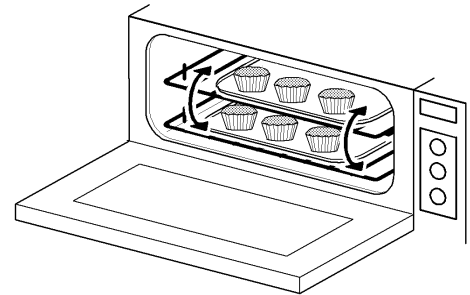
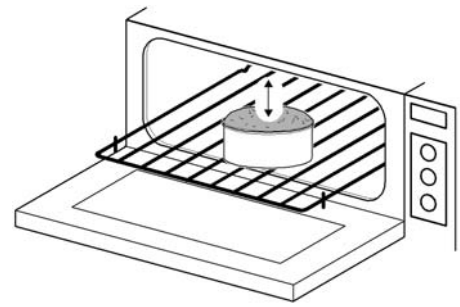

Conventional Top Oven

This form of cooking gives you the opportunity to cook without the fan in operation. It is particularly suitable for some cooked chilled convenience foods and dishes which require extra base browning such as pizzas, quiches and flans. Lasagne and hotpots which require extra top browning also cook well in the conventional oven. For best results cook on one level.

How to use the Conventional Top Oven

- Push out the Fan Selector button.
- Push out and turn the top oven/grill selector to top oven. 
- Push out and turn the top oven/grill temperature control to the required setting.

Things to Note

- The oven light will illuminate.
- The indicator neon will glow. It may turn ON and OFF during use to show that the setting is being maintained.
- The cooling fan for the controls may operate after a time.



Do not place dishes, tins and trays directly on the oven base as it becomes very hot and damage will occur.

To fit the Top Oven Shelf

The shelf should be fitted with the straight rods uppermost on the frame and the forms towards the back of the oven.

To remove a shelf slide the shelf towards you until the shelf stop is reached. Tilt shelf up at the front so that the stops clear the side supports. Lift shelf clear. To install a shelf, reverse the above steps. Each shelf position has an upper and lower support wire, ensure the shelf is placed between these two support wires.

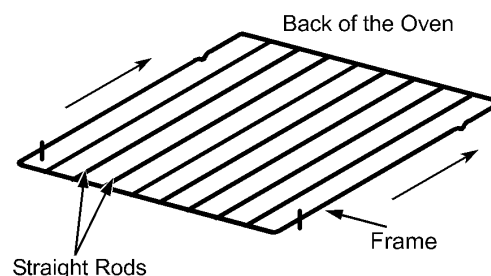
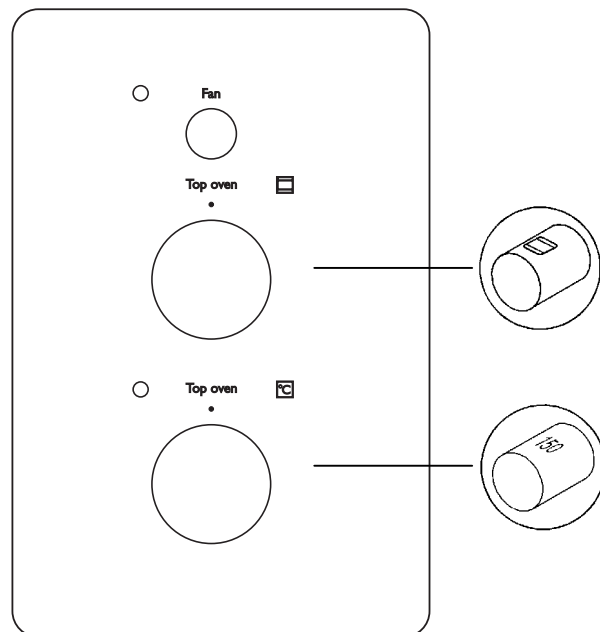

i Hints and Tips

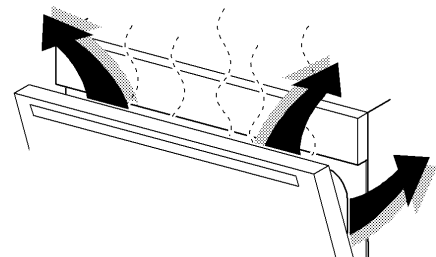
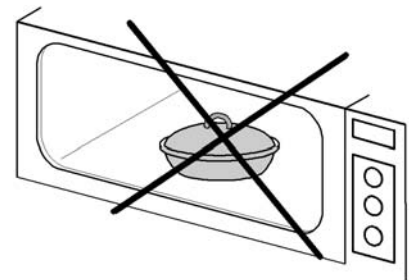
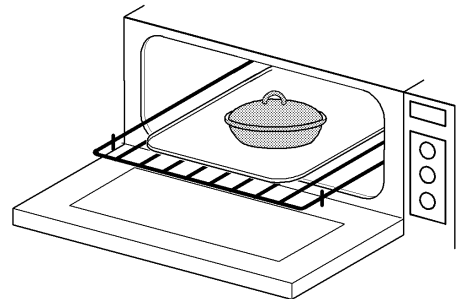
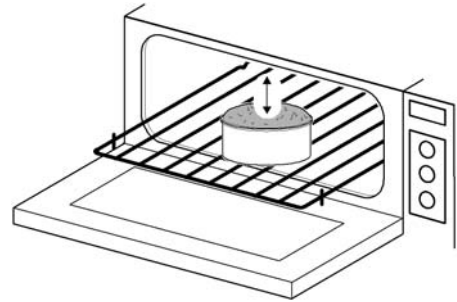

- Single level cooking gives best results. If you require more than one level of cooking use the main fan oven.
- The middle shelf allows for the best heat distribution. To increase base browning simply lower the shelf position. To increase top browning raise, the shelf position.
- There should always be at least 2.5cm (1") between the top of the food and the grill element. This gives best cooking results and allows room for rise in yeast mixtures, Yorkshire puddings etc. When cooking cakes, pastry, scones bread etc., place the tins or baking trays centrally on the shelf.
- Ensure that food is placed centrally on the shelf and there is sufficient room around the baking tray or dish to allow for maximum circulation.
- Place dishes on a suitably sized baking tray on the shelf to prevent spillage onto the oven base and to help reduce cleaning.
- The material and finish of the baking tray and dishes used affect base browning. Enamelware, dark, heavy or non-stick utensils increase base browning. Shiny aluminium or polished steel trays reflect the heat away and give less base browning.
- Because of the smaller cooking space and lower temperatures, shorter cooking times are sometimes required. Be guided by the recommendations in the cooking chart.
- Do not place baking trays directly on the oven base as it interferes with the oven air circulation and can lead to base burning; use the lower shelf position.
- For economy leave the door open for the shortest possible time, particularly when placing food into a pre-heated oven.



Do not place cookware and cooking pots with rough bases e.g. cast iron on the oven door as damage to the glass may occur.

Cooking Chart- Conventional and Fan Assisted Oven

i The chart is intended as a guide only. It may be necessary to increase or decrease the temperature to suit your individual requirements.

TYPE OF DISH	FAN OVEN 		CONVENTIONAL OVEN		Cooking time  minutes
	level	temp °C	level	temp °C	
Biscuits	Shelf positions are not critical but ensure that oven shelves are evenly spaced when more than one is used	180 - 190	3	180 - 190	10 - 20
BREAD		200 - 220	3	210 - 220	25 - 30
Casseroles		130 - 160	3	150 - 180	1½ - 2½h
CAKES:					
Small & Queen		160 - 170	2	170 - 180	18 - 25
Sponges		160 - 170	3	170 - 180	20 - 30
Madeira		140 - 150	3	160 - 170	1¼ - 1½h
Rich Fruit		130 - 140	3	150 - 160	2 - 2½h
Christmas		130 - 140	2	130 - 140	3 - 4½h
					depends on size
Convenience Foods		Follow manufacturer's instructions			
Fish		170 - 190	3	170 - 190	20 - 30
Fruit Pies and Crumbles		190 - 200	3	190 - 200	40 - 60
Milk Puddings		130 - 140	3	130 - 140	1½ - 2h
Pastry: Choux		190 - 200	3	160 - 170	30 - 35
Shortcrust	190 - 200	3	190 - 200	15 - 20	
Flaky	210 - 220	3	210 - 220	25 - 40	
Puff	210 - 220	3	210 - 220	25 - 40	
Plate Tarts	180 - 190	3	190 - 200	25 - 45	
Quiches/Flans	170 - 180	3	190 - 200	25 - 45	
Scones	210 - 220	3	220 - 230	8 - 12	

Note: Shelf positions are counted from the bottom upwards.

Thermal Grilling in the Top Oven

Thermal grilling in the top oven offers an alternative method of cooking food items normally associated with conventional grilling.

Thermal grilling helps to minimise cooking smells in the kitchen and allows you to grill with the oven door closed. With the exception of toast and rare steaks you can Thermal grill all the foods you would normally cook under a conventional grill.

The lower part of the oven can be used to cook accompaniments at the same time, e.g. tomatoes and mushrooms with a mixed grill or breakfast.

Dishes prepared in advance such as shepherd's pie, lasagne and au gratins can be heated through and browned on the top using the Thermal grilling function.

How to use Thermal Grill in the Top Oven

 **Always Thermal grill with the oven door closed and with the grill pan handle removed.**

- Push in the Fan Selector button.
- Push out and turn the top oven/grill selector to full grill. ▼▼▼
- Push out and turn the top oven/grill selector to centre section only. ▼▼
- Turn the top oven/grill temperature control knob to the right as far as it will go. This is the hottest setting.
- To use the grill at lower settings, turn the temperature control knob to 100°C or 150°C.

Things to Note

- The oven light will illuminate.
- The Fan Selector neon will illuminate.
- The indicator neon will glow. It may turn ON and OFF during use to show that the setting is being maintained.
- The cooling fan for the controls may operate after a time.
- The oven fan will operate.

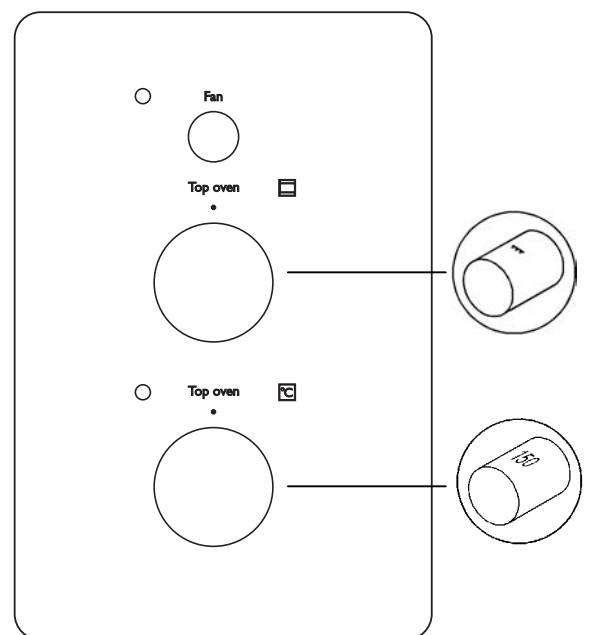

i Hints and Tips

- Prepare foods in the same way as for conventional grilling. Brush lean meats and fish lightly with a little oil or butter to keep them moist during cooking.
- Most food should be placed on the grill pan grid in the 'high' position in the grill pan to allow maximum circulation of air around the food.
- Accompaniments such as tomatoes and mushrooms may be placed below the grid when grilling meats, or in a separate dish on a lower shelf.
- Foods will cook more quickly the closer they are to the grill element and the higher the temperatures selected. Be prepared to adjust temperatures and shelf positions during cooking if necessary.
- Turn food over during cooking as necessary.
- Ensure that ready prepared or cooked chilled dishes e.g. shepherds pie, moussaka, lasagne, etc., are piping hot throughout before serving.
- A temperature range of 140°C - 220° is suitable for most foods. Be prepared to make suitable adjustments during cooking to suit individual requirements. If Thermal grilling on more than one level, it may be necessary to interchange the food on the shelves during cooking.

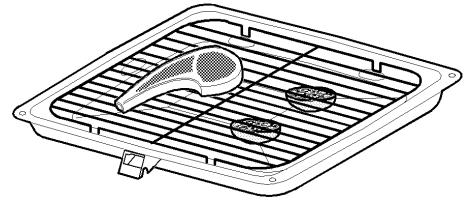
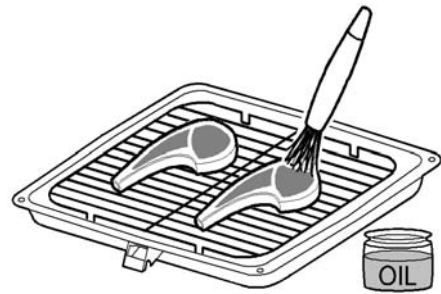

Thermal Grilling Chart

TYPE OF DISH	Level	Grilling	Cooking time (minutes)
Bacon Rashers	5	▼▼▼	8-12
Beefburgers	3	▼▼▼	10-15
Chicken Joints	3	▼▼	30-40
Chops - Lamb/Pork	3	▼▼	20-25
Fish - Whole		▼▼	
Trout/Mackerel	3	▼▼	10-20
Filletts - Plaice/Cod	3	▼▼	10-15
Kebabs	3	▼▼	20-30
Kidneys - Lamb/Pig	3	▼▼	10-15
Liver - Lamb/Pig	3	▼▼	20-30
Sausages	3	▼▼	10-20
Steaks - Medium	3	▼▼	15-20
Steaks - Well Done	3		20-30
Heating through and Browning, e.g. Au - gratin, Lasagne, Shepherd's Pie.	3	▼▼	depends on dish

The times quoted above are given as a guide and should be adjusted to suit personal taste.

Defrost in the Top Oven

This top oven function enables you to defrost most foods without heat faster than some conventional methods as the oven fan circulates air around the food. It is particularly suitable for delicate frozen foods which are to be served cold e.g. cream filled gateaux, cakes covered with icings or frostings, cheesecakes, biscuits, scones etc.

How to use Defrost in the Top Oven

- Push out the Fan Selector button.
- The Top oven/Dual grill control should be in the Off '0' position.

Things to Note

- The oven fan and internal oven light will operate.
- The cooling fan does not operate.

Hints and Tips

- Place the frozen food in a single layer where possible and turn it over half way through the defrosting process.
- The actual speed of defrosting is influenced by room temperature. On warm days defrosting will be faster than on cooler days.
- It is preferable to thaw fish, meat and poultry slowly in the fridge. However, this process can be accelerated by using the defrost function. Small or thin fish fillets, frozen peeled pawns, cubed or minced meat, liver, thin chops, steaks etc., can be thawed in 1 - 2 hours.
- A 1kg/2¼lb oven ready chicken will be thawed in approximately 5 hours. Remove the giblets as soon as possible during the thawing process.
- Joints of meat up to 2kg/4½lb in weight can be thawed using the defrost function.
- All joints of meat and poultry must be thawed thoroughly before cooking.
- Always cook thoroughly immediately after thawing.
- **Important!** Do not leave food at room temperature once it is defrosted. Cook raw food immediately or store cooked food in the fridge.
- Care must always be taken when handling foods in the home. Always follow the basic rules of food hygiene to prevent bacterial growth and cross contamination when defrosting, preparing, cooking, cooling and freezing foods.

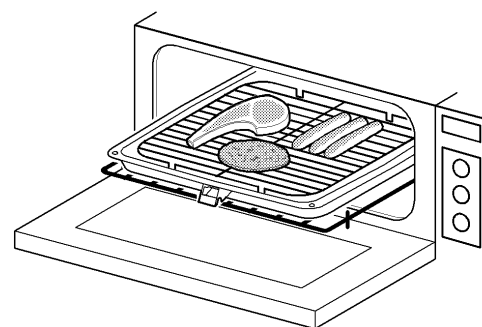
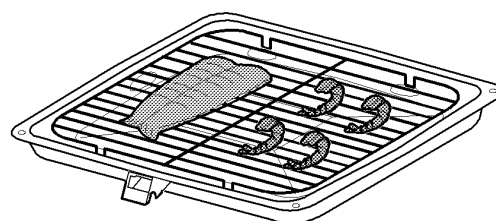
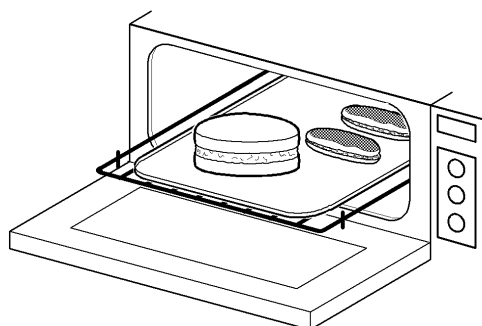
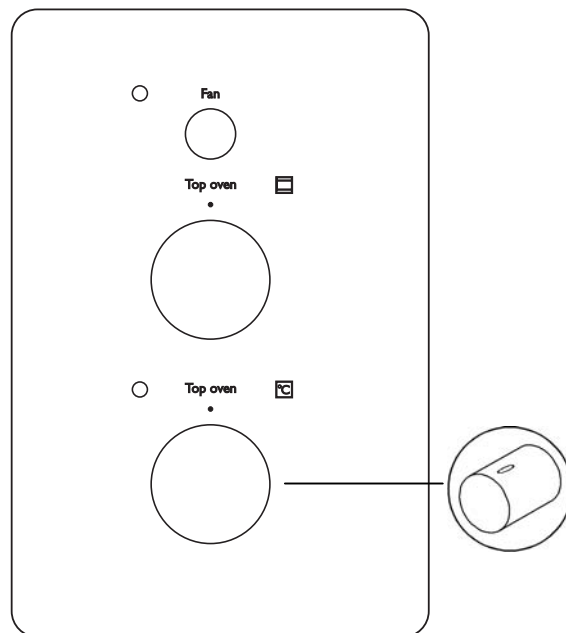

Main Fan Oven

The Main Fan oven is particularly suitable for cooking larger quantities of food.

The advantages of Fan oven cooking are:

Preheating

The Fan oven quickly reaches its temperature so it is not usually necessary to preheat the oven. Without preheating however you may need to add an extra 5 – 10 minutes on the recommended cooking times. For recipes needing high temperatures e.g. bread, pastries, scones, soufflés etc., best results are achieved if the oven is preheated first. For best results when cooking frozen or cooked chilled ready meals preheat the oven first.

Cooking Temperatures

Fan oven cooking generally requires lower temperatures than conventional cooking. Follow the temperatures recommended in the cooking chart. As a guide reduce temperatures by 20°C - 25°C for your own recipes, using a conventional oven.

Batch Baking

The Fan oven cooks evenly on all shelf levels, especially useful when batch baking.

How to use the Main Fan Oven

- Push out and turn the main oven temperature control to the required setting.

Things to Note

- The oven light will illuminate.
- The indicator neon will glow. It may turn ON and OFF during use to show that the setting is being maintained.
- The oven fan will operate.
- The cooling fan for the controls may operate after a time.
- If an automatic programme has been set, the oven fan and oven light will not come on until cooking begins.

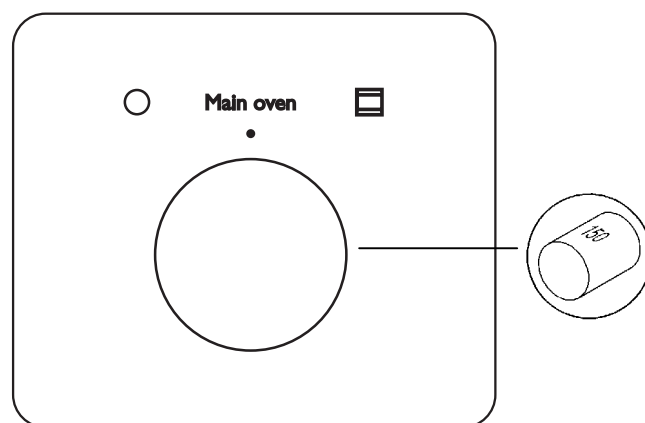

To fit the Main Fan Oven Shelves

The shelves should be fitted with the straight rods uppermost on the frame and the forms towards the back of the oven.

To remove a shelf slide the shelf towards you until the shelf stop is reached. Tilt shelf up at the front so that the stops clear the side supports. Lift shelf clear. To install a shelf, reverse the above steps. Each shelf position has an upper and lower support wire, ensure the shelf is placed between these two support wires.

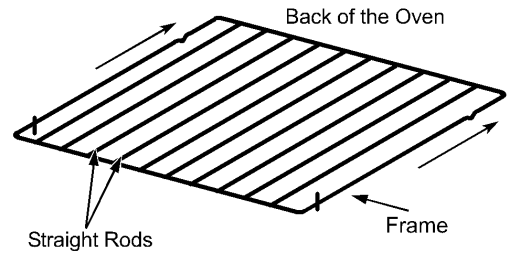

i Hints and Tips

- Arrange the shelves in the required positions before switching the oven on. Shelf positions are counted from the bottom upwards.
- When cooking more than one dish in the fan oven, place dishes centrally on different shelves rather than cluster several dishes on one shelf, this will allow the heat to circulate freely for the best cooking results.
- When batch baking one type of food, e.g. Victoria sandwich cakes, those of similar size will be cooked in the same time.
- It is recommended that when baking larger quantities, the shelf positions should be evenly spaced to suit the load being cooked. A slight increase in cooking time may be necessary.
- **Do not** place baking trays directly on the oven base as it interferes with the oven air circulation and can lead to base burning; use the lower shelf position.

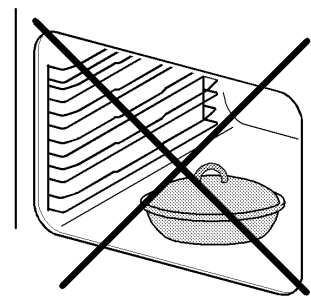
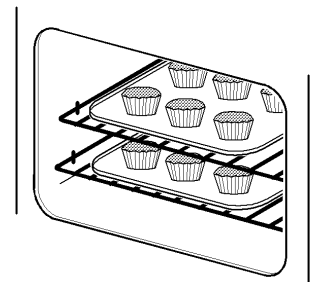
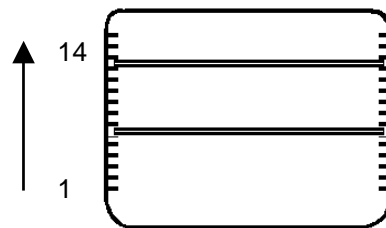

Do not place cookware and cooking pots with rough bases e.g. cast iron on the oven door as damage to the glass may occur.

Cooking Chart – Main Fan Oven

The oven temperatures are intended as a guide only. It may be necessary to increase or decrease the temperatures by a further 10°C to suit individual preferences and requirements.

TYPE OF DISH	Level	Temp. °C
Biscuits		160 - 190
Bread		210 - 220
Bread Rolls / Buns	Shelf	210 - 220
Cakes:		
Small & Queen		160 - 170
Sponges	positions	160 - 170
Victoria Sandwich		160 - 170
Madeira		140 - 150
Rich Fruit	are not	140 - 150
Christmas		130 - 140
Gingerbread	critical	140 - 150
Flapjack		170 - 180
Shortbread		140 - 150
Baked Custard	but ensure	140 - 150
Casseroles:		
Beef / Lamb		140 - 150
Chicken		160 - 180
Convenience Foods	that oven	Follow manufacturers instructions
Fish		150 - 170
Fish Pie (Potato Topped)	shelves are	190 - 200
Fruit Pies, Crumbles		180 - 190
Milk Puddings		130 - 140
Pasta / Lasagne etc.	evenly	180 - 190
Pastry :		
Choux –		
Eclairs/Profiteroles		160 - 170
Flaky / Puff Pies	spaced	210 - 220
Shortcrust -		
Mince Pies		170 - 180
Meat Pies	when more	210 - 220
Quiche, Tarts, Flans		180 - 190
Roasting Meat / Poultry		160 - 180
Scones	than one is	200 - 210
Shepherd's Pie		190 - 200
Soufflés		170 - 180
Vegetables:		
Baked Jacket Potatoes	used	190 - 200
Roast Potatoes		200 - 210
Yorkshire Puddings:		
Large		210 - 220
Individual		210 - 220

Roasting Chart

INTERNAL TEMPERATURES – Rare : 50-60°C; Medium : 60-70°C; Well done : 70-80°C		
MEAT	TEMPERATURE	COOKING TIME
Beef/ Beef boned	160-180°C	20-35 minutes per ½kg (1lb) and 20-35 minutes over
Mutton/Lamb	160-180°C	25-35 minutes per ½kg (1lb) and 25-35 minutes over
Pork/Veal/Ham	160-180°C	30-40 minutes per ½kg (1lb) and 30-40 minutes over
Chicken	160-180°C	15-20 minutes per ½kg (1lb) and 20 minutes over
Turkey/Goose	160-180°C	15-20 minutes per ½kg (1lb) up to 3½kg (7lb) then 10 minutes per ½kg (1lb) over 3½kg (7lb)
Duck	160-180°C	25-35 minutes per ½kg (1lb) and 25-30 minutes over
Pheasant	160-180°C	35-40 minutes per ½kg (1lb) and 35-40 minutes over
Rabbit	160-180°C	20 minutes per ½kg (1lb) and 20 minutes over

The roasting temperatures and times given in the chart should be adequate for most joints, but slight adjustments may be required to allow for personal requirements and the shape and texture of the meat. However, lower temperatures and longer cooking times are recommended for less tender cuts or larger joints.

Wrap joints in foil if preferred, for extra browning uncover for the last 20 – 30 min. cooking time.

Defrost in the Main Oven

This main oven function enables you to defrost most foods without heat faster than some conventional methods as the oven fan circulates air around the food. It is particularly suitable for delicate frozen foods which are to be served cold e.g. cream filled gateaux, cakes covered with icings or frostings, cheesecakes, biscuits, scones etc.

How to use Defrost in the Main Oven

- Push out and turn the main oven temperature control to the fan controlled defrost setting. 

Things to Note

- The oven fan and internal oven light will operate.

Hints and Tips

- Place the frozen food in a single layer where possible and turn it over half way through the defrosting process.
- The actual speed of defrosting is influenced by room temperature. On warm days defrosting will be faster than on cooler days.
- It is preferable to thaw fish, meat and poultry slowly in the fridge. However, this process can be accelerated by using the defrost function. Small or thin fish fillets, frozen peeled prawns, cubed or minced meat, liver, thin chops, steaks etc., can be thawed in 1 – 2 hours.
- A 1kg/2¼lb oven ready chicken will be thawed in approximately 5 hours. Remove the giblets as soon as possible during the thawing process.
- Joints of meat up to 2kg/4½lb in weight can be thawed using the defrost function.
- All joints of meat and poultry must be thawed thoroughly before cooking.
- Always cook thoroughly immediately after thawing.
- **Important!** Do not leave food at room temperature once it is defrosted. Cook raw food immediately or store cooked food in the fridge, once it has cooled.
- Care must always be taken when handling foods in the home. Always follow the basic rules of food hygiene to prevent bacterial growth and cross contamination when defrosting, preparing, cooking, cooling and freezing foods.

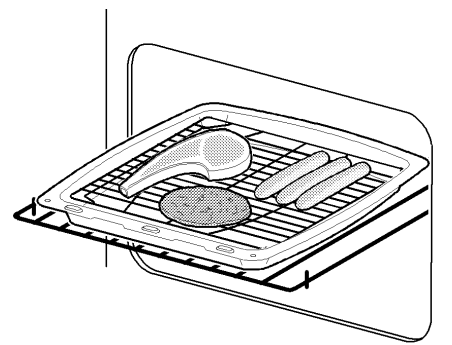
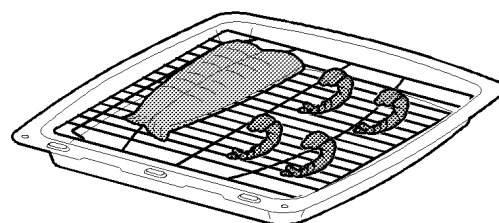
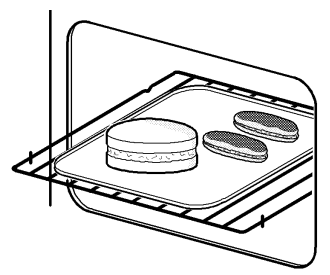
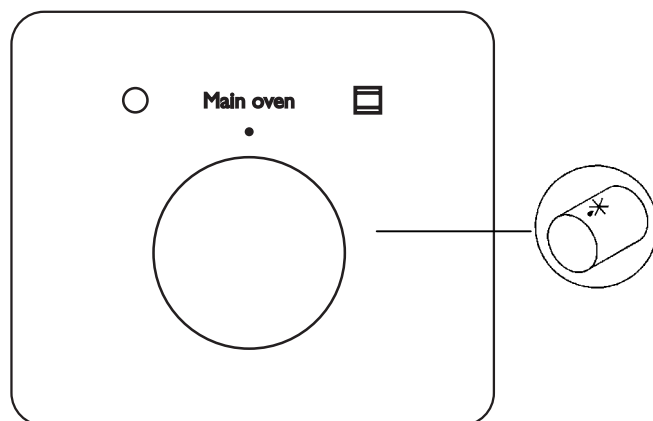

Cleaning the Oven



Before cleaning always allow the appliance to cool down before switching off at the electricity supply.

This appliance cannot be cleaned with steam or with a steam cleaning machine.

The oven should be kept clean at all times. A build up of fats or other foodstuffs could result in a fire, especially in the grill pan.

Cleaning Materials

Before using any cleaning materials on your appliance, check that they are suitable and that their use is recommended by the manufacturer.

Cleaners that contain bleach should NOT be used as they may dull the surface finishes. Harsh abrasives and scourers should also be avoided as damage will occur.

External Cleaning

Regularly wipe over the control panel, doors and handles using a soft cloth and hot soapy water. To prevent streaking finish with a soft cloth.

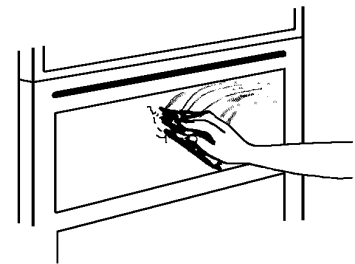

Do not attempt to remove any of the control knobs from the panel as this may cause damage and is a safety hazard.

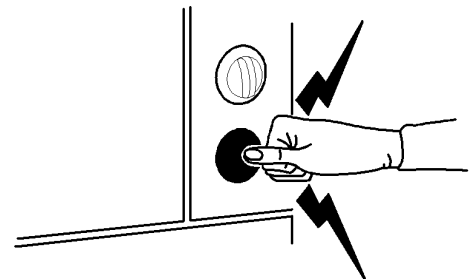

How to Remove and Replace the Wirework Runners

1. Remove all shelves and furniture from the oven.
2. Hold the wirework at the bottom, unclip from the cavity side and gently pull towards the centre of the oven.
3. Unhook the runner at the top and remove from the cavity.
4. To replace the runners, hook the wirework side runner into the cavity, slide back and press into place.

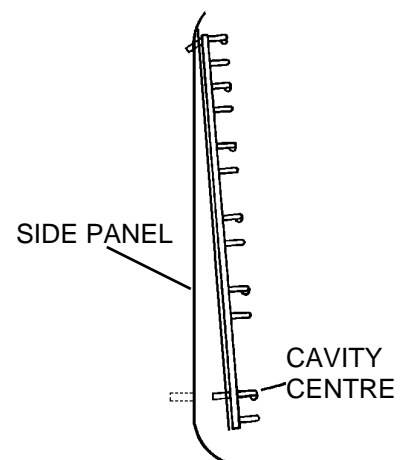

Ensure the wirework runners are firmly in position before replacing the oven shelves.

Cleaning Inside the Ovens

The sides and back of the grill/top oven and main oven compartments are coated with a special Stayclean coating. They should not be cleaned manually.

The vitreous enamel main oven base and grill compartment base can be cleaned using normal oven cleaners with care. Ensure that the manufacturers instructions are followed and that all parts are well rinsed afterwards.



Aerosol cleaners must not come into contact with elements, the door seal, or any painted finishes as this may cause damage.



Hints and Tips



Aerosol cleaners must not be used on Stayclean surfaces.

Stayclean surfaces destroy splashes of food and fats when the oven temperature is raised to around 220°C.

It is a good idea to run the oven for an hour or two per week to ensure continued good performance from the Stayclean finish.

Slight discolouration and polishing of the Stayclean surfaces may occur in time. This **DOES NOT** affect the Stayclean properties in any way.

Use minimal, if any, extra oil or fat when roasting meat, potatoes only require brushing with fat before cooking. Extra fat in the oven during roasting will increase splashing and soilage.

It is **NOT** necessary to add water to a meat tin when roasting. The water and the fat juices from the joint create excessive splattering during cooking – even at normal temperatures, as well as causing condensation.

Covering joints during cooking will also prevent splashing onto the interior surfaces. Removing the covering for the last 20-30 minutes will allow extra browning if required. Some large joints and turkeys especially benefit by this method of cooking, allowing the joint to cook through before the outside is over-browned.

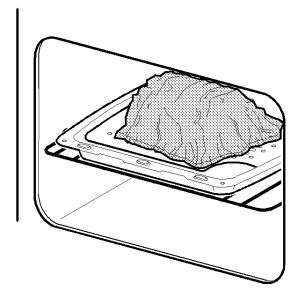
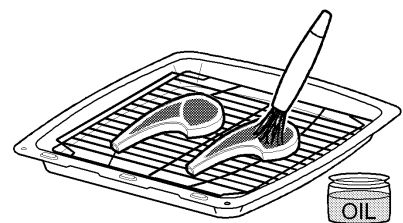

Cleaning the Door(s)



To prevent damaging or weakening the door glass panels avoid the use of the following:

- Household detergents and bleaches
 - Impregnated pads unsuitable for non-stick saucepans
 - Brillo/Ajax pads or steel wool pads
 - Chemical oven pads or aerosols
 - Rust removers
 - Bath/Sink stain removers
-

The outer oven door glass panels are removable for cleaning.



How to Remove the outer Door Glass

1. Open the oven door slightly to gain access to the two cross head screws on the top of the oven door.
2. Loosen the two screws using a Pozidrive screwdriver.
3. Holding the door glass securely in place with one hand remove the screws and washers with the other hand.
The screws and washers retain the trim on the top of the grill door. Note the position of the trim on the door.
4. Holding the door and glass with one hand, gently pull towards you and slightly lift the door glass with the other hand to disengage the panel from the location point at the bottom of the door. Gently release the door to close it.
5. Clean the outer and inner glass using hot soapy water or Hob Brite. Should the inner face of the outer door glass be heavily soiled it is recommended that soapy water with a high concentration of soap is used. To prevent streaking a glass cleaning spray may be applied and the glass polished with a soft cloth. Ensure that all parts are thoroughly dry before attempting to replace the outer door glass.

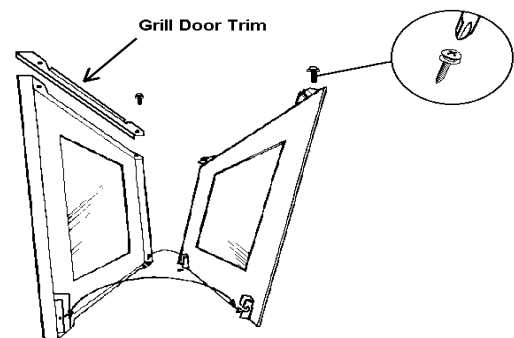

If the door glass panel becomes chipped or has deep scratches the glass will be weakened and must be replaced to prevent the possibility of the panel shattering. Please contact your local Service Force Centre who will be pleased to advise further.

How to Replace the outer Door Glass

1. Holding the oven glass with both hands, gently place the locators into the holes of the brackets at the bottom of the oven door.
2. Holding the door glass with your left hand, use your right hand to open the oven door.

Bring the door gently towards the glass panel ensuring the screw location holes line up.

3. Place the trim in the correct position on the top of the grill door.
4. Hold the glass in place with one hand and insert the cross head screws with washers into the location holes with the other hand. Give the screws one turn to ensure the glass is secure.
5. Tighten the screws positively with a Pozidrive screwdriver before closing the oven door.

 **Do not attempt to use the oven without the glass being in place.**

To Clean the Inner Glass Door

The inner glass door is not removable. Clean using hot soapy water or Hob Brite and a soft cloth. **Do not** use abrasives as they may damage the glass or seal.

Cleaning the Shelves, Wire-work runners and Grill/Oven furniture

All removable parts, except the grill pan handle can be washed in the dishwasher.

The grill pan, grill pan grid, oven shelves and wirework runners may be cleaned using a soap impregnated steel wool pad. Soaking first in hot soapy water will make cleaning easier.

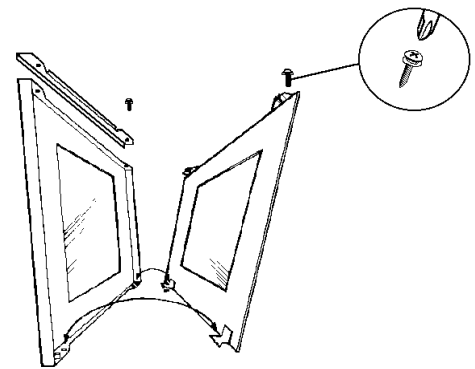

How to Replace the Oven light

The type of bulb required is a 300°C, 25 watt small Edison Screw.

 **Disconnect the appliance from the electricity supply before replacing the bulb.**

1. Make sure the appliance is cool before replacing a bulb.
2. Open the door and remove the shelves and wirework runners.
3. Pull the glass bulb cover towards you and then pull it off. If necessary use a screwdriver to carefully lever off the cover, taking care not to damage the oven cavity.
4. Unscrew the bulb by turning it to the left.
5. Fit a new bulb and then replace the glass bulb cover.
6. Refit the wirework runners and replace the oven shelves.
7. Restore the electricity supply and reset the time of day.

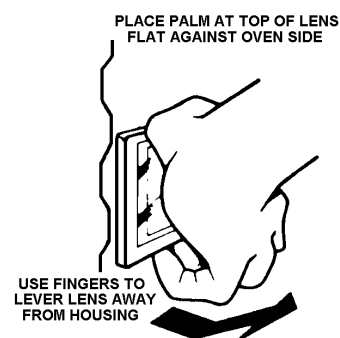

Something Not Working

If the oven is not working correctly, please carry out the following checks, before contacting your local Service Force Centre.

IMPORTANT: If you call out an engineer to a fault listed below, or to repair a fault caused by incorrect use or installation, a charge will be made even if the appliance is under guarantee.

SYMPTOM	SOLUTION
<ul style="list-style-type: none"> ■ The grill, ovens and timer do not work. 	<ul style="list-style-type: none"> ◆ Check that the appliance has been wired in to the appliance supply and is switched on at the wall. ◆ Check that the main appliance fuse is working. ◆ If you have checked the above: Allow the appliance to cool for a couple of hours. The appliance should now be working normally.
<ul style="list-style-type: none"> ■ The grill and top oven work but the main oven does not. 	<ul style="list-style-type: none"> ◆ Check that the time of day has been set on the clock. Check that the oven is set for manual cooking.
<ul style="list-style-type: none"> ■ The grill does not work or cuts out after being used for a long period of time. 	<ul style="list-style-type: none"> ◆ Ensure the cooling fan is running when the grill is on. If the cooling fan fails, the grill will not operate correctly. Contact your local Service Force Centre. ◆ Leave the grill door open and allow the grill to cool. After a couple of hours check that the grill works as normal.
<ul style="list-style-type: none"> ■ The timer does not work. 	<ul style="list-style-type: none"> ◆ Check that the instructions for the operation of the timer are being closely followed.
<ul style="list-style-type: none"> ■ The indicator neons are not working correctly. 	<ul style="list-style-type: none"> ◆ Check that you have selected only the function you require. Ensure all other controls are in the Off position.
<ul style="list-style-type: none"> ■ The oven is not cooking evenly. 	<ul style="list-style-type: none"> ◆ Check that the appliance is correctly installed and is level. ◆ Check that the recommended temperatures and shelf positions are being used.
<ul style="list-style-type: none"> ■ The oven light fails to illuminate. 	<ul style="list-style-type: none"> ◆ The oven light bulb may need replacing. ◆ If the Main Oven is set for automatic cooking the light will illuminate when the cook time begins.
<ul style="list-style-type: none"> ■ The oven fan is noisy. 	<ul style="list-style-type: none"> ◆ Check that the oven is level. ◆ Check that the shelves and bakeware are not vibrating in contact with the oven back panel.
<ul style="list-style-type: none"> ■ The oven temperature is too high or too low. 	<ul style="list-style-type: none"> ◆ Check that the recommended temperatures and shelf positions are being used. Be prepared to adjust the temperature up or down by 10°C to achieve the results you want.

Repairs – After Sales Service

If your oven is not performing satisfactorily; consult the fault finding guides within this instruction manual (Something Not Working). In the event of a fault occurring which you cannot resolve yourself from advice given within this instruction manual. Your first step is to contact our extended warranty administrators on **0870 0107887** who will give you details for your local Service Force Centre.

When contacting the Service Force centre, please quote the model (Mod.) and serial number (S.N.), both of which are shown on the rating plate. This is situated on the lower front frame of the appliance and can be seen upon opening the door. Alternatively the rating plate may also be found on the back or top of some models (where applicable). The appliance must be protected by a suitably rated fuse or circuit breaker. The rating of the appliance is given on the rating plate.

Do not remove the rating plate from the appliance as this may invalidate the guarantee.

So that you always have these numbers at hand, we recommend you make a note of them here:

Mod :.....

PNC:.....

S.N. :.....

Your oven is covered by a 3 year parts and labour guarantee (see separate details given at point of sale). Please retain your purchase receipt safely for the service engineer to verify the purchase details.



Spare parts

This product should be serviced by an authorised service engineer and only genuine spare parts should be used.

Under no circumstances should you attempt to repair the machine yourself.

Repairs carried out by inexperienced persons may cause injury or serious malfunctioning. Contact our extended warranty administrators on **0870 0107887** who will give you details for your local Service Force Centre.

Always insist on genuine spare parts.

	Manufacturer		JOHN LEWIS
	Model Number		JLDUOS70S
Top Oven	Energy Efficiency on a Scale A (more efficient) to G (less efficient) (4)		 Forced Air
	Energy Consumption in kWh (1)	Conventional	0.85
		Forced air Convection	0.79
	Useable Volume - Litres		35
	Oven Size (2)		Medium
	Time Taken to 'Cook' Standard Load - Minutes	Conventional	46
		Forced air Convection	42
The Area of the largest Baking Sheet -cm ² (3)		1208	
Bottom Oven	Energy Efficiency on a Scale A (more efficient) to G (less efficient) (5)		
	Energy Consumption in kWh (1)	Conventional	
		Forced air Convection	0.99
	Useable Volume - Litres		53
	Oven Size (2)		Medium
	Time Taken to 'Cook' Standard Load - Minutes	Conventional	
		Forced air Convection	56
The Area of the largest Baking Sheet -cm ² (3)		1558	

(1) Based on test results for a standard load in accordance with EN50304

(2) Small: 12l<35l Medium: 35l<65l Large: 65l+

(3) Surface Area of Shelf

(4) Conventional Function unless stated

John Lewis Partnership
171 Victoria Street
London SW1E 5NN
www.johnlewis.com

Free Manuals Download Website

<http://myh66.com>

<http://usermanuals.us>

<http://www.somanuals.com>

<http://www.4manuals.cc>

<http://www.manual-lib.com>

<http://www.404manual.com>

<http://www.luxmanual.com>

<http://aubethermostatmanual.com>

Golf course search by state

<http://golfingnear.com>

Email search by domain

<http://emailbydomain.com>

Auto manuals search

<http://auto.somanuals.com>

TV manuals search

<http://tv.somanuals.com>