

JLWM 1404

1400 spin washing machine

Instruction manual

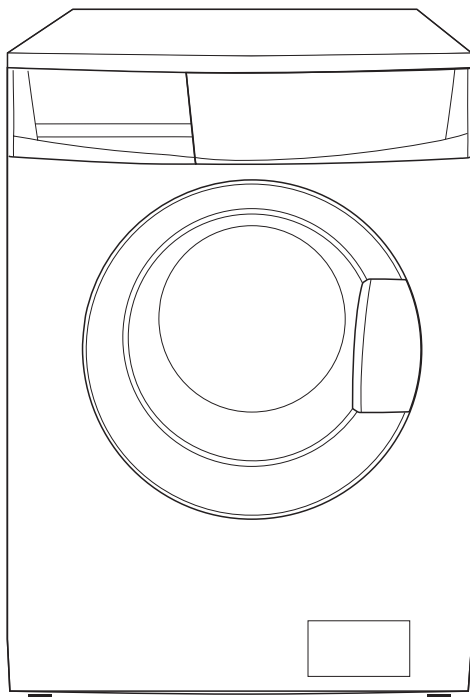

John Lewis

Safety information

It is most important that this instruction book should be retained with the appliance for future reference. Should the appliance be sold or transferred to another owner, or should you move house and leave the appliance, always ensure that the book is supplied with the appliance in order that the new owner can get to know the functioning of the appliance and the relevant warnings.

These warnings have been provided in the interest of safety. You **MUST** read them carefully before installing or using the appliance. If you are unsure of the meanings of these warnings contact the John Lewis branch from which you purchased the appliance.

Important! Read carefully and keep for future reference.

- The safety of your appliance complies with the industry standards and with legal requirements on the safety of appliances. However, as manufacturers, we feel it is our duty to provide the following safety notes.
- It is most important that this instruction book should be retained with the appliance for future reference. Should the appliance be sold or transferred to another owner, or should you move house and leave the appliance, always ensure that the book is supplied with the appliance in order that the new owner can get to know the functioning of the appliance and the relevant warnings.
- You **MUST** read them carefully before installing or using the appliance.
- Before first starting up, check the appliance for any damage incurred during transport. Never connect up a damaged appliance. If parts are damaged, contact your supplier.

- If the appliance is delivered in the winter months when there are minus temperatures. Store it at room temperature for 24 hours before using for the first time.

General safety

- It is dangerous to alter the specifications or attempt to modify this product in any way.
- During high temperature wash programmes the door glass may get hot. Do not touch it!
- Make sure that small children and animals do not climb into the drum. To avoid this, please check into the drum before using.
- Any objects such as coins, safety pins, nails, screws, stones or any other hard, sharp material can cause extensive damage and must not be placed into the machine.
- Only use the advised quantities of fabric softener and detergent. Damage to the fabric can ensue if you over-fill. Refer to the manufacturer's recommendations of quantities.

- Wash small items such as socks, laces, washable belts etc in a washing bag or pillow case as it is possible for such items to slip down between the tub and the inner drum.
- Do not use your washing machine to wash articles with whalebones, material without hems or torn material.
- Always unplug the appliance and turn off the water supply after use and during cleaning and maintenance.
- Under no circumstances should you attempt to repair the machine yourself. Repairs carried out by inexperienced people may cause injury or serious malfunctioning. Contact your local Service Centre. Always insist on genuine spare parts.
- If the appliance is installed in a location subject to frost, please read the “dangers of freezing” chapter.
- Any plumbing work required to install this appliance should be carried out by a qualified plumber or competent person.
- Any electrical work required to install this appliance should be carried out by a qualified electrician or competent person.

Use

- This appliance is designed for domestic use. It must not be used for purposes other than those for which it was designed.
- Only wash and dry fabrics which are designed to be machine washed or dried. Follow the instructions on each garment label
- Do not overload the appliance. See the Washing Programme Table.
- Before washing, ensure that all pockets are empty and buttons and zips are fastened. Avoid washing frayed or torn articles and treat stains such as paint, ink, rust, and grass before washing. Underwired bras must NOT be machine washed.
- Garments which have been in contact with volatile petroleum products should not be machine washed. If volatile cleaning fluids are used, care should be taken to ensure that the fluid is removed from the garment before placing in the machine.
- As some duvets and eiderdowns should be washed/dried in large commercial machines because of their bulk, please check with the manufacturer of the item before washing in a domestic machine.

Installation

- This appliance is heavy. Care should be taken when moving it.
- When unpacking the appliance, check that it is not damaged. If in doubt, do not use it and contact the Service Centre.
- All packing and transit bolts must be removed before use. Serious damage can occur to the product and to property if this is not adhered to. See relevant section in the user manual.
- After having installed the appliance, check that it is not standing on the inlet and drain hose and the worktop is not pressing the electrical supply cable against the wall.
- If the machine is situated on a carpeted floor, please adjust the feet in order to allow air to circulate freely under the appliance.
- Always be sure, that there is no water leakage from hoses and their connections after the installation.

- The users should always check that they have not left their gas lighters (disposable or otherwise) in their clothing.
- Never tumble dry items that have had contact with chemicals such as dry cleaning fluid. These are of a volatile nature and could cause an explosion. Only tumble dry items which have been washed in water or require airing.
- Plastic detergent dispensers should not remain in the drum during the drying cycle, as the plastic used is not designed to withstand the heat. If you wish to wash-through-to-dry you should use the conventional detergent dispenser drawer.
- Never pull the power supply cable to remove the plug from the socket; always take hold of the plug itself.
- Never use your new appliance if the power supply cable, the control panel, the working surface or the base are damaged so that the inside of the appliance is accessible.
- The packaging components (e.g. plastic film, polystyrene) can be dangerous to children - danger of suffocation! Keep them out of children's reach.
- Keep all detergents in a safe place out of children's reach.
- Make sure that children or pets do not climb into the drum. To prevent children and pets becoming trapped inside the drum the machine incorporates a special feature. To activate this device, rotate the button (without pressing it) inside the door clockwise until the groove is horizontal. If necessary use a coin.

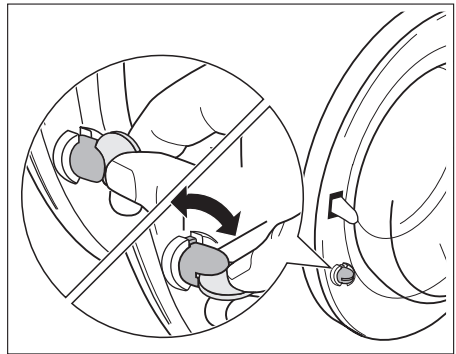

Child safety

- This appliance is not intended for use by person (including children) with reduced physical sensory or mental capabilities or lack of experience and knowledge unless they have been given supervision or instruction concerning use of the appliance by a person responsible for their safety.

To disable this device and restore the possibility of closing the door, rotate the button counterclockwise until the groove is vertical.

Contents

Operating instructions

Safety information

General safety

Installation

Use

Child safety

Product description

Detergent dispenser drawer

Control panel

Programme Dial (2)

Spin (3)

Prewash (4)

Intensive (5)

Extra Rinse (6)

Quick (7)

Start Pause (8)

Door lock light (9)

Delay Start (10)

Display (11)

First use

Personalisation

Acoustic signals

Child lock

Daily use

Load the laundry

Measure out the detergent

Select the required programme

Select the spin speed or None option

Select the desired options

Select the delay start

Start the programme

How to change an option or a programme during its cycle

How to interrupt a programme

How to open the door during the cycle of a programme

Installation instructions

Installation

Unpacking

Positioning and levelling

Plumbing in

Water inlet

Water drainage

Special conditions

In the interest of the environment

Electrical connection

What to do if...

Repairs - After Sales Service

Environment concerns

Packaging materials

Ecological hints

Guide to use the instruction manual

The following symbols will be found in the text to guide you throughout the instructions:



Safety instructions



Hints and tips



Environmental information

End of programme	15
Helpful hints and tips	16
Washing programmes	18
Technical data	21
Consumption values	22
Care and cleaning	22
Descaling	22
External cleaning	23
Washing drum	23
Door seal	24
Cleaning the pump	24
Emergency emptying out	26
Frost precautions	26

Product description

- 1 Detergent dispenser drawer
- 2 Control panel
- 3 Door opening handle
- 4 Rating plate
- 5 Drain pump
- 6 Adjustable feet

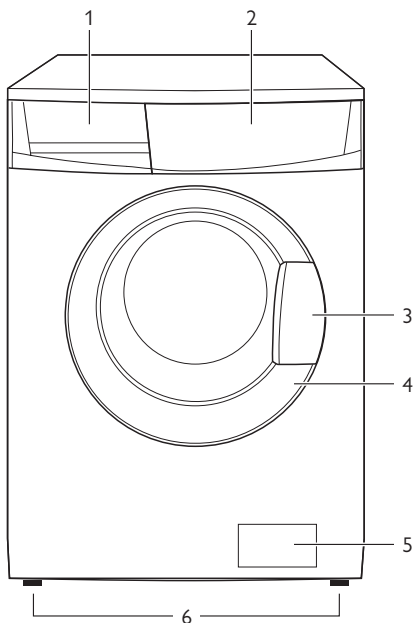

Detergent dispenser drawer

 Compartment for detergent used for prewash and soak phase or for stain remover used during the stain action phase (if available). The prewash and soak detergent is added at the beginning of the wash programme. The stain remover is added during the stain action phase.

 Compartment for powder or liquid detergent used for main wash. If using liquid detergent pour it **just before** starting the programme.

 Compartment for liquid additives (fabric softener, starch).

Follow the product manufacturer's recommendations on quantities to use and do not exceed the **«MAX»** mark in the detergent dispenser drawer. Any fabric softener or starching additives must be poured into the compartment before starting the wash programme.

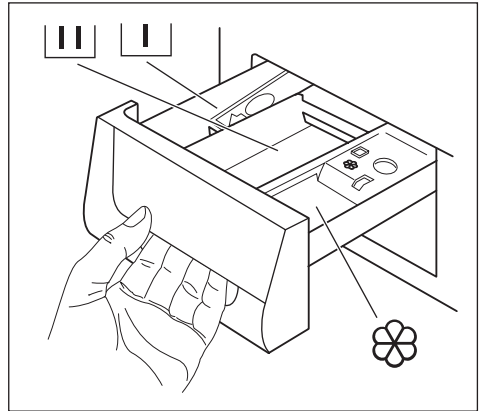

Control panel

 Below is a picture of the control panel. It shows the programme selector dial as well as the buttons and pilot lights. These are presented by relevant numbers on the following pages.

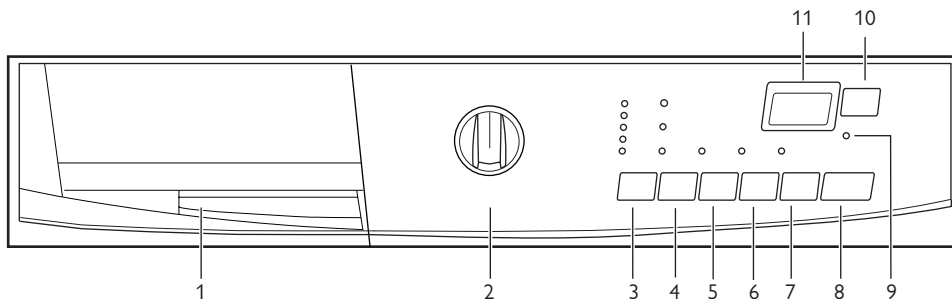

1 Detergent dispenser drawer

2 Programme selector dial

3 Spin button

4 Prewash button

5 Intensive button

6 Extra rinse button

7 Quick button

8 Start/Pause button

9 Door lock light

10 Delay start button

11 Display - Wash time

Programme Dial (2)

It allows you to switch the appliance on/off and/or to select a programme.

Spin (3)

By pressing this button you can change the spin speed of the selected programme or to select the available function (s).

None

By selecting this function all the spinning phases are cancelled and the last rinse water is drained. If you set this option with programmes for cotton, synthetics and delicates, the machine will perform some extra rinses.

Prewash (4)

By pressing this button repeatedly, you can select only one of the following options:

Prewash: the machine performs a prewash cycle before the main wash phase. The washing time will be prolonged. This option is recommended for heavily soiled laundry. The prewash ends with a short spin in programmes for cotton and synthetic fabrics, whereas in the programme for delicate fabrics the water is only drained.

Stain: the machine adds a stain phase to the washing of heavily soiled laundry. The washing time will be prolonged by a few minutes.



Pour a stain removing detergent into the compartment marked [I].

This function is available with a temperature of 40° or higher.

Rinse hold: the machine will not drain the water of the last rinse, this will ensure the minimum of creasing to laundry. Before opening the door the water must be drained.

Intensive (5)

By selecting this function the washing intensity will be increased and the washing time will be prolonged by a few minutes depending on the selected temperature. This option can be selected for heavily soiled cottons.

Extra Rinse (6)

This appliance is designed to save energy. If it is necessary to rinse the laundry using an extra quantity of water (extra rinse), select this option. Some additional rinses will be performed. This option is recommended for people who are allergic to detergents, and in areas where the water is very soft.

Quick (7)

This option can be used for lightly soiled laundry. The washing time will be reduced according to type of fabric and the selected temperature.

Display (11)

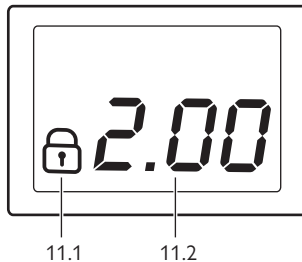

The following pieces of information are shown on the display:

11.1 - Child lock symbol.

11.2

Start Pause (8)

This button allows you to start or to interrupt the selected programme.

Door lock light (9)

The light **Door lock** shows if you can open the door:

- light on: the door cannot be opened. The machine is working or has stopped with water left in the tub.
- light off: the door can be opened. The programme is finished or the water has been emptied out.

Delay Start (10)

The programme can be delayed from 30 min - 60 min - 90 min, 2 hours and then by 1 hour up to a maximum of 20 hours by means of this button.

- **Duration of washing programme** in hours and minutes, after you have selected a programme. While the programme is running (after you have pressed the button **8**), the displayed time value decreases by one unit every minute.

The washing machine has stopped with water in the tub, at the end of the «Soak» programme or if the «Rinse hold» option has been set: this is indicated by a flashing zero. The «Door lock» pilot light is still on. The door cannot be opened.

The washing machine has completed the programme: this is indicated by a flashing zero. The «Door lock» pilot light has gone off. It is now possible to open the door.

- **Delay start**, a time value indicated in hours and selected by the relevant button. The delay time (20 hours max) is

displayed for a few seconds, then the duration of the selected programme reappears. After you have pressed the button **8**, the countdown is updated every hour, and, for the last hour, every minute.

- **An incorrect option selection** has been made: this is indicated by the message **Err** for a few seconds when an option incompatible with the current programme is selected.
- **An alarm code** indicates a fault with the machine (see the relevant chapter).

First use



- Ensure that the electrical and water connections comply with the installation instructions.
- Remove the polystyrene block and any material from the drum.
- Pour 2 litres of water into the main wash compartment [III] of the detergent drawer in order to activate the **ECO** valve. Then run a cotton cycle at the highest temperature without any laundry in the machine, to remove any manufacturing residue from the drum and tub. Pour 1/2 a measure of detergent into the main wash compartment and start the machine.

Personalisation

Acoustic signals

The machine is provided with an acoustic device, which sounds in the following cases:

- at the end of a washing cycle
- if there is a fault

You can deactivate the acoustic signal (except if there is a fault) by pressing the buttons **5** and the **6** simultaneously for about 5 seconds. By pressing these buttons again the acoustic signal is reactivated.

Child lock

This function works in two different ways:

- If enabled before the «Start/Pause» button is pressed, it prevents the machine from being started.
- If enabled after pressing the «Start/Pause» button, it prevents any changes being made to the programmes or options selected

To enable or disable this function, press the buttons **3** and **4** simultaneously for approximately 6 seconds until the icon appears on or disappears from the display.

Daily use

Load the laundry

Open the door by carefully pulling the door handle outwards. Place the laundry in the drum, one item at a time, shaking them out as much as possible. Close the door.

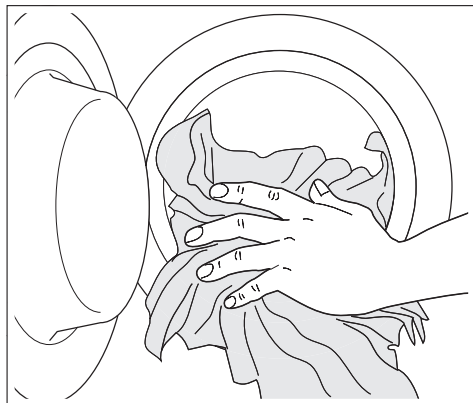

Measure out the detergent

Measure out the detergent and the fabric softener

Pull out the dispenser drawer until it stops. Measure out the amount of detergent required, pour it into the main wash compartment [1] or in the appropriate compartment if it is required by the selected programme or option (see more details in «Detergent dispenser drawer»).

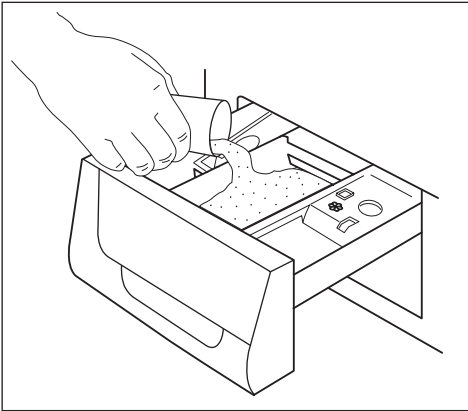

If required, pour fabric softener into the compartment marked  (the amount used must not exceed the «MAX» mark in the drawer). Close the drawer gently.

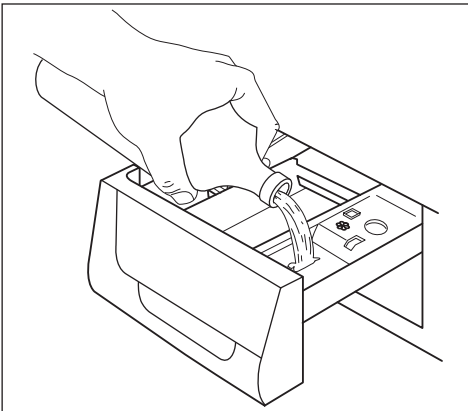

Select the required programme

Turn the programme dial to the required programme. The washing machine will automatically select the maximum spin value provided for the programme you have chosen and the display will show the duration, calculated on the basis of the maximum load for each type of fabric. Pressing the corresponding buttons to

change those values. The **green** pilot light of the button **8** starts flashing.

The dial can be turned either clockwise or counterclockwise. Turn to position «**Off**» to reset programme/Switching the machine off.

At the end of the programme the selector dial must be turned to position «Off», to switch the machine off.



Caution! If you turn the programme selector dial to another programme when the machine is working, the **red** pilot light of button **8** will blink 3 times to indicate a wrong selection. The machine will not perform the new selected programme. The message **Err** is displayed for a few seconds. The machine will not perform the new selected programme.

Select the spin speed or None option

Press button **3** repeatedly to select the required spin speed or to select «None» option. If you select this option, all spinning phases are suppressed. The relevant light will light up.

Select the desired options

Press buttons **4,5,6** and **7** to select the available options. Depending on the programme, different options can be selected together. These must be selected after choosing the desired programme and before pressing button **8**.

If an option which is not compatible with the set wash programme is selected, the red button **8** flashes 3 times and the message **Err** is displayed for a few seconds. When the option is set, the relevant light is on.

Select the delay start

Before you start the programme, press this button repeatedly to select the desired delay. The set delay time value (up to 20 hours) will appear on the display for a few seconds, then the duration of the programme will appear again. The wash programme can be delayed from 30 min - 60 min - 90 min, 2 hours and then by 1 hour up to a maximum of 20 hours.

You can cancel the delay time at any moment, before you press the «Start/ Pause» button.

Selecting the delayed start

You must select this option after you have set the programme and before you press the «Start/Pause» button.

- Select the programme and the required options.
- Select the delay start.
- Press button **8**: the machine starts its hourly count down. The programme will start after the selected delay has expired.

Opening the door throughout the delay time

If you wish to add laundry in the machine during the delay time

- Press button **8** to put the machine in pause.
- Add the laundry, close the door
- Press **8** button again.

Cancelling the delayed start

- Press button **8**.
- Press «Delay start» button once until the symbol «0'» is displayed.

- Press button **8** again.

The Delay Start cannot be selected with the draining programme.

Start the programme

To start the selected programme, press the button **8** ; the green pilot light stops flashing. If you have selected a delay time, the countdown will begin and will be shown on the display.

To interrupt a programme which is running, press button **8**: the green pilot light starts to flash. To restart the programme from the point at which it was interrupted, press the button **8** again. If an incorrect option is selected, the red pilot light of button **8** flashes 3 times and the message **Err** is displayed for a few seconds.

Important!

You must set the washing machine to Pause before you make any change in the programme in progress.

How to change an option or a programme during its cycle

It is possible to **change some options** before the programme carries them out. Before you make any change, you must pause the washing machine by pressing the button **8**. Changing a running programme is possible only **by resetting it**.

Turn the programme selector dial to «Off» and then to the new programme position. Start the new programme by pressing the button **8**. The washing water in the tub will not empty out

How to interrupt a programme

Press the button **8** to interrupt a programme which is running, the corresponding green pilot light starts blinking.

Press the same button again to **restart** the programme.

How to open the door during the cycle of a programme

You can open the door, after having set the washing machine to Pause, provided the following conditions exist:

- The washing machine is not in the heating phase
- The level of the water is not high;

If these requirements are met, when you pause the washing machine, the «Door lock» light goes off and the door can be opened.

Should it not be possible to open the door, and should it be absolutely necessary to do so, switch the machine off by turning the selector dial to **Off**. After a few minutes, you can open the door.

Pay attention to the level and temperature of the water in the washing machine! When you close the door to restart the programme turn the dial to the previous programme and repeat the options previously selected and press button **8**.

End of programme

At the end of the programme, the washing machine stops automatically, the button **8** light and the **Door lock** light go off. The

display shows a flashing zero «0». It is possible to open the door.

If you had selected an option that ends with water left in the tub the **Door lock** light remains lit to indicate that the water must be drained before opening the door.

To drain or to spin follow the below instructions:

1. Turn the programme selector dial to **Off**.
2. Select the draining or spinning programme.
3. Reduce the spin speed if needed, by pressing the relevant button.
4. Press button **8**.

At the end of the programme, the door can be now opened. Turn the programme selector dial to **Off** to switch the machine off.

Remove the laundry from the drum. Check whether the drum is completely empty, by rotating it with your hand. The purpose of this is to prevent any items of laundry from remaining accidentally in the drum, where they might get damaged in a subsequent wash (e.g. by shrinking) or bleed colour into another load of laundry.

If you do not intend to carry out another wash, close the water tap. Leave the door open to prevent the formation of mildew and unpleasant smells.



Stand by: once the programme has finished after a few minutes the energy saving system is enabled with the pilot lights switched on. By pressing any button the appliance will come out of the energy saving status.

Helpful hints and tips

Sorting out the laundry

Follow the wash code symbols on each garment label and the manufacturer's washing instructions. Sort the laundry as follows: whites, coloureds, synthetics, delicates, woollens.

Before loading the laundry

Never wash whites and coloureds together. Whites may lose their «whiteness» in the wash.

New coloured items may run in the first wash; they should therefore be washed separately the first time.

Make sure that no metal objects are left in the laundry (e.g. hair clips, safety pins, pins).

Button up pillowcases, close zip fasteners, hooks and poppers. Tie any belts or long tapes.

Remove persistent stains before washing. Rub particularly soiled areas with a special detergent or detergent paste.

Treat curtains with special care. Remove hooks or tie them up in a bag or net.

Removing stains

Stubborn stains may not be removed by just water and detergent. It is therefore advisable to treat them prior to washing.

Blood: treat fresh stains with cold water.

For dried stains, soak overnight in water with a special detergent then rub in the soap and water.

Oil based paint: moisten with benzine stain remover, lay the garment on a soft cloth and dab the stain; treat several times.

Dried grease stains: moisten with turpentine, lay the garment on a soft surface and dab the stain with your fingertips and a cotton cloth.

Rust: oxalic acid dissolved in hot water or a rust removing product used cold. Be careful with rust stains which are not recent since the cellulose structure will already have been damaged and the fabric tends to hole.

Mould stains: treat with bleach, rinse well (whites and fast coloureds only).

Grass: soap lightly and treat with bleach (whites and fast coloureds only).

Ball point pen and glue: moisten with acetone¹⁾, lay the garment on a soft cloth and dab the stain.

1) do not use acetone on artificial silk

Lipstick: moisten with acetone as above, then treat stains with methylated spirits.

Treat any residual marks with bleach.

Red wine: soak in water and detergent, rinse and treat with acetic or citric acid, then rinse. Treat any residual marks with bleach.

Ink: depending on the type of ink, moisten the fabric first with acetone¹⁾, then with acetic acid; treat any residual marks on white fabrics with bleach and then rinse thoroughly.

Tar stains: first treat with stain remover, methylated spirits or benzine, then rub with detergent paste.

Detergents and additives

Good washing results also depend on the choice of detergent and use of the correct quantities to avoid waste and protect the environment.

Although biodegradable, detergents contain substances which, in large quantities, can upset the delicate balance of nature.

The choice of detergent will depend on the type of fabric (delicates, woollens, cottons, etc.), the colour, washing temperature and degree of soiling.

All commonly available washing machine detergents may be used in this appliance:

- powder detergents for all types of fabric
- powder detergents for delicate fabrics (60°C max) and woollens
- liquid detergents, preferably for low temperature wash programmes (60°C max) for all types of fabric, or special for woollens only.

The detergent and any additives must be placed in the appropriate compartments of the dispenser drawer before starting the wash programme.

If using liquid detergents, a programme **without** prewash must be selected.

Your appliance incorporates a recirculation system which allows an optimal use of the concentrated detergent.

Follow the product manufacturer's recommendations on quantities to use and do **not exceed the «MAX» mark in the detergent dispenser drawer.**

Quantity of detergent to be used

The type and quantity of detergent will depend on the type of fabric, load size, degree of soiling and hardness of the water used.

Follow the product manufacturers' instructions on quantities to use.



Use less detergent if:















- you are washing a small load
- the laundry is lightly soiled
- large amounts of foam form during washing.



Degrees of water hardness

Water hardness is classified in so-called "degrees" of hardness. Information on hardness of the water in your area can be obtained from the relevant water supply company, or from your local authority. If the water hardness degree is medium or high we suggest you to add a water softener following always the manufacturer's instructions. When the degree of hardness is soft, readjust the quantity of the detergent.

Washing programmes

Programme - Maximum and Minimum Temperature - Cycle Description - Maximum Spin Speed - Maximum Fabrics Load - Type of Laundry	Options	Detergent Compartment
<p>Cottons 90° - 60° Main wash - Rinses Maximum spin speed at 1200 rpm Max. load 6 kg - Reduced load 3 kg White cotton (heavily or normally soiled items).</p>	SPIN NONE RINSE HOLD PREWASH INTENSIVE STAIN QUICK ¹⁾ EXTRA RINSE	
<p>Cottons Economy 60° Main wash - Rinses Maximum spin speed at 1200 rpm Max. load 6 kg White or fast colour cotton (normally or slightly soiled items). Energy saving programme: This programme can be selected for slightly or normally soiled cotton items. The temperature will decrease and the washing time will be extended. This allows to obtain a good washing efficiency by saving energy.</p>	SPIN NONE RINSE HOLD PREWASH STAIN EXTRA RINSE	
<p>Cottons Economy 40° Main wash - Rinses Maximum spin speed at 1200 rpm Max. load 6 kg White or non fast colour cotton (slightly soiled items). This programme can be selected for slightly or normally soiled cotton items. The temperature will decrease and the washing time will be extended. This allows to obtain a good washing efficiency by saving energy.</p>	SPIN NONE RINSE HOLD PREWASH STAIN EXTRA RINSE	

Programme - Maximum and Minimum Temperature - Cycle Description - Maximum Spin Speed - Maximum Fabrics Load - Type of Laundry	Options	Detergent Compartment
<p>Cottons 40° - 30° Main wash - Rinses Maximum spin speed at 1200 rpm Max. load 6 kg - Reduced load 3 kg Colour cotton (normally or slightly soiled items).</p>	<p>SPIN NONE RINSE HOLD PREWASH INTENSIVE STAIN³⁾ QUICK¹⁾ EXTRA RINSE</p>	<p>²⁾  </p>
<p>Synthetics 60° - 40° - 30° Main wash - Rinses Maximum spin speed at 900 rpm Max. load 3 kg - Reduced load 1.5 kg Synthetic or mixed fabrics: underwear, coloured garments, non-shrink shirts, blouses.</p>	<p>SPIN NONE RINSE HOLD PREWASH STAIN³⁾ QUICK¹⁾ EXTRA RINSE</p>	<p>²⁾  </p>
<p>Synthetics Economy 40° Main wash - Rinses Maximum spin speed at 900 rpm Max. load 3 kg - Reduced load 1.5 kg Mixed fabrics, shirts, blouses, underwear, coloured garments, non-shrink shirts.</p>	<p>SPIN NONE RINSE HOLD PREWASH STAIN EXTRA RINSE</p>	<p>²⁾  </p>
<p>Delicates 40° - 30° Main wash - Rinses Maximum spin speed 700 rpm Max. load kg 3 - Reduced load kg 1.5 Delicate fabrics: acrylics, viscose, polyester.</p>	<p>SPIN NONE RINSE HOLD PREWASH STAIN³⁾ QUICK¹⁾ EXTRA RINSE</p>	<p>²⁾  </p>
<p>Wool - Hand wash 40° - 30° - Cold Main wash - Rinses Maximum spin speed at 900 Max. load 2 kg Washing programme for machine washable wool as well as for hand washable woollens and delicate fabrics. Note: A single or bulky item may cause imbalance. If the appliance doesn't perform the final spin phase, add more items, redistribute the load manually and then select the spinning programme.</p>	<p>SPIN NONE RINSE HOLD</p>	<p> </p>

Programme - Maximum and Minimum Temperature - Cycle Description - Maximum Spin Speed - Maximum Fabrics Load - Type of Laundry	Options	Detergent Compartment
<p>Soak 30° Prewash - Soak for about 40 minutes - Stop with water in the tub Max. load 6 kg Special programme for heavily soiled laundry. The machine performs a soak at 30°C. At the end of this time the machine will stop automatically with water left in the tub. Before starting a new washing phase, it is necessary to empty out the water by:</p> <ul style="list-style-type: none"> • Draining only: turn the programme selector dial to the draining programme (press then the button 8). • Draining and spinning: turn the programme selector dial to spinning programme, reduce the spin speed by pressing the relevant button, press then button 8. <hr/> <p>Important! This programme cannot be used for very delicate fabrics as silk or wool. Pour the detergent for the soak programme into the compartment marked . At the end of the soak (after having emptied out the water) you can select the washing programme. (First turn the programme selector dial to Off, then to the programme and press the button 8).</p> <hr/>		
<p>Rinse Rinses Maximum spin speed at 1200 rpm Max. load 6 kg With this programme it is possible to rinse and spin cotton garments which have been washed by hand. The machine performs a few rinses, followed by a final long spin. The spin speed can be reduced.</p>	SPIN NONE RINSE HOLD EXTRA RINSE	
<p>Drain Draining of water Max. load 6 kg For emptying out the water of the last rinse in programmes with the set option, which ends with water left in the tub.</p>		

Programme - Maximum and Minimum Temperature - Cycle Description - Maximum Spin Speed - Maximum Fabrics Load - Type of Laundry	Options	Detergent Compartment
Spin Drain and long spin Maximum spin speed at 1200 rpm Max. load 6 kg Separate spin for hand washed cotton garments and after programmes with option Rinse hold. You can choose the spin speed by pressing the relevant button to adapt it to the fabrics to be spun.	SPIN	
30 Minute wash 30° Main wash - Rinses Maximum spin speed 900 rpm Max. load kg 2 Short cycle for lightly soiled fabrics.	SPIN NONE	
Off For cancelling the programme which is running or to switch the machine off .		

- 1) If you select the Quick option by pressing button **4**, we recommend that you reduce the maximum load as indicated. Full loading is possible however with somewhat reduced cleaning results.
- 2) If using liquid detergents, a programme without PREWASH must be selected.
- 3) «Stain» option is available only at a temperature of 40°C or higher.

Technical data

Dimensions	Width Height Depth Depth (Overall dimensions)	60 cm 85 cm 60 cm 63 cm
Electrical connection Voltage - Overall power - Fuse	Information on the electrical connection is given on the rating plate, on the inner edge of the appliance door.	
Water supply pressure	Minimum Maximum	0,05 MPa 0,8 MPa
Maximum Load	Cotton	6 kg
Spin Speed	Maximum	1200 rpm

Consumption values

Programme ¹⁾	Energy consumption (KWh) ²⁾	Water consumption (litre) ²⁾
White Cottons 95 °C	2.1	62
Cottons 60 °C	1.35	59
Cottons 40 °C	0.75	59
Synthetics 40 °C	0.5	44
Delicates 40 °C	0.55	57
Wool/ Handwash 30 °C	0.3	57

1) Refer to the display for the programme time.

2) The consumption information shown in this chart is indicative. It can vary depending on the quantity and the type of laundry, on the temperature of the water supply and on the ambient temperature.

Standard programmes for the Energy Label consumption values

The cotton 60 °C economy and cotton 40 °C economy are the standard cotton programmes for normally soiled cotton laundry. They are suitable to clean normally soiled cotton laundry and they are the most

efficient programmes in terms of combined energy and water consumption for washing that type of cotton laundry.

They agree with EN60456.



The actual water temperature may differ from the declared cycle temperature.

Care and cleaning

You must DISCONNECT the appliance from the electricity supply, before you can carry out any cleaning or maintenance work.

Descaling

The water we use normally contains lime. It is a good idea to periodically use a water softening powder in the machine. Do this separately from any laundry washing, and according to the softening powder manufacturer's instructions. This will help to prevent the formation of lime deposits.

After each wash

Leave the door open for a while. This helps to prevent mould and stagnant smells forming inside the appliance. Keeping the door open after a wash will also help to preserve the door seal.

Maintenance wash

With the use of low temperature washes it is possible to get a build up of residues inside the drum.

We recommend that a maintenance wash be performed on a regular basis.

To run a maintenance wash:

- The drum should be empty of laundry.
- Select the hottest cotton wash programme.
- Use a normal measure of detergent, must be a powder with biological properties.

External cleaning

Clean the exterior cabinet of the appliance with soap and water only, and then dry thoroughly.

Important! Do not use methylated spirits, solvents or similar products to clean the cabinet.

Cleaning the dispenser drawer

The washing powder and additive dispenser drawer should be cleaned regularly. Remove the drawer by pressing the catch downwards and by pulling it out. Flush it out under a tap, to remove any traces of accumulated powder.

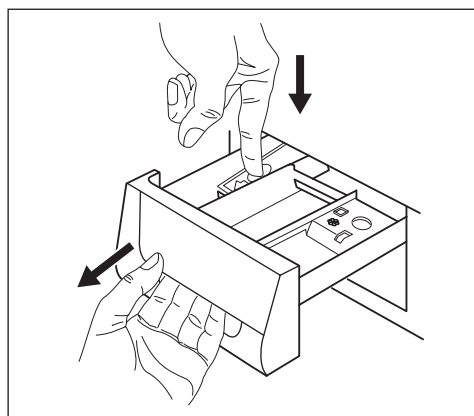
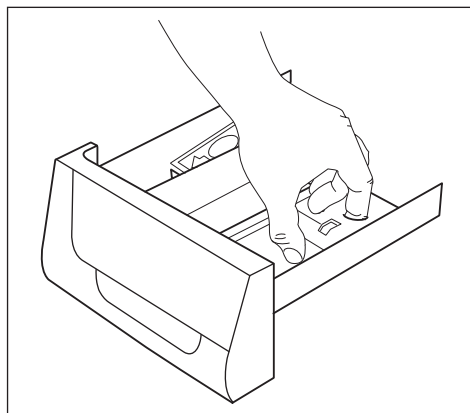

To aid cleaning, the top part of the additive compartment should be removed.

Cleaning the drawer recess

Having removed the drawer, use a small brush to clean the recess, ensuring that all washing powder residue is removed from the upper and lower part of the recess.

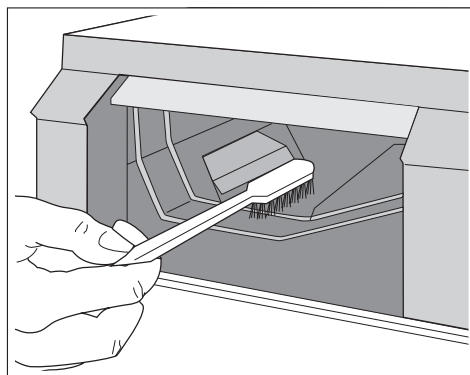

Replace the drawer and run the rinse programme without any clothes in the drum.

Washing drum

Rust deposits in the drum may occur due to rusting foreign bodies in the washing or tap water containing iron.

Important! Do not clean the drum with acidic descaling agents, scouring agents containing chlorine or iron or steel wool.

1. Remove any rust deposits on the drum with a cleaning agent for stainless steel.
2. Run a washing cycle without any washing to clean off any cleaning agent residues.

Programme: Short Cotton Programme at maximum temperature and add approx. 1/4 measuring cup of detergent.

Door seal

Check from time to time the door seal and possible objects that could be trapped in the fold.

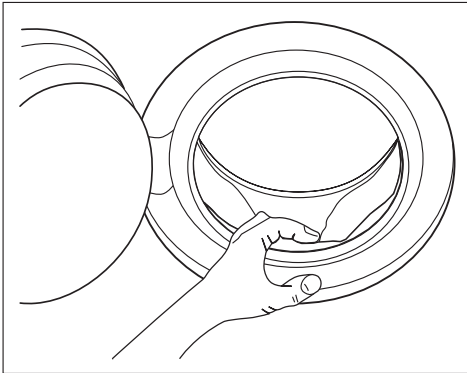

Cleaning the pump

The pump should be inspected regularly and particularly if:

- the appliance does not empty and/or spin;
- the appliance makes an unusual noise during draining due to objects such as safety pins, coins etc. blocking the pump.
- a problem with water draining is detected (see chapter "What to do if..." for more details).



Warning! Before opening the pump door, switch the appliance off and remove the mains plug from the socket.

Proceed as follows:

1. Unplug the appliance.
2. If it is necessary, wait until the water has cooled down.
3. Open the pump door levering on the groove with a coin (or with the suitable tool, that you can find in the bag containing the instruction booklet depending on the model).

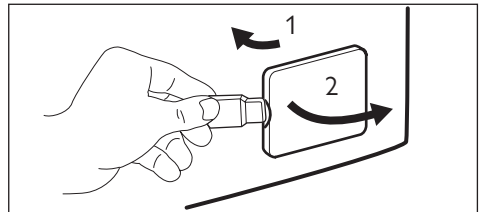

4. Place a container close to the pump to collect any spillage.

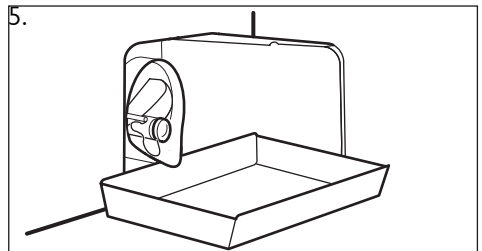

- 5.
6. Pull out the emergency emptying cap from the filter cover, using pliers.

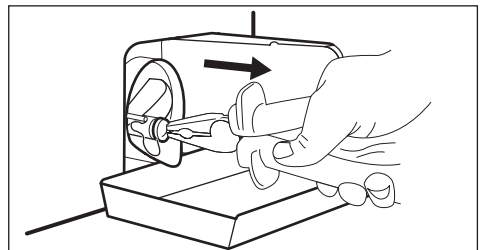

7. When no more water comes out, unscrew the pump cover by turning it anti-clockwise, using pliers, and remove the filter. Always keep a towel nearby to dry up any water spillage when removing the cover. Clean the filter under a tap, to remove any traces of fluff.

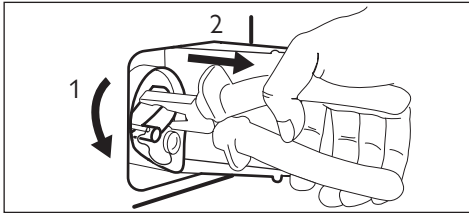
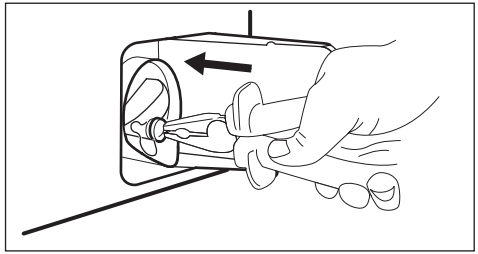

8. Remove foreign bodies and fluff from the pump seat and from the pump impeller.

11. Replace the emergency emptying cap into the filter cover and fix it firmly.

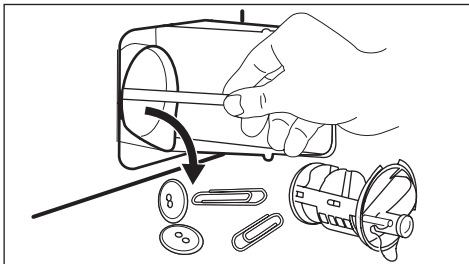
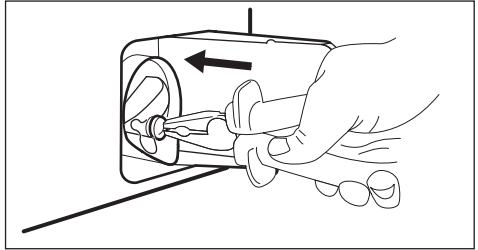

9. Check carefully whether the pump impeller rotates (it rotates jerkily). If it doesn't rotate, please contact your Service Centre.

10. Replace the filter into the pump by inserting it correctly into the special guides. Screw the pump cover firmly by turning it clockwise.

12. Close the pump door.

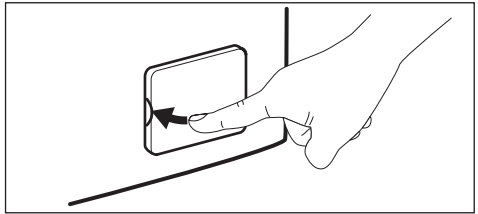

Warning!

When the appliance is in use and depending on the programme selected there can be hot water in the pump. Never remove the pump cover during a wash cycle, always wait until the appliance has finished the cycle, and is empty. When refitting the pump cover, ensure it is securely re-tightened so as to stop leaks and young children being able to remove it.

Cleaning the water inlet filters



Warning! If the appliance doesn't fill or it is taking longer to fill with water, check if the water inlet filters are blocked.

1. Turn off the water tap.
2. Unscrew the water inlet hose.
3. Clean the filter using a hard bristle brush.

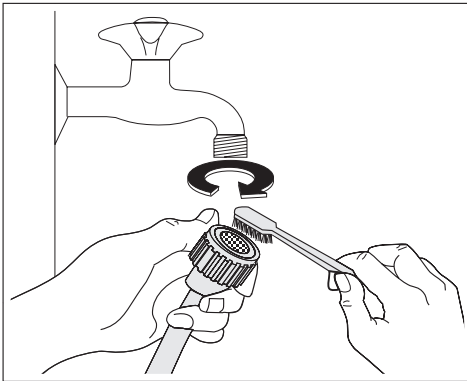

4. Screw the hose back onto the tap.
5. Unscrew the hose from the machine. Keep a rug nearby because some water may flow.
6. Clean the filter in the valve with a stiff brush or with the piece of cloth.

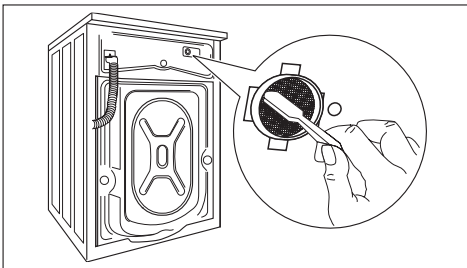

7. Screw the hose back to the machine and make sure the connection is tight.

8. Turn on the water tap.

Emergency emptying out

If the water is not discharged, proceed as follows to empty out the machine:

1. pull out the plug from the power socket;
2. close the water tap;
3. if necessary, wait until the water has cooled down;
4. open the pump door;
5. place a bowl on the floor. Remove the emergency emptying cap from the filter. The water should drain by gravity into the bowl. When the bowl is full, refit the cap into the filter. Empty the bowl. Repeat the procedure until water stops flowing out;
6. clean the pump if necessary as previously described;
7. screw the pump again and close the door.

Frost precautions

If the machine is installed in a place where the temperature could drop below 0°C, proceed as follows:

1. Pull out the plug from the power socket.
2. Turn off the water tap.
3. Unscrew the inlet hose.
4. Place the end of the inlet hose in a bowl placed on the floor, open the emergency emptying cup of the filter and let water drain out.
5. Refit the emergency emptying cap into the filter and screw the water inlet hose back.
6. When you intend to start the machine up again, make sure that the room temperature is above 0°C.

Important! Every time you drain the water through the emergency emptying hose you must pour 2 litres of water into the main wash compartment of the detergent drawer and then run the drain programme. This will avoid wasting detergent on the next wash programme.

Installation

Unpacking

All transit bolts and packing must be removed before using the appliance. You are advised to keep all transit devices so that they can be refitted if the machine ever has to be transported again.

1. After removing all the packaging, carefully lay machine on it's back to remove the polystyrene base from the bottom.

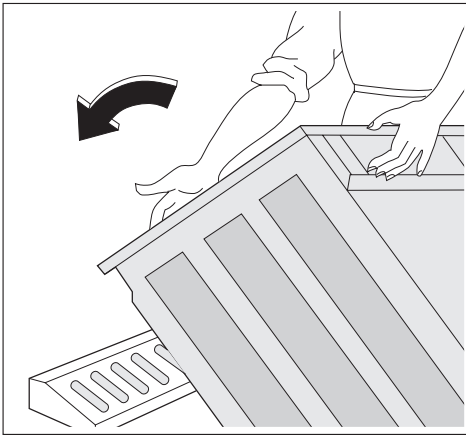

2. Remove the power supply cable and the draining and inlet hose from the hose holders on the rear of the appliance.

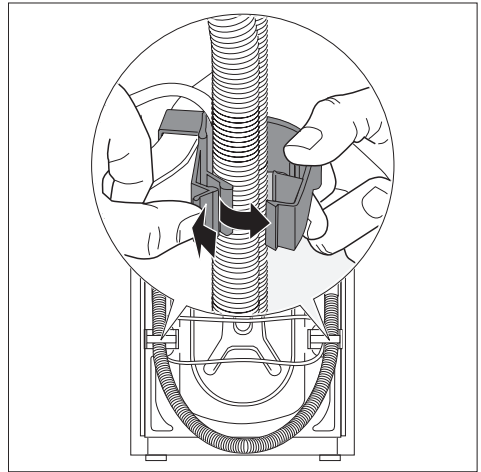

3. Unscrew the three bolts.

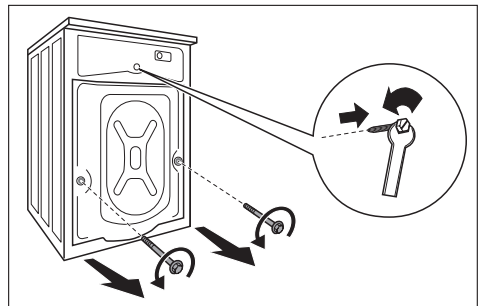

4. Slide out the relevant plastic spacers.

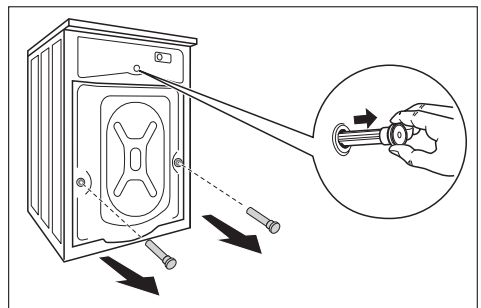

5. Open the porthole and remove the polystyrene block fitted on the door seal.

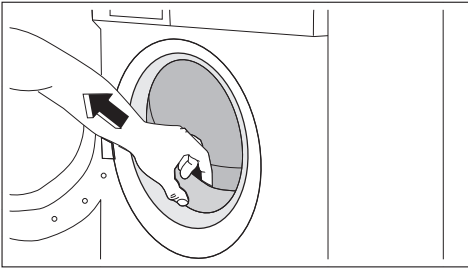

6. Fill the smaller upper hole and the two large ones with the corresponding plastic plug caps supplied in the bag containing the instruction booklet.

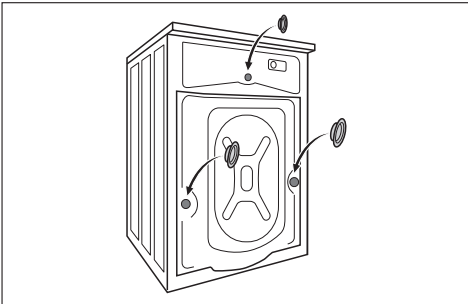

should protrude a few centimetres beyond the edges of the machine.



Warning! The machine should NOT be placed on deep pile carpeting.

Level the washing machine by raising or lowering the feet. The feet may be tight to adjust as they incorporate a self locking nut, but the machine **MUST** be level and stable. If necessary, check the setting with a spirit level. Any necessary adjustment can be made with a spanner. Accurate levelling prevents vibration, noise and displacement of the machine during operation.

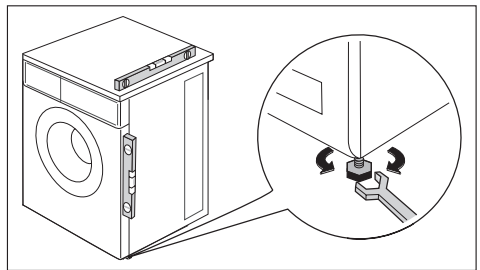

Some vibration is inevitable, especially if mounted on a wooden floor. Sprung wooden floors are particularly susceptible to vibration. For advice, consult a builder. If possible, always place the machine on a solid floor.

Positioning and levelling

Install the machine on a flat hard floor. Make sure that air circulation around the machine is not impeded by carpets, rugs etc. Check that the machine does not touch the wall or other kitchen units.



Caution! Never place cardboard, wood or similar materials under the machine to compensate for any unevenness in the floor.

If the floor is carpeted or covered with crumbly or soft material, insert a rigid support base under the feet to prevent noise, vibration or displacement. The base

Plumbing in

Your new washing machine has been designed to be permanently plumbed in to your home's water supply and drainage system. However, if this is not possible, it may be connected to a suitable existing tap with the drain hose discharging into a sink. The appliance has an inlet hose, with female 3/4" BSP thread connector. If this connection is not compatible with the plumbing of the existing installation, a variety

of connectors are available from good hardware stores and plumbers merchants to suit most domestic plumbing. Any alteration to your existing plumbing must be carried out by a competent person, or qualified plumber.

Water inlet



Warning! This appliance must be connected to a cold water supply.

The inlet hose is screwed to the back of the appliance.

1. Set the hose correctly by loosening the ring nut. After positioning the inlet hose, be sure to tighten the ring nut again to prevent leaks. Always use the hose supplied with the appliance.

Important! Do not place the inlet hose downwards. Angle the hose to the left or right depending on the position of your water tap as indicated in the picture.

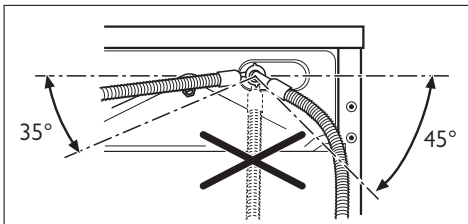

2. Connect the water inlet hose supplied with the machine to a tap with a 3/4" thread. Installation should comply with local water authority and building regulations' requirements.

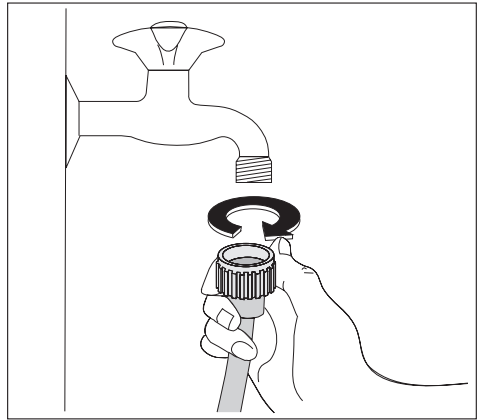

The inlet hose must not be lengthened. If it is too short and you do not wish to move the tap, you will have to purchase a new, longer hose specially designed for this type of use.



Warning! Installation should comply with local water authority and building regulations' requirements. The appliance must be connected to a cold water supply.

A minimum water pressure of 0.05 MPa (0.5 bar) is required for safe operation of the appliance.

If you cannot make the cold water connection direct from the rising mains, you may be able to operate the appliance from your cold water storage system.

There should be a minimum vertical distance of 5.02 m (16.5 ft) between the appliance's inlet and the bottom of the water storage tank.

Water drainage

This appliance is designed to be permanently plumbed into your home's drainage system using one of the following methods.

1. Into a drainage standpipe

Firstly form a hook in the end of the drain hose using the "U" piece" supplied.

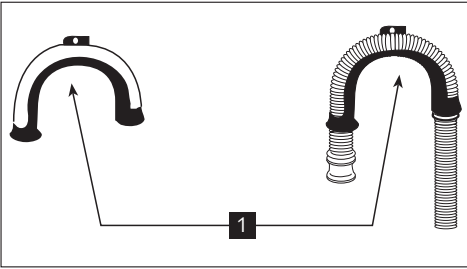

Place the drain hose into your standpipe, which should have an internal diameter of approximately 38 mm thus ensuring there is an air break between the drain hose and standpipe.

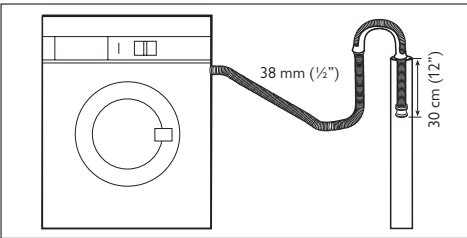

When discharging into a standpipe ensure that the top of the standpipe is no more than 90 cm (35.4") and no less than 60 cm (23.6") above floor level.

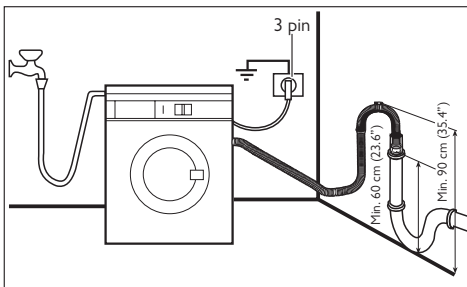

The drain hose may be extended to a maximum of 4 metres. An additional drain hose and joining piece is available from your

local Service Force Centre. The joining piece must have an internal diameter of 18 mm. If your drain hose looks like this (see below) you do not require the "U" piece". Just push the hose firmly in to the standpipe.

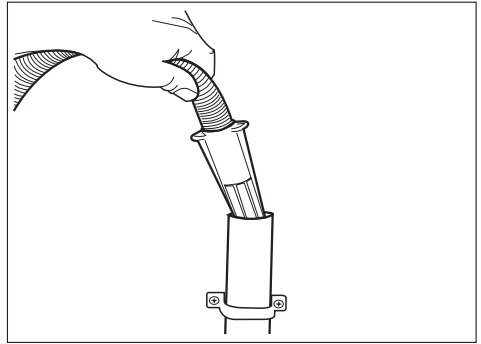

2. Onto a sink outlet spigot.

If the outlet spigot has not been used before, remove any blanking plug that may be in place.

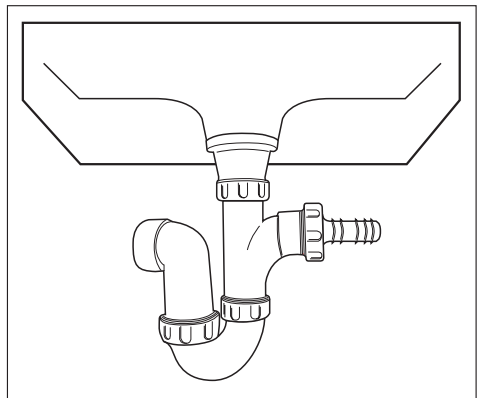

Push the drain hose onto the spigot and secure with a clip, ensure a loop is formed in the drain hose (see diagram) to prevent waste from the sink entering the appliance. If you intend to drain the hose from the machine into a sink, make sure that the sink is empty and the plug hole is not blocked. Use the plastic "U - Piece".

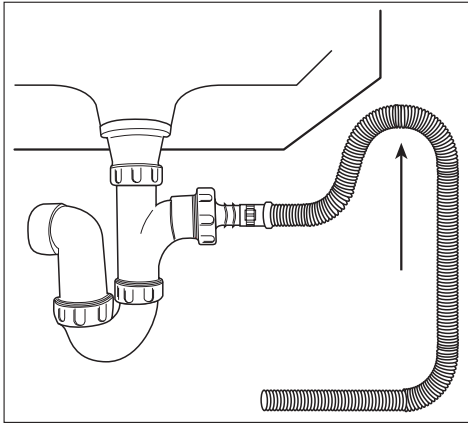

Important! Before connecting up the machine to new pipework or to pipework that has not been used for some time, run off a reasonable amount of water to flush out any debris that may have collected in the pipes.

Special conditions

If the floor is carpeted or covered with crumbly or soft material, insert a rigid support base under the feet to prevent noise, vibration or displacement. The base

should protrude a few centimetres beyond the edges of the appliance.



Warning! The appliance should NOT be placed on deep pile carpeting.

Note!

Please ensure that when the appliance is installed it is easily accessible for the engineer in the event of a breakdown.

In the interest of the environment

The appliance should be connected to the FOUL drainage system, the water will then be taken to a sewage works for treatment before being discharged safely into a river. It is essential that these appliances are not connected to the surface water drainage system as this water is discharged directly into a river or stream and may cause pollution.

If you require any further advice please contact your local water authority.

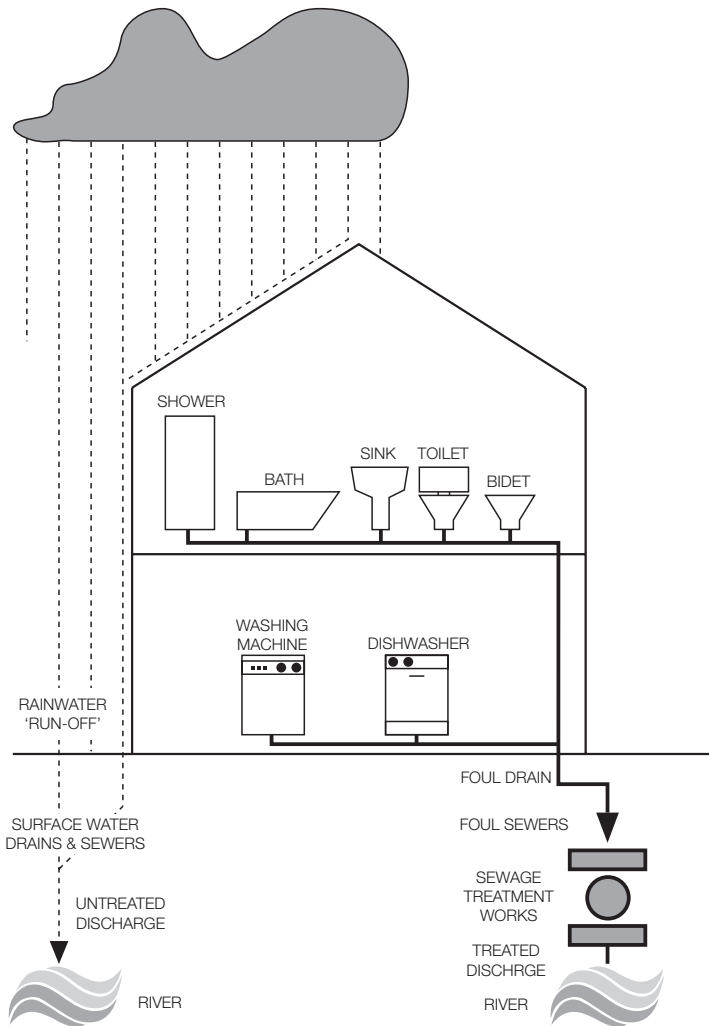

Electrical connection

Any electrical work required to install this appliance should be carried out by a qualified electrician or competent person.



Warning! THIS APPLIANCE MUST BE EARTHED.

The manufacturer declines any liability should this safety measure not be observed.

Before switching on, make sure the electricity supply voltage is the same as that indicated on the appliance's rating plate.

Important! Information on the electrical connection is given on the rating plate on the inner edge of the appliance door.

The appliance is supplied with a 13 amp plug fitted.

In the event of having to change the fuse in the plug supplied, a 13 amp ASTA approved (BS1363/A) fuse must be used.

Should the plug need to be replaced for any reason, proceed as described below.

The wires in the mains lead are coloured in accordance with the following code:

- 1** Green and Yellow - Earth
- 2** Brown- Live
- 3** Cord Clamp
- 4** Blue- Neutral

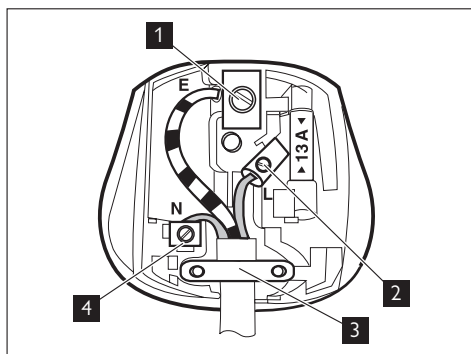

The wire coloured green and yellow must be connected to the terminal marked with the letter «E» or by the earth symbol \perp or coloured green and yellow.

The wire coloured blue must be connected to the terminal «N» or coloured black.

The wire coloured brown must be connected to the terminal marked «L» or coloured red.

Upon completion there must be no cut, or stray strands of wire present and the cord clamp must be secure over the outer sheath.



Warning! A cut off plug inserted into a 13 amp socket is a serious safety (shock) hazard. Ensure that the cut off plug is disposed of safely. Should the appliance power supply cable need to be replaced, this must be carried out by our Service Force Centre. The appliance should not be connected to the electrical supply by means of an extension cable.

Note!

When the appliance is installed the power supply cable must be accessible.

Permanent connection

in the case of permanent connection it is necessary that you install a double pole switch between the appliance and the electricity supply (mains), with a minimum gap of 3 mm between the switch contacts and of a type suitable for the required load in compliance with the current electrical regulations.

The switch must not break the yellow and green earth cable at any point.

What to do if...

Certain problems are due to lack of simple maintenance or oversights, which can be solved easily without calling out an engineer. Before contacting your local Service Centre, please carry out the checks listed below.

Important! if you call out an engineer to a fault listed below, or to repair a fault caused by incorrect use or installation, a charge will be made even if the appliance is under guarantee.

During machine operation it is possible that the **red** Start/Pause pilot light flashes, one of the following alarm codes appears on the

display and some acoustic signals sound to indicate that the machine is not working:

- **E10**: problem with the water supply
- **E20**: problem with water draining
- **E40**: door open

Once the problem has been eliminated, press the button **8** to restart the programme. If after all checks, the problem persists, contact your local Service Force Centre.

Problem	Possible cause/Solution
The washing machine does not start:	The door has not been closed (E40) . <ul style="list-style-type: none">• Close the door firmly. The plug is not properly inserted in the power socket. <ul style="list-style-type: none">• Insert the plug into the power socket. There is no power at the socket. <ul style="list-style-type: none">• Please check your domestic electrical installation. The main fuse or the fuse in a plug has blown. <ul style="list-style-type: none">• Replace the fuse. The button 8 has not been pressed. <ul style="list-style-type: none">• Please press the button 8 again. The «Delay start» option has been selected. <ul style="list-style-type: none">• Please cancel the Delay start. The «Child lock» option has been enabled. <ul style="list-style-type: none">• Disable the Child lock.

Problem	Possible cause/Solution
<p>The machine does not fill:</p>	<p>The water tap is closed (E10).</p> <ul style="list-style-type: none"> • Open the water tap. <p>The inlet hose is squashed or kinked (E10).</p> <ul style="list-style-type: none"> • Check the inlet hose connection. <p>The filter in the inlet hose or the inlet valve filter is blocked (E10).</p> <ul style="list-style-type: none"> • Clean the water inlet filters (See «Cleaning the water inlet filters» for more details). <p>The door is not properly closed (E40) .</p> <ul style="list-style-type: none"> • Close the door firmly.
<p>The machine does not empty and/or does not spin:</p>	<p>The drain hose is squashed or kinked (E20).</p> <ul style="list-style-type: none"> • Check the drain hose connection. <p>The drain filter is clogged (E10) .</p> <ul style="list-style-type: none"> • Clean the drain filter. <p>An option or a programme that ends with the water still in the tub or that eliminates all the spinning phases has been selected.</p> <ul style="list-style-type: none"> • Select the draining or spinning programme. <p>The laundry is not evenly distributed in the drum.</p> <ul style="list-style-type: none"> • Redistribute the laundry.
<p>The machine fills than empties out immediately:</p>	<p>The end of drain hose is too low.</p> <p>The end of drain hose is submerged in water.</p> <p>There is no vent in the end of drain hose.</p> <ul style="list-style-type: none"> • Refer to relevant paragraph in "Water drainage" section.
<p>There is water on the floor:</p>	<p>Too much detergent or unsuitable detergent (creates too much foam) has been used.</p> <ul style="list-style-type: none"> • Reduce the detergent quantity or use another one. <p>Check whether there are any leaks from one of the inlet hose fittings. It is not always easy to see this as the water runs down the hose; check to see if it is damp.</p> <ul style="list-style-type: none"> • Check the water inlet hose connection. <p>The drain or inlet hose is damaged.</p> <ul style="list-style-type: none"> • Replace it with a new one. <p>The emergency emptying cap has not been replaced into the filter or the filter has not been properly screwed in after cleaning action.</p> <ul style="list-style-type: none"> • Refit the emergency emptying cap into the filter or screw the filter fully in.

Problem	Possible cause/Solution
Unsatisfactory washing results:	<p>Too little detergent or unsuitable detergent has been used.</p> <ul style="list-style-type: none"> • Increase the detergent quantity or use another one. <p>Stubborn stains have not been treated prior to washing.</p> <ul style="list-style-type: none"> • Use commercial products to treat the stubborn stains. <p>The correct temperature was not selected.</p> <ul style="list-style-type: none"> • Check if you have selected the correct temperature. <p>Excessive laundry load.</p> <ul style="list-style-type: none"> • Reduce the laundry load.
The door will not open:	<p>The programme is still running.</p> <ul style="list-style-type: none"> • Wait the end of washing cycle. <p>The door lock has not been released. (Door lock pilot light is on)</p> <ul style="list-style-type: none"> • Wait the door release. <p>There is water in the drum.</p> <ul style="list-style-type: none"> • Select drain or spin programme to empty out the water.
The machine vibrates / The machine is noisy:	<p>The transit bolts and packing have not been removed.</p> <ul style="list-style-type: none"> • Check the correct installation of the appliance. <p>The support feet have not been adjusted</p> <ul style="list-style-type: none"> • Check the correct levelling of the appliance. <p>The laundry is not evenly distributed in the drum.</p> <ul style="list-style-type: none"> • Redistribute the laundry. <p>Maybe there is very little laundry in the drum.</p> <ul style="list-style-type: none"> • Load more laundry.
Spinning starts late or the machine does not spin:	<p>The electronic unbalance detection device has cut in because the laundry is not evenly distributed in the drum. The laundry is redistributed by reverse rotation of the drum. This may happen several times before the unbalance disappears and normal spinning can resume. If, after 10 minutes, the laundry is still not evenly distributed in the drum, the machine will not spin. In this case, redistribute the load manually and select the spin programme.</p> <ul style="list-style-type: none"> • Redistribute the laundry. <p>The load is too small.</p> <ul style="list-style-type: none"> • Add more items, redistribute the load manually and then select the spinning programme.
The machine makes an unusual noise:	<p>The machine is fitted with a type of motor which makes an unusual noise compared with other traditional motors. This new motor ensures a softer start and more even distribution of the laundry in the drum when spinning, as well as increased stability of the machine.</p>
No water is visible in the drum:	<p>Machines based on modern technology operate very economically using very little water without affecting performance.</p>

Repairs - After Sales Service

Repairs - After Sales Service

Your appliance comes with a three year warranty.

If it is not working correctly; consult the fault finding guides within this instruction book ("What to do if ..."). If a fault occurs which you can not resolve through following the advice and information contained within this instruction manual, the next step is to contact our extended warranty administrators on:

0844 871 7771

They will give you details for your local Service engineer. Before calling out an engineer, please ensure you have read the details under the heading "What to do if...". When you contact the local service engineer you will need to give the following details:

1. Your name, address and post code
2. Your telephone number
3. Clear and concise details of fault
4. The purchase date as found on your receipt
5. The model number, product number and serial number of the appliance (found on the rating plate - see picture)

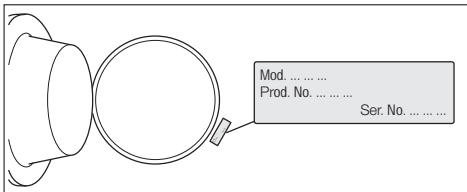

So that you always have these numbers at hand, we recommend you to make a note of them here:

- Mod.....
- P.N.C.....
- S.N.....

Please retain your purchase receipt safely for the service engineer to verify the purchase details.

Important! If you call out an engineer to a fault listed above, or to repair a fault caused by incorrect use or installation, a charge will be made even if the appliance is under guarantee.

Spare parts

Always insist on genuine spare parts. An authorised service engineer should service this product, and only genuine spare parts should be used. Under no circumstances should you attempt to repair the machine yourself. Repairs carried out by inexperienced persons may cause injury or serious malfunctioning. Contact your local John Lewis Branch.

Environment concerns

The symbol  on the product or on its packaging indicates that this product may not be treated as household waste. Instead it should be taken to the appropriate collection point for the recycling of electrical and electronic equipment. By ensuring this product is disposed of correctly, you will help prevent potential negative consequences for the environment and human health, which could otherwise be caused by inappropriate waste handling of this product. For more detailed information about recycling of this product, please contact your local council, your household waste disposal service or the shop where you purchased the product.

- With adequate pre-treatment, stains and limited soiling can be removed; the laundry can then be washed at a lower temperature.
- Measure out detergent according to the water hardness, the degree of soiling and the quantity of laundry being washed.

Packaging materials

The materials marked with the symbol  are recyclable.

>PE<=polyethylene

>PS<=polystyrene

>PP<=polypropylene

This means that they can be recycled by disposing of them properly in appropriate collection containers.

Ecological hints

To save water, energy and to help protect the environment, we recommend that you follow these tips:

- Normally soiled laundry may be washed without prewashing in order to save detergent, water and time (the environment is protected too!).
- The machine works more economically if it is fully loaded.

John Lewis Partnership

171 Victoria Street
London SW1E 5NN
www.johnlewis.com

Free Manuals Download Website

<http://myh66.com>

<http://usermanuals.us>

<http://www.somanuals.com>

<http://www.4manuals.cc>

<http://www.manual-lib.com>

<http://www.404manual.com>

<http://www.luxmanual.com>

<http://aubethermostatmanual.com>

Golf course search by state

<http://golfingnear.com>

Email search by domain

<http://emailbydomain.com>

Auto manuals search

<http://auto.somanuals.com>

TV manuals search

<http://tv.somanuals.com>