

JLWMI201
1200 spin washing machine

JLWMI402
1400 spin washing machine

Instruction manual

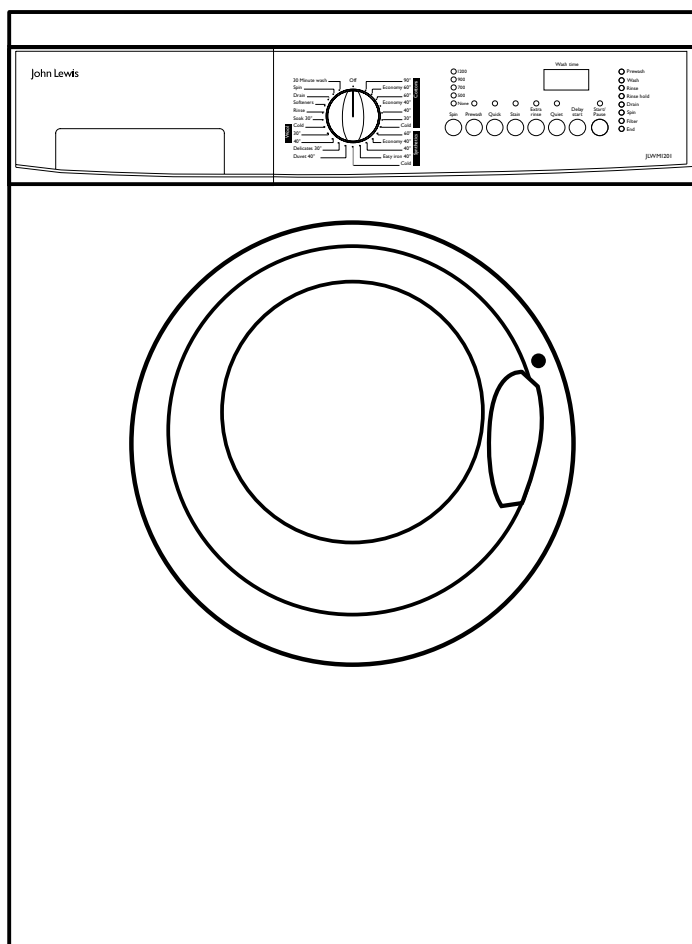

John Lewis



Important Safety Information

It is most important that this instruction book should be retained with the appliance for future reference. Should the appliance be sold or transferred to another owner, or should you move house and leave the appliance, always ensure that the book is supplied with the appliance in order that the new owner can get to know the functioning of the appliance and the relevant warnings.

These warnings have been provided in the interest of safety. You **MUST** read them carefully before installing or using the appliance. If you are unsure of the meanings of these warnings contact the John Lewis branch from which you purchased the appliance.

Installation

- This appliance is heavy. Care should be taken when moving it.
- It is dangerous to alter the specifications or attempt to modify this product in any way.
- All packing and transit bolts must be removed before use. Serious damage can occur to the product and to property if this is not adhered to. See relevant section in instructions.
- Any plumbing work required to install this appliance should be carried out by a qualified plumber or competent person.
- Any electrical work required to install this appliance should be carried out by a qualified electrician or competent person.
- Care must be taken to ensure that the appliance does not stand on the electrical supply cable.
- If the machine is situated on a carpeted floor, please adjust the feet in order to allow air to circulate freely.

Child Safety

- This appliance is designed to be operated by adults. Children should not be allowed to tamper with the controls or play with the product.
- Pets and children have been known to climb into washing machines. Please check your drum before use.
- The glass door becomes very hot during the washing cycle. Keep children away from the vicinity of the appliance whilst it is in operation.
- Keep all packaging well away from children.
- Keep all detergents in a safe place out of children's reach.

Use

- Always unplug the appliance and turn off the water supply after use.
- Do not overload the appliance. See relevant section in the instruction book.
- Only wash fabrics which are designed to be machine washed. If in doubt, consult the care label on the clothes.
- Before washing, ensure that all pockets are empty and buttons and zips are fastened. Avoid washing frayed or torn articles and treat stains such as paint, ink, rust, and grass before washing. Underwired bras must **NOT** be machine washed.
- Any objects such as coins, safety pins, nails, screws, stones or any other hard, sharp material can cause extensive damage and must not be placed into the machine.
- Garments which have been in contact with volatile petroleum products should not be machine washed. If volatile cleaning fluids are used, care should be taken to ensure that the fluid is removed from the garment before placing in the machine.
- Wash small items such as socks, laces, washable belts etc in a washing bag or pillow case as it is possible for such items to slip down between the tub and the inner drum.
- Only use the advised quantities of fabric softener. Damage to the fabric can ensue if you over-fill. Refer to the manufacturer's recommendations of quantities.
- As some duvets and eiderdowns should be washed in large commercial machines because of their bulk, please check with the manufacturer of the item before washing in a domestic machine.
- Leave the porthole door slightly ajar between washes to preserve the door seal.
- Under no circumstances should you attempt to repair the machine yourself. Repairs carried out by inexperienced persons may cause injury or serious malfunctioning. Contact your local Service Force Centre. Always insist on genuine spare parts.

Contents

For the User

| | |
|---|--------------|
| Important Safety Information | 2 |
| Your New Washing Machine | 4 |
| Description of the Appliance | 5 |
| Door locked light | 5 |
| Detergent dispenser drawer | 5 |
| Child safety feature | 5 |
| The Control Panel | 6-9 |
| Programme information | 9 |
| Operating Sequence | 10-12 |
| Load the laundry | 10 |
| Measure out the detergent | 10 |
| Measure out the fabric softener | 10 |
| Switch the machine on | 10 |
| Select the desired programme/temperature | 10 |
| Select the spin speed or the “None” option | 11 |
| Select the desired options | 11 |
| Select the “Delay start” | 11 |
| Start the programme | 11 |
| How to change an option or a programme during its cycle | 11 |
| How to interrupt a programme | 12 |
| How to open the door during the cycle of a programme | 12 |
| End of programme | 12 |
| Washing Hints | 13 |
| Wash Care Symbols | 14 |
| Washing Programmes | 15-16 |

| | |
|---------------------------------|--------------|
| Maintenance and Cleaning | 17-18 |
| Descaling | 17 |
| After each wash | 17 |
| Maintenance Wash | 17 |
| External cleaning | 17 |
| Cleaning the dispenser drawer | 17 |
| Cleaning the drawer recess | 17 |
| Cleaning the pump | 17-18 |
| Cleaning the water inlet filter | 18 |
| The dangers of freezing | 18 |
| Emergency emptying out | 18 |
| Something Not Working | 19-20 |
| Service and Spare Parts | 20 |

For the Installer

| | |
|------------------------------------|-----------|
| Installation Instructions | 21 |
| Technical Specifications | 21 |
| Unpacking | 22 |
| Positioning | 22 |
| Water inlet | 23 |
| Water drainage | 23-24 |
| Levelling | 24 |
| Special conditions | 24 |
| In the interest of the environment | 24-25 |
| Electrical connection | 25 |

Guide to use the Instruction Book

The following symbols will be found in the text to guide you throughout the instructions:



Safety instructions



Hints and tips



Environmental information

Your New Washing Machine

Your new washing machine meets all modern requirements for effective treatment of laundry with low water, energy and detergent consumption.

Even small loads are washed “economically” because the amount of water used is regulated automatically according to the load and type of fabric.

- **The programme progress display** shows the programme steps selected, the programme phase which is running and the end of the programme.
- **The programme selector dial** combines the function of programme and temperature selection, making it easier to set the programme.
- **Automatic cooling of the wash water to 60°C** before draining, with the 90°C programme. This reduces thermal shock to fabrics, helping to prevent creasing.
- **The special wool programme** with its new delicate wash system treats your woollens with extreme care.
- **The balance control device** ensures that the washing machine remains stable when spinning.
- **The ECO valve** allows total use of detergent and reduces water consumption so saving energy.

Ecological hints

To save water and energy and help protect the environment, we recommend that you follow these hints:

- Normally soiled laundry may be washed without prewashing in order to save detergent, water and time (the environment is protected too!).
- The machine works more economically if it is fully loaded.
- With adequate pre-treatment, stains and limited soiling can be removed; the laundry can then be washed at a lower temperature.
- Measure out detergent according to the water hardness, the degree of soiling and the quantity of laundry being washed.

In the interest of the environment

- Materials marked with the symbol  are recyclable.
- Check with your local Council or Environmental Health Office to see if there are facilities in your area for re-cycling this appliance.
- When the appliance is to be scrapped, cut off the power supply cable and make the door lock device unusable to prevent young children from being trapped inside.
- Help to keep your country tidy - use authorised disposal sites for your old appliance.

Important

Your machine is fitted with a balance control device, which ensures the machine is stable during the spin.

If the wash load appears not to have been spun sufficiently at the end of the wash cycle, because it is not evenly distributed in the drum, the balance control device may have operated. It will therefore be necessary to redistribute the wash load manually and select a spin programme. For more detailed information see the section headed “Something Not Working”.

Description of the Appliance

- 1 Detergent dispenser drawer
- 2 Control panel
- 3 Door locked light
- 4 Door opening handle
- 5 Drain pump
- 6 Adjustable feet

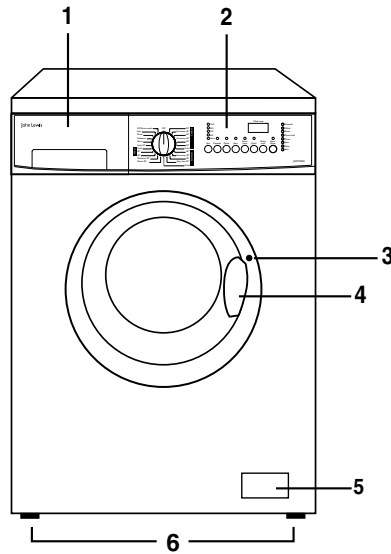



Door locked light

It stays on during the whole programme indicating that the door is locked.

When the light goes out, the door can be opened.

Detergent dispenser drawer

-  Prewash
-  Main wash
-  Fabric softener

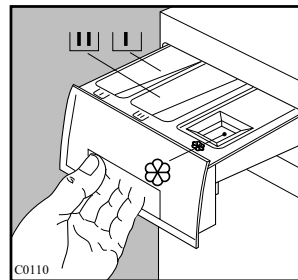

Child safety feature

This machine incorporates a special child safety feature to prevent small children from being trapped inside the machine.

To activate this device, rotate the button (without pressing it) inside the door clockwise until the groove is horizontal. If necessary use a coin.

To disable this device and restore the possibility of closing the door, rotate the button anti-clockwise until the groove is vertical.

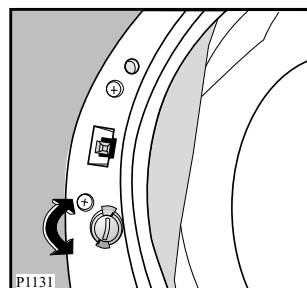

The Control Panel

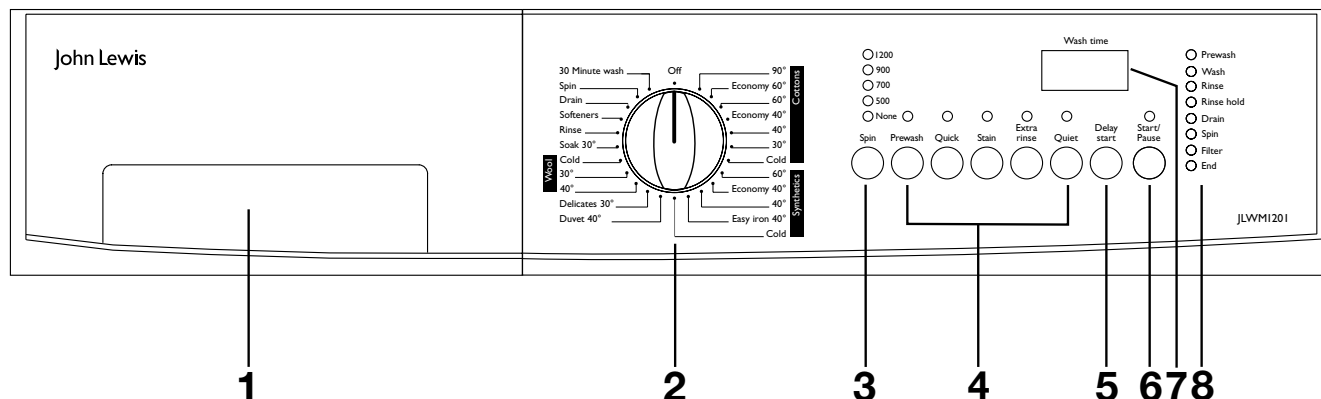

1 Detergent dispenser drawer

2 Programme selector dial

The programme selector dial is divided into following sections:

- Cottons,
- Synthetics,
- Delicates
- Wool  Hand washing
- Special programmes from “Soak 30°” to “30 Minute wash”
- Reset/Off programme **Off**

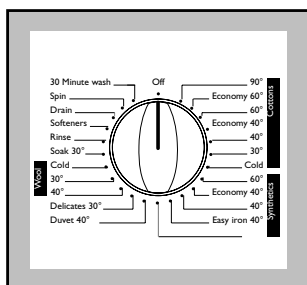

The selector dial can be turned either clockwise or anticlockwise.

Positions “**Economy**” correspond to an ENERGY SAVING programme and “**Cold**” to a cold wash.

At the end of the programme the selector dial must be turned to position “Off”.

3 “Spin” button

Press this button repeatedly to change the spin speed or to select position “None” (no spin), if you want your laundry to be spun at a speed different from the one proposed by the washing machine. The relevant light will light up.

Spin speed

The following speeds are available for the different fabrics:

- Cottons, linen:
500/700/900 max 1200 r.p.m. (for the model JLWM 1201) and 1400 r.p.m. (for the model JLWM 1402);
- Synthetics and wool:
500/700 max 900 r.p.m.;
- Duvet 40°/Delicates 30° and “30 Minute wash”:
500 max 700 r.p.m.

Position “None”

By selecting the option “None” the spinning phases are cancelled.

If you select this option with programmes for cotton and synthetics, the machine will perform some extra rinses.

4 “Option” buttons

Depending on the programme, different functions can be combined. These must be selected after choosing the desired programme and before depressing the “Start/Pause” button.

When these buttons are pressed, the corresponding pilot lights illuminate. When they are pressed again, the pilot lights go out.

If an incorrect option is selected, the pilot lights flash for about 2 seconds and the message Err is displayed. Press these buttons to select the following options:

- “**Prewash**”: select this option if you wish your laundry to be prewashed before the main wash (**not available for Wool, Duvet 40° and “30 Minute wash”**).
The prewash ends with a short spin at 650 rpm in programmes for cotton and synthetic fabrics, whereas in the programme for delicate fabrics the water is only drained. This option can be selected for heavily soiled laundry but not together with “**Stain**” option.

- **“Quick”**: select this option for laundry that is only slightly soiled in order to obtain a good washing result in a short time.
This option is **not** available with the Wool programmes, “Duvet 40°”, the Energy saving programmes **“Economy”** and **“30 Minute wash”**. The washing time will be reduced according to the type of fabric and the selected temperature.
- **“Stain”**: select this button if you wish to add to the washing of heavy soiled laundry a stain phase: at the temperature of 40°C the special detergent for stains is loaded from the compartment marked **U**.
This function is available in cotton and synthetic programmes with a temperature of 40° or higher.
The washing time will be prolonged by few minutes. The **“Prewash”** and the **“Stain”** options cannot be selected together.
- **“Extra rinse”**: this option can be selected with all programmes, except the wool programmes, “Duvet 40°” and **“30 Minute wash”**. The machine will add 2 rinses to the selected programme.
This option is recommended for people who are allergic to detergents, and areas where the water is very soft.
- **“Quiet”**: when you choose this option, the machine will not drain the water of the last rinse, so as not to crease the laundry.
As all spinning phases are cancelled, this washing cycle is very quiet and it can be useful at night or in hours with more economical power rate.
The machine will perform 3 additional rinses on cottons and 1 additional rinse on synthetics programmes.
At the end of the cycle, the light corresponding to the option **“Quiet”** and the **“Rinse hold”** pilot phase light are on, the **“Start/Pause”** button light goes out, the door locked light is on and the door cannot be opened to indicate that the water must be drained.
A blinking zero will appear on the display.
To empty out water there are 2 possibilities:
 - Select **“Drain”** programme :
the water is emptied out without spinning.
 - Select the **“Spin”** programme. Select the spin speed by means of the relevant button and then depress the **“Start/Pause”** button . The water is emptied out and the laundry is spun at the selected spin speed.

Attention!

Before selecting **“Drain”** programme, or **“Spin”** programme the selector dial has to be positioned on **“Off”**.

5 “Delay start” button

This button makes it possible to delay the starting of the programme from 30 min – 60 min – 90 min, 2 hours and then by 1 hour up to a maximum of 23 hours. The delay you have selected is shown on the display for about 3 seconds; afterwards, the duration of the programme reappears.

The Delay start cannot be selected with **“Soak 30°”**, **“Drain”** and **“Spin”** programmes.

Selecting the delayed start

You must select this option **after** you have set the programme and **before** you press the Start/Pause button.

The machine starts its countdown. The programme will start after the selected delay has expired.

Cancelling the delayed start

If you have already pressed the Start/Pause button, and you wish to **cancel** the delay time, proceed as follows:

- set the washing machine to Pause by pressing the Start/Pause button;
- press the **“Delay start”** button until the display shows the symbole **“D”**.
- press the **“Start/Pause”** button again.

Important!

The door will be locked throughout the delay time. If you need to open the door, you must first set the washing machine to Pause by pressing the Start/Pause button. After you have closed the door, press the Start/Pause button again.

6 “Start/Pause” button

This button has two functions:

- **Start**: after you have selected the desired programme and options, press this button to start the washing machine. The light above the button will stop flashing and remain lit.
If you have selected a delay time, the countdown will begin and will be shown on the display.
- **Pause**: when you press this button again, the programme in progress is interrupted. The light above the button will start flashing. To restart the programme from the point at which it was interrupted, press the button again.

When you PAUSE the cycle, and it becomes possible to open the door, provided:

- the washing machine is not in the heating phase;
- the level of the water is not high;
- the drum is not turning.

If all these requirements are met, the door locked light goes off.

Important! You must set the washing machine to Pause before you make any change in the programme in progress.

7 Display

The following pieces of information are shown on the display:

- **Duration of washing programme** in hours and minutes, after you have selected a programme.

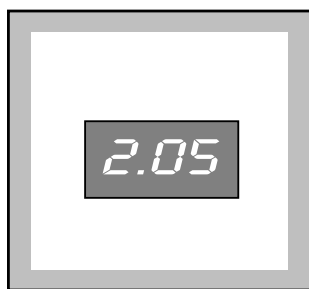

While the programme is running (after you have pressed the Start/Pause button), the displayed time value decreases by one unit every minute.

- **The washing machine has completed the programme:** this is indicated by a **flashing zero**.
- **The washing machine has stopped with water in the tub,** at the end of the "Soak 30" or a programme with the "Quiet" option: this is indicated by a **flashing zero**.

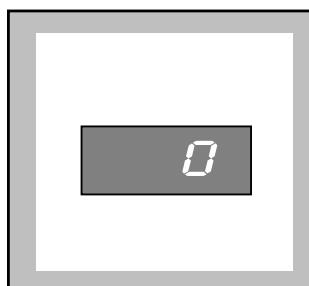

- **Delay start,** a time value indicated in hours and selected by means of the relevant button.

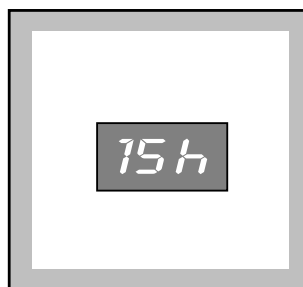

The delay time is displayed for 3 seconds, then the duration of the selected programme reappears. After you have pressed the Start/Pause button, the countdown begins, and the delay time value decreases by one unit every hour up to 2 hours and then by 30 minutes.

- **An incorrect option selection has been made:** this is indicated by the message **Err** when a function incompatible with the current programme is selected.

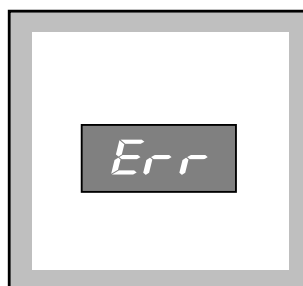

- **An alarm code** indicates a fault in the machine operation (see the relevant chapter).

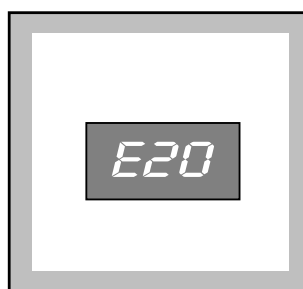

8 Programme phase indicator lights

When you select a programme, the lights relevant to the phases that form the programme light up.

After you have started the programme, only the light relevant to the phase that is currently being carried out will remain lit.

When the programme has finished, the “**End**” light comes on.

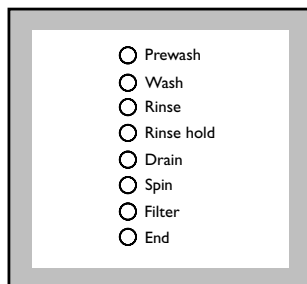

The “**End**” pilot light flashes in the event of operating problems. And the relative alarm code appears on the display.

E10 = the machine does not fill

E20 = the machine does not empty

E40 = the door has not been closed

To eliminate the problem, see paragraph “Something not working”.

ATTENTION!

If you turn the programme selector dial to another programme when the machine is working, all the lights of the programme progress display will flash for about 2 seconds but the washing machine will not perform the new selected programme.

Programme information

Soak 30°

This is a special programme for heavily soiled laundry. The machine performs a soak of about 30 minutes at 30°C. At the end of the soak time the machine will stop automatically **with water left in the tub**. The display will show a flashing zero.

Pour the detergent for the soak programme into the compartment marked []

Before starting a new washing phase, it is necessary to empty the water by selecting the “Drain” programme.

This function cannot be used with Wool programmes.

Rinse

With this programme it is possible to rinse and spin the garments which have been washed by hand. The machine performs 3 rinses, followed by a final long spin at the maximum speed.

The spin speed can be reduced by depressing the “**Spin**” button.

The final spin is foreseen only for cotton items as in the spin programme.

Softeners

Hand washed garments can be starched or softened with this programme.

The machine performs 1 rinse, followed by a final long spin at the maximum speed which can be reduced by depressing the “**Spin**” button.

The final spin is foreseen only for cotton items as in the spin programme.

Drain

For emptying out the water of the last rinse in programmes with the “**Quiet**” option or “Soak 30°” programme. Turn first the programme selector dial to “**Off**”, then select the “Drain” programme and depress the “**Start/Pause**” button.

Spin

Separate long spin at the max speed for hand washed garments. It has to be used for cotton items. You can reduce the speed by means of “**Spin**” button to adapt it to the fabrics to be spun.

30 Minute wash

This is a complete programme that can be combined with the following options:

“**Spin**” speed reduction, “**Quiet**” and “**Delay start**”.

To be used for laundry which is lightly soiled or which needs freshening up.

Max. load 2 kg.

Washing temperature 30 C.

Programme duration 30 minutes.

Final spin speed 700 rpm.

Off = Reset / Switching the machine off

To reset a programme turn the selector dial to “**Off**”. Now can a new programme be selected.

Operating Sequence

Before the first wash, we recommend that you pour 2 litres of water into the main wash compartment  of the detergent drawer in order to activate the ECO valve. Then run a cotton cycle at 60°C, without any laundry in the machine, to remove any manufacturing residue from the drum and tub.

Pour 1/2 a measure of detergent into the dispenser drawer and start the machine.

WASHING 6 KG OF WHITE COTTON AT 90°C

Suppose you have 6 kg of heavy soiled laundry to wash. It is white cotton and is suitable for high temperature washing.

1. Load the laundry

Open the door. Place the laundry in the drum, one item at a time, shaking them out as much as possible. Close the door.

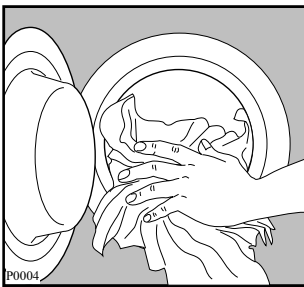

2. Measure out the detergent

Pull out the dispenser drawer until it stops. Measure out the amount of detergent required and pour it into the main wash compartment .

If you wish to carry out the prewash, a soak programme or a stain phase, pour detergent or stain remover into the appropriate compartment marked .

Important!

Do not use normal detergent for the “Stain” option, always use a STAIN remover.

3. Measure out the fabric softener

If required, pour fabric softener into the compartment marked , without exceeding the «MAX» mark.

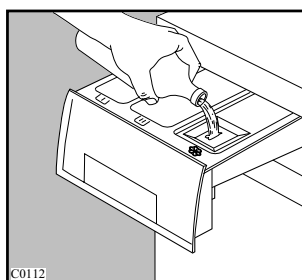
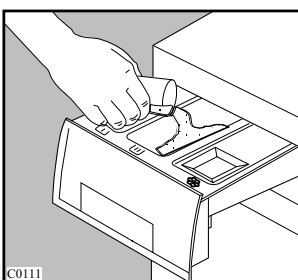

Close the drawer gently.

4. Switch the machine on

Turn the selector dial to the 90° programme to switch the machine on. To switch the appliance off turn it to “Off”.

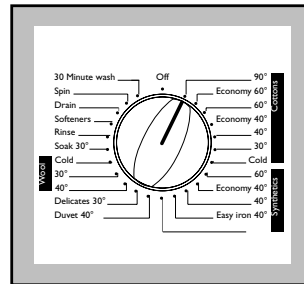

5. Select the desired programme/temperature

Turn the selector dial to the desired position. The lights relevant to the phases that form the programme will light up.

The display will show the duration of the selected programme, calculated on the basis of the maximum load for each type of fabric. The Start/Pause button light will start flashing.

If the load of laundry to be washed is small, at the beginning of the cycle the display will still indicate the duration relevant to the maximum load. The duration value will be gradually adjusted during the cycle.

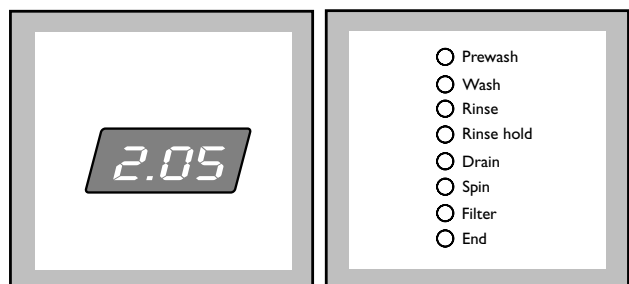

If your laundry needs a soak time, turn the programme selector dial to “Soak 30°” and then, before starting a washing cycle, drain the water as described in the “Soak 30°” paragraph.

6. Select the spin speed or the “None” option

Press the “**Spin**” button repeatedly button if order to select the desired spin speed or the “None” (no spin) option.

The relevant light will light up.

JLWM 1201

JLWM 1402

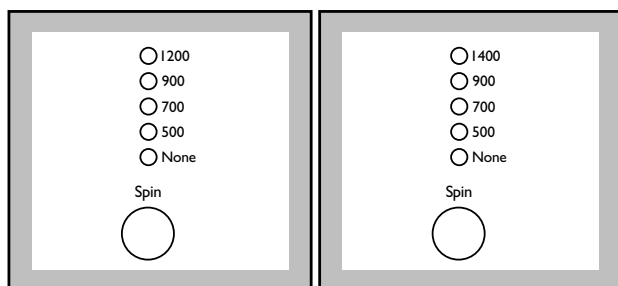

7. Select the desired options

If your laundry is very dirty, it may be advisable to select the “**Prewash**” option.

If your laundry is only slightly soiled, select the “**Quick**” option.

If your laundry has heavy stains and it is necessary to prolong the washing time, select the “**Stain**” option.

The special detergent for stains (Stain remover) is loaded from the compartment marked **U**.

If you wish the laundry to undergo an extra rinse, select the “**Extra Rinse**” option.

If your laundry should not be creased, select the “**Quiet**” option to leave the fabrics in the water of the last rinse.

The relevant light illuminates.

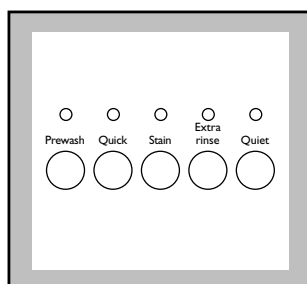

9. Select the “Delay start”

Before you start the programme, if you wish the start to be delayed, press the “Delay Start” button repeatedly, or keep it pressed, to select the desired delay. The selected delay time value (up to 23 hours) will appear on the display for 3 seconds, then the duration of the programme will appear again.

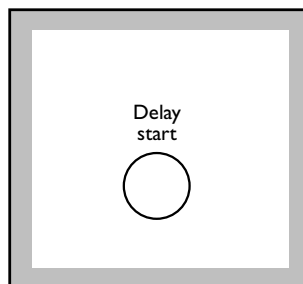

10. Start the programme

Press the “**Start/Pause**” button. The relevant light will stop flashing, and only the light relevant to the phase that is in progress will remain lit.

If you have chosen a delayed start, the washing machine will begin the countdown.

The display will show the duration of the programme or the selected delay.

11. How to change an option or a programme during its cycle

It is possible to change any option before the programme carries it out.

Before you make any change, you must pause the washing machine by pressing the “**Start/Pause**” button.

Changing a running programme is possible only by **resetting it**.

Turn the programme selector dial to “**Off**” and then to the new programme position. The washing water in the tub will not emptied out .

Start the new programme by depressing the “**Start/Pause**” button.

12. How to interrupt a programme

Depress the “**Start/Pause**” button to interrupt a programme which is running, the corresponding light starts to flash. Depress the button again to restart the programme.

13. How to open the door during the cycle of a programme

You can open the door, after having set the washing machine to Pause, provided the following conditions exist:

- the washing machine is not in the heating phase beyond 55°C;
- the level of the water is not high;
- the drum is not turning.

If these requirements are met, when you pause the washing machine, the door locked light goes off and the door can be opened.

Should it not be possible to open the door, and should it be absolutely necessary to do so, switch the machine off by turning the selector dial to “**Off**”.

After approximately 3 minutes, you can open the door.

Pay attention to the level and temperature of the water in the washing machine!

When you close the door to restart the programme turn the dial to the previous programme repeating the options previously selected and press START/PAUSE button.

14. End of programme

At the end of the programme, the washing machine stops automatically and displays a blinking zero.

If you had selected the “**Quiet**” option, the door locked light is on, the door is locked, the “**Start/Pause**” button light goes off, the “**Rinse Hold**” pilot light and the “**Quiet**” option light remain lit to indicate that the water must be drained.

The display shows a flashing zero. To drain or to spin see paragraph “**Quiet**” on page 7.

Turn the programme selector dial to Reset “**Off**” to switch the machine off.

Remove the laundry from the washing machine.

Check whether the drum is completely empty, by rotating it with your hand. The purpose of this is to prevent any items of laundry from remaining accidentally in the drum, where they might get damaged in a subsequent wash (e.g. by shrinking) or bleed colour into another load of laundry.

We advise you to close the water supply tap and disconnect the plug from the socket.

Leave the door ajar in order to air the washing machine.

Washing Hints

Do **NOT** overload the machine. Weigh the laundry the first few times you use the appliance.

The average weights of the most common items are listed below as a guide:

















1 000g = 1 kg

| | |
|----------------------|-------------|
| Sheet | 700-1000 g |
| Pillow case | 100-200 g |
| Tablecloth | 400-500 g |
| Serviette | 50-100 g |
| Tea towel | 70-120 g |
| Linen hand towel | 100-150 g |
| Towelling hand towel | 150-250 g |
| Towelling bath towel | 700-1000 g |
| Bath robe | 1000-1500 g |
| Man's shirt | 200-300 g |
| Apron | 150-200 g |

- Load the laundry loosely alternating large items with small ones.
- Sort the laundry according to the type of fabric, colour-fastness and how dirty it is.
- Avoid washing unhemmed or torn items as they may unravel.
- Before washing, empty all pockets of small objects which may have been left inside (coins, keys, screws etc). as these could damage the drain pump.
- When washing curtains, remove the hooks.
- Close poppers and zips and fasten loose buttons.
- It is essential to wash new coloured items separately when washing for the first time.
- When washing fabrics requiring different wash temperatures together, always select the lowest temperature.
- White items should not be washed with coloured items.
- Very small items (handkerchiefs, ribbons, socks etc) should be washed in a washing bag or a pillow case.
- Use a good quality detergent suitable for automatic washing machines.
- Use the correct quantities of detergent.
- For wool, use gentle detergent only in small quantities.
- Bleach is very corrosive; it should be used with care and kept out of reach of children.
- Some stains such as fruit, wine, grass, rust etc. are difficult to remove and should be treated before washing with specific products, which can be found in most household shops. In some cases it may help to soak the stain before washing with a special pre-soak product or biological detergent.
- Only wool marked "Pure New Wool - washable, preshrunk" can be washed in the the wool programme; other types of wool should be washed in Hand Wash programme..
- If you have used the machine to wash, rinse or spin only non-colour fast garments, there may be dye left in the sump. To ensure any subsequent wash is not contaminated with the dye, select and carry out a rinse and spin programme, without any garments, to ensure that any dye is removed from the sump.
- Once you have finished using the machine, you are advised to unplug it and turn off the water tap.

Wash Care Symbols

Wash care labels inside garments recommend how to launder your clothes with the best results. The care labelling code is in line with care labelling used in the rest of Europe. The symbols used make it easy to select the correct programme on your washing machine.

| WASHING SYMBOL | WASH ACTION | FABRIC |
|---|--|--|
|  | Normal (Maximum) | White Cotton or Linen without Special Finishes |
|  | Normal (Maximum) | Cotton, Linen or Viscose without Special Finishes Colourfast at 60°C. |
|  | Reduced (Medium) | Nylon, Polyester/Cotton, Viscose with Special Finishes, Cotton/Acrylic Mix. |
|  | Normal (Maximum) | Cotton, Linen or Viscose Colourfast at 40°C but not 60°C. |
|  | Reduced (Medium) | Acrylics, Acetate, Triacetate, Wool mixes, Polyester/wool blends. |
|  | Much Reduced (Minimum) | Wool, wool mixtures, Silks |
|  | Hand wash only | Do not machine wash |
| BLEACHING | | |
|  | Chlorine bleach may be used | |
| IRONING | | |
|  | Hot iron | Cotton, Linen, Viscose |
|  | Warm iron | Polyester mixtures, Wool |
|  | Cool iron | Acrylic, Nylon, Polyester |
| DRY CLEANING | | |
|  | May be dry cleaned. Other letters and/or a bar beneath the circle will indicate the required process to the dry cleaner. | |
| TUMBLE DRYING | | |
|  | with high heat setting | |
|  | with low heat setting | |
|  | May be tumble dried | |
|  | A cross through any symbol means «DO NOT» | |



Important Notes

For best results, always use the dispenser drawer for dispensing detergents and liquid additives. Once the dispenser has been filled, close it by pushing it in gently. This is particularly important if you are using

fabric conditioner to avoid the conditioner entering the machine prematurely.

When using liquid detergent and a prewash programme, place the detergent into the correct compartment in the dispenser drawer, after the prewash has finished.

Washing programmes

| Fabrics | Programme/ temperature | Type of laundry | Available options | Load | Consumptions* | | |
|---|---|---|--|------|---------------|-----------------|----------------|
| | | | | | Energy kWh | Water litres | Time h/min. |
| White cotton | 90° Cottons | Sheets, household linen, towels, tablecloths | Spin reduction/None Prewash Quick Stain Extra rinse Quiet | 6 Kg | 2.3 | 57 | 2.25 |
| White cotton | Economy 60° Cottons | Sheets, household linen, towels, tablecloths | Spin reduction/None Prewash Stain Extra rinse Quiet | 6 Kg | 1.02 | 49 | 2.17 |
| White and coloured cotton | 60° - 40° - 30° - Cold Cottons | Fast coloured and non-fast items, for example hand towels, sheets, underwear, tablecloths, shirts, blouses | Spin reduction/None Prewash Quick Stain** Extra rinse Quiet | 6 Kg | 1.3 | 54 | 2.00 |
| Coloured cotton | Economy 40° Cottons | Coloured items, for example underwear, shirts, blouses | Spin reduction/None Prewash Stain Extra rinse Quiet | 6 Kg | 1.14 | 54 | 2.20 |
| Synthetics | 60° - 40° - Cold Synthetics | Shirts, blouses, underwear, mixed fabrics | Spin reduction/None Prewash Quick Stain Extra rinse Quiet | 3 Kg | 0.95 | 55 | 1.29 |
| Synthetics | Economy 40° Synthetics | Shirts, blouses, underwear, mixed fabrics | Spin reduction/None Prewash Stain Extra rinse Quiet | 3 Kg | 0.5 | 55 | 1.30 |
| Synthetics | Easy iron 40° Synthetics | Shirts, blouses, underwear, mixed fabrics | Spin reduction/None Prewash Quick Stain Extra rinse Quiet | 3 Kg | 0.35 | 59 | 1.33 |
| Duvets | 40° Duvet | Acrylic, polyester items, duvets | | 2 Kg | 0.7 | 90 | 1.22 |
| Delicates | 30° Delicates | Acrylic, viscose, polyester items, curtains | Spin reduction/None Prewash Quick Extra rinse Quiet | 3 Kg | 0.37 | 57 | 56 |
|  Wool  | 40° - 30° - Cold Wool | Garments bearing the “ Pure new wool, non-shrink, machine washable” or “Hand wash” label | Spin reduction/None Quiet | 2 kg | 0.35 | 55 | 56 |

The “Cottons 60° economy” is the reference programme for the data entered in the energy label, in compliance with EEC 92/75 standards.

* This data is given purely as an indication: the consumption values may vary in relation to the quantity and type of laundry, the temperature of the water supply and the ambient temperature. The data refers to the highest temperature provided for each programme.

** Only at a temperature of 40°C or higher.

Washing programmes

| Programme | Programme description | Available options | Load | Consumptions* | | |
|--|--|---|------|---------------|--------------|-------------|
| | | | | Energy kWh | Water litres | Time h/min. |
| Soak 30° | Soak for 30 minutes at 30°C | | 6 Kg | 0.3 | 19 | 28 |
| Rinse | 3 rinses Long spin at max. speed | Spin reduction/None Extra rinse Quiet | 6 Kg | 0.06 | 59 | 45 |
| Softeners | 1 rinse with liquid additive Long spin at max. speed | Spin reduction/None Quiet | 3 Kg | - | 20 | 21 |
| Drain For emptying out the last rinse of the programmes with option “ Quiet ” and programme “ Soak 30° ” | Water draining | . | 6 Kg | - | - | 2 |
| Spin | Drain and long spin at max. speed** | Spin reduction | 6 Kg | - | - | 10 |
| 30 Minute wash Short cycle for lightly soiled fabrics | Wash at 30°C 2 rinses Short spin | Spin reduction/None Quiet | 2 Kg | 0.3 | 40 | 30 |
| Off / Reset | For cancelling the programme which is running or to switch the machine off | | - | - | - | - |

** You can reduce the spin speed by means of the relevant button to adapt it to the fabrics to be spun.

Maintenance and Cleaning

Before any maintenance or cleaning is carried out you must **DISCONNECT** the appliance from the electricity supply.

Descaling

The water we use normally contains lime. It is a good idea to periodically use a water softening powder in the machine. Do this separately from any laundry washing, and according to the softening powder manufacturer's instructions. This will help to prevent the formation of lime deposits.

After each wash

Leave the door open for a while. This helps to prevent mould and stagnant smells forming inside the appliance. Keeping the door open after a wash will also help to preserve the door seal.

Maintenance Wash

With the use of low temperature washes it is possible to get a build up of residues inside the drum. We recommend that a maintenance wash be performed on a regular basis.

To run a maintenance wash:

- The drum should be empty of laundry.
- Select the hottest cotton wash programme.
- Use a normal measure of detergent, must be a powder (such as Ariel Futur).

External cleaning

Clean the exterior cabinet of the appliance with soap and water only, and then dry thoroughly.

Cleaning the dispenser drawer

The washing powder and additive dispenser drawer should be cleaned regularly. Remove the drawer by pressing the catch downwards and by pulling it out. Flush it out under a tap, to remove any traces of accumulated powder. To aid cleaning, the top part of the additive compartment should be removed.

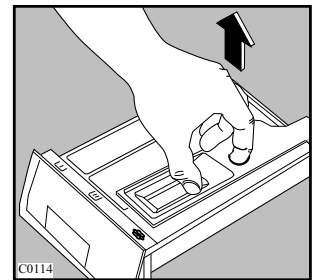
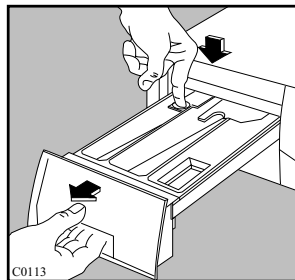

Cleaning the drawer recess

Having removed the drawer, use a small brush to clean the recess, ensuring that all washing powder residue is removed from the upper and lower part of the recess. Replace the drawer and run the rinse programme without any clothes in the drum.

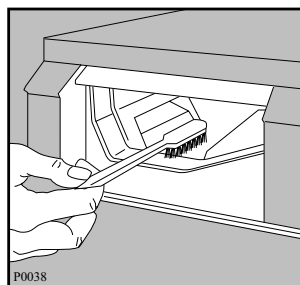

Cleaning the pump

The pump should be inspected if

- the machine does not empty and/or spin
- the machine makes an unusual noise during draining due to objects such as safety pins, coins etc. blocking the pump.

Proceed as follows:

- Disconnect the appliance.
- If necessary wait until the water has cooled down.
- Open the pump door.

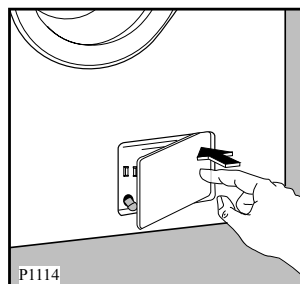

- Place a container close to the pump to collect any spillage.
- Pull out the emergency emptying hose, place it in the container and remove its cap.

- When no more water comes out, unscrew the pump cover and remove it. Always keep a rag nearby to dry up spillage of water when removing the cover.

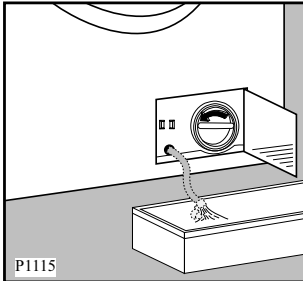

- Remove any objects from the pump impeller by rotating it.

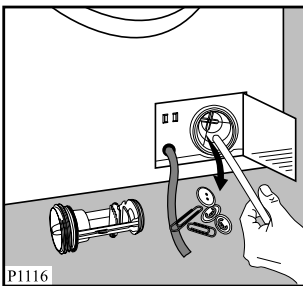

- Put the cap back on the emergency emptying hose and place the latter back in its seat.

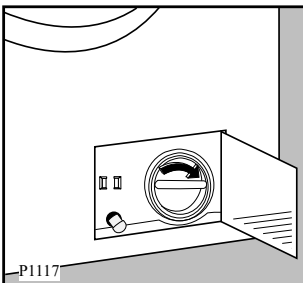

- Screw the pump cover fully in.
- Close the pump door.

Warning

When the appliance is in use and depending on the programme selected there can be hot water in the pump. Never remove the pump cover during a wash cycle, always wait until the appliance has finished the cycle, and is empty. When replacing the cover, ensure it is securely retightened so as to stop leaks and young children being able to remove it.

Cleaning the water inlet filter

If your water is very hard or contains traces of lime deposit, the water inlet filter may become clogged. It is therefore a good idea to clean it from time to time. Turn off the water tap. Unscrew the water inlet hose. Clean the filter using a hard bristle brush.

Tighten up the inlet hose.

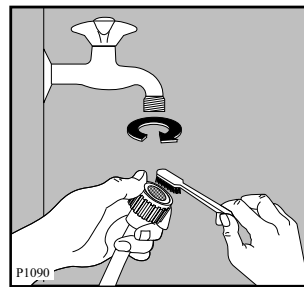

The dangers of freezing

If the machine is exposed to temperatures below 0°C, certain precautions should be taken.

- Turn off the water tap.
- Unscrew the inlet hose.
- Place the end of the emergency emptying hose and that of the inlet hose in a bowl placed on the floor and let water drain out.
- Screw the water inlet hose back on and reposition the emergency emptying hose after having put the cap on again.
- When you intend to start the machine up again, make sure that the room temperature is above 0°C.

Important!

Every time you drain the water through the emergency emptying hose you must pour 2 litres of water into the main wash compartment of the detergent drawer and then run the drain programme. This will activate the ECO valve avoiding that part of the detergent remains unused at next washing.

Emergency emptying out

If the water is not discharged, proceed as follows to empty out the machine:

- pull out the plug from the power socket;
- close the water tap;
- if necessary, wait until the water has cooled down;
- open the pump door;
- place a bowl on the floor and place the end of the emergency emptying hose into the bowl. Remove its cap. The water should drain by gravity into the bowl. When the bowl is full, put the cap back on the hose. Empty the bowl. Repeat the procedure until water stops flowing out;
- clean the pump if necessary as previously described;
- replace the emergency emptying hose in its seat after having plugged it;
- screw the pump cover again and close the door.

Something Not Working

Certain problems are due to lack of simple maintenance or oversights, which can be solved easily without calling out an engineer. Before contacting your local Service Force Centre, please carry out the checks listed below.

IMPORTANT: if you call out an engineer to a fault listed below, or to repair a fault caused by incorrect use or installation, a charge will be made even if the appliance is under guarantee.

During machine operation it is possible that the END light flashes and one of the following alarm codes appears on the display:

- **E10** : problem with the water supply
- **E20** : problem with water draining
- **E40** : door open

Once the problem has been eliminated, press the **“Start/Pause”** button to restart the programme. If after all checks, the problem persists, contact your local Service Force Centre.

| Symptom | Possible causes |
|--|---|
| The machine does not start | <ul style="list-style-type: none"> ● The door has not been closed. (E40) ● The plug is not properly inserted in the power socket. ● There is no supply at the socket. ● The main fuse or the fuse in the plug has blown. ● The “Start/Pause” button has not been depressed. ● The “Delay start” option has been selected. |
| The machine does not fill | <ul style="list-style-type: none"> ● The water tap is closed. (E10) ● The filter in the inlet hose is blocked. (E10) ● The inlet hose may be squashed or kinked. (E10) ● The door has not been closed. (E40) |
| The machine fills then empties immediately | <ul style="list-style-type: none"> ● The end of the drain hose is too low. ● The end of the drain hose is submerged in water. ● There is no vent in the end of the drain hose. |
| The machine does not empty and/or does not spin | <ul style="list-style-type: none"> ● The drain hose may be squashed or kinked. (E20) ● The “Quiet” option has been selected. ● The drain pump may be blocked. (E20) ● The “None” option has been selected ● The drainage system pipes are blocked. ● The programme “Soak 30”, which ends with water left in the tub, has been selected . |
| There is water on the floor | <ul style="list-style-type: none"> ● Too much detergent or unsuitable detergent has been used (creates too much foam). ● Check whether there are any leaks from the inlet hose fittings. It is not always easy to see this as the water runs down the hose; check to see if it is damp. ● The drain hose may be damaged or not securely positioned. ● The cap on the emergency emptying hose has not been replaced after cleaning the filter. |
| Unsatisfactory washing results | <ul style="list-style-type: none"> ● Too little detergent or unsuitable detergent has been used. An insufficient amount of detergent leaves the laundry looking grey and causes lime scale to form. ● Stubborn stains have not been treated prior to washing ● The correct wash programme/temperature has not been selected. ● Too much laundry has been placed in the drum. |

| Symptom | Possible causes |
|--|--|
| The machine vibrates when spinning | <ul style="list-style-type: none"> • The internal packing has not been removed. • The machine is in contact with the wall or furniture. • The machine is not level and stable (check diagonally). • The washing load is badly distributed in the drum. • Maybe there is very little laundry in the drum. |
| The door will not open | <ul style="list-style-type: none"> • The water level is above the bottom edge of the door. • The machine is heating the water. • The drum is turning. <p>In any case the door can be opened only when the door locked light has gone out.</p> |
| Spinning starts late or the machine does not spin | <ul style="list-style-type: none"> • The electronic balance control device has cut in because the laundry is not evenly distributed in the drum. The laundry is redistributed by reverse rotation of the drum. This may happen several times before the unbalance disappears and normal spinning can resume. If, after few minutes, the laundry is still not evenly distributed in the drum, the machine will not spin. In this case, redistribute the load manually and select the spin programme. |
| The machine makes an unusual noise | <ul style="list-style-type: none"> • The machine is fitted with a type of motor which makes an unusual noise compared with other traditional motors. This new motor ensures a softer start and more even distribution of the laundry in the drum when spinning, as well as increased stability of the machine. |
| No water is visible in the drum | <ul style="list-style-type: none"> • Machines based on modern technology operate very economically using very little water without affecting performance. |

Service & Spare Parts

In the event of your appliance requiring service, or if you wish to purchase spare parts, please contact our extended warranty administrators by telephoning:

0870 01 07887

They will give you details for your local Service Force Centre.

Before calling out an engineer, please ensure you have read the details under the heading "Something Not Working".



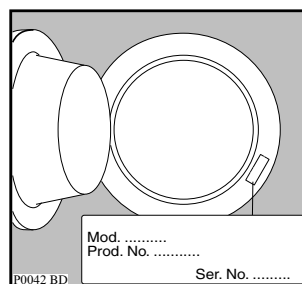

When you contact the Service Force Centre you will need to give the following details:

1. Your name, address and post code
2. Your telephone number
3. Clear and concise details of fault
4. The model and serial number of the appliance (found on the rating plate - see picture)
5. The purchase date.

Please note that a valid purchase receipt is required for in-guarantee service calls.



Installation Instructions

-  It is dangerous to alter the specifications or attempt to modify this product in any way.
-  Care must be taken to ensure that the appliance does not stand on the electrical supply cable.
-  Any electrical work required to install this appliance should be carried out by a qualified electrician or competent person.
-  Any plumbing work required to install this appliance should be carried out by a qualified plumber or competent person.

Technical Specifications

| | | |
|--|---|--|
| DIMENSIONS | Height Width Depth | 85 cm 60 cm 61 cm |
| POWER SUPPLY VOLTAGE TOTAL POWER ABSORBED | | 230-240 V/50 Hz 2050 W (10A) |
| WATER PRESSURE | Minimum Maximum | 0.05 MPa (0.5 bar) 0.8 MPa (8 bar) |
| MAXIMUM RECOMMENDED LOAD | Cotton, linen Synthetics Duvet/Delicate fabrics Wool/Hand wash | 6 kg 3 kg 3 kg 2 kg |
| SPIN SPEED | Maximum | 1200 rpm (JLWM 1201) 1400 rpm (JLWM 1402) |
| CONSUMPTION DATA FOR WASHING 6 KG NORMALLY SOILED COTTON ITEMS WITH PROGRAMME “ COTTONS ECONOMY 60° ”: | Energy Water | 1.02 kWh 49 litres |

-  This appliance complies with the following E.E.C. Directives:
- 73/23 EEC of 19.2.73 (Low Voltage Directive) and subsequent modifications;
 - 89/336 EEC of 3.5.89 (Electromagnetic Compatibility Directive) and subsequent modifications.

Unpacking

 All transit bolts and packing must be removed before using the appliance.

You are advised to keep all the packaging for re-use in case the machine is to be transported again.

Using a spanner unscrew and remove the two rear bottom screws. Slide out the two plastic pins.

Lay the machine gently on its back, making sure that the hoses are not squashed.

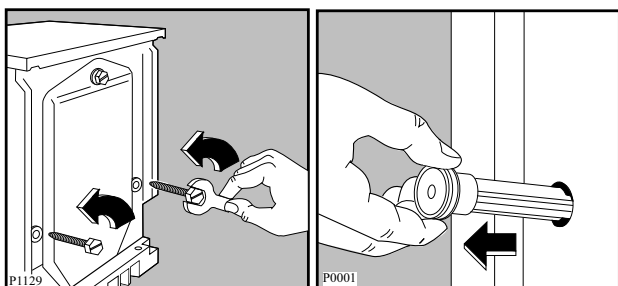

Remove the polystyrene block from the bottom of the machine and release the two plastic bags. Very carefully slide out the left polythene bag, removing it towards the right and then downwards.

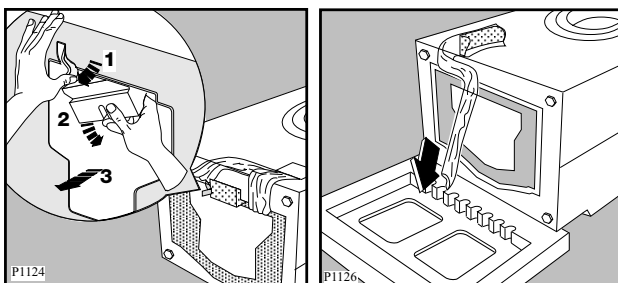

Repeat the operation for the right polythene bag, removing it towards the left and then upwards.

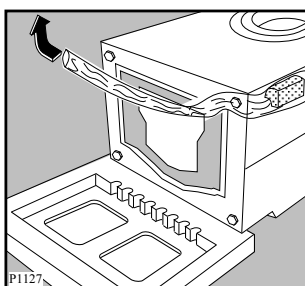

Remove the polystyrene base.

Set the machine upright and unscrew the remaining rear screw. Slide out the relevant pin.

Fill all the holes with the plastic plugs supplied with the instruction booklet.

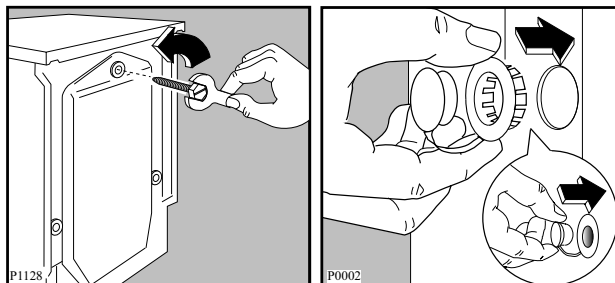

Positioning

Install the machine on a flat hard floor.

Make sure that air circulation around the machine is not impeded by carpets, rugs etc. Check that the machine does not touch the wall or other kitchen units.

Never place cardboard, wood or similar materials under the machine to compensate for any unevenness in the floor.

Your new washing machine has been designed to be permanently plumbed in to your home's water supply and drainage system. However, if this is not possible, it may be connected to a suitable existing tap with the drain hose discharging into a sink.

The appliance has an inlet hose, with female 3/4" BSP thread connector. If this connection is not compatible with the plumbing of the existing installation, a variety of connectors are available from good hardware stores and plumbers merchants to suit most domestic plumbing. Any alteration to your existing plumbing must be carried out by a competent person, or qualified plumber.

Installation on a Suspended Floor

Suspended wooden floors are particularly susceptible to vibration. To help prevent vibration we recommend you place a waterproof wood panel, at least 15 mm thick under the appliance, secured to at least 2 floor beams with screws. If possible install the appliance in one of the corners of the room, where the floor is more stable.

Water inlet

Connect the hose to a tap with a 3/4" thread. Always use the hose supplied with the appliance to connect to the water supply. Do not use previously used hoses for water connection.

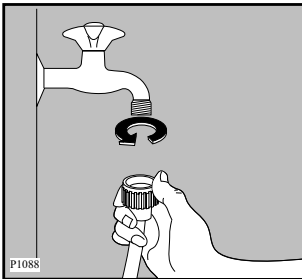

Installation should comply with local water authority and building regulations' requirements.

The appliance must be connected to a cold water supply.

A minimum water pressure of 50 kPa (0.5 bar) is required for safe operation of the appliance.

If you cannot make the cold water connection direct from the rising mains, you may be able to operate the appliance from your cold water storage system.

There should be a minimum distance of 5.02m (16.5 ft) between the appliance's inlet and the bottom of the water storage tank.

Set the hose correctly by loosening the ring nut. After positioning the inlet hose, be sure to tighten the ring nut again to prevent leaks.

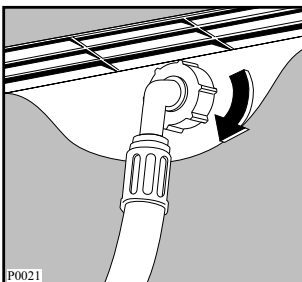

Water drainage

This appliance is designed to be permanently plumbed into your home's drainage system using one of the following methods.

I. Into a drainage standpipe.

Firstly form a hook in the end of the drain hose using the "U" piece" supplied.

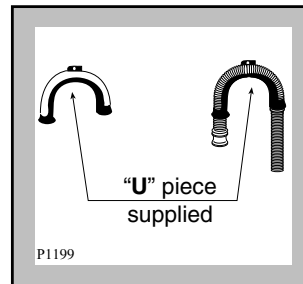

Place the drain hose into your standpipe, which should have an internal diameter of approximately 38mm thus ensuring there is an air break between the drain hose and standpipe.

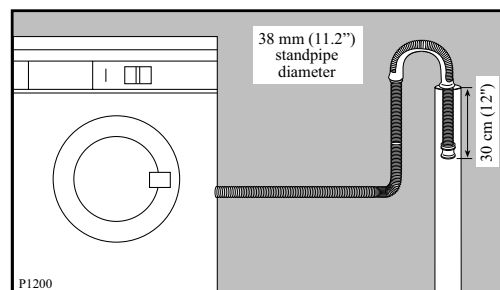

When discharging into a standpipe ensure that the top of the standpipe is no more than 90cm (35.4") and no less than 60cm (23.6") above floor level.

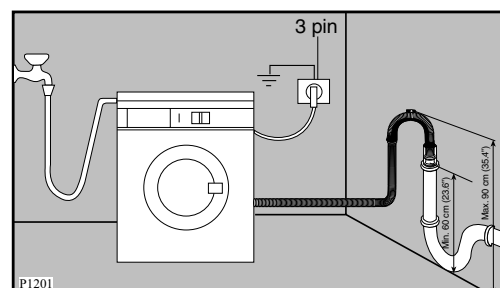

The drain hose may be extended to a maximum of 4 metres. An additional drain hose and joining piece is available from your local Service Force Centre. The joining piece must have an internal diameter of 18mm.

If your drain hose looks like this (see below) you do not require the "U" piece". Just push the hose firmly into the standpipe.

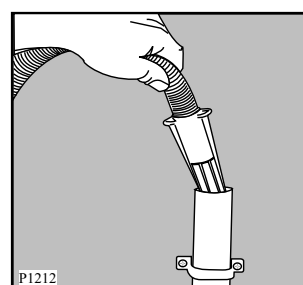

2. Onto a sink outlet spigot.

If the outlet spigot has not been used before, remove any blanking plug that may be in place.

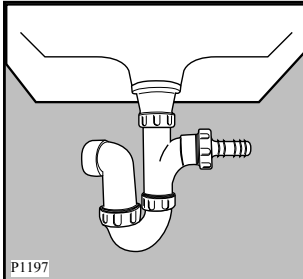

Push the drain hose onto the spigot and secure with a clip if required, ensure a loop is formed in the drain hose (see diagram) to prevent waste from the sink entering the washing machine.

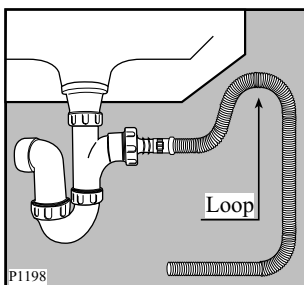

The drain hose may be extended to a maximum of 4 metres. An additional drain hose and joining piece is available from your local Service Force Centre. The joining piece must have an internal diameter of 18mm.

Important

- Before connecting the machine to new pipework or to pipework that has not been used for some time, run off a reasonable amount of water to flush out any debris that may have collected in the pipes.
- For a correct functioning of the machine the drain hose must be hooked on the proper support piece situated on the top of the back side of the appliance.

Levelling

Level the washing machine by raising or lowering the feet. The feet may be tight to adjust as they incorporate a self locking nut, but the machine **MUST** be level and stable (check diagonally).

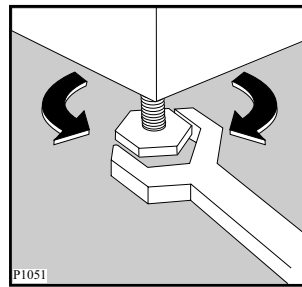

Any necessary adjustment can be made with a spanner. Accurate levelling prevents vibration, noise and displacement of the machine during operation.

Some vibration is inevitable, especially if mounted on a wooden floor.

Sprung wooden floors are particularly susceptible to vibration. For advice, consult a builder. If possible, always place the machine on a solid floor.

Special conditions

If the floor is carpeted or covered with crumbly or soft material, insert a rigid support base under the feet to prevent noise, vibration or displacement. The base should protrude a few centimetres beyond the edges of the machine.

Warning
 The machine should **NOT** be placed on deep pile carpeting.

Note

Please ensure that when the appliance is installed it is easily accessible for the engineer in the event of a breakdown.

In the interest of the environment

Washing machines and dishwashers should be connected to the FOUL drainage system, the water will then be taken to a sewage works for treatment before being discharged safely into a river.

It is essential that these appliances are not connected to the surface water drainage system as this water is discharged directly into a river or stream and may cause pollution.

If you require any further advice please contact your local water authority.

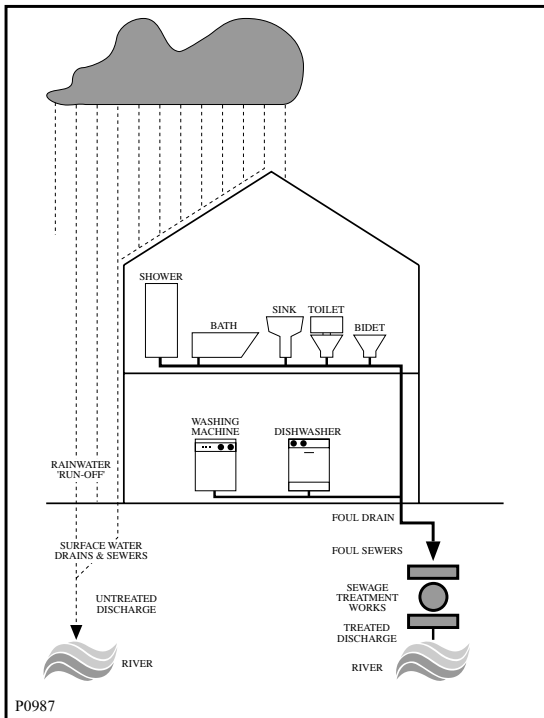

Electrical connection

Any electrical work required to install this appliance should be carried out by a qualified electrician or competent person.

WARNING: THIS APPLIANCE MUST BE EARTHED.

! The manufacturer declines any liability should this safety measure not be observed.

Before switching on, make sure the electricity supply voltage is the same as that indicated on the appliance's rating plate. The rating plate is located at the top of the rim of the open door.

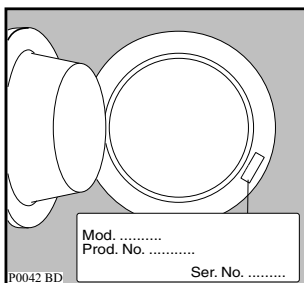

The appliance is supplied with a 13amp plug fitted. In the event of having to change the fuse in the plug supplied, a 13amp ASTA approved (BS1363/A) fuse must be used. Should the plug need to be replaced for any reason, proceed as described below.

The wires in the mains lead are coloured in accordance with the following code:

Green and Yellow - Earth
 Blue - Neutral
 Brown - Live

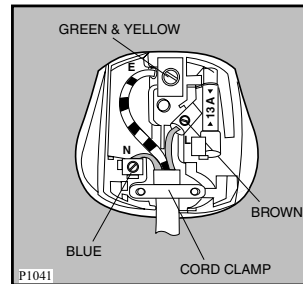

The wire coloured green and yellow must be connected to the terminal marked with the letter «E» or by the earth symbol \perp or coloured green and yellow.

The wire coloured blue must be connected to the terminal marked «N» or coloured black.

The wire coloured brown must be connected to the terminal marked «L» or coloured red.

Upon completion there must be no cut, or stray strands of wire present and the cord clamp must be secure over the outer sheath.

WARNING:

! A cut off plug inserted into a 13 amp socket is a serious safety (shock) hazard. Ensure that the cut off plug is disposed of safely.

The power supply cable must be easily accessible after installing the appliance.

Important

If the mains supply cable is damaged it must be replaced; contact our warranty administrators on 0870 0107887 who will give you details for your local Service Force Centre.

Permanent connection

In the case of permanent connection it is necessary that you install a double pole switch between the appliance and the electricity supply (mains), with a minimum gap of 3mm between the switch contacts and of a type suitable for the required load in compliance with the current electrical regulations.

The switch must not break the yellow and green earth cable at any point.

John Lewis partnership
171 Victoria Street
London SW1E 5NN
www.johnlewis.com

Free Manuals Download Website

<http://myh66.com>

<http://usermanuals.us>

<http://www.somanuals.com>

<http://www.4manuals.cc>

<http://www.manual-lib.com>

<http://www.404manual.com>

<http://www.luxmanual.com>

<http://aubethermostatmanual.com>

Golf course search by state

<http://golfingnear.com>

Email search by domain

<http://emailbydomain.com>

Auto manuals search

<http://auto.somanuals.com>

TV manuals search

<http://tv.somanuals.com>