



IMPRESSA F50/F5/F505

Instructions for use

IMPRESSA



Art. Nr. 66381

Legend:

- **DISPLAY** DISPLAY: serves as information.
- **DISPLAY** **DISPLAY**: please follow the instructions shown.

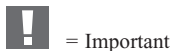

JURA Elektroapparate AG, CH-4626 Niederbuchsiten,
Internet <http://www.jura.com>

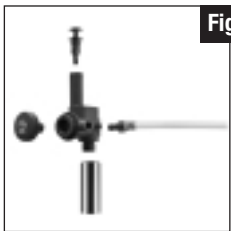
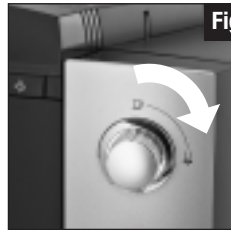
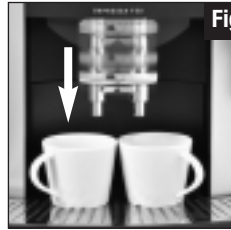

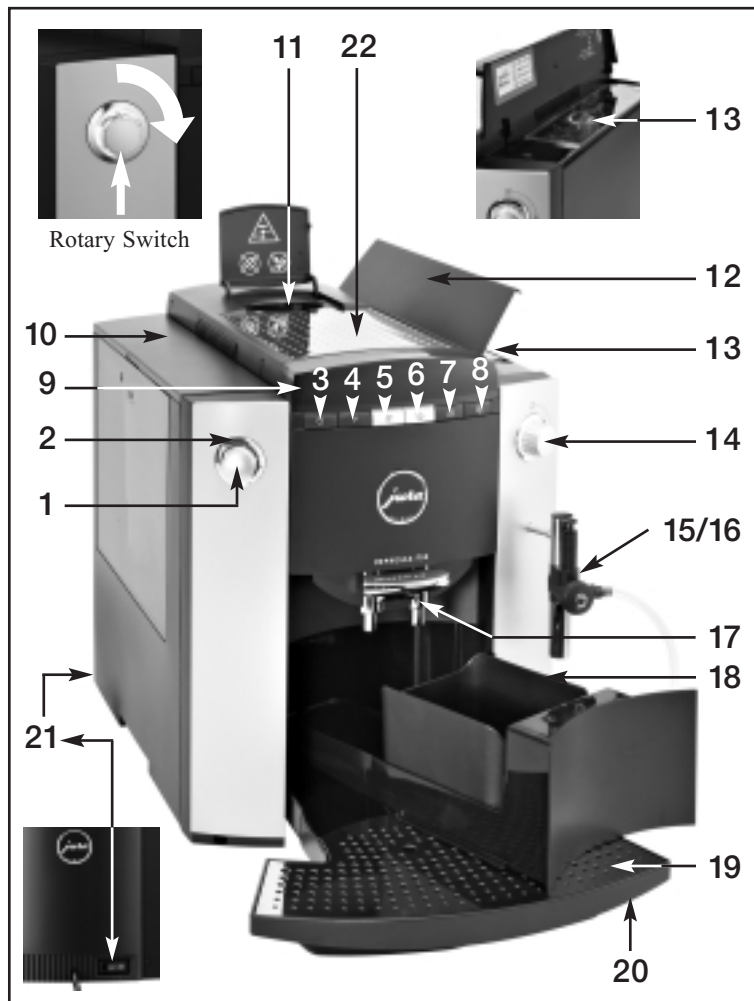

Control elements

1. Rotary Switch
2. Illuminated ring
3. ON/OFF key
4. Programming key
5. Draw-off key 1 cup
6. Draw-off key 2 cups
7. Maintenance key
8. Steam pre-selection key
9. Display dialog system
10. Water tank with carrying handle
11. Filler funnel for pre-ground coffee:
12. Bean tank cover
13. Aroma preservation cover
14. Steam/hot water draw-off valve
15. Easy-Auto-Cappuccino Frother with milk pipe
16. Interchangeable hot water nozzle (see Fig. 5)
17. Height-adjustable coffee spout
18. Coffee grounds container
19. Drip grate
20. Drip tray
21. Power Switch
22. Metal shelf

Contents

1. Safety information.....	page 6	15.1 Programming the filter.....	page 15
1.1 Warning.....	page 6	15.2 Programming the water hardness.....	page 15
1.2 Precautions.....	page 6	15.3 Programming the aroma ROBUST or STANDARD.....	page 15
2. Preparing the IMPRESSA.....	page 6	15.4 Programming the temperature.....	page 16
2.1 Check supply voltage.....	page 6	15.5 Programming the time.....	page 16
2.2 Check electrical fuse.....	page 6	15.6 Programming the automatic switch-on time.....	page 17
2.3 Fill water tank.....	page 7	15.7 Programming the automatic switch-off time.....	page 17
2.4 Fill coffee beans.....	page 7	15.8 Cup counter.....	page 18
2.5 Adjusting the grinding gear.....	page 7	15.9 Programming the language.....	page 18
2.6 Power switch.....	page 7	15.10 Programming Display 24H/AM/PM.....	page 18
3. First use.....	page 7	15.11 Programming the display for ML/OZ.....	page 19
4. Adjusting the water hardness.....	page 8	16. Maintenance.....	page 19
5. Installation of CLARIS plus filter cartridges.....	page 9	16.1 Filling in water.....	page 19
5.1 Installing the filter.....	page 9	16.2 Emptying the coffee grounds container.....	page 19
5.2 Replacing the filter.....	page 9	16.3 Drip tray missing.....	page 20
6. Rinsing the IMPRESSA.....	page 10	16.4 Fill coffee beans.....	page 20
7. Adjusting the water quantity for coffee.....	page 10	16.5 Replacing the filter.....	page 20
8. Drawing off 1 cup of coffee.....	page 10	16.6 Cleaning the IMPRESSA.....	page 20
9. Drawing off 2 cups of coffee.....	page 11	16.7 IMPRESSA decalcify.....	page 20
10. Drawing off pre-ground coffee.....	page 11	16.8 General cleaning instructions.....	page 20
11. Drawing off hot water.....	page 12	16.9 Emptying the system.....	page 21
12. Drawing off steam.....	page 12	17. Cleaning.....	page 21
13. Dispensing Cappuccino with the Easy-Auto-Cappuccino Frother.....	page 13	18. De-scaling.....	page 22
13.1 Cleaning the Easy-Auto-Cappuccino Frother.....	page 14	19. Disposal.....	page 23
13.2 Rinsing the Easy-Auto-Cappuccino Frother.....	page 14	20. Tips for perfect coffee.....	page 23
13.3 Cleaning the Easy-Auto-Cappuccino Frother.....	page 14	21. Messages.....	page 24
14. Switching off the IMPRESSA.....	page 15	22. Problems.....	page 25
15. Programming.....	page 15	23. Legal information.....	page 26
		24. Technical Data.....	page 26



Introduction

Thank you for purchasing the IMPRESSA. To ensure perfect functioning of your IMPRESSA, carefully read this operating manual and keep it for future reference.

Should you need more information or if you encounter particular problems not specified in these operating instructions in sufficient detail, either contact us directly or contact your local authorized dealer.



You will also find useful tips on operation and maintenance of your IMPRESSA on the website at www.jura.com. Don't forget to check out the Knowledge Builder our animated operating instructions. LEO, our assistant, will take you through all the functions.

1. Safety information

1.1 Warning

- Children do not realize the dangers involved in using electric appliances, for this reason always keep an eye on children when they use electric appliances.
- The coffee machine may only be used by instructed persons.
- Never use a defective coffee machine or a machine with a defective mains cable.
- Never repair or open the coffee machine yourself. Any repairs may only be carried out by authorized service shops using original spare parts and accessories.
- Never immerse the coffee machine in water.

1.2 Precautions

- Never expose the coffee machine to weather (rain, snow, frost), never touch the machine when your hands are wet.
- Place the IMPRESSA on a firm, level base that is resistant to any water that may leak. Never stand on hot or warm surfaces (oven hobs). Keep out of the reach of children.
- If you don't use the machine for a longer time (holidays, etc.) always disconnect the mains cable.
- Always disconnect mains cable before cleaning the machine.
- When disconnecting the mains cable never pull on the mains cable or the machine itself.
- The coffee machine is connected to mains supply via a mains cable. Make sure nobody can trip over the mains cable. Make sure children and pets cannot reach the machine
- Never put the coffee machine or individual parts of it into a dishwasher.
- Make sure to install the machine at a place with sufficient air circulation, to prevent overheating of the machine.

2. Preparing the IMPRESSA

2.1 Check supply voltage

The IMPRESSA is preset in the factory to the correct mains voltage. Check if your local mains supply voltage complies with the information given on the type plate on the underside of the IMPRESSA.

2.2 Check electrical fuse

The IMPRESSA is designed for an electric current of 10 amperes. Check if the electrical fuse has sufficient capacity.

2.3 Fill water tank



Only use fresh, cold water. Never fill in milk, mineral water or other liquids.

- Remove the water tank and rinse it with cold tap water thoroughly (Fig. 4).
- Then fill the water tank and reinstall it. Make sure to install the tank properly, it must engage audibly.

2.4 Fill coffee beans



To ensure that your machine will work perfectly for a long time and to avoid damage, please note that the grinding gear of your JURA coffee machine is not suitable for coffee beans which were treated, during or after roasting, with additives (e.g. sugar). Such coffee blends may damage the grinding gear. Any repair costs resulting from the use of such blends are not covered by warranty.

- Open the bean tank cover (12) and remove the aroma preservation cover (13).
- Remove any dirt or foreign matter from the bean tank.
- Fill coffee beans in the bean tank and close the cover.

2.5 Adjusting the grinding gear

You can adjust the grinding gear to the roast of your coffee. We recommend

- a fine grinding degree → for bright roasts (the smaller the dots, the finer the grinding)
- a coarse degree → for dark roasts (the larger the dots, the coarser the grinding)



The grinding degree may only be adjusted while the grinding gear is running.

- Open the bean tank cover (12) and remove the aroma preservation cover (13).
- To adjust the grinding degree, turn the Rotary Switch (Fig. 2) to the required position.

2.6 Power switch



Actuate the power switch (21) on your IMPRESSA before using the machine for the first time.



We recommend that you switch off your IMPRESSA with the power switch (21) if you intend not to use the machine for longer periods of time (e.g. during holidays)

3. First use

- Fill coffee beans in the bean tank (12).
- Switch on the IMPRESSA using the ON/OFF key \odot (3).
- **DISPLAY** SPRACHE
DEUTSCH
- The illuminated ring (2) is active.
- Turn the Rotary Switch (1) until the required language is displayed.
- For example **DISPLAY** LANGUAGE
ENGLISH
- Confirm your selection by pressing the Rotary Switch (1).
- **DISPLAY** FILL
WATER
- Fill the water tank (10) with fresh water.
- **DISPLAY** OPEN TAP
- Place a receptacle under Easy-Auto-Cappuccino Frother (15) (Fig. 10).
- Open the steam / hot water draw-off tap (14) (Fig. 13).

- **DISPLAY** FILLING SYSTEM
- **DISPLAY** CLOSE TAP
- Close the steam / hot water draw-off tap (14).
- **DISPLAY** HEATING
- **DISPLAY** PRESS RINSE
- Press the maintenance key  (7).
- Machine carries out a rinsing operation.
- **DISPLAY** RINSING
- **DISPLAY** READY



If BEANS FILL is displayed, press the coffee draw-off key again. Machine not filled with coffee beans yet.



To get an excellent crema, adjust the coffee spout (17) to the size of your cup (Fig. 3).

4. Adjusting the water hardness



Water is heated in the IMPRESSA. As a result, calcification occurs during normal use and is indicated automatically. Before using the IMPRESSA for the first time the hardness of the water used must be adjusted. Use the supplied test sticks for this.



1° German hardness is equivalent to 1.79° French hardness.



If the filter is activated, the program step Water Hardness no longer appears.





The IMPRESSA has 5 hardness degrees which can be used and are displayed while you are adjusting the water hardness.

The displayed information means the following:

- LEVEL — Water hardness function switched off
- LEVEL 1 German water hardness degree 1 to 7°
French Water hardness degree 1.79 – 12.53°
- LEVEL 2 German water hardness degree 8 to 15°
French Water hardness degree 14.32 – 26.85°
- LEVEL 3 German water hardness degree 16 to 23°
French Water hardness degree 28.64 – 41.14°
- LEVEL 4 German water hardness degree 24 to 30°
French Water hardness degree 42.96 – 53.7°

When the IMPRESSA leaves the factory it is adjusted to LEVEL 3. You can adjust another hardness. To do this, proceed as follows:

- **DISPLAY** READY
- Press the programming key  (4), illuminated ring (2) is active.
- **DISPLAY** FILTER
- Turn the Rotary Switch (1) until the following message is displayed:
- **DISPLAY** HARDNESS
- Now press the Rotary Switch (1) to start the programming.
- **DISPLAY** LEVEL 3
- Turn the Rotary Switch (1) until the required level is displayed.
- For example, **DISPLAY** LEVEL 4
- Press the Rotary Switch (1) to confirm the required level.
- **DISPLAY** HARDNESS
- Press the programming key  (4) to quit the programming mode.
- **DISPLAY** READY

5. Installation of CLARIS plus filter cartridges

➔ If the CLARIS plus filter cartridge is installed properly, descaling of the coffee machine is no longer required. For more information on the CLARIS plus filter cartridge refer to brochure «CLARIS plus. Hard on limescale. Gentle on your coffee machine.»

5.1 Installing the filter

- Fold up the cartridge holder. Install the filter cartridge in the water tank, applying a gentle pressure (Fig. 1).
- Fold down the cartridge holder again until it engages audibly.
- Fill the water tank with cold, fresh tap water and install it again.
- Press the programming key **[P]** (4), the illuminated ring (2) is active.
 - **DISPLAY** FILTER
- Press the Rotary Switch (1) to start the programming.
 - **DISPLAY** NO –
- Turn the Rotary Switch (1) until the following message is displayed:
 - **DISPLAY** YES ✓
- Press the Rotary Switch (1) to activate the filter cartridge.
 - **DISPLAY** INSERT
OPEN TAP
- Put a sufficiently large container (at least 0.5 litre) under the Easy-Auto-Cappuccino Frother (15) (Fig. 10).
- If not installed already, insert the CLARIS plus filter.
- Open the steam / hot water draw-off tap (14) (Fig.13).
 - **DISPLAY** RINSING
FILTER
 - **DISPLAY** CLOSE TAP

- Close the steam/hot water draw-off tap (14), now the IMPRESSA will heat up to coffee temperature.

- **DISPLAY** HEATING
- **DISPLAY** READY

➔ Now you have activated the filter. In Programming Mode the water hardness selection function is no longer displayed.

5.2 Replacing the filter

➔ After drawing off approx. 50 litres, the filter cartridge will be used up. A message requesting you to replace the filter will appear on the display. Please monitor the period of use of the CLARIS plus filter cartridge (max. 2 months) using the scale on the cartridge holder by the water tank.

- **DISPLAY** READY/FILTER
- Switch off the IMPRESSA using the ON/OFF key **[⏻]** (3).
- Press the maintenance key **[⚙️]** (7) until the following message is displayed:
 - **DISPLAY** CHG FILTER
OPEN TAP
- Remove the water tank from the machine and empty it.
- Fold up the cartridge holder. Install the filter cartridge in the water tank, applying a gentle pressure (Fig. 1).
- Fold down the cartridge holder again until it engages audibly.
- Fill the water tank with cold, fresh tap water and reinstall it.
- Place a sufficiently large jug (approx 1 litre) under the Easy-Auto-Cappuccino Frother (15) (Fig. 10) and open the steam/hot water tap (14).
 - **DISPLAY** RINSING
FILTER
 - **DISPLAY** CLOSE TAP

- Open the steam / hot water draw-off tap (14).
- **DISPLAY** HEATING
- **DISPLAY** READY

6. Rinsing the IMPRESSA



When the IMPRESSA is switched off and has cooled down, a rinsing operation is started when the machine is switched on again. When the machine is switched off, a rinsing operation is started automatically.

- Switch on the IMPRESSA using the ON/OFF key (3).
- **DISPLAY** HEATING
- **DISPLAY** PRESS
RINSE
- Press the maintenance key (7).
- **DISPLAY** RINSING
- **DISPLAY** READY

7. Adjusting the water quantity for coffee



The indicated value in ML is a reference value and may deviate from the actual value



If you press the draw-off key for 2 cups (6) the water quantity is doubled automatically.



You can change/stop the water quantity during the draw-off operation, too. Turn the Rotary Switch (1) until the required ML value is displayed.

You can adjust the water quantity in steps of 5 ML using the Rotary Switch (1).

- **DISPLAY** READY

- Turn the Rotary Switch (1) until the required water quantity is displayed.
- For example, **DISPLAY** 120 ML

8. Drawing off 1 cup of coffee



You have the possibility of increasing the strength of the coffee at any time in the grinding process by pressing the 1-cup draw-off key again
For Example: by pressing the 1-cup draw-off key three times you get strong coffee.
DISPLAY STRONG



You can choose among three strengths at the push of a button. The longer you press the draw-off key for 1 cup (5), the stronger your coffee will be (Display: MILD/ NORMAL/ STRONG).



You can adjust the water quantity before the draw-off operation using the Rotary Switch (1).



You can stop the draw-off operation at any time by pressing any coffee draw-off key.



You can check the water quantity used for the last draw-off operation by pressing the Rotary Switch (1).

- **DISPLAY** READY
- Put a cup under the adjustable coffee spout (17).
- Press the draw-off key for 1 cup (5) until the required strength is displayed:
- **DISPLAY** MILD
- **DISPLAY** 180 ML (water quantity last adjusted)
- The illuminated ring (2) is active.
- Turn the Rotary Switch (1) again to select the water quantity individually:



- For Example: **DISPLAY** 160 ML
- For Example: **DISPLAY** MILD
- Your product is being prepared.
- **DISPLAY** READY

9. Drawing off 2 cups of coffee

- ➔ Selecting the coffee strength is not possible when drawing off 2 cups of coffee. You will draw off 2 mild cups automatically.
- ➔ You can adjust the water quantity before the draw-off operation using the Rotary Switch (1). The adjusted value (ML) refers to 1 cup.
- ➔ You can stop the draw-off operation at any time by pressing any coffee draw-off key.
- 💡 You can check the water quantity used for the last draw-off operation by pressing the Rotary Switch (1).

- **DISPLAY** READY
- Put 2 cups under the adjustable coffee spout (17).
- Press the draw-off key for 2 cups  (6).
- **DISPLAY** 2 CUPS
- **DISPLAY** 120 ML (water quantity last adjusted)
- The illuminated ring (2) is active.
- Turn the Rotary Switch (1) again to select the water quantity individually:
 - For Example: **DISPLAY** 210 ML
 - **DISPLAY** 2 CUPS
 - Your product is being prepared.
 - **DISPLAY** READY

10. Drawing off pre-ground coffee

- ➔ Never use instant coffee or quick-coffee. We recommend that you always use powder from fresh coffee beans or, pre-ground, vacuum-packed coffee. Never fill in more than 2 portions of powder. The pre-ground coffee tank is no storage tank. Make sure that the pre-ground you use is not too fine. This may cause blocking of the system. In this case the coffee only drips out of the coffee spout.
- ➔ If you have filled in too little powder, the message ADD MORE POWDER will be displayed. The IMPRESSA stops the operation and returns to "ready for draw off" mode.
- ➔ You can stop the draw-off operation at any time by pressing any coffee draw-off key.
- **DISPLAY** READY
- Put 1 or 2 cups under the adjustable coffee spout (17).
- Open the cover of the filler funnel for pre-ground coffee (11).
- **DISPLAY** FILL POWDER
- Fill 1 or 2 level spoonfuls of pre-ground coffee in the filler funnel for pre-ground coffee (11) (Fig. 11) and close the cover.
- **DISPLAY** POWDER
- **DISPLAY** SELECT CUP BUTTON
- Press the required draw-off key for 1 cup  (5) or 2 cups  (6)
- **DISPLAY** 120 ML (water quantity last adjusted)
- The illuminated ring (2) is active.
- **DISPLAY** POWDER
- Turn the Rotary Switch (1) again to select the water quantity individually:

- For Example: **DISPLAY** 210 ML
- **DISPLAY** POWDER
- Your product is being prepared.
- **DISPLAY** READY

11. Drawing off hot water

 If you do not change the settings using the Rotary Switch (1), the water quantity last adjusted will be drawn off automatically.

 Install the hot water nozzle (see Fig. 5) to obtain perfect water flow. Do not replace the replaceable hot water nozzle (16) directly after drawing off water, because the nozzle is hot after the draw-off operation.

 At the start of the water draw-off operation there can be splashing. Avoid direct contact with the skin!

- **DISPLAY** READY
- Place a cup under the replaceable hot water nozzle (16).
- Open the steam / hot water draw-off tap (14) (Fig. 13).
- The illuminated ring (2) is active.
- For example, **DISPLAY** 140 ML
- **DISPLAY** WATER
- Adjust the required water quantity by turning the Rotary Switch (1).
- For example, **DISPLAY** 200 ML
- **DISPLAY** WATER
- If the required water quantity is reached, the following message is displayed:
- **DISPLAY** CLOSE TAP

- Close the steam / hot water draw-off tap (14).
- **DISPLAY** READY

 Before CLOSE TAP water may still escape the system.

12. Drawing off steam

 The steam function is used for the preparation of milk foam as well as for the Easy-Auto-Cappuccino Frother (15) cleaning programme.

 With the optionally available 2-stage frothing nozzle, liquids can be heated and frothed using the steam function.

 Make sure that the nozzle is correctly fitted when drawing steam. If the nozzle becomes blocked with particles of milk residue or is incorrectly assembled, a danger can arise during use whereby the nozzle may jump off.

 Due to the system design, some water will escape at first when steam is drawn. However, this will not affect the result in any way.

 When drawing steam, spluttering can occur at the start. The nozzle becomes hot in use. Avoid any direct skin contact.

- **DISPLAY** READY
- Press the steam pre-selection key  (8).
- **DISPLAY** HEATING
- **DISPLAY** STEAM
READY
- To draw off steam, open the steam/hot water draw-off tap (14) (Fig. 13).
- The illuminated ring (2) is active.

- You can adjust the steam draw-off time individually by turning the Rotary Switch (1) until the required SEC are displayed.
- For example, **DISPLAY** 35 SEC
- If you do not change the steam draw-off time settings using the Rotary Switch (1), the machine will use the settings last adjusted
- During the steam draw-off operation, the message STEAM is displayed
- When the steam quantity is reached, the message CLOSE TAP is displayed
- Close the steam / hot water draw-off tap (14).
- **DISPLAY** STEAM
READY

 As long as STEAM READY is on view in the display, the machine is ready to dispense steam.

 Before CLOSE TAP, steam may still escape the system.

13. Dispensing Cappuccino with the Easy-Auto-Cappuccino Frother

 Cappuccino comprises of one third each of Espresso, hot milk and milk foam. You produce the milk portion with the Easy-Auto-Cappuccino Frother (15).
When steam is drawn, a vacuum is produced which, with the aid of the Easy-Auto-Cappuccino Frother (15), draws in the milk and produces milk foam.

 To ensure perfect function, the Easy-Auto-Cappuccino Frother (15) must be cleaned regularly.

 Make sure that the nozzle is correctly fitted. If the nozzle becomes blocked with particles of milk residue or is incorrectly assembled, a danger can arise during use whereby the nozzle may jump off.

- When using for the first time, remove the protective cover from the Easy-Auto-Cappuccino Frother (15) (Fig. 6). The protective cover is used only during transport as protection to prevent the ingress of contaminated materials.
- Remove the milk pipe from the Welcome Pack and connect it to the Easy-Auto-Cappuccino Frother (15).
- Insert the other end of the milk pipe into a Tetra Pak of milk or connect it to a milk container (Fig. 7).
- Place a cup under the Easy-Auto-Cappuccino Frother (15) (Fig. 7).

 A useful addition is available for all lovers of milk specialties in the form of high-quality vacuum milk containers. They keep the milk cool the whole day long and are optimally suited to the design of your IMPRESSA.
All original JURA accessories can be obtained from the specialist shop.

- Press the steam pre-selection key  (8).

■ **DISPLAY** HEATING

■ **DISPLAY** STEAM
READY

- To draw off steam open the steam/hot water draw-off tap (14) (Fig. 13). The milkfoam is prepared.
- The illuminated ring (2) is active.
- You can adjust the steam draw-off time individually by turning the Rotary Switch (1) until the required SEC are displayed.
- For example, **DISPLAY** 35 SEC
- If you do not change the steam draw-off time settings using the Rotary Switch (1), the machine will use the settings last adjusted

 Adjust the steam dispensing time to suit the size of your cup.

- During the steam draw-off operation, the message STEAM is displayed.
- When the steam quantity is reached, the message CLOSE TAP is displayed.
- Close the steam / hot water draw-off tap (14).
- **DISPLAY** STEAM
READY

 At any time, you can stop dispensing steam at an earlier stage by closing the tap for dispensing steam/hot water (14).

 As long as STEAM READY is on view in the display, the machine is ready to dispense steam.

 Due to the system design, steam can still escape and some milk may continue to drip before the TAP is closed.

- Now, move your cup with the milk foam and place it under the coffee spout and dispense the required coffee product. (Fig. 8)
Your Cappuccino is ready.

13.1 Cleaning the Easy-Auto-Cappuccino Frother

 To ensure that the Easy-Auto-Cappuccino Frother functions perfectly, you should rinse it with water each time after preparing milk.

 You will not be prompted by your IMPRESSA to rinse the Easy-Auto-Cappuccino Frother.

13.2 Rinsing the Easy-Auto-Cappuccino Frother

- Carefully pull off the Easy-Auto-Cappuccino Frother.
- Dismantle the Easy-Auto-Cappuccino Frother (15) into its individual parts (Fig. 16)
- Thoroughly rinse all parts of the nozzle under running water.

- Reassemble the Easy-Auto-Cappuccino Frother (15) and refit it on to your IMPRESSA.

13.3 Cleaning the Easy-Auto-Cappuccino Frother

 To ensure that the Easy-Auto-Cappuccino Frother(15) functions perfectly, you should clean it daily if you have prepared milk foam.

 You will not be prompted by your IMPRESSA to clean the Easy-Auto-Cappuccino Frother (15).

 You can obtain the JURA Auto-Cappuccino Cleaner from the specialist shop.

- Place a container under the Easy-Auto-Cappuccino Frother (15). (Fig. 9)

- Fill a second container with 2.5 dl of fresh water and add one capful of the Auto-Cappuccino Cleaner.

- Dip the milk pipe into the second container with the Auto-Cappuccino Cleaner. (Fig. 9)

- Press the steam pre-selection key  (8).

- **DISPLAY** HEATING

- **DISPLAY** STEAM
READY

- To draw off steam open the steam / hot water draw-off tap (14) (Fig 13).



- Draw steam until the container with the Auto-Cappuccino Cleaner is empty.
This procedure cleans the Easy-Auto-Cappuccino Frother and the milk pipe.

- Close the steam / hot water draw-off tap (14).

- **DISPLAY** STEAM
READY



 As long as STEAM READY is on view in the display, the machine is ready to dispense steam.

- Fill the container with 2.5 dl of fresh water.
Dip the milk pipe into the container with the fresh water.

 When READY appears in the display, press the steam preselect key  (8) again to set the machine in readiness for the steam function.

- Open the tap for dispensing steam/hot water (14) (Fig. 13) in order to draw steam.
- Draw steam until the container with the fresh water is empty.
This procedure rinses the Easy-Auto-Cappuccino Frother (15) and the milk pipe with fresh water.
- Cleaning of the Easy-Auto-Cappuccino Frother (15) is now complete, your IMPRESSA is ready for use.

14. Switching off the IMPRESSA

 To ensure perfect operation, please switch your IMPRESSA to standby mode with the  (3) symbol first. Then switch the machine off with the power switch (21).



- **DISPLAY** READY
- Switch off the IMPRESSA using the ON/OFF key  (3).
- **DISPLAY** RINSING
- An automatic rinsing operation is started.

15. Programming

 When your IMPRESSA leaves the factory it is adjusted such that you can draw off coffee without having to change any settings. However, you can programme various parameters individually.

You can programme the following stages:

- Filter
- Water hardness
- Aroma
- Temperature
- Time
- Automatic switch-on time
- Automatic switch-off time
- Draw-offs
- Language
- Display

 **Programming key**  (4)
Use the programming key  (4) to open or quit the programming mode (no saving of values effected).

 **Rotary switch**
Turn the Rotary Switch to change the adjusted values or to select the next programming step.
Press the Rotary Switch to check the values adjusted or to save the values selected

15.1 Programming the filter

Refer to Chapter 5.1 «Inserting the filter».

15.2 Programming the water hardness

Refer to Chapter 4 «Adjusting the water hardness».

15.3 Programming the aroma ROBUST or STANDARD

 When the machine leaves the factory, the aroma is set to robust. If requested it can also be set to Standard.

- **DISPLAY** READY
- Press programming key **[P]** (4) until **DISPLAY** FILTER appears.
- The illuminated ring (2) is active.
- Turn the Rotary Switch (1) until Aroma is displayed.
- **DISPLAY** AROMA
- Press the Rotary Switch (1).
- **DISPLAY** ROBUST
- Turn the Rotary Switch (1) until the following message is displayed:
- **DISPLAY** STANDARD
- To confirm the new aroma settings, press the Rotary Switch (1).
- **DISPLAY** AROMA
- Press the programming key **[P]** (4) to quit the programming mode or select the next programming item using the Rotary Switch (1).
- **DISPLAY** READY

15.4 Programming the temperature

- **DISPLAY** READY
- Press programming key **[P]** (4) until **DISPLAY** FILTER appears.
- The illuminated ring (2) is active.
- Turn the Rotary Switch (1) until Temperature is displayed.
- **DISPLAY** TEMPERATURE
- Press the Rotary Switch (1).
- **DISPLAY** HIGH
- Turn the Rotary Switch (1) to change the temperature from HIGH to NORMAL (or vice versa).

- **DISPLAY** NORMAL
- To confirm the new settings, press the Rotary Switch (1).
- **DISPLAY** TEMPERATURE
- Press the programming key **[P]** (4) to quit the programming **[P]** mode or select the next programming item using the Rotary Switch (1).
- **DISPLAY** READY

15.5 Programming the time

 You must programme the time if you want to use the automatic switch-on function.

- **DISPLAY** READY
- Press programming key **[P]** (4) until **DISPLAY** FILTER appears.
- The illuminated ring (2) is active.
- Turn the Rotary Switch (1) until TIME is displayed.
- **DISPLAY** TIME
- Now press the Rotary Switch (1) to start programming the time.
- **DISPLAY** --:--
- Turn the Rotary Switch (1) to adjust the hours..
- **DISPLAY** 12:--
- Press the Rotary Switch (1) to confirm the hour settings and to activate the minutes.
- **DISPLAY** 12:--
- Turn the Rotary Switch (1) to select the minutes.
- **DISPLAY** 2:05
- To confirm the new settings, press the Rotary Switch (1).
- **DISPLAY** TIME

- Press the programming key **[P]** (4) to quit the programming mode or select the next programming item using the Rotary Switch (1).

■ **DISPLAY** READY

 If the machine is disconnected from power supply, the time must be programmed again.

15.6 Programming the automatic switch-on time

 You must programme the time (Chapter 15.5) if you want to use the automatic switch-on function.

■ **DISPLAY** READY

- Press programming key **[P]** (4) until **DISPLAY** FILTER appears.

■ The illuminated ring (2) is active.

■ Turn the Rotary Switch (1) until MACHINE ON is displayed.

■ **DISPLAY** MACHINE ON

■ Now press the Rotary Switch (1) to start programming the switch-on time.

■ **DISPLAY** --:--

■ Turn the Rotary Switch (1) to adjust the hours.

■ **DISPLAY** 12:--

■ Press the Rotary Switch (1) to confirm the hour settings and to activate the minutes.

■ **DISPLAY** 12:--

■ Turn the Rotary Switch (1) to select the minutes.

■ **DISPLAY** 12:05

■ To confirm the new switch-on time, press the Rotary Switch (1).

■ **DISPLAY** MACHINE ON

- Press the programming key **[P]** (4) to quit the programming mode or select the next programming item using the Rotary Switch (1).

■ **DISPLAY** READY

15.7 Programming the automatic switch-off time

 You can programme your coffee machine such that it will switch off automatically after a certain time. You can programme the switch-off time in a range between 0.5 and 9 hours, or select —:— (i.e. inactive).

■ **DISPLAY** READY

- Press programming key **[P]** (4) until **DISPLAY** FILTER appears.

■ The illuminated ring (2) is active.

■ Turn the Rotary Switch (1) until OFF AFT. HR is displayed.

■ **DISPLAY** OFF AFT. HR

■ Now press the Rotary Switch (1) to start programming the switch-off time. Switch-off time OFF AFT. HR

■ **DISPLAY** 5.0 HR

■ Turn the Rotary Switch (1) to adjust the hours.

■ **DISPLAY** 1.0 HR

■ To confirm the new switch-off time, press the Rotary Switch (1).

■ **DISPLAY** OFF AFT. HR

■ Press the programming key **[P]** (4) to quit the programming mode or select the next programming item using the Rotary Switch (1).

■ **DISPLAY** READY

15.8 Cup counter

You can check how many cups of the following coffee products were drawn off:

- a) 1 cup
- b) 2 cups
- c) Powder coffee

- **DISPLAY** READY
- Press programming key **[P]** (4) until **DISPLAY** FILTER appears.
- The illuminated ring (2) is active.
- Turn the Rotary Switch (1) until CUPS MADE is displayed.
- **DISPLAY** CUPS MADE
- Now press the Rotary Switch (1) to start programming the item CUPS MADE
- The total number of drawn off products is displayed.
- For example **DISPLAY** 100
- Press one of the draw-off keys to learn the number of draw-off operations for the individual products (1 cup **[D]**, 2 cups **[D]**, powder)
- For example, press draw-off key for 1 cup **[D]** **DISPLAY** 20

! The number of pre-ground coffee drawn off can be checked by opening the filler funnel for pre-ground coffee.

- To quit, press the Rotary Switch (1).
- **DISPLAY** CUPS MADE
- Press the programming key **[P]** (4) to quit the programming mode or select the next programming item using the Rotary Switch (1).
- **DISPLAY** READY

15.9 Programming the language

- **DISPLAY** READY
- Press programming key **[P]** (4) until **DISPLAY** FILTER appears.
- The illuminated ring (2) is active.
- Turn the Rotary Switch (1) until LANGUAGE is displayed.
- **DISPLAY** LANGUAGE
- Now press the Rotary Switch (1) to start programming the item LANGUAGE.
- Turn the Rotary Switch (1) until the required language is displayed.
- For example **DISPLAY** ENGLISH
- Press the Rotary Switch (1) to save the selected language
- **DISPLAY** LANGUAGE
- Press the programming key **[P]** (4) to quit the programming mode or select the next programming item using the Rotary Switch (1).
- **DISPLAY** READY

15.10 Programming Display 24H/AM/PM

- **DISPLAY** READY
- Press programming key **[P]** (4) until **DISPLAY** FILTER -/√ appears
- The illuminated ring (2) is active.
- Turn the Rotary Switch (1) until **DISPLAY** DISPLAY appears
- Press the Rotary Switch (1)
- **DISPLAY** ML/OZ appears
- Turn the Rotary Switch (1) until **DISPLAY** 24H/AM PM appears

- Press the Rotary Switch (1)
- **DISPLAY** e.g. 24H
- Select a setting of your choice.
- Press the Rotary Switch (1) to save the setting.
- **DISPLAY** DISPLAY
- Press the programming key **[P]** (4) to quit the programming mode or select the next programming item using the Rotary Switch (1).
- **DISPLAY** READY

15.11 Programming the display for ML/OZ

- **DISPLAY** READY
- Press programming key **[P]** (4) until **DISPLAY** FILTER –/✓ appears
- The illuminated ring (2) is active.
- Turn the Rotary Switch (1) until **DISPLAY** DISPLAY appears
- Press the Rotary Switch (1)
- **DISPLAY** ML/OZ appears
- Press the Rotary Switch (1)
- **DISPLAY** e.g. ML
- Select a setting of your choice.
- Press the Rotary Switch (1) to save the setting.
- **DISPLAY** DISPLAY
- Press the programming key **[P]** (4) to quit the programming mode or select the next programming item using the Rotary Switch (1).
- **DISPLAY** READY

16. Maintenance

16.1 Filling in water

- **DISPLAY** FILL
WATER

 If this information is displayed, drawing off products is no longer possible. Refill water as described in Chapter 2.3.

- **DISPLAY** READY

 The water tank should be rinsed daily and refilled with fresh water. Only fill in fresh, cold water. Never fill in milk, mineral water or other liquids.

16.2 Emptying the coffee grounds container

- **DISPLAY** EMPTY
GROUND

 If this message appears on the display, you can no longer draw off coffee. You must empty the coffee grounds container first (Fig. 14).

- Carefully take out the drip tray, it is filled with water.
- **DISPLAY** NO –
TRAY
- Insert the empty and clean trip tray again.
- **DISPLAY** READY

 The red water level indicator appears when the drip tray is full.

16.3 Drip tray missing

- **DISPLAY** NO – TRAY
- If this information is displayed, the drip tray (20) is not installed properly or was not installed at all.
- Insert the drip tray (20).
- **DISPLAY** READY

16.4 Fill coffee beans

- **DISPLAY** FILL BEANS
- Refill beans as described in Chapter 2.4.



The message REFILL BEANS will disappear after you draw off your next cup of coffee.



We recommend that you clean the bean tank regularly before refilling beans, using a dry cloth. Before cleaning the tank, switch off the IMPRESSA.

16.5 Replacing the filter



After drawing off 50 litres, the filter cartridge will be used up. A message requesting you to replace the filter will appear on the display.

Refer to Chapter 5.2 «Replacing the filter».

16.6 Cleaning the IMPRESSA

After 200 draw-off operations or after 160 rinsing operations, the IMPRESSA must be cleaned. A message appears on the display, telling you to start the cleaning programme. You can still draw off coffee or hot water/steam. However, we recommend that you should clean the machine (Chapter 17) within the next few days.

- **DISPLAY** READY
CLEAN

16.7 IMPRESSA decalcify

During operation, the machine will calcify. The degree of scaling depends on the hardness of the water in your region. The machine will inform you when de-scaling is required. You can still draw off coffee or hot water/steam. However, we recommend that you should de-scale the machine (Chapter 18) within the next few days.

- **DISPLAY** READY
DECALCIFY

16.8 General cleaning instructions

- Never use scratching objects, pan cleaners, cleaning sponges or caustic chemicals to clean the machine.
- Wipe off the case on the inside and outside using a soft, moist cloth.
- Clean the replaceable hot water nozzle after each use.
- To ensure that the Easy-Auto-Cappuccino Frother functions perfectly, you should rinse it with water each time after preparing milk.
- To ensure that the Easy-Auto-Cappuccino Frother functions perfectly, you should clean it daily if you have prepared milk.
- The water tank should be rinsed daily and refilled with fresh water.



If the water tank shows signs of scaling, remove the scaling using a commercial de-scaling solvent. Take out the water tank (Fig. 4).



Remove the Claris filter cartridge, if installed, before de-scaling the water tank.

16.9 Emptying the system

Precondition: IMPRESSA switched off

 This operation is required to protect the IMPRESSA against frost damage during transports.

- Place a container under the Easy-Auto-Cappuccino Frother (15) (Fig. 10).
- Press the steam preselection key  (8) until the following message is displayed:
 - **DISPLAY** OPEN TAP
 - **DISPLAY** EMPTYING
 - **DISPLAY** CLOSE TAP
- The IMPRESSA is switched off.

17. Cleaning



Your IMPRESSA features an integrated cleaning program. The cleaning operation will take some 15 min.

 Original JURA cleaning tablets which are specially designed for the cleaning programm of your IMPRESSA are available at your authorized dealer. Please note that machine defects or residues in the water cannot be excluded if you use inappropriate cleaning solvents.

 Once started, the de-scaling operation must not be interrupted!

 After each cleaning operation the filler funnel for pre-ground coffee should be cleaned (11).

- **DISPLAY** READY
CLEAN

- Press the maintenance key  (7) until the following message is displayed:
 - **DISPLAY** EMPTY
TRAY
- Empty the tray
 - **DISPLAY** NO
TRAY
- Insert the tray again.
- Remove the drip grate (19).
- Put a container (Fig. 12) under the adjustable coffee spout (17).
 - **DISPLAY** PRESS
RINSE
- Press the maintenance key  (7).
 - **DISPLAY** CLEANING
 - **DISPLAY** FILL
TABLET
- Fill in the tablet (see Fig. 15)
 - **DISPLAY** PRESS
RINSE
- Press the maintenance key  (7).
 - **DISPLAY** CLEANING
 - **DISPLAY** EMPTY
TRAY
 - **DISPLAY** NO
TRAY
 - **DISPLAY** READY
- Wipe coffee powder tank with a dry cloth after the cleaning program has finished.
- The cleaning operation was completed successfully.

18. De-scaling

Your IMPRESSA features an integrated de-scaling program. The de-scaling operation will take some 40 min.



 Original JURA de-scaling tablets which are specially designed for the de-scaling program of your IMPRESSA are available at your authorized dealer. Please note that machine defects or residues in the water cannot be excluded if you use inappropriate de-scaling solvents.

 If the IMPRESSA needs de-scaling, the corresponding message is displayed.
You can still draw off coffee or hot water/steam and start the de-scaling program later.
Before starting the de-scaling program, the machine must be switched off. Once started, the de-scaling operation must not be interrupted.

 When using the de-scaling solvent, immediately remove any splashes or drips from sensitive surfaces, i.e. natural stone and wooden surfaces, or take appropriate precautions.

 In any case wait until the de-scaling solvent is used up and the tank is empty. Never refill de-scaling solvent.

■ **DISPLAY** READY
DECALCIFY

- Switch off the IMPRESSA using the ON/OFF key  (3).
- Remove the Easy-Auto-Cappuccino Frother (15) (Fig. 17).
- Press the maintenance key  (7) until the following message is displayed:

■ **DISPLAY** EMPTY
TRAY

- Empty the tray

■ **DISPLAY** NO –
TRAY

- Insert the tray again.

■ **DISPLAY** SOLVENT
IN TANK

Completely dissolve the content of one blister (3 tablets) in a jug containing 0.5 litres of water, and fill the mixture in the water tank. Reinstall the water tank.

■ **DISPLAY** OPEN TAP
SOLVENT
IN TANK

- Put a sufficiently large container under the hot water spout (Fig. 17).

- Open the steam / hot water draw-off valve (14) (Fig. 13).

■ **DISPLAY** DE-SCALING

■ **DISPLAY** CLOSE TAP

- Close the steam / hot water draw-off tap (14).

■ **DISPLAY** DE-SCALING

■ **DISPLAY** EMPTY
TRAY

- Empty the tray

■ **DISPLAY** NO –
TRAY

- Insert the tray again.

■ **DISPLAY** FILL
WATER

 Rinse the water tank thoroughly and fill it with cold, fresh tap water. Install it again.

- **DISPLAY** OPEN
TAP
- Open the steam / hot water draw-off tap (14) (Fig. 13).
- **DISPLAY** DE-SCALING
- **DISPLAY** CLOSE TAP
- After you have closed the steam / hot water draw off tap (14), the following message is displayed
- **DISPLAY** DE-SCALING
- **DISPLAY** EMPTY
TRAY
- Empty the tray
- **DISPLAY** NO –
TRAY
- Insert the tray again.
- **DISPLAY** PRESS
RINSE
- Press the maintenance key  (7).
- **DISPLAY** RINSING
- **DISPLAY** READY
- The de-scaling operation was completed successfully.

19. Disposal



Please dispose of old machines in an environmentally compatible way

Old machines contain valuable materials capable of being recycled which should be salvaged for recycling. Please therefore dispose of old machines via suitable collection systems.

20. Tips for perfect coffee

Height-adjustable coffee spout (17)

You can adjust the height of the coffee spout to the size of your cups (Fig. 3)

Grinding degree

Refer to Chapter 2.5 «Adjusting the grinding gear».

Preheating cups

You can preheat the cups using hot water or steam. The smaller the coffee you want to draw off, the more important preheating is.

Sugar and cream

Stirring coffee/tea will result in heat being released. Adding refrigerated cream or milk will reduce the temperature of the coffee significantly.

21. Messages

DISPLAY	Cause	Remedy
FILL WATER	Water tank is empty.	Refill water
	Float defective	Rinse or de-scale water tank
FILL BEANS	Bean tank is empty.	Refill beans
	Although you have refilled beans, the message still appears.	Draw off a cup of coffee. The message will disappear only after you have drawn off a cup of coffee
EMPTY GROUNDS	Coffee grounds container full	Empty coffee grounds container
	Tray reinstalled too early after emptying	Wait 10 sec. before reinstalling the tray
NO TRAY	Drip tray not installed properly or missing	Install tray properly
READY CLEAN	Cleaning required	Start cleaning programme (Chapter 17)
READY SCALED	De-scaling required	Start de-scaling programme (Chapter 18)
READY FILTER	Filter used up	Replace filter (Chapter 5.2)
FAULT	General fault	<ul style="list-style-type: none">- switch off- disconnect from mains supply- Connect IMPRESSA to power supply- Switch on IMPRESSA <ul style="list-style-type: none">- Have IMPRESSA checked by JURA Service

22. Problems

Problem	Cause	Remedy
Very loud noise coming from the grinding gear	Foreign body in grinding gear	Drawing off pre-ground coffee still possible Have IMPRESSA checked by JURA Service
Too little froth when frothing milk	Easy Cappuccino Frother has become dirty	Clean the Easy-Auto-Cappuccino Frother (Chapter 13)
	Individual parts of the Easy-Auto-Cappuccino Frother are incorrectly assembled	Check correct assembly of the Easy-Auto-Cappuccino Frother
Coffee only drips from the coffee spout	Grinding degree too fine	Coarser grinding gear adjustment
	Pre-ground coffee too fine	Use a coarser pre-ground coffee

High-frequency, electromagnetic interference may influence the display. Drawing off coffee is possible at any time.

If the messages or problems still persist, please contact your local authorized dealer or JURA Elektroapparate AG.

23. Legal information

These operating instructions contain all the information required for using, operating and maintaining the machine properly.

Knowledge of and compliance with the specifications contained in these operating instructions is required for using the machine safely as well as for operational safety and safety during maintenance.

These operating instructions cannot cover any conceivable application. The machine was designed for private household use.

Additionally we point out that the content of these operating instructions does not form part of any previous or existing agreement, consent or al legal relationship nor does it constitute a change of such an agreement, consent or legal relationship. Any obligations to be fulfilled by JURA Elektroapparate AG are stipulated in the corresponding purchase contract, which also contains the full and solely applicable warranty stipulations. These contractual warranty stipulations are neither extended nor limited by the specifications contained in these operating instructions.

The operating instructions contain information, protected by Copyright. Photocopying or translations into other languages shall not be permissible without JURA Elektroapparate AG's written approval.

24. Technical data

Voltage:	230V AC
Power:	1450 W
Intensity of current:	10 A
Safety check:	
Energy consumption Standby:	approx. 3.5 Wh
Energy consumption «Ready for draw-off» mode:	approx. 11.5 Wh
Pump pressure:	static, max. 15 bar
Water tank:	1.9 litres
Bean tank capacity:	200gr
Coffee grounds container capacity :	max. 16 portions
Length of cable:	approx. 1.1 m
Weight:	9.1 kg
Size (WxHxD):	28 x 34.5 x 44.5 cm

The machine complies with the following EU directives:
73/23/EEG dated 19/02/1973 "Low Voltage Directive" including
Modification Directive 93/336/EEG
89/336/EEG dated 03/05/1989 "EMC Directive" including
Modification Directive 92/31/EEG

Free Manuals Download Website

<http://myh66.com>

<http://usermanuals.us>

<http://www.somanuals.com>

<http://www.4manuals.cc>

<http://www.manual-lib.com>

<http://www.404manual.com>

<http://www.luxmanual.com>

<http://aubethermostatmanual.com>

Golf course search by state

<http://golfingnear.com>

Email search by domain

<http://emailbydomain.com>

Auto manuals search

<http://auto.somanuals.com>

TV manuals search

<http://tv.somanuals.com>