

JVC



COMPACT COMPONENT SYSTEM SISTEMA DE COMPONENTES COMPACTO SISTEMA DE COMPONENTE COMPACTO

CA-D501T/MX-D401T/MX-D301T

Consists of CA-D401T and SP-D401
Consta del CA-D401T el SP-D401
Consta do CA-D401T e SP-D401

Consists of CA-D301T and SP-D311
Consta del CA-D301T el SP-D311
Consta do CA-D301T e SP-D311

CA-D501T

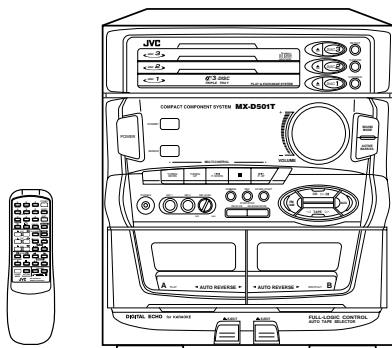

MX-D401T

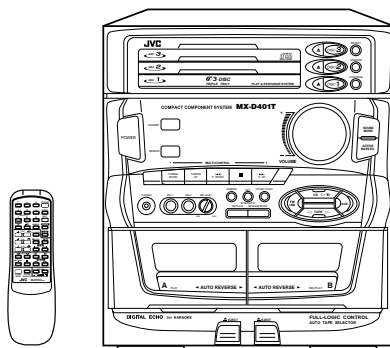

MX-D301T

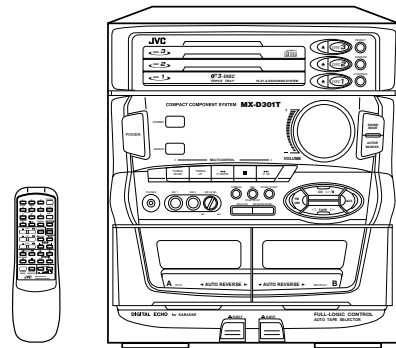

CA-D401T

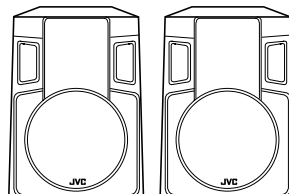

SP-D401

CA-D301T

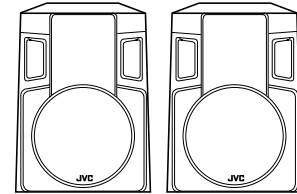

SP-D311

COMPACT
disc
DIGITAL AUDIO

INSTRUCTIONS MANUAL DE INSTRUCCIONES INSTRUÇÕES

For Customer Use:

Enter below the Model No. and Serial No. which are located either on the rear, bottom or side of the cabinet. Retain this information for future reference.

Model No. _____

Serial No. _____

PART No. FMUN9002-181M
[U, UT, US, UB]

Warnings, Cautions and Others
Avisos, precauciones y otras notas
Advertências, precauções e outras notas
警告，注意及其他須知事項
تحذيرات، تنبيهات وأشياء أخرى

IMPORTANT for the U.K.

DO NOT cut off the mains plug from this equipment. If the plug fitted is not suitable for the power points in your home or the cable is too short to reach a power point, then obtain an appropriate safety approved extension lead or consult your dealer.

BESURE to replace the fuse only with an identical approved type, as originally fitted.

If nonetheless the mains plug is cut off ensure to remove the fuse and dispose of the plug immediately, to avoid a possible shock hazard by inadvertent connection to the mains supply.

If this product is not supplied fitted with a mains plug then follow the instructions given below:

IMPORTANT.

DO NOT make any connection to the terminal which is marked with the letter E or by the safety earth symbol or coloured green or green-and-yellow.

The wires in the mains lead on this product are coloured in accordance with the following code:

Blue : Neutral
Brown : Live

As these colours may not correspond with the coloured markings identifying the terminals in your plug proceed as follows:

The wire which is coloured blue must be connected to the terminal which is marked with the letter N or coloured black.

The wire which is coloured brown must be connected to the terminal which is marked with the letter L or coloured red.

IF IN DOUBT - CONSULT A COMPETENT ELECTRICIAN.

Caution — POWER switch!

Disconnect the mains plug to shut the power off completely. The POWER switch in any position does not disconnect the mains line. The power can be remote controlled.

¡Atención — Interruptor POWER!

Desconectar el cable de alimentación para desactivar la alimentación totalmente. Cualquier que sea la posición de ajuste del interruptor POWER, la alimentación no es cortada completamente. La alimentación puede ser controlada remotamente.

Atenção — Interruptor POWER!

Desconecte o cabo de alimentação para interromper a alimentação completamente. Qualquer que seja a posição de ajuste do interruptor POWER, a alimentação não é completamente cortada. A alimentação pode ser controlada remotamente.

CAUTION

To reduce the risk of electrical shocks, fire, etc.:

1. Do not remove screws, covers or cabinet.
2. Do not expose this appliance to rain or moisture.

PRECAUCIÓN

Para reducir riesgos de choques eléctricos, incendio, etc.:

1. No extraiga los tornillos, los cubiertas ni la caja.
2. No exponga este aparato a la lluvia o a la humedad.

PRECAUÇÃO

Para reduzir riscos de choques elétricos, incêndio, etc.:

1. Não remova parafusos e tampas ou desmonte a caixa.
2. Não exponha este aparelho à chuva nem à umidade.

注意

為了減低觸電，火災等危險：

1. 請勿擅自卸下螺絲釘，蓋子或機殼。
2. 切勿讓本機受雨淋或置潮濕環境中。

تحذير

لتجنب خطر الحريق، الصدمات الكهربائية، الخ.:

١. لا تقم بفك البراغي، الاغطية أو الخزائن.
٢. لا تقم بتعريض هذا الجهاز للمطر أو للرطوبة.

IMPORTANT FOR LASER PRODUCTS / IMPORTANTE PARA PRODUCTOS LÁSER / IMPOTANTE PARA PRODUTOS LASER / 雷射產品的重要說明 / مهم للمنتجات الليزرية

REPRODUCTION OF LABELS / REPRODUCCIÓN DE ETIQUETAS / REPRODUÇÃO DE ETIQUETAS
標籤內容說明 / إنتاج الماصقات

- | | |
|---|---|
| ① CLASSIFICATION LABEL, PLACED ON REAR ENCLOSURE | ② WARNING LABEL, PLACED INSIDE THE UNIT |
| ① ETIQUETA DE CLASIFICACIÓN, PEGADA EN LA PARTE POSTERIOR DE LA CAJA | ② ETIQUETA DE ADVERTENCIA, PEGADA EN EL INTERIOR DE LA UNIDAD |
| ① ETIQUETA DE CLASSIFICAÇÃO LOCALIZADA NA PARTE POSTERIOR DA CAIXA DO APARELHO. | ② ETIQUETA DE ADVERTÊNCIA LOCALIZADA NA PARTE INTERNA DA UNIDADE. |
| ① 分類標籤，貼在機殼背後。 | ② 警告標籤，貼於機內。 |

① لاصق التصنيف، موضوعة على المرفق الخلفي

② لاصقة التحذير، موضوعة بداخل الجهاز

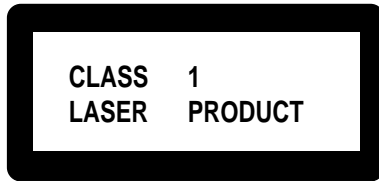

DANGER: Invisible laser radiation when open and interlock failed or defeated. AVOID DIRECT EXPOSURE TO BEAM. (e)	WARNING: Osynlig laserstrålning när denna del är öppnad och spärren är urkopplad. Beträkta ej strålen. (s)	ADVARSEL: Usynlig laserstrålning ved åbning, når sikkerhedsafbrydere er ude af funktion. Undgå udsættelse for stråling. (d)	VARO: Avattaessa ja suojalukitus ohitettaessa olet alttiina näkymättömälle lasersäteilylle. Älä katso säteeseen. (f)
---	---	--	---

1. CLASS 1 LASER PRODUCT
 2. **DANGER:** Invisible laser radiation when open and interlock failed or defeated. Avoid direct exposure to beam.
 3. **CAUTION:** Do not open the top cover. There are no user serviceable parts inside the Unit; leave all servicing to qualified service personnel.
1. PRODUCTO LÁSER CLASE 1
 2. **PELIGRO:** En el interior hay radiación láser invisible. Evite el contacto directo con el haz.
 3. **PRECAUCIÓN:** No abra la tapa superior. En el interior de la unidad no existen piezas reparables por el usuario; deje todo servicio técnico en manos de personal calificado.
1. PRODUTO LASER CLASSE 1
 2. **PERIGO:** O laser emite uma radiação invisível que é perigosa, caso o aparelho esteja aberto e a trava inoperante ou danificada. Evite exposição direta ao feixe dos raios.
 3. **CUIDADO:** Não abra a caixa do aparelho. Não existem peças reparáveis pelo usuário na parte interna da unidade. Solicite assistência técnica somente a pessoal técnico qualificado.

1. 一級雷射產品
2. 危險：當內部鎖定裝置失效或者損壞後，打開蓋板可能會產生不可見的雷射輻射。應避免受到光束直接照射。
3. 注意：請勿打開頂蓋板。本機內部沒有用戶可自行維修的部件；所有維修工作應由有資格的人員完成。

1. صنف ١ منتج ليزري
2. خطر: أشعة ليزرية غير مرئية عند الفتح والأغلاق الفاشل أو غير الصحيح. تجنب التعرض المباشر للأشعة.
3. تحذير: لا تفتح الغطاء العلوي. ليس في داخل الجهاز أقسام بمستطاع المستخدم صيانتها؛ إعهد بكافة الأعمال الصيانة لفي مختص.

Caution: Proper Ventilation

To avoid risk of electric shock and fire, and to prevent damage, locate the apparatus as follows:

- 1 Front: No obstructions and open spacing.
- 2 Sides/ Top/ Back: No obstructions should be placed in the areas shown by the dimensions below.
- 3 Bottom: Place on the level surface. Maintain an adequate air path for ventilation by placing on a stand with a height of 10 cm or more.

Precaución: el aparato debe estar bien ventilado

Para evitar posibles riesgos de descargas eléctricas e incendios y prevenir cualquier posible daño, coloque el aparato del modo siguiente:

- 1 Parte delantera: No ponga nada delante, deje el espacio libre.
- 2 Laterales/ parte superior/ parte trasera: No se debería colocar nada en las áreas y las distancias que se detallan a continuación.
- 3 Parte inferior: Coloque el aparato sobre una superficie recta. Debe haber buena circulación de aire; para ello, coloque el aparato sobre una base a una altura mínima de 10 cm.

Precaução: Ventilação adequada

Para evitar riscos de choques elétricos e incêndios, e prevenir avarias, instale o aparelho como segue:

- 1 Parte frontal: Sem obstruções e espaços abertos.
- 2 Partes laterais/Tampa/Posterior: Nenhuma obstrução deverá ser colocada entre as áreas cujas dimensões são indicadas abaixo.
- 3 Parte inferior: Instale-o sobre uma superfície plana. Deverá ser mantido espaço suficiente para a ventilação se este for instalado numa posição que tenha uma altura de 10 cm ou mais.

警告：正確通風

避免發生雷電和火警的危險，及防止本機受損，請將本機如下放置：

- 1 前面： 沒有障礙物及地方開闊
- 2 側面/頂部/背面： 在圖中所示範圍中，不要放置任何障礙物。
- 3 底座： 放置在水平面上，放置在一個高10厘米或以上的臺上，以保持足夠的通風距離。

تحذير: التهوية الصحيحة

لتفادي وقوع الصدمة الكهربائية وخطر الحريق والتلف المحتمل، قم بتركيب الجهاز كما هو موضح ادناه:

- ١ الجهة الامامية: عدم وجود العوائق
- ٢ الجهات الجانبية والعلوية والخلفية: ينبغي عدم وضع العوائق في المجالات الموضحة بالابعاد ادناه.
- ٣ القاع: ضع الجهاز على السطح المستوي، احتفظ بعمق الهواء للتهوية بوضع الجهاز على الحامل بارتفاع ١٠ سم او اكثر.

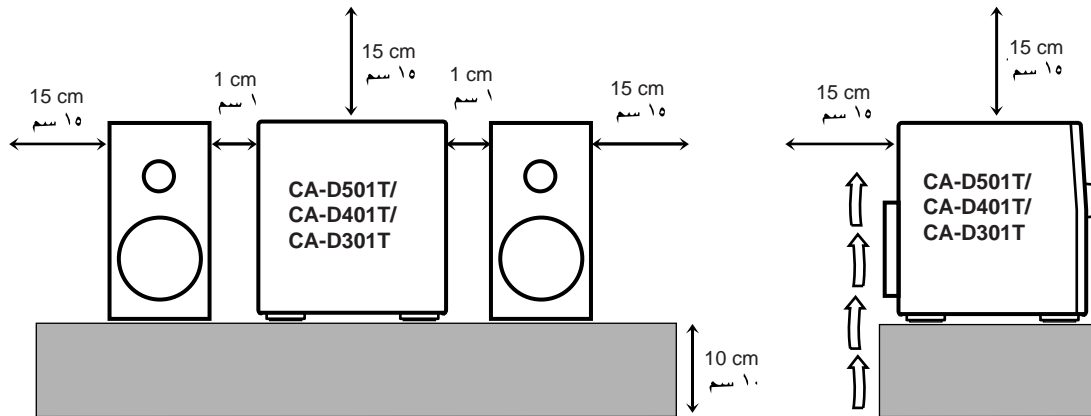

Thank you for purchasing the JVC Compact Component System.
 We hope it will be a valued addition to your home, giving you years of enjoyment.
 Be sure to read this instruction manual carefully before operating your new stereo system.
 Here you will find all the information you need to set up and use the system.
 For questions that are not be answered in the manual, please contact your dealer.

Features

Easy operation



Great sound

Triple Tray

Sing Along

Here are some of the things that make your System powerful and easy to use.

- The controls and operations have been redesigned to make them very easy to use, so you can spend your time listening to music.
 - With the One Touch Operation feature of JVC's **COMPU PLAY** you can turn on the System and start the radio, the Cassette Deck, or the CD Player with a single touch.
- To get such great sound from such a compact package the System has:
 - Programmed sound mode includes live surround effects **D. CLUB, HALL, and STADIUM**. It also includes S.E.A (Sound Effect Amplifier) effects **ROCK, CLASSIC, and POP**.
- CD changer function can operate 3 discs.
 - Discs can be changed during play using the **TRIPLE TRAY**.
 - Continuous, random or program play of 3 discs.
- Includes a timer for recording broadcasts while you are out, and an easy-to-use Sleep timer.
- You can use conventional tapes and CDs for **Karaoke** with the voice masking system. With an optional microphone, you can replace the lead singer's voice on your favorite songs with your own.
 - **Digital Echo** applied to your voice through the microphone gives you a professional sound.

How This Manual Is Organized

In this manual we have incorporated some special features:

- Basic information that is the same for many different functions is grouped in one place, and not repeated in each procedure. For instance, in the section on playing a CD, we do not repeat the information about setting the volume and the sound conditions, which are discussed in the Common Operations section.
- Name of buttons and controls are written in all capital letters like this: SOUND MODE.
- When we are talking about the Function, rather than the BUTTON or DISPLAY, only the first letter is capitalized.

The manual has a table of contents to help you quickly look up what you want to know.

We've enjoyed making this manual for you, and hope you will use it to enjoy the sound and many features built into your System.

IMPORTANT CAUTIONS

1. Installation of the Unit

- Select a place which is level, dry and neither too hot nor too cold. (Between 5°C and 35°C or 41°F and 95°F.)
- Leave sufficient distance between the Unit and a TV.
- Do not use the Unit in a place subject to vibrations.

2. Power cord

- Do not handle the power cord with wet hands!
- Some power (12 watts) is always consumed as long as the power cord is connected to the wall outlet.
- When unplugging the Unit from the wall outlet, always pull the plug, not the power cord.

3. Malfunctions, etc.

- There are no user serviceable parts inside. If anything goes wrong, unplug the power cord and consult your dealer.
- Do not insert any metallic object into the Unit.

Table of Contents

Features	1	Repeating a Selection or the Discs	17
How This Manual Is Organized	1	Tray Lock Function	17
IMPORTANT CAUTIONS	1	Locking the Electronic Lock	17
		Unlocking the Electronic Lock	17
Getting Started	3	Using the Cassette Deck	
Accessories	3	(Listening to a Tape)	18
Set the VOLTAGE SELECTOR Switch	3	One Touch Play	18
How To Put Batteries In the Remote Control	3	Regular Play	18
Using the Remote Control	3	Fast Left and Fast Right	19
Connecting the FM Antenna	4	Music Scan	19
Connecting the AM Antenna	4	To Find the Beginning of the Current Selection	19
Connecting the Speakers (CA-D501T)	5	To Find the Beginning of the Next Selection	19
Connecting the Speakers (MX-D401T/MX-D301T)	5	Reverse Mode	19
Connecting Auxiliary Equipment	6	Using the Cassette Deck (Recording)	20
COMPU PLAY	6	Things To Know Before You Start Recording	20
Common Operations	7	Standard Recording	21
Turning the Power On and Off	7	To Record Any Sound Source To Tape	21
Turning the System On	7	CD Direct Recording	22
Turning the System Off	7	Tape to Tape Recording (Dubbing)	22
Adjusting the Volume	8	How to Use the DUBBING Button	22
Reinforcing the Bass Sound	8	Using the Timer	23
Sound Modes	8	Setting the Clock	23
Listening to Auxiliary Equipment	9	Setting the Timer	24
Using the Tuner	10	Setting the SLEEP Timer	25
Setting the AM Tuner Interval Spacing	10	Using the Microphone	26
One Touch Radio	10	Karaoke (Sing Along)	26
Tuning In a Station	11	Singing Along with Karaoke	26
Switching between Frequency Bands	11	Digital Echo	27
Three ways to select a station	11	To Record Your Singing	27
Presetting Stations	11	Microphone Mixing	28
To Change the FM Reception Mode	11	To Record Microphone Mixing	28
Using the CD Player	12	Playing the Microphone Sound through	
The Quickest Way To Start a CD Is With the		the Speaker	28
One Touch Operation	13	Recording from the Microphone	28
To Insert Discs	13	Care And Maintenance	29
Basics of Using the CD Player — Normal Play	14	Troubleshooting	30
To Play a Disc	14	Specifications	31
To Select a Disc, Track Or Passage			
Within a Track	14		
Locating a Track With the Remote Control			
Directly	14		
To Change Discs While Playing	14		
Continuous Play	15		
Programming the Playing Order of the Tracks	15		
Random Play	16		

Accessories

Check that you have all of the following items, which are supplied with the System.

- AM Loop Antenna (1)
- Remote Control (1)
- Batteries (2)
- FM Wire Antenna (1)
- AC Plug Adaptor (except for Hong Kong) (1)

If any of these items is missing, contact your dealer immediately.

Set the VOLTAGE SELECTOR Switch

To avoid damaging the System, set the voltage before plugging in the Unit.

- Set the correct voltage for your area with the VOLTAGE SELECTOR switch on the back panel of the System. Use a screwdriver to rotate the selector so the number the arrow is pointed at is the same as the voltage.

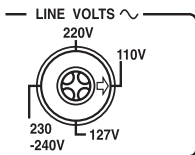

How To Put Batteries In the Remote Control

Match the polarity (+ and -) on the batteries with the + and - markings in the battery compartment.

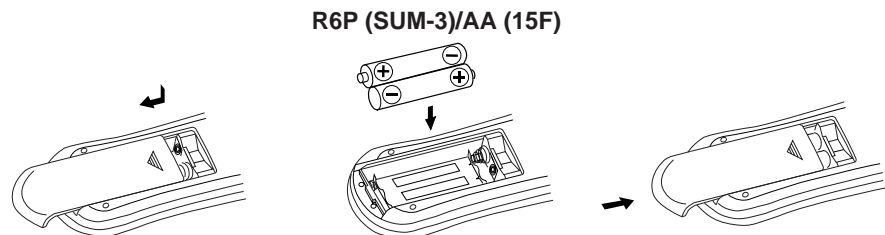

CAUTION: Handle batteries properly.

To avoid battery leakage or explosion:

- Remove batteries when the Remote Control will not be used for a long time.
- When you need to replace the batteries, replace both batteries at the same time with new ones.
- Don't use an old battery with a new one.
- Don't use different types of batteries together.

Using the Remote Control

The Remote Control makes it easy to use many of the functions of the System from a distance of up to 7m (23 feet) away.

You need to point the Remote Control at the remote sensor on the System's front panel.

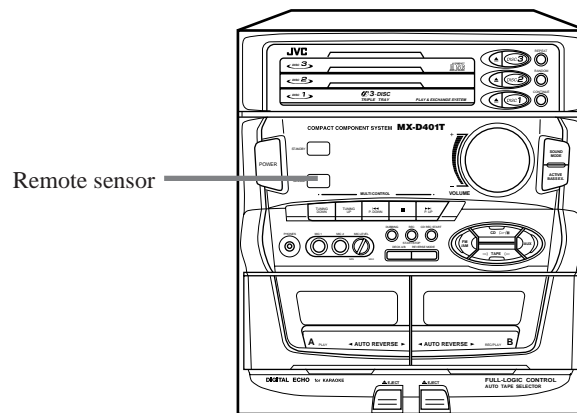

CAUTION: Make all connections before plugging the Unit into an AC power outlet.

Connecting the FM Antenna

Using the Supplied Wire Antenna

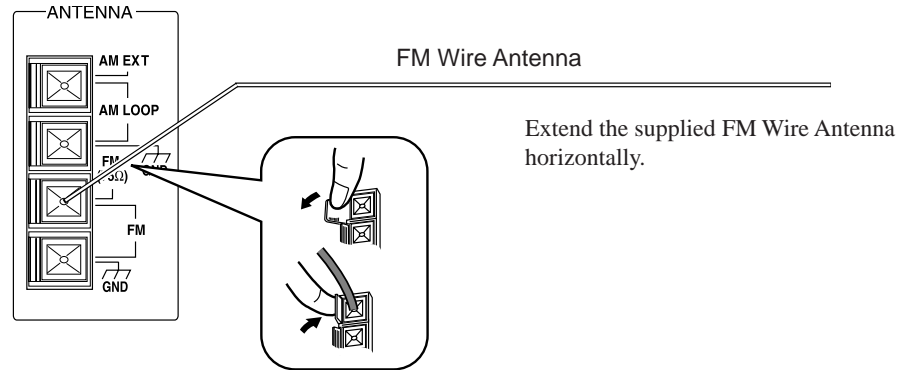

Using an FM 75-Ohm Antenna Wire (Not Supplied)

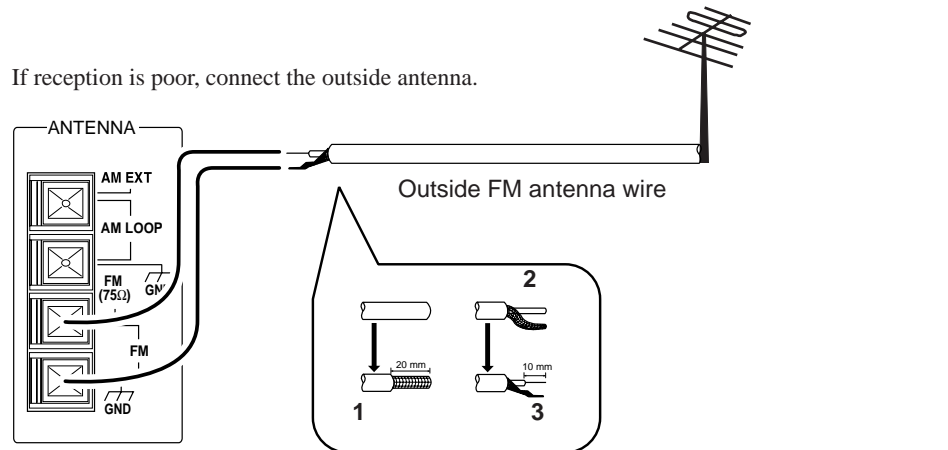

CAUTION: To avoid noise, keep antennas away from metallic parts of the System, connecting cord and the AC power cord.

Connecting the AM Antenna

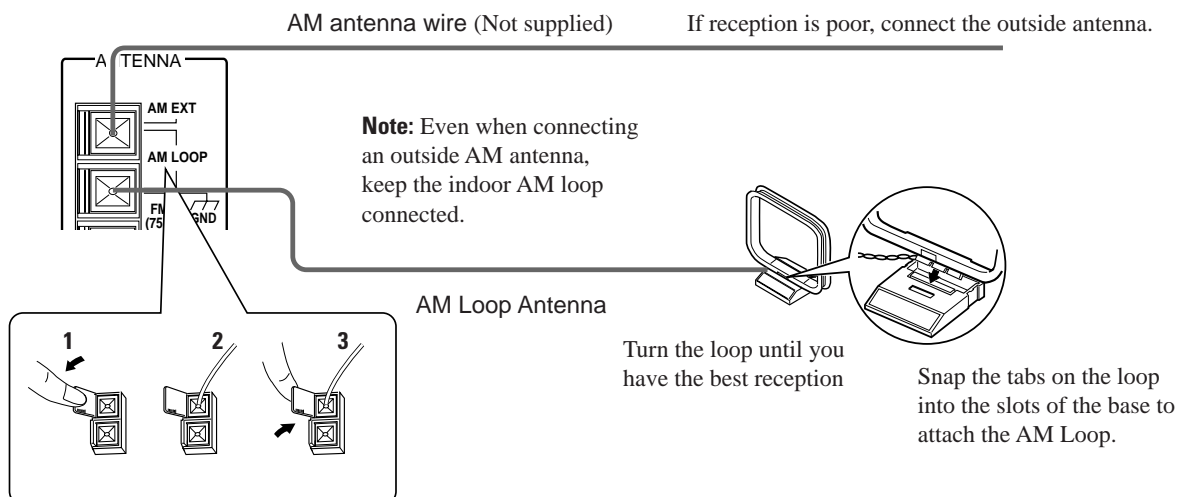

CAUTION: Make all connections before plugging the Unit into an AC power outlet.

Connecting the Speakers (CA-D501T)

■ Please refer to instructions for speakers as well when you connect speakers.

For each speaker, connect one end of the speaker wire to the speaker terminals on the back of the CA-D501T and the other end to the speaker.

1. Open each of the terminals and insert the speaker wires firmly (be sure to remove the insulation at the end of each wire first), then close the terminals.
2. Connect the red (+) and black (-) terminals of the right side speaker to the red (+) and black (-) terminals marked RIGHT on the CA-D501T.
Connect the red (+) and black (-) terminals of the left side speaker to the red (+) and black (-) terminals marked LEFT on the CA-D501T.

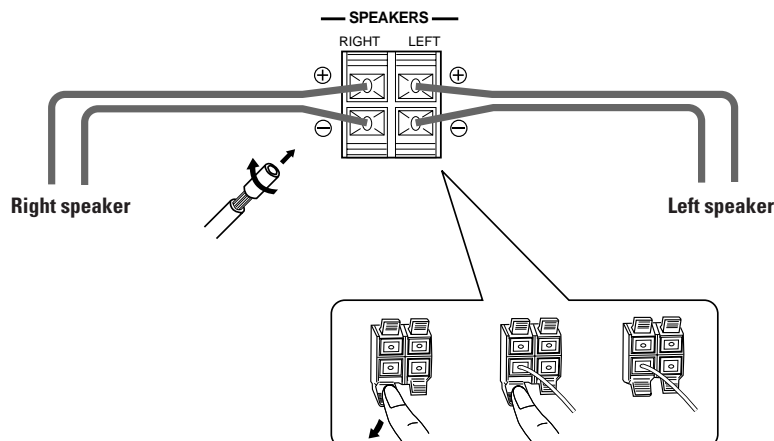

IMPORTANT: Use speakers with the correct impedance only. The correct impedance is indicated on the back panel.

CAUTION: If a TV is installed near speakers, the TV may display irregular colours. In this case, set the speakers away from the TV.

Connecting the Speakers (MX-D401T/ MX-D301T)

■ Please refer to instructions for speakers as well when you connect speakers.

For each speaker, connect one end of the speaker wire to the speaker terminals on the back of the System.

1. Open each of the terminals and insert the speaker wires firmly, then close the terminals.
2. Connect the red (+) and black (-) terminals of the right side speaker to the red (+) and black (-) terminals marked RIGHT on the System.
Connect the red (+) and black (-) terminals of the left side speaker to the red (+) and black (-) terminals marked LEFT on the System.

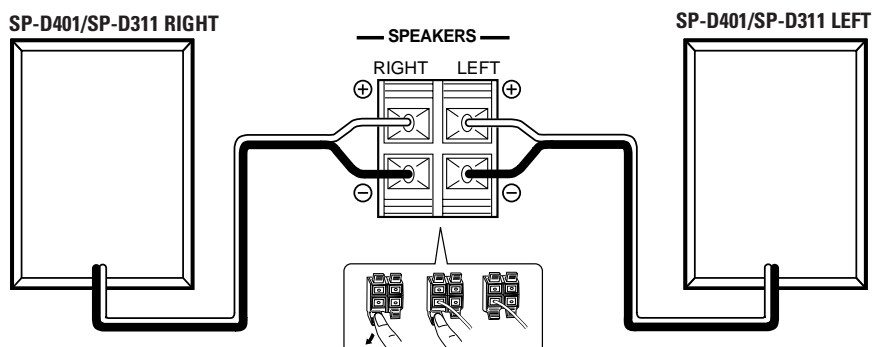

IMPORTANT: Use speakers with the correct impedance only. The correct impedance is indicated on the back panel.

CAUTION: If a TV is installed near speakers, the TV may display irregular colours. In this case, set the speakers away from the TV.

Connecting Auxiliary Equipment

VCR or other equipment

To listen to this source, press the AUX button.

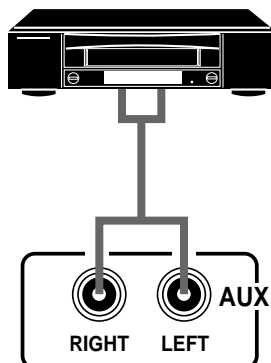

Now you can plug the AC power cord into the wall outlet, and your System is at your command!

COMPU PLAY

COMPU PLAY is JVC's feature that lets you control the most frequently used functions of the System with a single touch.

One Touch Operation starts playing a CD, turns on the radio, plays a tape, etc. with a single press of the play button for that function. What One Touch Operation does for you is to turn the power on, then start the function you have specified. If the Unit is not ready, such as no CD or tape in place, the Unit still powers on so you can insert a CD or tape.

How One Touch Operation works in each case is explained in the section dealing with that function.

The COMPU PLAY buttons are:

On the Unit

- CD ▷/|| button
- CD Player DISC-1 to DISC-3 buttons
- CD Player Open/Close (▲) buttons
- FM/AM button
- ◁ TAPE ▷ button
- AUX button

On the Remote Control

- FM/AM button
- AUX button
- CD control ►/|| button
- CD control DISC 1 to DISC 3 buttons
- CD control Open/Close (▲) buttons
- Deck control ◀, ▶ buttons

Common Operations

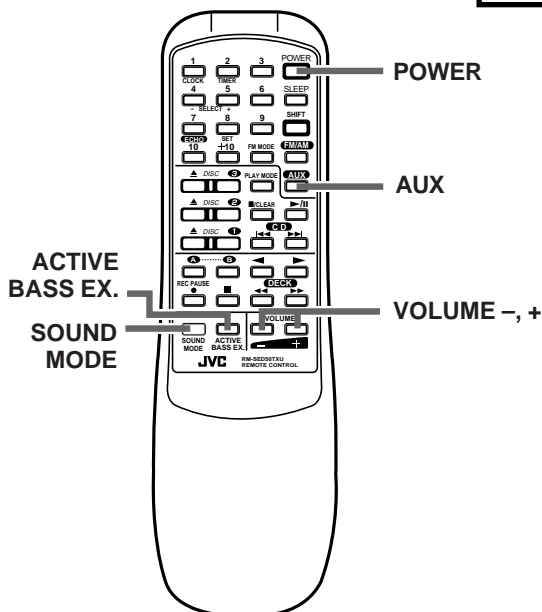
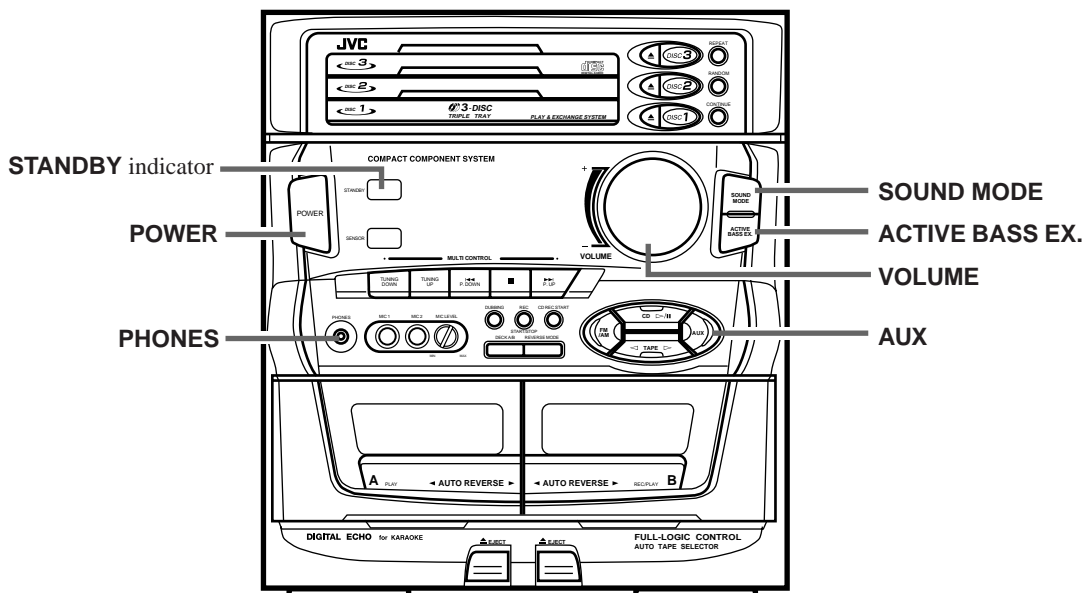

Display

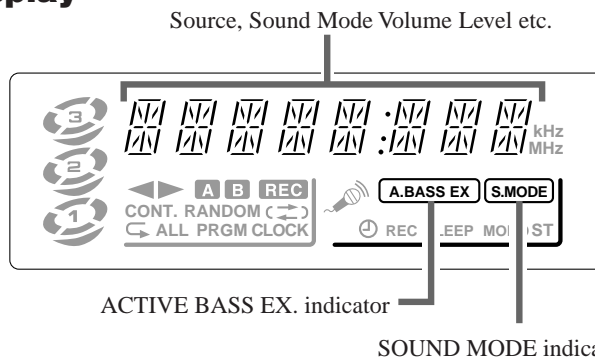

When the System is being used, the display shows other items as well. However, we have only shown the items described in this section.

Turning the Power On and Off

Turning the System On

Press the POWER button.

The display comes on and the STANDBY indicator goes out.

The System comes on ready to continue in the mode it was in when the power was last turned off.

- If the last thing you were doing was listening to a tape in Deck B, you are now ready to listen to a tape again in Deck B, or you can change to another source.
- If you were listening to the Tuner last, the Tuner comes on playing the station it was last set to.

Turning the System Off

Press the POWER button again.

The STANDBY indicator lights up and the display is blank, except for the clock display.

- Some power (12 watts) is always consumed even though power is turned off (called Standby Mode).
- To switch off the Unit completely, unplug the AC power cord from the AC outlet. When you unplug the AC power cord, the clock will be reset to 0:00 immediately, and preset Tuner stations will be erased after a few days.

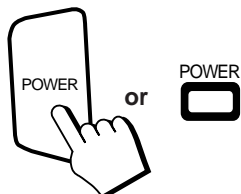

Adjusting the Volume

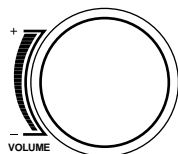

or



Turn the VOLUME control clockwise to increase the volume or anticlockwise to decrease it. Turning the VOLUME control quickly also adjusts the volume level quickly.

When using the Remote Control, press the VOLUME + button to increase the volume or press the VOLUME – button to decrease it.

You can adjust the volume level between 0 and 50.

VOLUME 0

CAUTION: The Volume cannot be adjusted while the Unit is in STANDBY mode. DO NOT turn on the Unit and/or start playing any source without setting the VOLUME control to 0; otherwise, the sudden blast of sound can damage your hearing, speakers and/or headphones.

For private listening

Connect a pair of headphones to the PHONES jack. No sound comes out of the speakers.

Be sure to turn down the volume before connecting or putting on headphones.

Reinforcing the Bass Sound

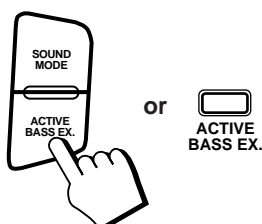

The richness and fullness of the bass sound is maintained regardless of how low you set the volume. You can use this effect only for playback.

To get the effect, press the ACTIVE BASS EX. (Active Bass Extension) button.

The frame around the “A. BASS EX” indicator lights up.

A.BASS EX

To cancel the effect, press the button again.

The frame around the “A. BASS EX” indicator goes out.

A.BASS EX

Sound Modes

The System has some preset sound effects that give you control of the way your music sounds, so you can tailor it for your room and for the quality of the source. We can give you some idea of how each one affects the music, but the only way to really tell is to try them yourself.

- The preset sound modes include modes using surround effects and modes using S.E.A. effects.
- Sound Mode effects cannot be recorded.

Surround effect modes

- D. CLUB (Dance Club)** Increases resonance and bass.
- HALL** Adds depth and brilliance to the sound, like in a concert hall.
- STADIUM** Adds clarity and spreads the sound, like in an outdoor stadium.

S.E.A. effect modes

- ROCK** Boosts low and high frequencies.
- CLASSIC** Set for wide and dynamic sound stereo systems.
- POP** Good for vocal music.

KARAOKE mode

- KARAOKE** The vocal on tapes or CDs is masked for karaoke.

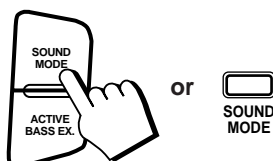

To get an effect, press the SOUND MODE button repeatedly until the Sound Mode you want appears in the display. The frame around the “S.MODE” indicator lights up.

Each time you press the SOUND MODE button, the display changes as shown below:

S.MODE

→ D. CLUB → HALL → STADIUM → ROCK → CLASSIC → POP → KARAOKE → FLAT → (back to the beginning)

To cancel an effect, press the SOUND MODE button until “FLAT” appears on the display. The frame around the “S. MODE” indicator goes out.

S.MODE

To recall the previous Sound Mode, press the SOUND MODE button again.

Listening to Auxiliary Equipment

By playing the sound from auxiliary equipment through the System, you can gain control over how the music or program sounds. Once the connected equipment is playing through the System, you can apply the sound effects.

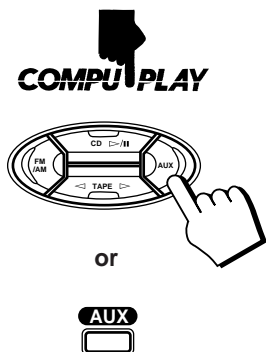

■ First make sure that the optional equipment is properly connected to the System. (See page 5).

1. Set the **VOLUME** control to 0.

2. Press the **AUX** button.

When System is in Standby mode, the Unit is automatically turned on and “AUX” appears on the display.

AUX

3. Start playing the equipment.

4. Adjust the **VOLUME** control to the desired listening level.

5. Select a sound effect mode, if you wish.

To Cancel the Setting

Change the source by starting any one of the System’s built-in sound sources, such as the Tuner or CD Player.

Using the Tuner

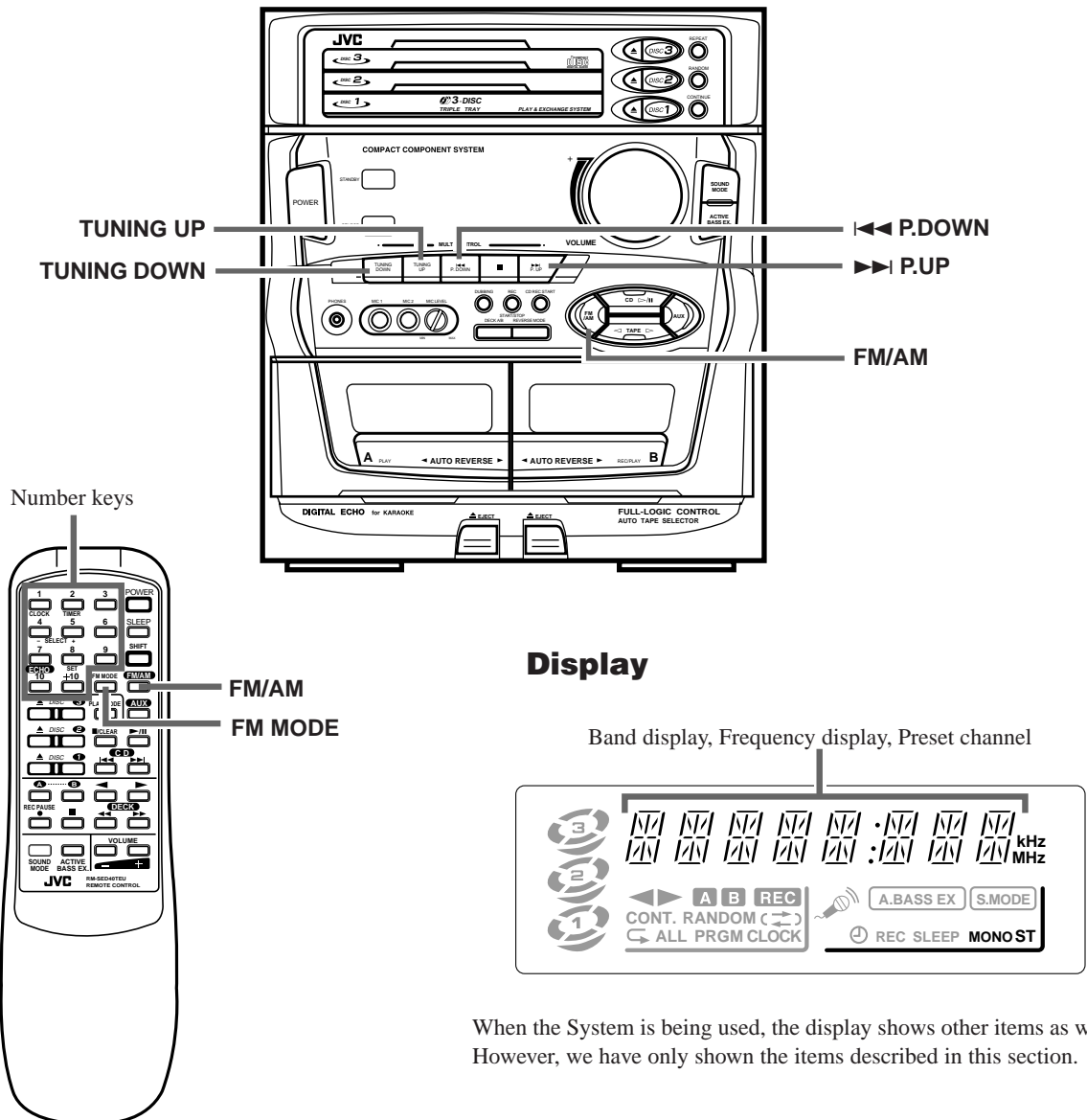

When the System is being used, the display shows other items as well. However, we have only shown the items described in this section.

You can listen to both FM and AM stations. Stations can be tuned in manually, automatically, or from preset memory storage.

■ Before listening to the radio:

- Check that both the FM and AM antennas are firmly connected. (See page 4).

Setting the AM Tuner Interval Spacing

Some countries space AM stations 9 kHz apart, and some countries use 10 kHz spacing. Europe, the U.K., Australia, and some other areas use 9 kHz spacing, while Canada, the United States, and some other Western Hemisphere countries use 10 kHz spacing.

■ When shipped, the System is set to 9 kHz spacing.

In case of Brazil, the System is set to 10 kHz spacing.

■ To select the 10 kHz interval, be sure that the Unit is in STANDBY mode. Turn on by pressing the POWER button while pressing the TUNING UP button on the Unit. "AM --10" appears on the display.

■ To change back to 9 kHz, be sure that the Unit is in STANDBY mode. Turn on by pressing the POWER button while pressing the TUNING DOWN button on the Unit. "AM -- 9" appears on the display.

One Touch Radio

Just press the FM/AM button to turn on the Unit and start playing the most recent station tuned in.

■ You can switch from any other sound source to the radio by pressing the FM/AM button.

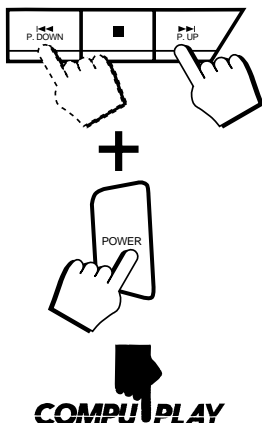

Tuning In a Station

Press the FM/AM button to turn on the radio.
The Frequency of the previously selected channel appears on the display.

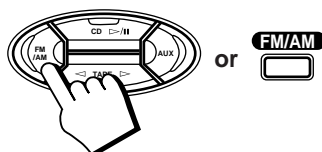

Switching between Frequency Bands

Press the FM/AM button.

Each time you press the button, the band alternates between FM and AM.

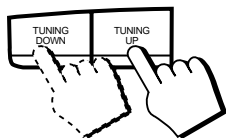

Three ways to select a station

■ Press the TUNING DOWN or TUNING UP button repeatedly to move from frequency to frequency until you find the one you want. (Manual Tuning)

OR

■ Press and hold the TUNING DOWN or TUNING UP button for a few seconds, the frequency starts changing on the display. When a station is tuned in, the frequency stops changing. (Auto Tuning)

OR

■ Possible only after presetting stations.

Press once and release the P. DOWN or P. UP button to go to the next preset station.

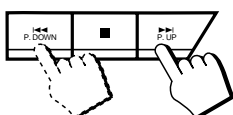

You can also use the Remote Control to tune in preset channels:

1. Press the FM/AM button so that you can receive the most recent station tuned in.
2. Select the station by entering the preset number in the number keys of the Remote Control.
 - Example: for channel 5, press 5. For channel 15, press +10 then 5. For channel 20, press +10, then 10. For channel 30, press +10 twice then 10.

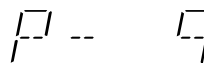

- After you have selected the preset number and the number is displayed, the broadcast frequency of the selected channel is displayed.

Presetting Stations

You can preset up to 30 FM stations and up to 15 AM stations for the preset numbers.

Note: In some cases, test frequencies have been already memorized for the tuner since the factory examined the tuner preset function before shipment. This is not a malfunction. You can preset the stations you want into memory by following the presetting method.

1

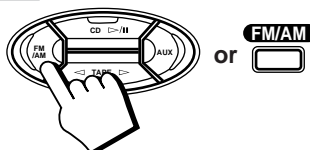

1. Select a band by pressing either the FM/AM button.

2

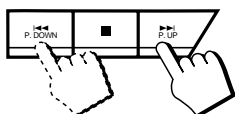

2. Press the TUNING DOWN or TUNING UP button to tune into a station.

3. Setting the preset number by pressing the number keys on the Remote Control continuously.

For preset numbers 1 to 10:

Press the number key for the preset number you want to set.

For preset numbers 11 to 20:

Press the 1 to 10 buttons after pressing the +10 button.

For preset numbers 21 to 30:

Press the 1 to 10 buttons after pressing the +10 button twice.

3

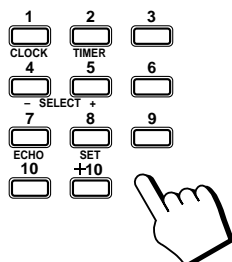

The preset number appears in the display after you have pressed the number keys. If the key is pressed continuously, the preset number display blinks. Release the button after the number starts to blink. This completes the preset setting.

4. Repeat steps 1 - 3 for each station you want to store in memory with a preset number.

CAUTION: If the Unit is unplugged or if a power failure occurs, the preset stations will be erased after a few days. If this happens, preset the station again.

To Change the FM Reception Mode

When an FM stereo broadcast is hard to receive or noisy, press the FM MODE button on the Remote Control so that the "MONO" indicator lights up in the display. Reception improves, but there is no stereo effect.



To restore the stereo effect, press the FM MODE button on the Remote Control so that the "MONO" indicator goes off. In this stereo mode, the "ST" indicator lights up and you can hear stereo effects, when a program is broadcast in stereo.

Using the CD Player

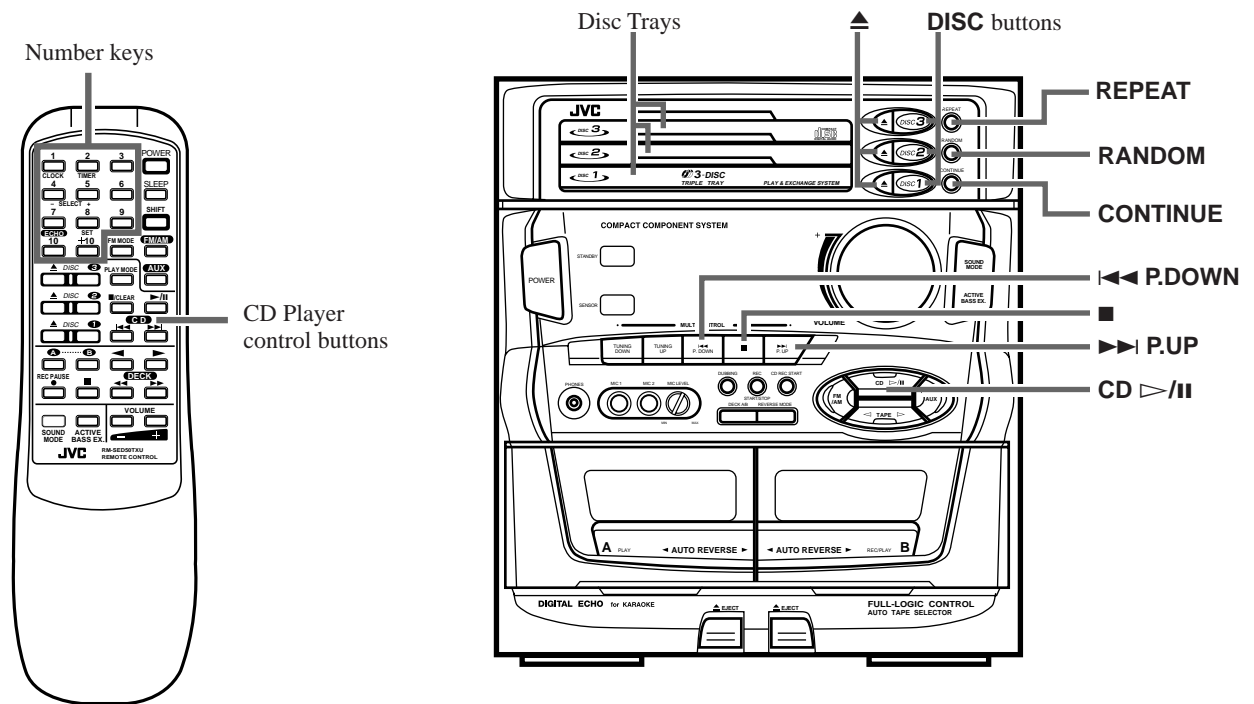

Display

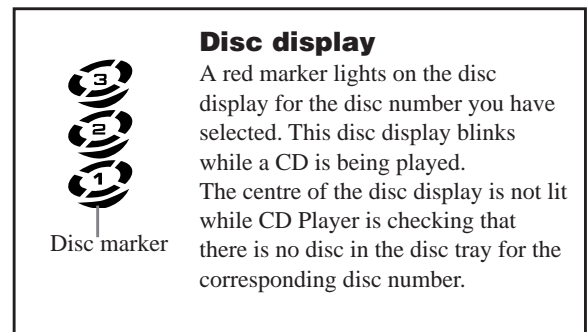
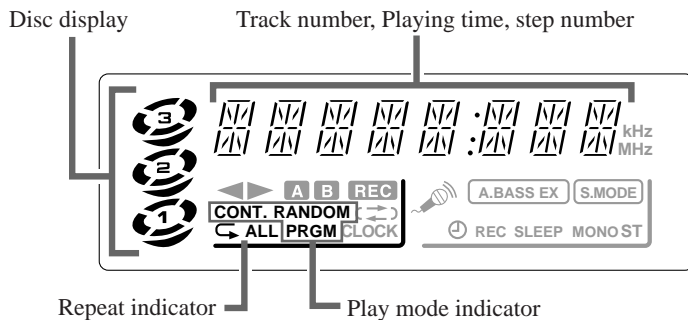

Disc display

A red marker lights on the disc display for the disc number you have selected. This disc display blinks while a CD is being played. The centre of the disc display is not lit while CD Player is checking that there is no disc in the disc tray for the corresponding disc number.

When the System is being used, the display shows other items as well. However, we have only shown the items described in this section.

The System's CD Player has an Automatic Changer with 3 disc trays. You can use Continuous, Random, Program or Repeat Play for the discs in DISC-1, DISC-2 and DISC-3. Repeat Play can repeat all the tracks on all the CD's, the tracks on one of the CD's or one track on one CD. There is also the Tray Lock function, which safely keeps discs in the trays.

Here are the basic things you need to know to play a CD and locate the different selections on it. Each selection is called a track, so when we are talking about locating a track, we are also talking about how you find a certain song or performance.

The Quickest Way To Start a CD Is With the One Touch Operation

■ Press the CD \triangleright /|| button (or the \blacktriangleright /|| button on the Remote Control).

For Normal Play (Play mode indicator is not lit):

- If there is a CD in the disc tray for the selected disc number, the power is automatically turned on and the CD is played from the first track.
- If there is no CD in the disc tray for the selected disc number, the power is automatically turned on and “NO DISC” appears on the display. The CD Player is in stop mode.

For Continuous Play or Random Play in Display mode (CONT. or RANDOM indicator is lit):

- If there is a CD in the disc tray for the selected disc number, the power is automatically turned on and the CD is played continuously from the first track or the tracks are played in random order.
- If there is no CD in the disc tray for the selected disc number, the power is automatically turned on and other tray containing a CD is selected and is played continuously from the first track or the tracks are played in random order.
- If there are no CDs in CD player, the power is automatically turned on and “NO DISC” appears on the display in Normal Play mode. The CD Player is in stop mode.

■ Press a DISC button (1 to 3).

- If there is a CD in the disc tray for the selected disc number, the power is automatically turned on and playback starts from the selected CD.
- If there are no CDs in CD Player, the power is automatically turned on and “NO DISC” appears on the display in Normal Play mode. The CD Player is set to stop mode.

■ Press the \blacktriangle button.

- The power turns on, and the tray opens automatically.

To Insert Discs

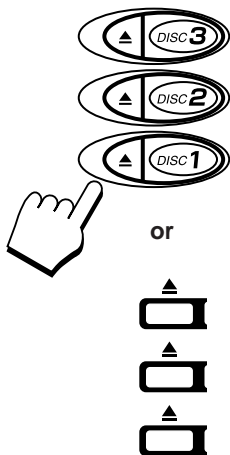

1. Press the \blacktriangle button on the left of the Disc button you want to insert the disc into.

The disc tray slides out automatically.

2. Place a CD, with its label side up, onto the tray.

ATTENTION: To avoid malfunctions when you play a CD, please set the CD in the right place at the centre of the tray.

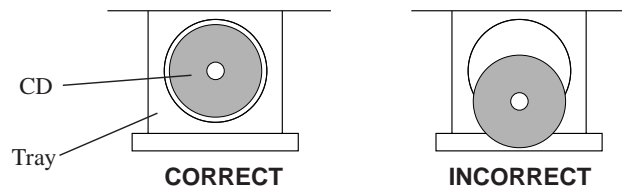

3. Press the \blacktriangle button to close the tray.

4. Repeat steps 1 to 3 to insert other discs into other trays.

- To continue putting discs into other trays, even if a tray is open, by pressing the \blacktriangle button of another disc tray, the open tray will close automatically, and the new disc tray will slide out.

■ To put an 8 cm CD into a tray, insert it so that it is aligned with the groove in the tray's centre.

■ If a tray is open when the System switches to Standby mode, the tray is closed automatically.

Basics of Using the CD Player — Normal Play

To Play a Disc

1. Prepare the discs.

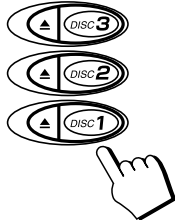
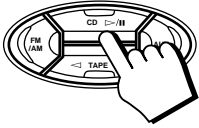

2. Press the CD \triangleright /|| or DISC button (1-3) of the disc you want to play.

When using the Remote Control, press the \triangleright /|| button or the DISC (1 to 3) buttons.

The first track of the selected disc will begin playing.

The CD Player automatically stops when the playback finishes the last track of the CD.

- If these buttons are pressed while the tray is open, the tray is automatically closed and playback starts.

Note: If the CD cannot be read correctly (due to scratches etc.), "00 0000" appears on the display.

To stop playing the disc, press the ■ button (or the ■/CLEAR button on the Remote Control).

To stop playing and removing the disc, press the ▲ button for the disc being played.

To pause, press the \triangleright /|| button (or the \triangleright /|| button on the Remote Control). The Disc display will blink.

To cancel pause, press the \triangleright /|| button again (or press the \triangleright /|| button on the Remote Control). Play continues from the point where it was paused.

To Select a Disc, Track Or Passage Within a Track

1. Press the DISC button (1-3) for the disc tray containing the track you want to listen to.

- Example: for the third disc, press 3.

2. Press the \lll P.DOWN or \ggg P.UP button to select the track.

The selected track starts playing.

Each time you briefly press and release the \lll P.DOWN or \ggg P.UP button, the track changes by one.

- Press and release the \ggg P.UP button to go ahead one track at a time.
- Press and release the \lll P.DOWN button to go back one track at a time.

Holding down the \lll P.DOWN or \ggg P.UP button, during playback, will fast forward/backwards the CD so you can quickly find a particular passage in the selection you are listening to.

When using the Remote Control, press the \lll or \ggg button.

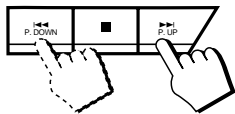

OR



Locating a Track With the Remote Control Directly

Using the number keys on the Remote Control allows you to go directly to the beginning of any track.

1. Press the DISC button (1-3) for the disc tray containing the track you want to listen to.

- Example: for the third disc, press 3.

2. Enter the number of the track you want to listen to with the number keys.

The selected track starts playing.

- Example: for track 5, press 5. For track 15, press +10 then 5. For track 20, press +10, then 10. For track 32, press +10 three times, then 2.

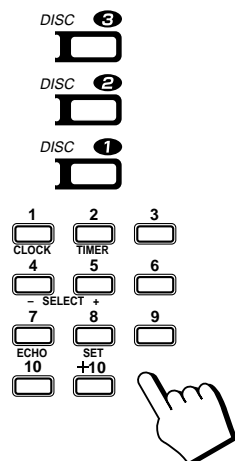

To Change Discs While Playing

You can replace a CD in a tray not being used, while another CD is playing.

1. Press the ▲ button of the tray not being used.

The tray opens.

2. Replace the disc in the tray.

3. Press the ▲ button to close the tray.

Continuous Play

This function plays the disc in the Unit continuously.



- 1. Prepare the discs.**
- 2. Select Continuous mode.**

On the Unit

Press the **CONTINUE** button.

The playback automatically starts from the selected CD.

- “CONT.” on the Play mode indicator lights up.

You can press the CONTINUE button while a CD is playing to switch to Continuous mode.

On the Remote Control

- 1. Press the PLAY MODE button while the CD Player is stopped, to select “CONTINUE”.**

- “CONT.” lights in the Play mode indicator. The display changes with each press of the PLAY MODE button as shown below.



→ PROGRAM → RANDOM → CONTINUE → No display → (back to the beginning)

- 2. Press the DISC button (1 to 3) or ►/|| button.**

Playback starts from the selected CD.

Playing order of the CDs

The selected CDs are played continuously in the following order.

→ DISC 1 → DISC 2 → DISC 3 → (back to the beginning)

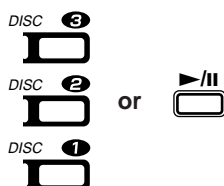

To cancel Continuous play, press the CONTINUE button again. The “CONT.” indicator on the display goes out and Normal Play is resumed. When using the Remote Control, press the PLAY MODE button while the CD Player is stopped to select a different Play mode. The “CONT.” indicator goes out and the next Play mode is selected.

Programming the Playing Order of the Tracks

You can change the order in which the discs and tracks play, and select only the discs and tracks you want from among those loaded in the CD Player.

- You can program up to 20 steps in any desired order from among the discs in the player.
- You can only make a program when the CD Player is stopped.
- Use the Remote Control.



- 1. Press the PLAY MODE button to select “PROGRAM”.**

The display changes with each press of the PLAY MODE button as shown below.

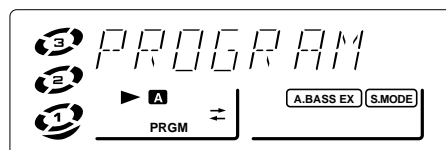

→ PROGRAM → RANDOM → CONTINUE → No display → (back to the beginning)

- The “PRGM” play mode indicator light up.
- If a program is already in progress, the last step of the program is displayed.

- 2. Select a disc with the DISC buttons (1-3).**

The display changes to the Program Entry display.

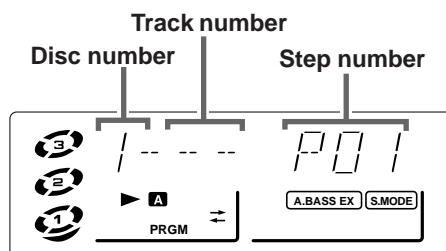

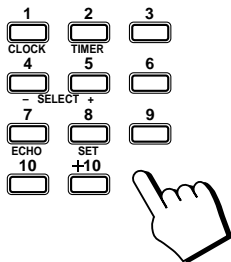

3. Press the number keys (1 to 10 and +10) to select the track to program.

- Example: for track 5, press 5. For track 15, press +10 then 5. For track 20, press +10 then 10.

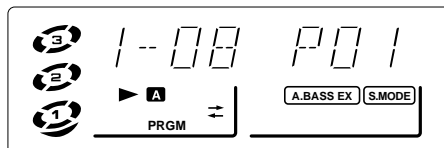

4. Repeat steps 1 to 3 to select the other tracks for the program.

5. Press the ►/|| button.

The Unit plays the tracks in the order you have programmed them.

- If you try to program a disc tray that is empty, or a track number that does not exist on a disc (for example, selecting track 14 on a disc that only has 12 tracks), the selected disc or track are skipped when the program is played.
- You can skip to a particular program step by pressing the ◀◀ or ▶▶ button during program play.
- To play the programmed tracks over and over, press the REPEAT button . The Repeat mode indicators light up in sequence with each press of the REPEAT button.

To stop playing, press the ■ button (or the ■/CLEAR button on the Remote Control) once.

To delete all the tracks in a program, press the ■ button on the Unit or the ■/CLEAR button on the Remote Control while the CD Player is stopped. The program is deleted and the “PRGM” play mode indicator goes out and Normal Play is resumed.

To cancel program play, press the PLAY MODE button on the Remote Control while the CD Player is stopped to select a different Play mode. The “PRGM” indicator goes out and the next Play mode is selected.

Note: If you press the CONTINUE or RANDOM button on the unit while a program is playing, the play mode changes to that mode.

Random Play

The tracks will play in no special order when you use this mode.

On the Unit

Press the RANDOM button.

The playback automatically starts from the selected CD.

- “RANDOM” on the Play mode indicator lights up.

You can press the RANDOM button while a CD is playing to switch to Random play mode.

On the Remote Control

1. Press the PLAY MODE button while the CD Player is stopped, to select “RANDOM”.

- “RANDOM” lights in the Play mode indicator.

The display changes with each press of the PLAY MODE button as shown below.

→ PROGRAM → RANDOM → CONTINUE → No display → (back to the beginning)

2. Press the ►/|| button.

Playback starts from the selected CD.

Note: Random Play cannot be activated with the DISC button (1 to 3).

To skip to the next track, press the ▶▶ button during playback. The next track is jumped to with each press of the button. Press the ◀◀ button to jump to the start of the track being played.

- Press the REPEAT button before or during random play to instruct the System to continue with a different random track selection after the last selection is played.

To cancel random play, press the RANDOM button again. The “RANDOM” play mode indicator goes out and Normal Play is resumed. When using the Remote Control, press the PLAY MODE button while the CD Player is stopped to select a different Play mode. The “RANDOM” indicator goes out and the next Play mode is selected.



Repeating a Selection or the Discs

You can have all the discs, the program or the individual selection currently playing repeat as many times as you like.



Press the REPEAT button.

The display changes with each press of the button, as shown below.

→ → ALL → blank display → (back to the beginning)

- : Repeats one track on a CD.
- ALL: For Normal Play, repeats all the tracks on the current CD.
For Continuous Play or Random Play, repeats all the tracks on all the CDs in the CD Player.
For Program Play, repeats all the tracks in the program.

To exit Repeat Mode, press the REPEAT button until the Repeat mode indicator on the display goes out.

Tray Lock Function

In order to safely keep the discs in the CD Player, the three trays can be electronically locked in a single operation.

When the electronic lock is on, the trays cannot be opened even if the button is pressed.

This function can only be accessed by using the buttons on the Unit itself.

Locking the Electronic Lock

1. Put the System's power into STANDBY mode.
2. While pressing the button, press the button for DISC 1's tray on the Unit.

"LOCK ON" appears on the display to let you know that the trays have been locked.

LOCK ON

When the CD Player trays are locked, pressing the buttons displays the message "LOCK ON" on the display and the trays do not open. Also, the button cannot be used to automatically turn on the power.

Unlocking the Electronic Lock

1. Put the System's power into STANDBY mode.
2. While pressing the button, press the button for DISC 1's tray on the Unit.

When the unlock operation is done, "LOCK OFF" appears in the display to show that the lock has been taken off.

LOCK OFF

The trays can now be opened by pressing the buttons.

The button can also be used to automatically turn on the power.

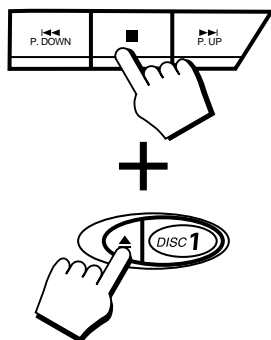

Using the Cassette Deck (Listening to a Tape)

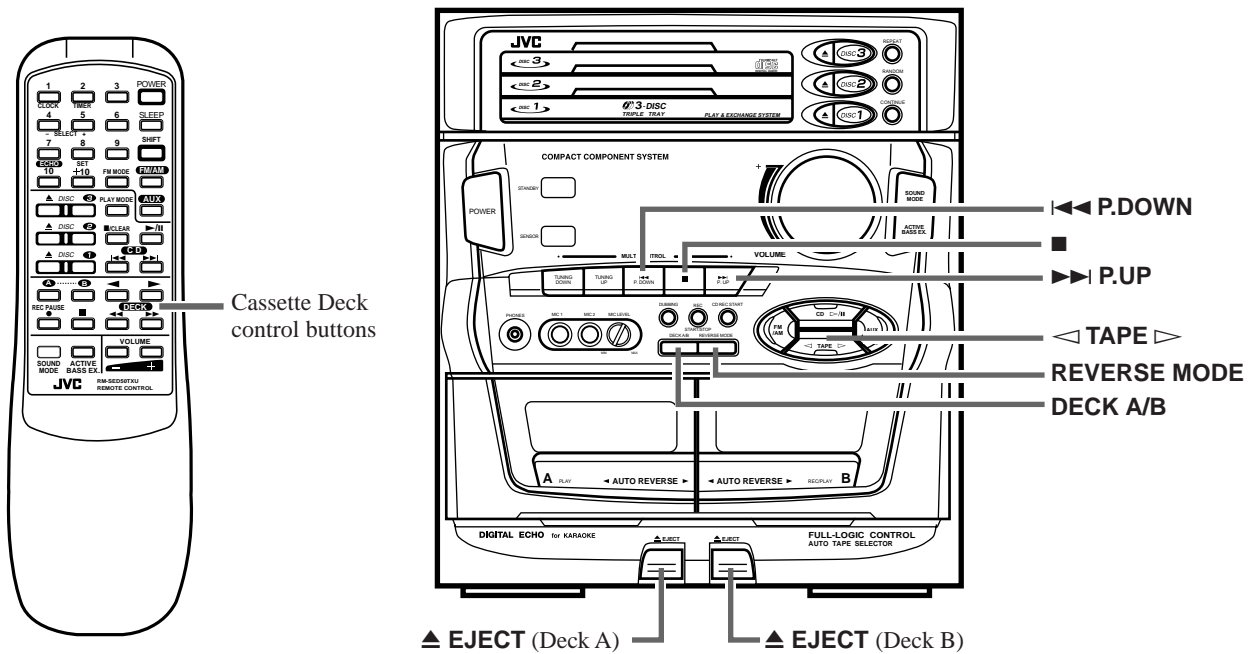

Display



- ◀▶ : Tape Direction indicator
 A B : DECK A, B indicator
 ◀▶ : Reverse Mode indicator

Tape Direction Indicator on the Display

The Tape Direction indicator tells you which direction the selected tape deck will use for playback. During playback, the direction indicator blinks slowly. During fast left or fast right, the indicator blinks quickly. During Music Scan mode, the direction indicator alternates between blinking slowly and quickly repeatedly.

When the System is being used, the display shows other items as well. However, we have only shown the items described in this section.

The Cassette Deck allows you to play, record and dub audio tapes.

■ With Automatic Tape Detection, you can listen to type I or II tapes without changing any settings.

The use of tapes longer than 120 minutes is not recommended, since characteristic deterioration may occur and these tapes easily jam in the pinch-rollers and the capstans.



One Touch Play

By pressing the ◀ TAPE ▶ button (or the ◀ or ▶ button on the Remote Control), the Unit will come on, "TAPPE" appears in the display, and if a tape is in the deck, it will start to play. If no tape is loaded, the Unit will come on and wait for you to insert a tape, or select another function.

Regular Play

When the power is already on, you can use this basic procedure:

1. Press the ▲ EJECT button for the deck you want to use.
2. When the cassette holder opens, put the cassette in, with the exposed part of the tape down, toward the base of the System.
 - If the cassette holder does not open, turn the Unit off, then back on and press the ▲ EJECT button again.

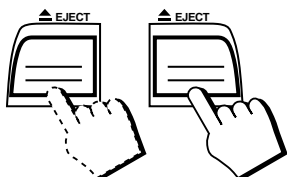

3. Close the holder gently.

When both Deck A and Deck B contain a tape, the last deck to have a tape inserted is selected. To change the selected deck, press the DECK A/B button. When using the Remote Control, press the A or B button.

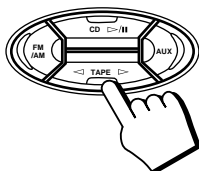
**4. Press the < TAPES > button (or < or > button on the Remote Control).**

The tape is played in the direction of the button pressed for the selected deck.

- The Cassette Deck automatically stops when one side of a tape has finished playing.

To stop playing, press the ■ button.

To remove the tape, stop the tape, and press the ▲ EJECT button.

To change deck while playing a tape, press the < TAPES > button after pressing the DECK A/B button on the Unit or press the < or > button after pressing the A or B button on the Remote Control.

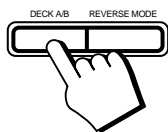
**Fast Left And Fast Right**

■ While the tape is stopped, press the <<< P.DOWN button (or <<< button on the Remote Control) and the tape will wind rapidly onto the left side of the cassette without playing.

■ While the tape is stopped, press the >>> P.UP button (or >>> button on the Remote Control) and the tape will wind rapidly onto the right side of the cassette without playing.

Note: Deck A and Deck B cannot be used for playback at the same time.

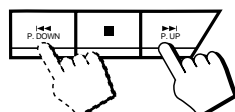
**Music Scan**

To find the beginning of a music track during play, use the Music Scan function. Music Scan searches for blank portions that usually separate selections, then plays the next selection.

To Find the Beginning of the Current Selection

Press the <<< P.DOWN or >>> P.UP button (or the << or >> button on the Remote Control) during play.

■ Make sure that you press the <<< P.DOWN or >>> P.UP button (or the << or >> button on the Remote Control) in the opposite direction to that in which the tape is playing. Searching stops at the beginning of the current selection, and the current selection starts automatically.

To Find the Beginning of the Next Selection

Press the <<< P.DOWN or >>> P.UP button (or the << or >> button on the Remote Control) during play.

■ Make sure that you press the <<< P.DOWN or >>> P.UP button (or the << or >> button on the Remote Control) in the same direction as that in which the tape is playing. Searching stops at the beginning of the next selection, and the next selection starts automatically.

Music Scan works by detecting a 4-second long blank at the beginning of each selection, so it won't work well if your tape has:

- No blank at the beginning of a selection .
- Noise (often caused by much use or poor quality dubbing) which fills the blank with noise.
- Long, very soft passages or pauses in a selection. The scan will detect these as 4-second long blanks. If this happens, just scan again until you reach the selection you want.

Reverse Mode

You can play both sides of a cassette, or play both the tapes in the two Cassette Decks continuously.

Press the REVERSE MODE button to switch to Reverse Mode.

The indicator changes with each press of the button as shown.

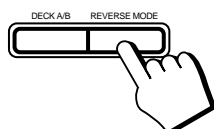

→ ⇄ → ⇄ → (⇄) → (back to the beginning)

⇄ : The Cassette Deck automatically stops after playing one side of the tape.

⇄) : The Cassette Deck automatically stops after playing both sides of the tape being played (or set to play).

(⇄) : After playing both sides of the tape being played (or set to play), the Unit always checks to see if a tape is in the other deck. If there is, it automatically starts playing that tape. This Continuous Play function works regardless of which deck starts first. The tapes are played continuously until the ■ button is pressed.

Using the Cassette Deck (Recording)

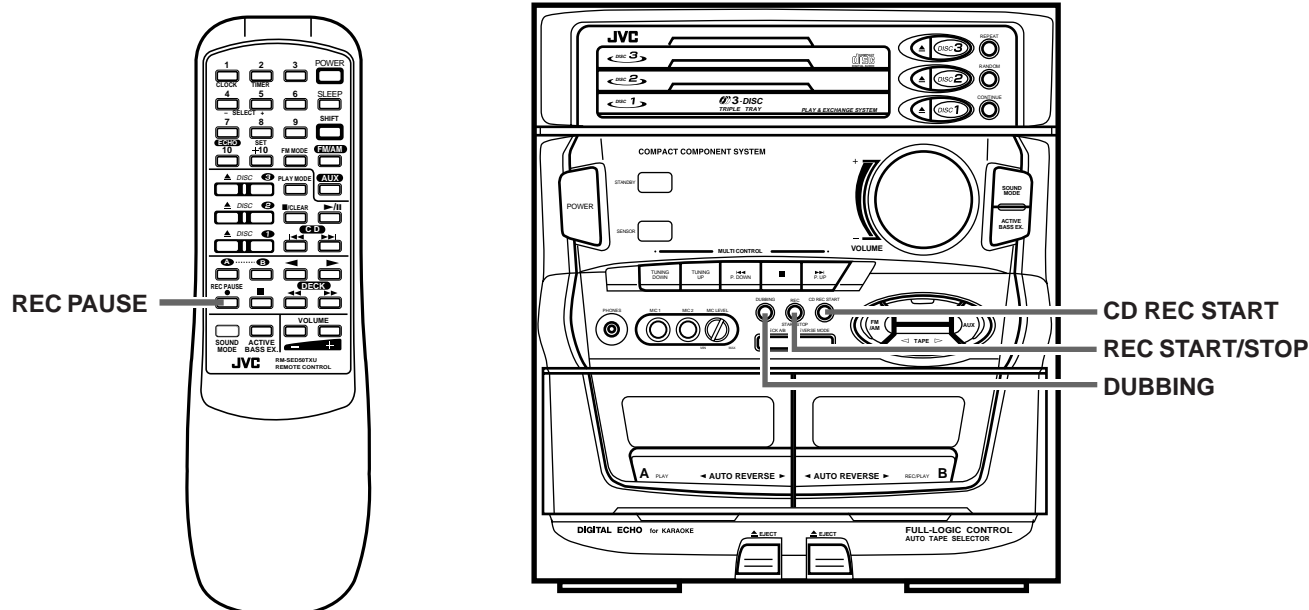

Display

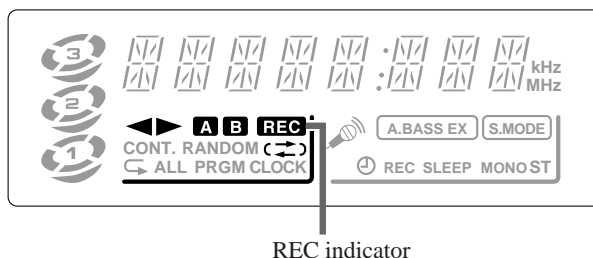

REC indicator

When the System is being used, the display shows other items as well. However, we have only shown the items described in this section.

Recording onto a cassette from any of the sound sources is simple. Just place a tape in Deck B, have the source ready, make one or two settings, and you're ready to record. For each source the procedure is a little bit different and now we'll explain just what to do for each one. If you forget, just come back to the section which has the specific procedures you need. But first, here are a few things to make your recordings better.

Things To Know Before You Start Recording

- It may be unlawful to record or play back copyrighted material without the consent of the copyright owner.
- When you want to record onto both sides of a tape, you can set Reverse mode on to do so. However, recording automatically stops after recording in the ◀ direction in Reverse mode. Therefore, make sure that the tape direction is ▶ when recording with Reverse mode on.
- The recording level, which is the volume at which the new tape is being made, is automatically set correctly, so it is not affected by the VOLUME control on the System. Thus, during recording you can adjust the sound you are actually listening to without affecting the recording level.
- Two small tabs on the back of the cassette tape, one for side A and one for side B, can be removed to prevent accidental erasure or re-recording. To record on a cassette with the tabs removed, you must cover the holes with adhesive tape first. However, when a type II tape is used, only cover part of the hole as shown, since the other part of the hole is used to detect the tape type.
- When recording, you can hear Sound Mode effects through the speakers or headphones. However, the sound is recorded without Sound Mode effects.
- Type I and Type II tapes can be used for recording.

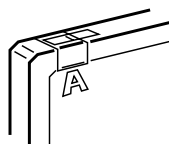

Note: At the start and end of cassette tapes, there is leader tape which cannot be recorded onto. Depending on the recording source, the first part of the recording may be missing because of the leader. When recording CDs or radio broadcasts, to get the beginning of the recording on the tape, first wind on the leader before beginning recording.

CAUTION: If recordings you have made have excessive noise or static, the Unit may be too close to a TV which was on during the recording. Either turn off the TV or increase the distance between the TV and the System.

Standard Recording

This is the basic method for recording any source. The System also has special ways for recording CD to tape, and tape to tape, which save you time and effort, as well as give you some special effects. However, when you need to add a selection to a tape you have made, or are combining selections from several sources on one tape, use the method described below; just substitute the source you want into this procedure, such as a tape in Deck A, a CD, or the Tuner. You can also record from auxiliary source with this procedure.

To Record Any Sound Source To Tape

Follow these steps to record from any sound source onto a tape in Deck B.

Using the Unit

1. Insert a blank or erasable tape into Deck B.

2. Press the REVERSE MODE button if you want to record on both sides of the tape.

Press the button until the “↔” or “↔” indicator is lit.

- When using Reverse Mode, insert the tape so that it will be recorded in the forwards ► direction.

3. Check the recording direction for the tape.

Check that the Tape Direction indicator is the same as that for the tape in the tape deck. If the directions are different, press the ■ button after pressing the < TAPE > button to set the tape direction.

- When using Reverse Mode to record both sides of a tape, check that the Tape Direction indicator is in the forwards ► direction. If the direction indicator is not in the forwards ► direction, press the < TAPE > button then press the ■ button.

4. Prepare the source, by, for example, tuning in a radio station, loading CDs, or turning on connected equipment.

5. Press the REC START/STOP button.

The “REC” indicator light comes on and the System begins recording.



Using the Remote Control

1. Insert a blank or erasable tape into Deck B.

2. Press the REC PAUSE button.

The “REC” indicator blinks.

3. Press the REVERSE MODE button on the Unit if you want to record on both sides of the tape.

Press the button until the “↔” or “↔” indicator is lit.

- When using Reverse Mode, insert the tape so that it will be recorded in the forwards ► direction.

4. Prepare the source by, for example, tuning in a radio station, loading CDs, or turning on connected equipment.

5. Press the ◀ or ▶ button.

Recording starts in the direction of the button pressed.

- When using Reverse Mode to record both sides of a tape, press the ► button.



Notes for using Reverse Mode for recording

When recording in Reverse Mode, the System automatically stops when it reaches the end of the reverse ◀ direction. To record on both sides of a tape, make sure that the recording direction for the tape inserted into Deck B is forwards ►, and that the Tape Direction indicator is also forwards ►, before you start recording.

To Pause at Any Time During the Recording Process

Press the REC PAUSE button on the Remote Control. Then press either the ◀ or ▶ button on the Remote Control or REC START/STOP button on the Unit to restart recording.

To Stop at Any Time During the Recording Process

Press the REC START/STOP button on the Unit again, or press the ■ button.



Recording AM station to tape

When recording an AM broadcast, beats may be produced which are not heard when listening to the broadcast. In this case, press the CONTINUE button on the CD Player to eliminate the beats.

1. Set to AM station and start recording.
2. Press the CONTINUE button to eliminate the beats.

Each time you press the button, the display changes as shown below:

→ CUT 2 → CUT 3 → CUT 1 → (back to the beginning)

CD Direct Recording

Everything on the CD goes onto the tape in the order it is on the CD, or according to the order you have set in a program.

1. Prepare CDs. (See page 13.)

Check that the CD Player is not playing a CD.

2. Insert a cassette in Deck B to record on.

- When you want to record on both sides of a tape, press the REVERSE MODE to turn Reverse Mode on. Check that the recording direction for the tape and the Tape Direction indicator is correct. (See page 21 “Notes for using Reverse Mode for recording”.)



3. Press the CD REC START button.

The “REC” indicator light comes on and the System begins recording.

If you make a recording with Reverse Mode on, the Unit will record the last song at the end of the first side at the beginning of the next side.

To stop at any time during the recording process, press the ■ button.

Note: When making SLEEP timer settings while doing CD Direct recording, set the time so that there is enough leeway to finish the recording before the power goes off. If the time is set to about the length of the CD, the power may go off before recording finishes.

For CD Direct Recording using more than one disc, use a blank tape. If you use a prerecorded tape, prerecorded material may not be erased between newly-recorded tracks.

Tape to Tape Recording (Dubbing)

Recording from one tape to another is called dubbing.

You can dub tapes simply, with just a single button.

- When dubbing tapes, make sure that the playback direction of Deck A and Deck B are the same.
- When you want to record both sides of a tape, press the REVERSE MODE button to turn Reverse mode on.
- It is preferable that the type of tape (Type I or Type II) you record from be the same as the type you record onto.

How to Use the DUBBING Button

1. Insert the source cassette you want to copy from into Deck A for playback.

Insert the cassette so that it will be played in the forwards ▶ direction.

2. Insert the blank or erasable cassette you want to copy onto into Deck B for recording.

Insert the cassette so that it will be recorded in the forwards ▶ direction.

3. Press the DUBBING button.

Deck A and Deck B will start simultaneously.



To stop dubbing, press the ■ button or REC START/STOP button.

- When doing dubbing with the DUBBING button, you can hear Sound Mode effects through the speakers or headphones. However, the sound is dubbed without Sound Mode effects.

Using the Timer

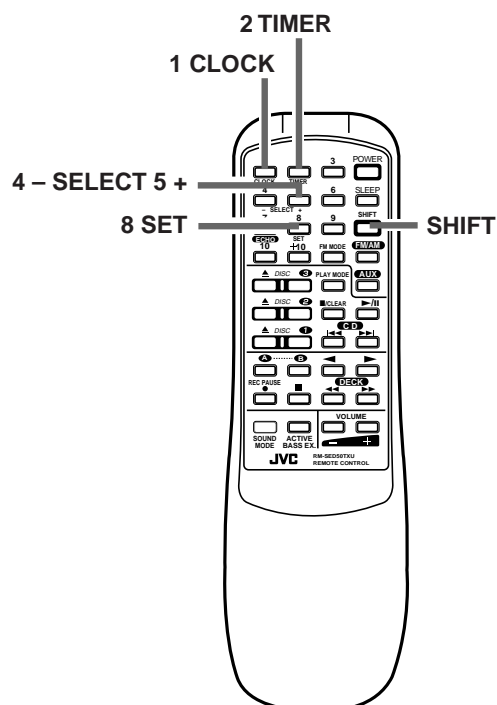

Display

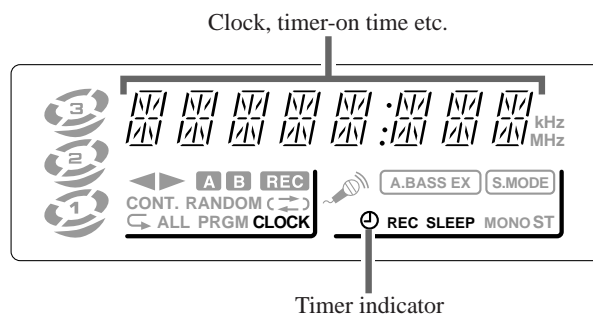

When the System is being used, the display shows other items as well. However, we have only shown the items described in this section.

The timers lets you control listening and recording functions automatically.
Use the Remote Control to set the clock and timers.

Setting the Clock

The timers depend on the clock: the clock must be right for the timers to work as you expect. You can set the clock whether the Unit is on or off.

Note that the clock must be set, otherwise the timers cannot be set.

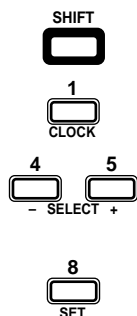

1. Press the SHIFT button.

2. Press the 1 CLOCK button.

The "CLOCK" indicator on the display light up and the clock time blinks.

3. Press the SELECT 5 + or 4 - button to set the time.

Pressing the 5 + button increases the time and pressing 4 - decreases the time. Pressing the button continuously advances or decreases the time in 10 minute intervals.

4. Press the 8 SET button.

The blinking time display changes from a blinking display to a steady display and the clock timer starts from 0 seconds.

CAUTION: If there is a power failure, the clock loses its setting. The display shows "0:00", and the clock must be reset.

Setting the Timer

■ You can set the Timer whether the Unit is on or off.

Procedure For Setting the Timer



1. Press the **SHIFT** button.

2. Press the **2 TIMER** button.

The Timer indicator on the display lights up and the blinking “TIMER ON” changes to the On Time setting display.

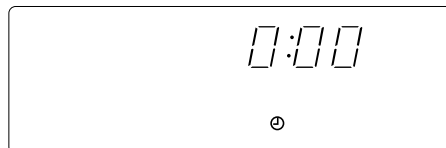
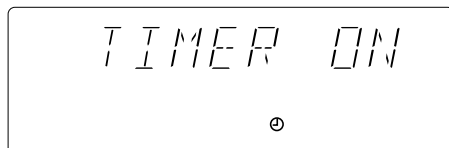

3. Set the time you want the Unit to come on.

Press the SELECT 5 + or 4 – button to set the On Time.

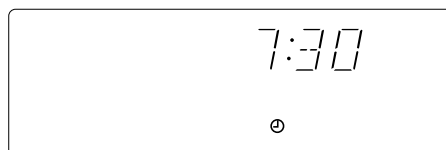

4. Press the **8 SET** button.

“TIMER OFF” blinks on the display, and the display changes to the Off Time setting display.

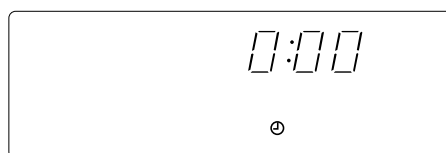

5. Set the time you want the Unit to be turned off.

Press the SELECT 5 + or 4 – button to set the Off Time.

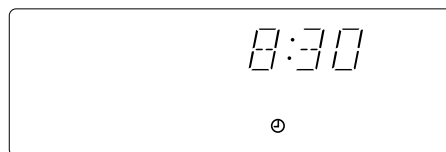

6. Press the **8 SET** button.

The name of the source blinks in the display.



7. Press the **SELECT 5 + or 4 –** button to select the source.

The display changes with each press of the button as shown.

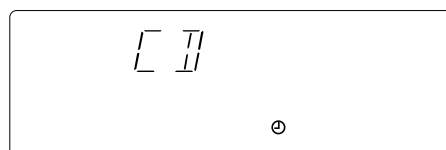

↔ TUNER ↔ TUNER REC ↔ CD ↔ TAPE ↔

TUNER: Selects the last station you were listening to.
TUNER REC: Records the last station you were listening to.
CD: Plays the last CD you were listening to.
TAPE: Plays the last tape you were listening to.

- In the source “TUNER”, “CD”, or “TAPE”, the timer acts as a Daily timer. Once the Daily timer has been set, it will be activated at the same time every day until the setting is turned off. In the source “TUNER REC”, the timer acts as a Once timer. After the Once timer has been performed, the details of the setting remain stored but the Timer status is set to off.



8. Press the 8 SET button.

The volume level blinks on the display.



9. Press the SELECT 5 + or 4 - button to set the volume level.

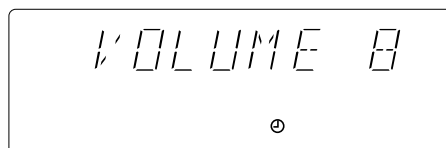

10. Press the 8 SET button.

The display returns to the display before you set the timer.

Before Turning the Unit Off

- Check that the selected source is ready.
- If you will be recording a source while you are out, set the volume to 0.

To turn the Timer off, press the 2 TIMER button while pressing the SHIFT button. The Timer indicator on the display goes out.

Setting the SLEEP Timer

Use the Sleep Timer to turn the Unit off after a certain number of minutes when it is playing. By setting this timer, you can fall asleep to music and know your Unit will turn off by itself rather than play all night.

- You can only set the Sleep Timer when the Unit is on and a source is playing.

To set the SLEEP Timer, follow this procedure:



1. With the System on and a source playing, press the SLEEP button on the Remote Control.

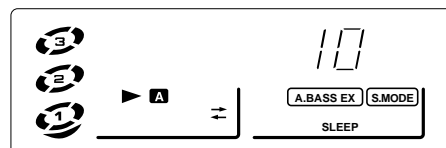

2. Set the length of time you want the source to play before shutting off.

- Each time you press this button, it changes the number of minutes shown on the display in this sequence:

→ 10 → 20 → 30 → 60 → 90 → 120 → Cancelled → (back to the beginning)

When the number of minutes you want shows on the display, just wait 5 seconds until the number of minutes stops blinking, and is lighted steadily.

The Unit is now set to turn off after the number of minutes you set.

To Change the SLEEP Timer Setting

Press the SLEEP button until the number of minutes you want appears on the display.

To Cancel the SLEEP Timer Setting

Press the SLEEP button until the "SLEEP" indicator goes off on the display.

Turning off the Unit also cancels the SLEEP Timer.

Using the Microphone

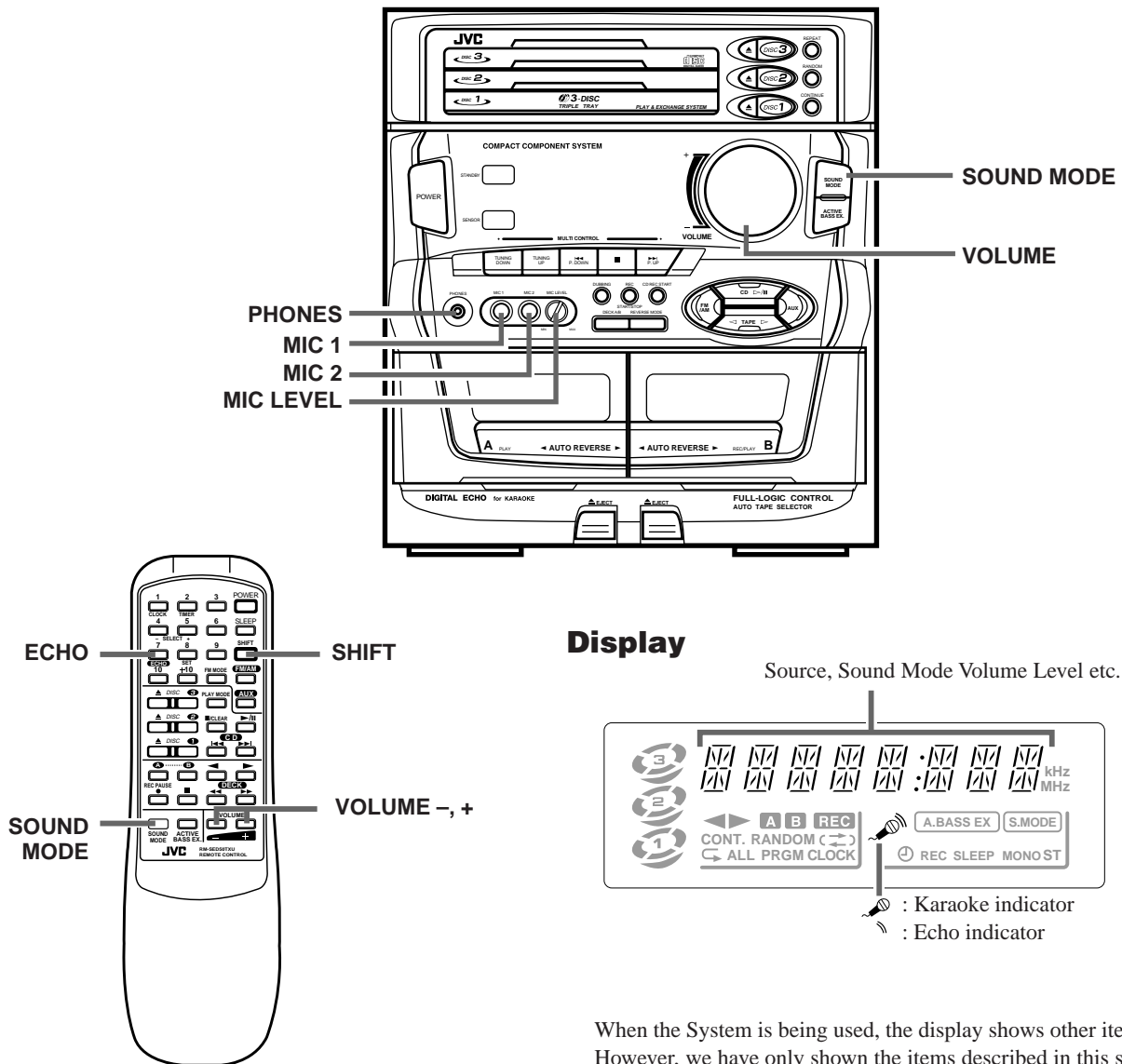

When the System is being used, the display shows other items as well. However, we have only shown the items described in this section.

The System includes two microphone terminals, MIC 1 and MIC 2. By attaching a microphone to one or both of these terminals, you can use the System for Karaoke or microphone mixing. You can also add an echo to the microphone's sound.

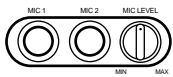

- The MIC LEVEL control adjusts the volume for both MIC 1 and MIC 2 at the same time.
- When you will not be using the microphone, keep the MIC LEVEL control set to MIN, and disconnect the microphone.

CAUTION: Always set the MIC LEVEL control to MIN when connecting or disconnecting the microphone.

Karaoke (Sing Along)

The Vocal Masking function lets you use regular tapes, CDs, or records as sources for Karaoke. When you select Karaoke mode, the lead vocal volume of the source is reduced, and you can replace it by singing into the microphones as the music plays.

Singing Along with Karaoke

1. Turn the MIC LEVEL control to MIN.
2. Connect the microphone (not supplied) by plugging it into the MIC jack on the front panel.

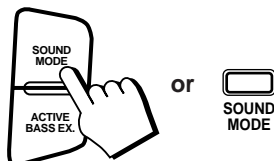

3. Press the **SOUND MODE** button repeatedly until “**KARAOKE**” appears in the display.

The “” indicator comes on.

4. Start the source CD, tape or other equipment.

5. Adjust the **VOLUME** control and the **MIC LEVEL** control, as you sing into the microphone.

Important Information on Karaoke

- Because a radio signal is not as reliable as signals coming from a tape or CD, you may not always get satisfactory results using the radio as a source for Karaoke.
- Some tapes and CDs are better sources for Karaoke than others.
 - Mono sources are not suitable for Karaoke.
 - The lead vocals may not be completely reduced for sources with duets, strong echo, a chorus, or only a few instruments.
 - Poorly dubbed tapes may not be suitable for Karaoke.

Digital Echo

You can get an echo effect to apply to your voice.

1. Press the **SHIFT** button on the Remote Control.

2. Press the **7 ECHO** button on the Remote Control.

The Echo indicator comes on.

No echo is applied.



An echo is applied.



To prevent howling and squealing (feedback) when using the microphone, adjust the MIC LEVEL control and the VOLUME control. Also, try to avoid pointing the microphone towards the speakers.

- When two microphones are connected, turn the microphone ON/OFF switch for the microphone that is not being used to OFF.
- When recording sound from the microphone, the digital echo effect is also recorded.

To Record Your Singing

1. Follow the steps in “Singing Along with Karaoke” above.

2. Follow the steps in “Standard Recording” (See page 21) to record your singing.

Microphone Mixing

When using special Karaoke sources for karaoke, use the following procedure.

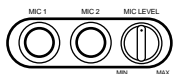

- 1. Set the MIC LEVEL control to MIN.**
- 2. Connect the microphone (not supplied) by plugging it into the MIC jack on the front panel.**
- 3. Start the source CD, tape, or other equipment.**
- 4. Adjust the VOLUME control and the MIC LEVEL control, as you sing into the microphone.**

To apply echo to the microphone sound, follow the steps in “Digital Echo”. (See page 27.)

To Record Microphone Mixing _____

- 1. Follow the steps in “Microphone Mixing” above.**
- 2. To record, follow the steps in “Standard Recording”. (See page 21.)**

Playing the Microphone Sound through the Speakers

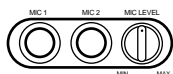

- 1. Set the MIC LEVEL control to MIN.**
- 2. Connect the microphone (not supplied) by plugging it into the MIC jack on the front panel.**
- 3. Adjust the VOLUME control and the MIC LEVEL control as you sing into the microphone.**

To apply echo to the microphone sound, follow the steps in “Digital Echo”. (See page 27.)

Recording from the Microphone _____

- 1. Follow the steps in “Playing the Microphone sound through the Speakers” above.**
- 2. To record, follow the steps in “Standard Recording”. (See page 21.)**

Care And Maintenance

Compact Discs

Handle your compact discs, cassette tapes, and Cassette Deck carefully, and they will last a long time.



- Remove the CD from the case by holding it at the edges while pressing the centre hole lightly.
- Do not touch the shiny surface of the CD, or bend the CD.



- Put the CD back in its case after use to prevent warping.
- Be careful not to scratch the surface of the CD when placing it back in the case.
- Avoid exposure to direct sunlight, temperature extremes, and moisture.



- A dirty CD may not play correctly. If a CD does become dirty, wipe it with a soft cloth in a straight line from centre to edge.

CAUTION: Do not use any solvent (for example, conventional record cleaner, spray thinner, benzene, etc.) to clean a CD.

Moisture Condensation



Moisture may condense on the lens inside the Unit in the following cases:

- After starting the heating in the room.
- In a damp room.
- If the unit is brought directly from a cold to a warm place.

Should this occur, the Unit may malfunction. In this case, leave the unit turned on for a few hours until the moisture evaporates, unplug the AC power cord, and then plug it in again.

General Notes

In general, you will have the best performance by keeping your tapes, CDs, and the mechanism clean.

- Store tapes and CDs in their cases, and keep them in cabinets or on shelves.
- Keep the Cassette Deck's tape doors and the CD trays closed when not in use.

Cassette Tapes

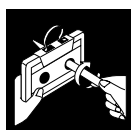

- If the tape is loose in its cassette, take up the slack by inserting a pencil in one of the reels and rotating.
- If the tape is loose, it may get stretched, cut, or caught in the cassette.



- Do not touch the tape surface.



- Do not store the tape:
 - In dusty places
 - In direct sunlight or heat
 - In moist areas
 - On a TV or speaker
 - Near a magnet

Cassette Deck

- If the heads, capstans, and pinch-rollers of the Cassette Deck become dirty, the following will occur:
 - Loss of sound quality
 - Discontinuous sound
 - Fading
 - Incomplete erasure
 - Difficulty recording
- Clean the heads, capstans, and pinch-rollers using a cotton swab moistened with alcohol.

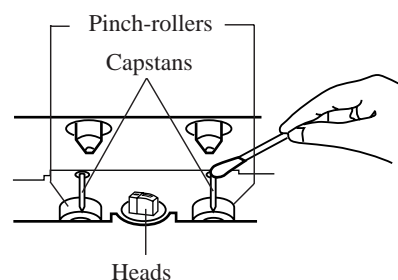

- If the heads become magnetized, the Unit will produce noise or lose high frequencies.
- To demagnetize the heads, turn off the Unit, and use a head demagnetizer (available at electronics and record shops).

Troubleshooting

- If you are having a problem with your System, check this list for a possible solution before calling for service.
- If you cannot solve the problem from the hints given here, or the Unit has been physically damaged, call a qualified person, such as your dealer, for service.

Symptom	Possible Cause	Action
No sound is heard.	Connections are incorrect, or loose.	Check all connections and make corrections. (See pages 4 - 5.)
Unable to record.	Cassette record protect tabs are removed.	Cover holes on back edge of cassette with tape.
Poor radio reception	<ul style="list-style-type: none"> • The antenna is disconnected. • The AM Loop Antenna is too close to the Unit. • The FM Wire Antenna is not properly extended and positioned. 	<ul style="list-style-type: none"> • Reconnect the antenna securely. • Change the position and direction of the AM Loop Antenna. • Extend FM Wire Antenna to the best reception position.
The CD skips.	The CD is dirty or scratched.	Clean or replace the CD.
Unable to operate the Remote Control.	<ul style="list-style-type: none"> • The path between the Remote Control and the sensor on the Unit is blocked. • The batteries have lost their charge. 	<ul style="list-style-type: none"> • Remove the obstruction. • Replace the batteries.
The CD tray cannot be opened.	The main AC power cord is not plugged in.	Plug in the AC power plug.
The CD does not play.	The CD is upside down.	Put the CD in with the label side up.
Operations are disabled.	The built-in microprocessor has malfunctioned due to external electrical interference.	Unplug the Unit then plug it back in.
The cassette door cannot be opened.	During tape playing, the power cord was unplugged.	Plug in the power cord, press the POWER button, and then press the ▲ EJECT button.

Specifications

Amplifier

CA-D501T/MX-D401T

Output Power (IEC 268-3/DIN) 27 watts per channel, min. RMS, both channels driven into 6 ohms at 1 kHz with no more than 0.9% total harmonic distortion.

MX-D301T

Output Power (IEC 268-3/DIN) 12 watts per channel, min. RMS, both channels driven into 4 ohms at 1 kHz with no more than 0.9% total harmonic distortion.

Input Sensitivity/Impedance (1 kHz)

AUX 300 mV/50 kohms

MIC 1 3 mV/2 kohms

MIC 2 3 mV/2 kohms

CA-D501T/MX-D401T

Speaker terminals 6 - 16 ohms

MX-D301T

Speaker terminals Minimum 4 ohms

Cassette Deck

Frequency Response

Type II (CrO₂) : 50 - 14,000 Hz

Type I (NORMAL) : 50 - 14,000 Hz

Wow And Flutter 0.15% (WRMS)

CD Automatic Changer

CD Capacity 3 discs

Dynamic Range 85 dB

Signal-To-Noise Ratio 90 dB

Wow And Flutter Unmeasurable

Tuner

FM Tuner

Tuning Range 87.5 - 108.0 MHz

AM Tuner

Tuning Range 531 - 1,602 kHz (at 9 kHz channel space)

530 - 1,710 kHz (at 10 kHz channel space)

CA-D501T/MX-D401T

Dimensions (W/H/D) 265 × 295 × 339 mm
(10-7/16 × 11-5/8 × 13-3/8 inches)

Mass 7.1 kg (15.7 lbs)

MX-D301T

Dimensions (W/H/D) 265 × 295 × 339 mm
(10-7/16 × 11-5/8 × 13-3/8 inches)

Mass 6.7 kg (14.8 lbs)

Speaker Specifications

SP-D401

Type 3- way, 3-speaker bass-reflex type

Speakers

Woofer 16 cm (6-5/16 inches) cone × 1

Mid Range 5 cm (2 inches) cone × 1

Tweeter 2 cm (13/16 inches) dome × 1

Power Handling Capacity 80 watts

Impedance 6 ohms

Frequency Range 45 Hz - 20,000 Hz

Sound Pressure Level 90 dB/w · m

Dimensions (W/H/D) 215 × 295 × 275 mm
(8-1/2 × 11-5/8 × 10-7/8 inches)

Mass 3.2 kg (7.1 lbs) each

SP-D311

Type	3- way, 3-speaker bass-reflex type
Speakers	
Woofer	16 cm (6-5/16 inches) cone × 1
Mid Range	5 cm (2 inches) cone × 1
Tweeter	2 cm (13/16 inches) dome × 1
Power Handling Capacity	80 watts
Impedance	4 ohms
Frequency Range	45 Hz - 20,000 Hz
Sound Pressure Level	90 dB/w · m
Dimensions (W/H/D)	215 × 295 × 275 mm (8-1/2 × 11-5/8 × 10-7/8 inches)
Mass	3.2 kg (7.1 lbs) each

Accessories

AM Loop Antenna	(1)
Remote Control	(1)
Batteries R6P (SUM-3)/AA (15F)	(2)
FM Wire Antenna	(1)
AC Plug Adaptor (except for Hong Kong)	(1)

Power Specifications**CA-D501T/MX-D401T**

Power Requirements	AC 110/127/220/230 - 240 V \sim , 50/60 Hz adjustable with the voltage selector
Power Consumption	85 watts
	12 watts (in standby mode)
Max. Power Consumption	185 watts (Taiwan only)

MX-D301T

Power Requirements	AC 110/127/220/230 - 240 V \sim , 50/60 Hz adjustable with the voltage selector
Power Consumption	55 watts
	12 watts (in standby mode)
Max. Power Consumption	120 watts (Taiwan only)

Design and specifications are subject to change without notice.

Mains (AC) Line Instruction (not applicable for Europe, U.S.A., Canada, Australia, and U.K.)

Instrucción sobre la línea de la red (CA) (no aplicable para Europa, EE.UU., Canadá, Australia, ni el Grã-Bretanha)

Instrução sobre a tensão da rede eléctrica (CA) (não aplicável para a Europa, os E.U.A., o Canadá, a Austrália e o Reino Unido)

主 (AC) 電源線路說明 (不適用於歐洲、美國、加拿大、澳洲及英國型號)

تعليمات التيار الرئيسي (التردد) (لا ينطبق لاوروبا وامريكا وكندا واستراليا والمملكة المتحدة)

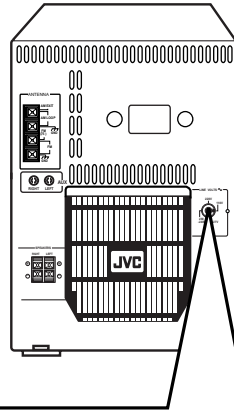

IMPORTANT for mains (AC) line

BEFORE PLUGGING IN, do check that your mains (AC) line voltage corresponds with the position of the voltage selector switch provided on the outside of this equipment and, if different, reset the voltage selector switch, to prevent from a damage or risk of fire/electric shock.

IMPORTANTE para la línea de la red (CA)

ANTES DE ENCHUFAR EL EQUIPO, compruebe si la tensión de la línea de la red (CA) corresponde con la posición del selector de tensión situado en la parte exterior del equipo, y si es diferente, reajuste el selector de tensión para evitar el riesgo de incendios/descargas eléctricas.

IMPORTANTE para a ligação à tensão da rede (CA)

ANTES DE LIGAR O APARELHO A UMA TOMADA DA REDE, verifique se a tensão da rede CA corresponde à posição do seletor de voltagem localizado na parte externa deste equipamento. Caso não corresponda, reajuste o seletor de voltagem a fim de evitar avarias ou riscos de incêndio e choque elétrico.

有關主 (AC) 電源線路的重要事項

接插電源以前，務請檢查當地的主 (AC) 電源線路電壓是否和位於本機外面的電壓選擇開關設定的位置一致。如果不一致，即重新設定電壓選擇開關使符合當地電壓，以免損壞機器或引起火災/觸電的危險。

هام من أجل خط التيار المتردد (AC) الرئيسي

قبل ادخال القابس، تأكد من أن فولتية خط التيار المتردد (AC) الرئيسي لديك متوافقة مع موضع مفتاح اختيار الفولتية المتوفر خارج هذه المعدات وإذا اختلفت، فقم باعادة ضبط مفتاح اختيار الفولتية، لمنع التلف أو الصدمة الكهربائية وخطر الحريق.

Free Manuals Download Website

<http://myh66.com>

<http://usermanuals.us>

<http://www.somanuals.com>

<http://www.4manuals.cc>

<http://www.manual-lib.com>

<http://www.404manual.com>

<http://www.luxmanual.com>

<http://aubethermostatmanual.com>

Golf course search by state

<http://golfingnear.com>

Email search by domain

<http://emailbydomain.com>

Auto manuals search

<http://auto.somanuals.com>

TV manuals search

<http://tv.somanuals.com>