

JVC



ENGLISH

FRANÇAIS

**CD RECEIVER
RECEPTEUR CD**

KD-G111

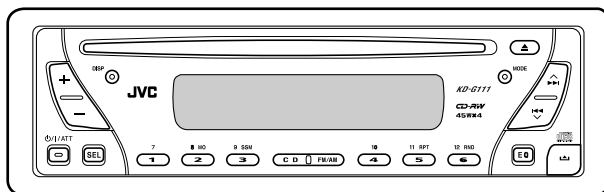
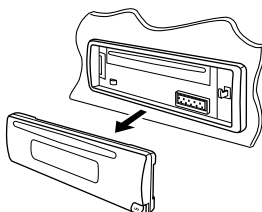

CD-RW

COMPACT
disc
DIGITAL AUDIO

For canceling the display demonstration, see page 7.
Pour annuler la démonstration des affichages, référez-vous à la page 7.

For installation and connections, refer to the separate manual.
Pour l'installation et les raccordements, se référer au manuel séparé.

INSTRUCTIONS

MANUEL D'INSTRUCTIONS

GET0253-003A
[EX/EU]

Thank you for purchasing a JVC product.

Please read all instructions carefully before operation, to ensure your complete understanding and to obtain the best possible performance from the unit.

IMPORTANT FOR LASER PRODUCTS

1. CLASS 1 LASER PRODUCT
2. **CAUTION:** Do not open the top cover. There are no user serviceable parts inside the unit; leave all servicing to qualified service personnel.
3. **CAUTION:** Visible and invisible laser radiation when open and interlock failed or defeated. Avoid direct exposure to beam.
4. REPRODUCTION OF LABEL: CAUTION LABEL, PLACED OUTSIDE THE UNIT.

CAUTION: Visible and invisible laser radiation when open and interlock failed or defeated. AVOID DIRECT EXPOSURE TO BEAM.	ADVARSEL: Synlig og usynlig laserstråling når maskinen er åpen eller interlocken fejler. Undgå direkte eksponering til stråling.	VARNING: Synlig och osynlig laserstråling när den öppnas och spärren är urkopplad. Beträkta ej strålen.	VARO: Arvattassa ja suojalukitus ohitettuna tai viallisena olet alttiina näkyvälle ja näkymättömälle lasersträlylle. Vältä säteen kohollistamista suoraan itseesi.
(e)	(e)	(f)	(s)

Warning:

If you need to operate the receiver while driving, be sure to look ahead carefully or you may be involved in a traffic accident.

How to reset your unit



- This will reset the microcomputer. Your preset adjustments will also be erased.
- If a disc is loaded, it will eject. Be careful not to drop the disc.

How to forcibly eject a disc

If a disc cannot be recognized by the receiver or cannot be ejected, ejects the disc as follows.



- If this does not work, try to reset your receiver.
- Be careful not to drop the disc when it ejects.

Note: Only for [EX] model users in UK and European countries

For security reasons, a numbered ID card is provided with this receiver, and the same ID number is imprinted on the receiver's chassis. Keep the card in a safe place, as it will help the authorities to identify your unit if stolen.

Contents

How to reset your unit	2	Sound adjustments	12
How to forcibly eject a disc	2	Selecting preset sound modes	
How to read this manual	4	(C-EQ: custom equalizer)	12
How to use the MODE button	4	Adjusting the sound	13
Control panel — KD-G111	5	General settings — PSM	14
Parts identification	5	Basic procedure	14
Getting started	6	Detaching the control panel....	15
Basic operations	6	Maintenance	16
Canceling the display demonstrations ...	7	More about this receiver	17
Setting the clock	7	Troubleshooting	18
Radio operations	8	Specifications	19
Listening to the radio.....	8		
Storing stations in memory	9		
Listening to a preset station	9		
Disc operations	10		
Playing a disc	10		
Selecting the playback modes.....	11		

*For safety....

- Do not raise the volume level too much, as this will block outside sounds, making driving dangerous.
- Stop the car before performing any complicated operations.



*Temperature inside the car....

If you have parked the car for a long time in hot or cold weather, wait until the temperature in the car becomes normal before operating the unit.

How to read this manual

The following methods are used to make the explanations simple and easy-to-understand:

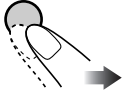
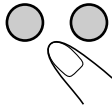
- Some related tips and notes are explained in “More about this receiver” (see page 17).
- Button operations are mainly explained with the illustrations as follows:

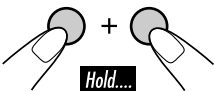
	Press briefly.
	Press repeatedly.
	Press either one.
	
	Press and hold until your desired response begins.
	Press and hold both buttons at the same time.

How to use the MODE button

If you press MODE, the receiver goes into functions mode, then the number buttons work as different function buttons.

Ex.: When number button 2 works as MO (monaural) button.

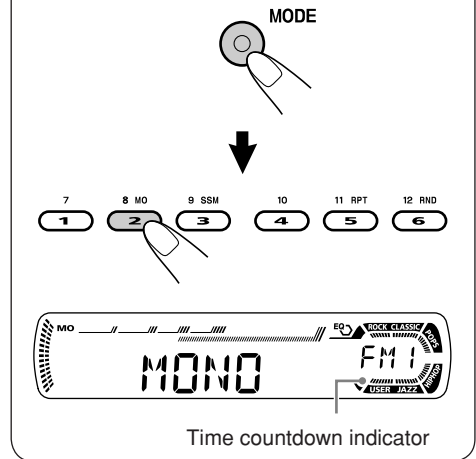

To use these buttons for original functions again after pressing MODE, wait for 5 seconds without pressing any of these buttons until the functions mode is cleared.

- Pressing MODE again also clears the functions mode.

Parts identification

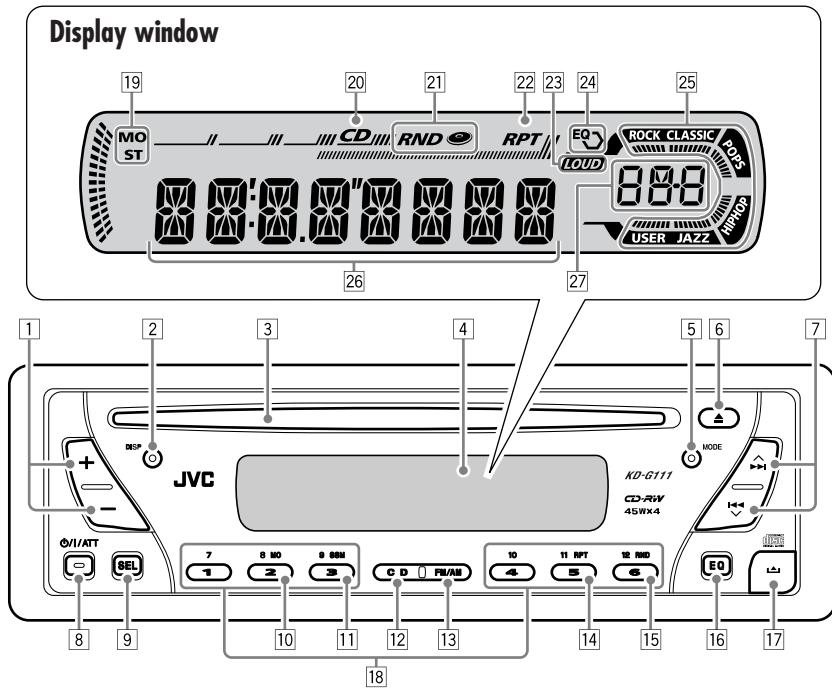

- 1 +/- buttons
- 2 DISP (display) button
- 3 Loading slot
- 4 Display window
- 5 MODE button
- 6 ▲ (eject) button
- 7 ▲▶▶/◀◀▼ buttons
- 8 ⏻/⏻/ATT (standby/on/attenuator) button
- 9 SEL (select) button
- 10 MO (monaural) button
- 11 SSM (Strong-station Sequential Memory) button
- 12 CD button
- 13 FM/AM button
- 14 RPT (repeat) button
- 15 RND (random) button
- 16 EQ (equalizer) button
- 17 ⏻ (control panel release) button
- 18 Number buttons

Display window

- 19 Tuner reception indicators
MO (monaural), ST (stereo)
- 20 CD indicator
- 21 RND (disc random) indicator
- 22 RPT (repeat) indicator
- 23 LOUD (loudness) indicator
- 24 EQ (equalizer) indicator
- 25 Sound mode (C-EQ: custom equalizer) indicators
ROCK, CLASSIC, POPS, HIP HOP, JAZZ, USER
 - also works as the time countdown indicator.
- 26 Main display
- 27 Source display
Volume level indicator

Getting started

Basic operations

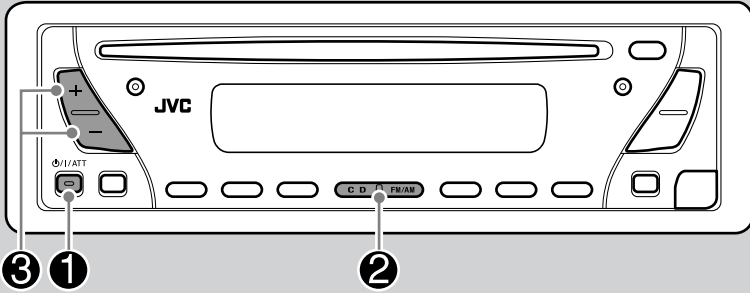

To drop the volume in a moment (ATT)

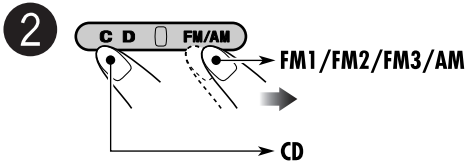
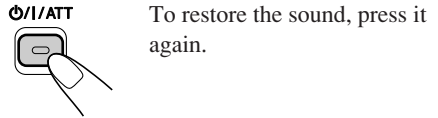

To turn off the power

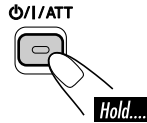

You cannot select "CD" as the playback source if there is no disc in the loading slot.

Caution on volume setting:

Discs produce very little noise compared with other sources. Lower the volume before playing a disc to avoid damaging the speakers by the sudden increase of the output level.

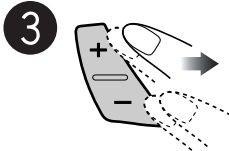

Volume level appears.

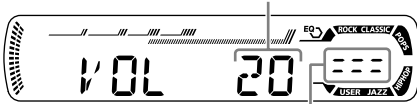

Volume level indicator



Canceling the display demonstrations

If no operations are done for about 20 seconds, display demonstration starts.

[Initial: DEMO ON]—see page 14.

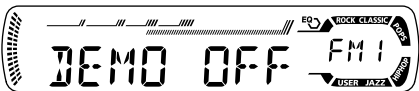
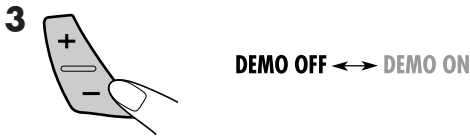
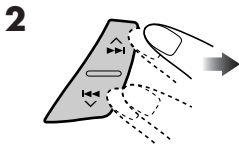

4 Finish the procedure.



To activate the display demonstration

In step 3 above...



DEMO OFF ↔ DEMO ON

Setting the clock



2 Set the hour and minute.

1 Select "CLOCK H" (hour), then adjust the hour.

2 Select "CLOCK M" (minute), then adjust the minute.

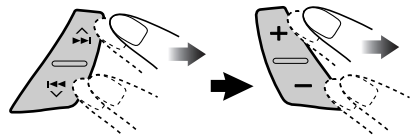

3 Finish the procedure.



To check the current clock time when the power is turned off

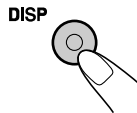

Radio operations

Listening to the radio

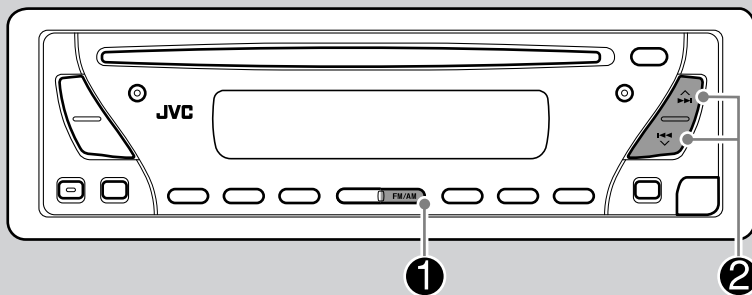

Lights up when receiving an FM stereo broadcast with sufficient signal strength.

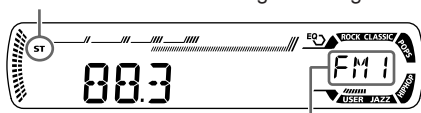

Selected band appears.

2 Start searching for a station.

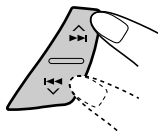

When a station is received, searching stops.

To stop searching, press the same button again.

To tune in to a station manually

In step 2 above...

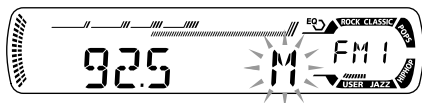
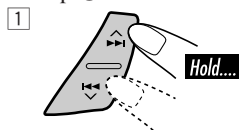

2 Select the desired station frequencies.

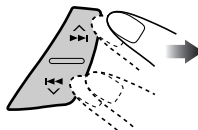

When an FM stereo broadcast is hard to receive

1 MODE

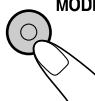

2 8 MO



Lights up when monaural mode is activated.



Reception improves, but stereo effect will be lost.

To restore the stereo effect, repeat the same procedure so that the MO indicator goes off.

Storing stations in memory

You can preset six stations for each band.

FM station automatic presetting—SSM (Strong-station Sequential Memory)

- 1 Select the FM band (FM1 – FM3) you want to store into.

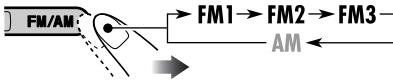

- 2 Press the MODE button.

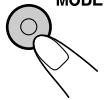

- 3 Press the 9 SSM button and hold it down.



“SSM” flashes, then disappears when automatic presetting is over.

Local FM stations with the strongest signals are searched and stored automatically in the FM band.

Manual presetting

Ex.: Storing FM station of 92.5 MHz into the preset number 4 of the FM1 band.

- 1 Select the FM band (FM1 – FM3) you want to store into.

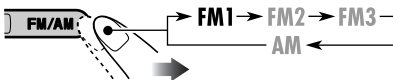

- 2 Press the 10 button and hold it down.

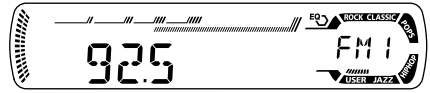

- 3 Press the 4 button and hold it down.

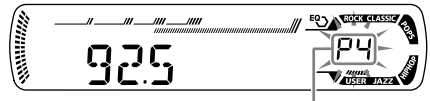

Preset number flashes for a while.

Listening to a preset station

- 1 Select the FM band (FM1 – FM3) you want to listen to.

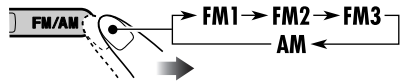

- 2 Select the preset station (1 – 6) you want.

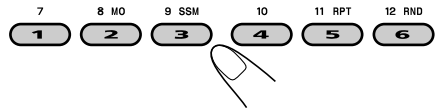

To check the current clock time while listening to an FM or AM station

- 1 Press the DISP button.

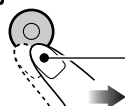

Frequency ↔ Clock

Disc operations

Playing a disc

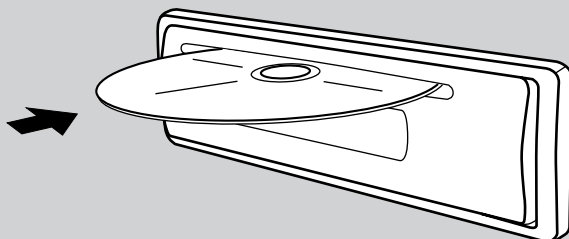

All tracks will be played repeatedly until you stop playback.

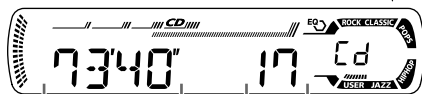

Total playing time of the inserted disc Total track number of the inserted disc

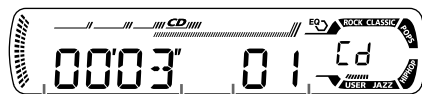

Elapsed playing time Current track number

To stop play and eject the disc

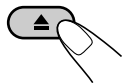

To fast-forward or reverse the track

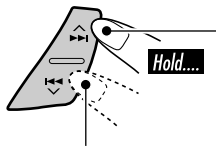

Fast-forwards.

Reverses.

To go to the next or previous tracks

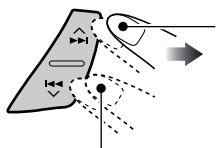

To the following tracks.

To the beginning of the current track, then the previous tracks.

To go to a particular track directly

To select a number from 01 – 06:

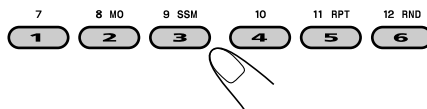

To select a number from 07 – 12:

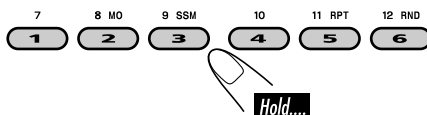

Prohibiting disc ejection

You can lock a disc in the loading slot.

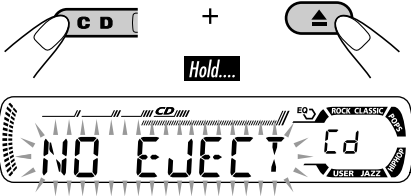

To cancel the prohibition, repeat the same procedure.

To check the current clock time while listening to a disc

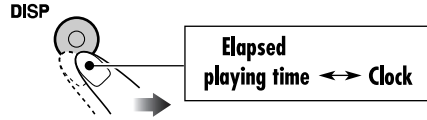

Selecting the playback modes

You can use only one of the following playback modes at a time.

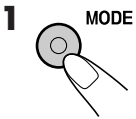

2 Select your desired playback mode.

Repeat play

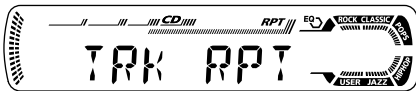
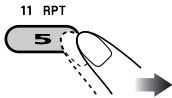

Ex.: When "TRK RPT" is selected

Mode	Plays repeatedly
------	------------------

TRK RPT: The current track.

- RPT lights up.

RPT OFF: Cancels repeat play.

Random play

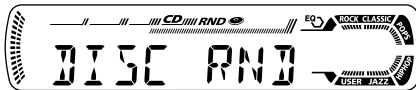
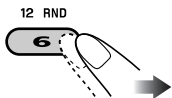

Ex.: When "DISC RND" is selected

Mode	Plays at random
------	-----------------

DISC RND: All tracks of the current disc.

- RND  lights up.

RND OFF: Cancels random play.

Sound adjustments

Selecting preset sound modes (C-EQ: custom equalizer)

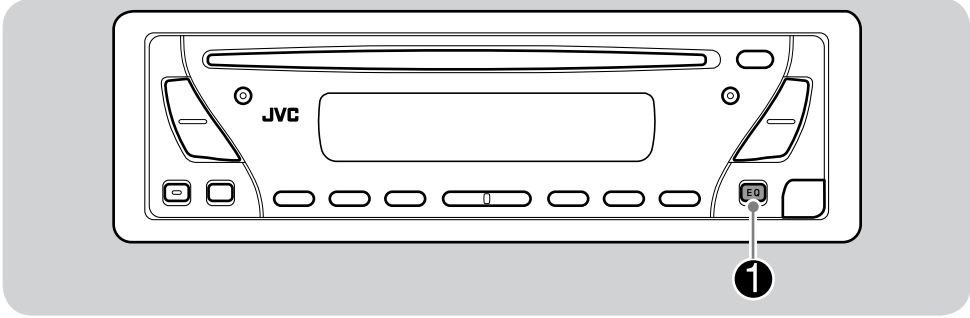

You can select a preset sound mode suitable to the music genre.

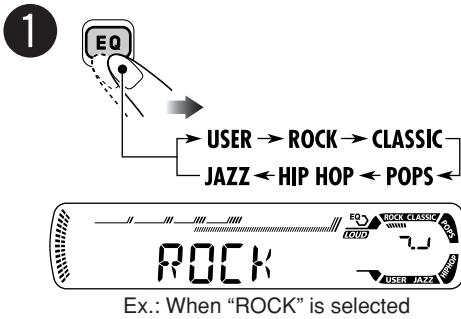

Indication	For:	Preset values		
		BAS* ¹	TRE* ²	LOUD* ³
USER	(Flat sound)	00	00	OFF
ROCK	Rock or disco music	+03	+01	ON
CLASSIC	Classical music	+01	-02	OFF
POPS	Light music	+04	+01	OFF
HIP HOP	Funk or rap music	+02	00	ON
JAZZ	Jazz music	+02	+03	OFF

Indication pattern for each sound mode:

USER	ROCK	CLASSIC
JAZZ	HIP HOP	POPS

*1 BAS: Bass

*2 TRE: Treble

*3 LOUD: Loudness

Adjusting the sound

You can adjust the sound characteristics to your preference.

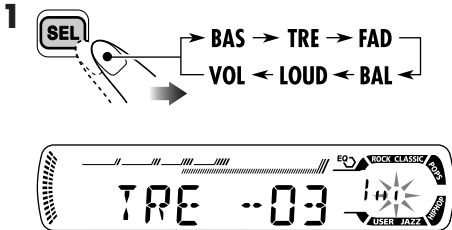

Ex.: When "TRE" is selected

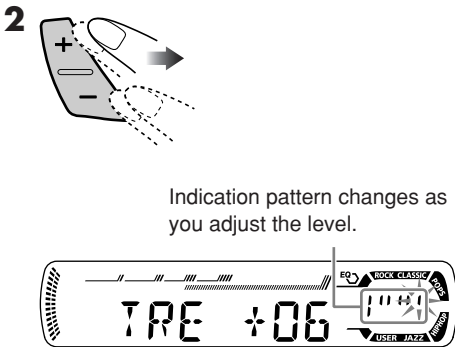

Indication pattern changes as you adjust the level.

Indication	To do:	Range
BAS* ¹ (bass)	Adjust the bass.	-06 (min.) to +06 (max.)
TRE* ¹ (treble)	Adjust the treble.	-06 (min.) to +06 (max.)
FAD* ² (fader)	Adjust the front and rear speaker balance.	R06 (Rear only) to F06 (Front only)
BAL (balance)	Adjust the left and right speaker balance.	L06 (Left only) to R06 (Right only)
LOUD* ¹ (loudness)	Boost low and high frequencies to produce a well-balanced sound at low volume level.	LOUD ON ↑ LOUD OFF
VOL* ³ (volume)	Adjust the volume.	00 (min.) to 30 or 50 (max.)* ⁴

*¹ When you adjust the bass, treble, or loudness, the adjustment you have made is stored for the currently selected sound mode (C-EQ) including "USER."

*² If you are using a two-speaker system, set the fader level to "00."

*³ Normally the +/- buttons work as the volume control. So you do not have to select "VOL" to adjust the volume level.

*⁴ Depending on the amplifier gain control setting. (See page 14 for details.)

General settings — PSM

Basic procedure

You can change PSM (Preferred Setting Mode) items listed on the table that follows.



2 Select a PSM item.

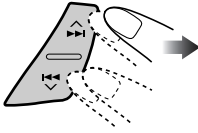

Ex.: When you select "AMP GAIN"

3 Adjust the PSM item selected.

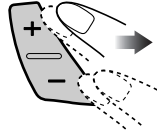

4 Repeat steps 2 and 3 to adjust the other PSM items if necessary.

5 Finish the procedure.



Indications	Selectable settings, [reference page]
<p>DEMO Display demonstration</p>	<p>DEMO ON: [Initial]; Display demonstration will be activated automatically if no operation is done for about 20 seconds, [7].</p> <p>DEMO OFF: Cancels.</p>
<p>CLOCK H Hour adjustment</p>	<p>0 – 23, [7] [Initial: 0 (0:00)]</p>
<p>CLOCK M Minute adjustment</p>	<p>00 – 59, [7] [Initial: 00 (0:00)]</p>
<p>AMP GAIN Amplifier gain control</p>	<p>You can change the maximum volume level of this receiver.</p> <p>LOW PWR: VOL 00 – VOL 30 (Select this if the maximum power of the speaker is less than 45 W to prevent them from damaging the speaker.)</p> <p>HIGH PWR: [Initial]; VOL 00 – VOL 50</p>

Detaching the control panel

When detaching or attaching the control panel, be careful not to damage the connectors on the back of the control panel and on the panel holder.

■ Detaching the control panel

Before detaching the control panel, be sure to turn off the power.

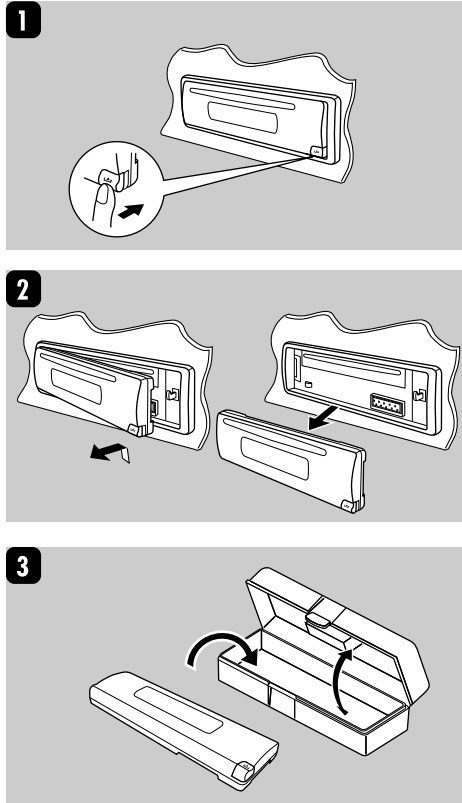

■ Attaching the control panel

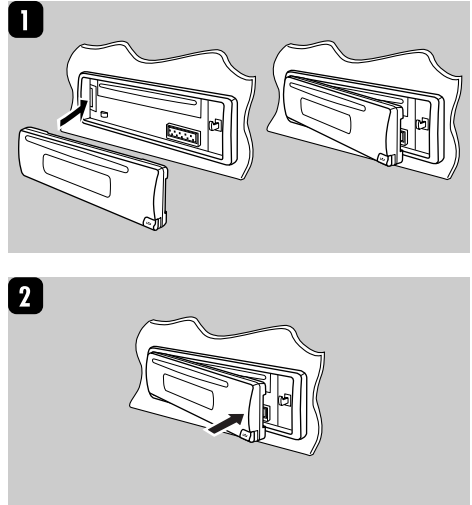

Maintenance

How to clean the connectors

Frequent detachment will deteriorate the connectors.

To minimize this possibility, periodically wipe the connectors with a cotton swab or cloth moistened with alcohol, being careful not to damage the connectors.

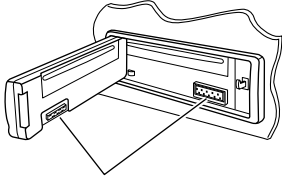

Connector

Moisture condensation

Moisture may condense on the lens inside the CD player in the following cases:

- After starting the heater in the car.
- If it becomes very humid inside the car.

Should this occur, the CD player may malfunction. In this case, eject the disc and leave the receiver turned on for a few hours until the moisture evaporates.

How to handle discs

When removing a disc from its case, press down the center holder of the case and lift the disc out, holding it by the edges.

Center holder



- Always hold the disc by the edges. Do not touch its recording surface.

When storing a disc into its case, gently insert the disc around the center holder (with the printed surface facing up).

- Make sure to store discs into the cases after use.

To keep discs clean

A dirty disc may not play correctly. If a disc does become dirty, wipe it with a soft cloth in a straight line from center to edge.



- Do not use any solvent (for example, conventional record cleaner, spray, thinner, benzine, etc.) to clean discs.

To play new discs

New discs may have some rough spots around the inner and outer edges. If such a disc is used, this receiver may reject the disc.



To remove these rough spots, rub the edges with a pencil or ball-point pen, etc.

Do not use the following discs:

Wrap disc



Sticker



Sticker residue

Disc



Stick-on label

More about this receiver

Basic operations

Turning off the power

- If you turn off the power while listening to a disc, disc play will start from where playback has been stopped previously, next time you turn on the power.

Tuner operations

Storing stations in memory

- During SSM search...
 - All previously stored stations are erased and stations are stored newly.
 - Received stations are preset in No. 1 (lowest frequency) to No. 6 (highest frequency).
 - When SSM is over, the station stored in No. 1 will be automatically tuned in.
- When storing a station manually, a previously preset station is erased when a new station is stored in the same preset number.

Disc operations

General

- This receiver has been designed to reproduce CDs, and CD-Rs (Recordable)/CD-RWs (Rewritable) in audio CD (CD-DA) format.
- When a disc has been loaded, selecting “CD” for the playback source starts disc play.

Inserting a disc

- When a disc is inserted upside down, the disc automatically ejects.
- Do not insert 8 cm discs (single CD) and unusual shape discs (heart, flower, etc) into the loading slot.

Playing a CD-R or CD-RW

- Use only “finalized” CD-Rs or CD-RWs.
- This receiver can play back multi-session discs; however, unclosed sessions will be skipped while playing.

- Some CD-Rs or CD-RWs may not play back on this receiver because of their disc characteristics, and for the following causes:
 - Discs are dirty or scratched.
 - Moisture condensation occurs on the lens inside the receiver.
 - The pickup lens inside the receiver is dirty.
 - CD-R or CD-RW on which the files are written with “Packet Write” method.
 - There are improper recording conditions (missing data, etc.) or media conditions (stain, scratch, warp, etc.).
 - CD-RWs may require a longer readout time since the reflectance of CD-RWs is lower than that of regular CDs.
 - Do not use the following CD-Rs or CD-RWs:
 - Discs with stickers, labels, or protective seal stuck to the surface.
 - Discs on which labels can be directly printed by an ink jet printer.
- Using these discs under high temperatures or high humidity may cause malfunctions or damage to discs.

Changing the source

- If you change the source, playback also stops (without ejecting the disc). Next time you select “CD” for the playback source, disc play starts from where it has been stopped previously.

Ejecting a disc

- If the ejected disc is not removed within 15 seconds, the disc is automatically inserted again into the loading slot to prevent it from dust. (Disc will not play this time.)

General settings—PSM

- If you change the “AMP GAIN” setting from “HIGH PWR” to “LOW PWR” while the volume level is set higher than “VOL 30,” the receiver automatically changes the volume level to “VOL 30.”

Troubleshooting

What appears to be trouble is not always serious. Check the following points before calling a service center.

	Symptoms	Causes	Remedies
General	<ul style="list-style-type: none"> • Sound cannot be heard from the speakers. 	<p>The volume level is set to the minimum level.</p> <p>Connections are incorrect.</p>	<p>Adjust it to the optimum level.</p> <p>Check the cords and connections.</p>
	<ul style="list-style-type: none"> • The receiver does not work at all. 	<p>The built-in microcomputer may have functioned incorrectly due to noise, etc.</p>	<p>Reset the receiver (see page 2).</p>
FM/AM	<ul style="list-style-type: none"> • SSM automatic presetting does not work. 	<p>Signals are too weak.</p>	<p>Store stations manually.</p>
	<ul style="list-style-type: none"> • Static noise while listening to the radio. 	<p>The aerial is not connected firmly.</p>	<p>Connect the aerial firmly.</p>
Disc playback	<ul style="list-style-type: none"> • Disc automatically ejects. 	<p>Disc is inserted upside down.</p>	<p>Insert the disc correctly.</p>
	<ul style="list-style-type: none"> • CD-R/CD-RW cannot be played back. • Tracks on the CD-R/CD-RW cannot be skipped. 	<p>CD-R/CD-RW is not finalized.</p>	<ul style="list-style-type: none"> • Insert a finalized CD-R/CD-RW. • Finalize the CD-R/CD-RW with the component which you used for recording.
	<ul style="list-style-type: none"> • Disc can be neither played back nor ejected. 	<p>Disc is locked.</p>	<p>Unlock the disc (see page 11).</p>
		<p>The CD player may have functioned incorrectly.</p>	<p>Eject the disc forcibly (see page 2).</p>
	<ul style="list-style-type: none"> • Disc sound is sometimes interrupted. 	<p>You are driving on rough roads.</p>	<p>Stop playback while driving on rough roads.</p>
		<p>Disc is scratched.</p>	<p>Change the disc.</p>
		<p>Connections are incorrect.</p>	<p>Check the cords and connections.</p>
	<ul style="list-style-type: none"> • “NO DISC” appears on the display. 	<p>No disc in the loading slot.</p>	<p>Insert a disc into the loading slot.</p>
<p>Disc is inserted incorrectly.</p>		<p>Insert the disc correctly.</p>	

Specifications

AUDIO AMPLIFIER SECTION

Maximum Power Output:

Front: 45 W per channel

Rear: 45 W per channel

Continuous Power Output (RMS):

Front: 17 W per channel into 4 Ω , 40 Hz to 20 000 Hz at no more than 0.8% total harmonic distortion.

Rear: 17 W per channel into 4 Ω , 40 Hz to 20 000 Hz at no more than 0.8% total harmonic distortion.

Load Impedance: 4 Ω (4 Ω to 8 Ω allowance)

Tone Control Range:

Bass: ± 10 dB at 100 Hz

Treble: ± 10 dB at 10 kHz

Frequency Response: 40 Hz to 20 000 Hz

Signal-to-Noise Ratio: 70 dB

Line-Out Level/Impedance:

2.0 V/20 k Ω load (full scale)

Output Impedance: 1 k Ω

TUNER SECTION

Frequency Range:

FM: 87.5 MHz to 108.0 MHz

AM: (MW) 522 kHz to 1 620 kHz

(LW) 144 kHz to 279 kHz

[FM Tuner]

Usable Sensitivity: 11.3 dBf (1.0 μ V/75 Ω)

50 dB Quieting Sensitivity:

16.3 dBf (1.8 μ V/75 Ω)

Alternate Channel Selectivity (400 kHz): 65 dB

Frequency Response: 40 Hz to 15 000 Hz

Stereo Separation: 30 dB

Capture Ratio: 1.5 dB

[MW Tuner]

Sensitivity: 20 μ V

Selectivity: 35 dB

[LW Tuner]

Sensitivity: 50 μ V

CD PLAYER SECTION

Type: Compact disc player

Signal Detection System: Non-contact optical pickup (semiconductor laser)

Number of channels: 2 channels (stereo)

Frequency Response: 5 Hz to 20 000 Hz

Dynamic Range: 96 dB

Signal-to-Noise Ratio: 98 dB

Wow and Flutter: Less than measurable limit

GENERAL

Power Requirement:

Operating Voltage:

DC 14.4 V (11 V to 16 V allowance)

Grounding System: Negative ground

Allowable Operating Temperature:

0°C to +40°C

Dimensions (W \times H \times D):

Installation Size (approx.):

182 mm \times 52 mm \times 150 mm

Panel Size (approx.):

188 mm \times 58 mm \times 11 mm

Mass (approx.):

1.3 kg (excluding accessories)

Design and specifications are subject to change without notice.



Having TROUBLE with operation?

Please reset your unit

Refer to page of How to reset your unit

Vous avez des PROBLÈMES de fonctionnement?

Réinitialisez votre appareil

Référez-vous à la page intitulée Comment réinitialiser votre appareil

JVC



EN, FR

© 2004 Victor Company of Japan, Limited

1004DTSMdTJEIN

ENGLISH

This receiver is designed to operate on **12 V DC, NEGATIVE ground electrical systems**. If your vehicle does not have this system, a voltage inverter is required, which can be purchased at JVC IN-CAR ENTERTAINMENT dealers.

Parts list for installation and connection

The following parts are provided for this receiver. After checking them, please set them correctly.

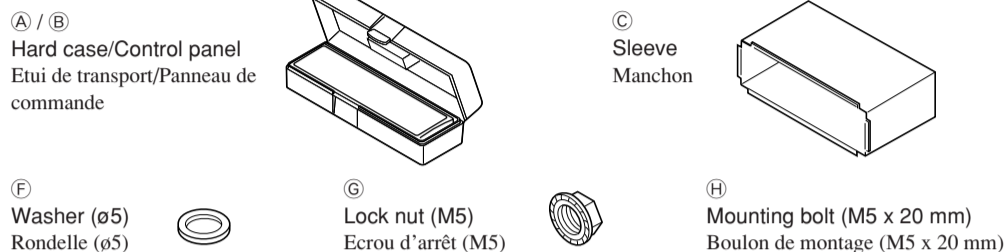

FRANÇAIS

Cet appareil est conçu pour fonctionner sur des sources de courant continu de **12 V à masse NEGATIVE**. Si votre véhicule n'offre pas ce type d'alimentation, il vous faut un convertisseur de tension, que vous pouvez acheter chez un revendeur d'autoradios JVC.

Liste des pièces pour l'installation et raccordement

Les pièces suivantes sont fournies avec cet appareil. Après vérification, veuillez les placer correctement.

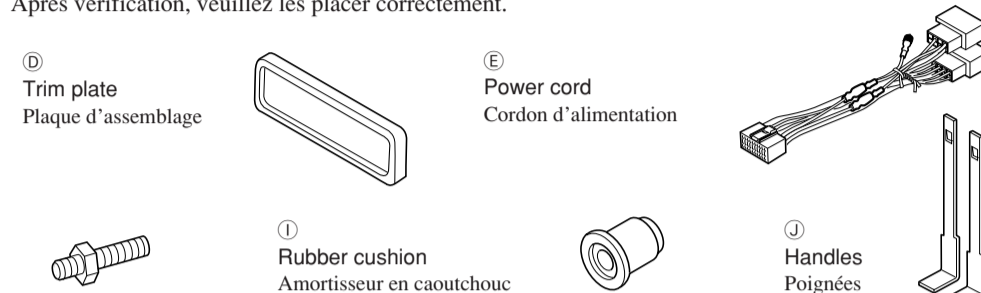

INSTALLATION (IN-DASH MOUNTING)

The following illustration shows a typical installation. If you have any questions or require information regarding installation kits, consult your JVC IN-CAR ENTERTAINMENT dealer or a company supplying kits.

- If you are not sure how to install this receiver correctly, have it installed by a qualified technician.

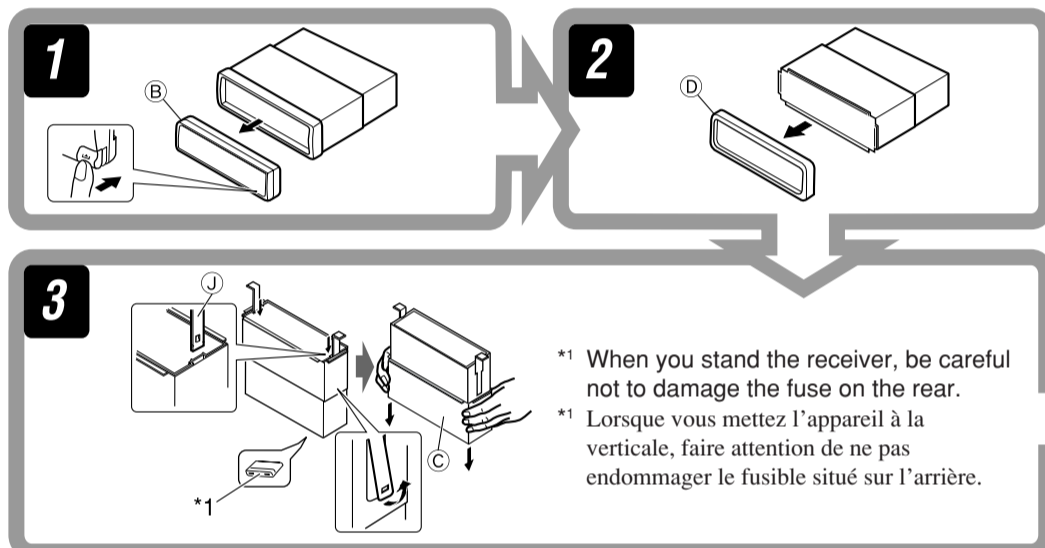

INSTALLATION (MONTAGE DANS LE TABLEAU DE BORD)

L'illustration suivante est un exemple d'installation typique. Si vous avez des questions ou avez besoin d'information sur des kits d'installation, consulter votre revendeur d'autoradios JVC ou une compagnie d'approvisionnement.

- Si l'on n'est pas sûr de pouvoir installer correctement cet appareil, le faire installer par un technicien qualifié.

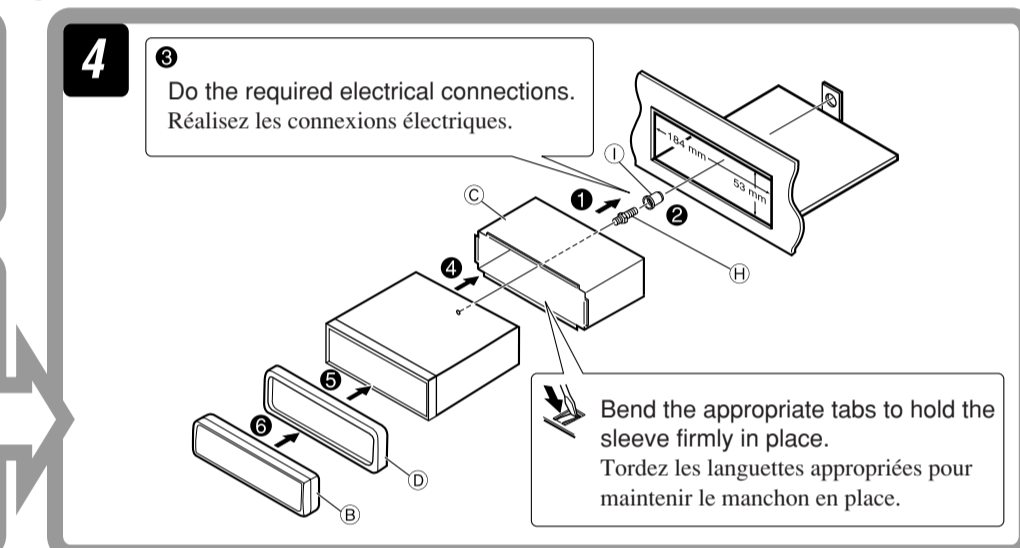

Removing the receiver / Retrait de l'appareil

Before removing the receiver, release the rear section. Avant de retirer l'appareil, libérer la section arrière.

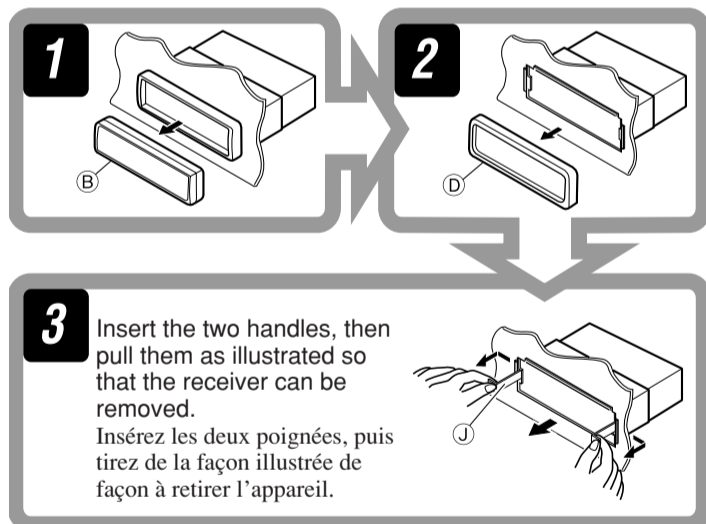

When using the optional stay / Lors de l'utilisation du hauban en option

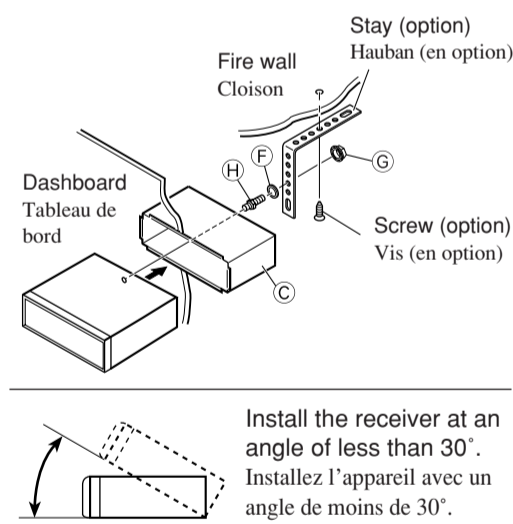

When installing the receiver without using the sleeve / Lors de l'installation de l'appareil sans utiliser de manchon

In a Toyota for example, first remove the car radio and install the receiver in its place. Par exemple dans une Toyota, retirer d'abord l'autoradio et installer l'appareil à la place.

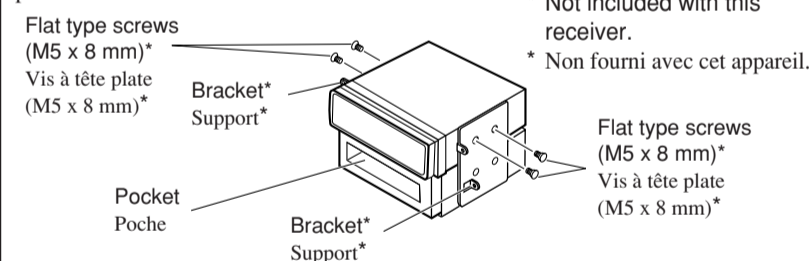

Note : When installing the receiver on the mounting bracket, make sure to use the 8 mm-long screws. If longer screws are used, they could damage the receiver.

Remarque : Lors de l'installation de l'appareil sur le support de montage, s'assurer d'utiliser des vis d'une longueur de 8 mm. Si des vis plus longues sont utilisées, elles peuvent endommager l'appareil.

PRECAUTIONS on power supply and speaker connections:

- **DO NOT** connect the speaker leads of the power cord to the car battery; otherwise, the receiver will be seriously damaged.
- **BEFORE** connecting the speaker leads of the power cord to the speakers, check the speaker wiring in your car.

PRECAUTIONS sur l'alimentation et la connexion des enceintes:

- **NE CONNECTEZ PAS** les fils d'enceintes du cordon d'alimentation à la batterie; sinon, l'appareil serait sérieusement endommagé.
- **AVANT** de connecter les fils d'enceintes du cordon d'alimentation aux enceintes, vérifiez le câblage des enceintes de votre voiture.

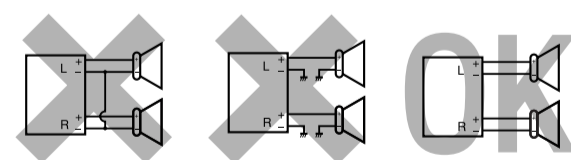

TROUBLESHOOTING

- **The fuse blows.**
 - * Are the red and black leads connected correctly?
- **Power cannot be turned on.**
 - * Is the yellow lead connected?
- **No sound from the speakers.**
 - * Is the speaker output lead short-circuited?
- **Sound is distorted.**
 - * Is the speaker output lead grounded?
 - * Are the "-" terminals of L and R speakers grounded in common?
- **Noise interfere with sounds.**
 - * Is the rear ground terminal connected to the car's chassis using shorter and thicker cords?
- **Receiver becomes hot.**
 - * Is the speaker output lead grounded?
 - * Are the "-" terminals of L and R speakers grounded in common?
- **This receiver does not work at all.**
 - * Have you reset your receiver?

EN CAS DE DIFFICULTES

- **Le fusible saute.**
 - * Les fils rouge et noir sont-ils raccordés correctement?
- **L'appareil ne peut pas être mise sous tension.**
 - * Le fil jaune est-elle raccordée?
- **Pas de son des enceintes.**
 - * Le fil de sortie d'enceinte est-il court-circuité?
- **Le son est déformé.**
 - * Le fil de sortie d'enceinte est-il à la masse?
 - * Les bornes "-" des enceintes gauche et droit sont-elles mises ensemble à la masse?
- **Interférence avec les sons.**
 - * La prise arrière de mise à la terre est-elle connectée au châssis de la voiture avec un cordon court et épais?
- **L'appareil devient chaud.**
 - * Le fil de sortie d'enceinte est-il à la masse?
 - * Les bornes "-" des enceintes gauche et droit sont-elles mises ensemble à la masse?
- **Cet appareil ne fonctionne pas du tout.**
 - * Avez-vous réinitialisé votre appareil?

ELECTRICAL CONNECTIONS

To prevent short circuits, we recommend that you disconnect the battery's negative terminal and make all electrical connections before installing the receiver.

- Be sure to ground this receiver to the car's chassis again after installation.

Notes:

- Replace the fuse with one of the specified rating. If the fuse blows frequently, consult your JVC IN-CAR ENTERTAINMENT dealer.
- It is recommended to connect to the speakers with maximum power of more than 45 W (both at the rear and at the front, with an impedance of 4 Ω to 8 Ω). If the maximum power is less than 45 W, change "AMP GAIN" setting to prevent the speakers from being damaged (see page 14 of the INSTRUCTIONS).
- To prevent short-circuit, cover the terminals of the UNUSED leads with insulating tape.
- The heat sink becomes very hot after use. Be careful not to touch it when removing this receiver.

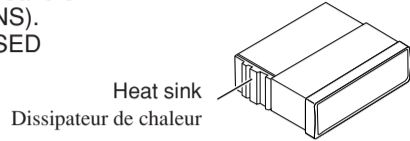

RACCORDEMENTS ELECTRIQUES

Pour éviter tout court-circuit, nous vous recommandons de débrancher la borne négative de la batterie et d'effectuer tous les raccordements électriques avant d'installer l'appareil.

- Assurez-vous de raccorder de nouveau la mise à la masse de cet appareil au châssis de la voiture après l'installation.

Remarques:

- Remplacer le fusible par un de la valeur précisée. Si le fusible saute souvent, consulter votre revendeur d'autoradios JVC.
- Il est recommandé de connecter des enceintes avec une puissance de plus de 45 W (les enceintes arrière et les enceintes avant, avec une impédance comprise entre 4 Ω et 8 Ω). Si la puissance maximum est inférieure à 45 W, changez "AMP GAIN" pour éviter d'endommager vos enceintes (voir page 14 du MANUEL D'INSTRUCTIONS).
- Pour éviter les court-circuits, couvrir les bornes des fils qui ne sont PAS UTILISÉS avec de la bande isolante.
- Le dissipateur de chaleur devient très chaud après usage. Faire attention de ne pas le toucher en retirant cet appareil.

A If your car is equipped with the ISO connector / Si votre voiture est équipée d'un connecteur ISO

• Connect the ISO connectors as illustrated.
• Connectez les connecteurs ISO comme montré sur l'illustration.

For some VW/Audi or Opel (Vauxhall) automobile / Pour certaine voiture VW/Audi ou Opel (Vauxhall)

You may need to modify the wiring of the supplied power cord as illustrated.
• Contact your authorized car dealer before installing this receiver.
Vous aurez peut-être besoin de modifier le câblage du cordon d'alimentation fourni comme montré sur l'illustration.
• Contactez votre revendeur automobile autorisé avant d'installer l'appareil.

Original wiring / Câblage original

Modified wiring [1] / Câblage modifié [1]

Modified wiring [2] / Câblage modifié [2]

Use modified wiring [2] if the receiver does not turn on.
Utilisez le câblage modifié [2] si l'appareil ne se met pas sous tension.

Y: Yellow / Jaune R: Red / Rouge

B Connections without using the ISO connectors / Connexions sans l'utilisation des connecteurs ISO

Before connecting: Check the wiring in the vehicle carefully. Incorrect connection may cause serious damage to this receiver.
The leads of the power cord and those of the connector from the car body may be different in color.

Avant de commencer la connexion: Vérifiez attentivement le câblage du véhicule. Une connexion incorrecte peut endommager sérieusement l'appareil.
Le fil du cordon d'alimentation et ceux des connecteurs du châssis de la voiture peuvent être différents en couleur.

- 1 Cut the ISO connector.
- 2 Connect the colored leads of the power cord in the order specified in the illustration below.
- 3 Connect the aerial cord.
- 4 Finally connect the wiring harness to the receiver.

1 Coupez le connecteur ISO.
2 Connectez les fils colorés du cordon d'alimentation dans l'ordre spécifié sur l'illustration ci-dessous.
3 Connectez le cordon d'antenne.
4 Finalement, connectez le faisceau de fils à l'appareil.

Rear ground terminal / Borne arrière de masse
Aerial terminal / Borne de l'antenne
Line out (see diagram) / Sortie de ligne (voir le diagramme)
15 A fuse / Fusible 15 A

Black / Noir (P) ① To metallic body or chassis of the car / Vers corps métallique ou châssis de la voiture
Yellow*2 / Jaune*2 (L) ② To a live terminal in the fuse block connecting to the car battery (bypassing the ignition switch) (constant 12 V) / À une borne sous tension du porte-fusible connectée à la batterie de la voiture (en dérivant l'interrupteur d'allumage) (12 V constant)
Red / Rouge (O) ③ To an accessory terminal in the fuse block / Vers borne accessoire du porte-fusible
Blue with white stripe / Bleu avec bande blanche (M) ④ To the remote lead of other equipment or power aerial if any (200 mA max.) / Au fil de télécommande de l'autre appareil ou à l'antenne automatique s'il y en a une (200 mA max.)

*1 Not included for this receiver / *1 Non fourni avec cet appareil
Ignition switch / Interrupteur d'allumage
Fuse block / Porte-fusible

*2 Before checking the operation of this receiver prior to installation, this lead must be connected, otherwise power cannot be turned on.
*2 Pour vérifier le fonctionnement de cet appareil avant installation, ce fil doit être raccordé, sinon l'appareil ne peut pas être mis sous tension.

White with black stripe / Blanc avec bande noire (F) (-) (+) Left speaker (front) / Enceinte gauche (avant)
White / Blanc (E) (+) Right speaker (front) / Enceinte droite (avant)
Gray with black stripe / Gris avec bande noire (D) (-) (+) Left speaker (rear) / Enceinte gauche (arrière)
Gray / Gris (C) (+) Right speaker (rear) / Enceinte droite (arrière)
Green with black stripe / Vert avec bande noire (H) (-) (+) Left speaker (rear) / Enceinte gauche (arrière)
Green / Vert (G) (+) Right speaker (rear) / Enceinte droite (arrière)
Purple with black stripe / Violet avec bande noire (B) (-) (+) Left speaker (rear) / Enceinte gauche (arrière)
Purple / Violet (A) (+) Right speaker (rear) / Enceinte droite (arrière)

C Connecting the external amplifier / Connexion d'un amplificateur extérieur

You can connect an amplifier to upgrade your car stereo system.
Vous pouvez connecter un amplificateur pour améliorer votre système autoradio.

- Connect the remote lead (blue with white stripe) to the remote lead of the other equipment so that it can be controlled through this receiver.
- Disconnect the speakers from this receiver, connect them to the amplifier. Leave the speaker leads of this receiver unused.
- Connectez le fil de commande à distance (bleu avec bande blanche) au fil de commande à distance de l'autre appareil de façon qu'il puisse être commandé via cet appareil.
- Déconnectez les enceintes de cet appareil et connectez-les à l'amplificateur. Laissez les fils d'enceintes de cet appareil inutilisés.

Rear speakers / Enceintes arrière
Remote lead / Fil d'alimentation à distance
Y-connector (not supplied with this receiver) / Connecteur Y (non fourni avec cet appareil)
Remote lead (Blue with white stripe) / Fil d'alimentation à distance (Bleu avec bande blanche)
Signal cord (not supplied with this receiver) / Cordon de signal (non fourni avec cet appareil)
JVC Amplifier / Amplificateur
KD-G111

* Cut the rear speaker leads of the car's ISO connector and connect them to the amplifier.
* Coupez les fils des enceintes arrière du connecteur ISO de la voiture et connectez-les à l'amplificateur.

Rear speakers / Enceintes arrière
Front speakers (see diagram B) / Enceintes avant (voir le diagramme B)

*3 Firmly attach the ground wire to the metallic body or to the chassis of the car—to the place not coated with paint (if coated with paint, remove the paint before attaching the wire). Failure to do so may cause damage to the receiver.
*3 Attachez solidement le fil de mise à la masse au châssis métallique de la voiture—à un endroit qui n'est pas recouvert de peinture (s'il est recouvert de peinture, enlevez d'abord la peinture avant d'attacher le fil). L'appareil peut être endommagé si cela n'est pas fait correctement.

JVC



ENGLISH

DEUTSCH

РУССКИЙ

CD RECEIVER CD-RECEIVER

РЕСИВЕР С ПРОИГРЫВАТЕЛЕМ КОМПАКТ-ДИСКОВ

KD-G111

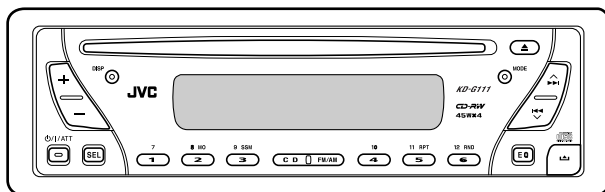
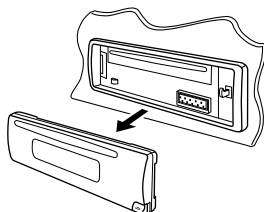

CD-RW

COMPACT
disc
DIGITAL AUDIO

For canceling the display demonstration, see page 7.

Zum Abbrechen der Displaydemonstration siehe Seite 7.

Информацию об отмене демонстрации функций дисплея см. на стр. 7.

For installation and connections, refer to the separate manual.

Für den Einbau und die Anschlüsse siehe das eigenständige Handbuch.

Указания по установке и выполнению соединений приводятся в отдельной инструкции.

INSTRUCTIONS BEDIENUNGSANLEITUNG ИНСТРУКЦИИ ПО ЭКСПЛУАТАЦИИ

GET0253-006A
[EY]



Thank you for purchasing a JVC product.

Please read all instructions carefully before operation, to ensure your complete understanding and to obtain the best possible performance from the unit.

IMPORTANT FOR LASER PRODUCTS

1. CLASS 1 LASER PRODUCT
2. **CAUTION:** Do not open the top cover. There are no user serviceable parts inside the unit; leave all servicing to qualified service personnel.
3. **CAUTION:** Visible and invisible laser radiation when open and interlock failed or defeated. Avoid direct exposure to beam.
4. REPRODUCTION OF LABEL: CAUTION LABEL, PLACED OUTSIDE THE UNIT.

CAUTION: Visible and invisible laser radiation when open and interlock failed or defeated. AVOID DIRECT EXPOSURE TO BEAM.	ADVARSEL: Synlig og usynlig laserstråling når maskinen er åpen eller interlocken fejler. Undgå direkte eksponering til stråling.	VARNING: Synlig och osynlig laserstråling när den öppnas och spärren är urkopplad. Beträkta ej strålen.	VARO: Arvattassa ja suojalukitus ohitettuna tai viallisena olet alitina näkyvälle ja näkymättömälle lasersträlylle. Vältä säteen kohollistamista suoraan itseesi. (f)
(e)	(e)	(f)	(s)

Warning:

If you need to operate the receiver while driving, be sure to look ahead carefully or you may be involved in a traffic accident.

How to reset your unit



- This will reset the microcomputer. Your preset adjustments will also be erased.
- If a disc is loaded, it will eject. Be careful not to drop the disc.

How to forcibly eject a disc

If a disc cannot be recognized by the receiver or cannot be ejected, ejects the disc as follows.



- If this does not work, try to reset your receiver.
- Be careful not to drop the disc when it ejects.

For security reasons, a numbered ID card is provided with this receiver, and the same ID number is imprinted on the receiver's chassis. Keep the card in a safe place, as it will help the authorities to identify your unit if stolen.

Contents

How to reset your unit	2	Sound adjustments	12
How to forcibly eject a disc	2	Selecting preset sound modes	
How to read this manual	4	(C-EQ: custom equalizer)	12
How to use the MODE button	4	Adjusting the sound	13
Control panel — KD-G111	5	General settings — PSM	14
Parts identification	5	Basic procedure	14
Getting started	6	Detaching the control panel....	15
Basic operations	6	Maintenance	16
Canceling the display demonstrations ...	7	More about this receiver	17
Setting the clock	7	Troubleshooting	18
Radio operations	8	Specifications	19
Listening to the radio.....	8		
Storing stations in memory	9		
Listening to a preset station	9		
Disc operations	10		
Playing a disc	10		
Selecting the playback modes.....	11		

*For safety....

- Do not raise the volume level too much, as this will block outside sounds, making driving dangerous.
- Stop the car before performing any complicated operations.



*Temperature inside the car....

If you have parked the car for a long time in hot or cold weather, wait until the temperature in the car becomes normal before operating the unit.

How to read this manual

The following methods are used to make the explanations simple and easy-to-understand:

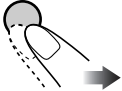
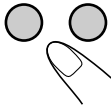
- Some related tips and notes are explained in “More about this receiver” (see page 17).
- Button operations are mainly explained with the illustrations as follows:

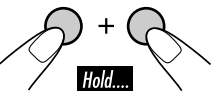
	Press briefly.
	Press repeatedly.
	Press either one.
	
	Press and hold until your desired response begins.
	Press and hold both buttons at the same time.

How to use the MODE button

If you press MODE, the receiver goes into functions mode, then the number buttons work as different function buttons.

Ex.: When number button 2 works as MO (monaural) button.

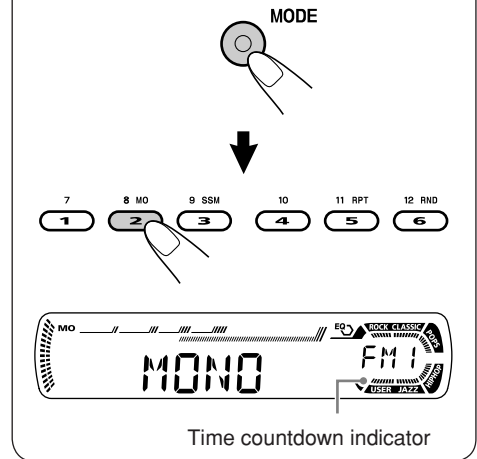

To use these buttons for original functions again after pressing MODE, wait for 5 seconds without pressing any of these buttons until the functions mode is cleared.

- Pressing MODE again also clears the functions mode.

Parts identification

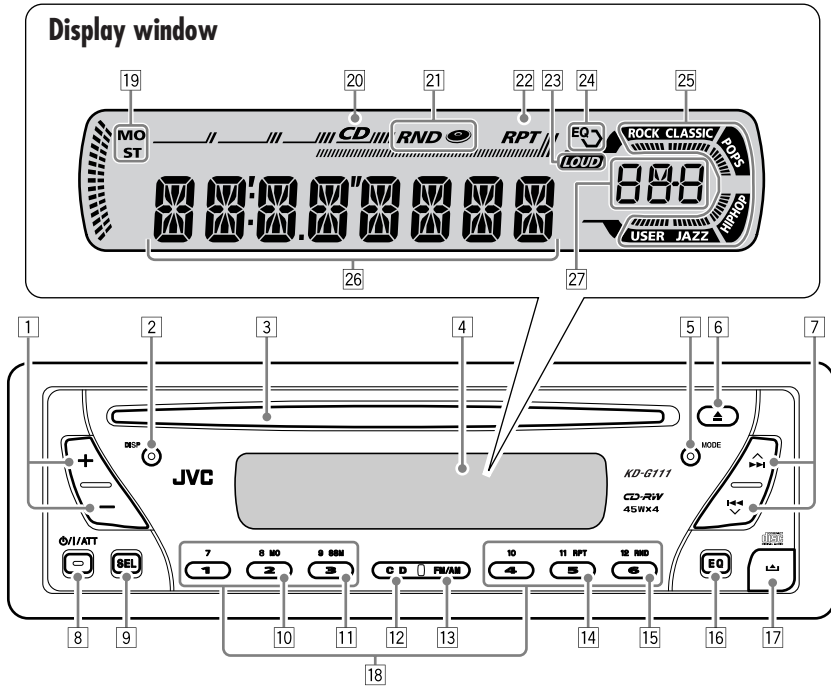

- 1 +/- buttons
- 2 DISP (display) button
- 3 Loading slot
- 4 Display window
- 5 MODE button
- 6 ▲ (eject) button
- 7 ▲▶▶/◀◀▼ buttons
- 8 ⏻/⏻/ATT (standby/on/attenuator) button
- 9 SEL (select) button
- 10 MO (monaural) button
- 11 SSM (Strong-station Sequential Memory) button
- 12 CD button
- 13 FM/AM button
- 14 RPT (repeat) button
- 15 RND (random) button
- 16 EQ (equalizer) button
- 17 ⏻ (control panel release) button
- 18 Number buttons

Display window

- 19 Tuner reception indicators
MO (monaural), ST (stereo)
- 20 CD indicator
- 21 RND (disc random) indicator
- 22 RPT (repeat) indicator
- 23 LOUD (loudness) indicator
- 24 EQ (equalizer) indicator
- 25 Sound mode (C-EQ: custom equalizer) indicators
ROCK, CLASSIC, POPS, HIP HOP, JAZZ, USER
 - also works as the time countdown indicator.
- 26 Main display
- 27 Source display
Volume level indicator

Getting started

Basic operations

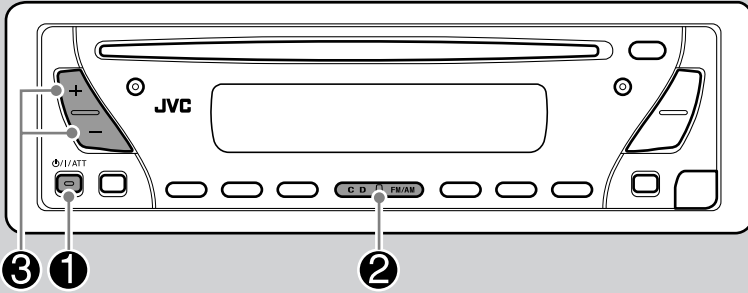

To drop the volume in a moment (ATT)



To restore the sound, press it again.

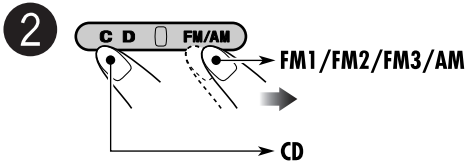

To turn off the power

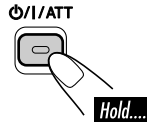

You cannot select "CD" as the playback source if there is no disc in the loading slot.

Caution on volume setting:

Discs produce very little noise compared with other sources. Lower the volume before playing a disc to avoid damaging the speakers by the sudden increase of the output level.

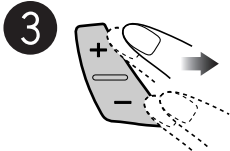

Volume level appears.

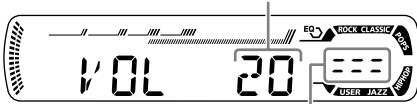

Volume level indicator



Canceling the display demonstrations

If no operations are done for about 20 seconds, display demonstration starts.

[Initial: DEMO ON]—see page 14.

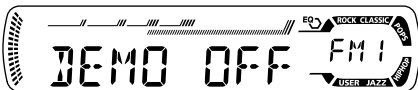
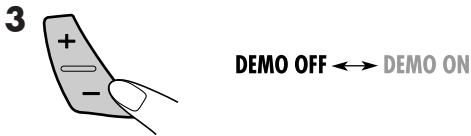
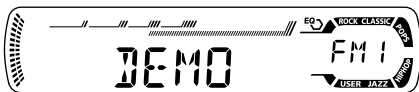
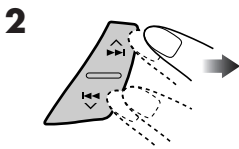

4 Finish the procedure.



To activate the display demonstration

In step 3 above...



DEMO OFF ↔ DEMO ON

Setting the clock



2 Set the hour and minute.

1 Select "CLOCK H" (hour), then adjust the hour.

2 Select "CLOCK M" (minute), then adjust the minute.

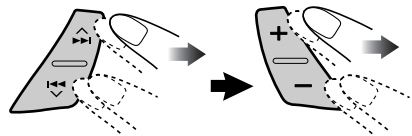

3 Finish the procedure.



To check the current clock time when the power is turned off



Radio operations

Listening to the radio

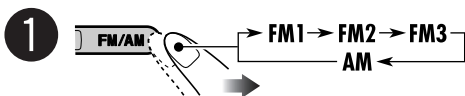
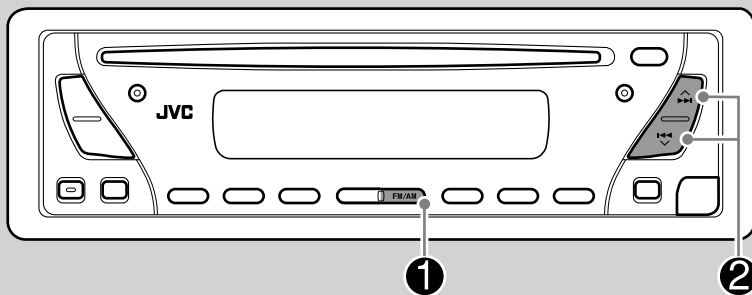

Lights up when receiving an FM stereo broadcast with sufficient signal strength.

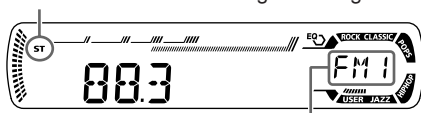

Selected band appears.

2 Start searching for a station.

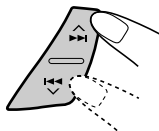

When a station is received, searching stops.

To stop searching, press the same button again.

To tune in to a station manually

In step 2 above...

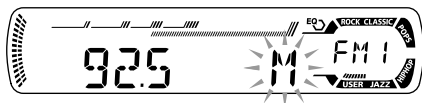
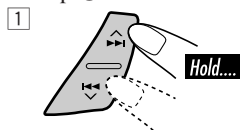

2 Select the desired station frequencies.

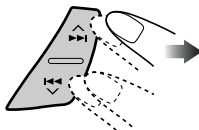

When an FM stereo broadcast is hard to receive

1 MODE

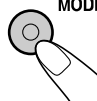

2 8 MO



Lights up when monaural mode is activated.



Reception improves, but stereo effect will be lost.

To restore the stereo effect, repeat the same procedure so that the MO indicator goes off.

Storing stations in memory

You can preset six stations for each band.

FM station automatic presetting—SSM (Strong-station Sequential Memory)

- 1 Select the FM band (FM1 – FM3) you want to store into.

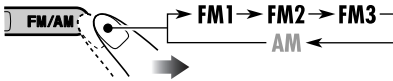

- 2 Press the MODE button.

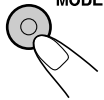

- 3 Press the 9 SSM button and hold it down.



“SSM” flashes, then disappears when automatic presetting is over.

Local FM stations with the strongest signals are searched and stored automatically in the FM band.

Manual presetting

Ex.: Storing FM station of 92.5 MHz into the preset number 4 of the FM1 band.

- 1 Select the FM band (FM1 – FM3) you want to store into.

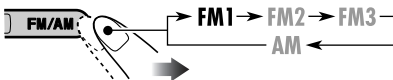

- 2 Press the 4 preset button.

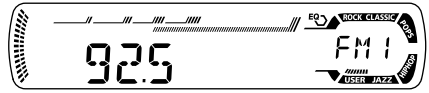

- 3 Press the 10 button and hold it down.

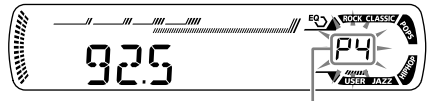

Preset number flashes for a while.

Listening to a preset station

- 1 Select the FM band (FM1 – FM3) you want to listen to.

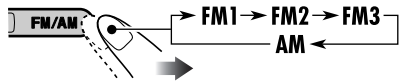

- 2 Select the preset station (1 – 6) you want.

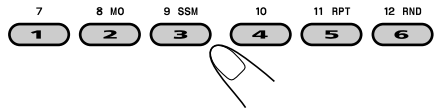

To check the current clock time while listening to an FM or AM station

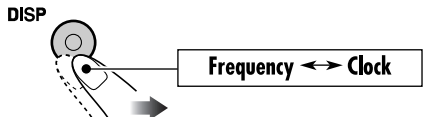

Disc operations

Playing a disc

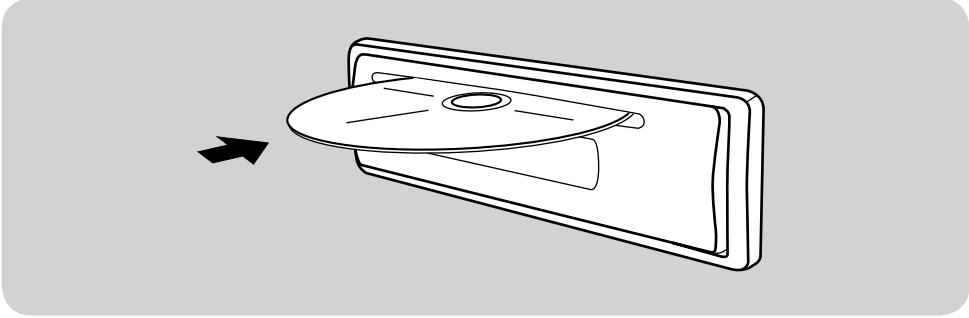

All tracks will be played repeatedly until you stop playback.

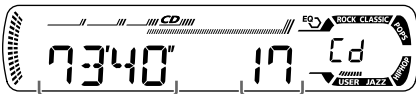
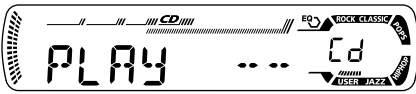

Total playing time of the inserted disc

Total track number of the inserted disc

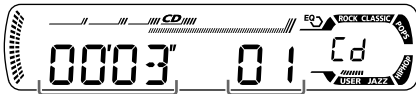

Elapsed playing time

Current track number

To stop play and eject the disc

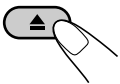

To fast-forward or reverse the track

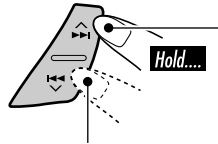

To go to the next or previous tracks

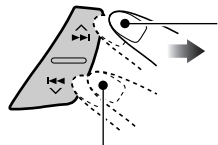

To go to a particular track directly

To select a number from 01 – 06:

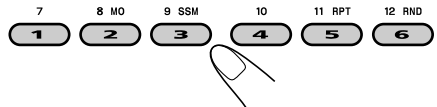

To select a number from 07 – 12:

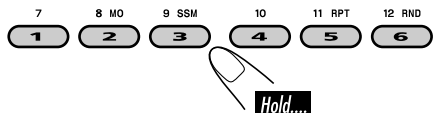

Prohibiting disc ejection

You can lock a disc in the loading slot.

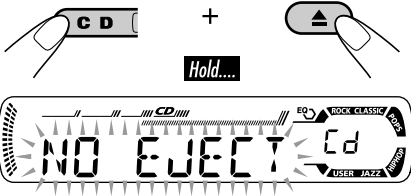

To cancel the prohibition, repeat the same procedure.

To check the current clock time while listening to a disc

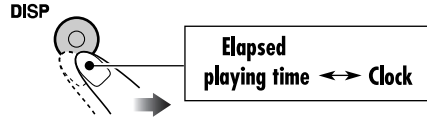

Selecting the playback modes

You can use only one of the following playback modes at a time.

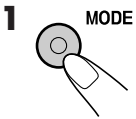

2 Select your desired playback mode.

Repeat play

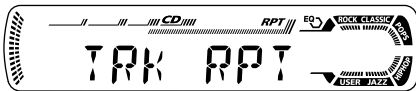
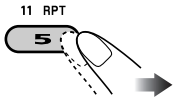

Ex.: When "TRK RPT" is selected

Mode	Plays repeatedly
------	------------------

TRK RPT: The current track.

- RPT lights up.

RPT OFF: Cancels repeat play.

Random play

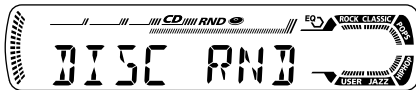
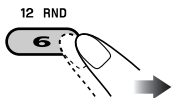

Ex.: When "DISC RND" is selected

Mode	Plays at random
------	-----------------

DISC RND: All tracks of the current disc.

- RND  lights up.

RND OFF: Cancels random play.

Sound adjustments

Selecting preset sound modes (C-EQ: custom equalizer)

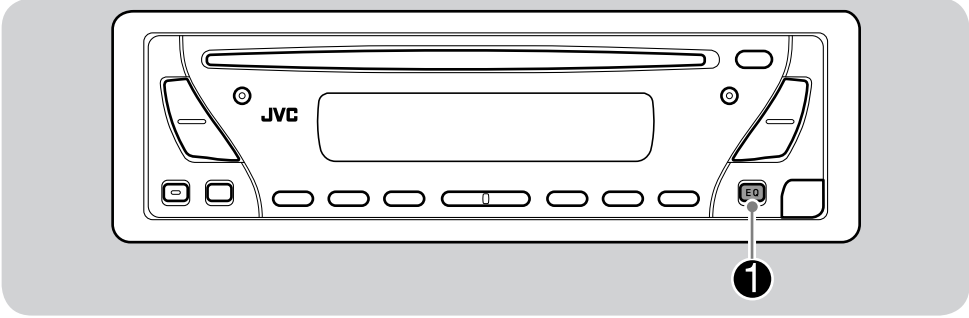

You can select a preset sound mode suitable to the music genre.

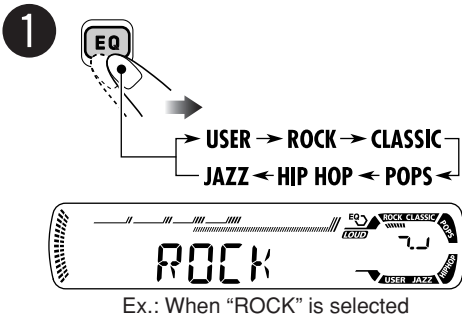

Indication	For:	Preset values		
		BAS* ¹	TRE* ²	LOUD* ³
USER	(Flat sound)	00	00	OFF
ROCK	Rock or disco music	+03	+01	ON
CLASSIC	Classical music	+01	-02	OFF
POPS	Light music	+04	+01	OFF
HIP HOP	Funk or rap music	+02	00	ON
JAZZ	Jazz music	+02	+03	OFF

Indication pattern for each sound mode:

USER	ROCK	CLASSIC
JAZZ	HIP HOP	POPS

*1 BAS: Bass

*2 TRE: Treble

*3 LOUD: Loudness

Adjusting the sound

You can adjust the sound characteristics to your preference.

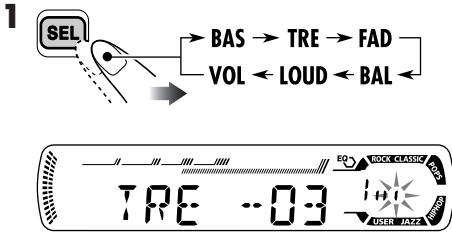

Ex.: When "TRE" is selected

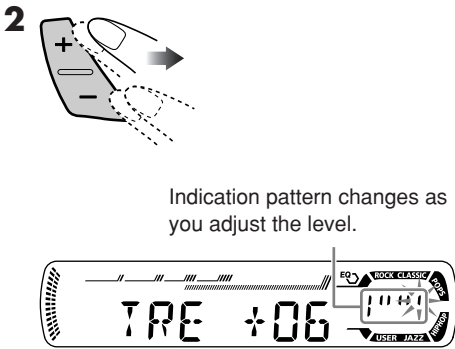

Indication pattern changes as you adjust the level.

Indication	To do:	Range
BAS* ¹ (bass)	Adjust the bass.	-06 (min.) to +06 (max.)
TRE* ¹ (treble)	Adjust the treble.	-06 (min.) to +06 (max.)
FAD* ² (fader)	Adjust the front and rear speaker balance.	R06 (Rear only) to F06 (Front only)
BAL (balance)	Adjust the left and right speaker balance.	L06 (Left only) to R06 (Right only)
LOUD* ¹ (loudness)	Boost low and high frequencies to produce a well-balanced sound at low volume level.	LOUD ON ↑ LOUD OFF
VOL* ³ (volume)	Adjust the volume.	00 (min.) to 30 or 50 (max.)* ⁴

*¹ When you adjust the bass, treble, or loudness, the adjustment you have made is stored for the currently selected sound mode (C-EQ) including "USER."

*² If you are using a two-speaker system, set the fader level to "00."

*³ Normally the +/- buttons work as the volume control. So you do not have to select "VOL" to adjust the volume level.

*⁴ Depending on the amplifier gain control setting. (See page 14 for details.)

General settings — PSM

Basic procedure

You can change PSM (Preferred Setting Mode) items listed on the table that follows.



2 Select a PSM item.

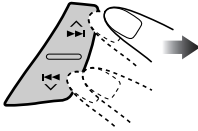

Ex.: When you select "AMP GAIN"

3 Adjust the PSM item selected.

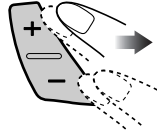

4 Repeat steps 2 and 3 to adjust the other PSM items if necessary.

5 Finish the procedure.



Indications	Selectable settings, [reference page]
<p>DEMO Display demonstration</p>	<p>DEMO ON: [Initial]; Display demonstration will be activated automatically if no operation is done for about 20 seconds, [7].</p> <p>DEMO OFF: Cancels.</p>
<p>CLOCK H Hour adjustment</p>	<p>0 – 23, [7] [Initial: 0 (0:00)]</p>
<p>CLOCK M Minute adjustment</p>	<p>00 – 59, [7] [Initial: 00 (0:00)]</p>
<p>AMP GAIN Amplifier gain control</p>	<p>You can change the maximum volume level of this receiver.</p> <p>LOW PWR: VOL 00 – VOL 30 (Select this if the maximum power of the speaker is less than 45 W to prevent them from damaging the speaker.)</p> <p>HIGH PWR: [Initial]; VOL 00 – VOL 50</p>

Detaching the control panel

When detaching or attaching the control panel, be careful not to damage the connectors on the back of the control panel and on the panel holder.

■ Detaching the control panel

Before detaching the control panel, be sure to turn off the power.

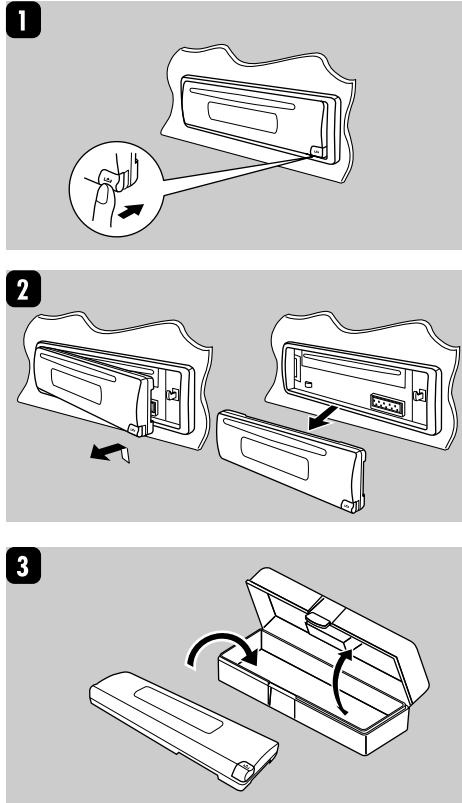

■ Attaching the control panel

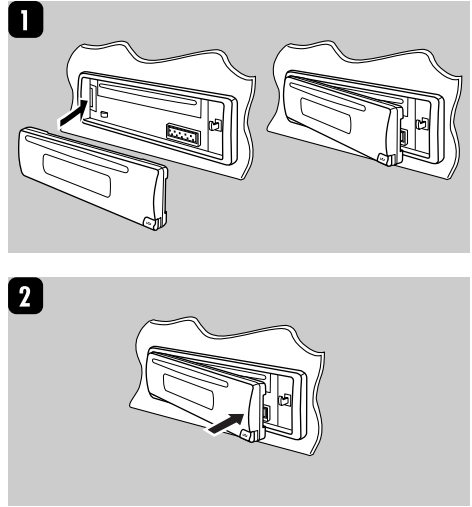

Maintenance

How to clean the connectors

Frequent detachment will deteriorate the connectors.

To minimize this possibility, periodically wipe the connectors with a cotton swab or cloth moistened with alcohol, being careful not to damage the connectors.

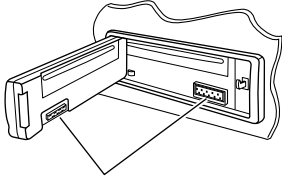

Connector

Moisture condensation

Moisture may condense on the lens inside the CD player in the following cases:

- After starting the heater in the car.
- If it becomes very humid inside the car.

Should this occur, the CD player may malfunction. In this case, eject the disc and leave the receiver turned on for a few hours until the moisture evaporates.

How to handle discs

When removing a disc from its case, press down the center holder of the case and lift the disc out, holding it by the edges.

Center holder



- Always hold the disc by the edges. Do not touch its recording surface.

When storing a disc into its case, gently insert the disc around the center holder (with the printed surface facing up).

- Make sure to store discs into the cases after use.

To keep discs clean

A dirty disc may not play correctly. If a disc does become dirty, wipe it with a soft cloth in a straight line from center to edge.



- Do not use any solvent (for example, conventional record cleaner, spray, thinner, benzine, etc.) to clean discs.

To play new discs

New discs may have some rough spots around the inner and outer edges. If such a disc is used, this receiver may reject the disc.



To remove these rough spots, rub the edges with a pencil or ball-point pen, etc.

Do not use the following discs:

Wrap disc



Sticker



Sticker residue

Disc



Stick-on label

More about this receiver

Basic operations

Turning off the power

- If you turn off the power while listening to a disc, disc play will start from where playback has been stopped previously, next time you turn on the power.

Tuner operations

Storing stations in memory

- During SSM search...
 - All previously stored stations are erased and stations are stored newly.
 - Received stations are preset in No. 1 (lowest frequency) to No. 6 (highest frequency).
 - When SSM is over, the station stored in No. 1 will be automatically tuned in.
- When storing a station manually, a previously preset station is erased when a new station is stored in the same preset number.

Disc operations

General

- This receiver has been designed to reproduce CDs, and CD-Rs (Recordable)/CD-RWs (Rewritable) in audio CD (CD-DA) format.
- When a disc has been loaded, selecting “CD” for the playback source starts disc play.

Inserting a disc

- When a disc is inserted upside down, the disc automatically ejects.
- Do not insert 8 cm discs (single CD) and unusual shape discs (heart, flower, etc) into the loading slot.

Playing a CD-R or CD-RW

- Use only “finalized” CD-Rs or CD-RWs.
- This receiver can play back multi-session discs; however, unclosed sessions will be skipped while playing.

- Some CD-Rs or CD-RWs may not play back on this receiver because of their disc characteristics, and for the following causes:
 - Discs are dirty or scratched.
 - Moisture condensation occurs on the lens inside the receiver.
 - The pickup lens inside the receiver is dirty.
 - CD-R or CD-RW on which the files are written with “Packet Write” method.
 - There are improper recording conditions (missing data, etc.) or media conditions (stain, scratch, warp, etc.).
 - CD-RWs may require a longer readout time since the reflectance of CD-RWs is lower than that of regular CDs.
 - Do not use the following CD-Rs or CD-RWs:
 - Discs with stickers, labels, or protective seal stuck to the surface.
 - Discs on which labels can be directly printed by an ink jet printer.
- Using these discs under high temperatures or high humidity may cause malfunctions or damage to discs.

Changing the source

- If you change the source, playback also stops (without ejecting the disc).
Next time you select “CD” for the playback source, disc play starts from where it has been stopped previously.

Ejecting a disc

- If the ejected disc is not removed within 15 seconds, the disc is automatically inserted again into the loading slot to prevent it from dust. (Disc will not play this time.)

General settings—PSM

- If you change the “AMP GAIN” setting from “HIGH PWR” to “LOW PWR” while the volume level is set higher than “VOL 30,” the receiver automatically changes the volume level to “VOL 30.”

Troubleshooting

What appears to be trouble is not always serious. Check the following points before calling a service center.

	Symptoms	Causes	Remedies
General	<ul style="list-style-type: none"> • Sound cannot be heard from the speakers. 	<p>The volume level is set to the minimum level.</p> <p>Connections are incorrect.</p>	<p>Adjust it to the optimum level.</p> <p>Check the cords and connections.</p>
	<ul style="list-style-type: none"> • The receiver does not work at all. 	<p>The built-in microcomputer may have functioned incorrectly due to noise, etc.</p>	<p>Reset the receiver (see page 2).</p>
FM/AM	<ul style="list-style-type: none"> • SSM automatic presetting does not work. 	<p>Signals are too weak.</p>	<p>Store stations manually.</p>
	<ul style="list-style-type: none"> • Static noise while listening to the radio. 	<p>The aerial is not connected firmly.</p>	<p>Connect the aerial firmly.</p>
Disc playback	<ul style="list-style-type: none"> • Disc automatically ejects. 	<p>Disc is inserted upside down.</p>	<p>Insert the disc correctly.</p>
	<ul style="list-style-type: none"> • CD-R/CD-RW cannot be played back. • Tracks on the CD-R/CD-RW cannot be skipped. 	<p>CD-R/CD-RW is not finalized.</p>	<ul style="list-style-type: none"> • Insert a finalized CD-R/CD-RW. • Finalize the CD-R/CD-RW with the component which you used for recording.
	<ul style="list-style-type: none"> • Disc can be neither played back nor ejected. 	<p>Disc is locked.</p>	<p>Unlock the disc (see page 11).</p>
		<p>The CD player may have functioned incorrectly.</p>	<p>Eject the disc forcibly (see page 2).</p>
	<ul style="list-style-type: none"> • Disc sound is sometimes interrupted. 	<p>You are driving on rough roads.</p>	<p>Stop playback while driving on rough roads.</p>
		<p>Disc is scratched.</p>	<p>Change the disc.</p>
		<p>Connections are incorrect.</p>	<p>Check the cords and connections.</p>
	<ul style="list-style-type: none"> • “NO DISC” appears on the display. 	<p>No disc in the loading slot.</p>	<p>Insert a disc into the loading slot.</p>
<p>Disc is inserted incorrectly.</p>		<p>Insert the disc correctly.</p>	

Specifications

AUDIO AMPLIFIER SECTION

Maximum Power Output:

Front: 45 W per channel

Rear: 45 W per channel

Continuous Power Output (RMS):

Front: 17 W per channel into 4 Ω , 40 Hz to 20 000 Hz at no more than 0.8% total harmonic distortion.

Rear: 17 W per channel into 4 Ω , 40 Hz to 20 000 Hz at no more than 0.8% total harmonic distortion.

Load Impedance: 4 Ω (4 Ω to 8 Ω allowance)

Tone Control Range:

Bass: ± 10 dB at 100 Hz

Treble: ± 10 dB at 10 kHz

Frequency Response: 40 Hz to 20 000 Hz

Signal-to-Noise Ratio: 70 dB

Line-Out Level/Impedance:

2.0 V/20 k Ω load (full scale)

Output Impedance: 1 k Ω

TUNER SECTION

Frequency Range:

FM: 87.5 MHz to 108.0 MHz

AM: (MW) 522 kHz to 1 620 kHz

(LW) 144 kHz to 279 kHz

[FM Tuner]

Usable Sensitivity: 11.3 dBf (1.0 μ V/75 Ω)

50 dB Quieting Sensitivity:

16.3 dBf (1.8 μ V/75 Ω)

Alternate Channel Selectivity (400 kHz): 65 dB

Frequency Response: 40 Hz to 15 000 Hz

Stereo Separation: 30 dB

Capture Ratio: 1.5 dB

[MW Tuner]

Sensitivity: 20 μ V

Selectivity: 35 dB

[LW Tuner]

Sensitivity: 50 μ V

CD PLAYER SECTION

Type: Compact disc player

Signal Detection System: Non-contact optical pickup (semiconductor laser)

Number of channels: 2 channels (stereo)

Frequency Response: 5 Hz to 20 000 Hz

Dynamic Range: 96 dB

Signal-to-Noise Ratio: 98 dB

Wow and Flutter: Less than measurable limit

GENERAL

Power Requirement:

Operating Voltage:

DC 14.4 V (11 V to 16 V allowance)

Grounding System: Negative ground

Allowable Operating Temperature:

0°C to +40°C

Dimensions (W \times H \times D):

Installation Size (approx.):

182 mm \times 52 mm \times 150 mm

Panel Size (approx.):

188 mm \times 58 mm \times 11 mm

Mass (approx.):

1.3 kg (excluding accessories)

Design and specifications are subject to change without notice.

Having TROUBLE with operation?

Please reset your unit

Refer to page of How to reset your unit

Haben Sie PROBLEME mit dem Betrieb?

Bitte setzen Sie Ihr Gerät zurück

Siehe Seite Zurücksetzen des Geräts

Затруднения при эксплуатации?

Пожалуйста, перезагрузите Ваше устройство

Для получения информации о перезагрузке Вашего устройства обратитесь на соответствующую страницу

JVC



EN, GE, RU

© 2004 Victor Company of Japan, Limited

1004DTSMdTJEIN

ENGLISH

This receiver is designed to operate on **12 V DC, NEGATIVE ground electrical systems**. If your vehicle does not have this system, a voltage inverter is required, which can be purchased at JVC IN-CAR ENTERTAINMENT dealers.

DEUTSCH

Dieses Gerät ist für einen Betrieb in **elektrischen Anlagen mit 12 V Gleichstrom und (-) Erdung ausgelegt**. Verfügt Ihr Fahrzeug nicht über diese Anlage, ist ein Spannungsinverter erforderlich, der bei JVC Autoradiohändler erworben werden kann.

РУССКИЙ

Это устройство разработано для эксплуатации на **12 В постоянного напряжения с минусом на массе**. Если Ваш автомобиль не имеет этой системы, требуется инвертор напряжения, который может быть приобретен у дилера автомобильного специалиста JVC.

Parts list for installation and connection

The following parts are provided for this receiver. After checking them, please set them correctly.

Teileliste für den Einbau und Anschluß

Die folgenden Teile werden zusammen mit diesem Gerät geliefert. Nach ihrer Überprüfung, die Teile richtig einsetzen.

Список деталей для установки и подключения

Следующие детали поставлены в комплекте с устройством. После проверки комплектации, пожалуйста, установите их правильно.

(A) / (B)
Hard case/Control panel
Etui/Schalttafel
Жесткий футляр/панель управления

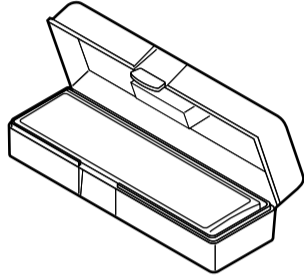

(C)
Sleeve
Halterung
Муфта

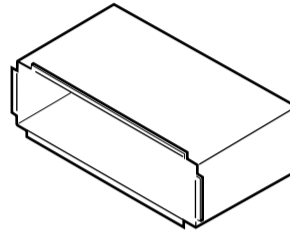

(D)
Trim plate
Frontrahmen
Декоративную панель

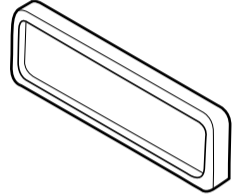

(E)
Power cord
Stromkable
Кабель питания

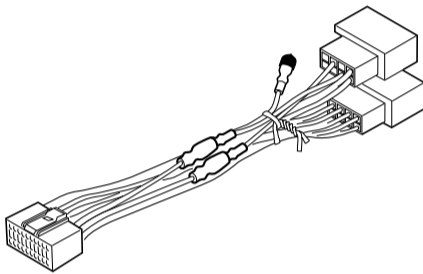

(F)
Washer (ø5)
Unterlegscheibe (ø5)
Шайба (н5)



(G)
Lock nut (M5)
Sicherungsmutter (M5)
Фиксирующая гайка (M5)



(H)
Mounting bolt (M5 x 20 mm)
Befestigungsschraube (M5 x 20 mm)
Крепежный болт (M5 x 20 мм)

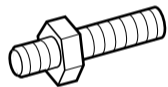

(I)
Rubber cushion
Gummipuffer
Резиновый чехол



(J)
Handles
Griffe
Рычаги

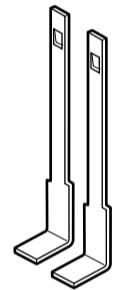

INSTALLATION (IN-DASH MOUNTING)

The following illustration shows a typical installation. If you have any questions or require information regarding installation kits, consult your JVC IN-CAR ENTERTAINMENT dealer or a company supplying kits.

- If you are not sure how to install this receiver correctly, have it installed by a qualified technician.

EINBAU (IM ARMATURENBRETT)

Die folgende Abbildung zeigt einen typischen Einbau. Bei irgendwelchen Fragen oder wenn Sie Informationen hinsichtlich des Einbausatzes brauchen, wenden Sie sich an ihren JVC Autoradiohändler oder ein Unternehmen das diese Einbausätze vertreibt.

- Sind Sie sich über den richtigen Einbau des Geräts nicht sicher, lassen Sie es von einem qualifizierten Techniker einbauen.

УСТАНОВКА (УСТАНОВКА В ПРИБОРНУЮ ПАНЕЛЬ)

На следующих иллюстрациях показана типовая установка. Если у Вас есть какие-либо вопросы, касающиеся установки, обратитесь к Вашему дилеру автомобильного специалиста JVC или в компанию, поставляющую соответствующие принадлежности.

- Если Вы не знаете точно, как следует устанавливать это устройство, обратитесь к квалифицированному специалисту.

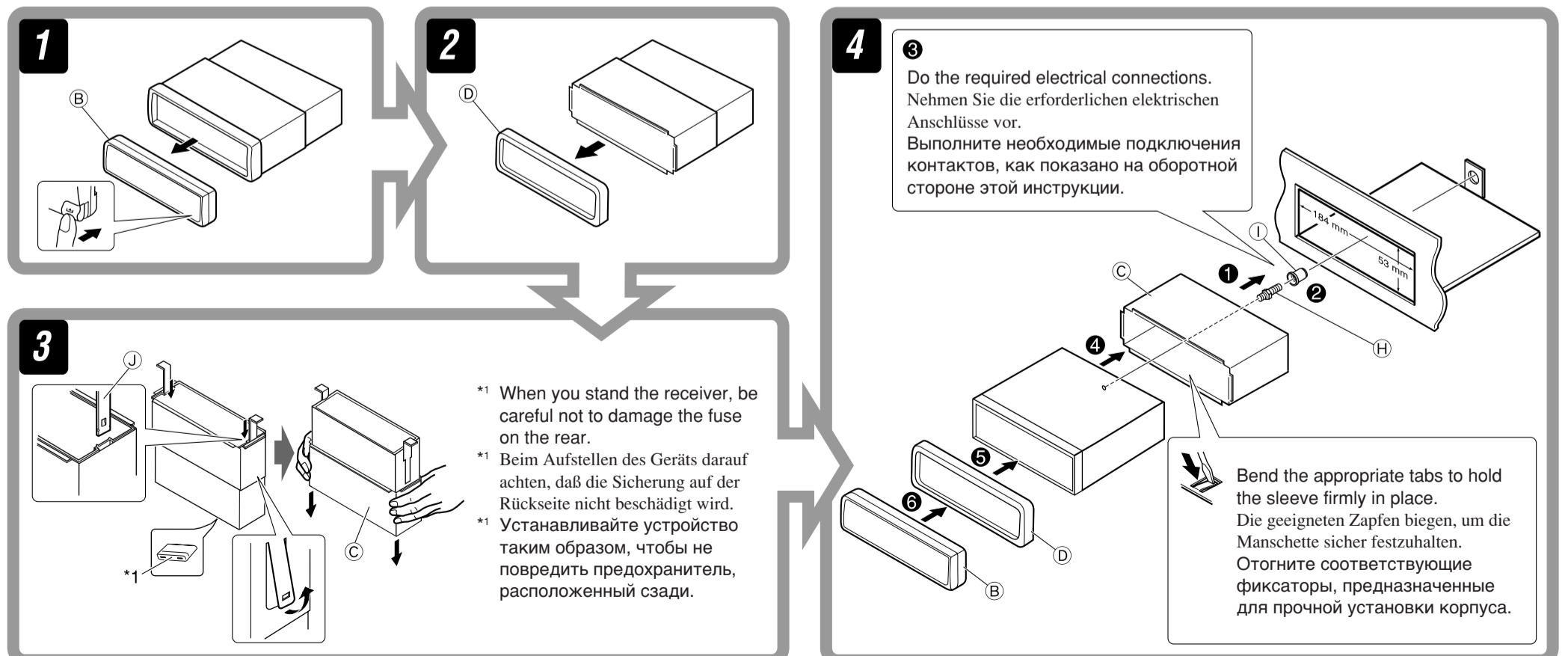

Removing the receiver

Before removing the receiver, release the rear section.

Ausbau des Geräts

Vor dem Ausbau des Geräts den hinteren Teil freigeben.

Удаление устройства

Перед удалением устройства освободите заднюю часть.

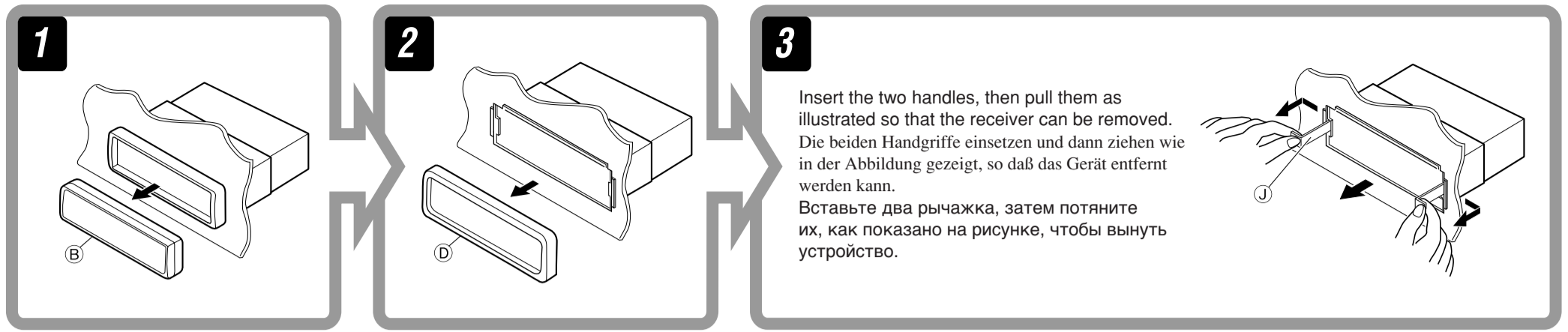

When using the optional stay / Beim Verwenden der Anker-Option / При использовании дополнительной стойки

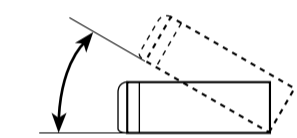
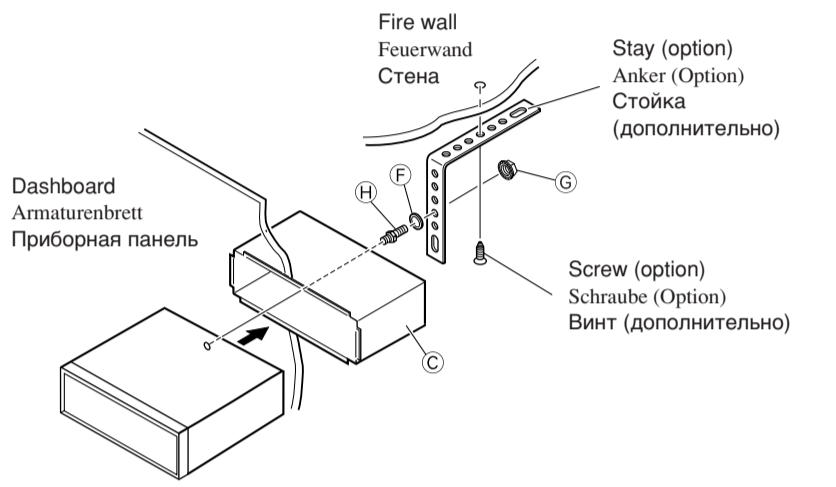

Install the receiver at an angle of less than 30°. Stellen Sie das Gerät mit einem Winkel von weniger als 30° auf. Установите устройство под углом менее 30°.

When installing the receiver without using the sleeve / Beim Einbau des Geräts ohne Halterung / При установке устройства без использования муфты

In a Toyota for example, first remove the car radio and install the receiver in its place.

Zum Beispiel in einem Toyota zuerst das Autoradio ausbauen und dann das Gerät an seinem Platz einbauen.

В автомобилях "Toyota", например, сначала удалите автомобильную магнитолу, затем установите на ее место это устройство.

Flat type screws (M5 x 8 mm)*
Senkkopfschrauben (M5 x 8 mm)*
Крепежные винты (M5 x 8 мм)*

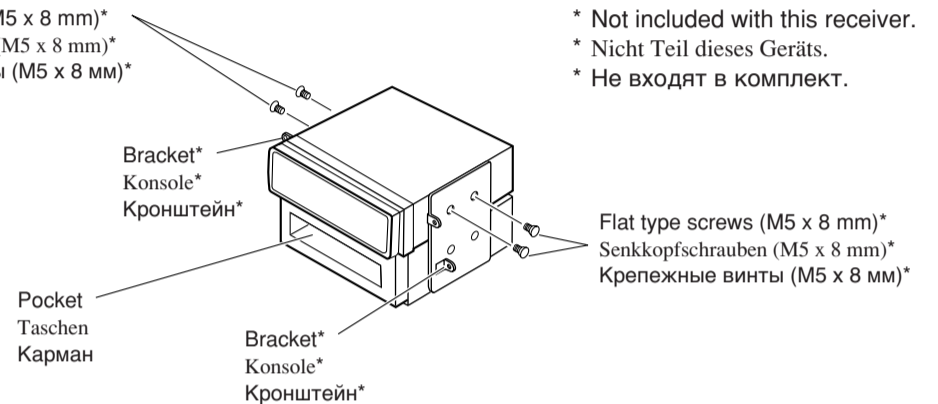

* Not included with this receiver.
* Nicht Teil dieses Geräts.
* Не входят в комплект.

Note

: When installing the receiver on the mounting bracket, make sure to use the 8 mm-long screws. If longer screws are used, they could damage the receiver.

Hinweis

: Beim Anbringen des Gerät an der Konsole sicherstellen, daß 8 mm lange Schrauben verwendet werden. Werden längere Schrauben verwendet, können sie das Gerät beschädigen.

Примечание

: При установке устройства на крепежный кронштейн, используйте только винты длиной 8 мм. При использовании более длинных винтов можно повредить устройство.

ELECTRICAL CONNECTIONS

To prevent short circuits, we recommend that you disconnect the battery's negative terminal and make all electrical connections before installing the receiver.

- Be sure to ground this receiver to the car's chassis again after installation.

Notes:

- Replace the fuse with one of the specified rating. If the fuse blows frequently, consult your JVC IN-CAR ENTERTAINMENT dealer.
- It is recommended to connect to the speakers with maximum power of more than 45 W (both at the rear and at the front, with an impedance of 4 Ω to 8 Ω). If the maximum power is less than 45 W, change "AMP GAIN" setting to prevent the speakers from being damaged (see page 14 of the INSTRUCTIONS).
- To prevent short-circuit, cover the terminals of the UNUSED leads with insulating tape.
- The heat sink becomes very hot after use. Be careful not to touch it when removing this receiver.

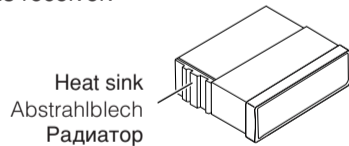

ELEKTRISCHE ANSCHLÜSSE

Zur Vermeidung von Kurzschlüssen empfehlen wir, daß Sie den negativen Batterieanschluß abtrennen und alle elektrischen Anschlüsse herstellen, bevor das Gerät eingebaut wird.

- Sicherstellen, daß das Gerät nach dem Einbau an Chassis des Fahrzeugs geerdet wird.

Hinweise:

- Die Sicherung mit einer der entsprechenden Nennleistung ersetzen. Brennt die Sicherung häufig durch, wenden Sie sich an ihren JVC Autoradiohändler.
- Es wird empfohlen, Lautsprecher mit einer Maximalleistung von mehr als 45 W anzuschließen (sowohl hinten als auch vorne, mit einer Impedanz von 4 Ω bis 8 Ω). Wenn die Maximalleistung weniger als 45 W beträgt, stellen Sie „AMP GAIN“ anders ein, um Schäden an den Lautsprechern zu vermeiden (siehe Seite 14 der BEDIENUNGSANLEITUNG).
- Zur Vermeidung eines Kurzschlusses die Anschlußklemmen der NICHT VERWENDETEN Leitungen mit Isolierklebeband umwickeln.
- Das Abstrahlblech wird nach dem Gebrauch sehr heiß. Beim Ausbau des Geräts darauf achten, das Abstrahlblech nicht zu berühren.

ЭЛЕКТРИЧЕСКИЕ ПОДКЛЮЧЕНИЯ

Для предотвращения коротких замыканий мы рекомендуем Вам отсоединить отрицательный разъем аккумулятора и осуществить все подключения перед установкой устройства.

- После установки обязательно заземлите данное устройство на шасси автомобиля.

Примечания:

- Заменяйте предохранитель другим предохранителем указанного класса. Если предохранитель сгорает слишком часто, обратитесь к дилеру автомобильного специалиста JVC.
- Рекомендуется подключать динамики с максимальной мощностью более 45 Вт (к задней и передней панели устройства, с полным сопротивлением от 4 Ω до 8 Ω). Если максимальная мощность динамиков менее 45 Вт, перейдите в режим "AMP GAIN", чтобы предотвратить их повреждение (см. ИНСТРУКЦИИ ПО ЭКСПЛУАТАЦИИ на стр. 14).
- Для предотвращения короткого замыкания заклейте НЕИСПОЛЬЗУЕМЫЕ концы изолирующей лентой.
- Радиатор во время использования сильно нагревается. Старайтесь его не трогать во время удаления устройства.

TROUBLESHOOTING

• The fuse blows.

- * Are the red and black leads connected correctly?

• Power cannot be turned on.

- * Is the yellow lead connected?

• No sound from the speakers.

- * Is the speaker output lead short-circuited?

• Sound is distorted.

- * Is the speaker output lead grounded?
- * Are the "-" terminals of L and R speakers grounded in common?

• Noise interfere with sounds.

- * Is the rear ground terminal connected to the car's chassis using shorter and thicker cords?

• Receiver becomes hot.

- * Is the speaker output lead grounded?
- * Are the "-" terminals of L and R speakers grounded in common?

• This receiver does not work at all.

- * Have you reset your receiver?

FEHLERSUCHE

• Die Sicherung brennt durch.

- * Sind die roten und schwarzen Leitungen richtig angeschlossen?

• Stromversorgung kann nicht eingeschaltet werden.

- * Ist die gelbe Leitung angeschlossen?

• Kein Ton aus den Lautsprechern.

- * Ist die LautsprecherAusgangsleitung kurzgeschlossen?

• Ton verzerrt.

- * Ist die LautsprecherAusgangsleitung geerdet?
- * Sind die (-) Anschlußklemmen der linken und rechten Lautsprecher zusammen geerdet?

• Störgeräusche im Klang.

- * Ist die hintere Erdungsklemme mit kürzeren und dickeren Kabeln an das Fahrzeugchassis angeschlossen?

• Gerät wird heiß.

- * Ist die LautsprecherAusgangsleitung geerdet?
- * Sind die (-) Anschlußklemmen der linken und rechten Lautsprecher zusammen geerdet?

• Dieser Receiver funktioniert überhaupt nicht.

- * Haben Sie einen Reset am Receiver vorgenommen?

ВЫЯВЛЕНИЕ НЕИСПРАВНОСТЕЙ

• Сработал предохранитель.

- * Правильно ли подключены черный и красный провода?

• Питание не включается.

- * Подключен ли желтый провод?

• Звук не выводится через громкоговорители.

- * Нет ли короткого замыкания на кабеле выхода громкоговорителей?

• Звук искажен.

- * Заземлен ли провод выхода громкоговорителей?
- * Заземлены ли разъемы "-" правого (R) и левого (L) громкоговорителей?

• Шум мешает звучанию.

- * Соединен ли находящийся сзади зажим заземления с шасси автомобиля с помощью более короткого и тонкого шнура?

• Устройство нагревается.

- * Заземлен ли провод выхода громкоговорителей?
- * Заземлены ли разъемы "-" правого (R) и левого (L) громкоговорителей?

• Приемник не работает.

- * Выполнена ли перенастройка приемника?

A If your car is equipped with the ISO connector / Wenn Ihr Auto mit ISO-Steckern ausgestattet ist / Если Ваш автомобиль оборудован разъемами ISO

- Connect the ISO connectors as illustrated.
- Die ISO-Stecker wie abgebildet anschließen.
- Подключите разъемы ISO, как показано на иллюстрации.

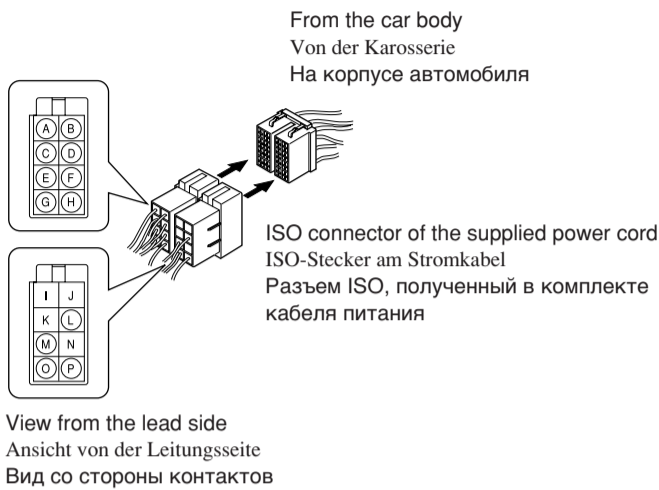

For some VW/Audi or Opel (Vauxhall) automobile / Für manche VW/Audi oder Opel (Vauxhall) Fahrzeuge / Для некоторых автомобилей VW/Audi или Opel (Vauxhall)

You may need to modify the wiring of the supplied power cord as illustrated.

- Contact your authorized car dealer before installing this receiver.
- Sie müssen evtl. die Verdrahtung des mitgelieferten Stromkabels wie abgebildet ändern.
- Wenden Sie sich an Ihre Vertragswerkstatt, bevor Sie das Gerät einbauen.

Вам может потребоваться изменение соединений полученного в комплекте кабеля питания, как показано на иллюстрации.

Original wiring / Originalverdrahtung / Исходное соединение

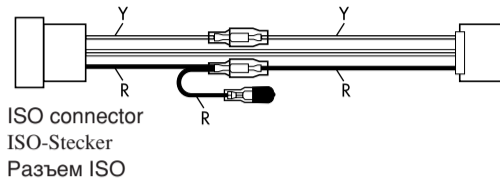

Y: Yellow
Gelb
Желтый

R: Red
Rot
Красный

Modified wiring 1 / Geänderte Verdrahtung 1 / Модифицированное соединение 1

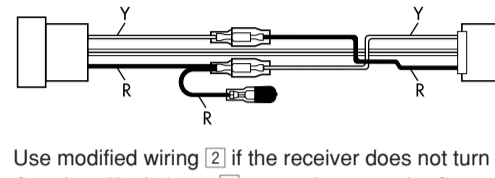

Use modified wiring 2 if the receiver does not turn on.
Geänderte Verdrahtung 2 verwenden, wenn das Gerät so nicht an geht.
Если устройство не включается, модифицируйте кабель по схеме 2.

Modified wiring 2 / Geänderte Verdrahtung 2 / Модифицированное соединение 2

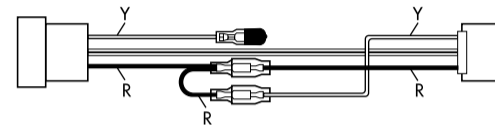

B Connections without using the ISO connectors / Anschlüsse ohne ISO-Stecker / Подключение без использования

Before connecting: Check the wiring in the vehicle carefully. Incorrect connection may cause serious damage to this receiver.

The leads of the power cord and those of the connector from the car body may be different in color.

- 1 Cut the ISO connector.
- 2 Connect the colored leads of the power cord in the order specified in the illustration below.
- 3 Connect the aerial cord.
- 4 Finally connect the wiring harness to the receiver.

Vor dem Anschließen: Die Verdrahtung im Fahrzeug sorgfältig überprüfen. Falsche Anschlüsse können ernsthafte Schäden am Gerät hervorrufen.

Die Leiter des Stromkabels und die Leiter des Anschlusses im Fahrzeug können sich farblich unterscheiden.

- 1 Den ISO-Stecker abschneiden.
- 2 Die farbigen Adern des Stromkabels in der Reihenfolge anschließen, wie in der Abbildung unten gezeigt.
- 3 Das Antennenkabel anschließen.
- 4 Die Kabelbäume am Gerät anschließen.

Перед началом подключений: Тщательно проверьте проводку в автомобиле. Неправильное подключение может привести к серьезному повреждению устройства. Жилы силового кабеля и жилы соединителя от кузова автомобиля могут быть разного цвета.

- 1 Отрежьте разъем ISO.
- 2 Подсоедините цветные провода шнура питания в указанном ниже порядке.
- 3 Подключите кабель антенны.
- 4 В последнюю очередь подключите электропроводку к устройству.

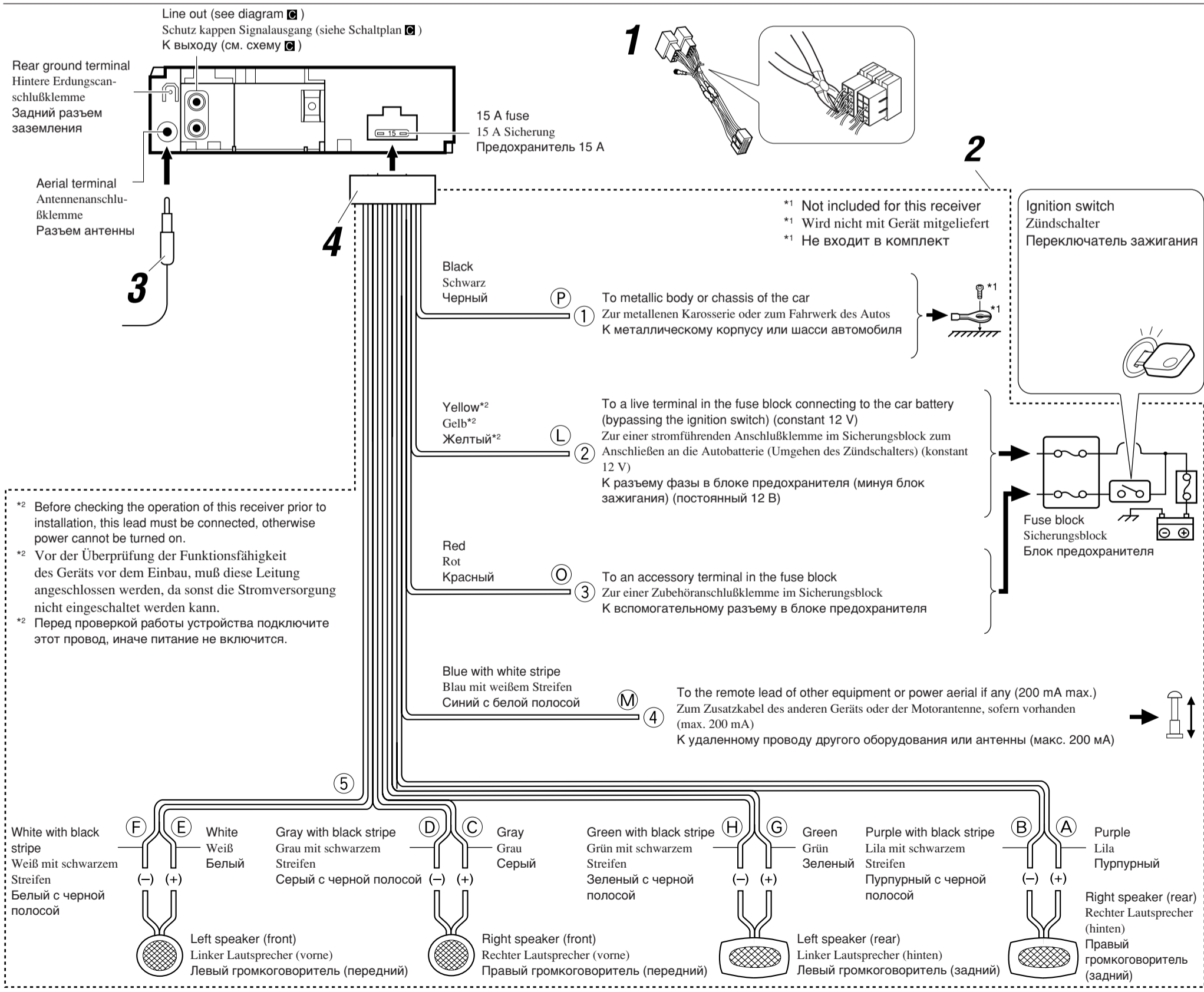

C Connecting the external amplifier / Anschließen des externen Verstärkers / Подключение внешнего усилителя

You can connect an amplifier to upgrade your car stereo system.

- Connect the remote lead (blue with white stripe) to the remote lead of the other equipment so that it can be controlled through this receiver.
- **Disconnect the speakers from this receiver, connect them to the amplifier. Leave the speaker leads of this receiver unused.**

Sie können einen Verstärker anschließen, um Ihre Autostereoanlage zu erweitern.

- Schließen Sie das Fernbedienungskabel (blau mit weißem Streifen) an das Fernbedienungskabel des anderen Geräts an, so daß es über dieses Gerät gesteuert werden kann.
- **Die Lautsprecher von diesem Gerät abtrennen und am Verstärker anschließen. Die Lautsprecherleitungen dieses Geräts unbenutzt lassen.**

Можно подключить усилитель для обновления автомобильной стереосистемы.

- Подсоедините провод внешнего устройства (синий с белой полосой) к проводу внешнего устройства другого оборудования так, чтобы им можно было управлять с этого устройства.
- **Отсоедините громкоговорители от данного устройства, подключите их к усилителю. Оставьте провода громкоговорителей данного устройства неиспользованными.**

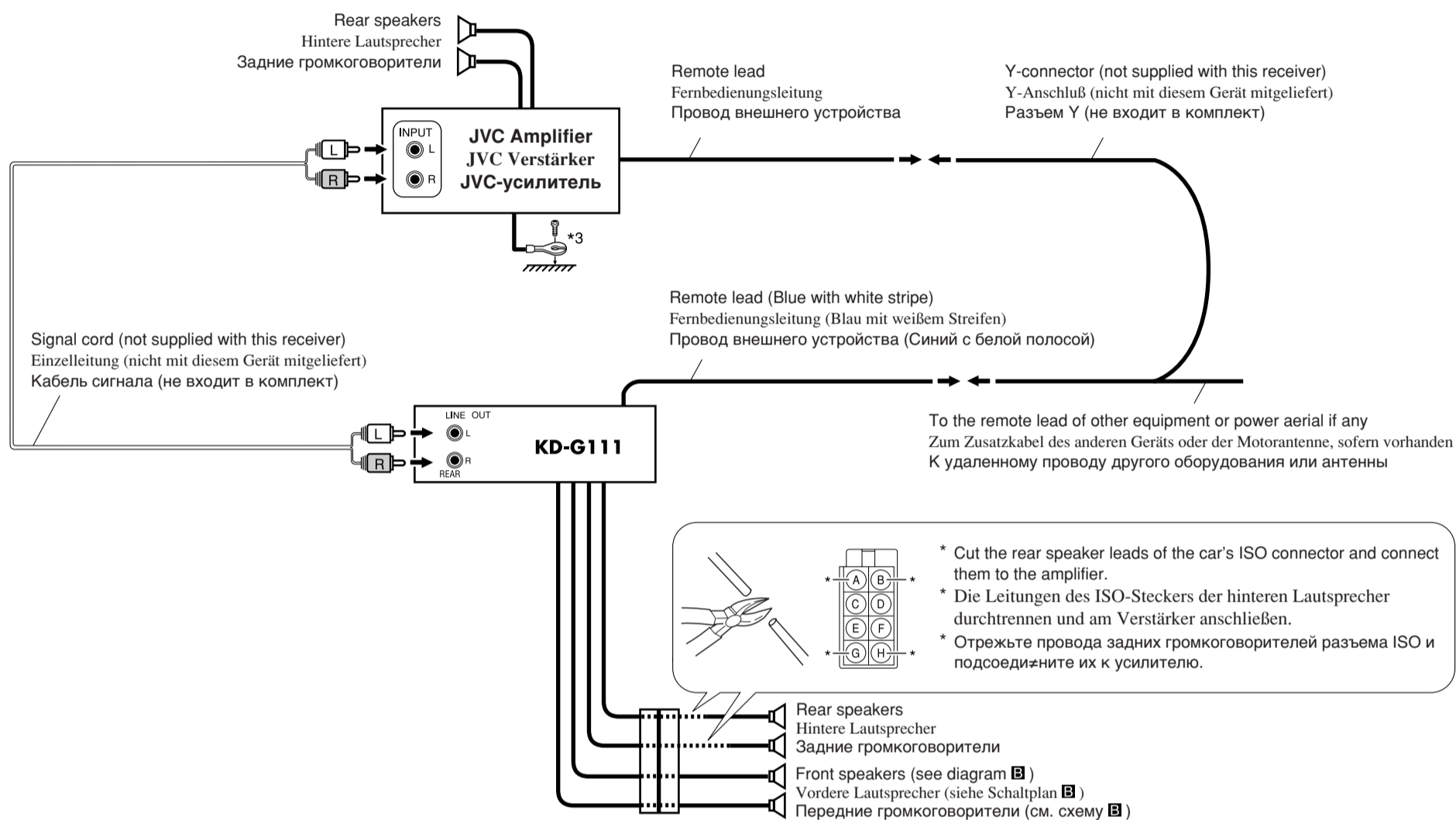

*3 Firmly attach the ground wire to the metallic body or to the chassis of the car—to the place not coated with paint (if coated with paint, remove the paint before attaching the wire). Failure to do so may cause damage to the receiver.

*3 Verbinden Sie den Erdungsleiter mit der Karosserie oder dem Rahmen des Fahrzeugs. Die Kontaktstelle darf nicht lackiert sein (sollte die Kontaktstelle lackiert sein, entfernen Sie den Lack der Kontaktstelle, bevor Sie den Leiter befestigen). Wenn der Erdungsleiter nicht ordnungsgemäß angeschlossen wird, kann dieses Gerät beschädigt werden.

*3 Плотнo прикрепите заземляющий провод к металлическому кузову или шасси автомобиля—в месте, не покрытом краской (если оно покрыто краской, удалите краску перед тем, как прикреплять провод). Невыполнение этого требования может привести к повреждению данного устройства.

PRECAUTIONS on power supply and speaker connections:

- **DO NOT** connect the speaker leads of the power cord to the car battery; otherwise, the receiver will be seriously damaged.
- **BEFORE** connecting the speaker leads of the power cord to the speakers, check the speaker wiring in your car.

VORSICHTSMASSREGELN beim Anschließen der Stromversorgung und Lautsprecher:

- Die Lautsprecherleitungen des Netzkabels **NICHT** an der Autobatterie anschließen, da sonst das Gerät schwer beschädigt wird.
- VOR dem Anschließen der Lautsprecherleitungen des Spannungsversorgungskabels an die Lautsprecher, die Lautsprecherverdrahtung in Ihrem Auto überprüfen.

ПРЕДОСТЕРЕЖЕНИЯ по питанию и подключению громкоговорителей:

- **НЕ** подключайте провода громкоговорителей к аккумулятору автомобиля, иначе устройство будет повреждено.
- **ПЕРЕД** подключением проводов громкоговорителей к кабелю питания громкоговорителя проверьте схему соединений громкоговорителей в Вашем автомобиле.

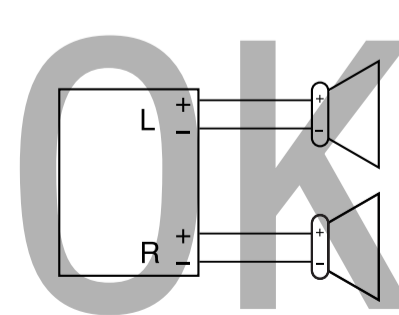
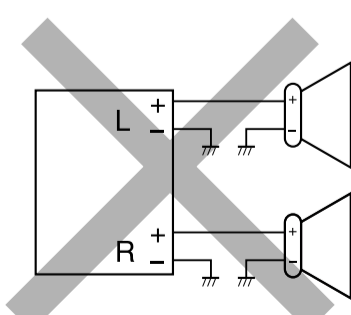
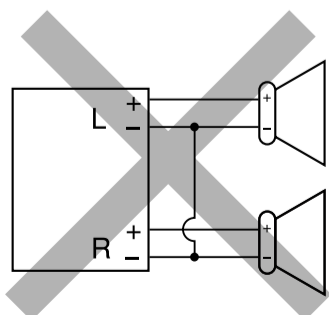

JVC



ENGLISH

РУССКИЙ

CD RECEIVER РЕСИВЕР С ПРОИГРЫВАТЕЛЕМ КОМПАКТ-ДИСКОВ

KD-G117

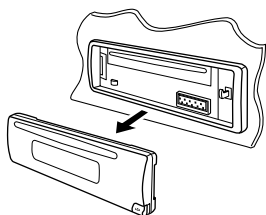

COMPACT
disc
DIGITAL AUDIO

CD-RW

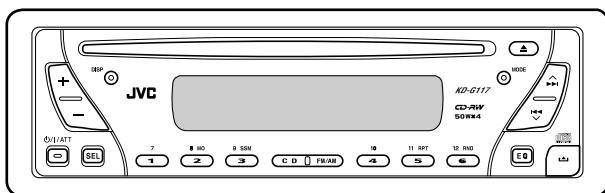

В соответствии с Законом Российской Федерации “О защите прав потребителей” срок службы (годности) данного товара “по истечении которого он может представлять опасность для жизни, здоровья потребителя, причинять вред его имуществу или окружающей среде” составляет семь (7) лет со дня производства. Этот срок является временем, в течение которого потребитель данного товара может безопасно им пользоваться при условии соблюдения инструкции по эксплуатации данного товара, проводя необходимое обслуживание, включающее замену расходных материалов и/или соответствующее ремонтное обеспечение в специализированном сервисном центре.

Дополнительные косметические материалы к данному товару, поставляемые вместе с ним, могут храниться в течение двух (2) лет со дня его производства.

Срок службы (годности), кроме срока хранения дополнительных косметических материалов, упомянутых в предыдущих двух пунктах, не затрагивает никаких других прав потребителя, в частности, гарантийного свидетельства JVC, которое он может получить в соответствии с законом о правах потребителя или других законов, связанных с ним.

For installation and connections, refer to the separate manual.

Указания по установке и выполнению соединений приводятся в отдельной инструкции.

For canceling the display demonstration, see page 7.

Информацию об отмене демонстрации функций дисплея см. на стр. 7.

INSTRUCTIONS ИНСТРУКЦИИ ПО ЭКСПЛУАТАЦИИ



GET0254-001A
[EE]

Thank you for purchasing a JVC product.

Please read all instructions carefully before operation, to ensure your complete understanding and to obtain the best possible performance from the unit.

IMPORTANT FOR LASER PRODUCTS

1. CLASS 1 LASER PRODUCT
2. **CAUTION:** Do not open the top cover. There are no user serviceable parts inside the unit; leave all servicing to qualified service personnel.
3. **CAUTION:** Visible and invisible laser radiation when open and interlock failed or defeated. Avoid direct exposure to beam.
4. REPRODUCTION OF LABEL: CAUTION LABEL, PLACED OUTSIDE THE UNIT.

CAUTION: Visible and invisible laser radiation when open and interlock failed or defeated. AVOID DIRECT EXPOSURE TO BEAM.	ADVARSEL: Synlig og usynlig laserstråling når maskinen er åpen eller interlocken fejler. UNNGÅ DIREKTE EKSPONERING TI STRÅLING.	WARNING: Synlig och osynlig laserstråling när den öppnas och spärren är urkopplad. Beträkta strålen.	VARO: Avalttaessa ja suojalukitus ohittettuna tai viallisena ollet alttina näkyvälle ja näkymättömälle lasersträilylle. Vältä säteen kohotustumista suoraan itseesi. (f)
--	--	---	---

Warning:

If you need to operate the receiver while driving, be sure to look ahead carefully or you may be involved in a traffic accident.

How to reset your unit



- This will reset the microcomputer. Your preset adjustments will also be erased.
- If a disc is loaded, it will eject. Be careful not to drop the disc.

How to forcibly eject a disc

If a disc cannot be recognized by the receiver or cannot be ejected, ejects the disc as follows.

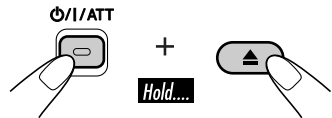

- If this does not work, try to reset your receiver.
- Be careful not to drop the disc when it ejects.

Contents

How to reset your unit	2	Sound adjustments	12
How to forcibly eject a disc	2	Selecting preset sound modes	
How to read this manual	4	(C-EQ: custom equalizer)	12
How to use the MODE button	4	Adjusting the sound	13
Control panel — KD-G117	5	General settings — PSM	14
Parts identification	5	Basic procedure	14
Getting started	6	Detaching the control panel....	15
Basic operations	6	Maintenance	16
Canceling the display demonstrations ...	7	More about this receiver	17
Setting the clock	7	Troubleshooting	18
Radio operations	8	Specifications	19
Listening to the radio.....	8		
Storing stations in memory	9		
Listening to a preset station	9		
Disc operations	10		
Playing a disc	10		
Selecting the playback modes.....	11		

***For safety....**

- Do not raise the volume level too much, as this will block outside sounds, making driving dangerous.
- Stop the car before performing any complicated operations.





***Temperature inside the car....**

If you have parked the car for a long time in hot or cold weather, wait until the temperature in the car becomes normal before operating the unit.

How to read this manual

The following methods are used to make the explanations simple and easy-to-understand:

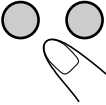
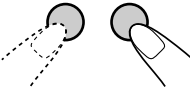
- Some related tips and notes are explained in “More about this receiver” (see page 17).
- Button operations are mainly explained with the illustrations as follows:

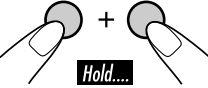
	Press briefly.
	Press repeatedly.
	Press either one.
	
	Press and hold until your desired response begins.
	Press and hold both buttons at the same time.

How to use the MODE button

If you press MODE, the receiver goes into functions mode, then the number buttons work as different function buttons.

Ex.: When number button 2 works as MO (monaural) button.

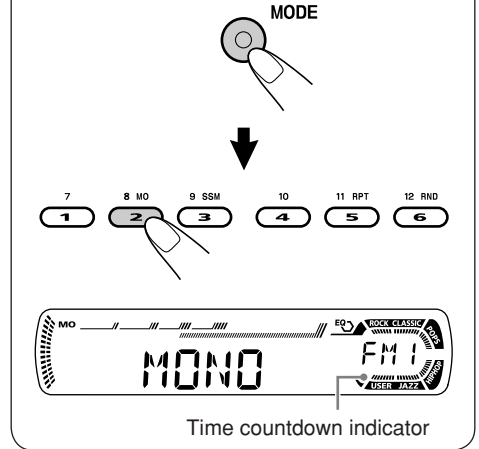

To use these buttons for original functions again after pressing **MODE**, wait for 5 seconds without pressing any of these buttons until the functions mode is cleared.

- Pressing **MODE** again also clears the functions mode.

Parts identification

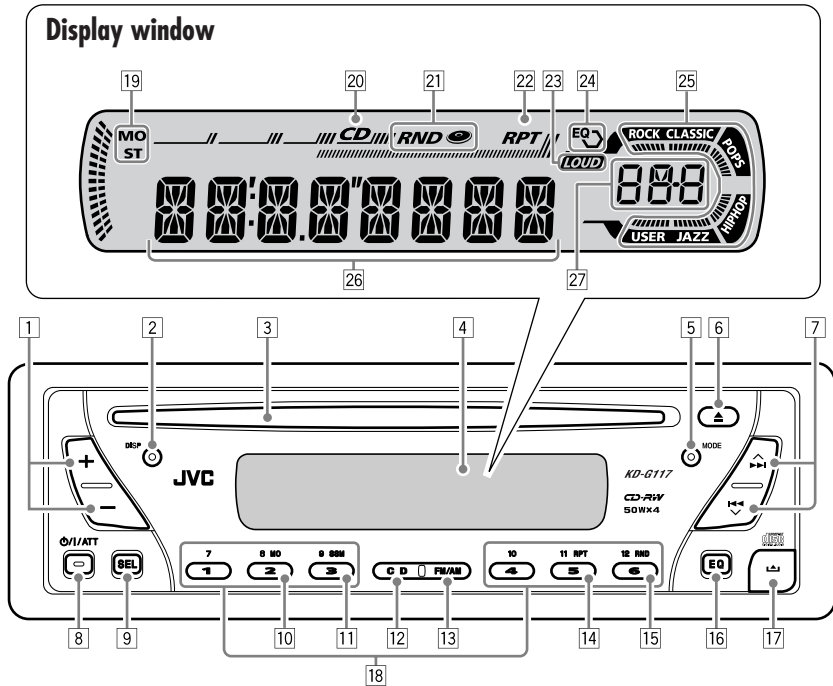

- 1 +/- buttons
- 2 DISP (display) button
- 3 Loading slot
- 4 Display window
- 5 MODE button
- 6 ▲ (eject) button
- 7 ▲▶▶/|◀◀▼ buttons
- 8 ⏻/I/ATT (standby/on/attenuator) button
- 9 SEL (select) button
- 10 MO (monaural) button
- 11 SSM (Strong-station Sequential Memory) button
- 12 CD button
- 13 FM/AM button
- 14 RPT (repeat) button
- 15 RND (random) button
- 16 EQ (equalizer) button
- 17 🗑️ (control panel release) button
- 18 Number buttons

Display window

- 19 Tuner reception indicators
MO (monaural), ST (stereo)
- 20 CD indicator
- 21 RND (disc random) indicator
- 22 RPT (repeat) indicator
- 23 LOUD (loudness) indicator
- 24 EQ (equalizer) indicator
- 25 Sound mode (C-EQ: custom equalizer) indicators
ROCK, CLASSIC, POPS, HIP HOP, JAZZ, USER
 - also works as the time countdown indicator.
- 26 Main display
- 27 Source display
Volume level indicator

Getting started

Basic operations

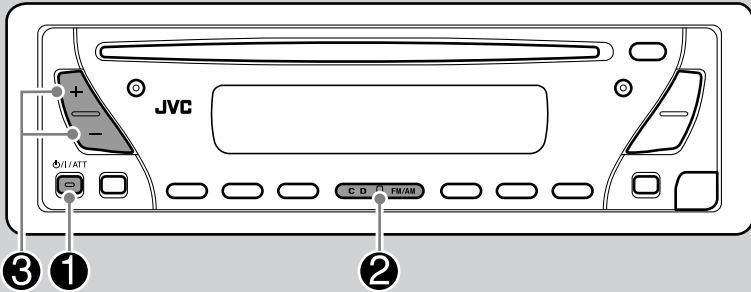

1



To drop the volume in a moment (ATT)



To restore the sound, press it again.

2

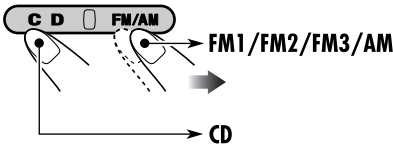

To turn off the power

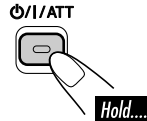

You cannot select “CD” as the playback source if there is no disc in the loading slot.

Caution on volume setting:

Discs produce very little noise compared with other sources. Lower the volume before playing a disc to avoid damaging the speakers by the sudden increase of the output level.

3

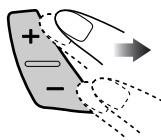

Volume level appears.

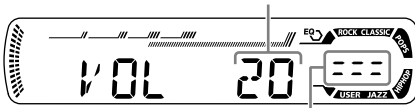

Volume level indicator

4

Adjust the sound as you want.
(See pages 12 and 13.)

Canceling the display demonstrations

If no operations are done for about 20 seconds, display demonstration starts.

[Initial: DEMO ON]—see page 14.

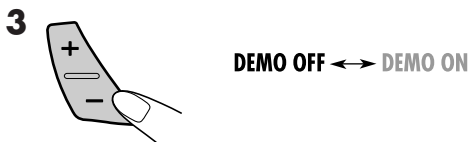
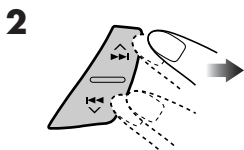

4 Finish the procedure.



To activate the display demonstration

In step 3 above...

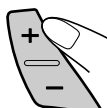

DEMO OFF ↔ DEMO ON

Setting the clock



2 Set the hour and minute.

1 Select “CLOCK H” (hour), then adjust the hour.

2 Select “CLOCK M” (minute), then adjust the minute.

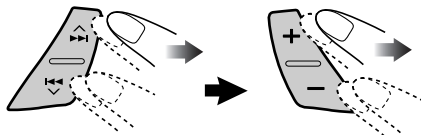

3 Finish the procedure.



To check the current clock time when the power is turned off

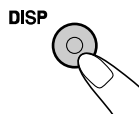

Radio operations

Listening to the radio

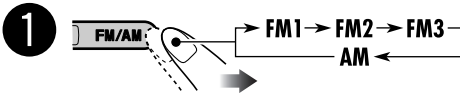
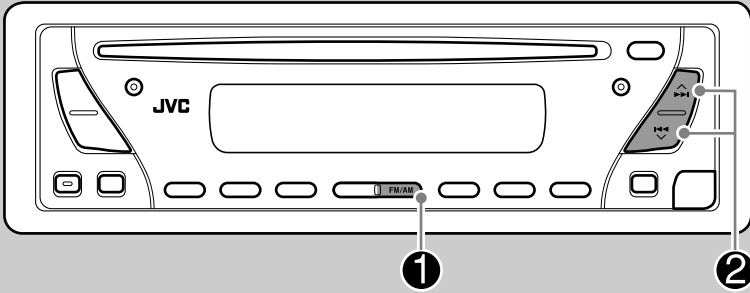

Lights up when receiving an FM stereo broadcast with sufficient signal strength.

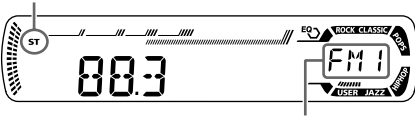

Selected band appears.

2 Start searching for a station.

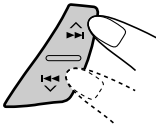

When a station is received, searching stops.

To stop searching, press the same button again.

Note:

FM1 and FM2: 87.5 MHz – 108.0 MHz

FM3: 65.00 MHz – 74.00 MHz

2 Select the desired station frequencies.

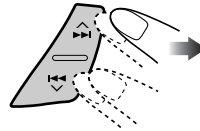

When an FM stereo broadcast is hard to receive

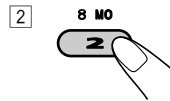
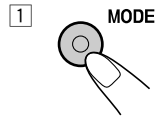

Lights up when monaural mode is activated.



Reception improves, but stereo effect will be lost.

To tune in to a station manually

In step 2 above...

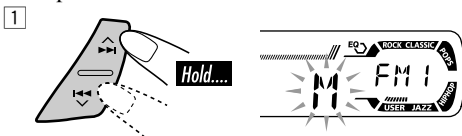

To restore the stereo effect, repeat the same procedure. "MONO OFF" appears and the MO indicator goes off.

Storing stations in memory

You can preset six stations for each band.

FM station automatic presetting—SSM (Strong-station Sequential Memory)

- 1 Select the FM band (FM1 – FM3) you want to store into.

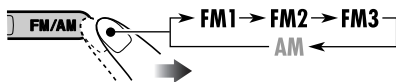

- 2 **MODE**
-

- 3 **9 SSM**
-



“SSM” flashes, then disappears when automatic presetting is over.

Local FM stations with the strongest signals are searched and stored automatically in the FM band.

Manual presetting

Ex.: Storing FM station of 92.5 MHz into the preset number 4 of the FM1 band.

- 1
-

- 2
-

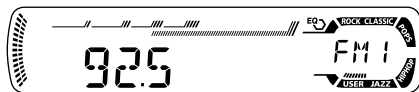

- 3 **10**
-

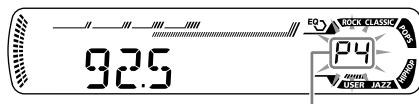

Preset number flashes for a while.

Listening to a preset station

- 1
-

- 2 Select the preset station (1 – 6) you want.

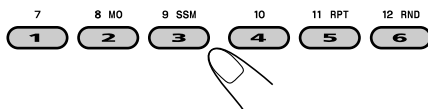

To check the current clock time while listening to an FM or AM station

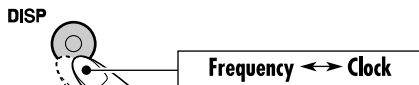

Disc operations

Playing a disc

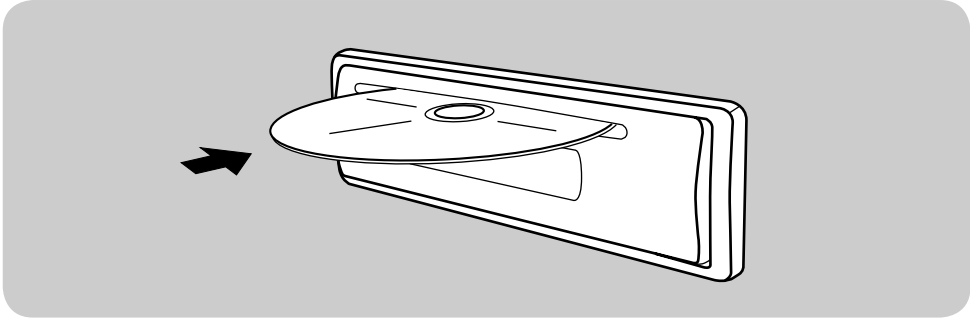

All tracks will be played repeatedly until you change the source or eject the disc.

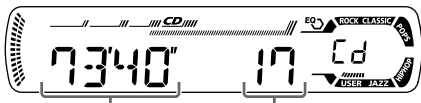
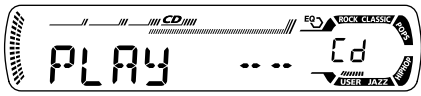

Total playing time of the inserted disc Total track number of the inserted disc



Elapsed playing time Current track number

To stop play and eject the disc

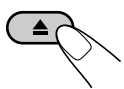

To fast-forward or reverse the track

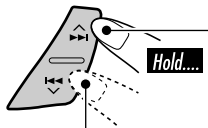

Fast-forwards.

Hold....

Reverses.

To go to the next or previous tracks

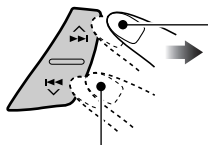

To the following tracks.

To the beginning of the current track, then the previous tracks.

To go to a particular track directly

To select a number from 01 – 06:



To select a number from 07 – 12:



Hold....

Prohibiting disc ejection

You can lock a disc in the loading slot.

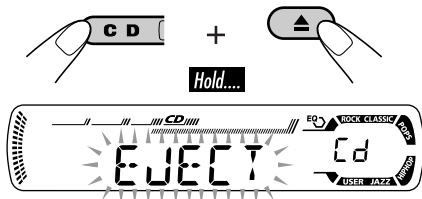

To check the current clock time while listening to a disc

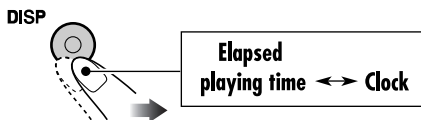

To cancel the prohibition, repeat the same procedure.

Selecting the playback modes

You can use only one of the following playback modes at a time.

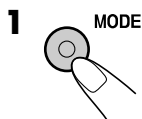

2 Select your desired playback mode.

Repeat play

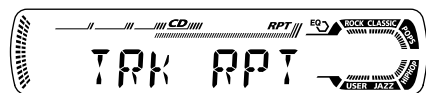
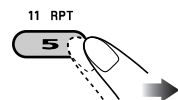

Ex.: When "TRK RPT" is selected

Mode	Plays repeatedly
TRK RPT:	The current track. • RPT lights up.
RPT OFF:	Cancels.

Random play

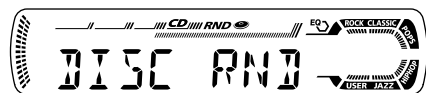
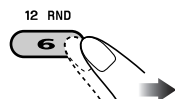

Ex.: When "DISC RND" is selected

Mode	Plays at random
DISC RND:	All tracks of the current disc. • RND  lights up.
RND OFF:	Cancels.

Sound adjustments

Selecting preset sound modes (C-EQ: custom equalizer)

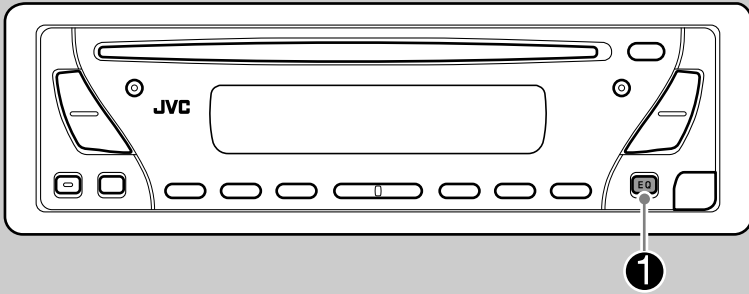

You can select a preset sound mode suitable to the music genre.

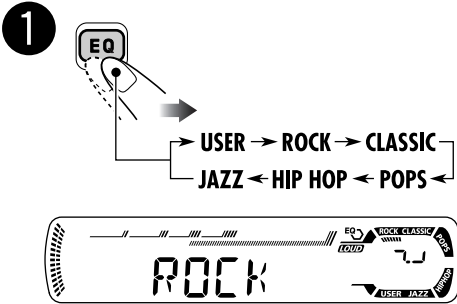

Ex.: When "ROCK" is selected

Indication	For:	Preset values		
		BAS ^{*1}	TRE ^{*2}	LOUD ^{*3}
USER	(Flat sound)	00	00	OFF
ROCK	Rock or disco music	+03	+01	ON
CLASSIC	Classical music	+01	-02	OFF
POPS	Light music	+04	+01	OFF
HIP HOP	Funk or rap music	+02	00	ON
JAZZ	Jazz music	+02	+03	OFF

*1 *BAS*: Bass

*2 *TRE*: Treble

*3 *LOUD*: Loudness

Indication pattern for each sound mode:

USER	ROCK	CLASSIC
JAZZ	HIP HOP	POPS

Adjusting the sound

You can adjust the sound characteristics to your preference.

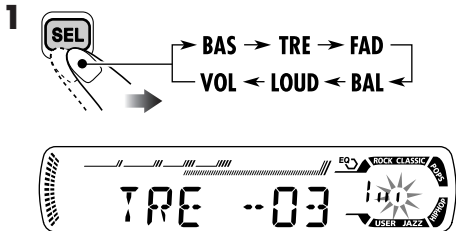

Ex.: When "TRE" is selected

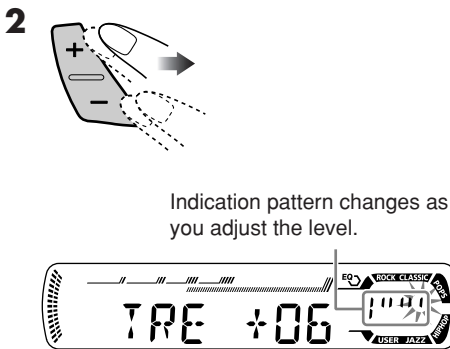

Indication pattern changes as you adjust the level.

Indication	To do:	Range
BAS* ¹ (bass)	Adjust the bass.	-06 (min.) to +06 (max.)
TRE* ¹ (treble)	Adjust the treble.	-06 (min.) to +06 (max.)
FAD* ² (fader)	Adjust the front and rear speaker balance.	R06 (Rear only) to F06 (Front only)
BAL (balance)	Adjust the left and right speaker balance.	L06 (Left only) to R06 (Right only)
LOUD* ¹ (loudness)	Boost low and high frequencies to produce a well-balanced sound at low volume level.	LOUD ON ↕ LOUD OFF
VOL* ³ (volume)	Adjust the volume.	00 (min.) to 30 or 50 (max.)* ⁴

*¹ When you adjust the bass, treble, or loudness, the adjustment you have made is stored for the currently selected sound mode (C-EQ) including "USER."

*² If you are using a two-speaker system, set the fader level to "00."

*³ Normally the +/- buttons work as the volume control. So you do not have to select "VOL" to adjust the volume level.

*⁴ Depending on the amplifier gain control setting. (See page 14 for details.)

General settings — PSM

Basic procedure

You can change PSM (Preferred Setting Mode) items listed on the table that follows.

1



Hold....

2 Select a PSM item.

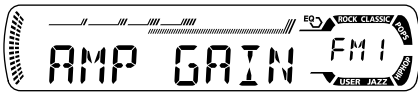
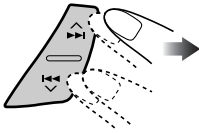

Ex.: When you select "AMP GAIN"

3 Adjust the PSM item selected.

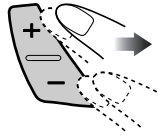

4 Repeat steps 2 and 3 to adjust the other PSM items if necessary.

5 Finish the procedure.



Indications	Selectable settings, [reference page]
DEMO Display demonstration	DEMO ON: [Initial]; Display demonstration will be activated automatically if no operation is done for about 20 seconds, [7]. DEMO OFF: Cancels.
CLOCK H Hour adjustment	0 – 23, [7] [Initial: 0 (0:00)]
CLOCK M Minute adjustment	00 – 59, [7] [Initial: 00 (0:00)]
AMP GAIN Amplifier gain control	You can change the maximum volume level of this receiver. LOW PWR: VOL 00 – VOL 30 (Select this if the maximum power of the speaker is less than 50 W to prevent them from damaging the speaker.) HIGH PWR: [Initial]; VOL 00 – VOL 50

Detaching the control panel

When detaching or attaching the control panel, be careful not to damage the connectors on the back of the control panel and on the panel holder.

■ Detaching the control panel

Before detaching the control panel, be sure to turn off the power.

■ Attaching the control panel

1

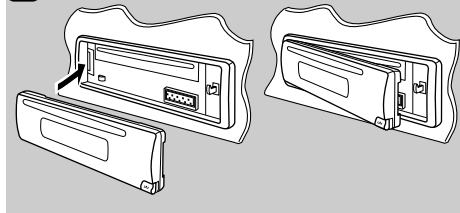

2

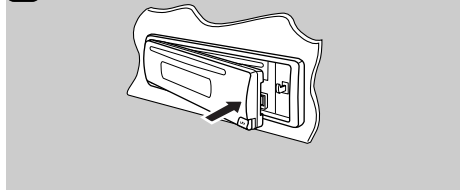

1

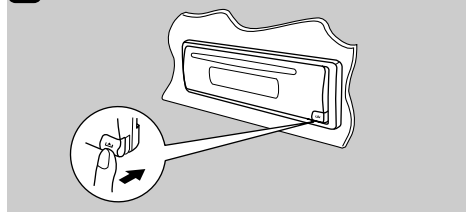

2

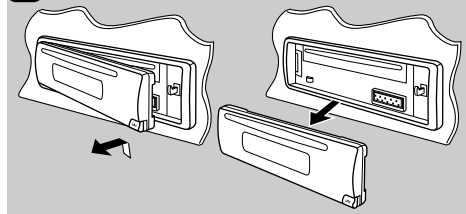

3

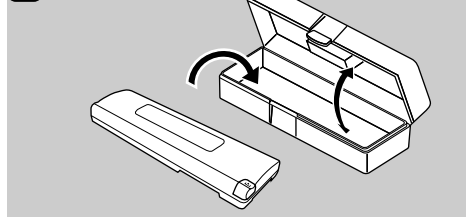

Maintenance

How to clean the connectors

Frequent detachment will deteriorate the connectors.

To minimize this possibility, periodically wipe the connectors with a cotton swab or cloth moistened with alcohol, being careful not to damage the connectors.

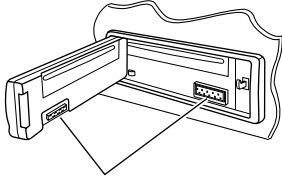

Connector

Moisture condensation

Moisture may condense on the lens inside the CD player in the following cases:

- After starting the heater in the car.
- If it becomes very humid inside the car.

Should this occur, the CD player may malfunction. In this case, eject the disc and leave the receiver turned on for a few hours until the moisture evaporates.

How to handle discs

When removing a disc from its case, press down the center holder of the case and lift the disc out, holding it by the edges.

Center holder



- Always hold the disc by the edges. Do not touch its recording surface.

When storing a disc into its case, gently insert the disc around the center holder (with the printed surface facing up).

- Make sure to store discs into the cases after use.

To keep discs clean

A dirty disc may not play correctly. If a disc does become dirty, wipe it with a soft cloth in a straight line from center to edge.



- Do not use any solvent (for example, conventional record cleaner, spray, thinner, benzine, etc.) to clean discs.

To play new discs

New discs may have some rough spots around the inner and outer edges. If such a disc is used, this receiver may reject the disc.



To remove these rough spots, rub the edges with a pencil or ball-point pen, etc.

Do not use the following discs:

Warped disc



Sticker



Sticker residue

Disc



Stick-on label

More about this receiver

Basic operations

Turning off the power

- If you turn off the power while listening to a disc, disc play will start from where playback has been stopped previously, next time you turn on the power.

Tuner operations

Storing stations in memory

- During SSM search...
 - All previously stored stations are erased and stations are stored newly.
 - Received stations are preset in No. 1 (lowest frequency) to No. 6 (highest frequency).
 - When SSM is over, the station stored in No. 1 will be automatically tuned in.
- When storing a station manually, a previously preset station is erased when a new station is stored in the same preset number.

Disc operations

General

- This receiver has been designed to reproduce CDs, and CD-Rs (Recordable)/ CD-RWs (Rewritable) in audio CD (CD-DA) format.
- When a disc has been loaded, selecting “CD” for the playback source starts disc play.

Inserting a disc

- When a disc is inserted upside down, the disc automatically ejects.
- Do not insert 8 cm discs (single CD) and unusual shape discs (heart, flower, etc.) into the loading slot.

Playing a CD-R or CD-RW

- Use only “finalized” CD-Rs or CD-RWs.
- This receiver can play back multi-session discs; however, unclosed sessions will be skipped while playing.

- Some CD-Rs or CD-RWs may not play back on this receiver because of their disc characteristics, and for the following causes:
 - Discs are dirty or scratched.
 - Moisture condensation occurs on the lens inside the receiver.
 - The pickup lens inside the receiver is dirty.
 - CD-R or CD-RW on which the files are written with “Packet Write” method.
 - There are improper recording conditions (missing data, etc.) or media conditions (stain, scratch, warp, etc.).
- CD-RWs may require a longer readout time since the reflectance of CD-RWs is lower than that of regular CDs.
- Do not use the following CD-Rs or CD-RWs:
 - Discs with stickers, labels, or protective seal stuck to the surface.
 - Discs on which labels can be directly printed by an ink jet printer.Using these discs under high temperatures or high humidities may cause malfunctions or damages to discs.

Changing the source

- If you change the source, playback also stops (without ejecting the disc). Next time you select “CD” for the playback source, disc play starts from where it has been stopped previously.

Ejecting a disc

- If the ejected disc is not removed within 15 seconds, the disc is automatically inserted again into the loading slot to prevent it from dust. (Disc will not play this time.)

General settings—PSM

- If you change the “AMP GAIN” setting from “HIGH PWR” to “LOW PWR” while the volume level is set higher than “VOL 30,” the receiver automatically changes the volume level to “VOL 30.”

Troubleshooting

What appears to be trouble is not always serious. Check the following points before calling a service center.

	Symptoms	Causes	Remedies
General	• Sound cannot be heard from the speakers.	The volume level is set to the minimum level.	Adjust it to the optimum level.
		Connections are incorrect.	Check the cords and connections.
	• This receiver does not work at all.	The built-in microcomputer may have functioned incorrectly due to noise, etc.	Reset the receiver (see page 2).
FM/AM	• SSM automatic presetting does not work.	Signals are too weak.	Store stations manually.
	• Static noise while listening to the radio.	The aerial is not connected firmly.	Connect the aerial firmly.
Disc playback	• Disc automatically ejects.	Disc is inserted upside down.	Insert the disc correctly.
	• CD-R/CD-RW cannot be played back. • Tracks on the CD-R/CD-RW cannot be skipped.	CD-R/CD-RW is not finalized.	• Insert a finalized CD-R/CD-RW. • Finalize the CD-R/CD-RW with the component which you used for recording.
	• Disc can be neither played back nor ejected.	Disc is locked.	Unlock the disc (see page 11).
		The CD player may have functioned incorrectly.	Eject the disc forcibly (see page 2).
	• Disc sound is sometimes interrupted.	You are driving on rough roads.	Stop playback while driving on rough roads.
		Disc is scratched.	Change the disc.
		Connections are incorrect.	Check the cords and connections.
• “NO DISC” appears on the display.	No disc is in the loading slot.	Insert a disc into the loading slot.	
	Disc is inserted incorrectly.	Insert the disc correctly.	

Specifications

AUDIO AMPLIFIER SECTION

Maximum Power Output:

Front: 50 W per channel

Rear: 50 W per channel

Continuous Power Output (RMS):

Front: 19 W per channel into 4 Ω , 40 Hz to 20 000 Hz at no more than 0.8% total harmonic distortion.

Rear: 19 W per channel into 4 Ω , 40 Hz to 20 000 Hz at no more than 0.8% total harmonic distortion.

Load Impedance: 4 Ω (4 Ω to 8 Ω allowance)

Tone Control Range:

Bass: ± 10 dB at 100 Hz

Treble: ± 10 dB at 10 kHz

Frequency Response: 40 Hz to 20 000 Hz

Signal-to-Noise Ratio: 70 dB

Line-Out Level/Impedance:

2.0 V/20 k Ω load (full scale)

Output Impedance: 1 k Ω

TUNER SECTION

Frequency Range:

FM1/FM2: 87.5 MHz to 108.0 MHz

FM3: 65.00 MHz to 74.00 MHz

AM: (MW) 522 kHz to 1 620 kHz
(LW) 144 kHz to 279 kHz

[FM Tuner]

Usable Sensitivity: 11.3 dBf (1.0 μ V/75 Ω)

50 dB Quieting Sensitivity:

16.3 dBf (1.8 μ V/75 Ω)

Alternate Channel Selectivity (400 kHz): 65 dB

Frequency Response: 40 Hz to 15 000 Hz

Stereo Separation: 30 dB

Capture Ratio: 1.5 dB

[MW Tuner]

Sensitivity: 20 μ V

Selectivity: 35 dB

[LW Tuner]

Sensitivity: 50 μ V

CD PLAYER SECTION

Type: Compact disc player

Signal Detection System: Non-contact optical pickup (semiconductor laser)

Number of channels: 2 channels (stereo)

Frequency Response: 5 Hz to 20 000 Hz

Dynamic Range: 96 dB

Signal-to-Noise Ratio: 98 dB

Wow and Flutter: Less than measurable limit

GENERAL

Power Requirement:

Operating Voltage:

DC 14.4 V (11 V to 16 V allowance)

Grounding System: Negative ground

Allowable Operating Temperature:

0°C to +40°C

Dimensions (W \times H \times D):

Installation Size (approx.):

182 mm \times 52 mm \times 150 mm

Panel Size (approx.):

188 mm \times 58 mm \times 11 mm

Mass (approx.):

1.3 kg (excluding accessories)

Design and specifications are subject to change without notice.



Having TROUBLE with operation?

Please reset your unit

Refer to page of How to reset your unit

Затруднения при эксплуатации?

Пожалуйста, перезагрузите Ваше устройство

Для получения информации о перезагрузке Вашего устройства обратитесь на соответствующую страницу

JVC



EN, RU

© 2004 Victor Company of Japan, Limited

1004DTSMDTJEIN

JVC KD-G117

Installation/Connection Manual

Руководство по установке/подключению

GET0254-002A
[EE]

1004DTSMDTJEIN
EN, RU

ENGLISH

This receiver is designed to operate on **12 V DC, NEGATIVE ground electrical systems**. If your vehicle does not have this system, a voltage inverter is required, which can be purchased at JVC IN-CAR ENTERTAINMENT dealers.

РУССКИЙ

Это устройство разработано для эксплуатации на **12 В постоянного напряжения с минусом на массе**. Если Ваш автомобиль не имеет этой системы, требуется инвертор напряжения, который может быть приобретен у дилера автомобильного специалиста JVC.

Parts list for installation and connection

The following parts are provided for this receiver. After checking them, please set them correctly.

(A) / (B)
Hard case/Control panel
Жесткий футляр/
панель управления

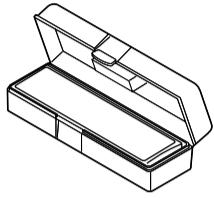

(C)
Sleeve
Муфта

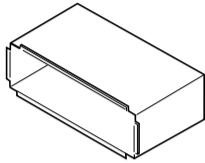

(D)
Trim plate
Декоративную панель

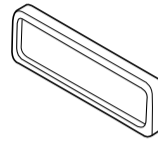

(E)
Power cord
Кабель питания

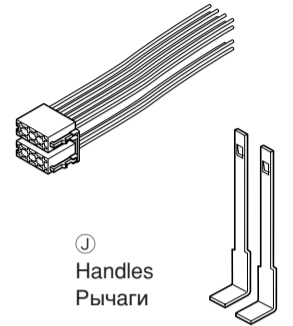

(F)
Washer (ø5)
Шайба (h5)



(G)
Lock nut (M5)
Фиксирующая гайка (M5)



(H)
Mounting bolt (M5 x 20 mm)
Крепежный болт (M5 x 20 мм)

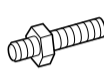

(I)
Rubber cushion
Резиновый чехол



(J)
Handles
Рычаги

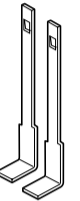

INSTALLATION (IN-DASH MOUNTING)

The following illustration shows a typical installation. If you have any questions or require information regarding installation kits, consult your JVC IN-CAR ENTERTAINMENT dealer or a company supplying kits.

• If you are not sure how to install this receiver correctly, have it installed by a qualified technician.

УСТАНОВКА (УСТАНОВКА В ПРИБОРНУЮ ПАНЕЛЬ)

На следующих иллюстрациях показана типовая установка. Если у Вас есть какие-либо вопросы, касающиеся установки, обратитесь к Вашему дилеру автомобильного специалиста JVC или в компанию, поставляющую соответствующие принадлежности.

• Если Вы не знаете точно, как следует устанавливать это устройство, обратитесь к квалифицированному специалисту.

1

2

3

*1 When you stand the receiver, be careful not to damage the fuse on the rear.
*1 Устанавливайте устройство таким образом, чтобы не повредить предохранитель, расположенный сзади.

4

Do the required electrical connections. Выполните необходимые подключения контактов, как показано на оборотной стороне этой инструкции.

Bend the appropriate tabs to hold the sleeve firmly in place. Отогните соответствующие фиксаторы, предназначенные для прочной установки корпуса.

Removing the receiver / Удаление устройства

Before removing the receiver, release the rear section. Перед удалением устройства освободите заднюю часть.

1

2

3

Insert the two handles, then pull them as illustrated so that the receiver can be removed. Вставьте два рычажка, затем потяните их, как показано на рисунке, чтобы вынуть устройство.

When using the optional stay / При использовании дополнительной стойки

Stay (option) / Стойка (дополнительно)

Fire wall / Стена

Dashboard / Приборная панель

Screw (option) / Винт (дополнительно)

Install the receiver at an angle of less than 30°. Установите устройство под углом менее 30°.

When installing the receiver without using the sleeve / При установке устройства без использования муфты

In a Toyota for example, first remove the car radio and install the receiver in its place. В автомобилях "Toyota", например, сначала удалите автомобильную магнитолу, затем установите на ее место это устройство.

Flat type screws (M5 x 8 mm)* / Крепежные винты (M5 x 8 мм)*

Bracket* / Кронштейн*

Pocket / Карман

Bracket* / Кронштейн*

Flat type screws (M5 x 8 mm)* / Крепежные винты (M5 x 8 мм)*

Note: When installing the receiver on the mounting bracket, make sure to use the 8 mm-long screws. If longer screws are used, they could damage the receiver.
Примечание: При установке устройства на крепежный кронштейн, используйте только винты длиной 8 мм. При использовании более длинных винтов можно повредить устройство.

TROUBLESHOOTING

- **The fuse blows.**
* Are the red and black leads connected correctly?
- **Power cannot be turned on.**
* Is the yellow lead connected?
- **No sound from the speakers.**
* Is the speaker output lead short-circuited?
- **Sound is distorted.**
* Is the speaker output lead grounded?
* Are the "-" terminals of L and R speakers grounded in common?
- **Noise interfere with sounds.**
* Is the rear ground terminal connected to the car's chassis using shorter and thicker cords?
- **Receiver becomes hot.**
* Is the speaker output lead grounded?
* Are the "-" terminals of L and R speakers grounded in common?
- **This receiver does not work at all.**
* Have you reset your receiver?

ВЫЯВЛЕНИЕ НЕИСПРАВНОСТЕЙ

- **Сработал предохранитель.**
* Правильно ли подключены черный и красный провода?
- **Питание не включается.**
* Подключен ли желтый провод?
- **Звук не выводится через громкоговорители.**
* Нет ли короткого замыкания на кабеле выхода громкоговорителей?
- **Звук искажен.**
* Заземлен ли провод выхода громкоговорителей?
* Заземлены ли разъемы "-" правого (R) и левого (L) громкоговорителей?
- **Шум мешает звучанию.**
* Соединен ли находящийся сзади зажим заземления с шасси автомобиля с помощью более короткого и тонкого шнура?
- **Устройство нагревается.**
* Заземлен ли провод выхода громкоговорителей?
* Заземлены ли разъемы "-" правого (R) и левого (L) громкоговорителей?
- **Приемник не работает.**
* Выполнена ли перенастройка приемника?

ELECTRICAL CONNECTIONS

To prevent short circuits, we recommend that you disconnect the battery's negative terminal and make all electrical connections before installing the receiver.

- **Be sure to ground this receiver to the car's chassis again after installation.**

Notes:

- Replace the fuse with one of the specified rating. If the fuse blows frequently, consult your JVC IN-CAR ENTERTAINMENT dealer.
- It is recommended to connect to the speakers with maximum power of more than 50 W (both at the rear and at the front, with an impedance of 4 Ω to 8 Ω). If the maximum power is less than 50 W, change "AMP GAIN" setting to prevent the speakers from being damaged (see page 14 of the INSTRUCTIONS).
- To prevent short-circuit, cover the terminals of the UNUSED leads with insulating tape.
- The heat sink becomes very hot after use. Be careful not to touch it when removing this receiver.

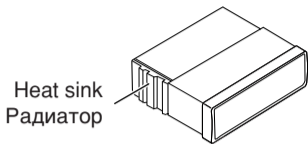

ЭЛЕКТРИЧЕСКИЕ ПОДКЛЮЧЕНИЯ

Для предотвращения коротких замыканий мы рекомендуем Вам отсоединить отрицательный разъем аккумулятора и осуществить все подключения перед установкой устройства.

- **После установки обязательно заземлите данное устройство на шасси автомобиля.**

Примечания:

- Заменяйте предохранитель другим предохранителем указанного класса. Если предохранитель сгорает слишком часто, обратитесь к дилеру автомобильного специалиста JVC.
- Рекомендуется подключать динамики с максимальной мощностью более 50 Вт (к задней и передней панели устройства, с полным сопротивлением от 4 Ω до 8 Ω). Если максимальная мощность динамиков менее 50 Вт, перейдите в режим "AMP GAIN", чтобы предотвратить их повреждение (см. ИНСТРУКЦИИ ПО ЭКСПЛУАТАЦИИ на стр. 14).
- Для предотвращения короткого замыкания заклейте НЕИСПОЛЬЗУЕМЫЕ концы изолирующей лентой.
- Радиатор во время использования сильно нагревается. Старайтесь его не трогать во время удаления устройства.

A Typical connections / Типичные подключения

Before connecting: Check the wiring in the vehicle carefully. Incorrect connection may cause serious damage to this receiver. The leads of the power cord and those of the connector from the car body may be different in color.

- 1 Connect the colored leads of the power cord in the order specified in the illustration below.
- 2 Connect the aerial cord.
- 3 Finally connect the wiring harness to the receiver.

Note: If your vehicle does not have any accessory terminal, move the fuse from the fuse position 1 (initial position) to fuse position 2, and connect the red lead (A7) to the positive (+) battery terminal.

- The yellow lead (A4) is not used in this case.

Перед началом подключений: Тщательно проверьте проводку в автомобиле. Неправильное подключение может привести к серьезному повреждению устройства. Жилы силового кабеля и жилы соединителя от кузова автомобиля могут быть разного цвета.

- 1 Подсоедините цветные провода шнура питания в указанном ниже порядке.
- 2 Подключите кабель антенны.
- 3 В последнюю очередь подключите электропроводку к устройству.

Примечание: Если в Вашем автомобиле никакого вспомогательного разъема не имеется, переставьте предохранитель из положения 1 предохранителя (первоначальное положение) в положение 2 предохранителя и подключите красный провод (A7) к положительному (+) полюсу аккумулятора.

- Желтый провод (A4) в этом случае не используется.

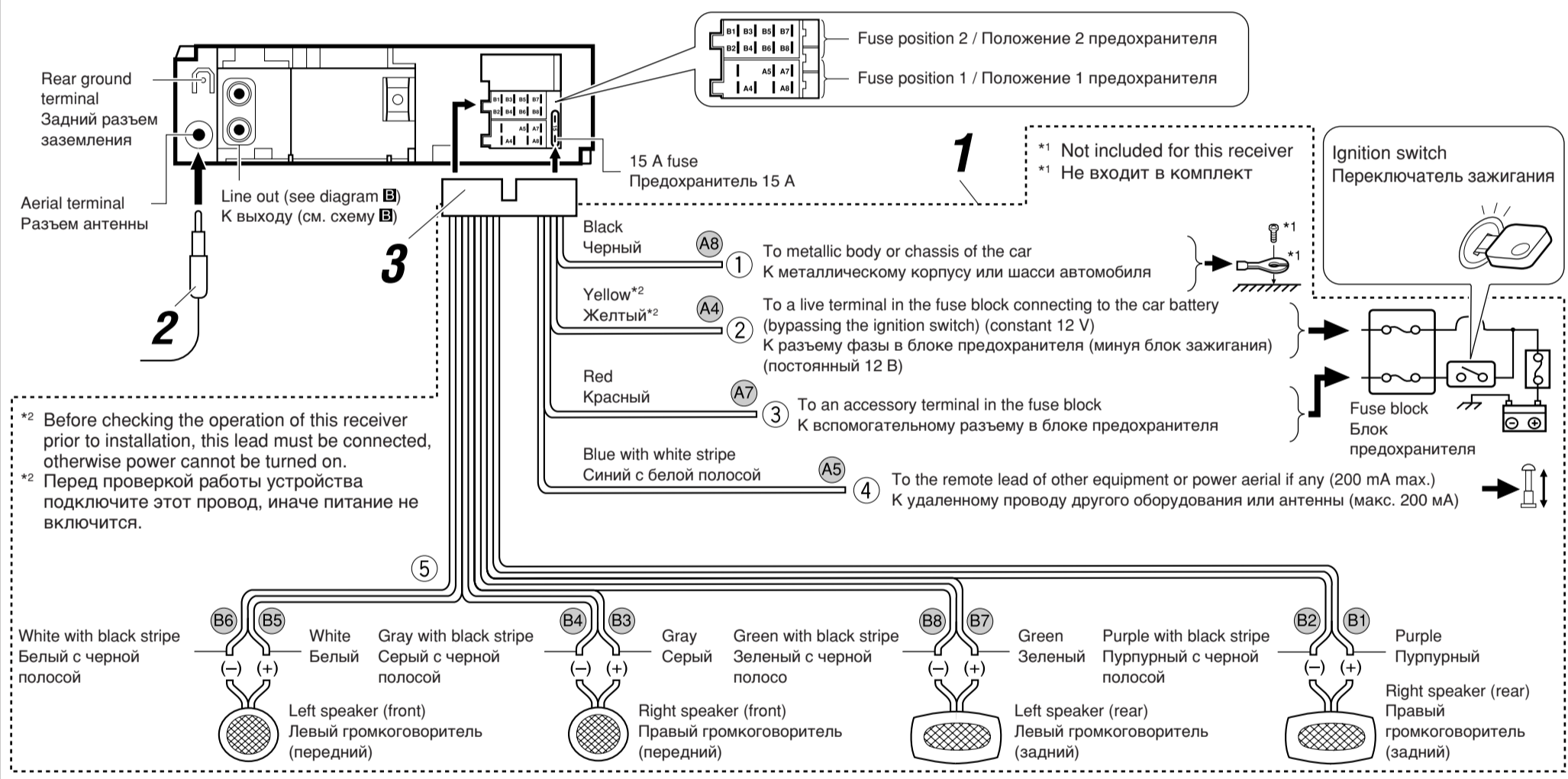

B Connecting the external amplifier / Подключение внешнего усилителя

You can connect an amplifier to upgrade your car stereo system.

- Connect the remote lead (blue with white stripe) to the remote lead of the other equipment so that it can be controlled through this receiver.
- **Disconnect the speakers from this receiver, connect them to the amplifier. Leave the speaker leads of this receiver unused.**

Можно подключить усилитель для обновления автомобильной стереосистемы.

- Подсоедините провод внешнего устройства (синий с белой полосой) к проводу внешнего устройства другого оборудования так, чтобы им можно было управлять с этого устройства.
- **Отсоедините громкоговорители от данного устройства, подключите их к усилителю. Оставьте провода громкоговорителей данного устройства неиспользованными.**

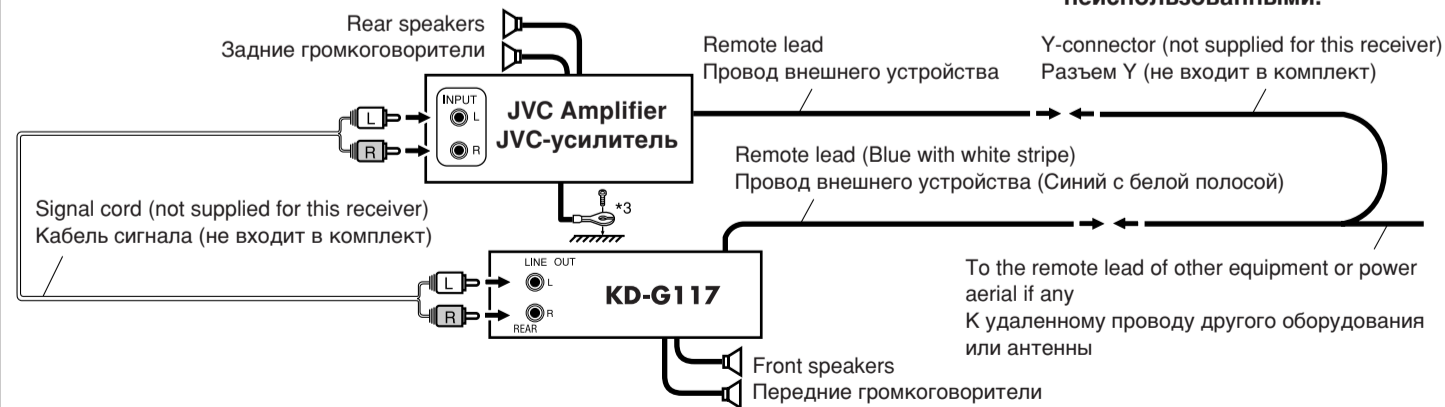

*3 Firmly attach the ground wire to the metallic body or to the chassis of the car—to the place not coated with paint (if coated with paint, remove the paint before attaching the wire). Failure to do so may cause damage to the receiver.

*3 Плотно прикрепите заземляющий провод к металлическому кузову или шасси автомобиля—в месте, не покрытом краской (если оно покрыто краской, удалите краску перед тем, как прикреплять провод). Невыполнение этого требования может привести к повреждению данного устройства.

PRECAUTIONS on power supply and speaker connections:

- **DO NOT** connect the speaker leads of the power cord to the car battery; otherwise, the receiver will be seriously damaged.
- BEFORE connecting the speaker leads of the power cord to the speakers, check the speaker wiring in your car.

ПРЕДОСТЕРЕЖЕНИЯ по питанию и подключению громкоговорителей:

- **НЕ** подключайте провода громкоговорителей к аккумулятору автомобиля, иначе устройство будет повреждено.
- ПЕРЕД подключением проводов громкоговорителей к кабелю питания громкоговорителя проверьте схему соединений громкоговорителей в Вашем автомобиле.

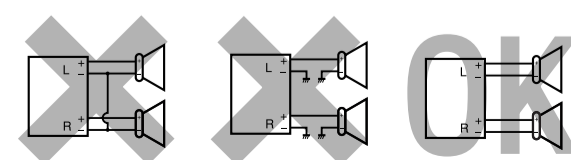

Free Manuals Download Website

<http://myh66.com>

<http://usermanuals.us>

<http://www.somanuals.com>

<http://www.4manuals.cc>

<http://www.manual-lib.com>

<http://www.404manual.com>

<http://www.luxmanual.com>

<http://aubethermostatmanual.com>

Golf course search by state

<http://golfingnear.com>

Email search by domain

<http://emailbydomain.com>

Auto manuals search

<http://auto.somanuals.com>

TV manuals search

<http://tv.somanuals.com>