

JVC

KD-R218

CD RECEIVER : INSTRUCTIONS/INSTALLATION

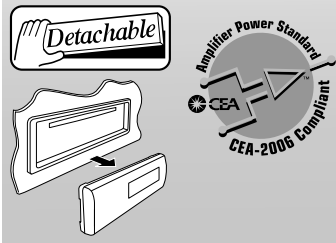

Thank you for purchasing a JVC product. Please read all instructions carefully before operation, to ensure your complete understanding and to obtain the best possible performance from the unit.

For customer Use:
Enter below the Model No. and Serial No. which are located on the top or bottom of the cabinet. Retain this information for future reference.
Model No. _____
Serial No. _____



1009DTSMDTJEIN
EN
© 2009 Victor Company of Japan, Limited

GET0622-001A
[J]

Canceling the display demonstration

1 Turn on the power.



2 MENU [Hold] DEMO (Initial setting)

3 DEMO ON

4 Select <DEMO OFF>.



5 DEMO

6 Finish the procedure.



Setting the clock

1 Turn on the power.



2 MENU [Hold] DEMO (Initial setting)

3 Select <CLOCK>.
CLOCK
CLOCK SET

4 Select <CLOCK SET>.
CLOCK SET

5 Adjust the hour.



6 Adjust the minute.
1:00
CLOCK SET

7 Finish the procedure.



Preparations

How to attach/detach the control panel

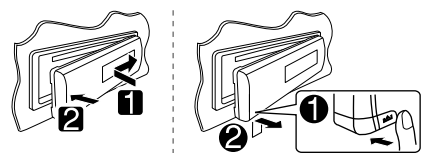

How to reset your unit

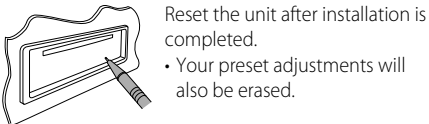

Reset the unit after installation is completed.
• Your preset adjustments will also be erased.

How to forcibly eject a disc

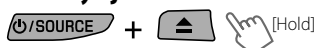

- You can forcibly eject the loaded disc even if the disc is locked. To lock/unlock the disc, see page 2.
- Be careful not to drop the disc when it ejects.
- If this does not work, reset your unit.

Preparing the remote controller (RM-RK50)

When you use the remote controller for the first time, pull out the insulation sheet.

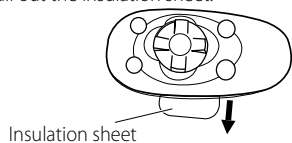

If the effectiveness of the remote controller decreases, replace the battery.

Replacing the lithium coin battery

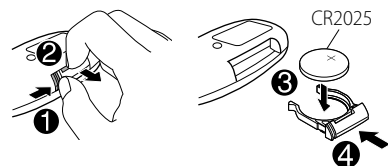

For USA-California Only:
This product contains a CR Coin Cell Lithium Battery which contains Perchlorate Material—special handling may apply.
See www.dtsc.ca.gov/hazardouswaste/perchlorate

Caution:

- Danger of explosion if battery is incorrectly replaced. Replace only with the same or equivalent type.
- Battery shall not be exposed to excessive heat such as sunshine, fire, or the like.

Warning (about battery handling)

- To prevent accidents and damage:
- Do not install any battery other than CR2025 or its equivalent.
 - Store out of reach of children.
 - Do not recharge, short, or dismantle.
 - Do not dispose of in fire.
 - Do not carry around with other metallic materials.
 - Wrap the battery with tape and insulate when throwing away or saving it.

INFORMATION (For U.S.A.)

This equipment has been tested and found to comply with the limits for a Class B digital device, pursuant to Part 15 of the FCC Rules. These limits are designed to provide reasonable protection against harmful interference in a residential installation. This equipment generates, uses, and can radiate radio frequency energy and, if not installed and used in accordance with the instructions, may cause harmful interference to radio communications. However, there is no guarantee that interference will not occur in a particular installation. If this equipment does cause harmful interference to radio or television reception, which can be determined by turning the equipment off and on, the user is encouraged to try to correct the interference by one or more of the following measures:

- Reorient or relocate the receiving antenna.
- Increase the separation between the equipment and receiver.
- Connect the equipment into an outlet on a circuit different from that to which the receiver is connected.
- Consult the dealer or an experienced radio/TV technician for help.

Caution:

Changes or modifications not approved by JVC could void the user's authority to operate the equipment.

IMPORTANT FOR LASER PRODUCTS

- CLASS 1 LASER PRODUCT
- CAUTION:** Do not open the top cover. There are no user serviceable parts inside the unit; leave all servicing to qualified service personnel.
- CAUTION:** (For U.S.A.) Visible and/or invisible class II laser radiation when open. Do not stare into beam. (For Canada) Visible and/or invisible class 1M laser radiation when open. Do not view directly with optical instruments.
- REPRODUCTION OF LABEL: CAUTION LABEL, PLACED OUTSIDE THE UNIT.

CAUTION VISIBLE AND/OR INVISIBLE CLASS 1M LASER RADIATION WHEN OPEN. DO NOT VIEW DIRECTLY WITH OPTICAL INSTRUMENTS. IEC00625-1:2001 (ENG)	ATTENTION RAYONNEMENT LASER VISIBLE ET/OU INVISIBLE DE CLASSE 1M UNE FOIS OUVERT. NE PAS REGARDER DIRECTEMENT AVEC DES INSTRUMENTS OPTIQUES. (FRA)	AVISO RADIACION LASER DE CLASE 1M VISIBLE Y/O INVISIBLE CUANDO ESTA ABIERTO. NO MIRAR DIRECTAMENTE CON INSTRUMENTAL OPTICA. (ESP)	VARNING SYNLIG OCH/ELLER OSYNLIG LASERSTRÅLNING, KLASS 1M, NÅR DENNA DEL ÅR ÖPPNAD. BETRÄKTA EJ STRÅLEN MED OPTISKA INSTRUMENT. (SWE)	注意 ここを覗くと有害及び眼に有害な光線が放射される場合があります。レーザー放射線は、レーザー放射線が放射されている間は、直接見ないでください。 (JPN)	CAUTION VISIBLE AND/OR INVISIBLE CLASS II LASER RADIATION WHEN OPEN. DO NOT STARE INTO BEAM. FDA 21 CFR (ENG)
--	---	--	--	---	--



[European Union only]

Warning:

If you need to operate the unit while driving, be sure to look around carefully or you may be involved in a traffic accident.

For safety...

- Do not raise the volume level too much, as this will block outside sounds, making driving dangerous.
- Stop the car before performing any complicated operations.

Temperature inside the car...

If you have parked the car for a long time in hot or cold weather, wait until the temperature in the car becomes normal before operating the unit.

Basic operations

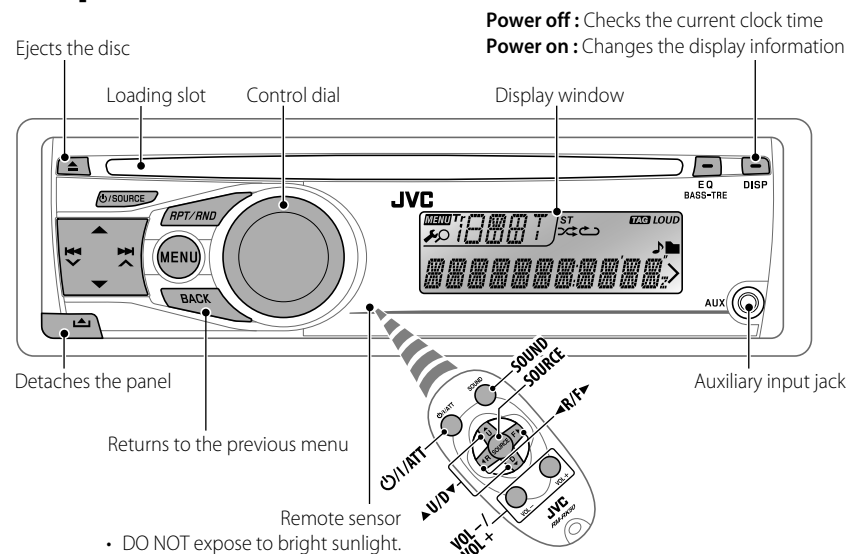

When you press or hold the following button(s)...

Main unit	Remote controller	General operation
		Turns on. • When the power is on, pressing on the remote controller also mutes the sound or pauses. Press again to cancel muting or resume playback.
		Turns off if pressed and held.
		Selects the available sources (if the power is turned on). • If the source is ready, playback also starts.
		Adjusts the volume level.
		Selects items.
		Mutes the sound while listening to a source. If the source is "CD," playback pauses. Press the control dial again to cancel muting or resume playback. • Confirms selection.
		Selects the sound mode. • Enters tone level adjustment directly (see page 2) if pressed and held EQ BASS-TRE on the main unit.
		Enters playback mode menu directly (see page 2).

Listening to the radio

- ⇒ "FM" or "AM"
- "ST" lights up when receiving an FM stereo broadcast with sufficient signal strength.

Manual search

"M" flashes, then press the button repeatedly.

When an FM stereo broadcast is hard to receive

- [Hold]
- ⇒ <TUNER> ⇒ <MONO> ⇒ <MONO ON>
Reception improves, but stereo effect will be lost.

To restore the stereo effect, repeat the same procedure to select <MONO OFF>.

Automatic presetting (FM)—SSM (Strong-station Sequential Memory)

You can preset up to 18 stations for FM.

While listening to a station...

- [Hold]
- ⇒ <TUNER> ⇒ <SSM> ⇒ <SSM 01 - 06> / <SSM 07 - 12> / <SSM 13 - 18>
"SSM" flashes and local stations with the strongest signals are searched and stored automatically.

To preset another 6 stations, repeat the above procedure by selecting one of the other 6 SSM setting ranges.

Manual presetting (FM/AM)

You can preset up to 18 stations for FM and 6 stations for AM.

Ex.: Storing FM station of 92.50 MHz into preset number "04."

- ⇒ "92.50MHz"
- [Hold]
"PRESET MODE" flashes.
- ⇒ Selects preset number "04."
"P04" flashes and "MEMORY" appears.

Listening to the disc

- ⇒ Turn on the power.
- All tracks will be played repeatedly until you change the source or eject the disc.

Stopping playback and ejecting the disc

"NO DISC" appears. Press to listen to another playback source.

Prohibiting disc ejection

+ [Hold]

To cancel the prohibition, repeat the same procedure.

 Selects folder of the MP3/WMA
 Selects track
 Fast-forwards or reverses the track [Hold]

Selecting a preset station

 or 1
 2

Assigning title to a station

You can assign titles to 30 station frequencies (FM and AM) using 8 characters (maximum) for each title.

- ⇒ "FM" or "AM"
- + [Hold]
⇒ Show the title entry screen.
- ⇒ Selects a character.
- ⇒ Move to the next (or previous) character position.
- Repeat steps 3 and 4 until you have finished entering the title.
-

To erase the entire title, press and hold after step 2, then press the control dial.

Available characters

A	B	C	D	E	F	G	H	I	
J	K	L	M	N	O	P	Q	R	
S	T	U	V	W	X	Y	Z	0	
1	2	3	4	5	6	7	8	9	
—	/	<	>	Space					

Changing the display information

 Station name * → Frequency →
 Clock → (back to the beginning)

* If no title is assigned to a station, "NO NAME" appears for a few seconds.

Using the remote controller

- ▲ U/D ▼ : Changes the preset stations
- ◀ R/F ▶ : Searches for stations

Selecting a track/folder

-
-

For MP3/WMA discs, select the desired folder, then the desired track by repeating step 2.
 • To return to the previous menu, press **BACK**.

Using the remote controller

- ▲ U/D ▼ : Selects folder of the MP3/WMA
- ◀ R/F ▶ : Selects track
- ◀ R/F ▶ [Hold] : Fast-forwards or reverses the track

Selecting the playback modes

You can use only one of the following playback modes at a time.

-
- ⇒ "REPEAT" ↔ "RANDOM"
- REPEAT
 - TRACK RPT : Repeats current track
 - FOLDER RPT : Repeats current folder
 - RANDOM
 - FOLDER RND : Randomly plays all tracks of current folder, then tracks of next folders
 - ALL RND : Randomly plays all tracks

To cancel repeat play or random play, select "RPT OFF" or "RND OFF."

Listening to the external components

You can connect an external component to the AUX (auxiliary) input jack on the control panel.

• Make sure <AUX ON> is selected for the <SRC SELECT> → <AUX IN> setting on page 3.

- ⇒ "AUX IN"
- Turn on the connected component and start playing the source.

Caution on volume setting:

Discs produce very little noise compared with other sources. Lower the volume before playing a disc to avoid damaging the speakers by the sudden increase of the output level.

Changing the display information

Disc title/Album name/performer (folder name)*
 → Track title (file name)* → Current track number with the elapsed playing time → Current track number with the clock time → (back to the beginning)

* If the current disc is an audio CD, "NO NAME" appears. If an MP3/WMA file does not have Tag information or <TAG DISPLAY> is set to <TAG OFF>, folder name and file name appear.

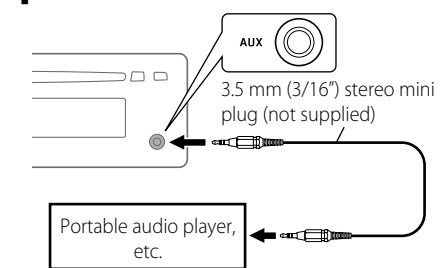

Selecting a preset sound mode

You can select a preset sound mode suitable for the music genre.

 FLAT → NATURAL → DYNAMIC →
 VOCAL BOOST → BASS BOOST →
 USER → (back to the beginning)

While listening, you can adjust the tone level of the selected sound mode.

- [Hold]
- Adjust the level (-06 to +06) of the selected tone (BASS / MIDDLE / TREBLE).
The sound mode is automatically stored and changed to "USER."

Storing your own sound mode

You can store your own adjustments in memory.

- [Hold]

- ⇒ <PRO EQ> ⇒ <BASS> / <MIDDLE> / <TREBLE>
- Adjust the sound elements of the selected tone.
 - BASS** Frequency: 60 Hz, 80 Hz, 100 Hz, 200 Hz
Level: -06 to +06
Q: Q1.0, Q1.25, Q1.5, Q2.0
 - MIDDLE** Frequency: 0.5 kHz, 1.0 kHz, 1.5 kHz, 2.5 kHz
Level: -06 to +06
Q: Q0.75, Q1.0, Q1.25
 - TREBLE** Frequency: 10.0 kHz, 12.5 kHz, 15.0 kHz, 17.5 kHz
Level: -06 to +06
Q: Q FIX

4 Repeat steps 2 and 3 to adjust other tones. The adjustments made will be stored automatically in "USER."

The current sound mode changes to "USER" automatically.

Menu operations

- [Hold]
-
- Repeat step 2 if necessary.
 - To return to the previous menu, press **BACK**.
 - To exit from the menu, press **DISP** or **MENU**.

Category	Menu item	Selectable setting, [Initial: <u>Underlined</u>]
DEMO	DEMO	• <u>DEMO ON</u> : Display demonstration will be activated automatically if no operation is done for about 20 seconds. • <u>DEMO OFF</u> : Cancels.
	CLOCK SET	[<u>1:00</u>] : Adjust the hour, then the minute.
PRO EQ	BASS	— : For settings, see "Storing your own sound mode."
	MIDDLE	
	TREBLE	
DISPLAY	DIMMER	• <u>DIMMER ON</u> : Dims the display and button illumination. • <u>DIMMER OFF</u> : Cancels.
	SCROLL *1	• <u>SCROLL ONCE</u> : Scrolls the displayed information once. • <u>SCROLL AUTO</u> : Repeats scrolling (at 5-second intervals). • <u>SCROLL OFF</u> : Cancels. Pressing DISP for more than one second can scroll the display regardless of the setting.
	TAG DISPLAY	• <u>TAG ON</u> : Shows the Tag information while playing MP3/WMA tracks. • <u>TAG OFF</u> : Cancels.

*1 Some characters or symbols will not be shown correctly (or will be blanked) on the display.

Category	Menu item	Selectable setting, [Initial: <u>Underlined</u>]
TUNER	SSM*2	• <u>SSM 01 – 06</u> : For settings, see "Automatic presetting (FM)—SSM (Strong-station Sequential Memory)" on page 2. • <u>SSM 07 – 12</u> • <u>SSM 13 – 18</u>
	AREA	• <u>AREA US</u> : When using in North/Central/South America. AM/FM intervals are set to 10 kHz/200 kHz. • <u>AREA EU</u> : When using in any other areas. AM/FM intervals are set to 9 kHz/50 kHz (100 kHz during auto search). • <u>AREA SA</u> : When using in South American countries where FM interval is 100 kHz. AM interval is set to 10 kHz.
	MONO*2	• <u>MONO ON</u> : Activate monaural mode to improve FM reception, but stereo effect will be lost. • <u>MONO OFF</u> : Restore the stereo effect.
	IF BAND	• <u>AUTO</u> : Increases the tuner selectivity to reduce interference noises between adjacent stations. (Stereo effect may be lost.) • <u>WIDE</u> : Subject to interference noises from adjacent stations, but sound quality will not be degraded and the stereo effect will remain.
AUDIO	FADER*3	<u>R06 – F06 [00]</u> : Adjust the front and rear speaker output balance.
	BALANCE*4	<u>L06 – R06 [00]</u> : Adjust the left and right speaker output balance.
	LOUD	• <u>LOUD ON</u> : Boost low and high frequencies to produce a well-balanced sound at a low volume level. • <u>LOUD OFF</u> : Cancels.
	AUX ADJUST*5	<u>AUX ADJ 00</u> — : Adjust the auxiliary input level to avoid the sudden increase of the output level when changing the source to the external component connected to the AUX input jack on the control panel. <u>AUX ADJ 05</u>
	L/O MODE	• <u>SUB.W</u> : Select if the REAR LINE OUT terminals are used for connecting a subwoofer (through an external amplifier). • <u>REAR</u> : Select if the REAR LINE OUT terminals are used for connecting the speakers (through an external amplifier).
	SUB.W FREQ*6	• <u>LOW</u> : Frequencies lower than 72 Hz are sent to the subwoofer. • <u>MID</u> : Frequencies lower than 111 Hz are sent to the subwoofer. • <u>HIGH</u> : Frequencies lower than 157 Hz are sent to the subwoofer.
	SUB.W LEVEL*6	<u>SUB.W 00</u> — : Adjust the subwoofer output level. <u>SUB.W 08</u> [<u>SUB.W 04</u>]
	BEEP	• <u>BEEP ON</u> : Activates the keypress tone. • <u>BEEP OFF</u> : Deactivates the keypress tone.
	AMP GAIN*7	• <u>LOW POWER</u> : VOLUME 00 – VOLUME 30 (Select if the maximum power of each speaker is less than 50 W to prevent damaging the speakers.) • <u>HIGH POWER</u> : VOLUME 00 – VOLUME 50
	SRC SELECT	AM*8
AUX IN*9		• <u>AUX ON</u> : Enable "AUX IN" in source selection. • <u>AUX OFF</u> : Disable "AUX IN" in source selection.

*2 Displayed only when the source is "FM."

*3 If you are using a two-speaker system, set the fader level to "00."

*4 This adjustment will not affect the subwoofer output.

*5 Displayed only when <AUX IN> is set to <AUX ON>.

*6 Displayed only when <L/O MODE> is set to <SUB.W>.

*7 The volume level automatically changes to "VOLUME 30" if you change to <LOW POWER> with the volume level set higher than "VOLUME 30."

*8 Displayed only when any source other than "AM" is selected.

*9 Displayed only when any source other than "AUX IN" is selected.

Installation

This unit is designed to operate on **12 V DC, NEGATIVE ground electrical systems**. If your vehicle does not have this system, a voltage inverter is required, which can be purchased at JVC car audio dealers.

Prepare these before installation....

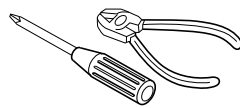

Warnings

- To prevent short circuits:
 - Disconnect the battery's negative terminal and make all electrical connections before installing the unit.
 - Cover the terminals of the UNUSED leads with insulating tape.
- Be sure to ground this unit to the car's chassis again after installation.
- Replace the fuse with one of the specified rating.
- Connect speakers with a maximum power of more than 50 W (impedance of 4 Ω to 8 Ω). Otherwise, change the <AMP GAIN> setting. (See "Menu operations.")
- The heat sink becomes very hot after use. Be careful not to touch it when removing this unit.

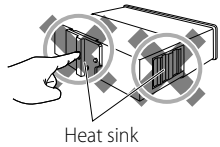

PRECAUTIONS on power supply and speaker connections

- DO NOT connect the speaker leads of the power cord to the car battery; otherwise, the unit will be seriously damaged.
- BEFORE connecting the speaker leads of the power cord to the speakers, check the speaker wiring in your car.

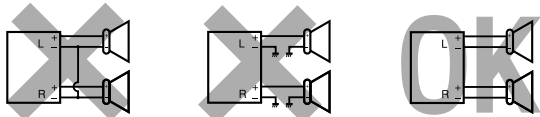

Parts List

(A) Control panel.....	1	(D) Power cord.....	1
(B) Sleeve.....	1	(E) Handles.....	2
(C) Trim plate.....	1		

The following illustration shows a typical installation. If you have any questions or require information regarding installation kits, consult your JVC car audio dealer or a company supplying kits.

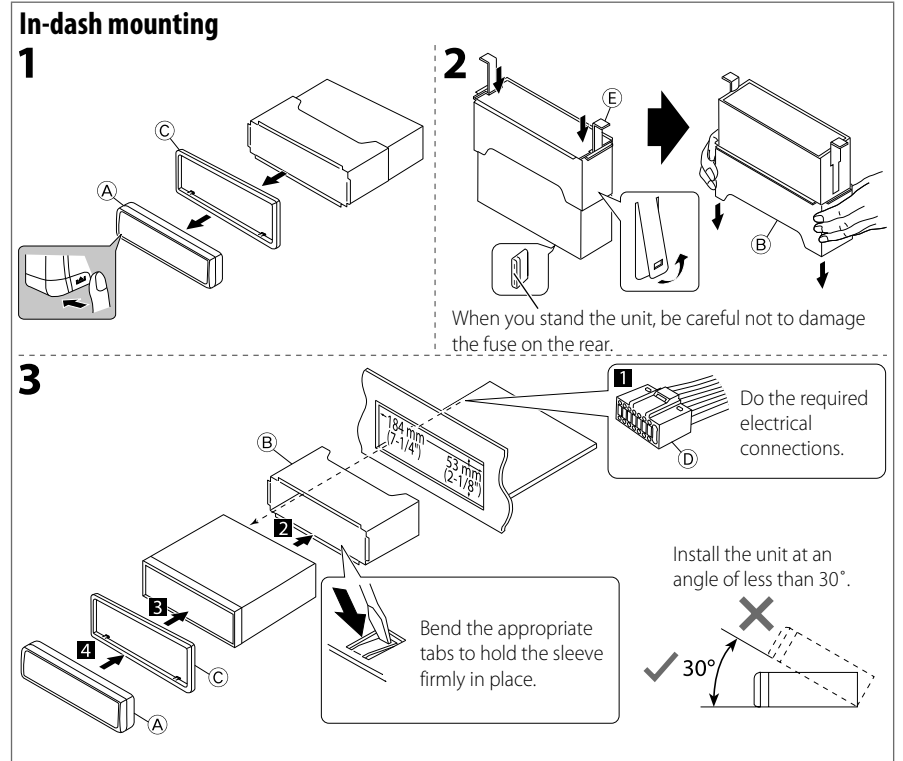

When installing the unit without using the sleeve

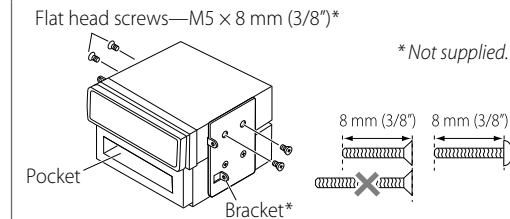

Removing the unit

Release the rear section first...

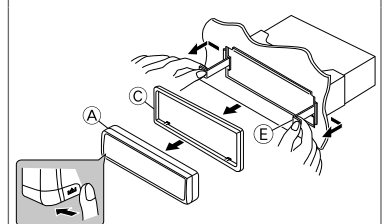

Electrical connections

IMPORTANT: A custom wiring harness (separately purchased) which is suitable for your car is recommended for connection between the unit and your car.

• Consult your JVC car audio dealer or a company supplying kits for details.

Connecting the external amplifier or subwoofer

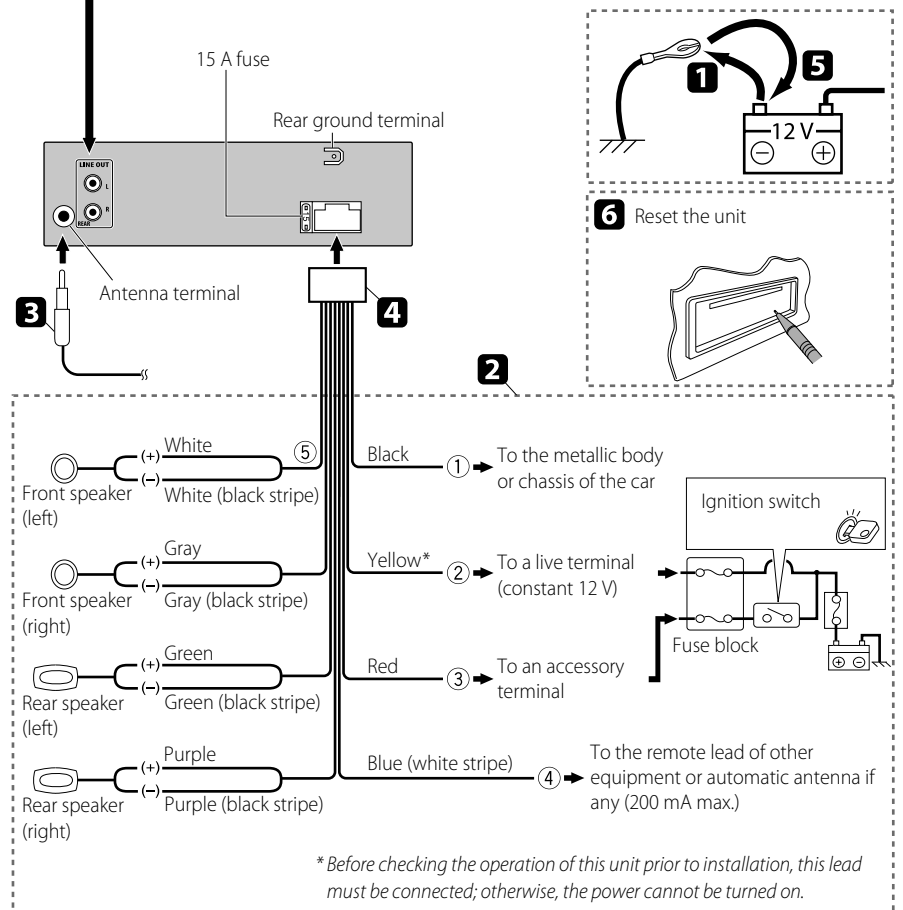
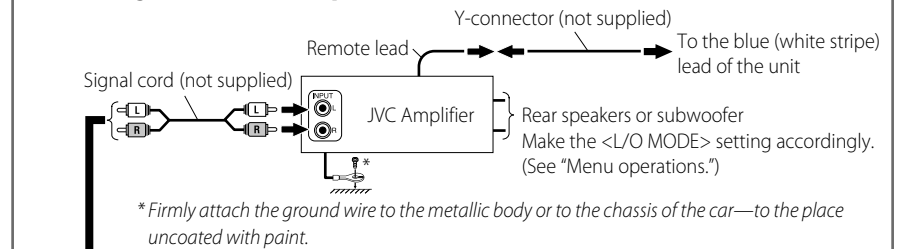

* Before checking the operation of this unit prior to installation, this lead must be connected; otherwise, the power cannot be turned on.

Troubleshooting

	Symptom	Remedy/Cause
General	Sound cannot be heard from the speakers.	<ul style="list-style-type: none"> Adjust the volume to the optimum level. Make sure the unit is not muted/paused. Check the cords and connections.
	"PROTECT" appears on the display and no operations can be done.	Check to be sure the terminals of the speaker leads are covered with insulating tape properly, then reset the unit. If "PROTECT" does not disappear, consult your JVC car audio dealer or a company supplying kits.
	This unit does not work at all.	Reset the unit. (See page 1.)
	"AUX IN" cannot be selected.	Check the <SRC SELECT> → <AUX IN> setting. (See "Menu operations" on page 3.)
FM/AM	SSM automatic presetting does not work.	Store stations manually.
	Static noise while listening to the radio.	Connect the antenna firmly.
	"AM" cannot be selected.	Check the <SRC SELECT> → <AM> setting. (See "Menu operations" on page 3.)
Disc playback	Disc cannot be played back.	Insert the disc correctly.
	<ul style="list-style-type: none"> CD-R/CD-RW cannot be played back. Tracks on the CD-R/CD-RW cannot be skipped. 	<ul style="list-style-type: none"> Insert a finalized CD-R/CD-RW. Finalize the CD-R/CD-RW with the component which you used for recording.
	Disc can be neither played back nor ejected.	<ul style="list-style-type: none"> Unlock the disc. Eject the disc forcibly.
	Disc sound is sometimes interrupted.	<ul style="list-style-type: none"> Stop playback while driving on rough roads. Change the disc. Check the cords and connections.
	"NO DISC" appears on the display.	Insert a playable disc into the loading slot.
	"PLEASE" and "EJECT" appear alternately on the display.	Press ▲, then insert a disc correctly.
MP3/WMA playback	Disc cannot be played back.	<ul style="list-style-type: none"> Use a disc with MP3/WMA tracks recorded in a format compliant with ISO 9660 Level 1, Level 2, Romeo, or Joliet. Add the extension code <.mp3> or <.wma> to the file names.
	Noise is generated.	Skip to another track or change the disc. (Do not add the extension code <.mp3> or <.wma> to non-MP3 or WMA tracks.)
	A longer readout time is required ("READING" keeps flashing on the display).	Do not use too many hierarchical levels and folders.
	Tracks are not played back in the order you have intended.	Playback order is determined when the files are recorded.
	The elapsed playing time is not correct.	This sometimes occurs during playback. This is caused by how the tracks are recorded on the disc.
	The correct characters are not displayed (e.g. album name).	This unit can only display letters (upper case), numbers, and a limited number of symbols.
Installation/connection	The fuse blows.	Connect the red and black leads correctly.
	Power cannot be turned on.	Check to make sure the yellow lead is connected.
	No sound from the speakers.	Check to make sure the speaker output lead is not shortcircuited.
	Sound is distorted.	<ul style="list-style-type: none"> Check to make sure the speaker output lead is grounded. Check to make sure the "-" terminals of L and R speakers are grounded in common.
	Noise interfere with sounds.	Check to make sure the rear ground terminal connected to the car's chassis is using shorter and thicker cords.
	This unit becomes hot.	<ul style="list-style-type: none"> Check to make sure the speaker output lead is grounded. Check to make sure the "-" terminals of L and R speakers are grounded in common.
	This unit does not work at all.	Reset the unit. (See page 1.)

Maintenance

How to clean the connectors

Wipe the connectors with a cotton swab or cloth moistened with alcohol.

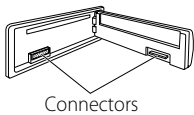

Connectors

To play new discs

Remove any rough areas from the inner and outer edges of the disc.



Moisture condensation

Moisture may condense on the lens inside the unit. Eject the disc and leave the unit turned on for a few hours until the moisture has evaporated.

To keep discs clean

Wipe in a straight line from center of disc to edge. Do not use liquid cleaners, thinners, or benzene.



Do not use the following discs:

- Single CD—8 cm (3-3/16") disc
- Warped disc
- Disc with sticker and sticker residue
- Disc with stick-on label
- Unusual shape disc
- C-thru Disc (semi-transparent disc)
- Disc with transparent or semi-transparent parts on its recording area

More about this unit

Basic operations

- If you turn off the power while listening to a track, playback will start from where it had been stopped previously next time you turn on the power.
- If no operation is done for about 60 seconds after pressing **MENU** button, the operation will be canceled.

Tuner operations

- During SSM search...
 - All previously stored stations are erased and the stations are stored anew.
 - When SSM is over, the station stored in the lowest preset number will be automatically tuned in.
- If you try to assign titles to more than 30 station frequencies, "NAME FULL" appears. Delete unwanted titles before assignment.

Disc operations

Caution for DualDisc playback

- The Non-DVD side of a "DualDisc" does not comply with the "Compact Disc Digital Audio" standard. Therefore, the use of Non-DVD side of a DualDisc on this product may not be recommended.

General

- This unit has been designed to reproduce CDs/ CD Texts, and CD-Rs (Recordable)/CD-RWs (Rewritable) in audio CD (CD-DA) and MP3/WMA formats.
- If you change the source while listening to a disc, playback stops. Next time you select "CD" as the playback source, playback will start from where it had been stopped previously.
- If the ejected disc is not removed within 15 seconds, the disc is automatically inserted again into the loading slot to protect it from dust.

Playing a CD-R or CD-RW

- Use only "finalized" CD-Rs or CD-RWs.
- This unit can play back multi-session discs; however, unclosed sessions will be skipped while playing.
- Some CD-Rs or CD-RWs may not be played back on this unit:
 - Discs are dirty or scratched.
 - Moisture condensation has occurred on the lens inside the unit.
 - The pickup lens inside the unit is dirty.
 - The files on the CD-R/CD-RW are written using the "Packet Write" method.
 - There are improper recording conditions (missing data, etc.) or media conditions (stained, scratched, warped, etc.).

Specifications

AUDIO AMPLIFIER SECTION

Power Output:
20 W RMS × 4 Channels at 4 Ω and ≤ 1% THD+N

Signal-to-Noise Ratio:
80 dBA (reference: 1 W into 4 Ω)



Load Impedance: 4 Ω (4 Ω to 8 Ω allowance)

Tone Control Range:

Bass: ±12 dB (60 Hz, 80 Hz, 100 Hz, 200 Hz)
Q1.0, Q1.25, Q1.5, Q2.0

Middle: ±12 dB (0.5 kHz, 1.0 kHz, 1.5 kHz, 2.5 kHz)
Q0.75, Q1.0, Q1.25

Treble: ±12 dB (10.0 kHz, 12.5 kHz, 15.0 kHz, 17.5 kHz)
Q (Fixed)

Frequency Response: 40 Hz to 20 000 Hz

Line-Out Level/Impedance:

2.5 V/20 kΩ load (full scale)

Subwoofer-Out Level/Impedance:

2.5 V/20 kΩ load (full scale)

Output Impedance: 1 kΩ

Other Terminal: AUX (auxiliary) input jack

TUNER SECTION

Frequency Range:

FM: 87.5 MHz to 107.9 MHz
(with channel interval set to 100 kHz or 200 kHz)

87.5 MHz to 108.0 MHz
(with channel interval set to 50 kHz)

AM: 530 kHz to 1 710 kHz
(with channel interval set to 10 kHz)

531 kHz to 1 602 kHz
(with channel interval set to 9 kHz)

[FM Tuner]

Usable Sensitivity: 9.3 dBf (0.8 μV/75 Ω)

50 dB Quieting Sensitivity: 16.3 dBf (1.8 μV/75 Ω)

Alternate Channel Selectivity (400 kHz): 65 dB

Frequency Response: 40 Hz to 15 000 Hz

Stereo Separation: 40 dB

[AM Tuner]

Sensitivity/Selectivity: 20 μV/40 dB

- CD-RWs may require a longer readout time since the reflectance of CD-RWs is lower than that of regular CDs.

Playing an MP3/WMA disc

- This unit can play back MP3/WMA files with the extension code <.mp3> or <.wma> (regardless of the letter case—upper/lower).
- This unit can show the names of albums, artists (performer), and tag (Version 1.0, 1.1, 2.2, 2.3, or 2.4) for MP3 files and for WMA files.
- This unit can display only one-byte characters. No other characters can be correctly displayed.
- This unit can play back MP3/WMA files meeting the conditions below:
 - Bit rate: 8 kbps — 320 kbps
 - Sampling frequency: 48 kHz, 44.1 kHz, 32 kHz (for MPEG-1) 24 kHz, 22.05 kHz, 16 kHz (for MPEG-2)
 - Disc format: ISO 9660 Level 1/Level 2, Romeo, Joliet, Windows long file name
- The maximum number of characters for file/folder names vary depending on the disc format used (includes 4 extension characters—<.mp3> or <.wma>).
 - ISO 9660 Level 1: up to 12 characters; ISO 9660 Level 2: up to 31 characters; Romeo: up to 128 characters; Joliet: up to 64 characters; Windows long file name: up to 128 characters
- This unit can recognize a total of 512 files, 255 folders, and 8 hierarchical levels.
- This unit can play back files recorded in VBR (variable bit rate). Files recorded in VBR have a discrepancy in the elapsed time display, and do not show the actual elapsed time. In particular, this difference becomes noticeable after performing the search function.
- This unit cannot play back the following files:
 - MP3 files: encoded in MP3i and MP3 PRO format; an inappropriate format; layer 1/2.
 - WMA files: encoded in lossless, professional, and voice format; not based upon Windows Media® Audio; copy-protected with DRM.
 - Files which have data such as AIFF, ATRAC3, etc.
- The search function works but search speed is not constant.

Microsoft and Windows Media are either registered trademarks or trademarks of Microsoft Corporation in the United States and/or other countries.

CD PLAYER SECTION

Type: Compact disc player
Signal Detection System: Non-contact optical pickup (semiconductor laser)

Number of channels: 2 channels (stereo)
Frequency Response: 5 Hz to 20 000 Hz
Dynamic Range: 93 dB
Signal-to-Noise Ratio: 98 dB
Wow and Flutter: Less than measurable limit
MP3 Decoding Format: MPEG1/2 Audio Layer 3
Max. Bit Rate: 320 kbps
WMA (Windows Media® Audio) Decoding Format: Max. Bit Rate: 192 kbps

GENERAL

Power Requirement: Operating Voltage: DC 14.4 V (11 V to 16 V allowance)
Grounding System: Negative ground
Allowable Operating Temperature: 0°C to +40°C (32°F to 104°F)

Dimensions (W × H × D):
Installation Size (approx.): 182 mm × 52 mm × 160 mm (7-3/16" × 2-1/16" × 6-5/16")
Panel Size (approx.): 188 mm × 58 mm × 6 mm (7-7/16" × 2-5/16" × 1/4")
Mass (approx.): 1.3 kg (2.9 lbs) (excluding accessories)

Design and specifications are subject to change without notice.

If a kit is necessary for your car, consult your telephone directory for the nearest car audio speciality shop.

**Having TROUBLE with operation?
Please reset your unit
Still having trouble??**

**Call 1-800-252-5722 (USA ONLY)
<http://www.jvc.com>**

JVC

ENGLISH

FRANÇAIS

KD-R412 / KD-R411 / KD-R35 / KD-R312 / KD-R311

CD RECEIVER / RÉCEPTEUR CD

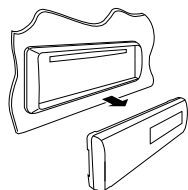

MP3
WMA

Radio Data System

KD-R412/KD-R411/KD-R35

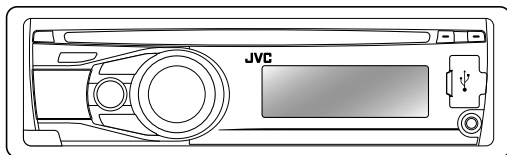

KD-R312/KD-R311

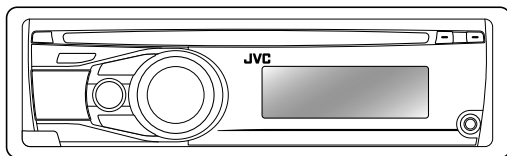

For canceling the display demonstration, see page 4. / Pour annuler la démonstration des affichages, référez-vous à la page 4.

For installation and connections, refer to the separate manual. / Pour l'installation et les raccordements, se référer au manuel séparé.

INSTRUCTIONS **MANUEL D'INSTRUCTIONS**

GET0624-003A
[E/EU]

Thank you for purchasing a JVC product.

Please read all instructions carefully before operation, to ensure your complete understanding and to obtain the best possible performance from the unit.

IMPORTANT FOR LASER PRODUCTS

1. CLASS 1 LASER PRODUCT

2. **CAUTION:** Do not open the top cover. There are no user serviceable parts inside the unit; leave all servicing to qualified service personnel.

3. **CAUTION:** Visible and/or invisible class 1M laser radiation when open. Do not view directly with optical instruments.

4. REPRODUCTION OF LABEL: CAUTION LABEL, PLACED OUTSIDE THE UNIT.

CAUTION VISIBLE AND/OR INVISIBLE CLASS 1M LASER RADIATION WHEN OPEN. DO NOT VIEW DIRECTLY WITH OPTICAL INSTRUMENTS. IEC00025-1:2001 (ENQ)	ATTENTION RAYONNEMENT LASER VISIBLE ET/OU INVISIBLE DE CLASSE 1M LORS QU'EST NE PAS REGARDER DIRECTEMENT AVEC DES INSTRUMENTS OPTIQUES. (FR)	AVISO RADIACION LASER DE CLASE 1M VISIBLE Y/O INVISIBLE CUANDO ESTA ABIERTO. NO MIRAR DIRECTAMENTE CON INSTRUMENTAL OPTICO. (ESP)	VARNING SYNLIG OCH/ELLER OSYNLIG LASERSTRÅLNING KLASS 1M, NÄR DENNA DEL ÄR ÖPPNAD. BETRÄKTA EJ STRÅLEN MED OPTISKA INSTRUMENT. (SWE)	注意 ここを開くと可視 及び/または不可視 のクラス1M レーザー放射が 出ます。 光学顕微鏡で見ないでください。 (JPN)	CAUTION VISIBLE AND/OR INVISIBLE CLASS II LASER RADIATION WHEN OPEN. DO NOT STARE INTO BEAM. FDA 21 CFR (ENG)
--	---	--	---	---	--



Battery

Products

Information for Users on Disposal of Old Equipment and Batteries

[European Union only]

These symbols indicate that the product and the battery with this symbol should not be disposed as general household waste at its end-of-life.

If you wish to dispose of this product and the battery, please do so in accordance with applicable national legislation or other rules in your country and municipality.

By disposing of this product correctly, you will help to conserve natural resources and will help prevent potential negative effects on the environment and human health.

Notice:

The sign Pb below the symbol for batteries indicates that this battery contains lead.

Warning:

If you need to operate the unit while driving, be sure to look around carefully or you may be involved in a traffic accident.

For safety...

- Do not raise the volume level too much, as this will block outside sounds, making driving dangerous.
- Stop the car before performing any complicated operations.

Temperature inside the car...

If you have parked the car for a long time in hot or cold weather, wait until the temperature in the car becomes normal before operating the unit.

KD-R412/KD-R411 is equipped with the steering wheel remote control function. Before operating, connect a JVC's OE remote adapter (not supplied) which matches your car to the steering wheel remote input terminal on the rear of the unit.

- For details, refer also to the instructions supplied with the remote adapter.

How to read this manual

The following icons/symbols are used to indicate:

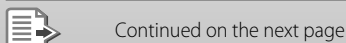
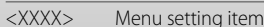
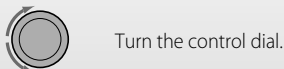
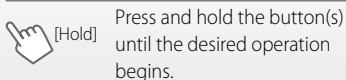

How to attach/detach the control panel

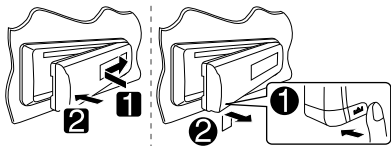

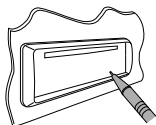

How to reset your unit

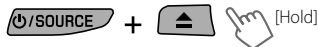

Your preset adjustments will also be erased.

How to forcibly eject a disc



- You can forcibly eject the loaded disc even if the disc is locked. To lock/unlock the disc,  8.
- Be careful not to drop the disc when it ejects.
- If this does not work, reset your unit.

CONTENTS

- 3 How to read this manual
- 3 How to attach/detach the control panel
- 3 How to reset your unit
- 3 How to forcibly eject a disc
- 4 Canceling the display demonstration**
- 4 Setting the clock**
- 5 Basic operations**
- 6 Listening to the radio**
- 8 Listening to a disc**
- 10 Listening to the USB device**
(For KD-R412/KD-R411/KD-R35)
- 11 Listening to the other external components**
- 12 Using the remote controller**
(For KD-R412/KD-R411)
- 13 Selecting a preset sound mode**
- 13 Menu operations**
- 17 More about this unit**
- 20 Maintenance**
- 21 Troubleshooting**
- 24 Specifications**

Canceling the display demonstration

1 Turn on the power.



2 MENU [Hold]



3



4 Select <DEMO OFF>.



5



6 Finish the procedure.



Setting the clock

1 Turn on the power.



2 MENU [Hold]



3 Select <CLOCK>.



4 Select <CLOCK SET>.



5 Adjust the hour.



6 Adjust the minute.



7 Select <24H/12H>.



8 Select <24 HOUR> or <12 HOUR>.

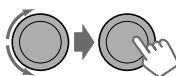

9 Finish the procedure.



Basic operations

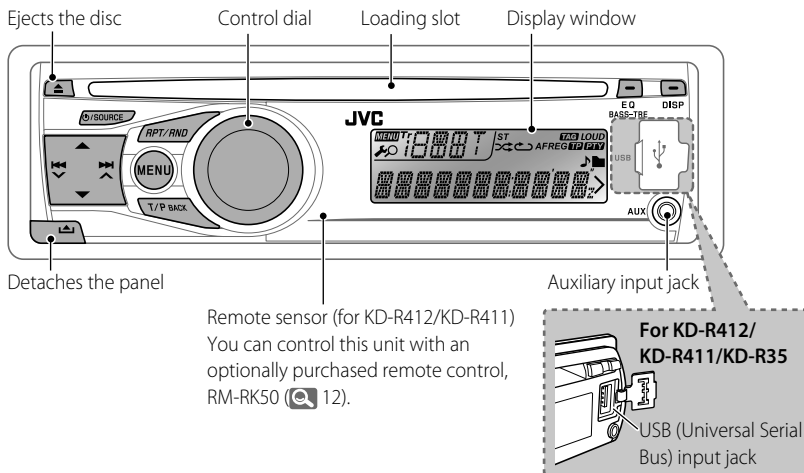

When you press or hold the following button(s)...

Button	General operation
	<ul style="list-style-type: none"> • Turns on. • Selects the available sources (if the power is turned on). If the source is ready, playback also starts. • Turns off if pressed and held.
	<ul style="list-style-type: none"> • Adjusts the volume level. • Selects items.
	<ul style="list-style-type: none"> • Mutes the sound while listening to a source. If the source is "CD" or "USB," playback pauses. Press the control dial again to cancel muting or resume playback. • Confirms selection.
	<ul style="list-style-type: none"> • Selects the sound mode. • Enters tone level adjustment directly (📺 13) if pressed and held.
	Enters playback mode menu directly (📺 9).
	<ul style="list-style-type: none"> • Returns to the previous menu • Activates/deactivates TA Standby Reception • Enters PTY Searching mode if pressed and held
	<p>Power off : Checks the current clock time</p> <p>Power on : Changes the display information</p>

Listening to the radio



⇒ "FM" or "AM"



"ST" lights up when receiving an FM stereo broadcast with sufficient signal strength.

Manual search



"M" flashes, then press the button repeatedly.

When an FM stereo broadcast is hard to receive

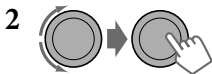

⇒ <TUNER> ⇒ <MONO> ⇒

<MONO ON>

Reception improves, but stereo effect will be lost.

To restore the stereo effect, repeat the same procedure to select <MONO OFF>.

Changing the display information



Frequency → Clock → (back to the beginning)

Automatic presetting (FM)—

SSM (Strong-station Sequential Memory)

You can preset up to 18 stations for FM.

While listening to a station...

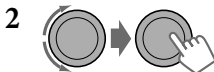

⇒ <TUNER> ⇒ <SSM> ⇒

<SSM 01 – 06> / <SSM 07 – 12> /

<SSM 13 – 18>

"SSM" flashes and local stations with the strongest signals are searched and stored automatically.

To preset another 6 stations, repeat the above procedure by selecting one of the other 6 SSM setting ranges.

Manual presetting (FM/AM)

You can preset up to 18 stations for FM and 6 stations for AM.

Ex.: Storing FM station of 92.50 MHz into preset number "04."



⇒ "92.50MHz"



"PRESET MODE" flashes.

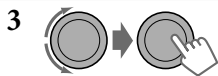

⇒ Selects preset number "04."
"P04" flashes and "MEMORY" appears.

Selecting a preset station

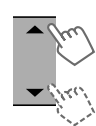

or

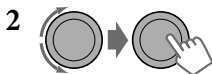

The following features are available only for FM Radio Data System stations.

Searching for your favourite FM Radio Data System

programme—PTY Search

You can tune in to a station broadcasting your favourite programme by searching for a PTY code.



The last selected PTY code appears.

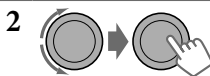

⇒ Select one of your favourite programme types or a PTY code (🔍 17), and start searching.

If there is a station broadcasting a programme of the same PTY code as you have selected, that station is tuned in.

Standby receptions

TA Standby Reception

TA Standby Reception allows the unit to switch temporarily to Traffic Announcement (TA) from any source other than AM.

- The volume changes to the preset TA volume level if the current level is lower than the preset level (🔊 15).

To activate TA Standby Reception



If the TP indicator lights up, TA Standby Reception is activated.
If the TP indicator flashes, TA Standby Reception is not yet activated.

- To activate the reception, tune in to another station providing Radio Data System signals required for TA Standby Reception.
- To deactivate the reception, press **T/P BACK** again.



PTY Standby Reception

PTY Standby Reception allows the unit to switch temporarily to your favourite PTY programme from any source other than AM.

To activate and select your favourite PTY code for PTY Standby Reception, see "Menu operations: <PTY-STANDBY>." (🔍 14)

If the PTY indicator lights up, PTY Standby Reception is activated.

If the PTY indicator flashes, PTY Standby Reception is not yet activated.

- To activate the reception, tune in to another station providing these signals.
- To deactivate the reception, select <PTY OFF> for the PTY code (🔍 14). The PTY indicator goes off.

Tracing the same programme— Network-Tracking Reception

When driving in an area where FM reception is not sufficient enough, this unit automatically tunes in to another FM Radio Data System station of the same network, possibly broadcasting the same programme with stronger signals.

Programme A broadcasting on different frequency areas (01 – 05)

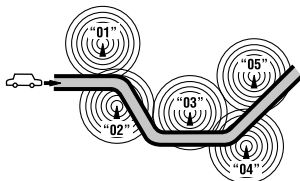

To change the Network-Tracking Reception setting, see "Menu operations: <AF-REG>." (🔍 14)

Automatic station selection— Programme Search

Usually when you select a preset number, the station preset in that number is tuned in. If the signals from the FM Radio Data System preset station are not sufficient for good reception, this unit, using the AF data, tunes in to another frequency possibly broadcasting the same programme as the original preset station is broadcasting.

- See "Menu operations: <P-SEARCH>." (🔍 15)

Changing the display information



Station name (PS) → Station Frequency → Programme type (PTY) → Clock → (back to the beginning)

Listening to a disc

1



⇒ Turn on the power.

2



All tracks will be played repeatedly until you change the source or eject the disc.

Stopping playback and ejecting the disc



"NO DISC" appears.
Press **⏻**/SOURCE to listen to another playback source.

Prohibiting disc ejection



To cancel the prohibition, repeat the same procedure.

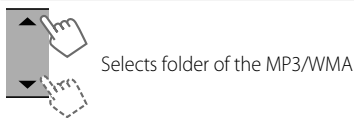

Selecting a track/folder

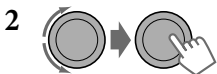

For MP3/WMA discs, select the desired folder, then the desired track by repeating step 2.

- To return to the previous menu, press **BACK**.

Caution on volume setting:

Discs produce very little noise compared with other sources. Lower the volume before playing a disc to avoid damaging the speakers by the sudden increase of the output level.

Changing the display information



Disc title/Album name/performer (folder name)* → Track title (file name)* → Current track number with the elapsed playing time → Current track number with the clock time → (back to the beginning)

* If the current disc is an audio CD, "NO NAME" appears.

If an MP3/WMA file does not have Tag information or <TAG DISPLAY> is set to <TAG OFF> (📺 14), folder name and file name appear.

Selecting the playback modes

You can use only one of the following playback modes at a time.

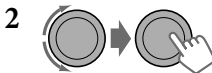

⇨ "REPEAT" ⇨ "RANDOM"

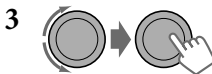

REPEAT

TRACK RPT : Repeats current track
FOLDER RPT : Repeats current folder

RANDOM

FOLDER RND : Randomly plays all tracks of current folder, then tracks of next folders
ALL RND : Randomly plays all tracks

To cancel repeat play or random play, select "RPT OFF" or "RND OFF."

Listening to the USB device (For KD-R412/KD-R411/KD-R35)

This unit can play MP3/WMA tracks stored in a USB device.

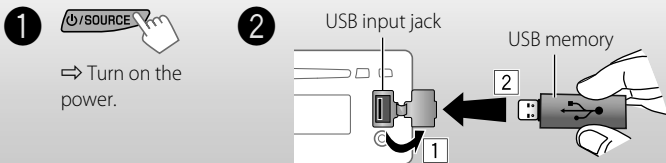

All tracks will be played repeatedly until you change the source or detach the USB device.

If a USB device has been attached...

Pressing **SOURCE** turns on the power and playback starts from where it has been stopped previously.

- If a different USB device is currently attached, playback starts from the beginning.

Stopping playback and detaching the USB device

Straightly pull it out from the unit.

"NO USB" appears. Press **SOURCE** to listen to another playback source.

You can operate the USB device in the same way you operate the files on a disc.

Caution on volume setting:

USB devices produce very little noise compared with other sources. Lower the volume before playing a USB to avoid damaging the speakers by sudden increase of the output level.

Cautions:



- Avoid using the USB device if it might hinder your safety driving.
- Do not pull out and attach the USB device repeatedly while "READING" is shown on the display.
- Do not start the car engine if a USB device is connected.
- This unit may not be able to play the files depending on the type of USB device.
- Operation and power supply may not work as intended for some USB devices.
- You cannot connect a computer to the USB input terminal of the unit.
- Make sure all important data has been backed up to avoid losing the data.
- Do not leave a USB device in the car, expose to direct sunlight, or high temperature to avoid deformation or cause damages to the device.
- Some USB devices may not work immediately after attaching USB device or turn on the power.
- For more details about USB operations, see page 19.

Listening to the other external components

You can connect an external component to the AUX (auxiliary) input jack on the control panel.

Preparation: Make sure <AUX ON> is selected for the <SRC SELECT> → <AUX IN> setting. (🔍 16)

- For details, refer also to the instructions supplied with the adapter or external components.

- 1 
⇒ "AUX IN"
- 2 Turn on the connected component and start playing the source.
- 3 
⇒ Adjust the volume.
- 4 **Adjust the sound as you want.** (🔍 13)

Connecting an external component to the AUX input jack

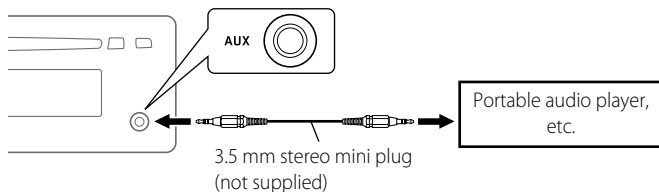

Using the remote controller (For KD-R412/KD-R411)

KD-R412/KD-R411 can be remotely controlled as instructed here (with an optionally purchased remote controller). We recommend that you use remote controller RM-RK50 with your unit.

Installing the lithium coin battery (CR2025)

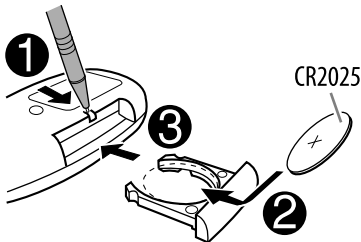

Caution:

- Danger of explosion if battery is incorrectly replaced. Replace only with the same or equivalent type.
- Battery shall not be exposed to excessive heat such as sunshine, fire, or the like.

If the effectiveness of the remote controller decreases, replace the battery.

Before using the remote controller:

- Aim the remote controller directly at the remote sensor on the unit.
- DO NOT expose the remote sensor to bright light (direct sunlight or artificial lighting).

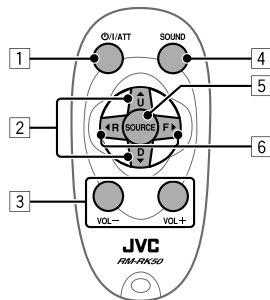
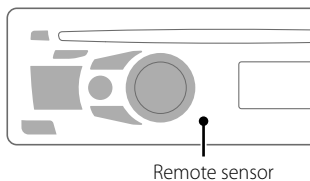

- 1 • Turns the power on if pressed briefly. When the power is on, pressing the button also mutes the sound or pauses. To cancel muting or resume playback, press the same button again.
 - Turns the power off if pressed and held.
- 2 • Changes the preset stations.
 - Changes the folder of the MP3/WMA.
- 3 Adjusts the volume level.
- 4 Selects the sound mode.
- 5 Selects the source.
- 6 • Searches for stations if pressed briefly.
 - Fast-forwards or reverses the track if pressed and held.
 - Changes the tracks if pressed briefly.

Warning (to prevent accidents and damage):

- Do not install any battery other than CR2025 or its equivalent.
- Do not leave the remote controller in a place (such as dashboards) exposed to direct sunlight for a long time.
- Store the battery in a place where children cannot reach.
- Do not recharge, short, disassemble, heat the battery, or dispose of it in a fire.
- Do not leave the battery with other metallic materials.
- Do not poke the battery with tweezers or similar tools.
- Wrap the battery with tape and insulate when throwing away or saving it.

Selecting a preset sound mode

You can select a preset sound mode suitable for the music genre.



**FLAT → NATURAL → DYNAMIC → VOCAL
BOOST → BASS BOOST → USER →** (back to the beginning)

While listening, you can adjust the tone level of the selected sound mode.

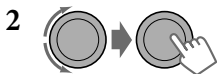

Adjust the level (-06 to +06) of the selected tone (BASS / MIDDLE / TREBLE). The sound mode is automatically stored and changed to "USER."

Storing your own sound mode

You can store your own adjustments in memory.

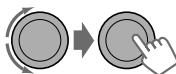

⇒ <PRO EQ> ⇒ <BASS> / <MIDDLE> / <TREBLE>

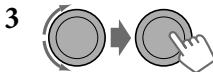

Adjust the sound elements of the selected tone. (🔍 19)

- 4** Repeat steps **2** and **3** to adjust other tones.
The adjustments made will be stored automatically in "USER."

The current sound mode changes to "USER" automatically.



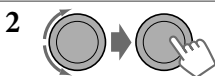

Menu operations



- 3** Repeat step **2** if necessary.
- To return to the previous menu, press **BACK**.
 - To exit from the menu, press **DISP** or **MENU**.

Category	Menu item	Selectable setting, [Initial: <u>Underlined</u>]
DEMO	DEMO Display demonstration	<ul style="list-style-type: none"> • <u>DEMO ON</u> : Display demonstration will be activated automatically if no operation is done for about 20 seconds. (🔍 4) • DEMO OFF : Cancels.
	CLOCK SET Clock setting	[<u>0:00</u>] : Adjust the hour, then the minute. (🔍 4)



Category	Menu item	Selectable setting, [Initial: <u>Underlined</u>]
CLOCK	24H/12H Time display mode	<ul style="list-style-type: none"> • 24 HOUR : For settings,  4. • 12 HOUR
	CLOCK ADJ *1 Clock adjustment	<ul style="list-style-type: none"> • AUTO : The built-in clock is automatically adjusted using the CT (clock time) data in the Radio Data System signal. • OFF : Cancels.
PRO EQ	BASS	— : For settings,  13.
	MIDDLE	
	TREBLE	
DISPLAY	DIMMER	<ul style="list-style-type: none"> • DIMMER ON : Dims the display and button illumination. • DIMMER OFF : Cancels.
	SCROLL *2	<ul style="list-style-type: none"> • SCROLL ONCE : Scrolls the displayed information once. • SCROLL AUTO : Repeats scrolling (at 5-second intervals). • SCROLL OFF : Cancels. <p>Pressing DISP for more than one second can scroll the display regardless of the setting.</p>
	TAG DISPLAY	<ul style="list-style-type: none"> • TAG ON : Shows the Tag information while playing MP3/WMA tracks. • TAG OFF : Cancels.
TUNER	SSM *3 Strong-station Sequential Memory	<ul style="list-style-type: none"> • SSM 01 – 06 : For settings,  6. • SSM 07 – 12 • SSM 13 – 18
	AF-REG *4 Alternative frequency/regionalization reception	<ul style="list-style-type: none"> • AF ON : When the currently received signals become weak, the unit switches to another station (the programme may differ from the one currently received). (The AF indicator lights up.) • AF-REG ON : When the currently received signals become weak, the unit switches to another station broadcasting the same programme. (The AF and REG indicators light up.) • OFF : Cancels.
	PTY-STANDBY *3,*4	• PTY OFF , PTY codes : Activates PTY Standby Reception with one of the PTY codes ( 17).

*1 Takes effect only when CT (clock time) data is received.

*2 Some characters or symbols will not be shown correctly (or will be blanked) on the display.

*3 Displayed only when the source is "FM."

*4 Only for FM Radio Data System stations.

Category	Menu item	Selectable setting, [Initial: <u>Underlined</u>]
TUNER	TA VOLUME *5 Traffic announcement volume	• VOLUME 00 – : — VOLUME 50 (or VOLUME 00 – VOLUME 30)*6 [VOLUME 15]
	P-SEARCH *5 Programme search	• SEARCH ON : Activates Programme Search. (🔍 8) • SEARCH OFF : Cancels.
	MONO *7 Monaural mode	• MONO ON : Activate monaural mode to improve FM reception, but stereo effect will be lost. • MONO OFF : Restore the stereo effect. (🔍 6)
	IF BAND Intermediate frequency band	• AUTO : Increases the tuner selectivity to reduce interference noises between adjacent stations. (Stereo effect may be lost.) • WIDE : Subject to interference noises from adjacent stations, but sound quality will not be degraded and the stereo effect will remain.
AUDIO	FADER *8	R06 – F06 [00] : Adjust the front and rear speaker output balance.
	BALANCE *9	L06 – R06 [00] : Adjust the left and right speaker output balance.
	LOUD Loudness	• LOUD ON : Boost low and high frequencies to produce a well-balanced sound at a low volume level. • LOUD OFF : Cancels.
	AUX ADJUST *10 Auxiliary adjust (For KD-R312/ KD-R311)	AUX ADJ 00 — AUX ADJ 05 : Adjust the auxiliary input level to avoid the sudden increase of the output level when changing the source to external component connected to the AUX input jack on the control panel.

*5 Only for FM Radio Data System stations.

*6 Depends on the amplifier gain control.

*7 Displayed only when the source is "FM."

*8 If you are using a two-speaker system, set the fader level to "00."

*9 For KD-R412/KD-R411/KD-R312/KD-R311: This adjustment will not affect the subwoofer output.

*10 Displayed only when <AUX IN> is set to <AUX ON>.



Category	Menu item	Selectable setting, [Initial: <u>Underlined</u>]
AUDIO	VOL ADJUST Volume adjust (For KD-R412/ KD-R411/KD-R35)	VOL ADJ -05 — : Preset the volume adjustment level of each source (except FM), compared to the FM volume level. The volume level will automatically increase or decrease when you change the source. VOL ADJ +05 [VOL ADJ 00] • Before making an adjustment, select the source you want to adjust. • "VOL ADJ FIX" appears on the display if "FM" is selected as the source.
	L/O MODE *11 Line output mode	• SUB.W : Select if the REAR LINE OUT terminals are used for connecting a subwoofer (through an external amplifier). • REAR : Select if the REAR LINE OUT terminals are used for connecting the speakers (through an external amplifier).
	SUB.W FREQ *11,*12 Subwoofer cutoff frequency	• LOW : Frequencies lower than 72 Hz are sent to the subwoofer. • MID : Frequencies lower than 111 Hz are sent to the subwoofer. • HIGH : Frequencies lower than 157 Hz are sent to the subwoofer.
	SUB.W LEVEL *11,*12 Subwoofer level	SUB.W 00 — : Adjust the subwoofer output level. SUB.W 08 [SUB.W 04]
	BEEP	• BEEP ON : Activates the keypress tone. • BEEP OFF : Deactivates the keypress tone.
	TEL MUTING Telephone muting	• MUTING 1/ MUTING 2 : Select either, one which mutes the sounds while using a mobile phone. • MUTING OFF : Cancels.
	AMP GAIN *13 Amplifier gain control	• LOW POWER : VOLUME 00 – VOLUME 30 (Select if the maximum power of each speaker is less than 50 W to prevent damaging the speakers.) • HIGH POWER : VOLUME 00 – VOLUME 50
SRC SELECT	AM *14 AM station	• AM ON : Enable "AM" in source selection. • AM OFF : Disable "AM" in source selection.
	AUX IN *15 Auxiliary input	• AUX ON : Enable "AUX IN" in source selection. • AUX OFF : Disable "AUX IN" in source selection.

*11 For KD-R412/KD-R411/KD-R312/KD-R311.

*12 Displayed only when <L/O MODE> is set to <SUB.W>.

*13 The volume level automatically changes to "VOLUME 30" if you change to <LOW POWER> with the volume level is set higher than "VOLUME 30."

*14 Displayed only when any source other than "AM" is selected.

*15 Displayed only when any source other than "AUX IN" is selected.

More about this unit

Basic operations

General

- If you turn off the power while listening to a track, playback will start from where it had been stopped previously next time you turn on the power.
- If no operation is done for about 60 seconds after pressing **MENU** button, the operation will be canceled.

Tuner operations

Storing stations in memory

- During SSM search...
 - All previously stored stations are erased and the stations are stored anew.
 - When SSM is over, the station stored in the lowest preset number will be automatically tuned in.
- When storing a station manually, the previously preset station is erased when a new station is stored in the same preset number.

FM Radio Data System operations

- Network-Tracking Reception requires two types of Radio Data System signals—PI (Programme Identification) and AF (Alternative Frequency) to work correctly.
- If a Traffic Announcement is received by TA Standby Reception, the volume level automatically changes to the preset level (TA VOLUME) if the current level is lower than the preset level.
- When Alternative Frequency Reception is activated (with AF selected), Network-Tracking Reception is also activated automatically.
- **PTY codes:** NEWS, AFFAIRS, INFO, SPORT, EDUCATE, DRAMA, CULTURE, SCIENCE, VARIED, POP M (music), ROCK M (music), EASY M (music), LIGHT M (music), CLASSICS, OTHER M (music), WEATHER, FINANCE, CHILDREN, SOCIAL, RELIGION, PHONE IN, TRAVEL, LEISURE, JAZZ, COUNTRY, NATION M (music), OLDIES, FOLK M (music), DOCUMENT

Disc operations

Caution for DualDisc playback

- The Non-DVD side of a “DualDisc” does not comply with the “Compact Disc Digital Audio” standard. Therefore, the use of Non-DVD side of a DualDisc on this product may not be recommended.

General

- This unit has been designed to reproduce CDs/CD Texts, and CD-Rs (Recordable)/CD-RWs (Rewritable) in audio CD (CD-DA), MP3 and WMA formats.
- If you change the source while listening to a disc, playback stops. Next time you select “CD” as the playback source, playback will start from where it had been stopped previously.
- When a disc is inserted upside down, “PLEASE” and “EJECT” appear alternately on the display. Press **▲** to eject the disc.
- If the ejected disc is not removed within 15 seconds, it is automatically inserted into the loading slot again to protect it from dust.
- MP3 and WMA “tracks” (words “file” and “track” are used interchangeably) are recorded in “folders.”
- While fast-forwarding or reversing on an MP3 or WMA disc, you can only hear intermittent sounds.

Playing a CD-R or CD-RW

- Use only “finalized” CD-Rs or CD-RWs.
- This unit can only play back files of the same type as those detected first if a disc includes both audio CD (CD-DA) files and MP3/WMA files.
- This unit can play back multi-session discs; however, unclosed sessions will be skipped while playing.



- Some CD-Rs or CD-RWs may not play back on this unit because of their disc characteristics, or for the following reasons:
 - Discs are dirty or scratched.
 - Moisture condensation has occurred on the lens inside the unit.
 - The pickup lens inside the unit is dirty.
 - The files on the CD-R/CD-RW are written using the “Packet Write” method.
 - There are improper recording conditions (missing data, etc.) or media conditions (stained, scratched, warped, etc.).
- CD-RWs may require a longer readout time since the reflectance of CD-RWs is lower than that of regular CDs.
- Do not use the following CD-Rs or CD-RWs:
 - Discs with stickers, labels, or a protective seal stuck to the surface.
 - Discs on which labels can be directly printed by an ink jet printer.
 Using these discs under high temperature or high humidity may cause malfunctions or damage to the unit.

Playing an MP3/WMA disc

- This unit can play back MP3/WMA files with the extension code <.mp3> or <.wma> (regardless of the letter case—upper/lower).
- This unit can show the names of albums, artists (performer), and Tag (Version 1.0, 1.1, 2.2, 2.3, or 2.4) for MP3 files and for WMA files.
- This unit can display only one-byte characters. No other characters can be correctly displayed.
- This unit can play back MP3/WMA files meeting the conditions below:
 - Bit rate:
 - MP3: 32 kbps — 320 kbps
 - WMA: 32 kbps — 192 kbps
 - Sampling frequency of MP3:
 - 32 kHz, 44.1 kHz, 48 kHz (for MPEG-1)
 - 16 kHz, 22.05 kHz, 24 kHz (for MPEG-2)
 - Sampling frequency of WMA:
 - 22.05 kHz, 32 kHz, 44.1 kHz, 48 kHz
 - Disc format: ISO 9660 Level 1/Level 2, Romeo, Joliet, Windows extension
- The maximum number of characters for file/folder names (includes 4 extension characters—<.mp3> or <.wma>): 12 — 128 characters (depending on the media used, etc.).
- This unit can recognize a total of 512 files, 255 folders, and 8 hierarchical levels.
- This unit can play back files recorded in VBR (variable bit rate).

Files recorded in VBR have a discrepancy in the elapsed time display, and do not show the actual elapsed time. In particular, this difference becomes noticeable after performing the search function.
- This unit cannot play back the following files:
 - MP3 files encoded in MP3i and MP3 PRO format.
 - MP3 files encoded in an inappropriate format.
 - MP3 files encoded with Layer 1/2.
 - WMA files encoded in lossless, professional, and voice format.
 - WMA files which are not based upon Windows Media® Audio.
 - WMA files copy-protected with DRM.
 - Files which have data such as AIFF, ATRAC3, etc.
- The search function works but search speed is not constant.

Playing MP3/WMA tracks from a USB device (for KD-R412/KD-R411/KD-R35)

- While playing from a USB device, the playback order may differ from other players.
- This unit may be unable to play back some USB devices or some files due to their characteristics or recording conditions.
- Depending on the shape of the USB devices and connection ports, some USB devices may not be attached properly or the connection might be loose.
- Connect one USB mass storage class device to the unit at a time. Do not use a USB hub.
- If the connected USB device does not have the correct files, "CANNOT PLAY" appears.
- This unit can show Tag (Version 1.0, 1.1, 2.2, 2.3, or 2.4) for MP3 files and for WMA files.
- This unit can play back MP3/WMA files meeting the conditions below:
 - Bit rate of MP3/WMA: 32 kbps — 320 kbps
 - Sampling frequency of MP3:
32 kHz, 44.1 kHz, 48 kHz (for MPEG-1)
16 kHz, 22.05 kHz, 24 kHz (for MPEG-2)
 - Sampling frequency of WMA:
22.05 kHz, 32 kHz, 44.1 kHz, 48 kHz
- This unit can play back MP3 files recorded in VBR (variable bit rate).
- The maximum number of characters for:
 - Folder names : 32 characters
 - File names : 32 characters
 - MP3 Tag : 64 characters
 - WMA Tag : 32 characters
- This unit can recognize a total of 5 000 files, 255 folders (255 files per folder including folder without unsupported files), and of 8 hierarchies.
- This unit does not support SD card reader.
- This unit cannot recognize a USB device whose rating is other than 5 V and exceeds 500 mA.

- USB devices equipped with special functions such as data security functions cannot be used with the unit.
- Do not use a USB device with 2 or more partitions.
- This unit may not recognize a USB device connected through a USB card reader.
- This unit may not play back files in a USB device properly when using a USB extension cord.
- This unit cannot play back the following files:
 - MP3 files encoded with MP3i and MP3 PRO format.
 - MP3 files encoded in an inappropriate format.
 - MP3 files encoded with Layer 1/2.
 - WMA files encoded in lossless, professional, and voice format.
 - WMA files not based on Windows Media® Audio.

Preset sound mode

Tone	Sound element		
	Frequency	Level	Q
BASS	60 Hz	–06 to +06	Q1.0
	80 Hz		Q1.25
	100 Hz		Q1.5
	200 Hz		Q2.0
MIDDLE	0.5 kHz	–06 to +06	Q0.75
	1.0 kHz		Q1.0
	1.5 kHz		Q1.25
	2.5 kHz		
TREBLE	10.0 kHz	–06 to +06	Q FIX
	12.5 kHz		
	15.0 kHz		
	17.5 kHz		

Maintenance

How to clean the connectors

Frequent detachment will deteriorate the connectors.

To minimize this possibility, periodically wipe the connectors with a cotton swab or cloth moistened with alcohol, being careful not to damage the connectors.

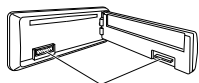

Connectors

Moisture condensation

Moisture may condense on the lens inside the unit in the following cases:

- After starting the heater in the car.
 - If it becomes very humid inside the car.
- Should this occur, the unit may malfunction. In this case, eject the disc and leave the unit turned on for a few hours until the moisture has evaporated.

How to handle discs

When removing a disc from its case, press down the center holder of the case and lift the disc out, holding it by the edges.

- Always hold the disc by the edges. Do not touch its recording surface.

When storing a disc in its case, gently insert the disc around the center holder (with the printed surface facing up).

- Make sure to store discs in cases after use.

Center holder



To keep discs clean

A dirty disc may not play correctly. If a disc does become dirty, wipe it with a soft cloth in a straight line from center to edge.

- Do not use any solvents (for example, conventional record cleaner, spray, thinner, benzene, etc.) to clean discs.







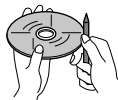

To play new discs

New discs may have some rough spots around the inner and outer edges. If such a disc is used, this unit may reject the disc.

To remove these rough spots, rub the edges with a pencil or ball-point pen, etc.



Do not use the following discs:

Single CD (8 cm disc) 	Warped disc 
Sticker and sticker residue 	Stick-on label 
Unusual shape 	C-thru Disc (semitransparent disc) 
Transparent or semitransparent parts on its recording area 	

Troubleshooting

	Symptom	Remedy/Cause
General	Sound cannot be heard from the speakers.	<ul style="list-style-type: none"> • Adjust the volume to the optimum level. • Make sure the unit is not muted/paused (🔍 5). • Check the cords and connections.
	"PROTECT" appears on the display and no operations can be done.	<p>Check to be sure the terminals of the speaker leads are covered with insulating tape properly, then reset the unit (🔍 3).</p> <p>If "PROTECT" does not disappear, consult your JVC IN-CAR ENTERTAINMENT dealer or a company supplying kits.</p>
	The unit does not work at all.	Reset the unit. (🔍 3)
	"AUX" cannot be selected.	Check the <SRC SELECT> → <AUX IN> setting. (🔍 16)
FM/AM	SSM automatic presetting does not work.	Store stations manually.
	Static noise while listening to the radio.	Connect the aerial firmly.
	"AM" cannot be selected.	Check the <SRC SELECT> → <AM> setting. (🔍 16)
Disc playback	Disc cannot be played back.	Insert the disc correctly.
	<ul style="list-style-type: none"> • CD-R/CD-RW cannot be played back. • Tracks on the CD-R/CD-RW cannot be skipped. 	<ul style="list-style-type: none"> • Insert a finalized CD-R/CD-RW. • Finalize the CD-R/CD-RW with the component which you used for recording.
	Disc can neither be played back nor ejected.	<ul style="list-style-type: none"> • Unlock the disc. (🔍 8) • Eject the disc forcibly. (🔍 3)
	Disc sound is sometimes interrupted.	<ul style="list-style-type: none"> • Stop playback while driving on rough roads. • Change the disc. • Check the cords and connections.
	"NO DISC" appears on the display.	Insert a playable disc into the loading slot.
	"PLEASE" and "EJECT" appear alternately on the display.	Press ▲, then insert a disc correctly.



	Symptom	Remedy/Cause
MP3/WMA playback	Disc cannot be played back.	<ul style="list-style-type: none"> Use a disc with MP3/WMA tracks recorded in a format compliant with ISO 9660 Level 1, Level 2, Romeo, or Joliet. Add the extension code <.mp3> or <.wma> to the file names.
	Noise is generated.	Skip to another track or change the disc. (Do not add the extension code <.mp3> or <.wma> to non-MP3 or WMA tracks.)
	A longer readout time is required ("READING" keeps flashing on the display).	Do not use too many hierarchical levels and folders.
	Tracks do not play back in the order you have intended them to play.	The playback order is determined when the files are recorded.
	For KD-R412/KD-R411/KD-R35: "NO FILE" appears on the display.	Selected folder is an empty folder *. Select another folder that contains MP3/WMA tracks. * Folder that is physically empty or folder that contains data but does not contain valid MP3/WMA track.
	"NOT SUPPORT" appears on the display and track skips.	Skip to the next track encoded in an appropriate format or to the next non-copy-protected WMA track.
	The elapsed playing time is not correct.	This sometimes occurs during playback. This is caused by how the tracks are recorded on the disc.
The correct characters are not displayed (e.g. album name).	This unit can only display letters (upper case), numbers, and a limited number of symbols.	

	Symptom	Remedy/Cause
USB device playback (for KD-R412/KD-R411/KD-R35)	Noise is generated.	The track played back is not an MP3/WMA track. Skip to another file. (Do not add the extension code <.mp3> or <.wma> to non-MP3 or WMA tracks.)
	"READING" keeps flashing on the display.	<ul style="list-style-type: none"> • Readout time varies depending on the USB device. • Do not use too many hierarchy or folders. • Turn off the power then on again. • Reattach the USB device again.
	"NO FILE" appears on the display.	<p>Selected folder is an empty folder*. Select another folder that contains MP3/WMA tracks.</p> <p><i>* Folder that is physically empty or folder that contains data but does not contain valid MP3/WMA track.</i></p>
	"NOT SUPPORT" appears on the display and track skips.	Skip to the next track encoded in an appropriate format or to the next non-copy-protected WMA track.
	Tracks/folders are not played back in the order you have intended.	The playback order is determined by the write-in time stamp. The first track/folder written into the USB device will be the first track/folder for playback.
	<ul style="list-style-type: none"> • "CANNOT PLAY" flashes on the display. • "NO USB" appears on the display. • The unit cannot detect the USB device. 	<ul style="list-style-type: none"> • Attach a USB device that contains tracks encoded in an appropriate format. • Reattach the USB device again.
	The correct characters are not displayed (e.g. album name).	This unit can only display letters (upper case), numbers, and a limited number of symbols.
	While playing a track, sound is sometimes interrupted.	<p>The MP3/WMA tracks have not been properly copied into the USB device.</p> <p>Copy MP3/WMA tracks again into the USB device, and try again.</p>

JVC bears no responsibility for any loss of the data in the USB mass storage class device while using this System.

Specifications

AUDIO AMPLIFIER SECTION	Maximum Power Output:	Front/ Rear:	50 W per channel	
	Continuous Power Output (RMS):	Front/ Rear:	19 W per channel into 4 Ω , 40 Hz to 20 000 Hz at no more than 0.8% total harmonic distortion.	
	Load Impedance:		4 Ω (4 Ω to 8 Ω allowance)	
	Tone Control Range:	Bass:	± 12 dB (60 Hz, 80 Hz, 100 Hz, 200 Hz) Q1.0, Q1.25, Q1.5, Q2.0	
		Middle:	± 12 dB (0.5 kHz, 1.0 kHz, 1.5 kHz, 2.5 kHz) Q0.75, Q1.0, Q1.25	
		Treble:	± 12 dB (10.0 kHz, 12.5 kHz, 15.0 kHz, 17.5 kHz) Q (Fixed)	
	Frequency Response:		40 Hz to 20 000 Hz	
	Signal-to-Noise Ratio:		70 dB	
	Line-Out Level/Impedance:	Except KD-R35:	2.5 V/20 k Ω load (full scale)	
	Subwoofer-Out Level/Impedance:	Except KD-R35:	2.5 V/20 k Ω load (full scale)	
Output Impedance:		1 k Ω		
Other Terminal:		<ul style="list-style-type: none"> • AUX (auxiliary) input jack, Aerial input • For KD-R412/KD-R411: Steering wheel remote input, USB input Jack • For KD-R35: USB input Jack 		
TUNER SECTION	Frequency Range:	FM:	87.5 MHz to 108.0 MHz	
		AM:	MW:	522 kHz to 1 620 kHz
			LW:	144 kHz to 279 kHz
	FM Tuner:	Usable Sensitivity:	9.3 dBf (0.8 μ V/75 Ω)	
		50 dB Quieting Sensitivity:	16.3 dBf (1.8 μ V/75 Ω)	
		Alternate Channel Selectivity (400 kHz):	65 dB	
		Frequency Response:	40 Hz to 15 000 Hz	
		Stereo Separation:	40 dB	
	MW Tuner:	Sensitivity:	20 μ V	
		Selectivity:	40 dB	
LW Tuner:	Sensitivity:	50 μ V		

CD PLAYER SECTION	Type:		Compact disc player	
	Signal Detection System:		Non-contact optical pickup (semiconductor laser)	
	Number of Channels:		2 channels (stereo)	
	Frequency Response:		5 Hz to 20 000 Hz	
	Dynamic Range:		93 dB	
	Signal-to-Noise Ratio:		98 dB	
	Wow and Flutter:		Less than measurable limit	
	MP3 Decoding Format: (MPEG1/2 Audio Layer 3)		Max. Bit Rate: 320 kbps	
	WMA (Windows Media® Audio) Decoding Format:		Max. Bit Rate: 192 kbps	
USB SECTION (for KD-R412/ KD-R411/KD-R35)	USB Standard:		USB 1.1, USB 2.0	
	Data Transfer Rate (Full Speed):		Max. 12 Mbps	
	Compatible Device:		Mass storage class	
	Compatible File System:		FAT 32/16/12	
	Playable Audio Format:		MP3/WMA	
	Max. Current:		DC 5 V  500 mA	
GENERAL	Power Requirement:	Operating Voltage:	DC 14.4 V (11 V to 16 V allowance)	
	Grounding System:		Negative ground	
	Allowable Operating Temperature:		0°C to +40°C	
	Dimensions (W × H × D): (approx.)	Installation Size:	182 mm × 52 mm × 160 mm	
		Panel Size:	188 mm × 58 mm × 13 mm	
	Mass:		1.3 kg (excluding accessories)	

Design and specifications are subject to change without notice.

Microsoft and Windows Media are either registered trademarks or trademarks of Microsoft Corporation in the United States and/or other countries.

Having TROUBLE with operation?

Please reset your unit

Refer to page of How to reset your unit

Vous avez des PROBLÈMES de fonctionnement?

Réinitialisez votre appareil

Référez-vous à la page intitulée Comment réinitialiser votre appareil

Dear Customer,

This apparatus is in conformance with the valid European directives and standards regarding electromagnetic compatibility and electrical safety.

European representative of Victor Company of Japan, Limited is:

JVC Technical Services Europe GmbH
Postfach 10 05 04
61145 Friedberg
Germany

Cher(e) client(e),

Cet appareil est conforme aux directives et normes européennes en vigueur concernant la compatibilité électromagnétique et à la sécurité électrique.

Représentant européen de la société Victor Company of Japan, Limited:

JVC Technical Services Europe GmbH
Postfach 10 05 04
61145 Friedberg
Allemagne

JVC



EN, FR

© 2009 Victor Company of Japan, Limited

1009DTSMDTJEIN

JVC KD-R312/KD-R311

Installation/Connection Manual

Manuel d'installation/raccordement

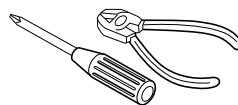

GET0624-010A
[E/EU]

1009DTSMDTJEIN
EN, FR

© 2009 Victor Company of Japan, Limited

ENGLISH / FRANÇAIS

You need the installation kits which corresponds to your car. / Vous avez besoin des kits d'installation correspondants à votre voiture.

Check the battery system in your car / Vérifiez le système de batterie de votre voiture

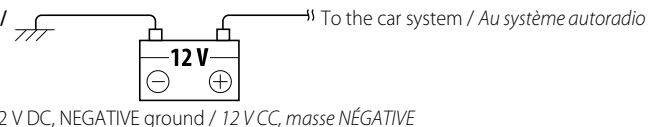

WARNINGS / AVERTISSEMENTS

- To prevent short circuits:
 - Disconnect the battery's negative terminal and make all electrical connections before installing the unit.
 - Cover the terminals of the UNUSED leads with insulating tape.
- Be sure to ground this unit to the car's chassis again after installation.
- Replace the fuse with one of the specified rating.
- Connect speakers with a maximum power of more than 50 W (impedance of 4 Ω to 8 Ω). Otherwise, change the <AMP GAIN> setting. (See page 16 of the INSTRUCTIONS.)
- The heat sink becomes very hot after use. Be careful not to touch it when removing this unit.



Heat sink / Dissipateur de chaleur

- Pour éviter les courts-circuits:
 - Déconnectez la borne négative de la batterie et réalisez toutes les connexions avant d'installer l'appareil.
 - Recouvrez les prises des fils NON UTILISÉS avec du ruban isolant.
- Assurez-vous de raccorder de nouveau la mise à la masse de cet appareil au châssis de la voiture après l'installation.
- Remplacer le fusible par un de la valeur précisée.
- Connectez des enceintes avec une puissance maximum de 50 W (impédance de 4 Ω à 8 Ω). Sinon, changez le réglage <AMP GAIN>. (Voir la page 16 du MANUEL D'INSTRUCTIONS.)
- Le dissipateur de chaleur devient très chaud après usage. Faire attention de ne pas le toucher en retirant cet appareil.

PRECAUTIONS on power supply and speaker connections

- DO NOT connect the speaker leads of the power cord to the car battery; otherwise, the unit will be seriously damaged.
- BEFORE connecting the speaker leads of the power cord to the speakers, check the speaker wiring in your car.

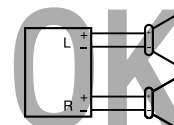
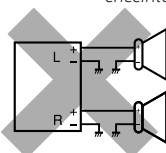
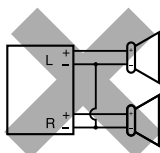

PRECAUTIONS sur l'alimentation et la connexion des enceintes

- NE CONNECTEZ PAS les fils d'enceintes du cordon d'alimentation à la batterie; sinon, l'appareil serait sérieusement endommagé.
- AVANT de connecter les fils d'enceintes du cordon d'alimentation aux enceintes, vérifiez le câblage des enceintes de votre voiture.

INSTALLATION / INSTALLATION

The following illustration shows a typical installation. If you have any questions or require information regarding installation kits, consult your JVC IN-CAR ENTERTAINMENT dealer or a company supplying kits.

L'illustration suivante est un exemple d'installation typique. Si vous avez des questions ou avez besoin d'information sur des kits d'installation, consulter votre revendeur d'autoradios JVC.

In-dash mounting / Montage encastré

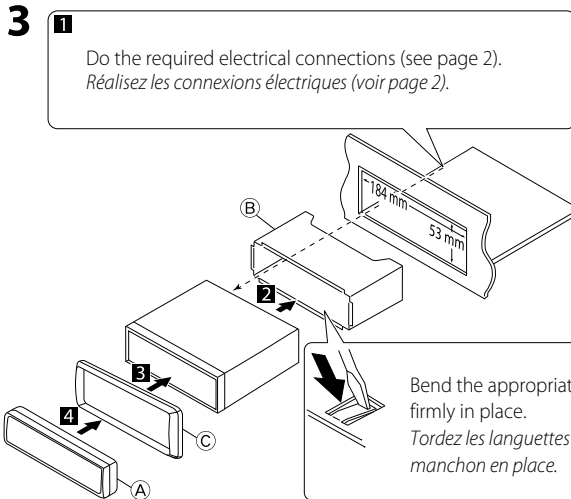
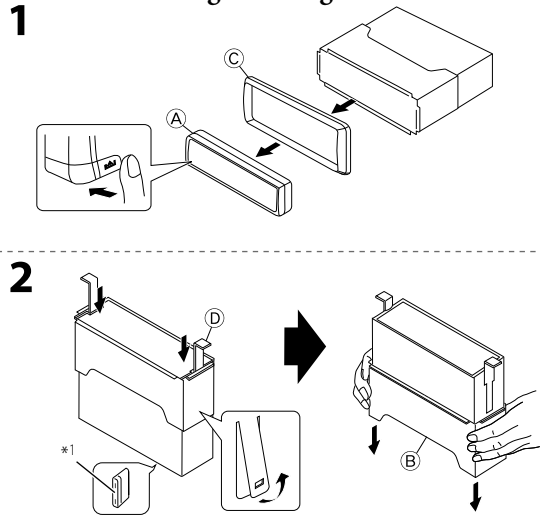

Install the unit at an angle of less than 30°. / Installez l'appareil avec un angle de moins de 30°.

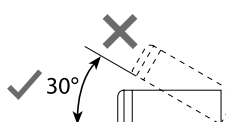

Bend the appropriate tabs to hold the sleeve firmly in place. / Tordez les languettes appropriées pour maintenir le manchon en place.

Part list / Liste de pièces

- A Control panel / Panneau de commande (x1)
- B Sleeve / Manchon (x1)
- C Trim plate / Plaque d'assemblage (x1)
- D Handles / Poignées (x2)

When installing the unit without using the sleeve / Lors de l'installation de l'appareil sans utiliser de manchon

Flat head screws (M5 × 8 mm) / Vis à tête plate (M5 × 8 mm) *2

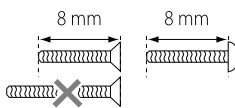
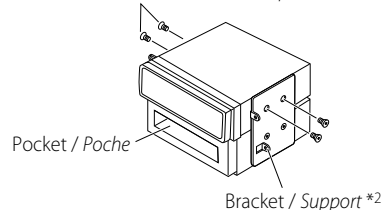

Removing the unit / Retrait de l'appareil

Release the rear section first... / Ouvrez la section arrière en premier...

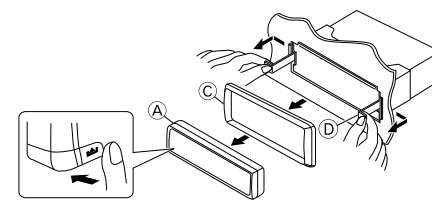

*1 When you stand the unit, be careful not to damage the fuse on the rear.

*2 Not supplied for this unit.

*1 Lorsque vous mettez l'appareil à la verticale, faire attention de ne pas endommager le fusible situé sur l'arrière.

*2 Non fourni avec cet appareil.

ELECTRICAL CONNECTIONS / RACCORDEMENTS ELECTRIQUES

The following illustration shows a typical connection. Select an appropriate connection method according to your car.

L'illustration suivante est un exemple de connexion typique. Choisissez une méthode de connexion appropriée en fonction de votre voiture.

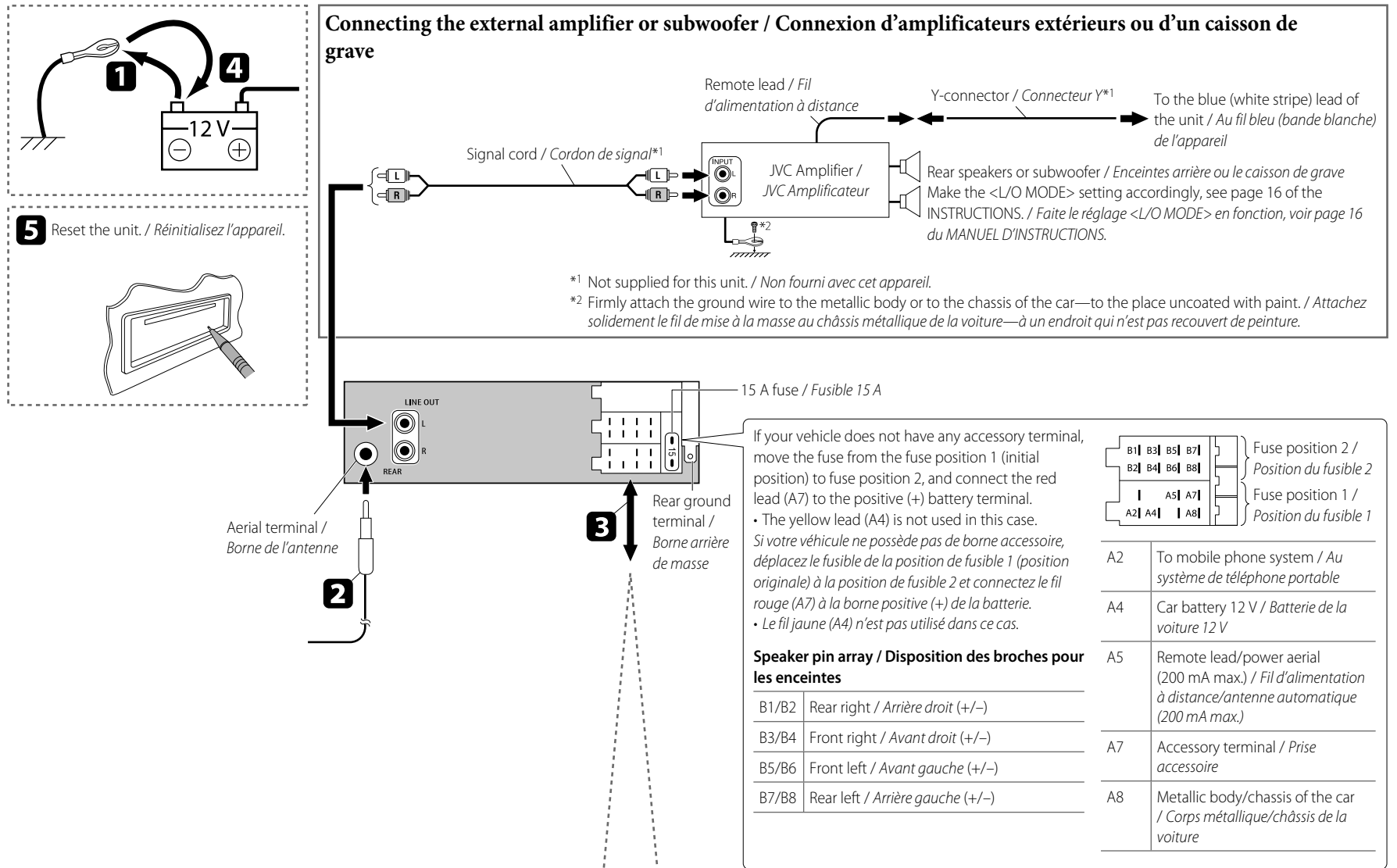

Connecting the unit to the vehicle / Connexion de l'appareil au véhicule

1. When the connector on the vehicle side is a ISO terminal (same terminal as this unit) / Lorsque le connecteur du côté véhicule est une prise ISO (même terminal que cet appareil)

- The connector of the vehicle and this unit having the **SAME** pin array. / Le connecteur du véhicule et cet appareil ont la **MÊME** disposition de broches.
- Refer to the pin array above to confirm the connectors on the vehicle and this unit are the same. / Référez-vous à la disposition des broches ci-dessous pour vérifier que les connecteurs du véhicule et de cet appareil sont les mêmes.

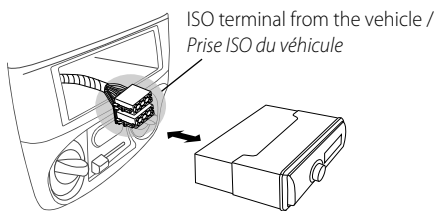

- The connector of the vehicle and this unit having **DIFFERENT** pin array. / Le connecteur du véhicule et cet appareil ont une disposition de broches **DIFFÉRENTE**.

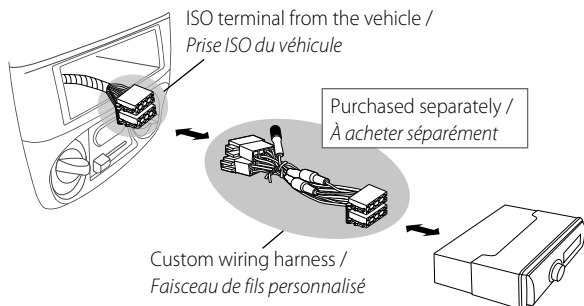

2. When the connector on the vehicle side is NOT a ISO terminal (different terminal as this unit) / Lorsque le connecteur du côté véhicule N'est PAS une prise ISO (terminal différent que cet appareil)

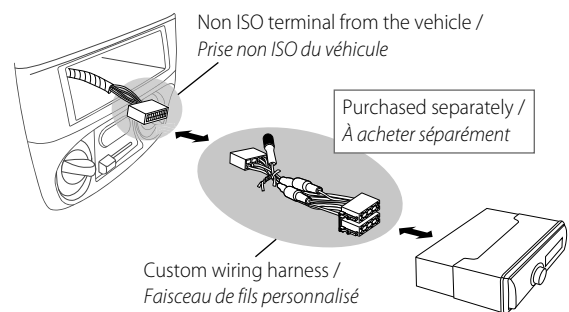

Consult your JVC IN-CAR ENTERTAINMENT dealer or a company supplying kits for details about connection. / Pour en savoir plus sur connexions, consultez votre revendeur d'autoradio JVC ou une compagnie fournissant des kits.

TROUBLESHOOTING / EN CAS DE DIFFICULTES

- The fuse blows.** ⇒ Are the red and black leads connected correctly?
- Power cannot be turned on.** ⇒ Is the yellow lead connected?
- No sound from the speakers.** ⇒ Is the speaker output lead short-circuited?
- "PROTECT" appears on the display and no operation can be done.** ⇒ Is the speaker output lead short-circuited or touches the chassis of the car/head unit?; Have you reset your unit?
- Sound is distorted.** ⇒ Is the speaker output lead grounded?; Are the "-" terminals of L and R speakers grounded in common?
- Noise interfere with sounds.** ⇒ Is the rear ground terminal connected to the car's chassis using shorter and thicker cords?
- This unit becomes hot.** ⇒ Is the speaker output lead grounded?; Are the "-" terminals of L and R speakers grounded in common?
- This unit does not work at all.** ⇒ Have you reset your unit?

- Le fusible saute.** ⇒ Les fils rouge et noir sont-ils raccordés correctement?
- L'appareil ne peut pas être mise sous tension.** ⇒ Le fil jaune est-elle raccordée?
- Pas de son des enceintes.** ⇒ Le fil de sortie d'enceinte est-il court-circuité?
- "PROTECT" apparaît sur l'affichage et aucune opération ne peut être réalisée.** ⇒ Est-ce qu'un fil de sortie d'enceinte est court-circuité ou touche le châssis de la voiture/appareil principal?; Avez-vous réinitialisé votre appareil?
- Le son est déformé.** ⇒ Le fil de sortie d'enceinte est-il à la masse?; Les bornes "-" des enceintes gauche et droit sont-elles mises ensemble à la masse?
- Interférence avec les sons.** ⇒ La prise arrière de mise à la terre est-elle connectée au châssis de la voiture avec un cordon court et épais?
- Cet appareil devient chaud.** ⇒ Le fil de sortie d'enceinte est-il à la masse?; Les bornes "-" des enceintes gauche et droit sont-elles mises ensemble à la masse?
- Cet appareil ne fonctionne pas du tout.** ⇒ Avez-vous réinitialisé votre appareil?

JVC

KD-R414/KD-R314

CD RECEIVER : INSTRUCTIONS/INSTALLATION



MP3 WMA

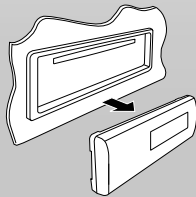

Thank you for purchasing a JVC product.
Please read all instructions carefully before operation, to ensure your complete understanding and to obtain the best possible performance from the unit.

1009DTSMDTJEIN
EN

© 2009 Victor Company of Japan, Limited

GET0659-001A
[U]

Canceling the display demonstration

1 Turn on the power.



2 MENU [Hold]



4 Select <DEMO OFF>.



6 Finish the procedure.



Setting the clock

1 Turn on the power.



2 MENU [Hold]



3 Select <CLOCK>.

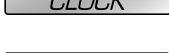

4 Select <CLOCK SET>.



5 Adjust the hour.



6 Adjust the minute.



7 Finish the procedure.



Preparations

How to attach/detach the control panel

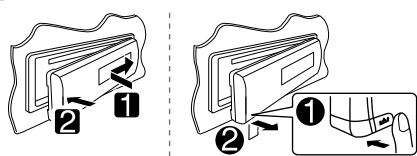

How to reset your unit

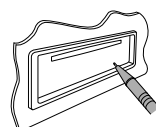

Reset the unit after installation is completed.
• Your preset adjustments will also be erased.

How to forcibly eject a disc

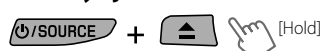

- You can forcibly eject the loaded disc even if the disc is locked. To lock/unlock the disc, see page 2.
- Be careful not to drop the disc when it ejects.
- If this does not work, reset your unit.

For safety...

- Do not raise the volume level too much, as this will block outside sounds, making driving dangerous.
- Stop the car before performing any complicated operations.

Temperature inside the car...

If you have parked the car for a long time in hot or cold weather, wait until the temperature in the car becomes normal before operating the unit.

Preparing the remote controller (RM-RK50)

When you use the remote controller for the first time, pull out the insulation sheet.

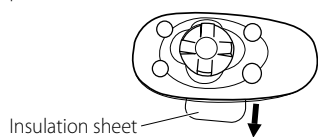

If the effectiveness of the remote controller decreases, replace the battery.

Replacing the lithium coin battery

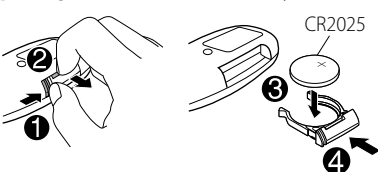

Caution:

- Danger of explosion if battery is incorrectly replaced. Replace only with the same or equivalent type.
- Battery shall not be exposed to excessive heat such as sunshine, fire, or the like.

Warning (about battery handling)

To prevent accidents and damage:

- Do not install any battery other than CR2025 or its equivalent.
- Store out of reach of children.
- Do not recharge, short, or dismantle.
- Do not dispose of in fire.
- Do not carry around with other metallic materials.
- Wrap the battery with tape and insulate when throwing away or saving it.

IMPORTANT FOR LASER PRODUCTS

1. CLASS 1 LASER PRODUCT
2. **CAUTION:** Do not open the top cover. There are no user serviceable parts inside the unit; leave all servicing to qualified service personnel.
3. **CAUTION:** Visible and/or invisible class 1M laser radiation when open. Do not view directly with optical instruments.
4. REPRODUCTION OF LABEL: CAUTION LABEL, PLACED OUTSIDE THE UNIT.

CAUTION VISIBLE AND/OR INVISIBLE CLASS 1M LASER RADIATION WHEN OPEN. DO NOT VIEW DIRECTLY WITH OPTICAL INSTRUMENTS. IEC60825-1:2001 (EN)	ATTENTION RAYONNEMENT LASER VISIBLE ET/OU INVISIBLE DE CLASSE 1M LORS QU'OUVERT NE PAS REGARDER DIRECTEMENT AVEC DES INSTRUMENTS OPTIQUES. (FR)	AVISO RADIACION LASER DE CLASE 1M VISIBLE Y/O INVISIBLE CUANDO ESTA ABIERTO. NO MIRAR DIRECTAMENTE CON INSTRUMENTAL OPTICA. (ES)	VARNING SYNLIG OCH/ELLER OSYNLIG LASERSTRÅLNING KLASS 1M NÅR DENNA DEL ÄR ÖPPNAD. BETRÄKTA EJ STRÅLEN MED OPTISKA INSTRUMENT. (SVE)	注意 この製品はレーザー光線 を放射する可能性があります。 レーザー光線は目や皮膚を 傷めます。 光学機器で直接見ると 有害です。 (JPN)	CAUTION VISIBLE AND/OR INVISIBLE CLASS II LASER RADIATION WHEN OPEN. DO NOT STARE INTO BEAM. FDA 21 CFR (EN)
---	---	--	---	---	---



Warning:

If you need to operate the unit while driving, be sure to look around carefully or you may be involved in a traffic accident.

Basic operations

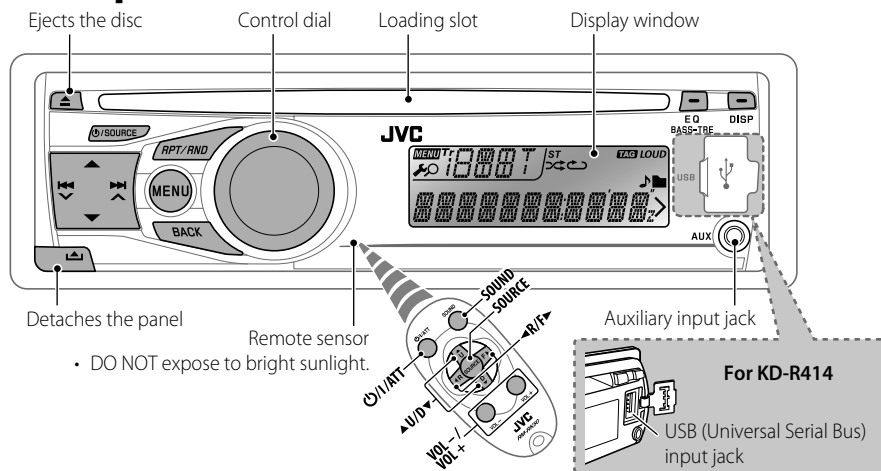

When you press or hold the following button(s)...

Main unit	Remote controller	General operation
SOURCE	II/ATT	Turns on. • When the power is on, pressing II/ATT on the remote controller also mutes the sound or pauses. Press II/ATT again to cancel muting or resume playback.
		Turns off if pressed and held.
	SOURCE	Selects the available sources (if the power is turned on). • If the source is ready, playback also starts.
Control dial	VOL- VOL+	Adjusts the volume level.
		Selects items.
Control dial		• Mutes the sound while listening to a source. If the source is "CD" or "USB (for KD-R414)," playback pauses. Press the control dial again to cancel muting or resume playback. • Confirms selection.
EQ BASS-TRE	SOUND	Selects the sound mode. • Enters tone level adjustment directly (see page 2) if pressed and held EQ BASS-TRE on the main unit.
RPT/RND		Enters playback mode menu directly (see page 2).
BACK		Returns to the previous menu.
DISP		Power off : Checks the current clock time. Power on : Changes the display information.

Maintenance

How to clean the connectors

Wipe the connectors with a cotton swab or cloth moistened with alcohol.

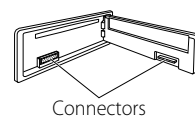

To play new discs

Remove any rough areas from the inner and outer edges of the disc.



Do not use the following discs:

- Single CD (8 cm disc)
- Warped disc
- Disc with sticker and sticker residue
- Disc with stick-on label
- Unusual shape disc
- C-thru Disc (semi-transparent disc)
- Disc with transparent or semi-transparent parts on its recording area

Moisture condensation

Moisture may condense on the lens inside the unit. Eject the disc and leave the unit turned on for a few hours until the moisture has evaporated.

To keep discs clean

Wipe in a straight line from center of disc to edge. Do not use liquid cleaners, thinners, or benzene.



Microsoft and Windows Media are either registered trademarks or trademarks of Microsoft Corporation in the United States and/or other countries.

Listening to the radio



⇒ "FM" or "AM"



"ST" lights up when receiving an FM stereo broadcast with sufficient signal strength.

Manual search



"M" flashes, then press the button repeatedly.

When an FM stereo broadcast is hard to receive



⇒ <TUNER>

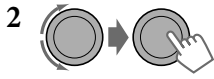

⇒ <MONO ON>
Reception improves, but stereo effect will be lost.

To restore the stereo effect, repeat the same procedure to select <MONO OFF>.

Automatic presetting (FM)—SSM (Strong-station Sequential Memory)

You can preset up to 18 stations for FM.

While listening to a station...



⇒ <TUNER>

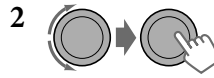

⇒ <SSM> ⇒ <SSM 01 - 06> / <SSM 07 - 12> / <SSM 13 - 18>
"SSM" flashes and local stations with the strongest signals are searched and stored automatically.

To preset another 6 stations, repeat the above procedure by selecting one of the other 6 SSM setting ranges.

Manual presetting (FM/AM)

You can preset up to 18 stations for FM and 6 stations for AM.

Ex.: Storing FM station of 92.50 MHz into preset number "04."



⇒ "92.50MHz"



"PRESET MODE" flashes.

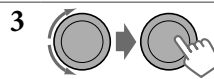

⇒ Selects preset number "04."
"P04" flashes and "MEMORY" appears.

Listening to the USB device (for KD-R414)

This unit can play MP3/WMA tracks stored in a USB device.



⇒ Turn on the power.

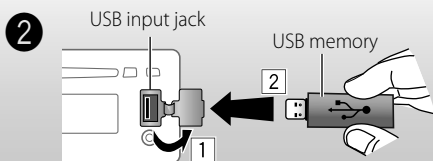

All tracks will be played repeatedly until you change the source or detach the USB device.

If a USB device has been attached...

Pressing SOURCE turns on the power and playback starts from where it has been stopped previously.

- If a different USB device is currently attached, playback starts from the beginning.

Stopping playback and detaching the USB device

Straightly pull it out from the unit.

"NO USB" appears. Press SOURCE to listen to another playback source.

You can operate the USB device in the same way you operate the files on a disc.

Caution on volume setting:

USB devices produce very little noise compared with other sources. Lower the volume before playing a USB to avoid damaging the speakers by sudden increase of the output level.

Selecting a preset station

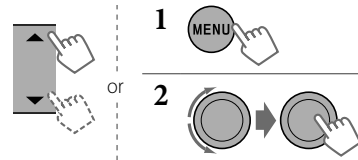

Assigning title to a station

You can assign titles to 30 station frequencies (FM and AM) using 8 characters (maximum) for each title.

- If you try to assign titles to more than 30 station frequencies, "NAME FULL" appears. Delete unwanted titles before assignment.



⇒ "FM" or "AM"



⇒ Show the title entry screen.



⇒ Selects a character.



⇒ Move to the next (or previous) character position.

5 Repeat steps 3 and 4 until you finish entering the title.



To erase the entire title, press and hold DISP after step 2, then press the control dial.

Available characters

A	B	C	D	E	F	G	H	I	J	K
L	M	N	O	P	Q	R	S	T	U	V
W	X	Y	Z	0	1	2	3	4	5	6
7	8	9	-	/	<	>				Space

Changing the display information

Station name* → Frequency → Clock → (back to the beginning)

* If no title is assigned to a station, "NO NAME" appears for a few seconds.

Using the remote controller

▲ U/D ▼ : Changes the preset stations
◀ R/F ▶ : Searches for stations

Listening to the disc



⇒ Turn on the power.



All tracks will be played repeatedly until you change the source or eject the disc.

Stopping playback and ejecting the disc



"NO DISC" appears.
Press SOURCE to listen to another playback source.

Prohibiting disc ejection



To cancel the prohibition, repeat the same procedure.



Selects folder of the MP3/WMA



Selects track



Fast-forwards or reverses the track

Selecting a track/folder

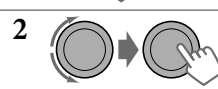

For MP3/WMA discs, select the desired folder, then the desired track by repeating step 2.

- To return to the previous menu, press BACK.

Caution on volume setting:

Discs produce very little noise compared with other sources. Lower the volume before playing a disc to avoid damaging the speakers by the sudden increase of the output level.

Selecting the playback modes

You can use only one of the following playback modes at a time.



⇒ "REPEAT" ↔ "RANDOM"



REPEAT
TRACK RPT : Repeats current track
FOLDER RPT : Repeats current folder
RANDOM
FOLDER RND : Randomly plays all tracks of current folder, then tracks of next folders
ALL RND : Randomly plays all tracks

To cancel repeat play or random play, select "RPT OFF" or "RND OFF."

Changing the display information



Disc title/Album name/performer (folder name)*
→ Track title (file name)* → Current track number with the elapsed playing time → Current track number with the clock time → (back to the beginning)

* If the current disc is an audio CD, "NO NAME" appears. If an MP3/WMA file does not have Tag information or <TAG DISPLAY> is set to <TAG OFF> (see page 3), folder name and file name appear.

Using the remote controller

▲ U/D ▼ : Selects folder of the MP3/WMA
◀ R/F ▶ : Selects track
◀ R/F ▶ : Fast-forwards or reverses the track [Hold]

Listening to the external components

You can connect an external component to the AUX (auxiliary) input jack on the control panel.

- Make sure <AUX ON> is selected for the <SRC SELECT> → <AUX IN> setting on page 3.



⇒ "AUX IN"

2 Turn on the connected component and start playing the source.

- For details, refer also to the instructions supplied with the adapter or external components.

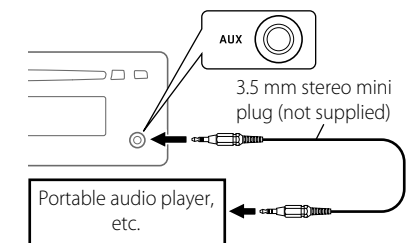

Selecting a preset sound mode

You can select a preset sound mode suitable for the music genre.

EQ BASS-TRE
FLAT → NATURAL → DYNAMIC → VOCAL BOOST → BASS BOOST → USER → (back to the beginning)

While listening, you can adjust the tone level of the selected sound mode.



Adjust the level (-06 to +06) of the selected tone (BASS / MIDDLE / TREBLE).
The sound mode is automatically stored and changed to "USER."

Storing your own sound mode

You can store your own adjustments in memory.



⇒ <PRO EQ> ⇒ <BASS> / <MIDDLE> / <TREBLE>



Adjust the sound elements of the selected tone (see table on the left).

4 Repeat steps 2 and 3 to adjust other tones. The adjustments made will be stored automatically in "USER."

The current sound mode changes to "USER" automatically.

Tone	Sound element		
	Frequency	Level	Q
BASS	60 Hz, 80 Hz, 100 Hz, 200 Hz	-06 to +06	Q1.0 Q1.25 Q1.5 Q2.0
MIDDLE	0.5 kHz, 1.0 kHz, 1.5 kHz, 2.5 kHz	-06 to +06	Q0.75 Q1.0 Q1.25
TREBLE	10.0 kHz, 12.5 kHz, 15.0 kHz, 17.5 kHz	-06 to +06	Q FIX

Menu operations

- 1** [Hold]
- 2**
- 3** Repeat step 2 if necessary.
 - To return to the previous menu, press **BACK**.
 - To exit from the menu, press **DISP** or **MENU**.

Category	Menu item	Selectable setting, [Initial: <u>Underlined</u>]
DEMO	DEMO	• DEMO ON : Display demonstration will be activated automatically if no operation is done for about 20 seconds.
		• DEMO OFF : Cancels.
CLOCK	CLOCK SET	[<u>1:00</u>] : Adjust the hour, then the minute.
PRO EQ	BASS	— : For settings, see "Storing your own sound mode" on page 2.
	MIDDLE	
	TREBLE	
DISPLAY	DIMMER	• DIMMER ON : Dims the display and button illumination.
		• DIMMER OFF : Cancels.
		• SCROLL ONCE : Scrolls the displayed information once.
TUNER	SSM *2	• SSM 01 – 06 : For settings, see page 2.
		• SSM 07 – 12
TUNER	MONO *2	• MONO ON : Activate monaural mode to improve FM reception, but stereo effect will be lost.
		• MONO OFF : Restore the stereo effect. (See page 2.)
		IF BAND
AUDIO	FADER *3	R06 – F06 [<u>00</u>] : Adjust the front and rear speaker output balance.
		BALANCE *4
	LOUD	• LOUD ON : Boost low and high frequencies to produce a well-balanced sound at a low volume level.
		• LOUD OFF : Cancels.
	AUX ADJUST *5 (For KD-R314)	AUX ADJ 00 — AUX ADJ 05 : Adjust the auxiliary input level to avoid the sudden increase of the output level when changing the source to external component connected to the AUX input jack on the control panel.
	VOL ADJUST (For KD-R414)	VOL ADJ -05 — VOL ADJ +05 [<u>VOL ADJ 00</u>] : Preset the volume adjustment level of each source (except FM), compared to the FM volume level. The volume level will automatically increase or decrease when you change the source. <ul style="list-style-type: none"> • Before making an adjustment, select the source you want to adjust. • "VOL ADJ FIX" appears on the display if "FM" is selected as the source.
	L/O MODE	• SUB.W : Select if the REAR LINE OUT terminals are used for connecting a subwoofer (through an external amplifier).
		• REAR : Select if the REAR LINE OUT terminals are used for connecting the speakers (through an external amplifier).
	SUB.W FREQ *6	• LOW : Frequencies lower than 72 Hz are sent to the subwoofer.
• HIGH : Frequencies lower than 157 Hz are sent to the subwoofer.		
SUB.W LEVEL *6	SUB.W 00 — SUB.W 08 [<u>SUB.W 04</u>] : Adjust the subwoofer output level.	
BEEP	• BEEP ON : Activates the keypress tone.	
	• BEEP OFF : Deactivates the keypress tone.	
AMP GAIN *7	• LOW POWER : VOLUME 00 – VOLUME 30 (Select if the maximum power of each speaker is less than 50 W to prevent damaging the speakers.)	
	• HIGH POWER : VOLUME 00 – VOLUME 50	
SRC SELECT	AM *8	• AM ON : Enable "AM" in source selection.
	AUX IN *9	• AUX ON : Enable "AUX IN" in source selection.
		• AM OFF : Disable "AM" in source selection.
		• AUX OFF : Disable "AUX IN" in source selection.

*1 Some characters or symbols will not be shown correctly (or will be blanked) on the display.
 *2 Displayed only when the source is "FM."
 *3 If you are using a two-speaker system, set the fader level to "00."
 *4 This adjustment will not affect the subwoofer output.
 *5 Displayed only when <AUX IN> is set to <AUX ON>.
 *6 Displayed only when <L/O MODE> is set to <SUB.W>.
 *7 The volume level automatically changes to "VOLUME 30" if you change to <LOW POWER> with the volume level is set higher than "VOLUME 30."
 *8 Displayed only when any source other than "AM" is selected.
 *9 Displayed only when any source other than "AUX IN" is selected.

Installation

This unit is designed to operate on **12 V DC, NEGATIVE ground electrical systems**. If your vehicle does not have this system, a voltage inverter is required, which can be purchased at JVC car audio dealers.

Prepare these before installation....

Warnings

- To prevent short circuits:
 - Disconnect the battery's negative terminal and make all electrical connections before installing the unit.
 - Cover the terminals of the UNUSED leads with insulating tape.
- Be sure to ground this unit to the car's chassis again after installation.
- Replace the fuse with one of the specified rating.
- Connect speakers with a maximum power of more than 50 W (impedance of 4 Ω to 8 Ω). Otherwise, change the <AMP GAIN> setting. (See above.)
- The heat sink becomes very hot after use. Be careful not to touch it when removing this unit.

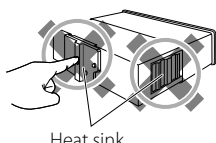
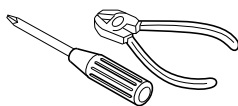

Parts List

- | | |
|-------------------------|----------------------|
| (A) Hard case.....1 | (D) Trim plate.....1 |
| (B) Control panel.....1 | (E) Power cord.....1 |
| (C) Sleeve.....1 | (F) Handles.....2 |

The following illustration shows a typical installation. If you have any questions or require information regarding installation kits, consult your JVC car audio dealer or a company supplying kits.

In-dash mounting

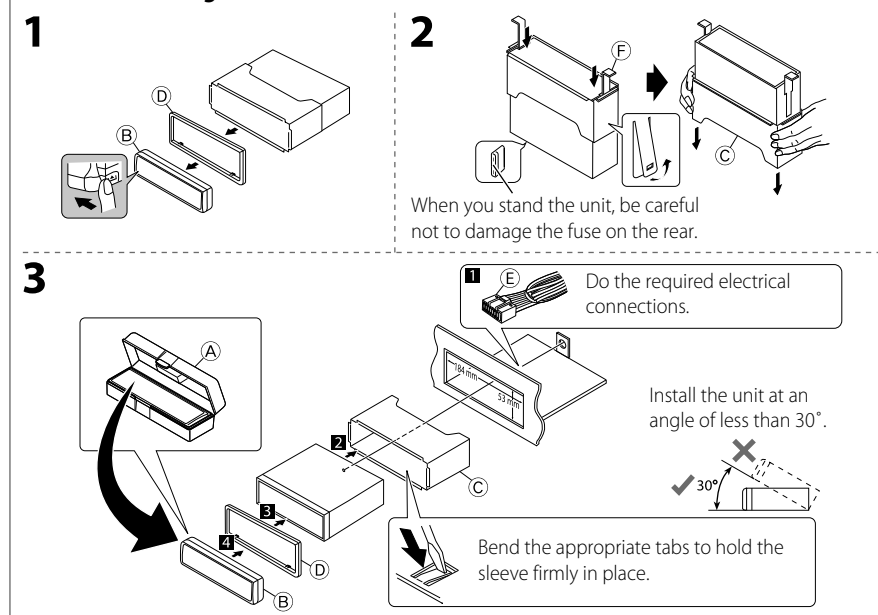

When installing the unit without using the sleeve

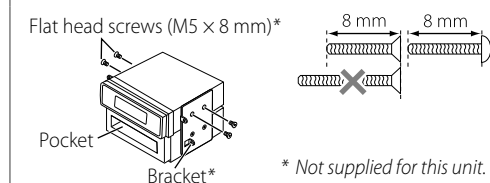

Removing the unit

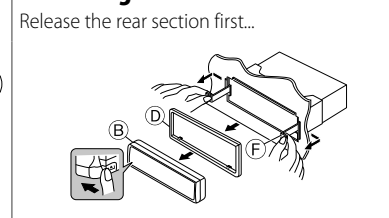

Electrical connections

IMPORTANT: A custom wiring harness (separately purchased) which is suitable for your car is recommended for connection between the unit and your car. Consult your JVC car audio dealer or a company supplying kits for details.

PRECAUTIONS on power supply and speaker connections

- DO NOT connect the speaker leads of the power cord to the car battery; otherwise, the unit will be seriously damaged.
- BEFORE connecting the speaker leads of the power cord to the speakers, check the speaker wiring in your car.

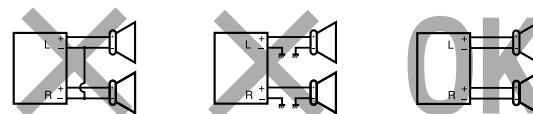

Connecting the external amplifier or subwoofer

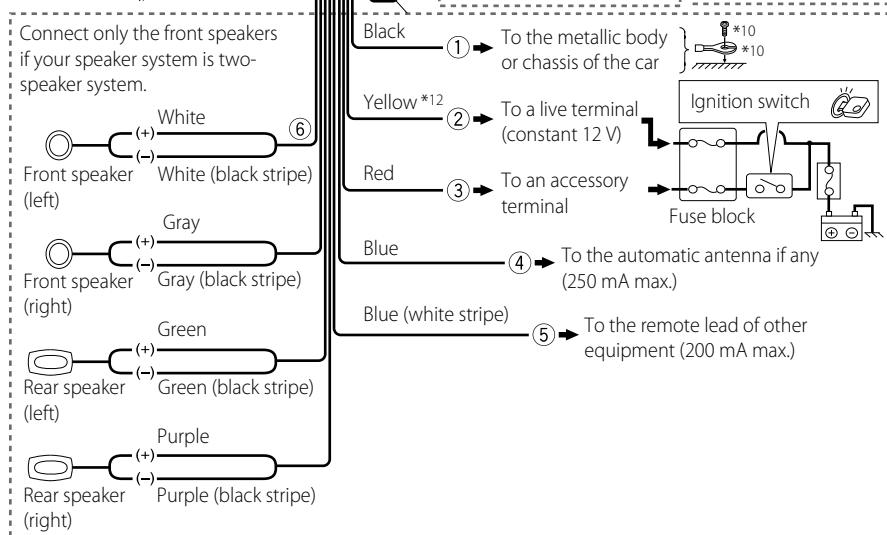
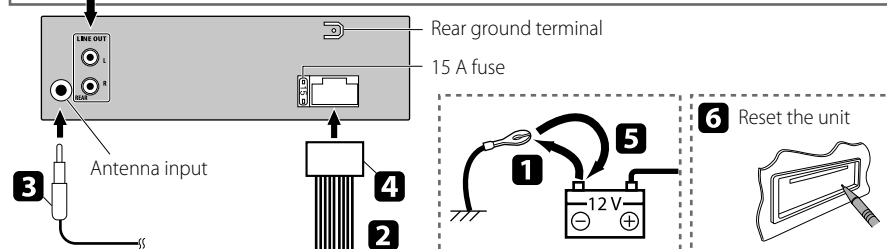
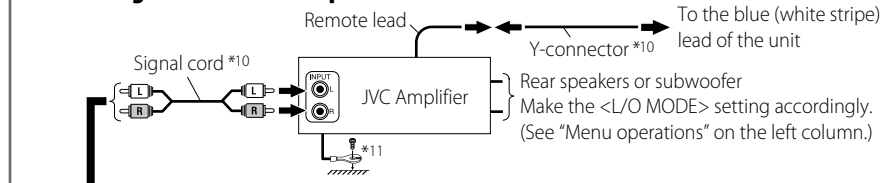

*10 Not supplied for this unit.
 *11 Firmly attach the ground wire to the metallic body or to the chassis of the car—to the place uncoated with paint.
 *12 Before checking the operation of this unit prior to installation, this lead must be connected, otherwise the power cannot be turned on.

Troubleshooting

	Symptom	Remedy/Cause
General	Sound cannot be heard from the speakers.	<ul style="list-style-type: none"> Adjust the volume to the optimum level. Make sure the unit is not muted/paused. (See page 1.) Check the cords and connections.
	"PROTECT" appears on the display and no operations can be done.	Check to be sure the terminals of the speaker leads are covered with insulating tape properly, then reset the unit. (See page 1.) If "PROTECT" does not disappear, consult your JVC car audio dealer or a company supplying kits.
	This unit does not work at all.	Reset the unit. (See page 1.)
FM/AM	"AUX IN" cannot be selected.	Check the <SRC SELECT> → <AUX IN> setting. (See "Menu operations" on page 3.)
	SSM automatic presetting does not work.	Store stations manually.
Disc playback	Static noise while listening to the radio.	Connect the antenna firmly.
	"AM" cannot be selected.	Check the <SRC SELECT> → <AM> setting. (See "Menu operations" on page 3.)
	Disc cannot be played back.	Insert the disc correctly.
	<ul style="list-style-type: none"> CD-R/CD-RW cannot be played back. Tracks on the CD-R/CD-RW cannot be skipped. 	<ul style="list-style-type: none"> Insert a finalized CD-R/CD-RW. Finalize the CD-R/CD-RW with the component which you used for recording.
	Disc can be neither played back nor ejected.	<ul style="list-style-type: none"> Unlock the disc. (See page 2.) Eject the disc forcibly. (See page 1.)
	Disc sound is sometimes interrupted.	<ul style="list-style-type: none"> Stop playback while driving on rough roads. Change the disc. Check the cords and connections.
MP3/WMA playback	"NO DISC" appears on the display.	Insert a playable disc into the loading slot.
	"PLEASE" and "EJECT" appear alternately on the display.	Press ▲, then insert a disc correctly.
	Disc cannot be played back.	<ul style="list-style-type: none"> Use a disc with MP3/WMA tracks recorded in a format compliant with ISO 9660 Level 1, Level 2, Romeo, or Joliet. Add the extension code <.mp3> or <.wma> to the file names.
	Noise is generated.	Skip to another track or change the disc. (Do not add the extension code <.mp3> or <.wma> to non-MP3 or WMA tracks.)
	A longer readout time is required ("READING" keeps flashing on the display).	Do not use too many hierarchical levels and folders.
	Tracks are not played back in the order you have intended.	Playback order is determined when the files are recorded.
	The elapsed playing time is not correct.	This sometimes occurs during playback. This is caused by how the tracks are recorded on the disc.
	For KD-R414: "NO FILE" appears on the display.	Selected folder is an empty folder*. Select another folder that contains MP3/WMA tracks. *Folder that is physically empty or folder that contains data but does not contain valid MP3/WMA track.
	"NOT SUPPORT" appears on the display and track skips.	Skip to the next track encoded in an appropriate format or to the next non-copy-protected WMA track.
	The correct characters are not displayed (e.g. album name).	This unit can only display letters (upper case), numbers, and a limited number of symbols. (See page 2.)
USB device playback (for KD-R414)	Noise is generated.	The track played back is not an MP3/WMA track. Skip to another file. (Do not add the extension code <.mp3> or <.wma> to non-MP3 or WMA tracks.)
	"READING" keeps flashing on the display.	<ul style="list-style-type: none"> Readout time varies depending on the USB device. Do not use too many hierarchy or folders. Turn off the power then on again. Reattach the USB device again.
	"NO FILE" appears on the display.	Selected folder is an empty folder*. Select another folder that contains MP3/WMA tracks. *Folder that is physically empty or folder that contains data but does not contain valid MP3/WMA track.
	"NOT SUPPORT" appears on the display and track skips.	Skip to the next track encoded in an appropriate format or to the next non-copy-protected WMA track.
	Tracks/folders are not played back in the order you have intended.	The playback order is determined by the write-in time stamp. The first track/folder written into the USB device will be the first track/folder for playback.
	<ul style="list-style-type: none"> "CANNOT PLAY" flashes on the display. "NO USB" appears on the display. The unit cannot detect the USB device. 	<ul style="list-style-type: none"> Attach a USB device that contains tracks encoded in an appropriate format. Reattach the USB device again.
	While playing a track, sound is sometimes interrupted.	The MP3/WMA tracks have not been properly copied into the USB device. Copy MP3/WMA tracks again into the USB device, and try again.
	The correct characters are not displayed (e.g. album name).	This unit can only display letters (upper case), numbers, and a limited number of symbols. (See page 2.)
	The fuse blows.	Connect the red and black leads correctly.
	Power cannot be turned on.	Check to make sure the yellow lead is connected.
Installation/connection	No sound from the speakers.	Check to make sure the speaker output lead is not shortcircuited.
	Sound is distorted.	<ul style="list-style-type: none"> Check to make sure the speaker output lead is grounded. Check to make sure the "-" terminals of L and R speakers are grounded in common.
	Noise interfere with sounds.	Check to make sure the rear ground terminal connected to the car's chassis is using shorter and thicker cords.
	This unit becomes hot.	<ul style="list-style-type: none"> Check to make sure the speaker output lead is grounded. Check to make sure the "-" terminals of L and R speakers are grounded in common.
	This unit does not work at all.	Reset the unit. (See page 1.)

JVC bears no responsibility for any loss of the data in the USB mass storage class device while using this System.

Having TROUBLE with operation?
Please reset your unit
Refer to page of How to reset your unit

More about this unit

General

- If you turn off the power while listening to a track, playback will start from where it had been stopped previously next time you turn on the power.
- If no operation is done for about 60 seconds after pressing **MENU** button, the operation will be canceled.

Tuner operations

- During SSM search...
 - All previously stored stations are erased and the stations are stored anew.
 - When SSM is over, the station stored in the lowest preset number will be automatically tuned in.
- When storing a station manually, the previously preset station is erased when a new station is stored in the same preset number.

Disc/USB operations

Caution for DualDisc playback

- The Non-DVD side of a "DualDisc" does not comply with the "Compact Disc Digital Audio" standard. Therefore, the use of Non-DVD side of a DualDisc on this product may not be recommended.

General

- This unit has been designed to reproduce CDs/CD Texts, and CD-Rs (Recordable)/CD-RWs (Rewritable) in audio CD (CD-DA), MP3 and WMA formats.
- If you change the source while listening to a disc, playback stops. Next time you select "CD" as the playback source, playback will start from where it had been stopped previously.
- If the ejected disc is not removed within 15 seconds, it is automatically inserted into the loading slot again to protect it from dust. Playback starts automatically.

Playing a CD-R or CD-RW

- Use only "finalized" CD-Rs or CD-RWs.
- This unit can play back multi-session discs; however, unclosed sessions will be skipped while playing.
- Some CD-Rs or CD-RWs may not be played back on this unit:
 - Discs are dirty or scratched.
 - Moisture condensation has occurred on the lens inside the unit.
 - The pickup lens inside the unit is dirty.
 - The files on the CD-R/CD-RW are written using the "Packet Write" method.
 - There are improper recording conditions (missing data, etc.) or media conditions (stained, scratched, warped, etc.).
- CD-RWs may require a longer readout time since the reflectance of CD-RWs is lower than that of regular CDs.

Playing an MP3/WMA disc

- This unit can play back MP3/WMA files with the extension code <.mp3> or <.wma> (regardless of the letter case—upper/lower).
- This unit can show the names of albums, artists (performer), and tag (Version 1.0, 1.1, 2.2, 2.3, or 2.4) for MP3 files and for WMA files.
- This unit can display only one-byte characters. No other characters can be correctly displayed.
- This unit can play back MP3/WMA files meeting the conditions below:
 - Bit rate: MP3: 32 kbps — 320 kbps
WMA: 32 kbps — 192 kbps
 - Sampling frequency of MP3: 32 kHz, 44.1 kHz, 48 kHz (for MPEG-1) 16 kHz, 22.05 kHz, 24 kHz (for MPEG-2)
 - Sampling frequency of WMA: 22.05 kHz, 32 kHz, 44.1 kHz, 48 kHz

Specifications

AUDIO AMPLIFIER SECTION

Maximum Power Output:
 Front/Rear: 50 W per channel
 Continuous Power Output (RMS):
 Front/Rear: 19 W per channel into 4 Ω, 40 Hz to 20 000 Hz at no more than 0.8% total harmonic distortion.
 Load Impedance: 4 Ω (4 Ω to 8 Ω allowance)
 Tone Control Range:
 Bass: ±12 dB (60 Hz, 80 Hz, 100 Hz, 200 Hz); Q1.0, Q1.25, Q1.5, Q2.0
 Middle: ±12 dB (0.5 kHz, 1.0 kHz, 1.5 kHz, 2.5 kHz); Q0.75, Q1.0, Q1.25
 Treble: ±12 dB (10.0 kHz, 12.5 kHz, 15.0 kHz, 17.5 kHz); Q (Fixed)
 Frequency Response: 40 Hz to 20 000 Hz
 Signal-to-Noise Ratio: 70 dB
 Line/subwoofer-Out Level/Impedance:
 KD-R414: 5.0 V/20 kΩ load (full scale)
 KD-R314: 2.5 V/20 kΩ load (full scale)
 Output Impedance: 1 kΩ
 Other Terminal: AUX (auxiliary) input jack, USB input jack (for KD-R414), Antenna input

TUNER SECTION

Frequency Range:
 FM: 87.5 MHz to 108.0 MHz
 AM: 531 kHz to 1602 kHz

[FM Tuner]

Usable Sensitivity: 9.3 dBf (0.8 μV/75 Ω)
 50 dB Quieting Sensitivity: 16.3 dBf (1.8 μV/75 Ω)
 Alternate Channel Selectivity (400 kHz): 65 dB
 Frequency Response: 40 Hz to 15 000 Hz
 Stereo Separation: 40 dB

- Disc format: ISO 9660 Level 1/ Level 2, Romeo, Joliet, Windows extension
- The maximum number of characters for file/folder names (includes 4 extension characters—<.mp3> or <.wma>): 12 — 128 characters (depending on the media used, etc.).
- This unit can recognize a total of 512 files, 255 folders, and 8 hierarchical levels.
- This unit can play back files recorded in VBR (variable bit rate).
Files recorded in VBR have a discrepancy in the elapsed time display, and do not show the actual elapsed time. In particular, this difference becomes noticeable after performing the search function.
- This unit cannot play back the following files:
 - MP3 files: encoded in MP3i and MP3 PRO format; an inappropriate format; layer 1/2.
 - WMA files: encoded in lossless, professional, and voice format; not based upon Windows Media® Audio; copy-protected with DRM.
- Files which have data such as AIFF, ATRAC3, etc.
- The search function works but search speed is not constant.

Playing MP3/WMA tracks from a USB device (for KD-R414)

- While playing from a USB device, the playback order may differ from other players.
- This unit may be unable to play back some USB devices or some files due to their characteristics or recording conditions.
- Depending on the shape of the USB devices and connection ports, some USB devices may not be attached properly or the connection might be loose.
- Connect one USB mass storage class device to the unit at a time. Do not use a USB hub.
- If the connected USB device does not have the correct files, "CANNOT PLAY" appears.
- This unit can show Tag (Version 1.0, 1.1, 2.2, 2.3, or 2.4) for MP3 files and for WMA files.
- This unit can play back MP3/WMA files meeting the conditions below:
 - Bit rate of MP3/WMA: 32 kbps — 320 kbps
 - Sampling frequency of MP3: 32 kHz, 44.1 kHz, 48 kHz (for MPEG-1) 16 kHz, 22.05 kHz, 24 kHz (for MPEG-2)
 - Sampling frequency of WMA: 22.05 kHz, 32 kHz, 44.1 kHz, 48 kHz
- This unit can play back MP3 files recorded in VBR (variable bit rate).
- The maximum number of characters for:
 - Folder names: 32 characters; File names: 32 characters; MP3 Tag: 64 characters; WMA Tag: 32 characters
- This unit can recognize a total of 5 000 files, 255 folders (255 files per folder including folder without unsupported files), and of 8 hierarchies.
- This unit does not support SD card reader.
- This unit cannot recognize a USB device whose rating is other than 5 V and exceeds 500 mA.
- USB devices equipped with special functions such as data security functions cannot be used with the unit.
- Do not use a USB device with 2 or more partitions.
- This unit may not recognized a USB device connected through a USB card reader.
- This unit may not play back files in a USB device properly when using a USB extension cord.
- This unit cannot play back the following files:
 - MP3 files: encoded in MP3i and MP3 PRO format; an inappropriate format; layer 1/2.
 - WMA files: encoded in lossless, professional, and voice format; not based upon Windows Media® Audio.

[AM Tuner]

Sensitivity/Selectivity: 20 μV/40 dB

CD PLAYER SECTION

Type: Compact disc player
 Signal Detection System: Non-contact optical pickup (semiconductor laser)
 Number of channels: 2 channels (stereo)
 Frequency Response: 5 Hz to 20 000 Hz
 Dynamic Range: 93 dB
 Signal-to-Noise Ratio: 98 dB
 Wow and Flutter: Less than measurable limit
 MP3 Decoding Format: (MPEG1/2 Audio Layer 3)
 Max. Bit Rate: 320 kbps
 WMA (Windows Media® Audio) Decoding Format:
 Max. Bit Rate: 192 kbps

USB SECTION (for KD-R414)

USB Standard: USB 1.1, USB 2.0
 Data Transfer Rate (Full Speed): Max. 12 Mb/s
 Compatible Device: Mass storage class
 Compatible File System: FAT 32/16/12
 Playable Audio Format: MP3/WMA
 Max. Current: DC 5 V ≐ 500 mA

GENERAL

Power Requirement: Operating Voltage: DC 14.4 V (11 V to 16 V allowance)
 Grounding System: Negative ground
 Allowable Operating Temperature: 0°C to +40°C
 Dimensions (W × H × D) (approx.):
 Installation Size: 182 mm × 52 mm × 160 mm
 Panel Size: 188 mm × 58 mm × 6 mm
 Mass (approx.): 1.3 kg (excluding accessories)

Design and specifications are subject to change without notice.

JVC

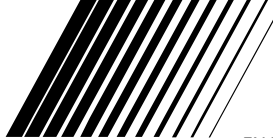

ENGLISH

ไทย

KD-R416 / KD-R415 / KD-R316 / KD-R315

CD RECEIVER / เครื่องเล่น CD

KD-R416/KD-R415

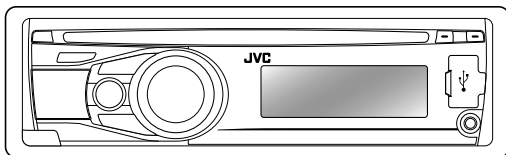
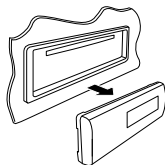

KD-R316/KD-R315

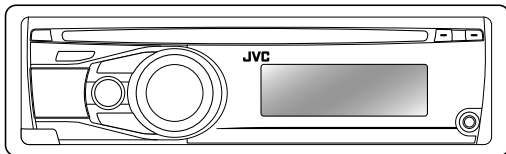

MP3
WMA

For canceling the display demonstration, see page 4. / ดูที่หน้า 4 เพื่อยกเลิกการสาธิตภาพประกอบ

For installation and connections, refer to the separate manual.

กรุณาดูคู่มือที่แยกต่างหาก ในการติดตั้งและการเชื่อมต่อ

INSTRUCTIONS คำแนะนำ

GET0623-001A
[U/UH]

Thank you for purchasing a JVC product.

Please read all instructions carefully before operation, to ensure your complete understanding and to obtain the best possible performance from the unit.

IMPORTANT FOR LASER PRODUCTS

1. CLASS 1 LASER PRODUCT

2. **CAUTION:** Do not open the top cover. There are no user serviceable parts inside the unit; leave all servicing to qualified service personnel.

3. **CAUTION:** Visible and/or invisible class 1M laser radiation when open. Do not view directly with optical instruments.

4. REPRODUCTION OF LABEL: CAUTION LABEL, PLACED OUTSIDE THE UNIT.

CAUTION VISIBLE AND/OR INVISIBLE CLASS 1M LASER RADIATION WHEN OPEN. DO NOT VIEW DIRECTLY WITH OPTICAL INSTRUMENTS. IEC00025-1:2001 (ENG)	ATTENTION RAYONNEMENT LASER VISIBLE ET/OU INVISIBLE DE CLASSE 1M LORS QU'EST OUVERT. NE PAS REGARDER DIRECTEMENT AVEC DES INSTRUMENTS OPTIQUES. (FR)	AVISO RADIACION LASER DE CLASE 1M VISIBLE Y/O INVISIBLE CUANDO ESTA ABIERTO. NO MIRAR DIRECTAMENTE CON INSTRUMENTAL OPTICO. (ESP)	VARNING SYNLIG OCH/ELLER OSYNLIG LASERSTRÅLNING KLASS 1M, NÄR DENNA DEL ÄR ÖPPNAD. BETRÄKTA EJ STRÅLEN MED OPTISKA INSTRUMENT. (SWE)	注意 ここを開くと可視 及び/または不可視 のクラス1M レーザー放射が 出ます。 光学装置で直接 見ないでください。 (JPN)	CAUTION VISIBLE AND/OR INVISIBLE CLASS II LASER RADIATION WHEN OPEN. DO NOT STARE INTO BEAM. FDA 21 CFR (ENG)
--	---	--	---	--	--



[European Union only]

Warning:

If you need to operate the unit while driving, be sure to look around carefully or you may be involved in a traffic accident.

For safety...

- Do not raise the volume level too much, as this will block outside sounds, making driving dangerous.
- Stop the car before performing any complicated operations.

Temperature inside the car...

If you have parked the car for a long time in hot or cold weather, wait until the temperature in the car becomes normal before operating the unit.

How to read this manual

The following icons/symbols are used to indicate:



[Hold]

Press and hold the button(s) until the desired operation begins.



Turn the control dial.

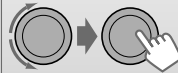

Turn the control dial to make a selection, then press to confirm.



Reference page number



Menu setting item



Continued on the next page

How to attach/detach the control panel

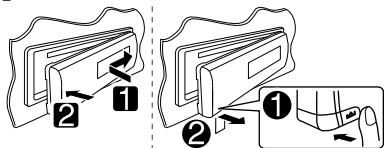

How to reset your unit

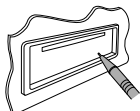

Your preset adjustments will also be erased.

How to forcibly eject a disc



- You can forcibly eject the loaded disc even if the disc is locked. To lock/unlock the disc, see 8.
- Be careful not to drop the disc when it ejects.
- If this does not work, reset your unit.

CONTENTS

- 2 How to read this manual
- 3 How to attach/detach the control panel
- 3 How to reset your unit
- 3 How to forcibly eject a disc
- 4 Canceling the display demonstration
- 4 Setting the clock
- 5 Preparing the remote controller (RM-RK50)
- 6 Basic operations
- 7 Listening to the radio
- 8 Listening to a disc
- 10 Listening to a USB device (For KD-R416/KD-R415)
- 11 Listening to the other external components
- 12 Selecting a preset sound mode
- 13 Menu operations
- 15 Title assignment
- 16 Maintenance
- 17 More about this unit
- 19 Troubleshooting
- 22 Specifications

Canceling the display demonstration

1 Turn on the power.



4 Select <DEMO OFF>.



6 Finish the procedure.



Setting the clock

1 Turn on the power.



3 Select <CLOCK>.



4 Select <CLOCK SET>.



5 Adjust the hour.



6 Adjust the minute.



7 Finish the procedure.



Preparing the remote controller (RM-RK50)

When you use the remote controller for the first time, pull out the insulation sheet.

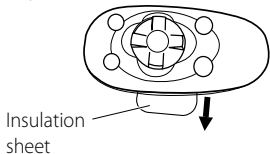

If the effectiveness of the remote controller decreases, replace the battery.

Replacing the lithium coin battery

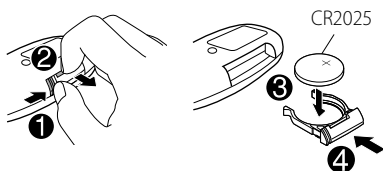

Caution:

- Danger of explosion if battery is incorrectly replaced. Replace only with the same or equivalent type.
- Battery shall not be exposed to excessive heat such as sunshine, fire, or the like.

Warning (to prevent accidents and damage):

- Do not install any battery other than CR2025 or its equivalent.
- Do not leave the remote controller in a place (such as dashboards) exposed to direct sunlight for a long time.
- Store the battery in a place where children cannot reach.
- Do not recharge, short, disassemble, heat the battery, or dispose of it in a fire.
- Do not leave the battery with other metallic materials.
- Do not poke the battery with tweezers or similar tools.
- Wrap the battery with tape and insulate when throwing away or saving it.

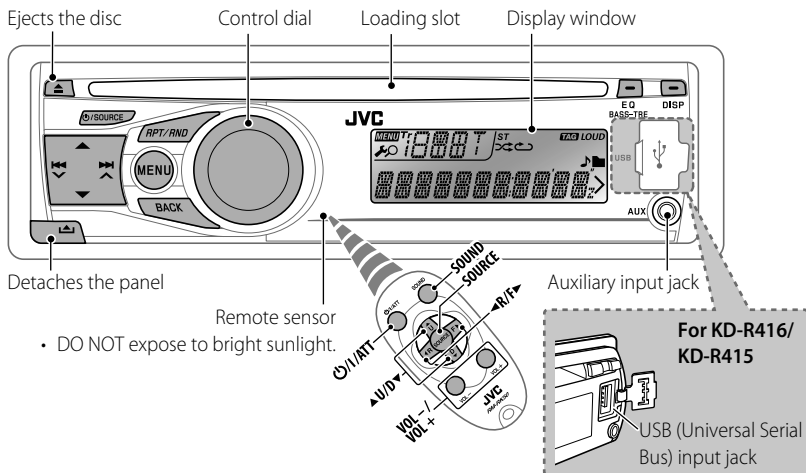

Basic operations



- DO NOT expose to bright sunlight.

When you press or hold the following button(s)...

Main unit	Remote controller	General operation
		Turns on. • When the power is on, pressing on the remote controller also mutes the sound or pauses. Press again to cancel muting or resume playback. Turns off if pressed and held.
		Selects the available sources (if the power is turned on). • If the source is ready, playback also starts.
		Adjusts the volume level. — Selects items.
	—	• Mutes the sound while listening to a source. If the source is "CD" or "USB," playback pauses. Press the control dial again to cancel muting or resume playback. • Confirms selection.
		Selects the sound mode. • Enters tone level adjustment directly (12) if pressed and held EQ BASS-TRE on the main unit.
	—	Enters playback mode menu directly (9).

Main unit	General operation
	Returns to the previous menu.
	Power off : Checks the current clock time. Power on : Changes the display information.

Listening to the radio

-  → "FM" or "AM"
-  "ST" lights up when receiving an FM stereo broadcast with sufficient signal strength.

Manual search



"M" flashes, then press the button repeatedly.
[Hold]

When an FM stereo broadcast is hard to receive

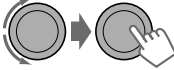
-  [Hold]
- 

⇒ <TUNER> ⇒ <MONO> ⇒
<MONO ON>
Reception improves, but stereo effect will be lost.

To restore the stereo effect, repeat the same procedure to select <MONO OFF>.

Changing the display information



Station name* → **Frequency** →
Clock → (back to the beginning)

* If no title is assigned to a station, "NO NAME" appears for a few seconds. To assign a title to a station,  15.

Automatic presetting (FM)—

SSM (Strong-station Sequential Memory)

You can preset up to 18 stations for FM.

While listening to a station...

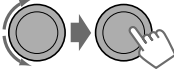
-  [Hold]
- 

⇒ <TUNER> ⇒ <SSM> ⇒
<SSM 01 – 06> / <SSM 07 – 12> /
<SSM 13 – 18>
"SSM" flashes and local stations with the strongest signals are searched and stored automatically.

To preset another 6 stations, repeat the above procedure by selecting one of the other 6 SSM setting ranges.

Manual presetting (FM/AM)

You can preset up to 18 stations for FM and 6 stations for AM.

Ex.: Storing FM station of 92.50 MHz into preset number "04."



⇒ "92.50MHz"



"PRESET MODE" flashes.

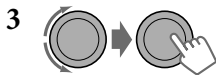

⇒ Selects preset number "04."

"P04" flashes and "MEMORY" appears.

Selecting a preset station

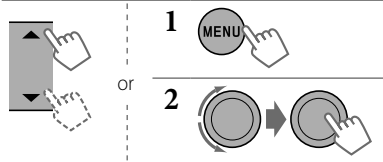

Using the remote controller



▲ U/D ▼ : Changes the preset stations

◀ R/F ▶ : Searches for stations

Listening to a disc



⇒ Turn on the power.



All tracks will be played repeatedly until you change the source or eject the disc.

Stopping playback and ejecting the disc



"NO DISC" appears.

Press **⏻**/SOURCE to listen to another playback source.

Caution on volume setting:

Discs produce very little noise compared with other sources. Lower the volume before playing a disc to avoid damaging the speakers by the sudden increase of the output level.

Prohibiting disc ejection



To cancel the prohibition, repeat the same procedure.

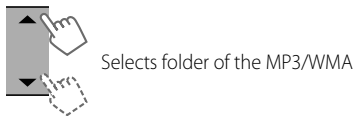

Selecting a track/folder

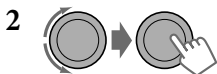

For MP3/WMA discs, select the desired folder, then the desired track by repeating step 2.

- To return to the previous menu, press **BACK**.

Changing the display information



Disc title/Album name/performer (folder name)* → Track title (file name)* → Current track number with the elapsed playing time → Current track number with the clock time → (back to the beginning)

* If the current disc is an audio CD, "NO NAME" appears.

If an MP3/WMA file does not have Tag information or <TAG DISPLAY> is set to <TAG OFF> (🗨️ 13), folder name and file name appear.

Selecting the playback modes

You can use only one of the following playback modes at a time.

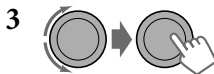
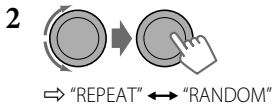

REPEAT

TRACK RPT : Repeats current track
FOLDER RPT : Repeats current folder

RANDOM

FOLDER RND : Randomly plays all tracks of current folder, then tracks of next folders
ALL RND : Randomly plays all tracks

To cancel repeat play or random play, select "RPT OFF" or "RND OFF."

Using the remote controller



▲ U/D ▼ : Selects folder of the MP3/WMA

◀ R/F ▶ : Selects track

◀ R/F ▶ : Fast-forwards or [Hold] reverses the track

Listening to a USB device (For KD-R416/KD-R415)

This unit can play MP3/WMA tracks stored in a USB device.

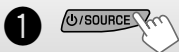

⇒ Turn on the power.

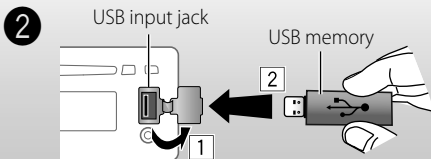

All tracks will be played repeatedly until you change the source or detach the USB device.

If a USB device has been attached...

Pressing **SOURCE** turns on the power and playback starts from where it has been stopped previously.

- If a different USB device is currently attached, playback starts from the beginning.

Stopping playback and detaching the USB device

Straightly pull it out from the unit. "NO USB" appears. Press **SOURCE** to listen to another playback source.

You can operate the USB device in the same way you operate the files on a disc. (🔍 8, 9)

Caution on volume setting:

USB devices produce very little noise compared with other sources. Lower the volume before playing a USB device to avoid damaging the speakers by sudden increase of the output level.

Cautions:

- Avoid using the USB device if it might hinder your safety driving.
- Do not pull out and attach the USB device repeatedly while "READING" is shown on the display.
- Do not start the car engine if a USB device is connected.
- This unit may not be able to play the files depending on the type of USB device.
- Operation and power supply may not work as intended for some USB devices.
- You cannot connect a computer to the USB input terminal of the unit.
- Make sure all important data has been backed up to avoid losing the data.
- Do not leave a USB device in the car, expose to direct sunlight, or high temperature to avoid deformation or cause damages to the device.
- Some USB devices may not work immediately after attaching USB device or turn on the power.
- For more details about USB operations, see pages 18 and 19.



Listening to the other external components

You can connect an external component to the AUX (auxiliary) input jack on the control panel.

Preparation: Make sure <AUX ON> is selected for the <SRC SELECT> → <AUX IN> setting.

(🔍 15)

- For details, refer also to the instructions supplied with the adapter or external components.

- 1 
⇒ "AUX IN"
- 2 Turn on the connected component and start playing the source.
- 3 
⇒ Adjust the volume.
- 4 **Adjust the sound as you want.** (🔍 12)

Connecting an external component to the AUX input jack

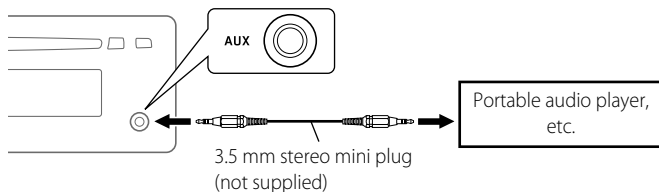

Selecting a preset sound mode

You can select a preset sound mode suitable for the music genre.



**FLAT → NATURAL → DYNAMIC →
VOCAL BOOST → BASS BOOST → USER →**
(back to the beginning)

While listening, you can adjust the tone level of the selected sound mode.

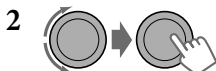

Adjust the level (-06 to +06) of the selected tone (BASS / MIDDLE / TREBLE). The sound mode is automatically stored and changed to "USER."

Tone	Sound element		
	Frequency	Level	Q
BASS	60 Hz	-06 to +06	Q1.0
	80 Hz		Q1.25
	100 Hz		Q1.5
	200 Hz		Q2.0
MIDDLE	0.5 kHz	-06 to +06	Q0.75
	1.0 kHz		Q1.0
	1.5 kHz		Q1.25
	2.5 kHz		
TREBLE	10.0 kHz	-06 to +06	Q FIX
	12.5 kHz		
	15.0 kHz		
	17.5 kHz		

Storing your own sound mode

You can store your own adjustments in memory.

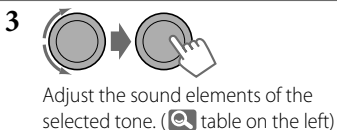
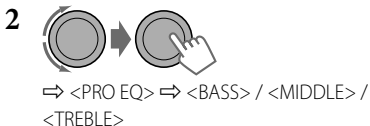

4 Repeat steps **2** and **3** to adjust other tones.
The adjustments made will be stored automatically in "USER."

The current sound mode changes to "USER" automatically.

Menu operations

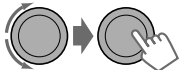
- 1  [Hold]
- 2 
- 3 Repeat step 2 if necessary.
 - To return to the previous menu, press **BACK**.
 - To exit from the menu, press **DISP** or **MENU**.

Category	Menu item	Selectable setting, [Initial: <u>Underlined</u>]
DEMO	DEMO Display demonstration	<ul style="list-style-type: none"> • <u>DEMO ON</u> : Display demonstration will be activated automatically if no operation is done for about 20 seconds. (🔍 4) • <u>DEMO OFF</u> : Cancels.
	CLOCK SET Clock setting	[<u>1:00</u>] : Adjust the hour, then the minute. (🔍 4)
PROEQ	BASS	— : For settings, 🔍 12.
	MIDDLE	
	TREBLE	
DISPLAY	DIMMER	<ul style="list-style-type: none"> • <u>DIMMER ON</u> : Dims the display and button illumination. • <u>DIMMER OFF</u> : Cancels.
	SCROLL *1	<ul style="list-style-type: none"> • <u>SCROLL ONCE</u> : Scrolls the displayed information once. • <u>SCROLL AUTO</u> : Repeats scrolling (at 5-second intervals). • <u>SCROLL OFF</u> : Cancels. Pressing DISP for more than one second can scroll the display regardless of the setting.
	TAG DISPLAY	<ul style="list-style-type: none"> • <u>TAG ON</u> : Shows the Tag information while playing MP3/WMA tracks. • <u>TAG OFF</u> : Cancels.
TUNER	SSM *2 Strong-station Sequential Memory	<ul style="list-style-type: none"> • <u>SSM 01 – 06</u> • <u>SSM 07 – 12</u> • <u>SSM 13 – 18</u> : For settings, 🔍 7.
	MONO *2 Monaural mode	<ul style="list-style-type: none"> • <u>MONO ON</u> : Activate monaural mode to improve FM reception, but stereo effect will be lost. • <u>MONO OFF</u> : Restore the stereo effect. (🔍 7)
	IF BAND Intermediate frequency band	<ul style="list-style-type: none"> • <u>AUTO</u> : Increases the tuner selectivity to reduce interference noises between adjacent stations. (Stereo effect may be lost.) • <u>WIDE</u> : Subject to interference noises from adjacent stations, but sound quality will not be degraded and the stereo effect will remain.

*1 Some characters or symbols will not be shown correctly (or will be blanked) on the display.

*2 Displayed only when the source is "FM."



Category	Menu item	Selectable setting, [Initial: <u>Underlined</u>]
AUDIO	FADER *3	R06 – F06 [00] : Adjust the front and rear speaker output balance.
	BALANCE *4	L06 – R06 [00] : Adjust the left and right speaker output balance.
	LOUD Loudness	<ul style="list-style-type: none"> • LOUD ON : Boost low and high frequencies to produce a well-balanced sound at a low volume level. • LOUD OFF : Cancels.
	AUX ADJUST *5 Auxiliary adjust (For KD-R316/ KD-R315)	AUX ADJ 00 — AUX ADJ 05 : Adjust the auxiliary input level to avoid the sudden increase of the output level when changing the source to external component connected to the AUX input jack on the control panel.
	VOL ADJUST Volume adjust (For KD-R416/ KD-R415)	VOL ADJ -05 — VOL ADJ +05 [VOL ADJ 00] : Preset the volume adjustment level of each source (except FM), compared to the FM volume level. The volume level will automatically increase or decrease when you change the source. <ul style="list-style-type: none"> • Before making an adjustment, select the source you want to adjust. • "VOL ADJ FIX" appears on the display if "FM" is selected as the source.
	L/O MODE Line output mode	<ul style="list-style-type: none"> • SUB.W : Select if the REAR LINE OUT terminals are used for connecting a subwoofer (through an external amplifier). • REAR : Select if the REAR LINE OUT terminals are used for connecting the speakers (through an external amplifier).
	SUB.W FREQ *6 Subwoofer cutoff frequency	<ul style="list-style-type: none"> • LOW : Frequencies lower than 72 Hz are sent to the subwoofer. • MID : Frequencies lower than 111 Hz are sent to the subwoofer. • HIGH : Frequencies lower than 157 Hz are sent to the subwoofer.
	SUB.W LEVEL *6 Subwoofer level	SUB.W 00 — SUB.W 08 [SUB.W 04] : Adjust the subwoofer output level.

*3 If you are using a two-speaker system, set the fader level to "00."

*4 This adjustment will not affect the subwoofer output.

*5 Displayed only when <AUX IN> is set to <AUX ON>.

*6 Displayed only when <L/O MODE> is set to <SUB.W>.

Category	Menu item	Selectable setting, [Initial: <u>Underlined</u>]
AUDIO	BEEP	<ul style="list-style-type: none"> • BEEP ON : Activates the keypress tone. • BEEP OFF : Deactivates the keypress tone.
	AMP GAIN *7 Amplifier gain control	<ul style="list-style-type: none"> • LOW POWER : VOLUME 00 – VOLUME 30 (Select if the maximum power of each speaker is less than 50 W to prevent damaging the speakers.) • HIGH POWER : VOLUME 00 – VOLUME 50
SRC SELECT	AM *8 AM station	<ul style="list-style-type: none"> • AM ON : Enable "AM" in source selection. • AM OFF : Disable "AM" in source selection.
	AUX IN *9 Auxiliary input	<ul style="list-style-type: none"> • AUX ON : Enable "AUX IN" in source selection. • AUX OFF : Disable "AUX IN" in source selection.

*7 The volume level automatically changes to "VOLUME 30" if you change to <LOW POWER> with the volume level is set higher than "VOLUME 30."

*8 Displayed only when any source other than "AM" is selected.

*9 Displayed only when any source other than "AUX IN" is selected.

Title assignment

You can assign titles to 30 station frequencies (FM and AM) using 8 characters (maximum) for each title.

- If you try to assign titles to more than 30 station frequencies, "NAME FULL" appears. Delete unwanted titles before assignment.



⇒ "FM" or "AM"



⇒ Show the title entry screen.



⇒ Select a character.



⇒ Move to the next (or previous) character position.

5 Repeat steps **3** and **4** until you have finished entering the title.



To erase the entire title

In step **2** on the left column...



Available characters

A	B	C	D	E	F	G	H	I	
J	K	L	M	N	O	P	Q	R	
S	T	U	V	W	X	Y	Z	0	
1	2	3	4	5	6	7	8	9	
—	/	<	>	Space					

Maintenance

How to clean the connectors

Frequent detachment will deteriorate the connectors.

To minimize this possibility, periodically wipe the connectors with a cotton swab or cloth moistened with alcohol, being careful not to damage the connectors.

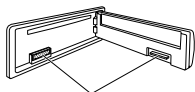

Connectors

Moisture condensation

Moisture may condense on the lens inside the unit in the following cases:

- After starting the heater in the car.
 - If it becomes very humid inside the car.
- Should this occur, the unit may malfunction. In this case, eject the disc and leave the unit turned on for a few hours until the moisture has evaporated.

How to handle discs

When removing a disc from its case, press down the center holder of the case and lift the disc out, holding it by the edges.



- Always hold the disc by the edges. Do not touch its recording surface.

When storing a disc in its case, gently insert the disc around the center holder (with the printed surface facing up).

- Make sure to store discs in cases after use.

To keep discs clean

A dirty disc may not play correctly. If a disc does become dirty, wipe it with a soft cloth in a straight line from center to edge.



- Do not use any solvents (for example, conventional record cleaner, spray, thinner, benzene, etc.) to clean discs.





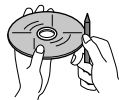

To play new discs

New discs may have some rough spots around the inner and outer edges. If such a disc is used, this unit may reject the disc.



To remove these rough spots, rub the edges with a pencil or ball-point pen, etc.

Do not use the following discs:

Single CD (8 cm disc) 	Warped disc 
Sticker and sticker residue 	Stick-on label 
Unusual shape 	C-thru Disc (semitransparent disc) 
Transparent or semitransparent parts on its recording area 	

More about this unit

Basic operations

General

- If you turn off the power while listening to a track, playback will start from where it had been stopped previously next time you turn on the power.
- If no operation is done for about 60 seconds after pressing **MENU** button, the operation will be canceled.

Tuner operations

Storing stations in memory

- During SSM search...
 - All previously stored stations are erased and the stations are stored anew.
 - When SSM is over, the station stored in the lowest preset number will be automatically tuned in.
- When storing a station manually, the previously preset station is erased when a new station is stored in the same preset number.

Disc operations

Caution for DualDisc playback

- The Non-DVD side of a "DualDisc" does not comply with the "Compact Disc Digital Audio" standard. Therefore, the use of Non-DVD side of a DualDisc on this product may not be recommended.

General

- This unit has been designed to reproduce CDs/CD Texts, and CD-Rs (Recordable)/CD-RWs (Rewritable) in audio CD (CD-DA), MP3 and WMA formats.
- If you change the source while listening to a disc, playback stops. Next time you select "CD" as the playback source, playback will start from where it had been stopped previously.

- When a disc is inserted upside down, "PLEASE" and "EJECT" appear alternately on the display. Press **▲** to eject the disc.
- If the ejected disc is not removed within 15 seconds, it is automatically inserted into the loading slot again to protect it from dust.
- MP3 and WMA "tracks" (words "file" and "track" are used interchangeably) are recorded in "folders."
- While fast-forwarding or reversing on an MP3 or WMA disc, you can only hear intermittent sounds.

Playing a CD-R or CD-RW

- Use only "finalized" CD-Rs or CD-RWs.
- This unit can only play back files of the same type as those detected first if a disc includes both audio CD (CD-DA) files and MP3/WMA files.
- This unit can play back multi-session discs; however, unclosed sessions will be skipped while playing.
- Some CD-Rs or CD-RWs may not play back on this unit because of their disc characteristics, or for the following reasons:
 - Discs are dirty or scratched.
 - Moisture condensation has occurred on the lens inside the unit.
 - The pickup lens inside the unit is dirty.
 - The files on the CD-R/CD-RW are written using the "Packet Write" method.
 - There are improper recording conditions (missing data, etc.) or media conditions (stained, scratched, warped, etc.).
- CD-RWs may require a longer readout time since the reflectance of CD-RWs is lower than that of regular CDs.



- Do not use the following CD-Rs or CD-RWs:
 - Discs with stickers, labels, or a protective seal stuck to the surface.
 - Discs on which labels can be directly printed by an ink jet printer.

Using these discs under high temperature or high humidity may cause malfunctions or damage to the unit.

Playing an MP3/WMA disc

- This unit can play back MP3/WMA files with the extension code <.mp3> or <.wma> (regardless of the letter case—upper/lower).
- This unit can show the names of albums, artists (performer), and Tag (Version 1.0, 1.1, 2.2, 2.3, or 2.4) for MP3 files and for WMA files.
- This unit can display only one-byte characters. No other characters can be correctly displayed.
- This unit can play back MP3/WMA files meeting the conditions below:
 - Bit rate:
 - MP3: 32 kbps — 320 kbps
 - WMA: 32 kbps — 192 kbps
 - Sampling frequency of MP3:
 - 32 kHz, 44.1 kHz, 48kHz (for MPEG-1)
 - 16 kHz, 22.05 kHz, 24 kHz (for MPEG-2)
 - Sampling frequency of WMA:
 - 22.05 kHz, 32 kHz, 44.1 kHz, 48kHz
 - Disc format: ISO 9660 Level 1/Level 2, Romeo, Joliet, Windows extension
- The maximum number of characters for file/folder names (includes 4 extension characters—<.mp3> or <.wma>): 12 — 128 characters (depending on the media used, etc.).
- This unit can recognize a total of 512 files, 255 folders, and 8 hierarchical levels.

- This unit can play back files recorded in VBR (variable bit rate).
 - Files recorded in VBR have a discrepancy in the elapsed time display, and do not show the actual elapsed time. In particular, this difference becomes noticeable after performing the search function.
- This unit cannot play back the following files:
 - MP3 files encoded in MP3i and MP3 PRO format.
 - MP3 files encoded in an inappropriate format.
 - MP3 files encoded with Layer 1/2.
 - WMA files encoded in lossless, professional, and voice format.
 - WMA files which are not based upon Windows Media® Audio.
 - WMA files copy-protected with DRM.
 - Files which have data such as AIFF, ATRAC3, etc.
- The search function works but search speed is not constant.

Playing MP3/WMA tracks from a USB device (for KD-R416/KD-R415)

- While playing from a USB device, the playback order may differ from other players.
- This unit may be unable to play back some USB devices or some files due to their characteristics or recording conditions.
- Depending on the shape of the USB devices and connection ports, some USB devices may not be attached properly or the connection might be loose.
- Connect one USB mass storage class device to the unit at a time. Do not use a USB hub.
- If the connected USB device does not have the correct files, "CANNOT PLAY" appears.
- This unit can show Tag (Version 1.0, 1.1, 2.2, 2.3, or 2.4) for MP3 files and for WMA files.
- This unit can play back MP3/WMA files meeting the conditions below:

- Bit rate of MP3/WMA: 32 kbps — 320 kbps
- Sampling frequency of MP3:
32 kHz, 44.1 kHz, 48 kHz (for MPEG-1)
16 kHz, 22.05 kHz, 24 kHz (for MPEG-2)
- Sampling frequency of WMA:
22.05 kHz, 32 kHz, 44.1 kHz, 48 kHz
- This unit can play back MP3 files recorded in VBR (variable bit rate).
- The maximum number of characters for:
 - Folder names : 32 characters
 - File names : 32 characters
 - MP3 Tag : 64 characters
 - WMA Tag : 32 characters
- This unit can recognize a total of 5 000 files, 255 folders (255 files per folder including folder without unsupported files), and of 8 hierarchies.
- This unit does not support SD card reader.
- This unit cannot recognize a USB device whose rating is other than 5 V and exceeds 500 mA.
- USB devices equipped with special functions such as data security functions cannot be used with the unit.
- Do not use a USB device with 2 or more partitions.
- This unit may not recognized a USB device connected through a USB card reader.
- This unit may not play back files in a USB device properly when using a USB extension cord.
- This unit cannot play back the following files:
 - MP3 files encoded with MP3i and MP3 PRO format.
 - MP3 files encoded in an inappropriate format.
 - MP3 files encoded with Layer 1/2.
 - WMA files encoded in lossless, professional, and voice format.
 - WMA files not based on Windows Media® Audio.

Troubleshooting

	Symptom	Remedy/Cause
General	Sound cannot be heard from the speakers.	<ul style="list-style-type: none"> • Adjust the volume to the optimum level. • Make sure the unit is not muted/paused (🔊 6). • Check the cords and connections.
	"PROTECT" appears on the display and no operations can be done.	<p>Check to be sure the terminals of the speaker leads are covered with insulating tape properly, then reset the unit (🔊 3).</p> <p>If "PROTECT" does not disappear, consult your JVC car audio dealer or a company supplying kits.</p>
	The unit does not work at all.	Reset the unit. (🔊 3)
	"AUX" cannot be selected.	Check the <SRC SELECT> → <AUX IN> setting. (🔊 15)
FM/AM	SSM automatic presetting does not work.	Store stations manually.
	Static noise while listening to the radio.	Connect the antenna firmly.
	"AM" cannot be selected.	Check the <SRC SELECT> → <AM> setting. (🔊 15)



	Symptom	Remedy/Cause
Disc playback	Disc cannot be played back.	Insert the disc correctly.
	<ul style="list-style-type: none"> • CD-R/CD-RW cannot be played back. • Tracks on the CD-R/CD-RW cannot be skipped. 	<ul style="list-style-type: none"> • Insert a finalized CD-R/CD-RW. • Finalize the CD-R/CD-RW with the component which you used for recording.
	Disc can neither be played back nor ejected.	<ul style="list-style-type: none"> • Unlock the disc. (🔒 8) • Eject the disc forcibly. (🔒 3)
	Disc sound is sometimes interrupted.	<ul style="list-style-type: none"> • Stop playback while driving on rough roads. • Change the disc. • Check the cords and connections.
	"NO DISC" appears on the display.	Insert a playable disc into the loading slot.
	"PLEASE" and "EJECT" appear alternately on the display.	Press ▲, then insert a disc correctly.
MP3/WMA playback	Disc cannot be played back.	<ul style="list-style-type: none"> • Use a disc with MP3/WMA tracks recorded in a format compliant with ISO 9660 Level 1, Level 2, Romeo, or Joliet. • Add the extension code <.mp3> or <.wma> to the file names.
	Noise is generated.	Skip to another track or change the disc. (Do not add the extension code <.mp3> or <.wma> to non-MP3 or WMA tracks.)
	A longer readout time is required ("READING" keeps flashing on the display).	Do not use too many hierarchical levels and folders.
	Tracks do not play back in the order you have intended them to play.	The playback order is determined when the files are recorded.
	The elapsed playing time is not correct.	This sometimes occurs during playback. This is caused by how the tracks are recorded on the disc.
	For KD-R416/KD-R415: "NO FILE" appears on the display.	<p>Selected folder is an empty folder *. Select another folder that contains MP3/WMA tracks.</p> <p>* Folder that is physically empty or folder that contains data but does not contain valid MP3/WMA track.</p>
	"NOT SUPPORT" appears on the display and track skips.	Skip to the next track encoded in an appropriate format or to the next non-copy-protected WMA track.
	The correct characters are not displayed (e.g. album name).	This unit can only display letters (upper case), numbers, and a limited number of symbols.

	Symptom	Remedy/Cause
USB device playback (for KD-R416/KD-R415)	Noise is generated.	The track played back is not an MP3/WMA track. Skip to another file. (Do not add the extension code <.mp3> or <.wma> to non-MP3 or WMA tracks.)
	"READING" keeps flashing on the display.	<ul style="list-style-type: none"> • Readout time varies depending on the USB device. • Do not use too many hierarchy or folders. • Turn off the power then on again. • Reattach the USB device again.
	"NO FILE" appears on the display.	<p>Selected folder is an empty folder*. Select another folder that contains MP3/WMA tracks.</p> <p><i>* Folder that is physically empty or folder that contains data but does not contain valid MP3/WMA track.</i></p>
	"NOT SUPPORT" appears on the display and track skips.	Skip to the next track encoded in an appropriate format or to the next non-copy-protected WMA track.
	Tracks/folders are not played back in the order you have intended.	The playback order is determined by the write-in time stamp. The first track/folder written into the USB device will be the first track/folder for playback.
	<ul style="list-style-type: none"> • "CANNOT PLAY" flashes on the display. • "NO USB" appears on the display. • The unit cannot detect the USB device. 	<ul style="list-style-type: none"> • Attach a USB device that contains tracks encoded in an appropriate format. • Reattach the USB device again.
	While playing a track, sound is sometimes interrupted.	<p>The MP3/WMA tracks have not been properly copied into the USB device.</p> <p>Copy MP3/WMA tracks again into the USB device, and try again.</p>
	The correct characters are not displayed (e.g. album name).	This unit can only display letters (upper case), numbers, and a limited number of symbols.

JVC bears no responsibility for any loss of the data in the USB mass storage class device while using this System.

Microsoft and Windows Media are either registered trademarks or trademarks of Microsoft Corporation in the United States and/or other countries.

Specifications

AUDIO AMPLIFIER SECTION	Maximum Power Output:	Front/ Rear:	50 W per channel	
	Continuous Power Output (RMS):	Front/ Rear:	19 W per channel into 4 Ω , 40 Hz to 20 000 Hz at no more than 0.8% total harmonic distortion.	
	Load Impedance:		4 Ω (4 Ω to 8 Ω allowance)	
	Tone Control Range:	Bass:	± 12 dB (60 Hz, 80 Hz, 100 Hz, 200 Hz) Q1.0, Q1.25, Q1.5, Q2.0	
		Middle:	± 12 dB (0.5 kHz, 1.0 kHz, 1.5 kHz, 2.5 kHz) Q0.75, Q1.0, Q1.25	
		Treble:	± 12 dB (10.0 kHz, 12.5 kHz, 15.0 kHz, 17.5 kHz) Q (Fixed)	
	Frequency Response:		40 Hz to 20 000 Hz	
	Signal-to-Noise Ratio:		70 dB	
	Line-Out Level/Impedance:	KD-R416/ KD-R415	5.0 V/20 k Ω load (full scale)	
		KD-R316/ KD-R315	2.5 V/20 k Ω load (full scale)	
	Subwoofer-Out Level/Impedance:	KD-R416/ KD-R415	5.0 V/20 k Ω load (full scale)	
		KD-R316/ KD-R315	2.5 V/20 k Ω load (full scale)	
Output Impedance:		1 k Ω		
Other Terminal:		AUX (auxiliary) input jack, USB input jack (for KD-R416/KD-R415), Antenna input		
TUNER SECTION	Frequency Range:	FM:	87.5 MHz to 108.0 MHz	
		AM:	531 kHz to 1 602 kHz	
	FM Tuner:	Usable Sensitivity:	9.3 dBf (0.8 μ V/75 Ω)	
		50 dB Quieting Sensitivity:	16.3 dBf (1.8 μ V/75 Ω)	
		Alternate Channel Selectivity (400 kHz):	65 dB	
		Frequency Response:	40 Hz to 15 000 Hz	
		Stereo Separation:	40 dB	
	AM Tuner:	Sensitivity:	20 μ V	
Selectivity:		40 dB		

CD PLAYER SECTION	Type:		Compact disc player	
	Signal Detection System:		Non-contact optical pickup (semiconductor laser)	
	Number of Channels:		2 channels (stereo)	
	Frequency Response:		5 Hz to 20 000 Hz	
	Dynamic Range:		93 dB	
	Signal-to-Noise Ratio:		98 dB	
	Wow and Flutter:		Less than measurable limit	
	MP3 Decoding Format: (MPEG1/2 Audio Layer 3)		Max. Bit Rate: 320 kbps	
	WMA (Windows Media® Audio) Decoding Format:		Max. Bit Rate: 192 kbps	
USB SECTION (for KD-R416/KD-R415)	USB Standard:		USB 1.1, USB 2.0	
	Data Transfer Rate (Full Speed):		Max. 12 Mbps	
	Compatible Device:		Mass storage class	
	Compatible File System:		FAT 32/16/12	
	Playable Audio Format:		MP3/WMA	
	Max. Current:		DC 5 V $\overline{\text{---}}$ 500 mA	
GENERAL	Power Requirement:	Operating Voltage:	DC 14.4 V (11 V to 16 V allowance)	
	Grounding System:		Negative ground	
	Allowable Operating Temperature:			0°C to +40°C
	Dimensions (W × H × D): (approx.)	Installation Size:		182 mm × 52 mm × 160 mm
		Panel Size:		188 mm × 58 mm × 6 mm
	Mass:		1.3 kg (excluding accessories)	

Design and specifications are subject to change without notice.

Having TROUBLE with operation?

Please reset your unit

Refer to page of How to reset your unit

หากมีปัญหในการใช้งาน

กรุณาคดปุ่มตั้งค่าเริ่มต้นใหม่

กรุณาดูหน้าวิธีตั้งค่าเครื่องใหม่

JVC



EN, TH

© 2009 Victor Company of Japan, Limited

1009DTSMDTJEIN

JVC KD-R416/KD-R415/ KD-R316/KD-R315 Installation/Connection Manual

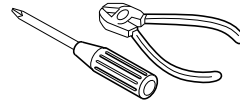

การติดตั้ง/คู่มือการติดตั้ง

GET0623-006A
[U/UH]

1009DTSMDTJEIN
EN, TH

© 2009 Victor Company of Japan, Limited

ENGLISH / ไทย

You need the installation kits which corresponds to your car.
ต้องใช้ชุดติดตั้งที่เหมาะสมกับรถของท่าน

Check the battery system in your car /
ตรวจสอบระบบแบตเตอรี่ในรถ



WARNINGS / คำเตือน

- To prevent short circuits:
 - Disconnect the battery's negative terminal and make all electrical connections before installing the unit.
 - Cover the terminals of the UNUSED leads with insulating tape.
- Be sure to ground this unit to the car's chassis again after installation.
- Replace the fuse with one of the specified rating.
- Connect speakers with a maximum power of more than 50 W (impedance of 4 Ω to 8 Ω). Otherwise, change the <AMP GAIN> setting. (See page 15 of the INSTRUCTIONS.)
- The heat sink becomes very hot after use. Be careful not to touch it when removing this unit.

- เพื่อป้องกันไฟฟ้าลัดวงจร:
 - ถอดขั้วลบของแบตเตอรี่ออก และเชื่อมต่อไฟฟ้าทั้งหมดก่อนติดตั้งเครื่อง
 - ปิดขั้วต่อของสายที่ไม่ได้ใช้ด้วยเทปป้องกัน
- ตรวจสอบให้แน่ใจว่าติดตั้งเครื่องกับโครงรถก่อนการติดตั้ง
- เปลี่ยนฟิวส์เป็นฟิวส์ตามพิกัดที่ระบุ
- ต่อลำโพงเข้ากับแหล่งจ่ายไฟที่ไม่เกิน 50 W (ค่าความต้านทาน 4 Ω ถึง 8 Ω) หรือเปลี่ยนการตั้งค่า <AMP GAIN> (ดูหน้า 15 คำแนะนำ)
- แผ่นระบายความร้อนร้อนมากหลังใช้งาน ห้ามสัมผัสเมื่อถอดเครื่องออก

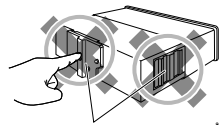

Heat sink / แผ่นระบายความร้อน

INSTALLATION / การติดตั้ง

The following illustration shows a typical installation. If you have any questions or require information regarding installation kits, consult your JVC car audio dealer or a company supplying kits.

ภาพประกอบต่อไปนี้แสดงการติดตั้งแบบปกติ หากท่านมีคำถามหรือต้องการข้อมูลเกี่ยวกับชุดติดตั้ง โปรดปรึกษาตัวแทนจำหน่ายเครื่องเสียงติดรถยนต์ JVC ของท่านหรือบริษัทที่จัดหาชุดอุปกรณ์ให้

In-dash mounting / การติดตั้งจอแบบ In-dash

1

2

3

Do the required electrical connections.
เชื่อมต่อไฟฟ้าที่จำเป็น

Install the unit at an angle of less than 30°.
ติดตั้งเครื่องในมุมน้อยกว่า 30°

Bend the appropriate tabs to hold the sleeve firmly in place.
บิดแถบล็อกเพื่อรองรับปลอกหุ้มให้เข้าที่อย่างแน่นหนา

Part list / รายการอุปกรณ์

- (A) Hard case / โครงแบบหนา (x1)
- (B) Control panel / แผงควบคุม (x1)
- (C) Sleeve / ปลอกหุ้ม (x1)
- (D) Trim plate / ทรिमเพลท (x1)
- (E) Power cord / สายไฟ (x1)
- (F) Handles / ที่จับ (x2)

When installing the unit without using the sleeve / เมื่อติดตั้งเครื่องโดยไม่ใช้ปลอกหุ้ม

Flat head screws (M5 × 8 mm) / ตะปูคางหัวแบน (M5 × 8 mm) *2

Pocket / กระเปาะ

Bracket / ขาแขวน *2

8 mm 8 mm

Removing the unit / การถอดเครื่อง

Release the rear section first... / ปลดส่วนหลังก่อน...

*1 When you stand the unit, be careful not to damage the fuse on the rear.
*2 Not supplied for this unit.

*1 เมื่อวางเครื่อง ระวังอย่าทำให้ฟิวส์ด้านหลังเสียหาย
*2 ไม่ได้จัดส่งให้สำหรับเครื่องนี้

ELECTRICAL CONNECTIONS / การเชื่อมต่อไฟฟ้า

IMPORTANT: A custom wiring harness (separately purchased) which is suitable for your car is recommended for connection between the unit and your car.

• Consult your JVC car audio dealer or a company supplying kits for details.

ข้อสำคัญ: ขอแนะนำให้ใช้ชุดสายไฟแบบสำเร็จ (แยกซื้อต่างหาก) ซึ่งเหมาะสำหรับรถของคุณ เพื่อใช้เชื่อมต่อระหว่างเครื่องและรถ

• สอบถามตัวแทนจำหน่ายวิทยุ JVC ของคุณหรือบริษัทที่จัดส่งชุดอุปกรณ์เพื่อขอรายละเอียด

PRECAUTIONS on power supply and speaker connections

- DO NOT connect the speaker leads of the power cord to the car battery; otherwise, the unit will be seriously damaged.
- BEFORE connecting the speaker leads of the power cord to the speakers, check the speaker wiring in your car.

ข้อควรระวังเกี่ยวกับการเชื่อมต่อแหล่งจ่ายไฟและลำโพง

- อย่าต่อสายลำโพงที่เป็นสายไฟกับแบตเตอรี่รถยนต์ ไมเช่นนั้นเครื่องอาจได้รับความเสียหายร้ายแรง
- ก่อนต่อสายลำโพงที่เป็นสายไฟกับลำโพง ควรตรวจสอบการเดินสายลำโพงในรถของท่าน

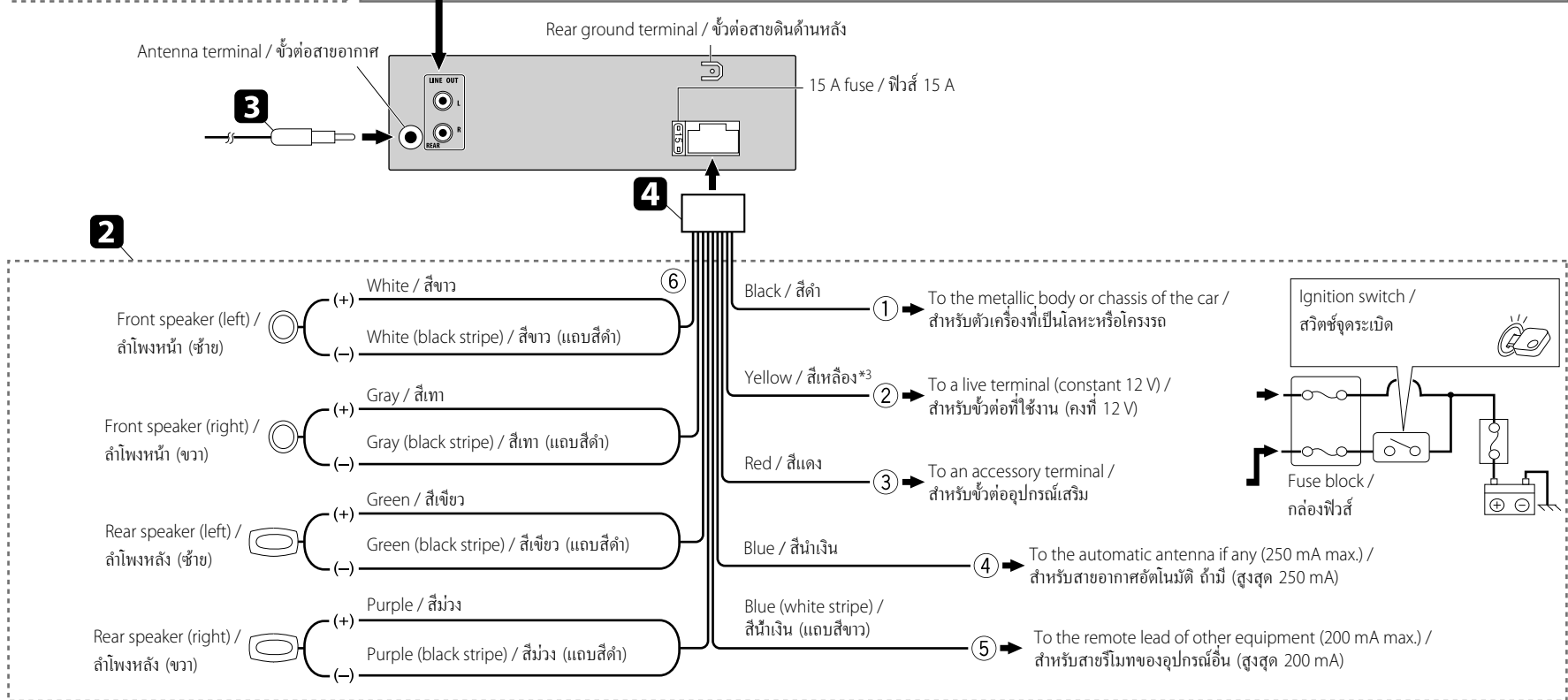
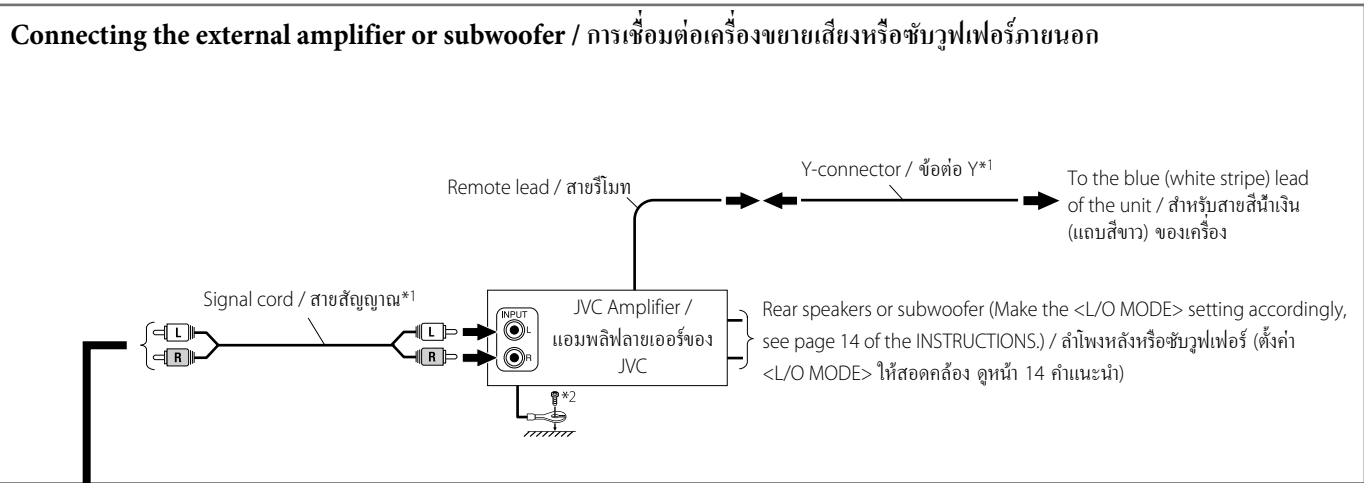
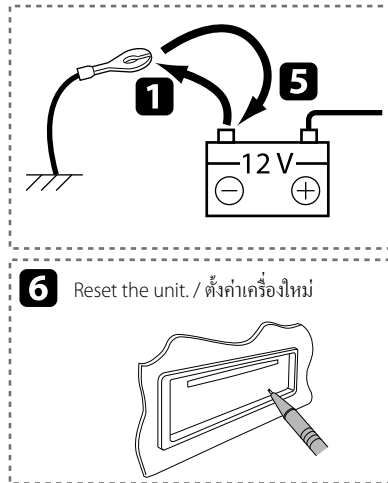
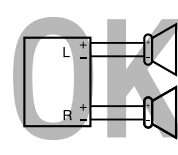
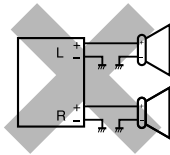
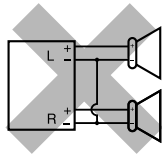

*1 Not supplied for this unit.

*2 Firmly attach the ground wire to the metallic body or to the chassis of the car—to the place uncoated with paint.

*3 Before checking the operation of this unit prior to installation, this lead must be connected; otherwise, the power cannot be turned on.

*1 ไม่ได้จัดส่งให้สำหรับเครื่องนี้

*2 ติดสายดินกับตัวเครื่องที่เป็นโลหะหรือโครงรถให้แน่นหนา—ในสถานที่ที่ไม่ได้พ่นสีทับ

*3 ก่อนตรวจสอบการทำงานของเครื่องนี้ก่อนการติดตั้ง สายไฟต้องต่อไว้แล้ว ไมเช่นนั้นจะไม่สามารถเปิดเครื่องได้

TROUBLESHOOTING / การแก้ไขปัญหาเบื้องต้น

- **The fuse blows.** ⇒ Are the red and black leads connected correctly?
- **Power cannot be turned on.** ⇒ Is the yellow lead connected?
- **No sound from the speakers.** ⇒ Is the speaker output lead short-circuited?
- **"PROTECT" appears on the display and no operation can be done.** ⇒ Is the speaker output lead short-circuited or touches the chassis of the car/head unit?; Have you reset your unit?
- **Sound is distorted.** ⇒ Is the speaker output lead grounded?; Are the "-" terminals of L and R speakers grounded in common?
- **Noise interfere with sounds.** ⇒ Is the rear ground terminal connected to the car's chassis using shorter and thicker cords?
- **This unit becomes hot.** ⇒ Is the speaker output lead grounded?; Are the "-" terminals of L and R speakers grounded in common?
- **This unit does not work at all.** ⇒ Have you reset your unit?

- ฟิวส์ขาด ⇒ ต่อสายสีแดงและสีดำถูกต้องหรือไม่?
- ไม่สามารถเปิดเครื่องได้ ⇒ ต่อสายสีเหลืองแล้วหรือไม่?
- ไม่ได้ยินเสียงจากลำโพง ⇒ สายสัญญาณออกของลำโพงลัดวงจรหรือไม่?
- ข้อความ "PROTECT" ปรากฏขึ้นบนหน้าจอและเครื่องไม่สามารถทำงานได้ ⇒ สายสัญญาณออกของลำโพงลัดวงจรหรือสัมผัสกับโครงรถ/ตัวเครื่องหลักหรือไม่?; ท่านตั้งเครื่องใหม่ไว้หรือไม่?
- เสียงผิดเพี้ยน ⇒ สายสัญญาณออกของลำโพงต่อกับสายดินหรือไม่?; ขั้วต่อ "-" ของลำโพง L (ซ้าย) และ R (ขวา) ต่อสายดินไว้ด้วยกันหรือไม่?
- มีเสียงรบกวน ⇒ ขั้วต่อสายดินด้านหลังที่ต่อกับโครงรถใช้สายที่สั้นและหนากว่าหรือไม่?
- เครื่องร้อน ⇒ สายสัญญาณออกของลำโพงต่อกับสายดินหรือไม่?; ขั้วต่อ "-" ของลำโพง L (ซ้าย) และ R (ขวา) ต่อสายดินไว้ด้วยกันหรือไม่?
- เครื่องใช้งานไม่ได้เลย ⇒ ท่านตั้งเครื่องใหม่ไว้หรือไม่?

Free Manuals Download Website

<http://myh66.com>

<http://usermanuals.us>

<http://www.somanuals.com>

<http://www.4manuals.cc>

<http://www.manual-lib.com>

<http://www.404manual.com>

<http://www.luxmanual.com>

<http://aubethermostatmanual.com>

Golf course search by state

<http://golfingnear.com>

Email search by domain

<http://emailbydomain.com>

Auto manuals search

<http://auto.somanuals.com>

TV manuals search

<http://tv.somanuals.com>