

JVC



ENGLISH

ESPAÑOL

FRANÇAIS

CD RECEIVER

KD-AR800/KD-G800/KD-G700

RECEPTOR CON CD

KD-AR800/KD-G800/KD-G700

RECEPTEUR CD

KD-AR800/KD-G800/KD-G700

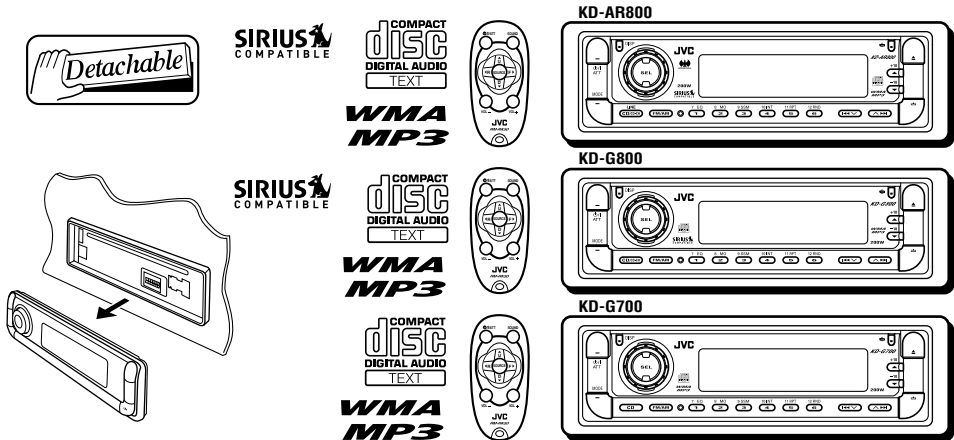

- This unit is equipped with the display demonstration. To cancel it, see page 8.
- Esta unidad está equipada con demostración en la pantalla. Para cancelarla, consulte la página 8.
- Cet appareil est équipé d'une fonction de démonstration des affichages. Pour l'annuler, référez-vous à la page 8.

For installation and connections, refer to the separate manual.

Para la instalación y las conexiones, refiérase al manual separado.

Pour l'installation et les raccordements, se référer au manuel séparé.

INSTRUCTIONS

MANUAL DE INSTRUCCIONES
MANUEL D'INSTRUCTIONS

For customer Use:

Enter below the Model No. and Serial No. which are located on the top or bottom of the cabinet. Retain this information for future reference.

Model No. _____

Serial No. _____

GET0197-001A

[J]

INFORMATION (For U.S.A.)

This equipment has been tested and found to comply with the limits for a Class B digital device, pursuant to Part 15 of the FCC Rules. These limits are designed to provide reasonable protection against harmful interference in a residential installation. This equipment generates, uses, and can radiate radio frequency energy and, if not installed and used in accordance with the instructions, may cause harmful interference to radio communications. However, there is no guarantee that interference will not occur in a particular installation. If this equipment does cause harmful interference to radio or television reception, which can be determined by turning the equipment off and on, the user is encouraged to try to correct the interference by one or more of the following measures:

- Reorient or relocate the receiving antenna.
- Increase the separation between the equipment and receiver.
- Connect the equipment into an outlet on a circuit different from that to which the receiver is connected.
- Consult the dealer or an experienced radio/TV technician for help.

IMPORTANT FOR LASER PRODUCTS

1. CLASS 1 LASER PRODUCT
2. **CAUTION:** Do not open the top cover. There are no user serviceable parts inside the unit; leave all servicing to qualified service personnel.
3. **CAUTION:** Visible and invisible laser radiation when open and interlock failed or defeated. Avoid direct exposure to beam.

How to reset your unit

Press the reset button on the control panel using a ball-point pen or similar tool. This will reset the built-in microcomputer.

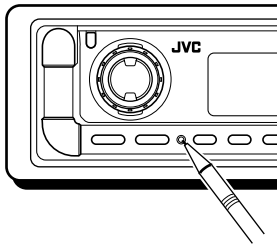
**Note:**

Your preset adjustments—such as preset channels or sound adjustments—will also be erased.

CAUTION:

NEVER insert your finger in between the control panel and the unit, as it may get caught or hurt. (See page 32.)

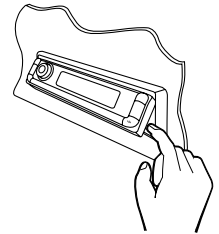
**CAUTION on Volume Setting:**

Discs produce very little noise compared with other sources. If the volume level is adjusted for the tuner, for example, the speakers may be damaged by the sudden increase in the output level. Therefore, lower the volume before playing a disc and adjust it as required during playback.

BEFORE USE***For safety....**

- Do not raise the volume level too much, as this will block outside sounds, making driving dangerous.
- Stop the car before performing any complicated operations.

***Temperature inside the car....**

If you have parked the car for a long time in hot or cold weather, wait until the temperature in the car becomes normal before operating the unit.

Thank you for purchasing a JVC product. Please read all instructions carefully before operation, to ensure your complete understanding and to obtain the best possible performance from the unit.

CONTENTS

How to reset your unit	2	MP3/WMA OPERATIONS	18
How to use the MODE button	3	Playing a disc	18
LOCATION OF THE BUTTONS	4	Locating a file or a particular portion on a disc	19
Control panel	4	Selecting the playback modes	21
Remote controller	5	SOUND ADJUSTMENTS	23
Preparing the remote controller	6	Adjusting the sound	23
BASIC OPERATIONS	7	Selecting preset sound modes (iEQ: intelligent equalizer)	24
Turning on the power	7	Storing your own sound adjustments	25
Canceling the display demonstration	8	OTHER MAIN FUNCTIONS	26
Setting the clock	9	Changing the general settings (PSM)	26
RADIO OPERATIONS	10	Assigning names to the sources	31
Listening to the radio	10	Changing the control panel angle	32
Storing stations in memory	11	Detaching the control panel	33
Tuning in to a preset station	12	CD CHANGER OPERATIONS	
CD OPERATIONS	13	(Only for KD-AR800/KD-G800)	34
Playing a CD	13	Playing discs	34
Locating a track or a particular portion on a CD	14	Selecting the playback modes	37
Selecting CD playback modes	15	EXTERNAL COMPONENT OPERATIONS	
Playing a CD Text	16	(Only for KD-AR800/KD-G800)	39
Prohibiting disc ejection	16	Playing an external component	39
MP3/WMA INTRODUCTION	17	ADDITIONAL INFORMATION	40
What are MP3/WMA?	17	TROUBLESHOOTING	41
How are MP3/WMA files recorded and played back?	17	MAINTENANCE	44
		Handling discs	44
		SPECIFICATIONS	45

How to use the MODE button

If you press MODE, the unit goes into functions mode, then the number buttons and ▲/▼ buttons work as different function buttons.

Ex.: When number button 2 works as MO (monaural) button.

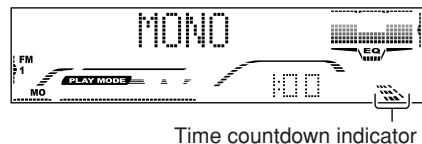
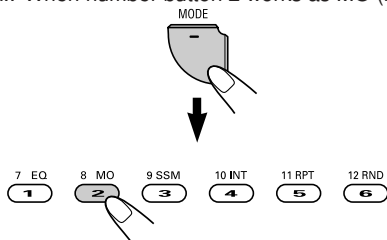

To use these buttons for original functions again after pressing MODE, wait for 5 seconds without pressing any of these buttons until the functions mode is cleared.

- Pressing MODE again also clears the functions mode.



LOCATION OF THE BUTTONS

ENGLISH

Control panel

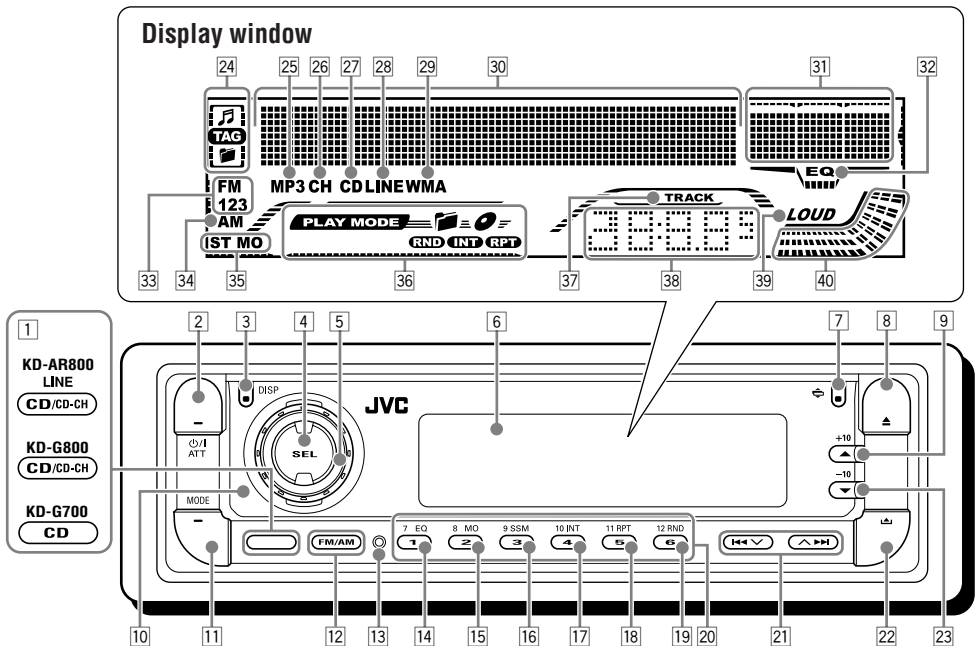

- 1 For KD-AR800:
• CD/CD-CH (CD changer) LINE button
- For KD-G800:
• CD/CD-CH (CD changer) button
- For KD-G700:
• CD button
- 2 ϕ /I ATT (standby/on attenuator) button
- 3 DISP (display) button
- 4 SEL (select) button
- 5 Control dial
- 6 Display window
- 7 \curvearrowright (angle) button
- 8 \blacktriangle (eject) button
- 9 \blacktriangle (up) button
+10 button
- 10 Remote sensor
- 11 MODE button
- 12 FM/AM button
- 13 Reset button
- 14 EQ (equalizer) button
- 15 MO (monaural) button
- 16 SSM (Strong-station Sequential Memory) button
- 17 INT (intro) button
- 18 RPT (repeat) button
- 19 RND (random) button
- 20 Number buttons
- 21 \blacktriangleleft \blacktriangleright / \blacktriangle \blacktriangleright buttons
- 22 \blacktriangle (control panel release) button

- 23 \blacktriangledown (down) button
-10 button

Display window

- 24 Disc information indicators— ID3 (track/file), TAG (ID3 Tag), ID3 (folder)
- 25 MP3 indicator
- 26 For KD-AR800/KD-G800:
• CH (CD changer) indicator
- 27 CD indicator
- 28 For KD-AR800/KD-G800:
• LINE indicator
- 29 WMA indicator
- 30 Main display
- 31 Equalizer pattern indicator
Audio level indicator
- 32 EQ (equalizer) indicator
- 33 FM band indicators—FM1, FM2, FM3
- 34 AM band indicator
- 35 Tuner reception indicators—ST (stereo), MO (monaural)
- 36 Play mode indicators— ID3 (folder), ID3 (disc), RND (random), INT (intro), RPT (repeat)
- 37 TRACK indicator
- 38 Source/clock display
- 39 LOUD (loudness) indicator
- 40 Audio level indicator
Volume level indicator



Remote controller

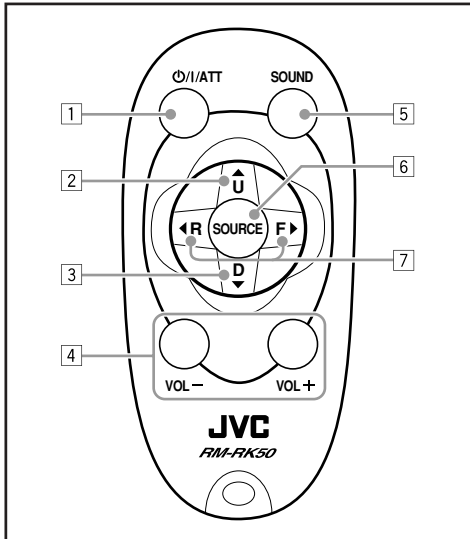

- 1 • Turns on the unit if pressed when the unit is turned off.
 - Turns off the unit if pressed and held until “SEE YOU” appears on the display.
 - Drops the volume level in a moment if pressed briefly. Press again to resume the volume.
- 2 • Selects the band while listening to the radio. Each time you press the button, the band changes.
 - Skips to the first file of the next folder while listening to an MP3 or a WMA disc. Each time you press the button, you can move to the next folder and start playing the first file.
 - For KD-AR800/KD-G800: While playing an MP3 disc on an MP3-compatible CD changer;
 - Skips to the next disc if pressed briefly.
 - Skips to the next folder if pressed and held.

Note: While playing a CD on a CD changer, this always skips to the next disc.

- 3 • Selects the preset stations while listening to the radio. Each time you press the button, the preset station number increases, and the selected station is tuned in.
 - Skips to the first file of the previous folder while listening to an MP3 or a WMA disc. Each time you press the button, you can move to the previous folder and start playing the first file.
 - For KD-AR800/KD-G800: While playing an MP3 disc on an MP3-compatible CD changer;
 - Skips to the previous disc if pressed briefly.
 - Skips to the previous folder if pressed and held.

Note: While playing a CD on a CD changer, this always skips to the previous disc.
- 4 Functions the same as the control dial on the main unit.

Note: These buttons do not function for the preferred setting mode (PSM) adjustment.
- 5 Selects the sound mode (iEQ: intelligent equalizer). Each time you press the button, the sound mode (iEQ) changes.
- 6 Selects the source. Each time you press the button, the source changes.
- 7 • Searches for stations while listening to the radio.
 - Fast-forwards or reverses the track/file if pressed and held while listening to a disc.
 - Skips to the beginning of the next track/file or goes back to the beginning of the current (or previous) tracks/files if pressed briefly while listening to a disc.



Preparing the remote controller

Before using the remote controller:

- Aim the remote controller directly at the remote sensor on the main unit. Make sure there is no obstacle in between.

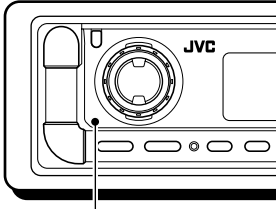

Remote sensor

- Do not expose the remote sensor to strong light (direct sunlight or artificial lighting).

Installing the battery

When the controllable range or effectiveness of the remote controller decreases, replace the battery.

1. Remove the battery holder.

- 1) Push out the battery holder in the direction indicated by the arrow using a ball-point pen or a similar tool.
- 2) Remove the battery holder.

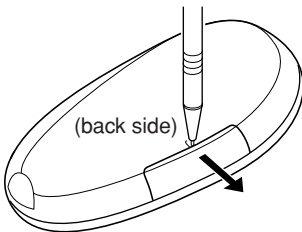

2. Place the battery.

Slide the battery into the holder with the + side facing upwards so that the battery is fixed in the holder.

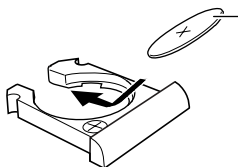

Lithium coin battery (product number: CR2025)

3. Return the battery holder.

Insert again the battery holder by pushing it until you hear a clicking sound.

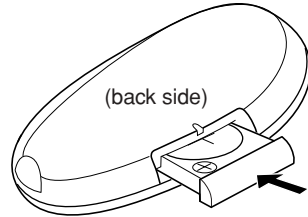

WARNING:

- Store the battery in a place where children cannot reach.
If a child accidentally swallows the battery, consult a doctor immediately.
- Do not recharge, short, disassemble, or heat the battery or dispose of it in a fire.
Doing any of these things may cause the battery to give off heat, crack, or start a fire.
- Do not leave the battery with other metallic materials.
Doing this may cause the battery to give off heat, crack, or start a fire.
- When throwing away or saving the battery, wrap it in tape and insulate; otherwise, the battery may start to give off heat, crack, or start a fire.
- Do not poke the battery with tweezers or similar tools.
Doing this may cause the battery to give off heat, crack, or start a fire.

CAUTION:

DO NOT leave the remote controller in a place (such as dashboards) exposed to direct sunlight for a long time. Otherwise, it may be damaged.

BASIC OPERATIONS

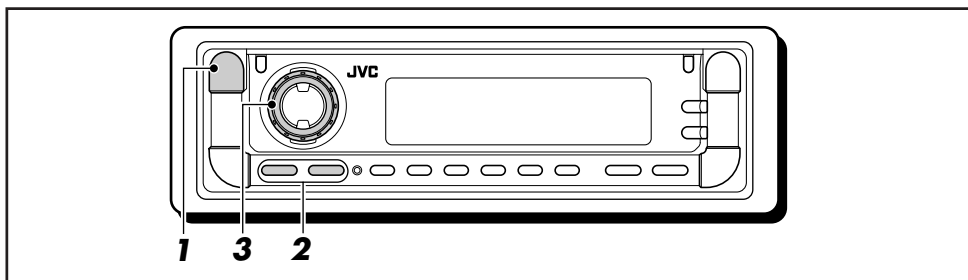

Turning on the power

1 Turn on the power.

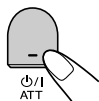

Note on One-Touch Operation:

When you select a source in step 2 below, the power automatically comes on. You do not have to press this button to turn on the power.

2 Select the source.



(For KD-AR800)



(For KD-G800)



(For KD-G700)

To operate the tuner (FM or AM), see pages 10 – 12.

To play a CD, see pages 13 – 16.

To play an MP3/WMA disc, see pages 18 – 22.

• For KD-AR800/KD-G800

To operate the CD changer, see pages 34 – 38.

To operate the external component—LINE IN or SIRIUS, see page 39.

3 Adjust the volume.

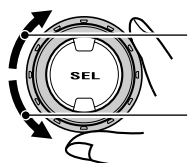

To increase the volume

To decrease the volume

Volume level appears.



Volume level indicator

4 Adjust the sound as you want. (See pages 23 – 25.)

To drop the volume in a moment

Press Φ /I ATT briefly while listening to any source. "ATT" starts flashing on the display, and the volume level will drop in a moment.

To resume the previous volume level, press the button briefly again.

- If you turn the control dial, you can also restore the sound.

To turn off the power

Press and hold Φ /I ATT for more than one second.

"SEE YOU" appears, then the unit turns off.

- If you turn off the power while listening to a disc, disc play will start from where playback has been stopped previously, next time you turn on the power.

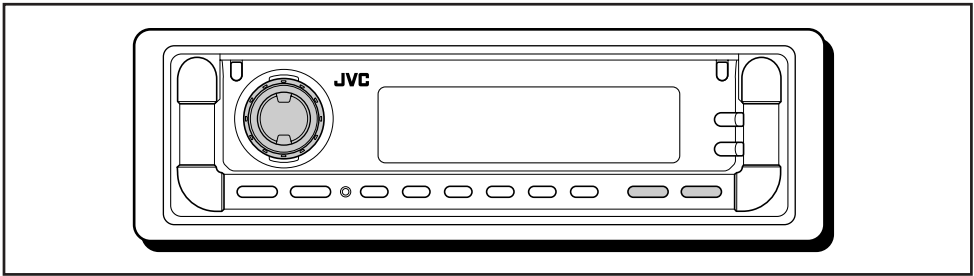

Canceling the display demonstration

When shipped from the factory, display demonstration has been activated, and starts automatically when no operations are done for about 20 seconds.

- It is recommended to cancel the display demonstration before you use the unit for the first time.

To cancel the display demonstration, follow the procedure below:

- 1** Press and hold SEL (select) for more than 2 seconds so that one of the PSM items appears on the display. (PSM: see pages 26 and 27.)



- 2** Select "DEMO MODE" if not shown on the display.



- 3** Select "DEMO OFF."



DEMO OFF ↔ DEMO ON



- 4** Finish the setting.



To activate the display demonstration, repeat the same procedure and select "DEMO ON" in step 3.

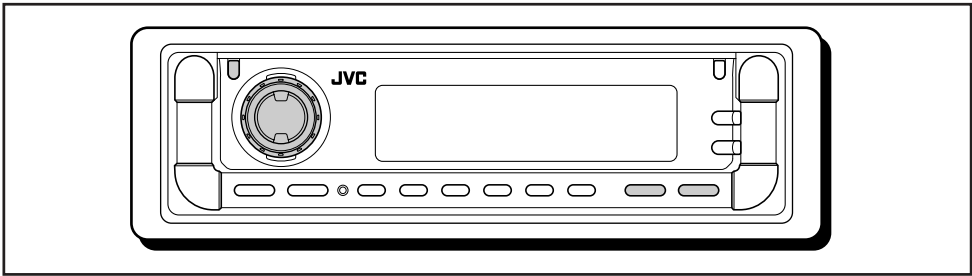

Setting the clock

- 1 Press and hold SEL (select) for more than 2 seconds so that one of the PSM items appears on the display. (PSM: see pages 26 and 27.)**



- 2 Set the hour.**

- 1 Select "CLOCK HOUR" if not shown on the display.
- 2 Adjust the hour.

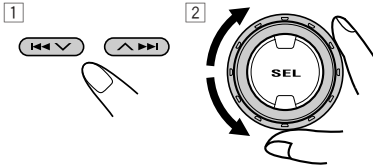

- 3 Set the minute.**

- 1 Select "CLOCK MINUTE".
- 2 Adjust the minute.

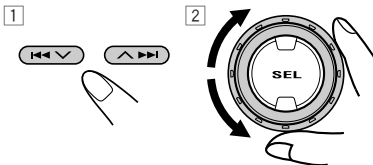

- 4 Finish the setting.**



Note:

To show the clock time on the display, see page 28.

To check other information during play, press DISP (display).



Each time you press the button, the other information will be shown on the lower part of the display. (See page 28 for details.)

- Pressing DISP (display) with the unit turned off will show the clock time for about 5 seconds.



RADIO OPERATIONS

ENGLISH

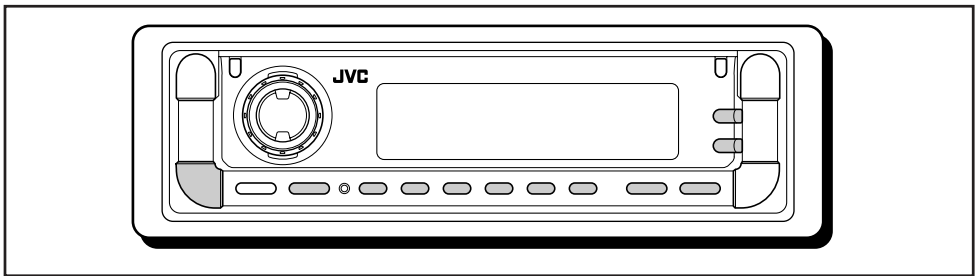

Listening to the radio

You can use either automatic searching or manual searching to tune in to a particular station.

Searching for a station automatically: Auto search

1 Select the band (FM1 – 3, AM).



Each time you press the button, the band changes as follows:

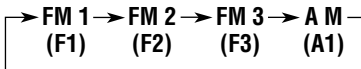

Selected band appears*.



Lights up when receiving an FM stereo broadcast with sufficient signal strength.

* When "CLOCK DISP" is set to "CLK DISP ON" (see page 28), the current indication will soon change to the clock time.

Note:

This receiver has three FM bands (FM1, FM2, FM3). You can use any one of them to listen to an FM broadcast.

2 Start searching for a station.

To search for stations of higher frequencies

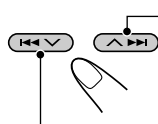

To search for stations of lower frequencies

When a station is received, searching stops.

To stop searching before a station is received, press the same button you have pressed for searching.

Searching for a station manually: Manual search

1 Select the band (FM1 – 3, AM).



Each time you press the button, the band changes as follows:

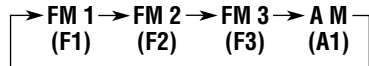

Note:

This receiver has three FM bands (FM1, FM2, FM3). You can use any one of them to listen to an FM broadcast.

2 Press and hold ^▶▶▶ or ◀◀◀ until "M.SEEK" appears on the display.

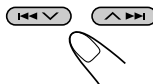

3 Tune in to a station you want while “M.SEEK” (manual seek) is still on the display.

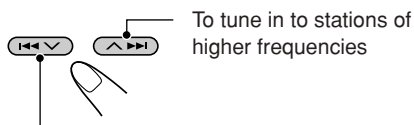

To tune in to stations of lower frequencies

- If you release your finger from the button, the manual mode will automatically turn off after 5 seconds.
- If you hold down the button, the frequency keeps changing (in 200 kHz intervals for FM and 10 kHz for AM) until you release the button.

When an FM stereo broadcast is hard to receive:

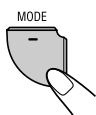

- 1 Press MODE to enter the functions mode while listening to an FM stereo broadcast.



- 2 Press MO (monaural), while “MODE” is still on the display, so that “MONO” appears on the display. Each time you press the button, the monaural mode turns on and off alternately.



MO (monaural) indicator

When the MO indicator is lit on the display, the sound you hear becomes monaural but the reception will be improved.

Storing stations in memory

You can use one of the following two methods to store broadcasting stations in memory.

- Automatic preset of FM stations: SSM (Strong-station Sequential Memory)
- Manual preset of both FM and AM stations

FM station automatic preset: SSM

You can preset 6 local FM stations in each FM band (FM1, FM2, and FM3).

1 Select the FM band (FM1 – 3) you want to store FM stations into.



Each time you press the button, the band changes as follows:

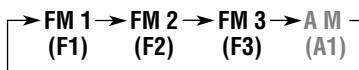

2 Press MODE to enter the functions mode.

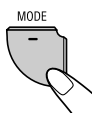

3 Press and hold SSM for about 2 seconds.



“SSM” appears, then disappears when automatic preset is over.

Local FM stations with the strongest signals are searched and stored automatically in the band number you have selected (FM1, FM2, or FM3). These stations are preset in the number buttons—No.1 (lowest frequency) to No.6 (highest frequency).

When automatic preset is over, the station stored in number button 1 will be automatically tuned in.



Manual preset

You can preset up to 6 stations in each band (FM1, FM2, FM3, and AM) manually.

Ex.: Storing FM station of 92.5 MHz into the preset number 1 of the FM1 band.

1 Select the band (FM1 – 3, AM) you want to store stations into (in this example, FM1).



Each time you press the button, the band changes as follows:

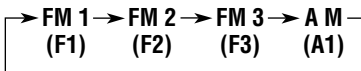

2 Tune in to a station (in this example, of 92.5 MHz).

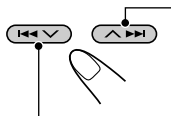

To tune in to stations of higher frequencies

To tune in to stations of lower frequencies

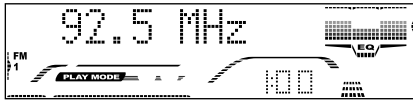

3 Press and hold the number button (in this example, 1) for more than 2 seconds.



Preset number flashes for a while



4 Repeat the above procedure to store other stations into other preset numbers.

Notes:

- A previously preset station is erased when a new station is stored in the same preset number.
- Preset stations are erased when the power supply to the memory circuit is interrupted (for example, during battery replacement). If this occurs, preset the stations again.

Tuning in to a preset station

You can easily tune in to a preset station. Remember that you must store stations first. If you have not stored them yet, see "Storing stations in memory" on pages 11 and 12.

1 Select the band (FM1 – 3, AM).



Each time you press the button, the band changes as follows:

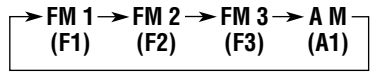

2 Select the number (1 – 6) for the preset station you want.



Note:

You can also use the ▲ (up) or ▼ (down) button on the unit to select the next or previous preset stations. Each time you press the ▲ (up) or ▼ (down) button, the next or previous preset station is tuned in.

CD OPERATIONS

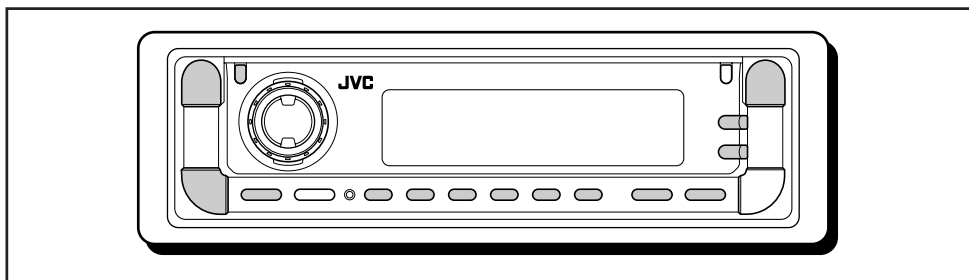

Refer to “MP3/WMA OPERATIONS” on pages 18 to 22 for operating MP3/WMA discs.

Playing a CD

1 Open the control panel.

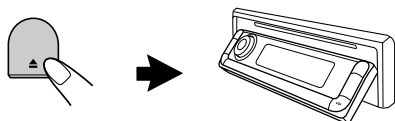

Note on One-Touch Operation:

When a CD is already in the loading slot, pressing CD/CD-CH LINE (for KD-AR800) or CD/CD-CH (for KD-G800) or CD (for KD-G700) turns on the unit and starts playback automatically.

2 Insert a CD into the loading slot.

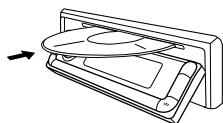

The unit draws the CD, the control panel goes back to the previous position (see page 32), and playback starts automatically.

All tracks will be played repeatedly until you stop playback.

The display changes to show the following:



CD indicator Current source indication*

Total playing time of the inserted disc Total track number of the inserted disc



Elapsed playing time Current track number



* When “CLOCK DISP” is set to “CLK DISP ON” (see page 28), the current indication will soon change to the clock time.

Notes:

- When a CD is inserted upside down, the control panel moves down, the CD automatically ejects from the loading slot. The source changes to the previously selected source.
- If there is no CD in the loading slot, you cannot select CD as the source.
- If the current disc is a CD Text, disc title/performer and then track title will automatically appear.



To stop play and eject the CD

Press **▲**.
CD play stops and the control panel moves down. The CD automatically ejects from the loading slot.

- If you change the source or turn the power off, CD play also stops (without ejecting the CD). Next time you select "CD" as the source, CD play starts from where playback has been stopped previously.

To return the control panel to its previous position, press **▲** again.

- If you keep the loading slot fully open for 1 minute, (beeps sound when the "BEEP SWITCH" is set to "BEEP ON"—see page 29) the control panel automatically returns to its previous position.
Be careful not to get the disc or your finger caught in between the control panel and the unit.

Notes:

- If the ejected disc is not removed for about 15 seconds, the disc is automatically inserted again into the loading slot to protect it from dust. (Disc play will not start this time.)
- You can eject the disc even when the unit is turned off.

Locating a track or a particular portion on a CD

To fast-forward or reverse the track

Press and hold **▲ ▶▶**, while playing a CD, to fast-forward the track.

Press and hold **◀◀ ▼**, while playing a CD, to reverse the track.

To go to the next or previous tracks

Press **▲ ▶▶** briefly, while playing a CD, to go ahead to the beginning of the next track.
Each time you press the button consecutively, the beginning of the next tracks is located and played back.

Press **◀◀ ▼** briefly, while playing a CD, to go back to the beginning of the current track.
Each time you press the button consecutively, the beginning of the previous tracks is located and played back.

To go to a particular track directly

Press the number button corresponding to the track number to start its playback.

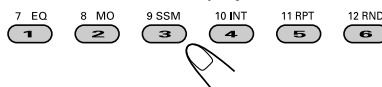

- To select a track number from 1 – 6:
Press 1 (7) – 6 (12) briefly.
- To select a track number from 7 – 12:
Press and hold 1 (7) – 6 (12) for more than one second.

To go to a track quickly (+10 and -10 buttons)

- 1 Press **MODE** to enter the functions mode while playing a CD.

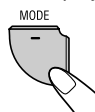

- 2 Press +10 or -10.

+10 — To skip 10 tracks* forwards to the last track

-10 — To skip 10 tracks* backwards to the first track

* First time you press +10 or -10 button, the track skips to the nearest higher or lower track with a track number of multiple ten (ex. 10th, 20th, 30th).

Then each time you press the button, you can skip 10 tracks (see "How to use the +10 and -10 buttons" on page 15).

- After the last track, the first track will be selected, and vice versa.



How to use the +10 and -10 buttons

- Ex. 1: To select track number 32 while playing track number 6

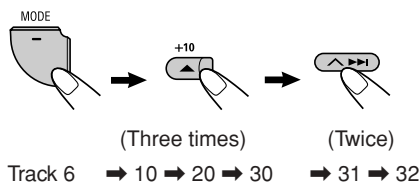

- Ex. 2: To select track number 8 while playing track number 36

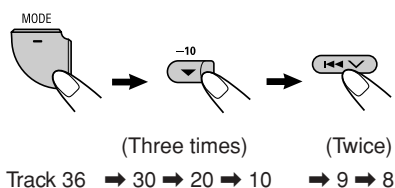

To play back tracks repeatedly (Track Repeat Play)

You can play back the current track repeatedly.

- 1 Press MODE to enter the functions mode while playing a CD.
- 2 Press RPT (repeat), while "MODE" is still on the display, so that "TRK RPT" appears on the display. Each time you press the button, track repeat play mode turns on and off alternately.

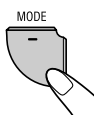

RPT indicator

When track repeat play is turned on, the RPT indicator lights up on the display. The current track starts playing repeatedly.

Selecting CD playback modes

To play back tracks at random (Disc Random Play)

You can play back all tracks on the CD at random.

- 1 Press MODE to enter the functions mode while playing a CD.
- 2 Press RND (random), while "MODE" is still on the display, so that "DISC RND" appears on the display. Each time you press the button, disc random play mode turns on and off alternately.

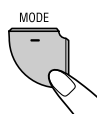

(disc) and RND indicators

When disc random play is turned on, the (disc) and RND indicators light up on the display. A track randomly selected starts playing.

To play back only intros (Track Intro Scan)

You can play back the first 15 seconds of each track sequentially.

- 1 Press MODE to enter the functions mode while playing a CD.
- 2 Press INT (intro), while "MODE" is still on the display, so that "TRK INT" appears on the display. Each time you press the button, track intro scan mode turns on and off alternately.

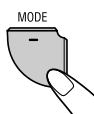

INT indicator

When track intro scan is turned on, the INT indicator lights up on the display. The first 15 seconds of each track is played sequentially.



Playing a CD Text

In a CD Text, some information about the disc (its disc title, performer, and track title) is recorded.

This CD Text information will be shown automatically when you play a CD Text.

To change the CD Text information manually, select text display mode while playing a CD Text.



Press DISP (display) repeatedly. Each time you press the button, the display changes as follows:

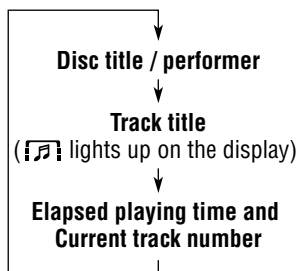

Notes:

- The display shows up to 12 characters at one time and scrolls if there are more than 12 characters. See also "To select the scroll mode—SCROLL MODE" on page 29. Some characters or symbols will not be shown (will be blanked or substituted) on the display.
- If no name is assigned to the CD, "NO NAME" will appear. To assign a name to an audio CD, see page 31.
- If no disc title/performer or no track title is recorded for the CD Text, "NO NAME" will appear.
- When track title is shown, TRACK indicator and current track number also appear on the lower part of the display.

Prohibiting disc ejection

You can prohibit disc ejection and can lock a disc in the loading slot.

While pressing CD/CD-CH LINE (for KD-AR800) or CD/CD-CH (for KD-G800) or CD (for KD-G700), press and hold ϕ /I ATT for more than 2 seconds.

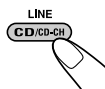

(For KD-AR800)



(For KD-G800)

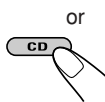
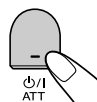

(For KD-G700)

"NO EJECT" flashes on the display for about 5 seconds, and the disc is locked and cannot be ejected.



To cancel the prohibition and unlock the disc

While pressing CD/CD-CH LINE (for KD-AR800) or CD/CD-CH (for KD-G800) or CD (for KD-G700), press and hold ϕ /I ATT again for more than 2 seconds.

"EJECT OK" flashes on the display for about 5 seconds, and the disc is unlocked.

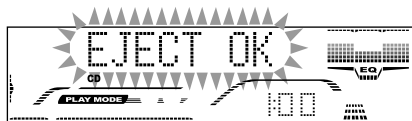

MP3/WMA INTRODUCTION



ENGLISH

What are MP3/WMA?

MP3 is an abbreviation of Motion Picture Experts Group (or MPEG) Audio Layer 3. MP3 is simply a file format with a data compression ratio of 1:10 (128 Kbps*).

WMA (Windows Media® Audio) is the digital audio compression format developed by Microsoft Corporation.

* *Bit rate is the average number of bits that one second of audio data will consume. The unit used is Kbps. To get a better audio quality, choose a higher bit rate. The most popular bit rate for encoding is 128 Kbps.*

- For details information about the MP3/WMA discs, refer to “A Guide to MP3/WMA” (separate volume).

Compatible with ID3 Tag

Extra information data such as album title, performer name, song title, recording year, music genre and a brief comment can be stored within an MP3/WMA file.

This unit can show both ID3v1 (Version 1) and ID3v2 (Version 2) tags on the display. (See page 19.)

- Some characters cannot be shown correctly.
- If both ID3v1 and ID3v2 are recorded on a disc, ID3v2 information will be shown.

How are MP3/WMA files recorded and played back?

MP3/WMA “files (tracks)” can be recorded in “folders” —in PC terminology.

During recording, the files and folders can be arranged in a way similar to arranging files and folders of computer data.

“Root” is similar to the root of a tree. Every file and folder can be linked to and be accessed from the root.

The illustration below shows an example of how MP3/WMA files are recorded on a CD-R or CD-RW, how they are played back, and how they are searched for on this unit.

Notes:

- This unit cannot read or play an MP3 file without the extension code <.mp3> and a WMA track without the extension code <.wma>.
- This unit is not compatible with MP3 files encoded with Layer 1 and Layer 2 formats.
- This unit is not compatible with WMA files which are not based upon Windows Media® Audio.
- This unit is not compatible with Playlist**.

** A playlist is a simple text file, used on a PC, which enables users to make their own playback order without physically rearranging the files.

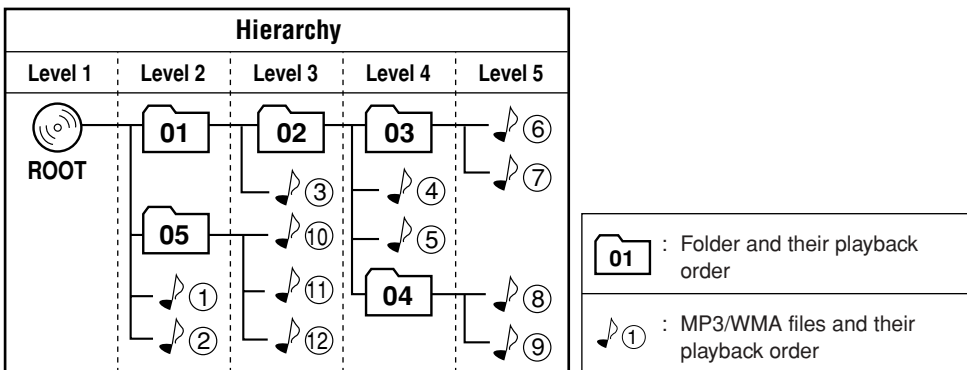

- Microsoft and Windows Media are either registered trademarks or trademarks of Microsoft Corporation in the United States and/or other countries.



MP3/WMA OPERATIONS

ENGLISH

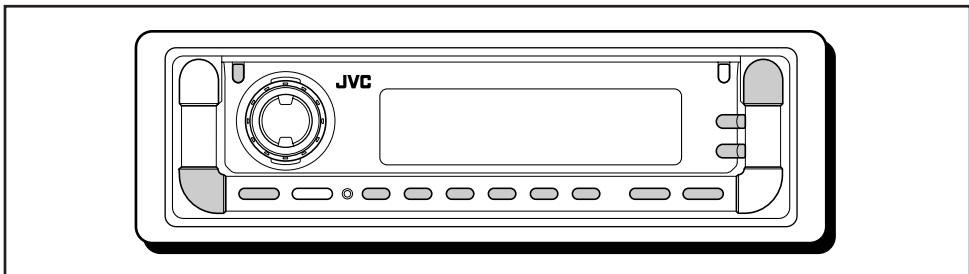

Refer also to "CD OPERATIONS" on pages 13 to 16.

Playing a disc

1 Open the control panel.

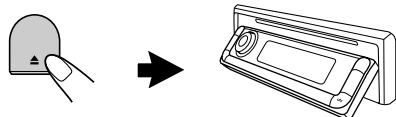

Note on One-Touch Operation:

When a disc is already in the loading slot, pressing CD/CD-CH LINE (for KD-AR800) or CD/CD-CH (for KD-G800) or CD (for KD-G700) turns on the unit and starts playback automatically.

2 Insert a disc into the loading slot.

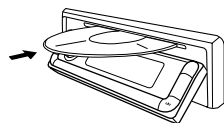

The unit draws the disc, the control panel goes back to the previous position (see page 32), and playback starts automatically.

All files will be played repeatedly until you stop playback.

The display changes to show the following:

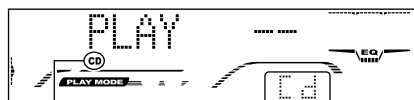

CD indicator Current source indication*1



Total folder number Total file number



MP3 or WMA indicator*2

Ex.: When the disc contains 19 folders and 144 MP3/WMA files

*1 When "CLOCK DISP" is set to "CLK DISP ON" (see page 28), the current indication will soon change to the clock time.

*2 WMA or MP3 indicator lights up depending on the first detected file.

Notes:

- MP3/WMA discs require a longer readout time. (It differs due to the complexity of the folder/file configuration.)
- When playback starts, folder and file names (or ID3 tags) will automatically appear. (See also page 19.)
- If you change the source or turn the power off, disc playback stops (without ejecting the disc). Next time you select the CD player as the source or turn the power on, disc play starts from where playback has been stopped previously.

To stop play and eject the disc

Press .
Playback stops and the control panel moves down.
The disc automatically ejects from the loading slot.

To change the display information

While playing back an MP3/WMA file, you can change the disc information shown on the display.



Press DISP (display) repeatedly. Each time you press the button, the display changes to show the following:

- When “TAG DISPLAY” is set to “TAG DISP ON” (initial setting: see page 30)

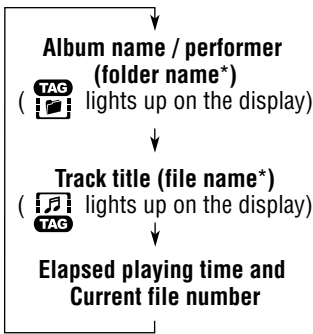

* If ID3 tags are not recorded, folder name and file name appear. In this case, the TAG indicator will not light up on the display.

- When “TAG DISPLAY” is set to “TAG DISP OFF”

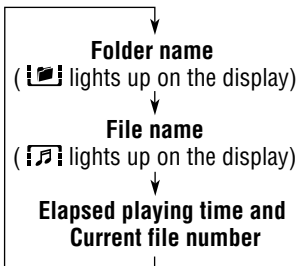



Notes:

- The display shows up to 12 characters at a time and scrolls if there are more than 12 characters. See also “To select the scroll mode—SCROLL MODE” on page 29.
- When file name is shown, TRACK indicator and current track number also appear on the lower part of the display.

Locating a file or a particular portion on a disc

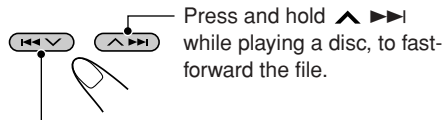
To fast-forward or reverse the file



Press and hold  while playing a disc, to fast-forward the file.

Press and hold  while playing a disc, to reverse the file.

Note:

During this operation, you can only hear intermittent sounds. (The elapsed playing time also changes intermittently on the display.)

To skip to the next or previous files

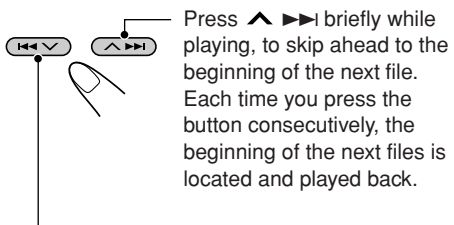

Press  briefly while playing, to skip ahead to the beginning of the next file. Each time you press the button consecutively, the beginning of the next files is located and played back.

Press  briefly while playing, to skip back to the beginning of the current file. Each time you press the button consecutively, the beginning of the previous files is located and played back.



To go to a particular file quickly within the current folder (+10 and -10 buttons)

- 1 Press MODE to enter the functions mode while playing a disc.

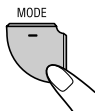

- 2 Press +10 or -10.

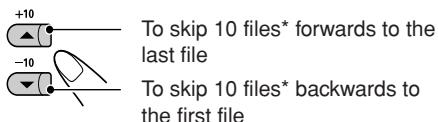

* First time you press +10 or -10 button, the file skips to the nearest higher or lower file with a file number of multiple ten (ex. 10th, 20th, 30th).

Then each time you press the button, you can skip 10 files (see "How to use the +10 and -10 buttons" below).

- After the last file, the first file will be selected, and vice versa.

How to use the +10 and -10 buttons

- Ex. 1: To select file number 32 while playing file number 6

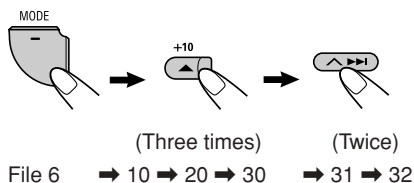

- Ex. 2: To select file number 8 while playing file number 36

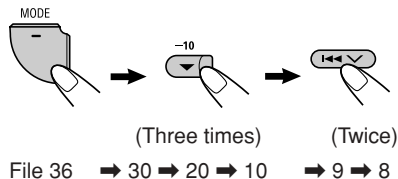

To go to a particular folder directly

IMPORTANT:

To directly select the folders using the number button(s), it is required that folders are assigned 2 digit numbers at the beginning of their folder names. (This can only be done during the recording of CD-Rs or CD-RWs.)

Ex.: If folder name is "01 ABC"

- Press 1 to go to Folder 01 ABC. If folder name is "1 ABC," pressing 1 does not work.

If folder name is "12 ABC"

- Press and hold 6 (12) to go to Folder 12 ABC.

Press the number button corresponding to the folder number to start playing the first file in the selected folder.

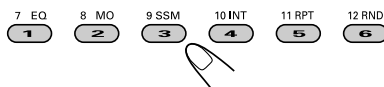

- To select a folder number from 01 – 06: Press 1 (7) – 6 (12) briefly.
- To select a folder number from 07 – 12: Press and hold 1 (7) – 6 (12) for more than one second.

Notes:

- If indicator flashes on the display after you have selected a folder, it means that the folder does not contain any MP3/WMA files.
- You cannot directly select a folder with a number greater than 12.

To select a particular file in a folder, press

▲▶▶ or ◀◀▼ after selecting the folder.

To skip to the next or previous folder

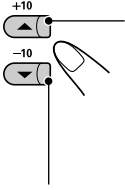

Press ▲ (up) while playing a disc to skip to the next folder.
Each time you press the button consecutively, the next folder is located (and the first file in the folder starts playing, if recorded).

Press ▼ (down) while playing a disc to skip back to the previous folder.

Each time you press the button consecutively, the previous folder is located (and the first file in the folder starts playing, if recorded).

Note:

If the folder does not contain any MP3/WMA files, it is skipped.

Selecting the playback modes

To play back files at random (Folder Random/Disc Random Play)

You can play back all files of the current folder or all files on the disc at random.

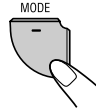

1 Press MODE to enter the functions mode while playing a disc.



2 Press RND (random), while "MODE" is still on the display, so that "FLDR RND" or "DISC RND" appears on the display. Each time you press the button, the random play mode changes as follows:

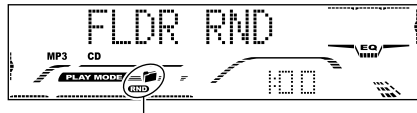

■ (folder) and RND indicators

Ex.: When you select "FLDR RND" while listening to an MP3 file

Mode	Active indicator	Plays at random
FLDR RND	■ and RND indicators light up.	All files of the current folder, then files of the next folder and so on.
DISC RND	● and RND indicators light up.	All files on the disc.

To play back files repeatedly (Track Repeat/Folder Repeat Play)

You can play back the current file or all the files in the current folder repeatedly.

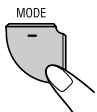

- 1 Press MODE to enter the functions mode while playing a disc.



- 2 Press RPT (repeat), while "MODE" is still on the display, so that "TRK RPT" or "FLDR RPT" appears on the display. Each time you press the button, the repeat play mode changes as follows:

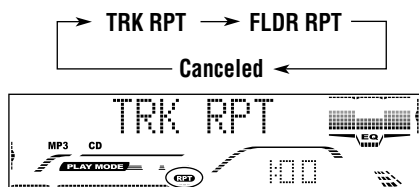

RPT indicator

Ex.: When you select "TRK RPT" while listening to an MP3 file

Mode	Active indicator	Plays repeatedly
TRK RPT	RPT indicator lights up.	The current (or specified) file.
FLDR RPT	and RPT indicators light up.	All files of the current (or specified) folder.

To play back only intros (Track Intro Scan/Folder Intro Scan)

You can play back the first 15 seconds of each file sequentially.

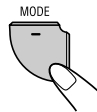

- 1 Press MODE to enter the functions mode while playing a disc.



- 2 Press INT (intro), while "MODE" is still on the display, so that "TRK INT" or "FLDR INT" appears on the display. Each time you press the button, the intro scan mode changes as follows:

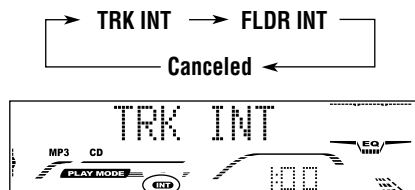

INT indicator

Ex.: When you select "TRK INT" while listening to an MP3 file

Mode	Active indicator	Plays the beginnings (15 seconds) of
TRK INT	INT indicator lights up.	All files on the current disc.
FLDR INT	and INT indicators light up.	The first file of every folder of the current disc.

SOUND ADJUSTMENTS

Adjusting the sound

You can adjust the sound characteristics to your preference.

1 Select the item you want to adjust.



Each time you press the button, the adjustable items change as follows:

For KD-AR800/KD-G800:

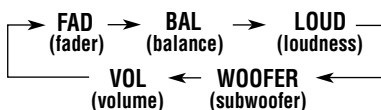

For KD-G700:

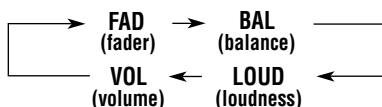

*1 If you are using a two-speaker system, set the fader level to "00."

*2 This takes effect only when a subwoofer is connected.

*3 Normally the control dial works as the volume control. So you do not have to select "VOL" to adjust the volume level.

*4 Depending on the amplifier gain control setting. (See page 30 for details.)

2 Adjust the setting.

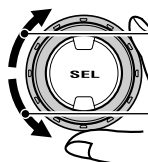

To increase the level or turn on the loudness

To decrease the level or turn off the loudness

Indication pattern changes as you adjust the fader or balance.

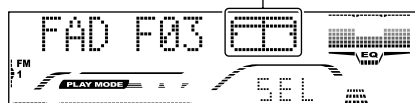

Ex. 1: When you adjust "FAD" (fader)

LOUD indicator



Ex. 2: When you turn on the loudness

Indication	To do:	Range
FAD*1	Adjust the front and rear speaker balance.	R06 (Rear only) F06 (Front only)
BAL	Adjust the left and right speaker balance.	L06 (Left only) R06 (Right only)
LOUD	Boost low and high frequencies to produce a well-balanced sound at low volume level.	LOUD ON LOUD OFF
WOOFER*2 (only for KD-AR800/ KD-G800)	Adjust the subwoofer output level.	00 (min.) 08 (max.)
VOL*3	Adjust the volume.	00 (min.) 30 or 50 (max.)*4

3 Repeat steps 1 and 2 to adjust the other items.



Selecting preset sound modes (iEQ: intelligent equalizer)

You can select a preset sound mode (iEQ: intelligent equalizer) suitable to the music genre.

- There is a time limit in doing the following procedure. If the setting is canceled before you finish, start from step 1 again.

1 Press MODE to enter the functions mode.

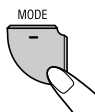

2 Press EQ (equalizer) while "MODE" is still on the display.



The last selected sound mode is called up.

3 Select the sound mode you want.



As you turn the control dial, the sound modes change as follows:

FLAT ⇄ HARD ROCK ⇄ R&B ⇄
 POP ⇄ JAZZ ⇄ DANCE MUSIC ⇄
 COUNTRY ⇄ REGGAE ⇄ CLASSIC ⇄
 USER 1 ⇄ USER 2 ⇄ USER 3 ⇄
 (back to the beginning)

Indication pattern changes for each sound mode.



Ex.: When you select "HARD ROCK"

To cancel the preset sound mode, select "FLAT" in step 3.

Notes:

- You can adjust the preset sound modes temporarily. However, your temporary adjustments will be reset when you select another sound mode.
- For details about the preset settings of each sound mode, see table on page 40.
- For showing the iEQ pattern on the display during play, select "EQ & LEVEL" or "SILENT" for the level meter. See also page 28.

When using the remote controller:



Press SOUND repeatedly. Each time you press the button, the sound modes change as follows:

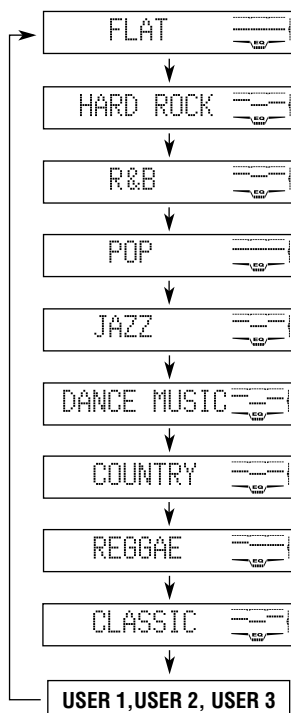

Storing your own sound adjustments

You can adjust the sound modes to your preference and store your own adjustments in memory (USER 1, USER 2 and USER 3).

- There is a time limit in doing the following procedure. If the setting is canceled before you finish, start from step **1** again.

1 Press MODE to enter the functions mode.

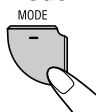

2 Press EQ (equalizer) while "MODE" is still on the display.



The last selected sound mode is called up.

3 Select the sound mode you want to adjust.

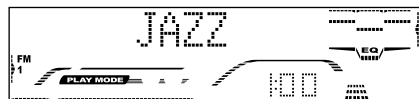

Ex.: When you select "JAZZ"

4 Select sound elements to adjust.



Each time you press the button, the sound elements change as follows:

LOW LEVEL* → LOW FREQ → LOW WIDTH
 → MID LEVEL* → MID WIDTH
 → HI (high) LEVEL* → HI (high) FREQ
 → (back to the beginning)

FREQ (LOW, HI):

Select the center frequency to adjust.

WIDTH (LOW, MID):

Select the band width level.

LEVEL (LOW, MID, HI):

Adjust the enhancement level.

- * By pressing \blacktriangle \blacktriangleright or \blacktriangleleft \blacktriangledown , you can directly move as follows:



5 Adjust the selected sound element.



Indication	Preset values		
	LOW	MID	HI
LEVEL	-06 (min.) +06 (max.)	-06 (min.) +06 (max.)	-06 (min.) +06 (max.)
FREQ.	60Hz 80Hz 100Hz 120Hz	_____	8kHz 10kHz 12kHz 15kHz
WIDTH	1 (min.) 4 (max.)	1 (min.) 2 (max.)	_____

6 Repeat steps 4 and 5 to adjust the other sound elements.

7 Select one of the user sound modes (USER 1, USER 2, USER 3).

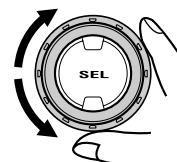

8 Press EQ to store the adjustments.



"MEMORY" appears for a while.



OTHER MAIN FUNCTIONS

ENGLISH

Changing the general settings (PSM)

You can change the items listed in the table on page 27 by using the PSM (Preferred Setting Mode) control.

Basic Procedure

- 1** Press and hold SEL (select) for more than 2 seconds so that one of the PSM items appears on the display. (See page 27.)



- 2** Select the PSM item you want to adjust.

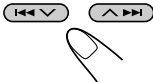

Ex.: When you select "DIMMER MODE"

- 3** Adjust the PSM item selected.



- 4** Repeat steps 2 and 3 to adjust the other PSM items if necessary.

- 5** Finish the setting.





Preferred Setting Mode (PSM) items

- For detailed operations of each PSM items, refer to the pages listed in the table.

Indications		Selectable values/items		Factory-preset settings	See page
DEMO MODE	Display demonstration	DEMO OFF	DEMO ON	DEMO ON	8
CLOCK HOUR	Hour adjustment	1 — 12		1 (1:00)	9
CLOCK MINUTE	Minute adjustment	00 — 59		00 (1:00)	
CLOCK DISP	Clock display	CLK DISP OFF	CLK DISP ON	CLK DISP ON	28
LEVELMETER	Level meter	LEVEL 1 ↔ LEVEL 2 ↓ ↓ SILENT ↔ EQ & LEVEL		LEVEL 1	28
DIMMER MODE	Dimmer mode	DIMMER AUTO ↔ DIMMER OFF ↙ ↘ DIMMER ON ↖		DIMMER AUTO	28
BEEP SWITCH	Key-touch tone	BEEP OFF	BEEP ON	BEEP ON	29
CONTRAST	Display contrast	01 — 10		05	29
SCROLL MODE	Scroll mode	SCROLL ONCE ↔ SCROLL AUTO ↙ ↘ SCROLL OFF ↖		SCROLL ONCE	29
WOOFER FREQ*1	Subwoofer cutoff frequency	FREQ MID ↔ FREQ HIGH ↙ ↘ FREQ LOW ↖		FREQ MID	29
LINE ADJ*2	Line input level adjustment	00 — 05		00	29
EXTERNAL IN*1, *4	External component	CHANGER ↔ LINE IN*3 ↙ ↘ SIRIUS ↖		CHANGER	30
TAG DISPLAY	Tag display	TAG DISP OFF	TAG DISP ON	TAG DISP ON	30
AMP. GAIN*5	Amplifier gain control	<i>KD-AR800:</i> HIGH POWER ↔ LOW POWER ↙ ↘ OFF ↖		HIGH POWER	30
		<i>KD-G800/KD-G700:</i> LOW POWER ↔ HIGH POWER			
SLOT LIGHT	Slot light	OFF	ON	ON	30

*1 Only for KD-AR800/KD-G800.

*2 Only for KD-AR800.

*3 Only for KD-G800.

*4 Displayed only when one of the following sources is selected—FM, AM, and CD.

*5 Depending on the amplifier gain control setting. (See page 30 for details.)



To set the clock display—CLOCK DISP

You can set the clock to be shown on the lower part of the display when the unit is turned on. When shipped from the factory, the clock is set to be shown on the display.

- CLK DISP ON: Clock display is turned on.
- CLK DISP OFF: Clock display is turned off. When “CLK DISP OFF” is selected, the current source name, station band, or disc number appears instead of the clock display (except when “LINE IN” or “SIRIUS” is selected as the source—for KD-AR800/KD-G800).

When “CLOCK DISP” is set to “CLK DISP OFF”:

Source	Initial indication	Pressing DISP (display)
Tuner	Band	Clock appears for about 5 seconds.
CD or CD-CH	CD, folder number, or disc number	

When “CLOCK DISP” is set to “CLK DISP ON”:

Source	Initial indication	Pressing DISP (display) repeatedly
Tuner	Clock	Station frequency or band number appears for about 5 seconds.
CD	Clock	CD, or track/file/folder number appears for about 5 seconds.
CD-CH	Clock	Disc number, or track/file/folder number appears for about 5 seconds.

To select the level meter—LEVELMETER

You can select the level meter display according to your preference. When shipped from the factory, this mode is set to “LEVEL 1.”

- LEVEL 1/LEVEL 2: Display the audio level meter with different illumination pattern.
- EQ & LEVEL: Display the equalizer pattern and the audio level meter.
- SILENT: Display the equalizer pattern and volume level meter.

To select the dimmer mode—DIMMER MODE

When you turn on the car headlights, the display automatically dims (Auto Dimmer). When shipped from the factory, Auto Dimmer mode is activated.

- DIMMER AUTO: Activates Auto Dimmer.
- DIMMER OFF: Cancels Auto Dimmer.
- DIMMER ON: Always dims the display.

Note:

Auto Dimmer equipped with this unit may not work correctly on some vehicles, particularly on those having a control dial for dimming.

In this case, set the dimmer mode to “DIMMER ON” or “DIMMER OFF.”



To turn the key-touch tone on or off —BEEP SWITCH

You can deactivate the key-touch tone if you do not want it to beep each time you press a button. When shipped from the factory, the key-touch tone is activated.

- BEEP ON: Activates the key-touch tone.
- BEEP OFF: Deactivates the key-touch tone.

To adjust the display contrast level —CONTRAST

Adjust the display contrast (01 – 10) to make the display indications clear and legible. When shipped from the factory, the display contrast level is set at level 05.

To select the scroll mode—SCROLL MODE

You can select the scroll mode for the disc information (when the entire text cannot be shown at a time).

When shipped from the factory, scroll mode is set to “SCROLL ONCE.”

- SCROLL ONCE: Scrolls only once.
- SCROLL AUTO: Repeats the scroll (5-second intervals in between).
- SCROLL OFF: Cancels scroll mode.

Note:

Even if the scroll mode is set to “SCROLL OFF,” you can scroll the display by pressing DISP (display) for more than 1 second.

To select the subwoofer cutoff frequency —WOOFER FREQ (Only for KD-AR800/KD-G800)

When a subwoofer is connected to this unit, select an appropriate cutoff frequency level for your subwoofer.

When shipped from the factory, the subwoofer cutoff frequency is set to “FREQ MID.”

- FREQ LOW: Frequencies higher than 50 Hz are cut off to the subwoofer.
- FREQ MID: Frequencies higher than 80 Hz are cut off to the subwoofer.
- FREQ HIGH: Frequencies higher than 120 Hz are cut off to the subwoofer.

To adjust the line input level —LINE ADJ (Only for KD-AR800)

Adjust the line input level properly when an external component is connected to the LINE IN plugs.

When shipped from the factory, the line input level is set at level 00.

If the input level of the connected component is not high enough, increase the input level properly. Without adjusting the line input level, you may be surprised at a loud sound when you change the source from the external component to another source.



To select the external component to use —EXTERNAL IN (only for KD-AR800/KD-G800)

You can connect the external component to the CD changer jack on the rear using an adapter specially designed for the external component. When shipped from the factory, CD changer is selected as the external component.

- CHANGER: To use the CD changer.
- LINE IN: To use the external component other than CD changer (only for KD-G800).
- SIRIUS: To use the JVC SIRIUS Radio.

Notes:

- Only for KD-G800: For connecting the Line Input Adapter KS-U57 and the external component, refer to the Installation/Connection Manual (separate volume).
- For connecting the JVC SIRIUS Radio, refer to the SIRIUS Radio Setup Manual (separate volume).

To turn the tag display on or off —TAG DISPLAY

An MP3/WMA file can contain file information called "ID3 Tag" where its album name, performer, track title, etc. are recorded. There are two versions—ID3v1 (ID3 Tag version 1) and ID3v2 (ID3 Tag version 2). If both ID3v1 and ID3v2 are recorded on a disc, ID3v2 information will be shown. When shipped from the factory, "TAG DISP ON" is selected.

- TAG DISP ON: Turns on the ID3 tag display while playing MP3/WMA files.
 - If an MP3/WMA file does not have ID3 tags, folder name and file name appear.

Note:

Only for KD-AR800/KD-G800:
If you change the setting from "TAG DISP OFF" to "TAG DISP ON" while playing an MP3/WMA file, the tag display will be activated when the next file starts playing.

- TAG DISP OFF: Turns off the ID3 tag display while playing MP3/WMA files. (Only the folder name and file name can be shown.)

To select the amplifier gain control —AMP.GAIN

You can change the maximum volume level of this unit. When the maximum power of the speakers is less than 50 W, select "LOW POWER" to prevent them from being damaged. When shipped from the factory, "HIGH POWER" is selected.

- LOW POWER: You can adjust the volume level from "VOL 00" to "VOL 30."

Note:

If you change the setting from "HIGH POWER" to "LOW POWER" while listening at a volume level more than 30, the unit automatically changes the volume level to "VOL 30."

- HIGH POWER: You can adjust the volume level from "VOL 00" to "VOL 50."
- OFF: Only for KD-AR800: Deactivates the built-in amplifier. (Sounds come out only from external amplifiers connected to Line Out plugs).

To turn the slot light on or off —SLOT LIGHT

You can turn off the slot light if you do not want the illumination each time you insert/eject the disc or when you change the control panel angle. When shipped from the factory, slot illumination is activated.

- ON: Activates the illumination.
- OFF: Deactivates the illumination.



Assigning names to the sources

You can assign names to station frequencies, CDs (both in this unit and in the CD changer), and external component (Line Input—only for KD-AR800).

After assigning a name, it will appear on the display when you select the source.

Sources	Maximum number of characters
Station frequencies	Up to 9 characters (up to 30 station frequencies including both FM and AM)
CDs*1	Up to 32 characters (up to 40 discs)
External component (Line Input)*2	Up to 12 characters

*1 You cannot assign a name to a CD Text or an MP3/WMA disc.

*2 Only for KD-AR800.

1 Select a source you want to assign a name to.

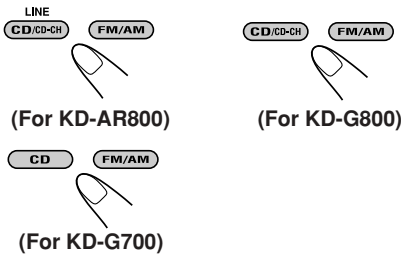

When you select a source, the power automatically comes on.

2 While pressing DISP (display), press and hold SEL (select) for more than 2 seconds.

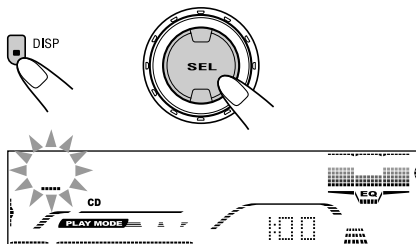

3 Select the character set you want while the first character position is flashing.

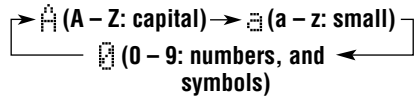
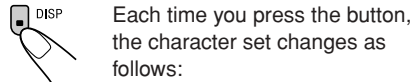

4 Select a character.

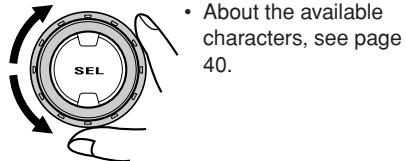

5 Move the cursor to the next (or previous) character position.

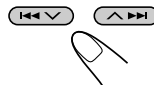

6 Repeat steps 3 to 5 until you finish entering the name.

7 Finish the procedure while the last selected character is flashing.



To erase the input characters

To erase all the characters at a time, press and hold DISP (display) for more than 1 second as described in the procedure above.

Notes:

- When you try to assign a name to a 41st disc or to the 31st station frequency, "NAME FULL" appears and you cannot enter the text entry mode. In this case, delete unwanted names before assignment.
- Only for KD-AR800/KD-G800: When the CD changer is connected, you can assign names to CDs in the CD changer. These names can also be shown on the display if you insert the CDs in this unit.



Changing the control panel angle

You can change the angle of the control panel in four positions.

Press  (angle) repeatedly to adjust the angle of the control panel to the position you want.

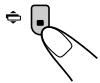

The control panel angles changes as follows:

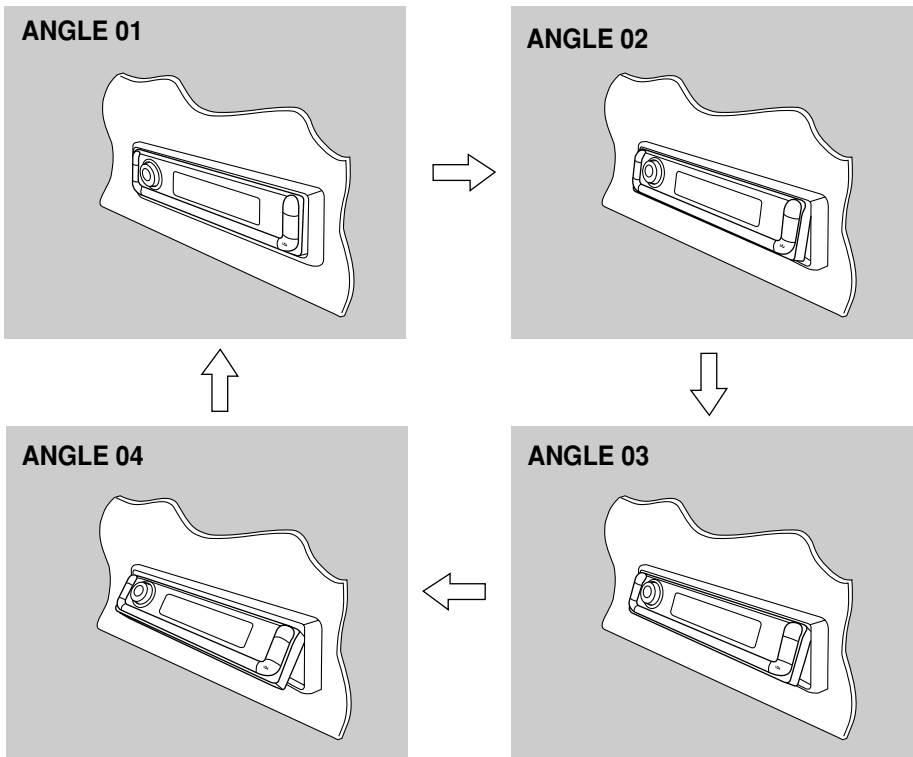

CAUTION:

NEVER insert your finger in between the control panel and the unit, as it may get caught or hurt.

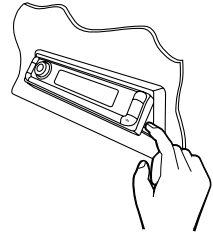

Note:

If you turn the power off, the control panel automatically returns to the closed position. Next time you turn on the power, the control panel moves to its previous position.



Detaching the control panel

You can detach the control panel when leaving the car.

When detaching or attaching the control panel, be careful not to damage the connectors on the back of the control panel and on the panel holder.

Detaching the control panel

Before detaching the control panel, be sure to turn off the power.

1 Unlock the control panel.

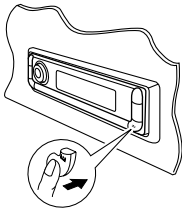

2 Lift and pull the control panel out of the unit.

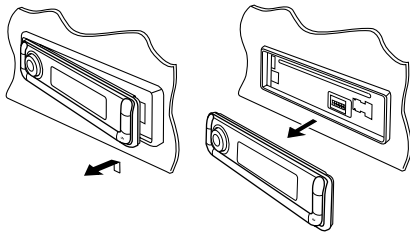

3 Put the detached control panel into the provided case.

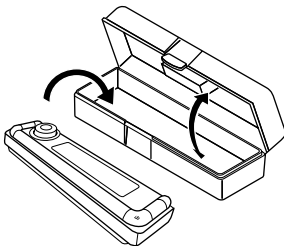

Attaching the control panel

1 Insert the left side of the control panel into the groove on the panel holder.

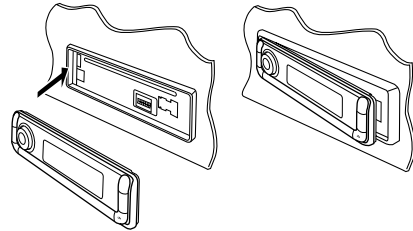

2 Press the right side of the control panel to fix it to the panel holder.

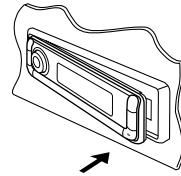

Note on cleaning the connectors:

If you frequently detach the control panel, the connectors will deteriorate.

To minimize this possibility, periodically wipe the connectors with a cotton swab or cloth moistened with alcohol, being careful not to damage the connectors.

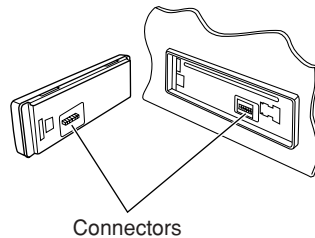

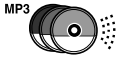

CD CHANGER OPERATIONS

ENGLISH

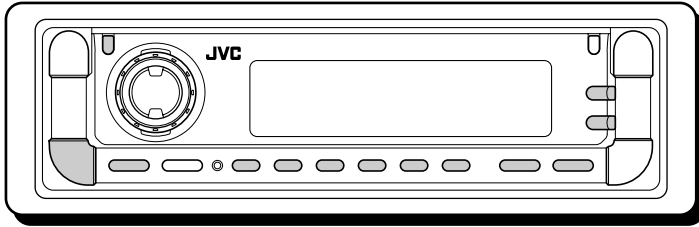

This section is only for KD-AR800/KD-G800.

We recommend that you use the JVC MP3-compatible CD changer with your unit.

By using this CD changer, you can play back your original CD-Rs (Recordable) and CD-RWs (Rewritable) recorded either in audio CD format or in MP3 format.

- You can also connect other CH-X series CD changers (except CH-X99 and CH-X100). However, they are not compatible with MP3 discs, so you cannot play back MP3 discs.
- You cannot use the KD-MK series CD changers with this unit.

Before operating your CD changer:

- Refer also to the Instructions supplied for your CD changer.
- If no discs are in the magazine of the CD changer or the discs are inserted upside down, "NO DISC" will appear on the display. If this happens, remove the magazine and set the discs correctly.
- If no magazine is loaded in the CD changer, "NO MAG" appears on the display. If this happens, insert the magazine in the CD changer.
- If "RESET 1" – "RESET 8" appears on the display, something is wrong with the connection between this unit and the CD changer. If this happens, check the connection and make sure the cords are connected firmly. Then, press the reset button of the CD changer.

Note:

You cannot control and play any WMA disc on the CD changer.

Playing discs

Select the CD changer (CD-CH).

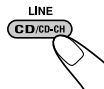

(For KD-AR800)

CD ↔ CD-CH



(For KD-G800)

* For CD changer setting, see "To select the external component to use—EXTERNAL IN" on page 30 for details.

- When the current disc is an MP3 disc:

Playback starts from the first folder of the current disc once file check is completed.



Selected disc number*

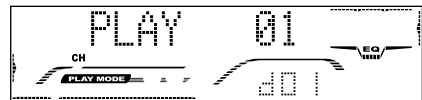

(folder) indicator



MP3 indicator

Selected folder number

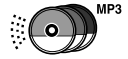

* When "CLOCK DISP" is set to "CLK DISP ON" (see page 28), the current indication will soon change to the clock time.

Note:

Folder name appears on the display instead of "ROOT," if an MP3 disc contains a folder.

• When the current disc is a CD:

Playback starts from the first track of the current disc.



Selected disc number ↓

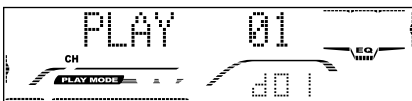

Elapsed playing time Current track number ↓



* When "CLOCK DISP" is set to "CLK DISP ON" (see page 28), the current indication will soon change to the clock time.

Notes:

- When you press CD/CD-CH LINE (for KD-AR800) or CD/CD-CH (for KD-G800), the power automatically comes on. You do not have to press **⏻/ATT** to turn on the power.
- If you change the source, CD changer play also stops. Next time you select the CD as the source, CD changer play starts from where playback has been stopped previously.
- When you start playing back a CD Text or MP3 disc, disc information will automatically appear on the display. (See pages 16 and 19.)

To go to a particular disc directly

Press the number button corresponding to the disc number to start its playback (while the CD changer is playing).

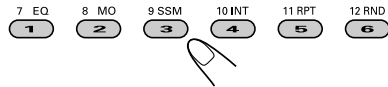

- To select a disc number from 1 – 6: Press 1 (7) – 6 (12) briefly.
- To select a disc number from 7 – 12: Press and hold 1 (7) – 6 (12) for more than one second.

To fast-forward or reverse the track/file

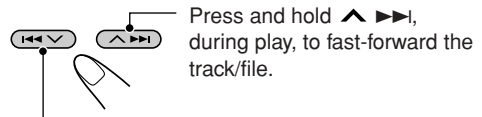

Press and hold **⏩**, during play, to fast-forward the track/file.

Press and hold **⏮**, during play, to reverse the track/file.

Note:

During this operation on an MP3 disc, you can only hear intermittent sounds. (The elapsed playing time also changes intermittently on the display.)

To go to the next or previous tracks/files

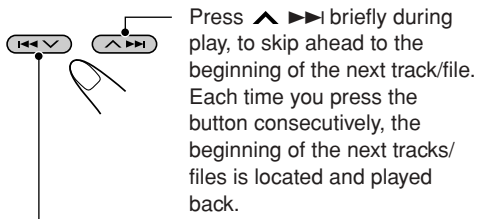

Press **⏭** briefly during play, to skip ahead to the beginning of the next track/file. Each time you press the button consecutively, the beginning of the next tracks/files is located and played back.

Press **⏪** briefly during play, to skip back to the beginning of the current track/file. Each time you press the button consecutively, the beginning of the previous tracks/files is located and played back.

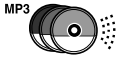

This operation is only possible when using JVC MP3-compatible CD changer (CH-X1500).

To go to a track/file quickly (+10 and -10 buttons)

- 1 Press MODE to enter the functions mode while playing a disc.

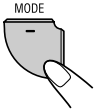

- 2 Press +10 or -10.

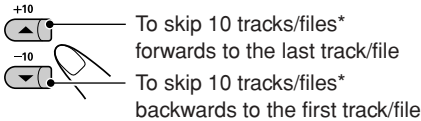

* First time you press +10 or -10 button, the track/file skips to the nearest higher or lower track/file with a track/file number of multiple ten (ex. 10th, 20th, 30th).

Then each time you press the button, you can skip 10 tracks/files (see "How to use the +10 and -10 buttons" below).

- After the last track/file, the first track/file will be selected, and vice versa.

Note:

If the current playing disc is an MP3 disc, files are skipped within the same folder.

How to use the +10 and -10 buttons

- Ex. 1: To select track/file number 32 while playing track/file number 6

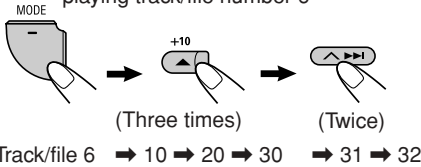

- Ex. 2: To select track/file number 8 while playing track/file number 36

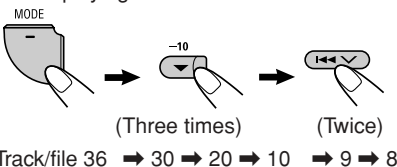

To skip to the next or previous folder (only for MP3 discs)

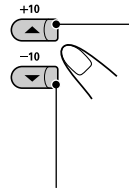

Press ▼ (down) while playing an MP3 disc, to go to the previous folder. Each time you press the button consecutively, the previous folder is located, and the first file in the folder starts playback.

Press ▼ (down) while playing an MP3 disc, to go to the previous folder. Each time you press the button consecutively, the previous folder is located, and the first file in the folder starts playback.

To show the disc information for CD Text and MP3 discs

This is possible only when connecting a JVC CD changer equipped with CD Text and/or MP3 disc information reading capability.

Select text display mode while playing a CD Text or an MP3 disc.



- For details, see page 16 about CD Text disc information and page 19 about MP3 disc information.



Selecting the playback modes

To play back tracks/files at random (Folder Random/Disc Random/Magazine Random Play)

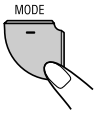

1 Press MODE to enter the functions mode while playing a disc.



2 Press RND (random), while "MODE" is still on the display. Each time you press the button, the random play mode changes as follows:

For MP3 discs:

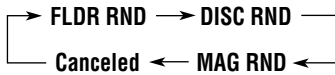

For CDs:



RND indicator

Ex.: When you select "MAG RND"

Note:

MP3 indicator also lights up if the current playing disc is an MP3 disc.

Mode	Active indicator	Plays at random
FLDR RND*	☐ and RND indicators light up.	All files of the current folder, then files of the next folder and so on.
DISC RND	● and RND indicators light up.	All tracks/files of the current (or specified) disc.
MAG RND	RND indicator lights up.	All tracks/files of the inserted discs.

* "FLDR RND" is only applicable for MP3 disc.

To play back tracks/files repeatedly (Track Repeat/Folder Repeat/Disc Repeat Play)

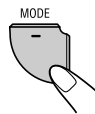

1 Press MODE to enter the functions mode while playing a disc.



2 Press RPT (repeat), while "MODE" is still on the display. Each time you press the button, the repeat play mode changes as follows:

For MP3 discs:

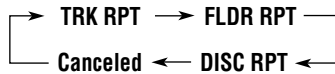

For CDs:



● (disc) and RPT indicators

Ex.: When you select "DISC RPT"

Note:

MP3 indicator also lights up if the current playing disc is an MP3 disc.

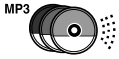

Mode	Active indicator	Plays repeatedly
TRK RPT	RPT indicator lights up.	The current (or specified) track/file.
FLDR RPT*	and RPT indicators light up.	All files of the current (or specified) folder of the current disc.
DISC RPT	and RPT indicators light up.	All tracks/files of the current (or specified) disc.

* "FLDR RPT" is only applicable for MP3 disc.

To play back only intros (Track Intro Scan/Folder Intro Scan/Disc Intro Scan)

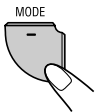

1 Press MODE to enter the functions mode while playing a disc.



2 Press INT (intro), while "MODE" is still on the display. Each time you press the button, the intro scan mode changes as follows:

For MP3 discs:

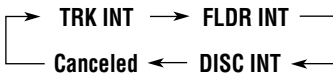

For CDs:

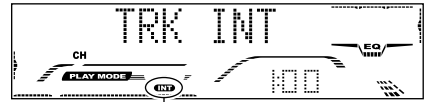

INT indicator

Ex.: When you select "TRK INT"

Note:

MP3 indicator also lights up if the current playing disc is an MP3 disc.

Mode	Active indicator	Plays the beginnings (15 seconds) of
TRK INT	INT indicator lights up.	All tracks/files of the current disc.
FLDR INT*	and INT indicators light up.	The first file of every folder of the current disc.
DISC INT	and INT indicators light up.	The first tracks/files of the inserted discs.

* "FLDR INT" is only applicable for MP3 disc.

EXTERNAL COMPONENT OPERATIONS

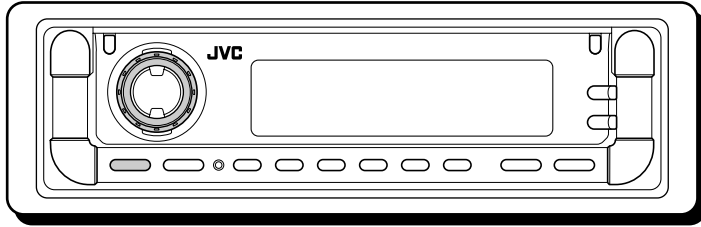

This section is only for KD-AR800/KD-G800.

Playing an external component

For KD-AR800:

You can connect an external components to the LINE IN plugs on the rear.

- You can also connect the SIRIUS tuner to the CD changer jack on the rear and select it as the external component.

For KD-G800:

You can connect the external component to the CD changer jack on the rear using the adapter specially designed for the external component.

- Before operating the external component, select the "EXTERNAL IN" setting correctly (see page 30).
- To use the JVC SIRIUS Radio, refer to the SIRIUS Radio Setup Manual (separate volume).

1 Select the external component (LINE IN/SIRIUS).

For KD-AR800:

Press CD/CD-CH LINE repeatedly.



To select LINE IN, press and hold CD/CD-CH LINE.

For KD-G800:

Press CD/CD-CH repeatedly.



Note on One-Touch Operation:

When you press CD/CD-CH LINE (for KD-AR800) or CD/CD-CH (for KD-G800), the power automatically comes on. You do not have to press P/I ATT to turn on the power.

2 Turn on the connected component and start playing the source.

3 Adjust the volume.



4 Adjust the sound as you want. (See pages 23 – 25.)



ADDITIONAL INFORMATION

ENGLISH

Sound modes (preset frequency level settings)

The list below shows the preset frequency level settings for each sound mode.

Sound Mode	Preset equalizing values						
	LOW LEVEL	LOW FREQ	LOW WIDTH	MID LEVEL	MID WIDTH	HI LEVEL	HI FREQ
FLAT	00	60Hz	1	00	1	00	8kHz
HARD ROCK	+03	120Hz	4	00	1	+02	8kHz
R&B	+03	80Hz	1	+01	1	+03	15kHz
POP	+02	120Hz	1	+01	1	+02	10kHz
JAZZ	+03	80Hz	1	00	1	+03	10kHz
DANCE MUSIC	+04	60Hz	2	-02	2	+01	8kHz
COUNTRY	+02	60Hz	3	00	1	+02	12kHz
REGGAE	+03	60Hz	1	+02	1	+02	12kHz
CLASSIC	+01	80Hz	1	00	1	+03	10kHz
USER 1	00	60Hz	1	00	1	00	8kHz
USER 2	00	60Hz	1	00	1	00	8kHz
USER 3	00	60Hz	1	00	1	00	8kHz

Available characters

You can use the following characters to assign names to station frequencies, CDs (both in this unit and in the CD changer), and external component (Line Input—only for KD-AR800). (See page 31.)

- These characters can be also used to show other information such as disc title/performer on the display.

Capital letters

A	B	C	D	E
F	G	H	I	J
K	L	M	N	O
P	Q	R	S	T
U	V	W	X	Y
Z	space			

Small letters

a	b	c	d	e
f	g	h	i	j
k	l	m	n	o
p	q	r	s	t
u	v	w	x	y
z	space			

Numbers and symbols

0	1	2	3	4
5	6	7	8	9
!	"	#	\$	%
&	'	()	*
+	,	-	.	/
:	;	<	=	>
?	@	_	`	space

TROUBLESHOOTING

What appears to be trouble is not always serious. Check the following points before calling a service center.

	Symptoms	Causes	Remedies
General	<ul style="list-style-type: none"> Sound cannot be heard from the speakers. 	The volume level is set to the minimum level.	Adjust it to the optimum level.
		Connections are incorrect.	Check the cords and connections.
	<ul style="list-style-type: none"> This unit does not work at all. 	The built-in microcomputer may have functioned incorrectly due to noise, etc.	Press the reset button on the control panel. (The clock setting and preset stations stored in memory are erased.) (See page 2.)
FM/AM	<ul style="list-style-type: none"> SSM (Strong-station Sequential Memory) automatic preset does not work. 	Signals are too weak.	Store stations manually.
	<ul style="list-style-type: none"> Static noise while listening to the radio. 	The antenna is not connected firmly.	Connect the antenna firmly.
Disc Playback	<ul style="list-style-type: none"> Disc cannot be played back. 	Disc is inserted upside down.	Insert the disc correctly.
	<ul style="list-style-type: none"> CD-R/CD-RW cannot be played back. Tracks on the CD-R/CD-RW cannot be skipped. 	CD-R/CD-RW is not finalized.	<ul style="list-style-type: none"> Insert a finalized CD-R/CD-RW. Finalize the CD-R/CD-RW with the component which you used for recording.
		Disc cannot be ejected.	Disc is locked.
	<ul style="list-style-type: none"> Disc sound is sometimes interrupted. 	You are driving on rough roads.	Stop playback while driving on rough roads.
		Disc is scratched.	Change the disc.
		Connections are incorrect.	Check the cords and connections.
	<ul style="list-style-type: none"> Disc cannot be recognized ("NO DISC" appears on the display). 	No disc in the loading slot.	Insert a disc into the loading slot.
		Disc is inserted incorrectly.	Insert the disc correctly.
The unit may have functioned incorrectly.		While pressing CD/CD-CH LINE (for KD-AR800) or CD/CD-CH (for KD-G800) or CD (for KD-G700), press and hold SEL (select) for more than 2 seconds to eject the disc.	
<ul style="list-style-type: none"> When "PUSH RESET" appears on the display. 	There is something blocking the control movement.	Press the reset button on the control panel. (See page 2.) If the reset button does not work, check the Installation/Connection Manual (separate volume). (Ex.: You have used a longer screw than specified.)	



	Symptoms	Causes	Remedies
MP3/WMA Playback	<ul style="list-style-type: none"> Disc cannot be played back. 	No MP3/WMA files are recorded on the disc.	Change the disc.
		MP3/WMA files do not have the extension code <.mp3> or <.wma> in their file names.	Add the extension code <.mp3> or <.wma> to their file names.
		MP3/WMA files are not recorded in the format compliant with ISO 9660 Level 1, Level 2, Romeo, or Joliet.	Change the disc. (Record MP3/WMA files using a compliant application.)
	<ul style="list-style-type: none"> Noise is generated. 	The file played back is not an MP3/WMA file (although it has the extension code <.mp3> or <.wma>).	Skip to another file or change the disc. (Do not add the extension code <.mp3> or <.wma> to non-MP3 or non-WMA files.)
	<ul style="list-style-type: none"> A longer readout time is required ("FILE CHECK" keeps flashing on the display). 	Readout time varies due to the complexity of the folder/file configuration.	Do not use too many hierarchies and folders.
	<ul style="list-style-type: none"> Files cannot be played back as you have intended them to play. 	Playback order is determined when the files are recorded.	_____
	<ul style="list-style-type: none"> Elapsed playing time is not correct. 	This sometimes occurs during play. This is caused by how the files are recorded on the disc.	_____
	<ul style="list-style-type: none">  indicator flashes on the display. 	The current folder does not contain any MP3/WMA file.	Select another folder.
<ul style="list-style-type: none"> "NO FILES" appears on the display. 	The current disc does not contain any MP3/WMA file.	Insert a disc that contains MP3/WMA files.	
<ul style="list-style-type: none"> Correct characters are not displayed (e.g. album name). 	This unit can only display alphabets (capital: A–Z, small: a–z), numbers, and a limited number of symbols.	_____	



This section is only for KD-AR800/KD-G800

Symptoms	Causes	Remedies
• “NO DISC” appears on the display.	No disc is in the magazine.	Insert discs into the magazine.
	Discs are inserted upside down.	Insert discs correctly.
• “NO MAG” appears on the display.	No magazine is loaded in the CD changer.	Insert the magazine.
• “RESET 8” appears on the display.	This unit is not connected to the CD changer correctly.	Connect this unit and the CD changer correctly and press the reset button of the CD changer.
• “RESET 1” – “RESET 7” appears on the display.	_____	Press the reset button of the CD changer.
• The CD changer does not work at all.	The built-in microcomputer may function incorrectly due to noise, etc.	Press the reset button on the the control panel. (The clock setting and preset stations stored in memory are erased.) (See page 2.)

CD Changer

About mistracking:

Mistracking may result from driving on extremely rough roads. This does not damage the unit and the disc, but will be annoying.

We recommend that you stop disc play while driving on such rough roads.



MAINTENANCE

Handling discs

This unit has been designed to reproduce CDs, CD-Rs (Recordable), CD-RWs (Rewritable), and CD Texts.

- **This unit is also compatible with MP3 and WMA discs.**

How to handle discs

When removing a disc from its case, press down the center holder of the case and lift the disc out, holding it by the edges.

Center holder



- Always hold the disc by the edges. Do not touch its recording surface.

When storing a disc into its case, gently insert the disc around the center holder (with the printed surface facing up).

- Make sure to store discs into the cases after use.

To keep discs clean

A dirty disc may not be played correctly. If a disc does become dirty, wipe it with a soft cloth in a straight line from center to edge.



To play new discs

New discs may have some rough spots around the inner and outer edges. If such a disc is used, this unit may reject the disc.



To remove these rough spots, rub the edges with a pencil or ball-point pen, etc.

Moisture condensation

Moisture may condense on the lens inside the CD player in the following cases:

- After starting the heater in the car.
- If it becomes very humid inside the car.

Should this occur, the CD player may malfunction. In this case, eject the disc and leave the unit turned on for a few hours until the moisture evaporates.

When playing a CD-R or CD-RW

Before playing back CD-Rs or CD-RWs, read their instructions or cautions carefully.

- Use only "finalized" CD-Rs or CD-RWs.
- Some CD-Rs or CD-RWs may not be played back on this unit because of their disc characteristics, and for the following reasons:
 - Discs are dirty or scratched.
 - Moisture condensation on the lens inside the unit.
 - The pickup lens inside the unit is dirty.
- CD-RWs may require a longer readout time since the reflectance of CD-RWs is lower than that of regular CDs.
- CD-Rs or CD-RWs are susceptible to high temperatures or high humidity, so do not leave them inside your car.
- Do not use following CD-Rs or CD-RWs:
 - Discs with stickers, labels, or protective seal stuck to the surface.
 - Discs on which labels can be directly printed by an ink jet printer.

Using these discs under high temperatures or high humidity may cause malfunctions or damage to discs. For example,

- Stickers or labels may shrink and warp a disc.
- Stickers or labels may be peeled off so discs cannot be ejected.
- Print on discs may get sticky.

Read instructions or cautions about labels and printable discs carefully.

CAUTIONS:

- Do not insert 8 cm (3-3/16") discs (single CDs) into the loading slot. (Such discs cannot be ejected.)
- Do not insert any disc of unusual shape—like a heart or flower; otherwise, it will cause a malfunction.
- Do not expose discs to direct sunlight or any heat source or place them in a place subject to high temperature and humidity. Do not leave them in a car.
- Do not use any solvent (for example, conventional record cleaner, spray, thinner, benzine, etc.) to clean discs.

Warped disc



Sticker



Sticker residue

Disc



Stick-on label

SPECIFICATIONS

AUDIO AMPLIFIER SECTION

Maximum Power Output:
Front: 50 W per channel
Rear: 50 W per channel

Continuous Power Output (RMS):
Front: 19 W per channel into 4 Ω , 40 Hz to 20 000 Hz at no more than 0.8% total harmonic distortion.
Rear: 19 W per channel into 4 Ω , 40 Hz to 20 000 Hz at no more than 0.8% total harmonic distortion.

Load Impedance: 4 Ω (4 Ω to 8 Ω allowance)

Equalizer Control Range
Low: ± 12 dB (60 Hz, 80 Hz, 100 Hz, 120 Hz)
Mid: ± 12 dB
High: ± 12 dB (8 kHz, 10 kHz, 12 kHz, 15 kHz)

Frequency Response: 40 Hz to 20 000 Hz
Signal-to-Noise Ratio: 70 dB

Line-In Level/Impedance:
KD-AR800: 1.5 V/20 k Ω load

Line-Out Level/Impedance:
KD-AR800: 5.0 V/20 k Ω load (full scale)
KD-G800: 4.0 V/20 k Ω load (full scale)
KD-G700: 2.5 V/20 k Ω load (full scale)

Output Impedance: 1 k Ω

Subwoofer-Out Level/Impedance:
KD-AR800/KD-G800:
2.0 V/20 k Ω load (full scale)

TUNER SECTION

Frequency Range:
FM: 87.5 MHz to 107.9 MHz
AM: 530 kHz to 1 710 kHz

[FM Tuner]

Usual Sensitivity: 11.3 dBf (1.0 μ V/75 Ω)
50 dB Quieting Sensitivity:
16.3 dBf (1.8 μ V/75 Ω)
Alternate Channel Selectivity (400 kHz):
65 dB
Frequency Response: 40 Hz to 15 000 Hz
Stereo Separation: 35 dB
Capture Ratio: 1.5 dB

[AM Tuner]

Sensitivity: 20 μ V
Selectivity: 35 dB

CD PLAYER SECTION

Type: Compact disc player
Signal Detection System: Non-contact optical pickup (semiconductor laser)
Number of channels: 2 channels (stereo)
Frequency Response: 5 Hz to 20 000 Hz
Dynamic Range: 96 dB
Signal-to-Noise Ratio: 98 dB
Wow and Flutter: Less than measurable limit
MP3 decoding format:
MPEG1/2 Audio Layer 3
Max. Bit Rate: 320 Kbps
WMA (Windows Media[®] Audio) decoding format:
Max. Bit Rate: 192 Kbps

GENERAL

Power Requirement
Operating Voltage:
DC 14.4 V (11 V to 16 V allowance)

Grounding System: Negative ground
Allowable Operating Temperature:
0°C to +40°C (32°F to 104°F)

Dimensions (W \times H \times D):
Installation Size (approx.):
182 mm \times 52 mm \times 159 mm
(7-3/16" \times 2-1/16" \times 6-5/16")
Panel Size (approx.):
188 mm \times 58 mm \times 12 mm
(7-7/16" \times 2-5/16" \times 1/2")
Mass (approx.):
1.5 kg (3.4 lbs) (excluding accessories)

Design and specifications are subject to change without notice.

If a kit is necessary for your car, consult your telephone directory for the nearest car audio speciality shop.



JVC

**MOBILE
ENTERTAINMENT**

<http://www.jvcmobile.com>

Visit us on-line for

Technical Support & Customer Satisfaction Survey.

US RESIDENTS ONLY

**Having TROUBLE with operation?
Please reset your unit**

**Refer to page of How to Reset
Still having trouble??**

USA ONLY

Call 1-800-252-5722

<http://www.jvc.com>

We can help you!

JVC

VICTOR COMPANY OF JAPAN, LIMITED



EN, SP, FR
© 2003 VICTOR COMPANY OF JAPAN, LIMITED

1203KKSMJTJEIN



CAUTION

**CONNECT BLACK WIRE (① GND) TO GROUND FIRST.
OTHERWISE, DAMAGE TO YOUR UNIT MAY OCCUR.**

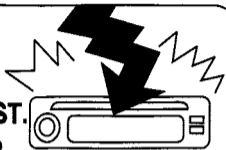

CAUTION

**INCORRECT CONNECTION CAUSES SERIOUS
DAMAGE TO THIS UNIT.**

**PLEASE READ INSTALLATION/CONNECTION
MANUAL CAREFULLY.**

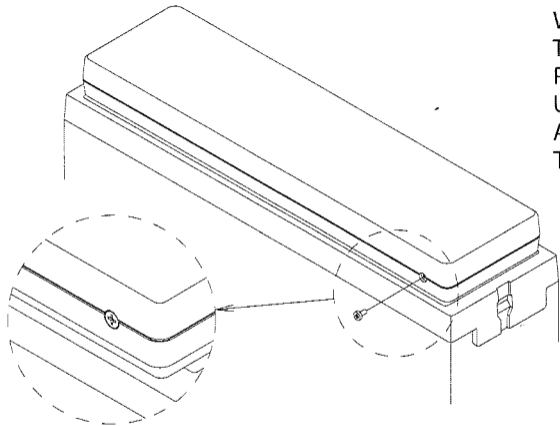

WHEN IT IS NOT REQUIRED
TO DETACH THE FRONT CONTROL
PANEL FROM THE MAIN UNIT,
USE THE PROVIDED SCREW TO
ATTACH THE CONTROL PANEL TO
THE MAIN UNIT.

GE40209-001A

JVC KD-AR800/KD-G800/KD-G700

Installation/Connection Manual Manual de instalación/conexión Manuel d'installation/raccordement

GET0197-002A
[J]

1203KKSMdTJEIN
EN, SP, FR

ENGLISH

ESPAÑOL

FRANÇAIS

This unit is designed to operate on **12 V DC, NEGATIVE ground electrical systems**. If your vehicle does not have this system, a voltage inverter is required, which can be purchased at JVC car audio dealers.

Esta unidad está diseñada para funcionar con **12 V de CC, con sistemas eléctricos de masa NEGATIVA**. Si su vehículo no posee este sistema, será necesario un inversor de tensión, que puede ser adquirido en los concesionarios de JVC de equipos de audio para automóviles.

Cet appareil est conçu pour fonctionner sur des sources de courant continu de **12 V à masse NEGATIVE**. Si votre véhicule n'offre pas ce type d'alimentation, il vous faut un convertisseur de tension, que vous pouvez acheter chez un revendeur d'autoradios JVC.

Parts list for installation and connection

The following parts are provided with this unit. After checking them, please set them correctly.

Lista de piezas para instalación y conexión

Con esta unidad se suministran las siguientes piezas. Después de inspeccionarlas, colóquelas correctamente.

Liste des pièces pour l'installation et raccordement

Les pièces suivantes sont fournies avec cet appareil. Après vérification, veuillez les placer correctement.

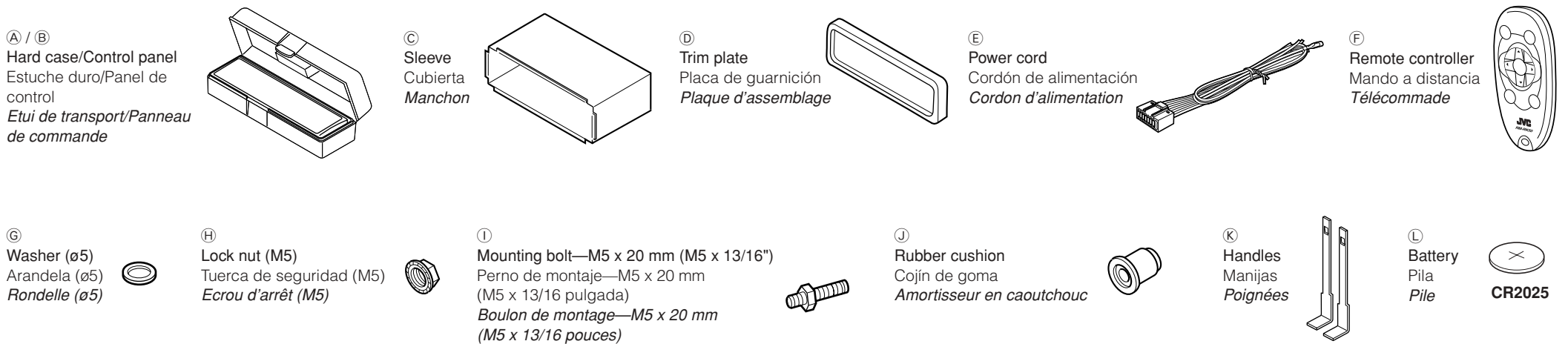

INSTALLATION (IN-DASH MOUNTING)

The following illustration shows a typical installation. If you have any questions or require information regarding installation kits, consult your JVC car audio dealer or a company supplying kits.

- If you are not sure how to install this unit correctly, have it installed by a qualified technician.

INSTALACION (MONTAJE EN EL TABLERO DE INSTRUMENTOS)

La siguiente ilustración muestra una instalación típica. Si tiene alguna pregunta o necesita información acerca de las herramientas para instalación, consulte con su concesionario de JVC de equipos de audio para automóviles o a una compañía que suministra tales herramientas.

- Si usted no está seguro de cómo instalar correctamente la unidad, hágala instalar por un técnico cualificado.

INSTALLATION (MONTAGE DANS LE TABLEAU DE BORD)

L'illustration suivante est un exemple d'installation typique. Si vous avez des questions ou avez besoin d'information sur des kits d'installation, consulter votre revendeur d'autoradios JVC ou une compagnie d'approvisionnement.

- Si l'on n'est pas sûr de pouvoir installer correctement cet appareil, le faire installer par un technicien qualifié.

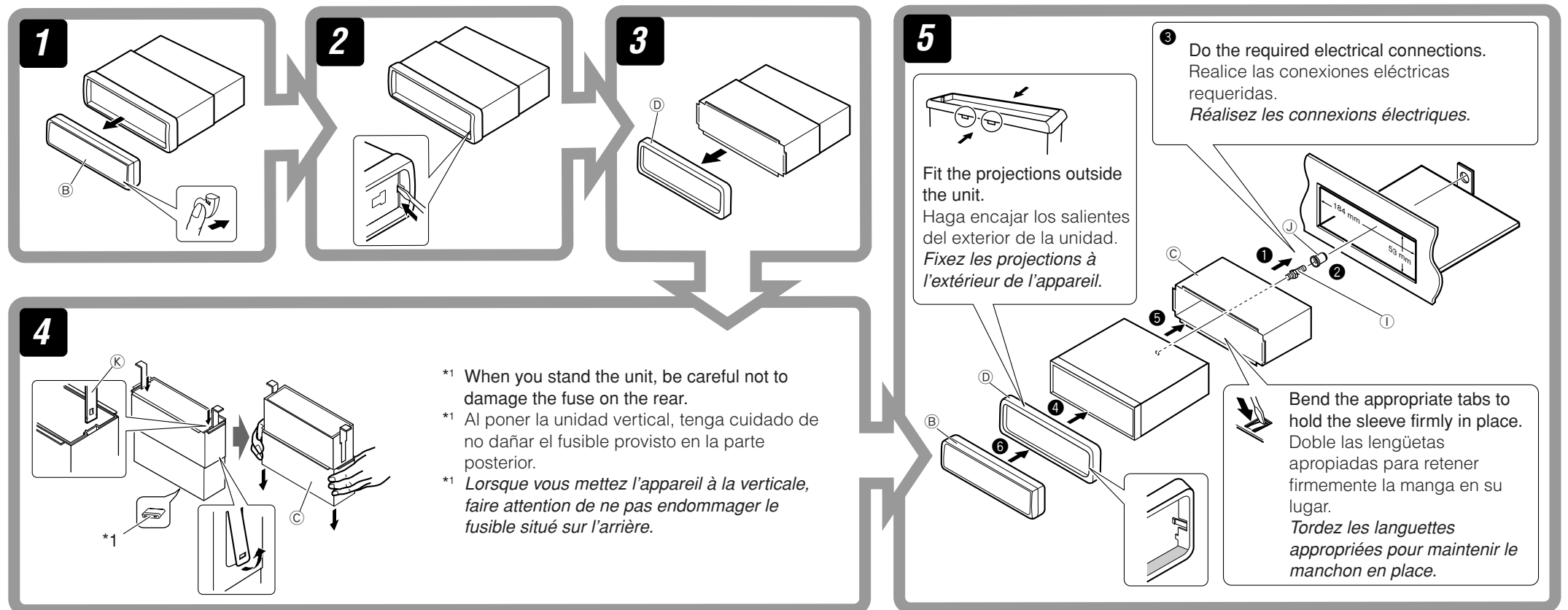

Removing the unit

Before removing the unit, release the rear section.

Extracción de la unidad

Antes de extraer la unidad, libere la sección trasera.

Retrait de l'appareil

Avant de retirer l'appareil, libérer la section arrière.

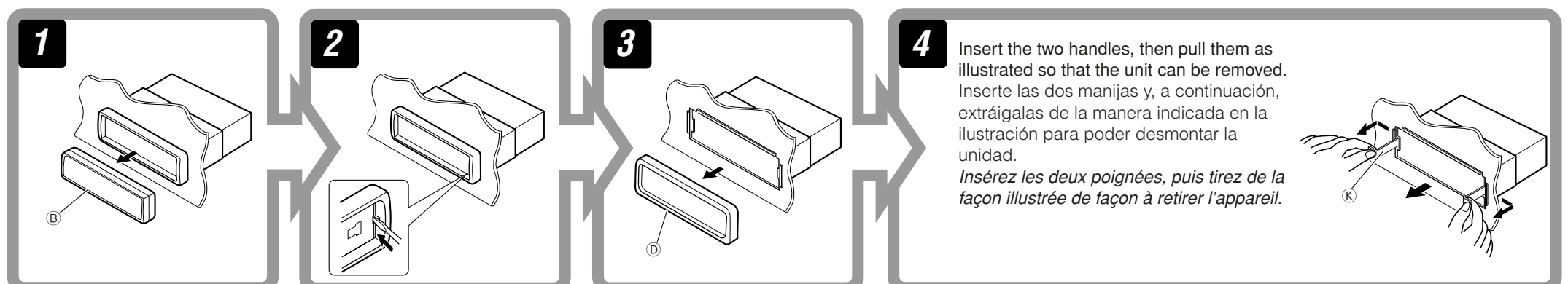

When using the optional stay / Cuando emplea un soporte opcional / Lors de l'utilisation du hauban en option

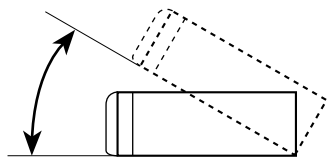
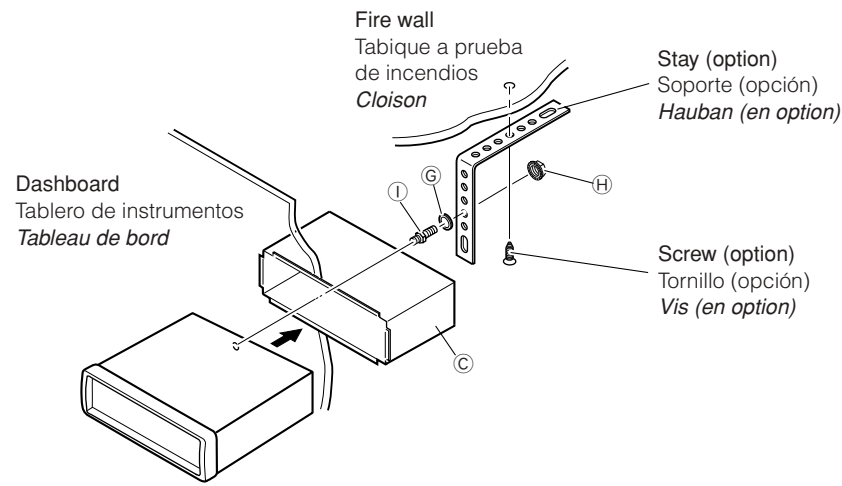

Install the unit at an angle of less than 30°.
Instale la unidad a un ángulo de menos de 30°.
Installez l'appareil avec un angle de moins de 30°.

When installing the unit without using the sleeve / Instalación de la unidad sin utilizar la cubierta / Lors de l'installation de l'appareil sans utiliser de manchon

In a Toyota for example, first remove the car radio and install the unit in its place.
En un Toyota por ejemplo, primero retire la radio del automóvil y luego instale la unidad en su lugar.
Par exemple dans une Toyota, retirer d'abord l'autoradio et installer l'appareil à la place.

Flat type screws—M5 x 8 mm (M5 x 3/8")*
Tornillos tipo plano—M5 x 8 mm (M5 x 3/8 pulgada)*
Vis à tête plate—M5 x 8 mm (M5 x 3/8 pouces)*

* Not included with this unit.
* No suministrado con esta unidad.
* Non fourni avec cet appareil.

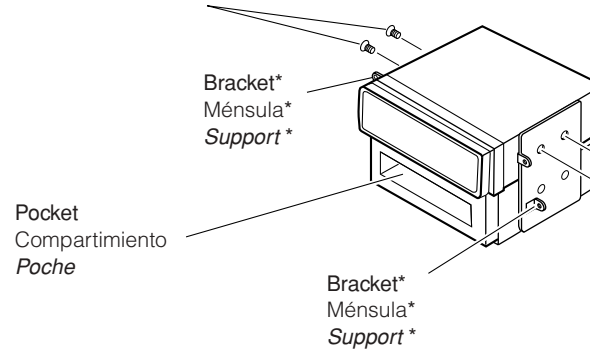

Flat type screws—M5 x 8 mm (M5 x 3/8")*
Tornillos tipo plano—M5 x 8 mm (M5 x 3/8 pulgada)*
Vis à tête plate—M5 x 8 mm (M5 x 3/8 pouces)*

- Note** : When installing the unit on the mounting bracket, make sure to use the 8 mm (3/8")-long screws. If longer screws are used, they could damage the unit.
Nota : Cuando instala la unidad en la ménsula de montaje, asegúrese de utilizar los tornillos de 8 mm (3/8 pulgada) de longitud. Si se utilizan tornillos más largos, éstos pueden dañar la unidad.
Remarque : Lors de l'installation de l'appareil sur le support de montage, s'assurer d'utiliser des vis d'une longueur de 8 mm (3/8 pouces). Si des vis plus longues sont utilisées, elles peuvent endommager l'appareil.

ELECTRICAL CONNECTIONS

To prevent short circuits, we recommend that you disconnect the battery's negative terminal and make all electrical connections before installing the unit.

- Be sure to ground this unit to the car's chassis again after installation.

Notes:

- Replace the fuse with one of the specified rating. If the fuse blows frequently, consult your JVC car audio dealer.
- It is recommended to connect to the speakers with maximum power of more than 50 W (both at the rear and at the front, with an impedance of 4 Ω to 8 Ω). If the maximum power is less than 50 W, change "AMP.GAIN" setting to prevent the speakers from being damaged (see page 30 of the INSTRUCTIONS).
- To prevent short-circuit, cover the terminals of the UNUSED leads with insulating tape.
- The heat sink becomes very hot after use. Be careful not to touch it when removing this unit.

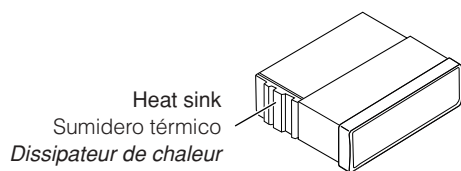

CONEXIONES ELECTRICAS

Para evitar cortocircuitos, recomendamos que desconecte el terminal negativo de la batería y que efectúe todas las conexiones eléctricas antes de instalar la unidad.

- Asegúrese de volver a conectar a masa esta unidad al chasis del automóvil después de la instalación.

Notas:

- Reemplace el fusible por uno con la corriente especificada. Si el fusible se quemase frecuentemente consulte con su concesionario de JVC de equipos de audio para automóviles.
- Se recomienda conectar los altavoces con una potencia máxima de más de 50 W (tanto atrás como adelante, con una impedancia de 4 Ω a 8 Ω). Si la potencia máxima es de menos de 50 W, cambie "AMP.GAIN" para evitar daños en los altavoces (consulte la página 30 del MANUAL DE INSTRUCCIONES).
- Para evitar cortocircuitos, cubra los cables NO UTILIZADOS con cinta aislante.
- El sumidero térmico estará muy caliente después del uso. Asegúrese de no tocarlo al desmontar esta unidad.

RACCORDEMENTS ELECTRIQUES

Pour éviter tout court-circuit, nous vous recommandons de débrancher la borne négative de la batterie et d'effectuer tous les raccordements électriques avant d'installer l'appareil.

- Assurez-vous de raccorder de nouveau la mise à la masse de cet appareil au châssis de la voiture après l'installation.

Remarques:

- Remplacer le fusible par un de la valeur précisée. Si le fusible saute souvent, consulter votre revendeur d'autoradios JVC.
- Il est recommandé de connecter des enceintes avec une puissance de plus de 50 W (les enceintes arrière et les enceintes avant, avec une impédance comprise entre 4 Ω et 8 Ω). Si la puissance maximum est inférieure à 50 W, changez "AMP.GAIN" pour éviter d'endommager vos enceintes (voir page 30 du MANUEL D'INSTRUCTIONS).
- Pour éviter les court-circuits, couvrir les bornes des fils qui ne sont PAS UTILISÉS avec de la bande isolante.
- Le dissipateur de chaleur devient très chaud après usage. Faire attention de ne pas le toucher en retirant cet appareil.

PRECAUTIONS on power supply and speaker connections:

- DO NOT connect the speaker leads of the power cord to the car battery; otherwise, the unit will be seriously damaged.
- BEFORE connecting the speaker leads of the power cord to the speakers, check the speaker wiring in your car.

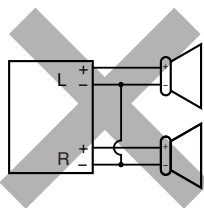

PRECAUCIONES sobre las conexiones de la fuente de alimentación y de los altavoces:

- NO conecte los conductores de altavoz del cable de alimentación a la batería de automóvil, pues podrían producirse graves daños en la unidad.
- ANTES de conectar a los altavoces los conductores de altavoz del cable de alimentación, verifique el conexionado de altavoz de su automóvil.

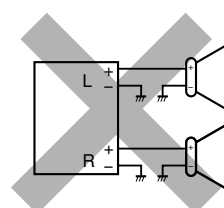

PRECAUTIONS sur l'alimentation et la connexion des enceintes:

- NE CONNECTEZ PAS les fils d'enceintes du cordon d'alimentation à la batterie; sinon, l'appareil serait sérieusement endommagé.
- AVANT de connecter les fils d'enceintes du cordon d'alimentation aux enceintes, vérifiez le câblage des enceintes de votre voiture.

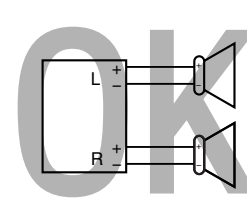

TROUBLESHOOTING

- **The fuse blows.**
 - * Are the red and black leads connected correctly?
- **Power cannot be turned on.**
 - * Is the yellow lead connected?
- **No sound from the speakers.**
 - * Is the speaker output lead short-circuited?
- **Sound is distorted.**
 - * Is the speaker output lead grounded?
 - * Are the "-" terminals of L and R speakers grounded in common?
- **Noise interfere with sounds.**
 - * Is the rear ground terminal connected to the car's chassis using shorter and thicker cords?
- **Unit becomes hot.**
 - * Is the speaker output lead grounded?
 - * Are the "-" terminals of L and R speakers grounded in common?

LOCALIZACION DE AVERIAS

- **El fusible se quema.**
 - * ¿Están los conductores rojo y negro correctamente conectados?
- **No es posible conectar la alimentación.**
 - * ¿Está el cable amarillo conectado?
- **No sale sonido de los altavoces.**
 - * ¿Está el cable de salida del altavoz cortocircuitado?
- **El sonido presenta distorsión.**
 - * ¿Está el cable de salida del altavoz conectado a masa?
 - * ¿Están los terminales "-" de los altavoces L y R conectados a una masa común?
- **Perturbación de ruido.**
 - * ¿El terminal de tierra trasero está conectado al chasis del automóvil utilizando los cordones más corto y más grueso?
- **La unidad se calienta.**
 - * ¿Está el cable de salida del altavoz conectado a masa?
 - * ¿Están los terminales "-" de los altavoces L y R conectados a una masa común?

EN CAS DE DIFFICULTES

- **Le fusible saute.**
 - * Les fils rouge et noir sont-ils raccordés correctement?
- **L'appareil ne peut pas être mise sous tension.**
 - * Le fil jaune est-elle raccordée?
- **Pas de son des enceintes.**
 - * Le fil de sortie d'enceinte est-il court-circuité?
- **Le son est déformé.**
 - * Le fil de sortie d'enceinte est-il à la masse?
 - * Les bornes "-" des enceintes gauche et droit sont-elles mises ensemble à la masse?
- **Interférence avec les sons.**
 - * La prise arrière de mise à la terre est-elle connectée au châssis de la voiture avec un cordon court et épais?
- **L'appareil devient chaud.**
 - * Le fil de sortie d'enceinte est-il à la masse?
 - * Les bornes "-" des enceintes gauche et droit sont-elles mises ensemble à la masse?

A Typical Connections / Conexiones típicas / Raccordements typiques

Before connecting: Check the wiring in the vehicle carefully. Incorrect connection may cause serious damage to this unit. The leads of the power cord and those of the connector from the car body may be different in color.

- 1 Connect the colored leads of the power cord in the order specified in the illustration below.
- 2 Connect the antenna cord.
- 3 Finally connect the wiring harness to the unit.

Antes de la conexión: Verifique atentamente el conexionado del vehículo. Una conexión incorrecta podría producir daños graves en la unidad. Los cordones del cable de alimentación y los del conector procedentes de la carrocería del automóvil podrían ser de diferentes en color.

- 1 Conecte los conductores de color del cable de alimentación en el orden especificado en la ilustración de abajo.
- 2 Conecte el cable de antena.
- 3 Por último, conecte el cable de alimentación a la unidad.

Avant de commencer la connexion: Vérifiez attentivement le câblage du véhicule. Une connexion incorrecte peut endommager sérieusement l'appareil.

- Le fil du cordon d'alimentation et ceux des connecteurs du châssis de la voiture peuvent être différents en couleur.
- 1 Connectez les fils colorés du cordon d'alimentation dans l'ordre spécifié sur l'illustration ci-dessous.
 - 2 Connectez le cordon d'antenne.
 - 3 Finalement, connectez le faisceau de fils à l'appareil.

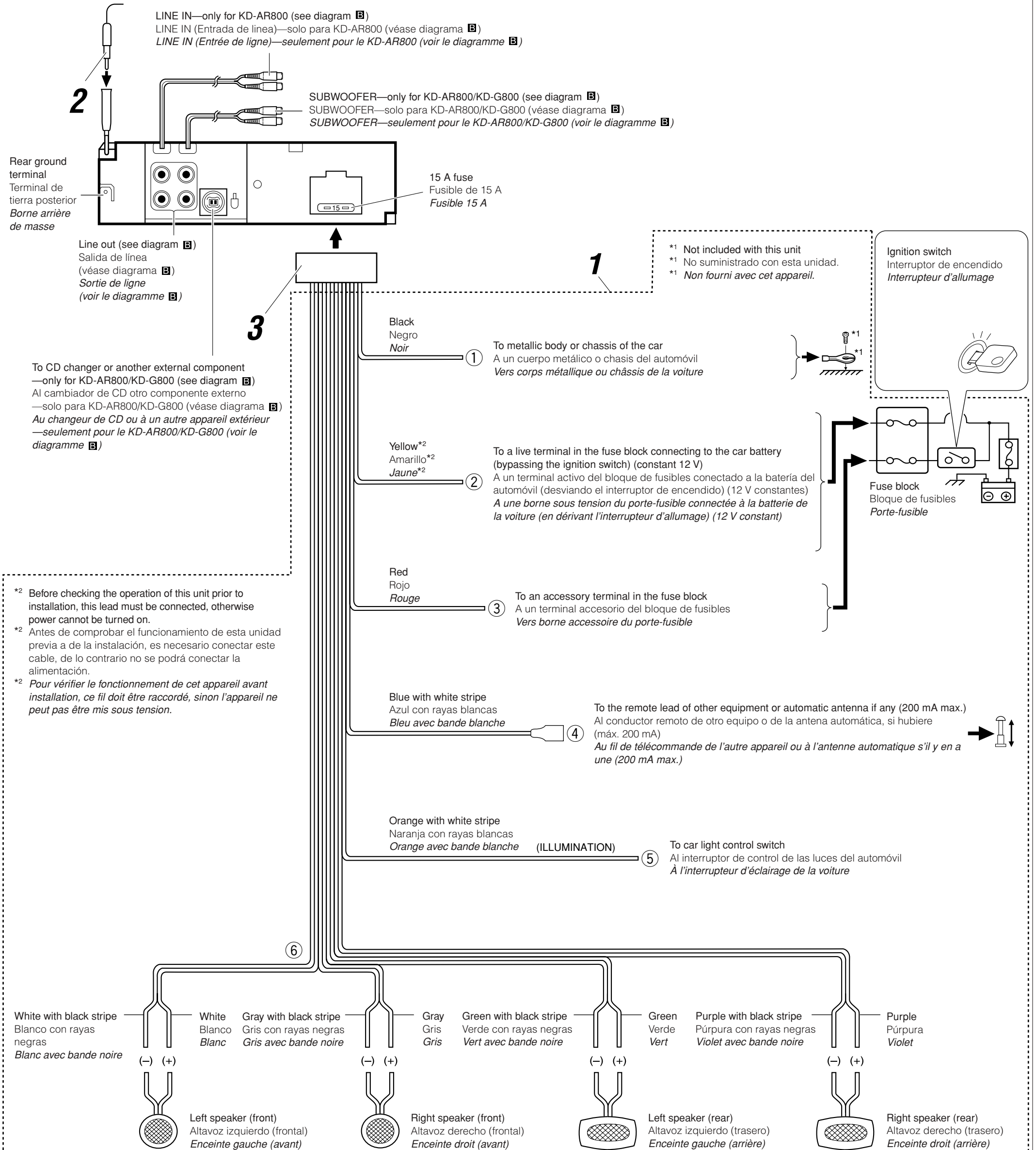

Amplifier / Amplificador / Amplificateur

You can connect an amplifier and other equipment to upgrade your car stereo system.

- Connect the remote lead (blue with white stripe) to the remote lead of the other equipment so that it can be controlled through this unit.

For amplifier only:

– Disconnect the speakers from this unit, connect them to the amplifier. Leave the speaker leads of this unit unused.

– Only for KD-AR800: You can switch off the built-in amplifier and send the audio signals only to the external amplifier(s) to get clear sounds and to prevent internal heat built-up inside the unit. See page 30 of the INSTRUCTIONS (separate volume).

– Only for KD-AR800/KD-G800: The line output level of this unit is kept high to maintain the hi-fi sounds reproduced from this unit.

When connecting an external amplifier to this unit, turn down the gain control on the external amplifier to obtain the best performance from this unit.

Usted podrá conectar un amplificador y otros equipos para mejorar el sistema estéreo de su automóvil.

- Conecte el conductor remoto (azul con rayas blancas) al conductor remoto del otro equipo para poderlo controlar a través de esta unidad.

Sólo para el amplificador:

– Desconecte los altavoces de esta unidad y conéctelos al amplificador. Los cables de los altavoces de esta unidad quedan sin usar.

– Solo para KD-AR800: Podrá desconectar el amplificador incorporado y enviar las señales de audio solamente al(los) amplificador(es) externo(s) para obtener sonidos nítidos y evitar que se caliente el interior de la unidad. Véase la página 30 de las MANUAL DE INSTRUCCIONES (volumen separado).

– Solo para KD-AR800/KD-G800: El nivel de salida de línea de esta unidad permanece alto para que corresponda con los sonidos de alta fidelidad reproducidos por esta unidad. Cuando conecte un amplificador externo a esta unidad, disminuya el control de ganancia del amplificador externo para obtener un óptimo rendimiento de esta unidad.

Vous pouvez connecter un amplificateur ou autre appareil pour améliorer votre système autoradio.

- Connectez le fil de commande à distance (bleu avec bande blanche) au fil de commande à distance de l'autre appareil de façon qu'il puisse être commandé via cet appareil.

Pour l'amplificateur seulement:

– Déconnectez les enceintes de cet appareil et connectez-les à l'amplificateur. Laissez les fils d'enceintes de cet appareil inutilisés.

– Seulement pour le KD-AR800: Vous pouvez désactiver l'amplificateur intégré et envoyer les signaux audio uniquement à un ou plusieurs amplificateurs extérieurs afin d'obtenir un son clair et pour éviter un échauffement interne de l'appareil. Référez-vous à la page 30 du MANUEL D'INSTRUCTIONS (volume séparé).

– Seulement pour le KD-AR800/KD-G800: Le niveau de sortie de ligne de cet appareil est maintenu à un niveau élevé pour maintenir une qualité Hi-Fi pour les sons reproduits par cet appareil.

Lors de la connexion d'un amplificateur extérieur à cet appareil, diminuez le réglage du gain sur l'amplificateur extérieur pour obtenir les meilleures performances de cet appareil.

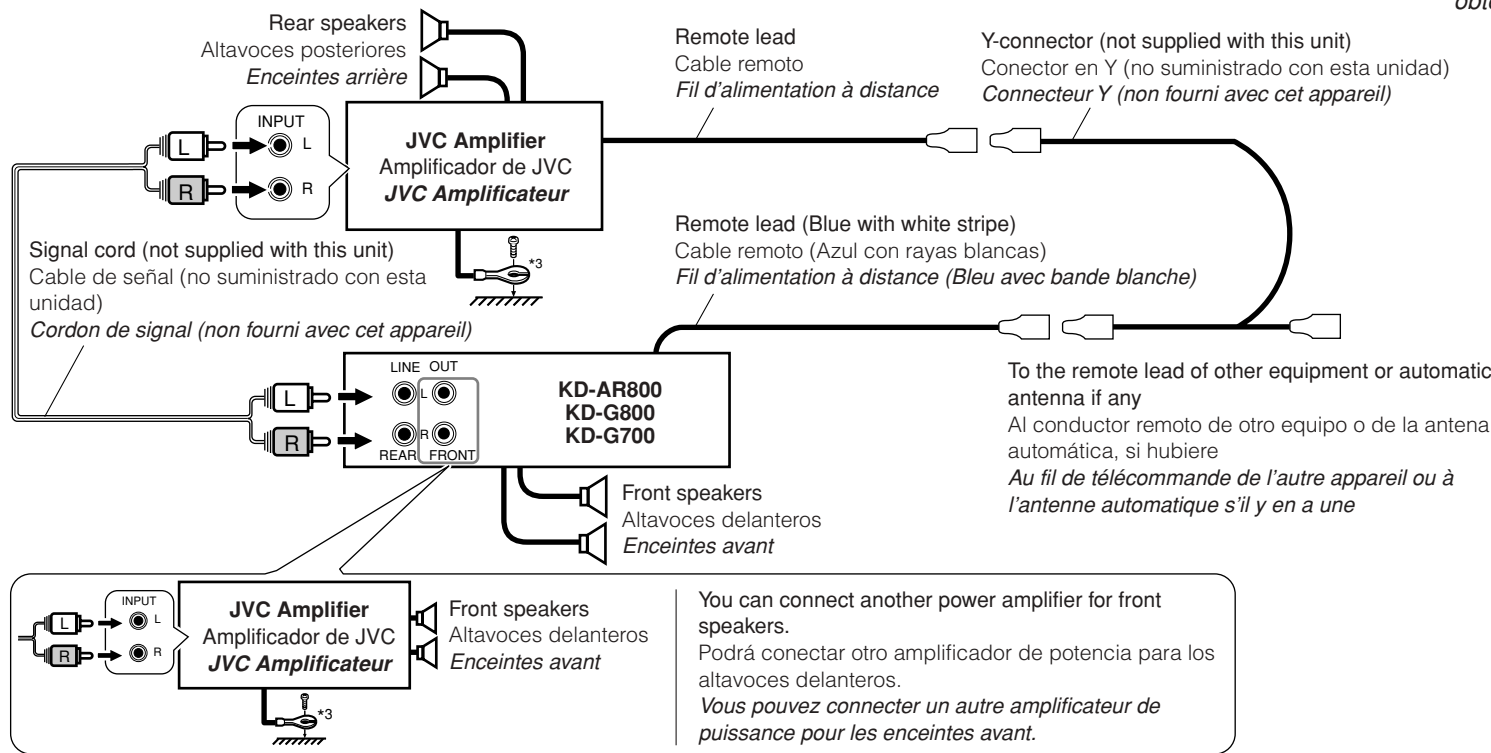

*3 Firmly attach the ground wire to the metallic body or to the chassis of the car—to the place not coated with paint (if coated with paint, remove the paint before attaching the wire). Failure to do so may cause damage to the unit.
 *3 Fije firmemente el cable de tierra a la carrocería metálica o al chasis—a un lugar no cubierto con pintura (si está cubierto con pintura, quítela antes de fijar el cable). De lo contrario, se podrían producir daños en la unidad.
 *3 Attachez solidement le fil de mise à la masse au châssis métallique de la voiture—à un endroit qui n'est pas recouvert de peinture (s'il est recouvert de peinture, enlevez d'abord la peinture avant d'attacher le fil). L'appareil peut être endommagé si cela n'est pas fait correctement.

CD Changer / Cambiador de CD / Changeur CD

Only for KD-AR800/KD-G800 / Sólo para KD-AR800/KD-G800 / Seulement pour le KD-AR800/KD-G800

Refer also to page 34 of the INSTRUCTIONS. Consulte también la página 34 de las MANUAL DE INSTRUCCIONES. Référez-vous aussi à la page 34 du MANUEL D'INSTRUCTIONS.

Connecting cord supplied for your CD changer
 Cable de conexión suministrado con su cambiador de CD
 Cordon de connexion fourni avec votre changeur CD

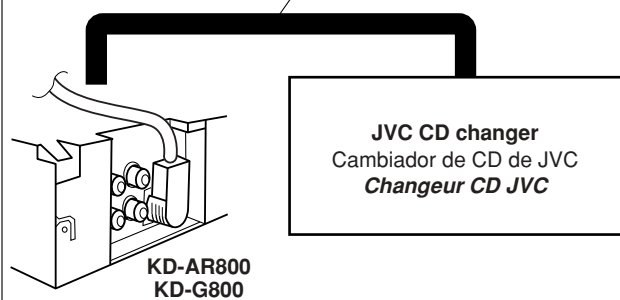

CAUTION / PRECAUCION / PRECAUTION

- Before connecting the CD changer, make sure that the unit is turned off.
- Antes de conectar el cambiador de CD, asegúrese de que la unidad esté apagada.
- Avant de connecter le changeur CD, s'assurer que l'unité est éteinte.

Subwoofer / Subwoofer / Caisson de grave

Only for KD-AR800/KD-G800 / Sólo para KD-AR800/KD-G800 / Seulement pour le KD-AR800/KD-G800

You can connect a subwoofer through an amplifier to reinforce the bass.
 • For their connections, refer to the instructions supplied with your subwoofer.
 Usted podrá conectar un subwoofer a través de un amplificador para reforzar los graves.
 • Con respecto a sus conexiones, refiérase a las instrucciones suministradas con sus subwoofer.
 Vous pouvez connecter un caisson de grave par un amplificateur pour renforcer les graves.
 • Pour la connexion, référez-vous aux instructions fournies avec le caisson de grave.

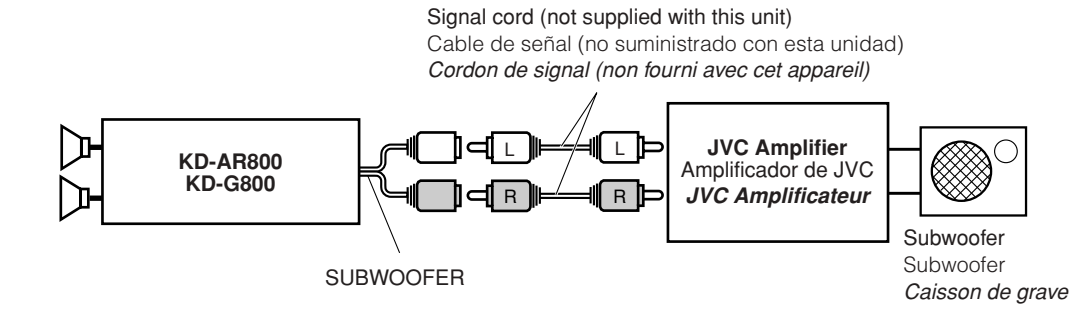

External Component / Componente exterior / Appareil extérieur

Only for KD-AR800/KD-G800 / Sólo para KD-AR800/KD-G800 / Seulement pour le KD-AR800/KD-G800
 For connecting the JVC SIRIUS Radio, refer to the SIRIUS Radio Setup Manual (separate volume).
 Para la conexión de la radio JVC SIRIUS, consulte el Manual de configuración de la radio SIRIUS (volumen separado).
 Pour brancher la radio JVC SIRIUS, référez-vous au Manuel d'installation de la radio SIRIUS (volume séparé).

Only for KD-AR800 / Sólo para KD-AR800 / Seulement pour le KD-AR800

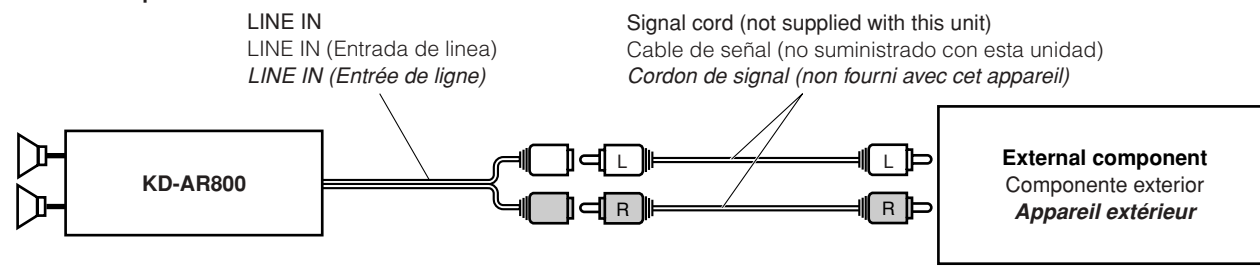

Only for KD-G800 / Sólo para KD-G800 / Seulement pour le KD-G800

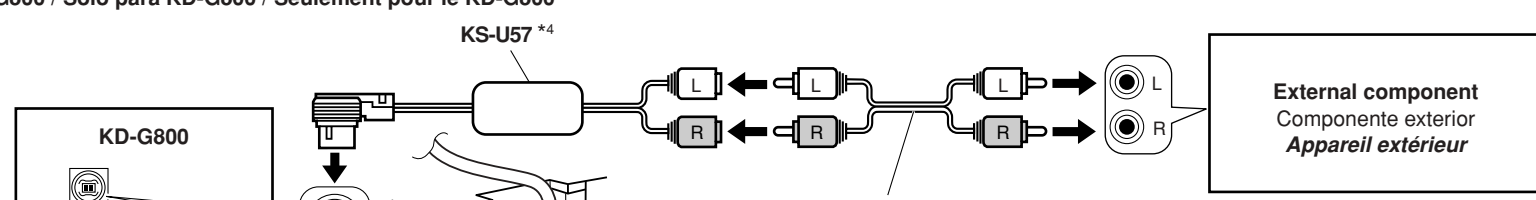

*4 Line Input Adapter KS-U57 (not supplied with this unit)
 *4 Adaptador de entrada de línea KS-U57 (no suministrado con esta unidad)
 *4 Adaptateur d'entrée de ligne KS-U57 (non fourni avec cet appareil)

JVC IMPORTANT

Notice the following information will help you to solve your problems.
Keep this IMPORTANT sheet together with the INSTRUCTIONS.

- **After installing the unit**

→ Follow the procedure **[A]** described below.

- **If the unit does not operate**

→ Follow the procedure **[A]** described below.

- **If a disc is not ejected from the loading slot**

→ Follow the procedure **[B]** described below. (If the procedure **[B]** does not work, try the procedure **[A]**.)

- **If a disc is not recognized (“NO DISC” appears on the display) even though there is a disc in the loading slot**

→ Follow the procedure **[B]** described below. (If the procedure **[B]** does not work, try the procedure **[A]**.)

[A] To reset the microcomputer

Press the reset button on the control panel using a ball-point pen or similar tool.
This will reset the built-in microcomputer.

NOTE: Your preset adjustments—such as preset channels or sound adjustments—will also be erased.

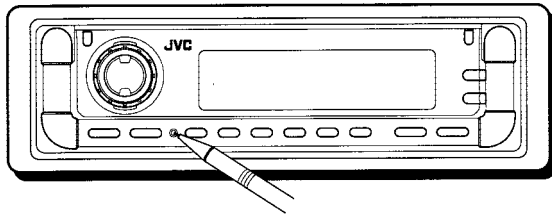

[B] To eject a CD by force

While pressing CD/CD-CH LINE (for KD-AR800) or CD/CD-CH (for KD-G800) or CD (for KD-G700), press and hold SEL (select) for more than 2 seconds to eject the disc.

The control panel moves down and the disc automatically ejects from the loading slot. Be careful not to drop the disc when it is ejected.

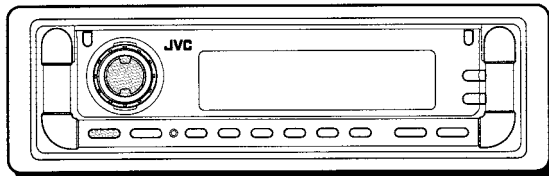

GET0206-001A

Canceling the display demonstration / Beendigung der Display-Demonstration / Annulation de la démonstration des affichages / Annuleren van de displaydemonstratie

1



2



3

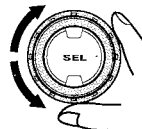

4



ENGLISH

When shipped from the factory, display demonstration has been activated, and starts automatically when no operations are done for about 20 seconds.

- It is recommended to cancel the display demonstration before you use the unit for the first time.

To cancel the display demonstration, follow the procedure below:

- 1 Press and hold SEL (select) for more than 2 seconds so that one of the PSM items appears on the display.
- 2 Select "DEMO MODE" if not shown on the display.
- 3 Select "DEMO OFF."
- 4 Finish the setting.

To activate the display demonstration, repeat the same procedure and select "DEMO ON" in step 3.

DEUTSCH

Die Display-Demonstration ist werkseitig aktiviert und beginnt automatisch, wenn für ca. 20 Sekunden keine Aktionen durchgeführt wurden.

- Es wird empfohlen, die Display-Demonstration vor der ersten Verwendung des Geräts auszuschalten.

Führen Sie die folgenden Schritte zur **Beendigung der Display-Demonstration aus**:

- 1 Drücken Sie die Taste SEL (Auswahl), und halten Sie sie länger als 2 Sekunden gedrückt, bis eine der PSM-Elemente im Display angezeigt wird.
- 2 Wählen Sie „DEMO MODE“, sofern nicht bereits im Display angezeigt wird.
- 3 Wählen Sie „DEMO OFF“ aus.
- 4 Bestätigen Sie die Einstellung.

Zum Aktivieren der Display-Demonstration wiederholen Sie das gleiche Verfahren und wählen „DEMO ON“ in Schritt 3.

FRANÇAIS

À l'expédition de l'usine, la démonstration est en service et celle-ci démarre automatiquement quand aucune opération n'est effectuée pendant environ 20 secondes.

- Il est recommandé d'annuler la démonstration des affichages avant d'utiliser l'appareil pour la première fois.

Pour annuler la démonstration, suivez la procédure ci-dessous.

- 1 Maintenez pressée SEL (sélection) pendant plus de 2 secondes de façon que l'un des éléments PSM apparaisse sur l'affichage.
- 2 Choisissez "DEMO MODE" s'il n'apparaît pas sur l'affichage.
- 3 Choisissez "DEMO OFF".
- 4 Terminez le réglage.

Pour mettre en service la démonstration des affichages, répétez la même procédure et choisissez "DEMO ON" à l'étape 3.

NEDERLANDS

Bij het verlaten van de fabriek is de displaydemonstratie geactiveerd en start deze automatisch indien u gedurende ongeveer 20 seconden geen bediening uitvoert.

- Het wordt aanbevolen de demonstratie op het display te annuleren voordat u het toestel voor het eerst gaat gebruiken.

Voor het annuleren van de displaydemonstratie, voert u de volgende handelingen uit:

- 1 Druk op SEL (selecteren) in en houd deze tenminste 2 seconden ingedrukt, zodat een van de PSM-meldingen op de display wordt weergegeven.
- 2 Kies "DEMO MODE" indien het niet op het display wordt getoond.
- 3 Kies "DEMO OFF".
- 4 Voltooi de instelling.

Om de demonstratie op het display weer te activeren, herhaalt u deze procedure en kiest u in stap 3 "DEMO ON".

GET0210-001A

ENGLISH

To install this unit, attach the trim plate to the unit first, then fit the unit into the mounting sleeve by pressing the four corners of the trim plate.

DO NOT press the panel (shaded in the illustration); otherwise the panel may become unable to open or close.

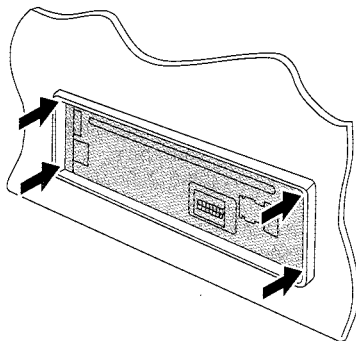

DEUTSCH

Um dieses Gerät zu installieren, bringen Sie zunächst den Zierrahmen am Gerät an.

Schieben Sie anschließend das Gerät in die Schutzhülle, indem Sie auf die vier Ecken des Zierrahmens drücken.

Drücken Sie NICHT auf die Blende (die in der Abbildung dunkelgetönt dargestellt ist); anderenfalls läßt sich die Blende weder öffnen noch schließen.

FRANÇAIS

Pour installer cet appareil, fixez d'abord la plaque d'assemblage à l'appareil, puis ajustez l'appareil dans le manchon en appuyant sur les quatre coins de la plaque d'assemblage.

N'APPUYEZ PAS sur le panneau (partie ombrée sur l'illustration); sinon le panneau risque de ne pas pouvoir s'ouvrir ou se fermer.

NEDERLANDS

Om dit apparaat te installeren, dient u eerst de sierplaat op het apparaat te bevestigen, daarna het apparaat in de behuizing te plaatsen en de vier hoeken van de sierplaat aan te drukken.

Druk NIET op het paneel (gearceerd in de illustratie aangegeven), anders loopt u het risico dat het paneel niet meer kan worden geopend of gesloten.

ESPAÑOL

Para instalar esta unidad, en primer lugar fije la placa de guarnición en la unidad y póngala en la manga de montaje presionando las cuatro esquinas de la placa de guarnición.

NO presione el panel (rayado en la ilustración) pues podría suceder que sea imposible abrirlo o cerrarlo después.

ITALIANO

Per installare l'apparecchio, per prima cosa fissare la piastra di finitura all'apparecchio, poi inserire l'apparecchio nella protezione premendo i quattro angoli della piastra di finitura.

Nota: Non premere il pannello (sfumato in figura) in quanto si rischia di danneggiarne l'apertura e la chiusura.

JVC SIRIUS Radio Setup Manual

Manual de configuración de la radio SIRIUS

Manuel d'installation de la radio SIRIUS

LVT1122-001A
[J]



KT-SR1000

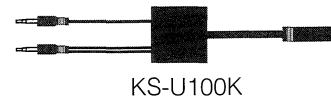

KS-U100K

JVC Car Receiver
Receptor para automóvil JVC
Autoradio JVC

SIRIUS

COMPATIBLE

EN, SP, FR

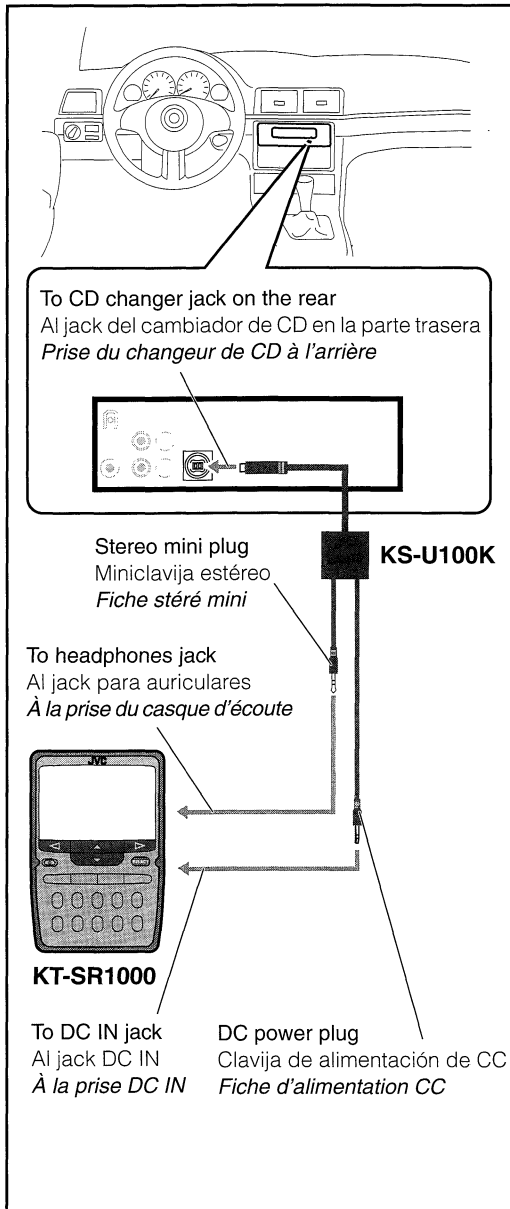

ENGLISH

You can connect JVC SIRIUS Radio KT-SR1000 (not supplied), and enjoy its sound through this receiver.

- The power can be supplied to KT-SR1000 through this receiver.

Connecting the SIRIUS Radio

To connect KT-SR1000, it is also required to purchase JVC SIRIUS Radio Adapter KS-U100K.

- See the left diagram for connection.

Set up the SIRIUS Radio

After connection, follow the procedure below to use the SIRIUS Radio with this receiver.

- 1 Turn on the receiver.
- 2 Select "SIRIUS" for the external component setting—"EXT IN" or "EXT INPUT" of the PSM items.
 - For details, refer to the PSM section of the Instructions.

Daily operations

- 1 Turn on the receiver.
Your SIRIUS Radio also comes on.
- 2 Select "SIRIUS" as the playback source on the receiver.
- 3 Adjust the sound on the receiver.
- 4 Operate your SIRIUS Radio.
 - For its operations, refer to its Instructions supplied.

ESPAÑOL

Podrá conectar la radio SIRIUS JVC KT-SR1000 (no suministrada), y disfrutar de su sonido a través de este receptor.

- La alimentación para la KT-SR1000 puede suministrarse a través de este receptor.

Conexión de la radio SIRIUS

Para conectar la KT-SR1000, también deberá comprar el adaptador KS-U100K para la radio SIRIUS JVC.

- Para la conexión, consulte el diagrama de la izquierda.

Configuración de la radio SIRIUS

Después de la conexión, proceda de la siguiente manera para poder utilizar la radio SIRIUS con este receptor.

- 1 Encienda el receptor.
- 2 Seleccione "SIRIUS" para el ajuste del componente externo—"EXT IN" o "EXT INPUT" de las opciones PSM.
 - Para más detalles, consulte la sección PSM de las instrucciones.

Operaciones diarias

- 1 Encienda el receptor.
Su radio SIRIUS también se enciende.
- 2 Seleccione "SIRIUS" como fuente de reproducción en su receptor.
- 3 Ajuste el sonido en el receptor.
- 4 Opere su radio SIRIUS.
 - Para las operaciones, consulte las instrucciones suministradas.

FRANÇAIS

Vous pouvez connecter la radio SIRIUS JVC KT-SR1000 (non fournie) et écouter son son à travers cet autoradio.

- *L'alimentation peut être fournie au KT-SR1000 par cet autoradio.*

Connexion de la radio SIRIUS

Pour connecter la KT-SR1000, il faut aussi acheter l'adaptateur pour radio SIRIUS JVC, KS-U100K.

- *Référez-vous au diagramme ci-à gauche pour la connexion.*

Réglage de la radio SIRIUS

Après la connexion, suivez la procédure suivante pour utiliser la radio SIRIUS avec cet autoradio.

- 1 *Mettez l'autoradio sous tension.*
- 2 *Choisissez "SIRIUS" pour le réglage de l'appareil extérieur—"EXT IN" ou "EXT INPUT" des réglages PSM.*
 - *Pour les détails, référez-vous à la section PSM du manuel d'instructions.*

Fonctionnement quotidien

- 1 *Mettez l'autoradio sous tension.*
Votre radio SIRIUS se met aussi sous tension.
- 2 *Choisissez "SIRIUS" comme source de lecture sur l'autoradio.*
- 3 *Ajustez le son sur l'autoradio.*
- 4 *Utilisez votre radio SIRIUS.*
 - *Pour son fonctionnement, référez-vous au manuel d'instruction qui l'accompagne.*

ENGLISH

A Guide to MP3/WMA

IMPORTANT: Some players cannot play back WMA files. For the WMA compatibility, refer to Instructions of your car audio (separate volume).

▶ What are MP3/WMA?

MP3 (MPEG Audio Layer 3) is one of digital audio compression standards.

- This player cannot play back MP3i and MP3 PRO formats.

WMA (Windows Media® Audio) is the digital audio compression format developed by Microsoft Corporation. WMA formatted files copy-protected with DRM cannot be decoded and played on this product.

- This player cannot play back WMA files that are encoded with the following methods:
 - Lossless
 - Professional
 - Voice

▶ About Tag of MP3/WMA

This player can show the names of albums, artists (performer), and tracks of MP3/WMA Tag.

- This player can handle only one-byte characters. Any other characters cannot be correctly displayed.

▶ About formats of MP3/WMA

This player cannot play back the following files:

- MP3/WMA files without extensions such as [.MP3] or [.WMA].
- MP3/WMA files with the extensions other than [.MP3] or [.WMA].
- Files which do not have MP3/WMA data.
- MP3/WMA files are not encoded in an appropriate format (this player skips the files after "Not Support" appears on the display).
- MP3 files encoded with Layer 1/2 (this player skips the files after "Not Support" appears on the display).
- WMA files which are not based upon Windows Media® Audio.
- WMA formatted files copy-protected with DRM (this player skips the files after "Not Support" appears on the display).
- Files which have the data such as WAVE, ATRAC3, etc.

▶ About available formats of disc

This player cannot play back the following cases:

- CD-R/RW on which the files are written with "Packet Write" method.
- There are improper recording conditions (missing data, etc.) or media conditions (stain, scratch, warp, etc.).
- There are unclosed sessions on CD-R/RW (this player skips unclosed sessions).

▶ About functions restrained during MP3/WMA playback

- The search function works but search speed is not constant during search.
- When skip is tried at the last file in a folder, the next folder is selected.

▶ Glossary

CD-DA

The data of music CD

Mixed-CD

A CD-R/RW on which audio tracks (CD-DA data) have been added to data tracks before closing a session.

Enhanced-CD

A CD-R/RW on which data tracks have been added to audio tracks (CD-DA data) before closing a session.

Multiple session

A CD-writing method, which make it possible to add data on a CD-R/RW after closing a session.

Microsoft and Windows Media are either registered trademarks or trademarks of Microsoft Corporation in the United States and/or other countries.

ESPAÑOL

Una guía sobre MP3/WMA

IMPORTANTE: Algunos reproductores no pueden reproducir archivos WMA. Para la compatibilidad con WMA, consulte el Manual de instrucciones de su car audio (volumen separado).

▶ ¿Qué es MP3/WMA?

MP3 (MPEG Audio Layer 3) es una de las normas de compresión de audio digital.

- Este reproductor no puede reproducir los formatos MP3i y MP3 PRO.

WMA (Windows Media® Audio) es el formato de compresión de audio digital desarrollado por Microsoft Corporation. Los archivos formateados WMA protegidos contra la copia por DRM, no pueden ser decodificados ni reproducidos en este producto.

- Este reproductor no puede reproducir archivos WMA codificados con los siguientes métodos:
 - Lossless (Sin pérdida)
 - Professional (Profesional)
 - Voice (Voz)

▶ Acerca del Tag para MP3/WMA

Este reproductor puede mostrar los nombres de los álbumes, artistas (ejecutantes), y pistas del Tag para MP3/WMA.

- Este reproductor puede manejar solamente caracteres de un byte. Los demás caracteres no serán visualizados correctamente.

▶ Acerca de los formatos disponibles con MP3/WMA

Este reproductor no puede reproducir los archivos siguientes:

- Archivos MP3/WMA que no tengan las extensiones [.MP3] o [.WMA].
- Archivos MP3/WMA con otras extensiones que no sean [.MP3] o [.WMA].
- Archivos que no tengan datos MP3/WMA.
- Los archivos MP3/WMA no están codificados en un formato apropiado (este reproductor omitirá los archivos después que aparezca "Not Support" en la pantalla).
- Archivos MP3 codificados con Layer 1/2 (este reproductor omitirá los archivos después que aparezca "Not Support" en la pantalla).
- Archivos WMA que no se basan en Windows Media® Audio.
- Archivos formateados WMA protegidos contra la copia por DRM (este reproductor omitirá los archivos después que aparezca "Not Support" en la pantalla).
- Archivos que disponen de datos tales como WAVE, ATRAC3, etc.

▶ Acerca de los formatos de discos disponibles

Este reproductor no puede reproducir en los siguientes casos:

- CD-R/RW cuyos archivos están escritos con el método "Packet Write" (escritura por paquetes).
- Condiciones inadecuadas de grabación (datos faltantes, etc.) o del medio (manchas, rayaduras, alabeo, etc.).
- Hay sesiones sin cerrar en el CD-R/RW (este reproductor omite las sesiones sin cerrar).

▶ Acerca de las funciones inhibidas durante la reproducción de MP3/WMA

- Es posible activar la función de búsqueda, pero la velocidad de búsqueda no se mantiene constante.
- Cuando se intente omitir en el último archivo de una carpeta, se seleccionará la siguiente carpeta.

▶ Glosario

CD-DA

Datos de un CD de música

Mixed-CD

Un CD-R/RW con pistas de audio (datos de CD-DA) añadidas a las pistas de datos antes de cerrar una sesión.

Enhanced-CD

Un CD-R/RW al que se han añadido pistas de audio (datos de CD-DA) antes de cerrar una sesión.

Multiple session (Multisesión)

Un método de escritura de CD, que hace posible añadir datos a un CD-R/RW después de cerrar una sesión.

Microsoft y Windows Media son marcas registradas o bien marcas comerciales de Microsoft Corporation en los Estados Unidos y/u otros países.

FRANÇAIS

Un guide du format MP3/WMA

IMPORTANT: Certains lecteurs ne peuvent pas reproduire les fichiers WMA. Pour connaître la compatibilité de votre lecteur avec le format WMA, veuillez vous référer au Manuel d'instructions de votre autoradio (volume séparé).

▶ Qu'est-ce que le format MP3/WMA?

MP3 (Norme MPEG Audio de Layer 3) est une des normes de compression audio numérique.

- Ce lecteur ne peut pas reproduire les formats MP3i et MP3 PRO.

WMA (Windows Media® Audio) est le format de compression audio numérique mis au point par Microsoft Corporation. Les fichiers WMA avec protection contre les copies DRM ne peuvent pas être décodés ni reproduits sur cet appareil.

- Ce lecteur ne peut pas reproduire les fichiers WMA codés avec une des méthodes suivantes:
 - Lossless (Sans perte de qualité)
 - Professional (Professionnel)
 - Voice (Voix)

▶ À propos des balises MP3/WMA

Ce lecteur peut afficher le nom des albums, des artistes (interprète) et des plages des balises MP3/WMA.

- Ce lecteur peut prendre en charge uniquement les caractères d'un octet. Tous les autres caractères ne peuvent pas être affichés correctement.

▶ À propos des formats MP3/WMA

Ce lecteur ne peut pas reproduire les fichiers suivants:

- Les fichiers MP3/WMA sans extension telle que [.MP3] ou [.WMA].
- Les fichiers MP3/WMA avec une extension différente que [.MP3] ou [.WMA].
- Les fichiers qui ne contiennent pas de données MP3/WMA.
- Les fichiers MP3/WMA ne sont pas codés dans le format approprié (ce lecteur saute ces fichiers après que "Not Support" apparaisse sur l'afficheur).
- Les fichiers MP3 codés avec le Layer 1/2 (ce lecteur saute ces fichiers après que "Not Support" apparaisse sur l'afficheur).
- Les fichiers WMA qui ne sont pas basés sur Windows Media® Audio.
- Les fichiers WMA avec protection contre les copies DRM (ce lecteur saute ces fichiers après que "Not Support" apparaisse sur l'afficheur).
- Les fichiers avec des données telles que WAVE, ATRAC3, etc.

▶ À propos des formats de disque disponibles

Ce lecteur ne peut pas reproduire les disques dans les cas suivants:

- Les CD-R/RW sur lesquels les fichiers ont été écrits avec la méthode "Packet Write" (écriture par paquet).
- Mauvaises conditions d'enregistrement (données manquantes, etc.) ou mauvaise condition du support (tâche, rayure, voilage, etc.).
- Une session sur le CD-R/RW n'a pas été fermée (ce lecteur saute les sessions non fermées).

▶ À propos des fonctions réduites pendant la lecture MP3/WMA

- La fonction de recherche fonctionne mais la vitesse de recherche n'est pas constante.
- Quand vous essayez d'utiliser la fonction de saut pour le dernier fichier d'un dossier, le dossier suivant est choisi.

▶ Glossaire

CD-DA

Les données des CD musicaux

Mixed-CD (CD mixé)

Des plages audio (données CD-DA) ont été ajoutées aux plages de données d'un CD-R/RW avant la fermeture d'une session.

Enhanced-CD (CD amélioré)

Des plages de données ont été ajoutées aux plages audio (données CD-DA) d'un CD-R/RW avant la fermeture d'une session.

Multiple session (Session multiple)

Une méthode d'écriture de CD qui permet d'ajouter des données sur un CD-R/RW après la fermeture d'une session.

Microsoft et Windows Media sont des marques déposées ou des marques de commerce de Microsoft Corporation aux États-Unis et/ou dans les autres pays.

Table of playable disc types / Tabla de los tipos de discos reproducibles / Tableau des types de disque reproductibles

○: Compatible / Compatible / Compatible

	Models compatible with both MP3 and WMA files / Modelos compatibles con ambos archivos, MP3 y WMA / Modèles compatibles avec les fichiers MP3 et WMA	Models compatible with only MP3 files / Modelos compatibles con archivos MP3 solamente / Modèles compatibles uniquement avec les fichiers MP3
Discs containing both MP3 files and WMA files / Discos conteniendo tanto archivos MP3 como archivos WMA / Disques contenant des fichiers MP3 et WMA	○	MP3 playback / Reproducción de MP3 / Lecture MP3
Mixed-CD	MP3 + CD-DA	MP3 playback / Reproducción de MP3 / Lecture MP3
	WMA + CD-DA	WMA playback / Reproducción de WMA / Lecture WMA
	MP3/WMA + CD-DA	MP3/WMA playback / Reproducción de MP3/WMA / Lecture MP3/WMA
	Other files + CD-DA / Otros archivos + CD-DA / Autres fichiers + CD-DA	CD-DA playback / Reproducción de CD-DA / Lecture CD-DA
Enhanced-CD	CD-DA + MP3/WMA	CD-DA playback / Reproducción de CD-DA / Lecture CD-DA
File name system^{*1} / Sistema de nombre de archivo^{*1} / Système noms de fichiers^{*1}	ISO9660 Level1 / Nivel1 / Niveau1	Up to 12 characters (8.3 format) / Hasta 12 caracteres (formato 8,3) / Jusqu'à 12 caractères (format 8,3)
	ISO9660 Level2 / Nivel2 / Niveau2	Up to 31 characters / Hasta 31 caracteres / Jusqu'à 31 caractères
	ISO9660 Level3 / Nivel3 / Niveau3	Not available / No disponible / Non disponible
	Romeo	Up to 128 (72) characters ^{*2} / Hasta 128 (72) caracteres ^{*2} / Jusqu'à 128 (72) caractères ^{*2}
	Joliet	Up to 64 (36) characters ^{*2} / Hasta 64 (36) caracteres ^{*2} / Jusqu'à 64 (36) caractères ^{*2}
Windows long file name / Norma de archivo largo de Windows / Nom de fichier Windows longs	Up to 128 (72) characters ^{*2} / Hasta 128 (72) caracteres ^{*2} / Jusqu'à 128 (72) caractères ^{*2}	
Multiple session / Multisesión / Session multiple		○
80-minute discs (capacity: 700 MB) / Discos de 80 minutos (capacidad: 700MB) / Disques de 80 minutes (capacité: 700 Mo)		○

*1: Maximum number of characters for file/folder names includes 4 extension characters—“.MP3” or “.WMA”.

El número máximo de caracteres para nombres de archivos/carpetas incluye 4 caracteres de extensión—.MP3” o “.WMA”.

Le nombre maximum de caractères pour les noms de fichier/dossier est de 4—.MP3” ou “.WMA”.

*2: The parenthetic figure is the maximum number of characters for file/folder names in case the total number of files and folders is 313 or more.

La cifra entre paréntesis indica el número máximo de caracteres para los nombres de archivos/carpetas en caso de que el número total de archivos y carpetas sea de 313 o más.

Le nombre entre parenthèses indique le nombre maximum de caractères pour les noms de fichier/dossier dans le cas où le nombre total de fichiers et de dossiers est de 313 ou plus.

Table for playable MP3/WMA files / Tabla de archivos MP3/WMA reproducibles / Tableau des fichiers MP3/WMA reproductibles

○: Compatible / Compatible / Compatible

	Models compatible with both MP3 and WMA files / Modelos compatibles con ambos archivos, MP3 y WMA / Modèles compatibles avec les fichiers MP3 et WMA	Models compatible with only MP3 files / Modelos compatibles con archivos MP3 solamente / Modèles compatibles uniquement avec les fichiers MP3	
WMA playback / Reproducción de WMA / Lecture WMA	○	Not playable / No reproducible / Non reproductible	
MP3	Bit-rate / Velocidad de bit / Débit binaire	8 kbps—320 kbps	
	VBR	○	
	Sampling frequency / Frecuencia de muestreo / Fréquence d'échantillonnage	MPEG-1	48 kHz, 44.1 kHz, 32 kHz
		MPEG-2	24 kHz, 22.05 kHz, 16 kHz
	Joint stereo / Estéreo conjunto / Stéréo combiné	○	
	Emphasis / Énfasis / Accentuation	○	
ID3-Tag / Etiqueta ID3 / Balises ID3	Ver. 1.0, 1.1, 2.2, 2.3, 2.4		
WMA	Bit-rate / Velocidad de bit / Débit binaire	32 kbps—192 kbps	
	Sampling frequency / Frecuencia de muestreo / Fréquence d'échantillonnage	48 kHz, 44.1 kHz, 32 kHz	
	WMA-Tag / Etiqueta WMA / Balises WMA	○	
m3u playlist		Not available / No disponible / Non disponible	
Manual search / Búsqueda manual / Recherche manuelle	○ (Search speed is not constant. / La velocidad de búsqueda no es constante. / La vitesse de recherche n'est pas constante.)		
Maximum number of folder hierarchy / Máximo número de jerarquía de carpetas / Nombre maximum de hiérarchies de dossiers		8	
Maximum number of files/folders / Máximo número de archivos/carpetas / Nombre maximum de fichiers/dossiers	Folders on a disc / Carpetas en un disco / Dossiers sur un disque	200	
	Total / Total / Total	512	
Maximum number of characters on the display / Máximo número de caracteres en la pantalla / Nombre maximum de caractères sur l'afficheur	(including [.MP3] or [.WMA]) 128 (incluyendo [.MP3] o [.WMA]) (incluant [.MP3] ou [.WMA])	(including [.MP3]) 128 (incluyendo [.MP3]) (incluant [.MP3])	
Playback order / Orden de reproducción / Ordre de lecture		In the order of hierarchy / En el orden de la jerarquía / Dans l'ordre des hiérarchie	

Questions and Answers

An MP3/WMA disc requires a long readout time...?

When an MP3/WMA disc is inserted, information inside the disc (number of folders and files, and positions of data) is first read.

So, in the following cases, a fairly long time may be needed before playback starts:

- If the file structure is complicated,
- If the number of files is large, or
- If the number of sessions is large (in case of multi-session discs).

There occurs sound interruption or sound skipping...?

Sound interruption or sound skipping may occur, depending on recording conditions (missing data, etc.) or media conditions (stain, scratch, warp, etc.).

MP3/WMA files are not played back in an intended order...?

This player plays back MP3/WMA files in order of hierarchy levels.

- The playback order may differ from your intended order because of your writing software.

Elapsed playing time is not displayed correctly...?

Files recorded in VBR (variable bit rate) have a discrepancy in elapsed time display, and do not show the actual passage of time. Especially, after performing the search function, this difference becomes noticeable.

Preguntas y respuestas

¿Un disco MP3/WMA requiere un mayor tiempo de lectura...?

Cuando se inserta un disco MP3/WMA, primero se lee la información contenida dentro del disco (número de carpetas y archivos, y posiciones de los datos).

Por lo tanto, en los siguientes casos, es posible que se tarde un poco antes de iniciarse la reproducción:

- Si la estructura del archivo es complicado,
- Si el número de archivos es grande,
- Si el número de sesiones es grande (en caso de discos de múltiples sesiones).

¿Ocurre la interrupción de sonido o la omisión de sonido...?

Puede producirse interrupción u omisión de sonido, dependiendo de las condiciones de grabación (datos faltantes, etc.) o del medio (manchas, rayaduras, alabeo, etc.).

¿Los archivos MP3/WMA no se reproducen en el orden previsto...?

Este reproductor reproduce los archivos MP3/WMA en el orden de los niveles de jerarquía.

- El orden de reproducción puede ser distinto del orden previsto debido a su software de escritura.

¿El tiempo transcurrido no se visualiza correctamente...?

Los archivos grabados en VBR (velocidad de bit variable) presentan discrepancia en la visualización del tiempo transcurrido, y no visualizan exactamente el tiempo que transcurre. Especialmente, esta diferencia se vuelve más evidente después de realizar la función de búsqueda.

Questions et réponses

Le temps d'initialisation d'un disque MP3/WMA est plus long...?

Quand un disque MP3/WMA est inséré, les informations dans le disque (nombre de dossiers et de fichiers, position des données) sont lues.

Dans les cas suivants, un temps plus long peut être nécessaire avant que la lecture démarre:

- Si la structure des fichiers est compliquée.
- Si le nombre de fichiers est grand.
- Si le nombre de sessions est grand (dans le cas d'un disque multi sessions).

Il y a des interruptions de son ou le son est sauté...?

Des interruptions du son ou des sauts dans la lecture peuvent se produire en fonction des conditions d'enregistrement (données manquantes, etc.) ou des conditions du support (tâche, rayure, voilage, etc.).

Les fichiers MP3/WMA ne sont pas reproduits dans l'ordre souhaité...?

Ce lecteur reproduit les fichiers MP3/WMA dans l'ordre des niveaux de hiérarchie.

- L'ordre de lecture peut différer de l'ordre souhaité à cause du logiciel de gravure.

La durée de lecture écoutée n'est pas affichée correctement...?

Les fichiers enregistrés en mode VBR (débit binaire variable) ont une différence dans l'affichage de la durée de lecture écoutée et n'affiche pas le temps du passage actuel. Plus spécialement, la différence devient importante après l'utilisation de la fonction de recherche.

ENGLISH

BEFORE ELECTRICAL CONNECTIONS

The first and most important step in installation is to identify the wires inside the car you need to use. If you are not sure what wires are used for what purposes inside the car, read this sheet carefully.

What Leads Are inside the Car?

You need to identify the following leads used in the car (after removing an existing audio receiver or radio, if any, from your car).

Leads inside the car	Function (and where to connect on the receiver)
① Battery lead	Supplies a continuous power to your receiver even when the ignition key is turned off. This lead provides a continuous power to maintaining the clock and internal memory in the receiver. – Connect this lead to the yellow wire of the receiver.
② Power lead	Supplies power to your receiver when the ignition key is turned to the accessory position (ACC) or to the on position (ON). – Connect this lead to the red wire of the receiver.
③ Speaker leads	Connects to the speakers inside the car. – Connect these leads to the corresponding speaker wires of the receiver.
④ Automatic antenna lead	Supplies power to automatic power antenna if any. – If receiver has the blue-with-white-stripe wire, connect this lead to it.
⑤ Antenna lead	Connects to the car antenna. – Connect to the antenna input terminal of the receiver.

Required Tools

• Tools you must prepare:

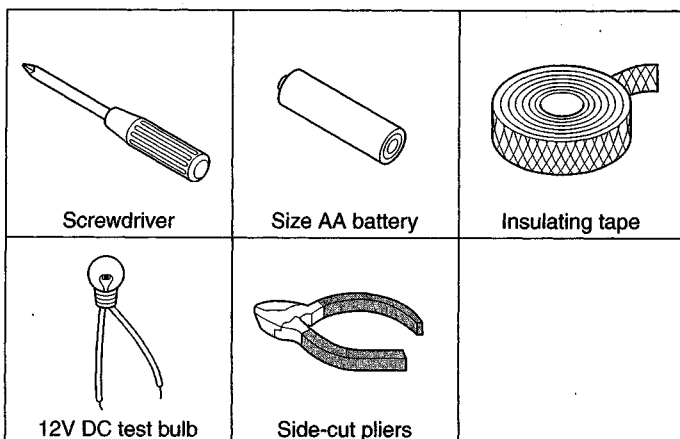

• Tools you had better prepare:



As you identify each lead, you can label it using masking tape and a permanent marker, and can note the colors of the leads used in the car. This will help avoid confusion when making connections later.

• For identifying method by using the above tools, see the reverse side.

ESPAÑOL

ANTES DE LAS CONEXIONES ELÉCTRICAS

El primer paso de la instalación y el más importante, es identificar cuáles son los cables del automóvil que se deben utilizar. Si tiene dudas acerca de los cables que se deben utilizar para cada propósito, lea esta hoja atentamente.

¿Qué conductores hay dentro del automóvil?

Es necesario que sepa identificar los siguientes conductores de su automóvil (tras desmontar el receptor de audio o la radio de su automóvil, si equiparse).

Conductores del interior del automóvil (y punto de conexión en el receptor)	Función
① Conductor de la batería	Suministra continuamente energía a su receptor incluso con el encendido desconectado. Este conductor suministra energía de manera continua para alimentar al reloj y a la memoria interna del receptor. – Conecte este conductor con el cable amarillo del receptor.
② Conductor de alimentación	Suministra energía a su receptor con la llave de contacto en la posición de accesorios (ACC) o en la posición de conexión (ON). – Conecte este conductor con el cable rojo del receptor.
③ Conductores de los altavoces	Efectúan la conexión con los altavoces del automóvil. – Conecte estos conductores con los correspondientes cables de altavoz del receptor.
④ Conductor de antena automática	Suministra energía a la antena motriz automática, si hubiere. – Si el receptor tiene cable azul con rayas blancas, conéctele este conductor.
⑤ Conductor de antena	Conecta con la antena del automóvil. – Conecte este conductor con el terminal de entrada de antena del receptor.

Herramientas requeridas

• Herramientas que debe preparar:

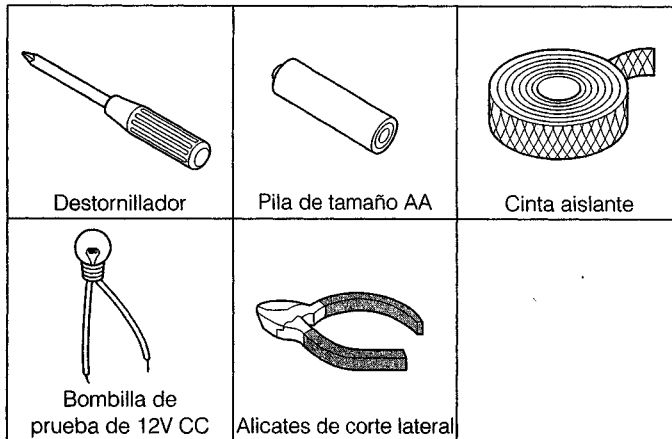

• Herramientas recomendadas:

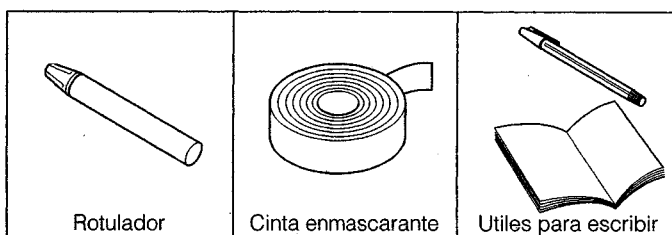

A medida que vaya identificando cada conductor, podrá ponerle una etiqueta utilizando cinta enmascarante y rotulador, y anotar los colores de los conductores empleados en su automóvil. Esto le ayudará a evitar confusiones a la hora de realizar las conexiones.

• Con respecto al método de identificación utilizando las herramientas de arriba, véase al dorso.

FRANÇAIS

AVANT LES CONNEXIONS ÉLECTRIQUES

La première et plus importante étape de l'installation est l'identification des fils de la voiture que vous devez utiliser. Si vous ne savez pas quelle est l'utilisation de chaque fil, lisez cette feuille attentivement.

Quels sont les fils de votre voiture?

Vous devez identifier les fils suivants dans votre voiture (après avoir retiré l'actuel et éventuel autoradio).

Fils à l'intérieur de la voiture	Fonction (et où connecter ces fils sur l'autoradio)
① Fil de batterie	Alimente en courant continu votre autoradio même quand le contact est coupé. Ce fil offre une alimentation continue qui permet de protéger l'horloge et la mémoire interne de l'autoradio. – Connectez ce fil au fil jaune de l'autoradio.
② Fil d'alimentation	Alimente votre autoradio quand la clé de contact est mise sur la position accessoire (ACC) ou sur la position marche (ON). – Connectez ce fil au fil rouge de l'autoradio.
③ Fils d'enceintes	Connectent les enceintes intérieures de la voiture. – Connectez ces fils aux fils correspondants sur l'autoradio.
④ Fil d'antenne automatique	Alimente l'antenne automatique s'il y en a une. – Si l'autoradio possède un fil bleu à bandes blanches, connectez-y ce fil.
⑤ Fil d'antenne	Connecte l'antenne de la voiture. – Connectez ce fil à la prise d'entrée d'antenne de l'autoradio.

Outils nécessaires

• Outils à préparer:

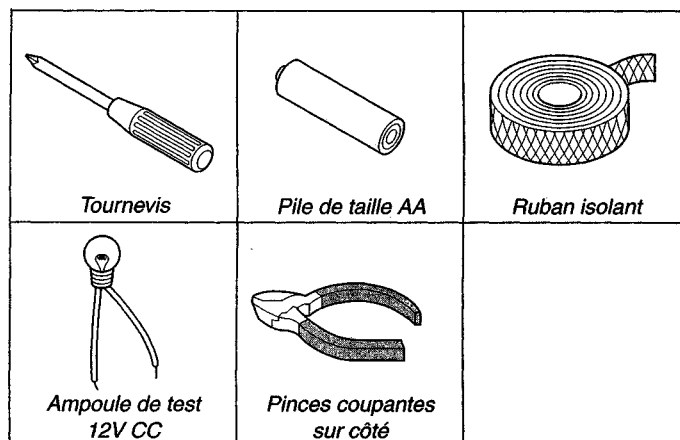

• Outils dont vous pouvez avoir besoin

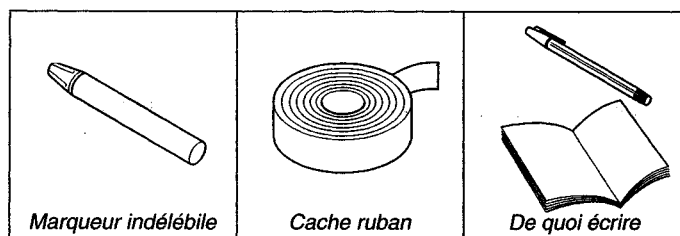

Au fur et à mesure que vous identifiez chaque fil, vous pouvez les étiqueter en utilisant le cache ruban et un marqueur indélébile et noter les couleurs des fils utilisés dans la voiture. Cela vous aidera à ne pas vous tromper lorsque vous ferez les connexions plus tard.

• Pour la méthode d'identification en utilisant les outils ci-dessus, reportez-vous au verso de cette feuille.

How to Identify the Leads inside the Car

Before start, make sure

- Check the speaker wiring inside the car first.
If speaker wiring is not appropriate (see "PRECAUTION on power supply and speaker connection" on the Installation/Connection Manual), first redo the speaker wiring inside the car.
- Pay much attention to avoid short-circuits. Insulate all exposed leads until you use them. Do not allow any exposed wire not in use to touch the metallic part or chassis of the car, and other exposed wires.
- If necessary, cut off the connector plug from leads coming from the car's battery (leaving the leads as long as possible) so that you can work with individual wires.

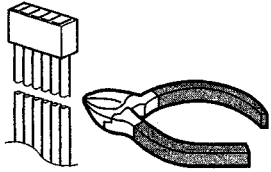
**① Battery lead**

■ If your car is pre-wired for the audio system:

- 1 Turn the ignition key to the off position (OFF).
- 2 Connect one lead of the test bulb to the metallic part or chassis of the car.
- 3 Touch the other lead of the test bulb to each wire inside the car.
 - Touch one wire at a time until you find a wire causing the test bulb to light. This wire is the battery lead.

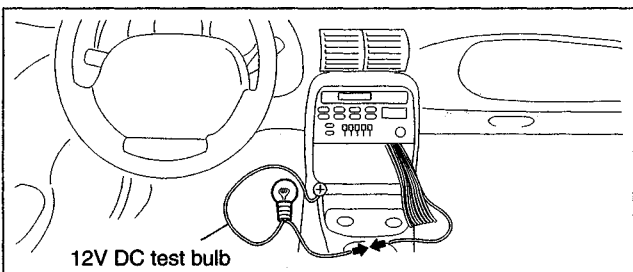

■ If your car is NOT pre-wired for the audio system:

- Find the fuse port preparing for a continuous power supply from the battery (usually marked BAT).

② Power lead

■ If your car is pre-wired for the audio system:

- 1 Turn the ignition key to the accessory position (ACC).
- 2 Connect one lead of the test bulb to the metallic part or chassis of the car.
- 3 Touch the other lead of the test bulb to each wire inside the car.
 - Touch one wire at a time until you find a wire causing the test bulb to light.
- 4 If you find one, turn the ignition key off then on. If the test bulb also turns off and on, it is the power lead. If it does not turn off though you turn off the ignition key, it is the battery lead (see above).

■ If your car is NOT pre-wired for the audio system:

- Find the fuse port preparing for a radio (RADIO) or an accessory (ACC) in the fuse block.

③ Speaker leads

Find two wires for each speaker by using a size AA battery as follows.

- 1 Turn the ignition key to the off position (OFF).
- 2 Touch one wire inside the car to one pole (+ or -) of the battery.
- 3 Touch another wire to the other of the battery. If you hear a scraping noise from a speaker, you find a correct combination of the speaker leads for the speaker.
- 4 Repeat steps 1 and 2 until you find all combinations of speaker leads for the other speakers.

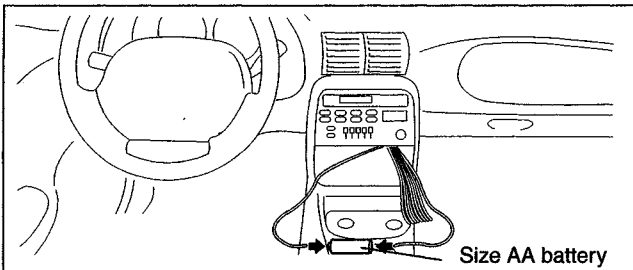
**④ Automatic antenna lead**

If your car is equipped with an automatic power antenna, find the automatic antenna lead.

- 1 Turn the ignition key to the accessory position (ACC).
- 2 Connect one lead of the test bulb to the battery lead (①) you have found.
- 3 Touch the other lead of the test bulb to each wire inside the car.
 - Touch one wire at a time until you find a wire causing the automatic power antenna to extend. This wire is the automatic antenna lead.

⑤ Antenna lead

This is a thick, black wire with a metal plug. Easily identified by its appearance. (See "A Typical Connections" on the Installation/Connection Manual.)

Cómo identificar los conductores empleados en el automóvil

Antes de comenzar, asegúrese de

- Comprobar primero el cableado de los altavoces del automóvil.
Si el cableado de los altavoces no es apropiado (consulte "PRECAUCIONES sobre la fuente de alimentación y la conexión de los altavoces" en el manual de instalación/conexión), primero deberá rehacer el cableado de los altavoces del interior del automóvil.
- Prestar suma atención para evitar cortocircuitos. Asegurarse de aislar todos los conductores al descubierto hasta el momento de utilizarlos. Ningún cable al descubierto sin utilizar deberá estar en contacto con alguna parte metálica o el chasis del automóvil o con otros cables al descubierto.
- Si es necesario, cortar la clavija de conexión y separarla de los conductores procedentes de la batería del automóvil (dejando los conductores lo más largo posible) de manera que pueda trabajar individualmente con cada cable.

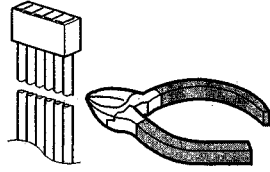
**① Conductor de la batería**

■ Si su automóvil está precableado para el sistema de audio:

- 1 Gire la llave de contacto a la posición de desconexión (OFF).
- 2 Conecte un conductor de la bombilla de prueba con la parte metálica o el chasis del automóvil.
- 3 Con el otro conductor de la bombilla de prueba toque uno por uno los cables del interior del automóvil.
 - Toque los cables de a uno hasta encontrar el que haga iluminar la bombilla de prueba. Este cable es el conductor de la batería.

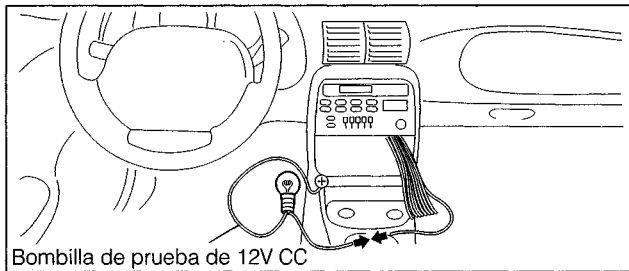

■ Si su automóvil NO está precableado para el sistema de audio:

- Localice el puerto de fusible y prepárelo para suministrar continuamente energía desde la batería (normalmente marcado BAT).

② Conductor de alimentación

■ Si su automóvil está precableado para el sistema de audio:

- 1 Gire la llave de contacto a la posición de accesorios (ACC).
- 2 Conecte un conductor de la bombilla de prueba con la parte metálica o el chasis del automóvil.
- 3 Con el otro conductor de la bombilla de prueba toque uno por uno los cables del interior del automóvil.
 - Toque los cables de a uno hasta encontrar el que haga iluminar la bombilla de prueba.
- 4 Si lo encuentra, desconecte y vuelva a conectar la llave de contacto. Si la bombilla de prueba también se apaga y se enciende, significa que es el conductor de alimentación. Si la bombilla no se apaga al desconectar la llave de contacto, significa que se trata del conductor de la batería (véase arriba).

■ Si su automóvil NO está precableado para el sistema de audio:
Localice el puerto de fusible y prepárelo para la radio (RADIO) o un accesorio (ACC) en el bloque de fusibles.

③ Conductores de los altavoces

Utilizando una pila de tamaño AA, localice dos cables para cada altavoz, de la siguiente manera.

- 1 Gire la llave de contacto a la posición de desconexión (OFF).
- 2 Toque un polo (+ o -) de la pila con uno de los cables del interior del automóvil.
- 3 Toque el otro polo de la pila con otro cable. Si el altavoz produce rechinar, significa que ha encontrado la combinación correcta de conductores para el altavoz.
- 4 Repita los pasos 1 y 2 hasta encontrar todas las combinaciones de conductores para los demás altavoces.

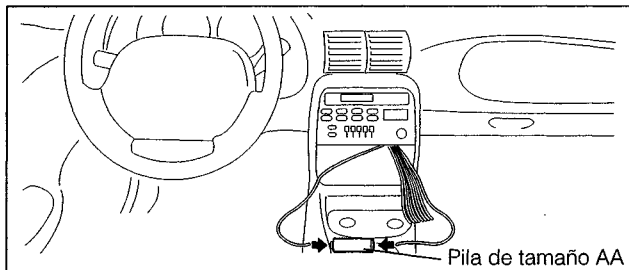
**④ Conductor de antena automática**

Si su automóvil se encuentra equipado con una antena motriz automática, localice el conductor de la antena automática.

- 1 Gire la llave de contacto a la posición de accesorios (ACC).
- 2 Conecte un conductor de la bombilla de prueba con el conductor de batería (①) localizada previamente.
- 3 Toque cada uno de los cables del interior del automóvil con el otro conductor de la bombilla de prueba.
 - Toque los cables de a uno hasta encontrar el que haga extender la antena motriz automática. Este cable es el conductor de antena automática.

⑤ Conductor de antena

Este es un cable grueso y negro con clavija de metal. Se identifica fácilmente por su apariencia. (Consulte "A Conexiones típicas" en el manual de instalación/conexión.)

Comment identifier les fils de votre voiture

Avant de commencer, veuillez vous assurer des choses suivantes

- Vérifiez d'abord le câblage des enceintes de la voiture.
Si le câblage des enceintes n'est pas correct (voir "PRÉCAUTIONS sur l'alimentation et la connexion des enceintes" dans le manuel d'installation/connexion), refaites d'abord le câblage des enceintes de la voiture.
- Faites attention d'éviter les courts-circuits. Isolez tous les fils à nu jusqu'à ce que vous les utilisiez. Ne laissez aucun fil à nu inutilisé toucher la partie métallique ou le châssis de la voiture ni les autres fils à nu.
- Si nécessaire, coupez la fiche de connexion des fils provenant de la batterie de la voiture (laissez les fils aussi longs que possible) de façon à pouvoir travailler sur un fil particulier.

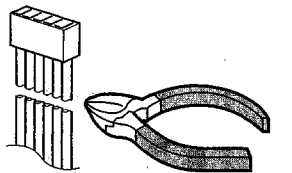
**① Fil de batterie**

■ Si votre voiture possède déjà un câblage pour système audio:

- 1 Mettez la clé de contact sur la position d'arrêt (OFF).
- 2 Connectez un fil de l'ampoule de test à une partie métallique ou au châssis de la voiture.
- 3 Avec l'autre fil de l'ampoule de test, touchez chaque fil de la voiture.
 - Touchez un fil à la fois jusqu'à ce que vous ayez trouvé celui qui allume l'ampoule de test. Ce fil est le fil de batterie.

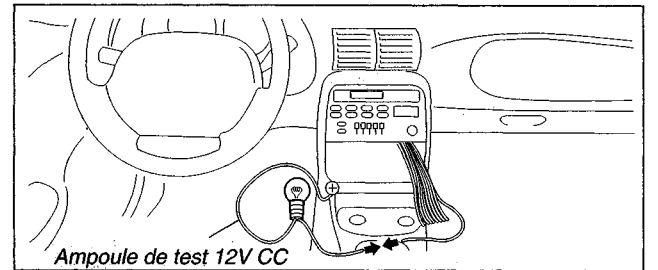

■ Si votre voiture ne possède pas de câblage pour système audio:

- Trouvez la prise fusible prévue pour une alimentation continue à partir de la batterie (marquée habituellement BAT).

② Fil d'alimentation

■ Si votre voiture possède déjà un câblage pour système audio:

- 1 Mettez la clé de contact sur la position accessoire (ACC).
- 2 Connectez un fil de l'ampoule de test à une partie métallique ou au châssis de la voiture.
- 3 Avec l'autre fil de l'ampoule de test, touchez chaque fil de la voiture.
 - Touchez un fil à la fois jusqu'à ce que vous ayez trouvé celui qui allume l'ampoule de test. Ce fil est le fil de batterie.
- 4 Une fois que vous avez trouvé un fil, tournez la clé de contact sur la position d'arrêt (OFF) puis de nouveau en position accessoire. Si l'ampoule de test s'éteint et s'allume aussi, c'est le fil d'alimentation. Si elle ne s'éteint pas quand vous mettez la clé de contact en position d'arrêt, c'est le fil de batterie (voir ci-dessus).

■ Si votre voiture ne possède pas de câblage pour système audio:

- Trouvez la prise fusible prévue pour la radio (RADIO) ou pour les accessoires (ACC) (marquée habituellement BAT) dans la boîte à fusibles.

③ Fils d'enceintes

Trouvez deux fils d'enceinte pour chaque enceinte en utilisant la pile AA de la façon suivante.

- 1 Mettez la clé de contact en position d'arrêt (OFF).
- 2 Touchez une des bornes de la pile (+ ou -) avec un des deux fils.
- 3 Touchez l'autre borne de la pile avec le deuxième fil. Vous entendrez des grésillements dans une enceinte et cela vous permettra de trouver les combinaisons correctes des fils d'enceinte.
- 4 Répétez les étapes 1 et 2 jusqu'à ce que vous ayez trouvé toutes les combinaisons de fils de toutes les enceintes.

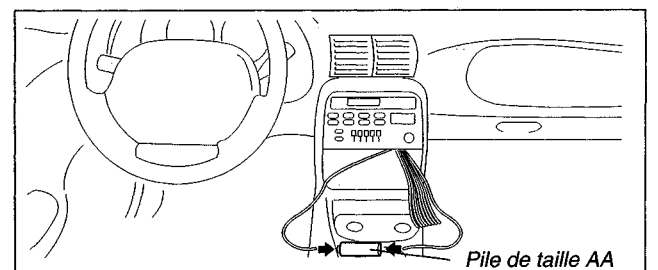
**④ Fil d'antenne automatique**

Si votre voiture est équipée d'une antenne électrique automatique, trouvez le fil correspondant.

- 1 Mettez la clé de contact sur la position accessoire (ACC).
- 2 Connectez un des fils de l'ampoule de test au fil de batterie (①) que vous avez trouvé.
- 3 Avec l'autre fil de l'ampoule de test, touchez chaque fil de la voiture.
 - Touchez un fil à la fois jusqu'à ce que vous ayez trouvé celui qui provoque le déploiement de l'antenne. C'est le fil d'antenne automatique.

⑤ Fil d'antenne

C'est un câble noir épais avec une fiche métallique. Elle peut être identifiée facilement par sa forme. (Reportez-vous à "A Connexions typiques" dans le manuel d'installation/connexion.)

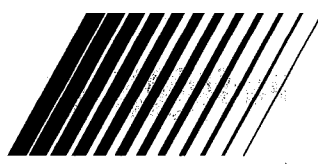

Having TROUBLE with operation? Please check this Troubleshooting Guide. Still having trouble??

USA ONLY

Call **1-800-252-5722**

<http://www.jvc.com>

We can help you!

Since the descriptions in this troubleshooting guide have been designated to be applied to JVC's standard CD Receiver, some of the functions and operations described may not be applied exactly to your receiver.

If they cannot be applied exactly, refer also to the Instructions and Installation/Connection manual supplied with your receiver for details on the actual functions and operations, and cope with your troubles properly.

TROUBLESHOOTING GUIDE For CD Receiver

SYMPTOMS	CAUSES	REMEDIES
No sound comes out of the speakers.	The speaker wiring is not correctly finished.	Check if the speaker wiring is correctly finished, by referring to the Installation/Connection manual.
	Speaker cables are short-circuited.	Check if each cable is not cut or caught in the bracket or shorted by some other metallic parts. <i>To prevent any short-circuit, cover the ends of any unused cable with insulating tape.</i>
	Original speaker wiring in the car has a common ground for both left and right speakers or speaker wiring is earthed to the metallic body or chassis of the car.	Do not use the original speaker wiring in the car. Redo the speaker wiring by referring to the Installation/Connection manual.
	Speaker cable connection or soldering is not intact.	Check if the speaker cable connection is correct and intact, by using a tester or other measuring devices.
	Volume is set to the minimum level.	Adjust the volume to the optimum level. <i>If this does not work, check and adjust the fader and balance settings.</i>
	Power amplifier built in this unit has been deactivated.	Activate the built-in power amplifier by turning on the power amplifier on/off switch. <i>Refer to the Instructions manual.</i>
	When using an external power amplifier: The remote cable is not connected correctly.	Check if the remote cable connection is correct and intact, by using a tester or other measuring devices.
	The microcomputer built in this unit malfunctions due to noise, etc.	Press the Reset button, or press and hold the POWER and SEL buttons at the same time for more than 2 seconds to reset the microcomputer. <i>The clock setting and other preset setting such as preset stations will be erased.</i>
	Others.	The unit is damaged. <i>Consult with your JVC car audio dealer.</i>

Troubleshooting for CD Receiver

SYMPTOMS	CAUSES	REMEDIES
The unit does not turn on.	The power cords are not connected correctly.	Check if the connection is correctly finished, by referring to the Installation/Connection manual.
		Check if the original wiring in the car has been correctly finished, especially on the following terminal connections — Constant 12 volts, ACC (accessory), ground.
	A fuse has blown (in the unit or in the fuse block of the car).	Check if the connection and the original wiring in the car are correct, then replace the fuse. <i>If the fuse blows frequently, consult with your JVC car audio dealer.</i>
	The ground cable is not correctly earthed.	Check if the ground cable connection is correct and intact, by using a tester or other measuring devices. <i>If the ground cable is connected to a painted metallic part, sand off the paint from or connect to an unpainted metallic part.</i>
	Wiring is short-circuited.	Check if each cable is not cut or caught in the bracket or shorted by some other metallic parts.
	The car battery is exhausted. (The voltage power is less than 11 volts.)	Have the car battery and electrical system checked so that a proper output voltage (11 to 16 volts) is obtained. CAUTION: NEVER use a 24-volt battery.
	The microcomputer built in this unit malfunctions due to noise, etc.	Press the Reset button, or press and hold the POWER and SEL buttons at the same time for more than 2 seconds to reset the microcomputer. <i>The clock setting and other preset setting such as preset stations will be erased.</i>
Others.	The unit is damaged. <i>Consult with your JVC car audio dealer.</i>	

SYMPTOMS	CAUSES	REMEDIES
CD sound is sometimes interrupted.	Used while driving on rough roads. (The unit is subjected to extreme shock.)	Check if the unit can play back a CD normally on a flat road.
	CD is scratched.	Check if the unit can play back another CD normally. <i>If CD sound is not interrupted while playing back another CD, there is nothing wrong with this unit.</i>
	CD is stained by fingerprints, grease, etc.	Clean CD with a commercially available cleaner.
	Pickup lens inside the unit is stained.	Clean the lens by using a commercially available pickup lens cleaner. CAUTION: NEVER use a cleaner with a detachable brush.
	Interference from the cellular phone.	Keep the phone away from the unit.
	The microcomputer built in this unit malfunctions due to noise, etc.	Press the Reset button, or press and hold the POWER and SEL buttons at the same time for more than 2 seconds to reset the microcomputer. <i>The clock setting and other preset setting such as preset stations will be erased.</i>
	Others.	The unit is damaged. <i>Consult with your JVC car audio dealer.</i>

SYMPTOMS	CAUSES	REMEDIES
The unit does not operate at all.	Detachable control panel connection is not intact.	Clean the connectors on both detachable control panel and on the main unit, by referring to the Instructions manual.
	The microcomputer built in this unit malfunctions due to noise, etc.	Press the Reset button, or press and hold the POWER and SEL buttons at the same time for more than 2 seconds to reset the microcomputer. <i>The clock setting and other preset setting such as preset stations will be erased.</i>
	Others.	The unit is damaged. <i>Consult with your JVC car audio dealer.</i>

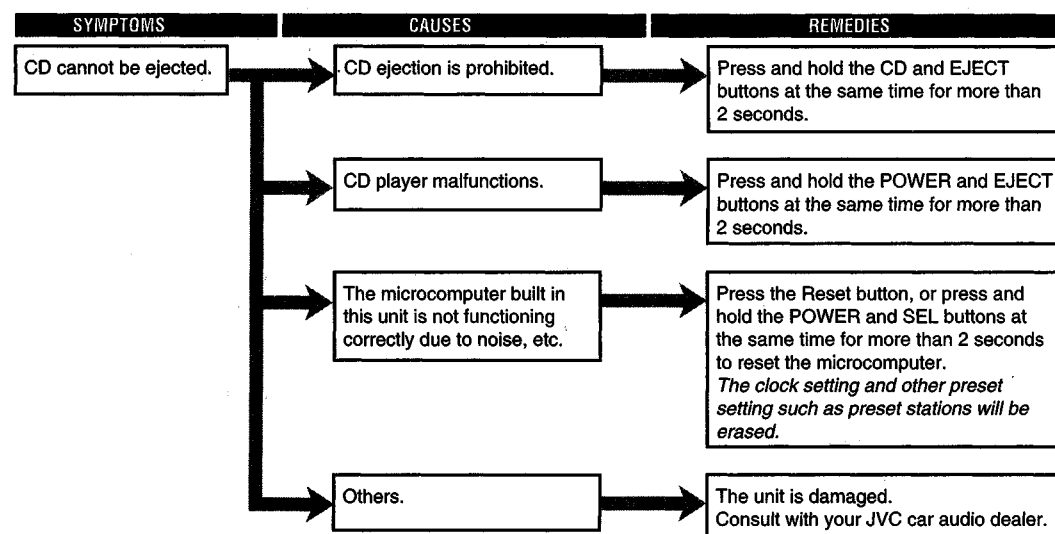
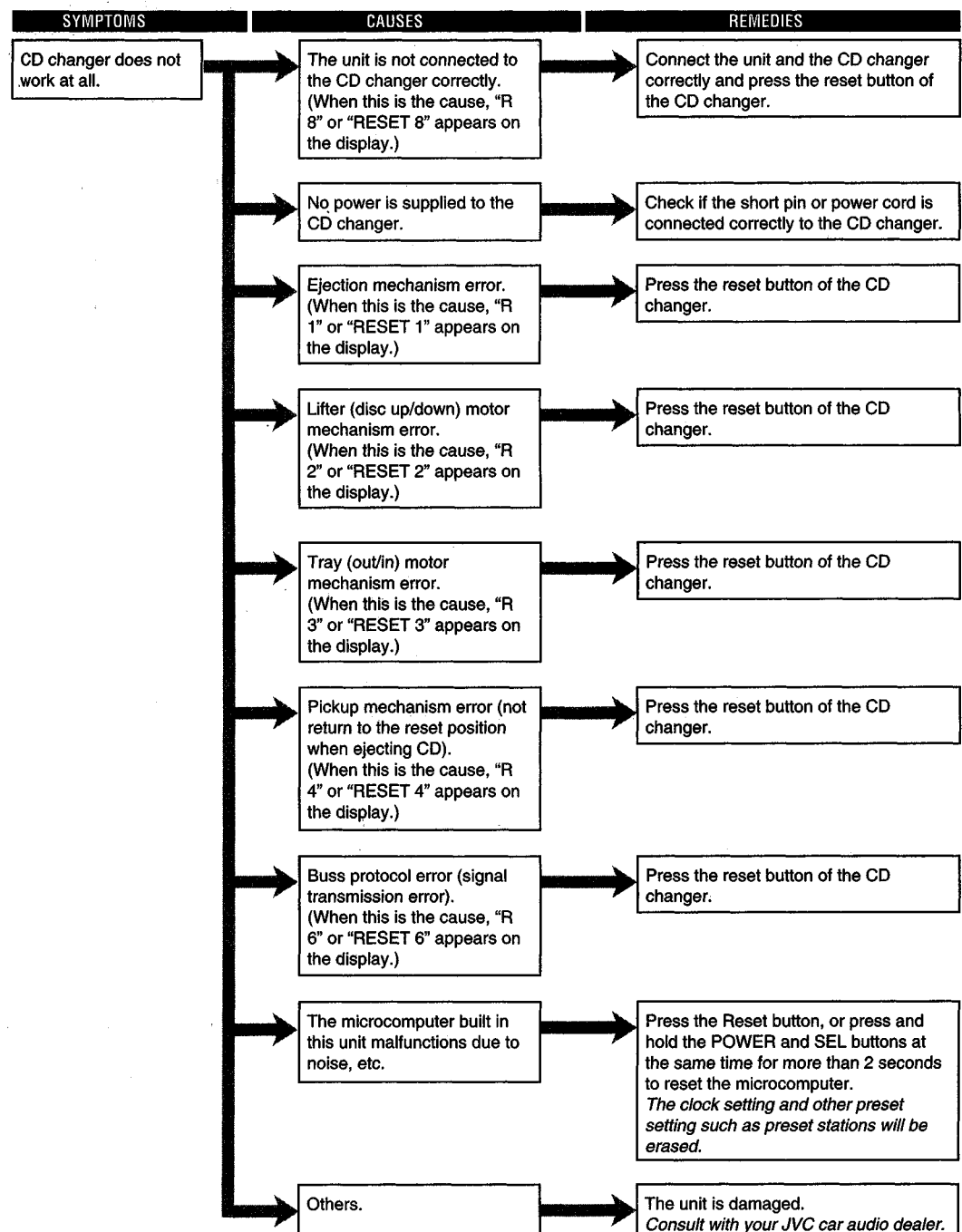
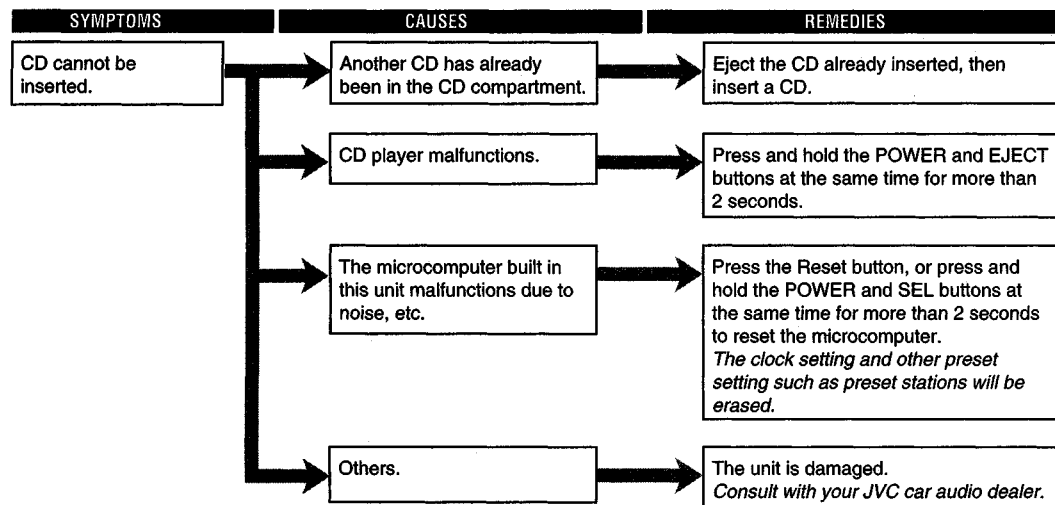
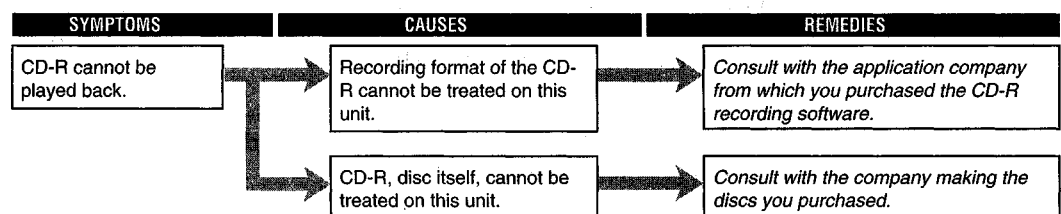
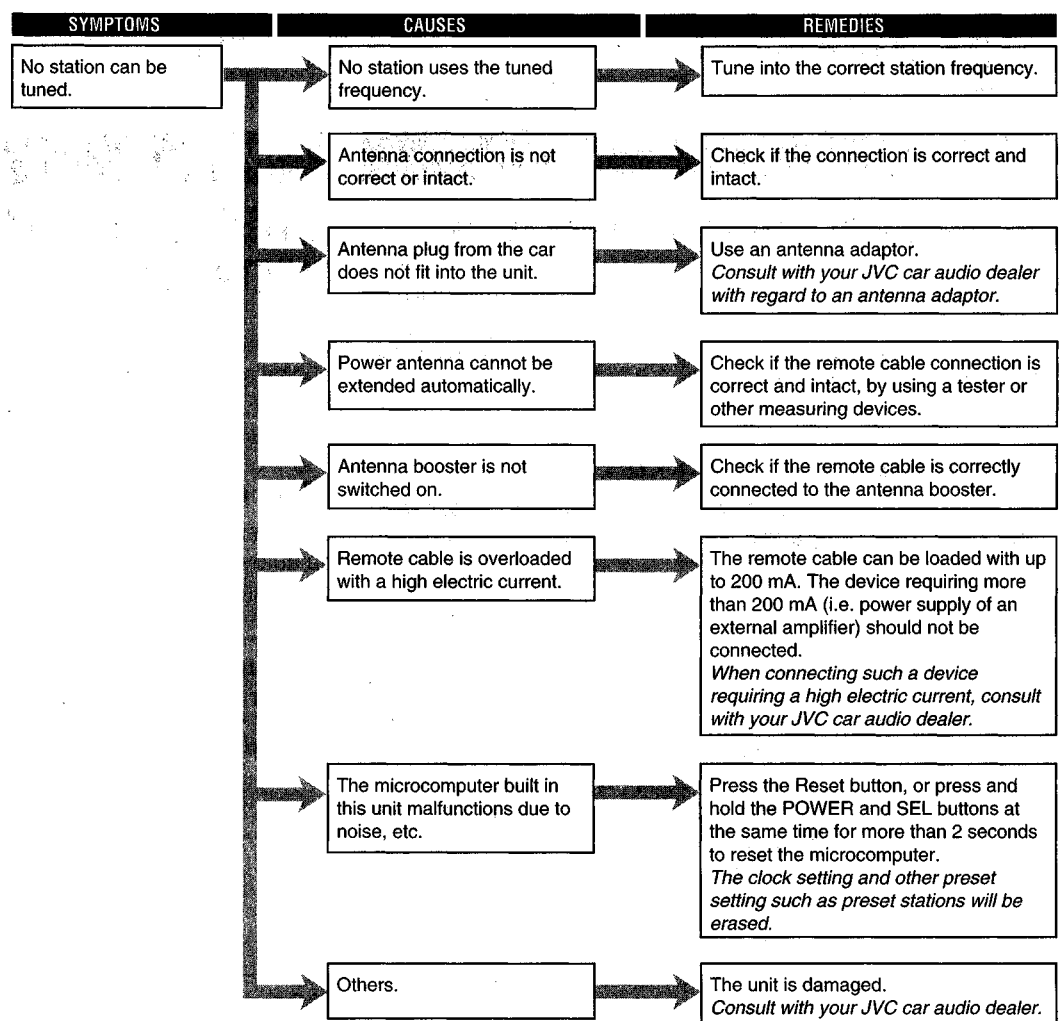
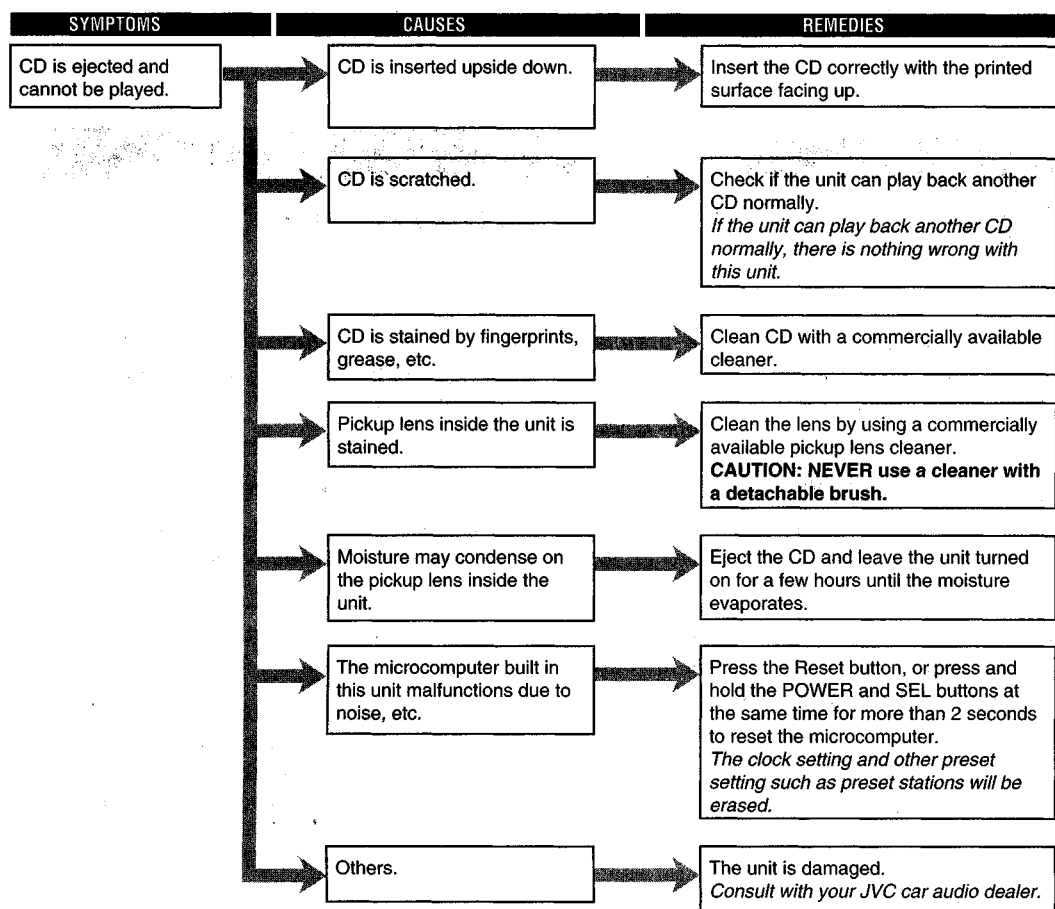

Thank you for purchasing

JVC[®]

Instructions
Fold so opening is at the top.
Tape in middle or on front.

Please do not send products or other
correspondence to this address.

307C



PLACE
FIRST-CLASS
STAMP
HERE

JVC[®]
PO BOX 3434
PEORIA IL 61612-3434



PRODUCT REGISTRATION CARD/QUESTIONNAIRE

US CUSTOMERS ONLY

Registering your product will allow us to contact you in the unlikely event a product safety notification is required.

This is not a warranty card. Retain your bill of sale for proof of warranty coverage.

THANK YOU FOR PURCHASING THIS JVC PRODUCT

REGISTER ONLINE AT: WWW.JVC.COM

JVC® Product Registration

IMPORTANT: Please fill-out and return in 10 days or Log to JVC.com and register On-Line

First Name: _____
Last Name: _____
Address: _____
Apt #^o: _____
City: _____
State: _____
Zip: _____
Phone: _____
Email Address: _____

Thank you! We appreciate your responses to this questionnaire. The information you choose to share with us will be used by JVC to offer you product information and other communications that may interest you. If you prefer not to be contacted about these special offers, please check here. { }

Date of Purchase _____
Model Number _____
Serial Number _____
Purchase Price _____
Dealer _____

1) Did you:

- Purchase this product your self?
- Receive this product as a gift?

5) Your Gender:

- Male
- Female

2) Is this Product:

- The first product of this type you have ever owned?
- A replacement for a similar JVC product?
- A replacement for a similar product made by another company?
- An addition to a similar product you are still using?

6) Your Marital Status

- Married
- Single

3) What factors most influenced your decision to purchase this product?

- JVC brand reputation
- Previous experience with JVC products
- Price
- Specific product features
- Style/appearance
- Salesperson's recommendation
- Friend/relative's recommendation
- Warranty coverage
- Other

7) What is your approximate annual household income level?

- Under \$25,000
- \$25,000 – \$49,000
- \$50,000 – \$74,000
- \$75,000 – \$99,000
- \$100,000 and over

Comments:

4) How did you learn about this product?

- Magazine Advertisement
- Newspaper Advertisement
- TV/Radio Announcement
- Product Brochure
- Direct Mail
- Mail Order Catalog
- Friend/Relative Recommendations
- Salesperson/Store Recommendation
- Internet
- Dealer Event
- Other

JVC Thanks you for completing this questionnaire. Your responses will help us reach you with offers that may interest you. If you prefer not to receive these offers please check here { }

Authorized Service Centers

QUALITY **JVC**[®] SERVICE

HOW TO LOCATE YOUR JVC SERVICE CENTER

TOLL FREE: 1 (800) 537-5722

<http://www.jvc.com>

Dear Customer,

In order to receive the most satisfaction from your purchase, please read the instruction booklet before operating the unit. In the event that repairs are necessary, please call 1 (800)537-5722 for your nearest authorized servicer or visit our website at **www.JVC.com**

Remember to retain your Bill of Sale for Warranty Service.

Do not service the television yourself

Caution

To prevent electrical shock, do not open the cabinet. There are no user serviceable parts inside. Please refer to qualified service personnel for repairs.

Accessories

To purchase accessories for your JVC product, please call toll free: 1 (800)882-2345 or on the web at **www.JVC.com**



LIMITED WARRANTY

AUDIO-2 **USA ONLY**

ONLY FOR PRODUCT PURCHASED IN U.S.A.

JVC Company of America (JVC) warrants this product and all parts thereof, except as set forth below ONLY TO THE ORIGINAL PURCHASER AT RETAIL to be FREE FROM DEFECTIVE MATERIALS AND WORKMANSHIP from the date of the original purchase for the period shown below. ("The Warranty Period")

PARTS	2 YRS	LABOR	2 YRS
-------	--------------	-------	--------------

THIS LIMITED WARRANTY IS VALID ONLY IN THE FIFTY (50) UNITED STATES, THE DISTRICT OF COLUMBIA AND IN COMMONWEALTH OF PUERTO RICO.

WHAT WE WILL DO:

If this product is found to be defective within the warranty period, JVC will repair or replace defective parts at no charge to the original owner. Such repair and replacement services shall be rendered by JVC during normal business hours at JVC authorized service centers. Parts used for replacement are warranted only for the remainder of the Warranty Period. All products must be brought or shipped to a JVC authorized service center.

WHAT YOU MUST DO FOR WARRANTY SERVICE:

Either contact the selling dealer or call 1-800-537-5722 to locate the nearest JVC authorized service center. Service locations can also be obtained from our website <http://www.jvc.com>.

If service is not available locally, box the product carefully, preferably in the original carton, and ship, insured, with a copy of your bill of sale plus a letter explaining the problem to the nearest JVC authorized service center, the location of which will be provided by the toll-free number.

If you have any questions concerning your JVC Product, please contact our Customer Relations Department at 800-252-5722

WHAT IS NOT COVERED:

This limited warranty provided by JVC does not cover:

1. Products which have been subject to abuse, accident, alteration, modification, tampering, negligence, misuse, faulty installation, lack of reasonable care, or if repaired or serviced by anyone other than a service facility authorized by JVC to render such service, or if affixed to any attachment not provided with the products, or if the model or serial number has been altered, tampered with, defaced or removed;
2. Initial installation, installation and removal from cabinets or mounting systems.
3. Operational adjustments covered in the Owner's Manual, normal maintenance, video and audio head cleaning.
4. Damage that occurs in shipment, due to act of God, and cosmetic damage.
5. Signal reception problems and failures due to line power surge.
6. Products used for commercial purposes, including, but not limited to rental.
7. Accessories
8. Batteries (except that Rechargeable Batteries are covered for 90 days from the date of purchase).

There are no express warranties except as listed above.

THE DURATION OF ANY IMPLIED WARRANTIES, INCLUDING THE IMPLIED WARRANTY OF MERCHANTABILITY, IS LIMITED TO THE DURATION OF THE EXPRESS WARRANTY HEREIN.

JVC SHALL NOT BE LIABLE FOR ANY LOSS OF USE OF THE PRODUCT, INCONVIENCE, OR ANY OTHER DAMAGES, WHETHER DIRECT, INCIDENTAL OR CONSEQUENTIAL (INCLUDING, WITHOUT LIMITATION, DAMAGE TO TAPES, RECORDS OR DISCS) RESULTING FROM THE USE OF THIS PRODUCT, OR ARISING OUT OF ANY BREACH OF THIS WARRANTY. ALL EXPRESS AND IMPLIED WARRANTIES, INCLUDING THE WARRANTIES OF MERCHANTABILITY AND FITNESS FOR PARTICULAR PURPOSE, ARE LIMITED TO THE WARRANTY PERIOD SET FORTH ABOVE.

Some states do not allow the exclusion of incidental or consequential damages or limitations on how long an implied warranty lasts, so these limitations or exclusions may not apply to you. This warranty gives you specific legal rights and you may also have other rights which vary from state to state.

JVC COMPANY OF AMERICA
 DIVISION OF JVC AMERICAS CORP.
<http://www.jvc.com>

1700 Valley Road
 Wayne, New Jersey 07470

REFURBISHED PRODUCTS CARRY A SEPARATE WARRANTY, THIS WARRANTY DOES NOT APPLY. FOR DETAIL OF REFURBISHED PRODUCT WARRANTY, PLEASE REFER TO THE REFURBISHED PRODUCT WARRANTY INFORMATION PACKAGED WITH EACH REFURBISHED PRODUCT.

For customer use:

Enter below the Model No. and Serial No. which is located either on the rear, bottom or side of the cabinet. Retain this information for future reference.

Model No. : _____ Serial No. : _____

Purchase data : _____ Name of dealer : _____

Free Manuals Download Website

<http://myh66.com>

<http://usermanuals.us>

<http://www.somanuals.com>

<http://www.4manuals.cc>

<http://www.manual-lib.com>

<http://www.404manual.com>

<http://www.luxmanual.com>

<http://aubethermostatmanual.com>

Golf course search by state

<http://golfingnear.com>

Email search by domain

<http://emailbydomain.com>

Auto manuals search

<http://auto.somanuals.com>

TV manuals search

<http://tv.somanuals.com>