

JVC



ENGLISH

FRANÇAIS

NEDERLANDS

CD RECEIVER RECEPTEUR CD CD-RECEIVER

KD-DB711

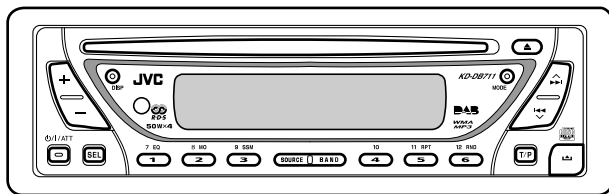
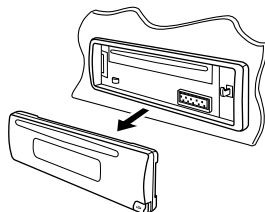

WMA MP3



For canceling the display demonstration, see page 7.
Pour annuler la démonstration des affichages, référez-vous à la page 7.
Zie bladzijde 7 voor het annuleren van de displaydemonstratie.

For installation and connections, refer to the separate manual.
Pour l'installation et les raccordements, se référer au manuel séparé.
Bijzonderheden over de installatie en aansluiting van het apparaat vindt u in de desbetreffende handleiding.

INSTRUCTIONS MANUEL D'INSTRUCTIONS GEBRUIKSAANWIJZING

LVT1309-003A
[EX]

Thank you for purchasing a JVC product.

Please read all instructions carefully before operation, to ensure your complete understanding and to obtain the best possible performance from the unit.

IMPORTANT FOR LASER PRODUCTS

1. CLASS 1 LASER PRODUCT
2. **CAUTION:** Do not open the top cover. There are no user serviceable parts inside the unit; leave all servicing to qualified service personnel.
3. **CAUTION:** Visible and invisible laser radiation when open and interlock failed or defeated. Avoid direct exposure to beam.
4. REPRODUCTION OF LABEL: CAUTION LABEL, PLACED OUTSIDE THE UNIT.

CAUTION: Visible and invisible laser radiation when open and interlock failed or defeated. AVOID DIRECT EXPOSURE TO BEAM.	ADVARSEL: Synlig og usynlig laserstråling når maskinen er åpen eller interlocken fejler. Undgå direkte eksponering til strålingen.	WARNING: Synlig och osynlig laserstrålning när den öppnas och spärren är urkopplad. Beträkta ej strålen.	VARO: Avlåtassa ja suoja-alkutus ohjelutuna tai viäläisena ollet antinna näkyvälle ja näkymättömälle laserstrålelle. Vältä säteeseen kohdistumista suoraan itseesi. (f)
--	---	---	--

Warning:

If you need to operate the receiver while driving, be sure to look ahead carefully or you may be involved in a traffic accident.

How to reset your unit

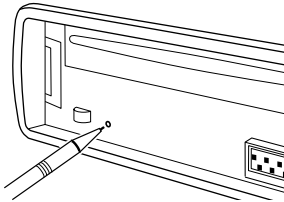

This will reset the microcomputer. Your preset adjustments will also be erased.

How to forcibly eject a disc

If a disc cannot be recognized by the receiver or cannot be ejected, ejects the disc as follows.



- If this does not work, try to reset your receiver.
- Be careful not to drop the disc when it ejects.

For security reasons, a numbered ID card is provided with this receiver, and the same ID number is imprinted on the receiver's chassis. Keep the card in a safe place, as it will help the authorities to identify your receiver if stolen.

Contents

How to reset your unit	2	Disc operations	16
How to forcibly eject a disc	2	Playing a disc	16
How to read this manual	4	Changing the display information	18
How to use the MODE button	4	Selecting the playback modes.....	19
Control panel — KD-DB711	5	Sound adjustments	20
Parts identification.....	5	Selecting preset sound modes	
Getting started.....	6	(C-EQ: custom equalizer)	20
Basic operations.....	6	Adjusting the sound.....	21
Canceling the display demonstration.....	7	General settings — PSM	22
Setting the clock	7	Basic procedure	22
Radio operations	8	Detaching the control	
Listening to the radio.....	8	panel	25
Storing stations in memory.....	9	Using the remote controller	
Listening to a preset station	10	— RM-RK60.....	26
FM RDS operations.....	11	Main elements and features	26
Searching for your favorite FM RDS		Maintenance	27
programme	11	More about this receiver	28
Storing your favorite programmes.....	12	Troubleshooting	31
Using the standby receptions.....	12	Specifications	33
Tracking the same programme			
—Network-Tracking Reception	13		
DAB tuner operations	14		
Listening to the DAB tuner	14		
Storing DAB services in memory.....	15		
Tuning in to a preset DAB service	15		
Tracing the same programme			
—Alternative Frequency Reception...	15		
Other Main DAB Features.....	15		

*For safety....

- Do not raise the volume level too much, as this will block outside sounds, making driving dangerous.
- Stop the car before performing any complicated operations.



*Temperature inside the car....

If you have parked the car for a long time in hot or cold weather, wait until the temperature in the car becomes normal before operating the unit.

How to read this manual

The following methods are used to make the explanations simple and easy-to-understand:

- Some related tips and notes are explained in “More about this receiver” (see pages 28–30).
- Button operations are mainly explained with the illustrations as follows:

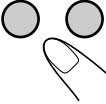
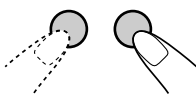
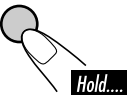
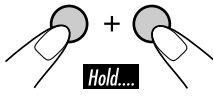
	Press briefly.
	Press repeatedly.
	Press either one.
	
	Press and hold until your desired response begins.
	Press and hold both buttons at the same time.

How to use the MODE button

If you press MODE, the receiver goes into functions mode, then the number buttons and \wedge \triangleright \blacktriangleleft \blacktriangleright \blacktriangledown buttons work as different function buttons.

Ex.: When number button 2 works as MO (monaural) button.

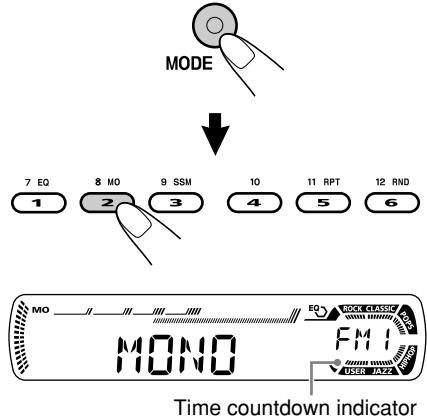

To use these buttons for original functions again after pressing **MODE**, wait for 5 seconds without pressing any of these buttons until the functions mode is cleared.

- Pressing **MODE** again also clears the functions mode.

Caution on volume setting:

Discs produce very little noise compared with other sources. Lower the volume before playing a disc to avoid damaging the speakers by the sudden increase of the output level.

Parts identification

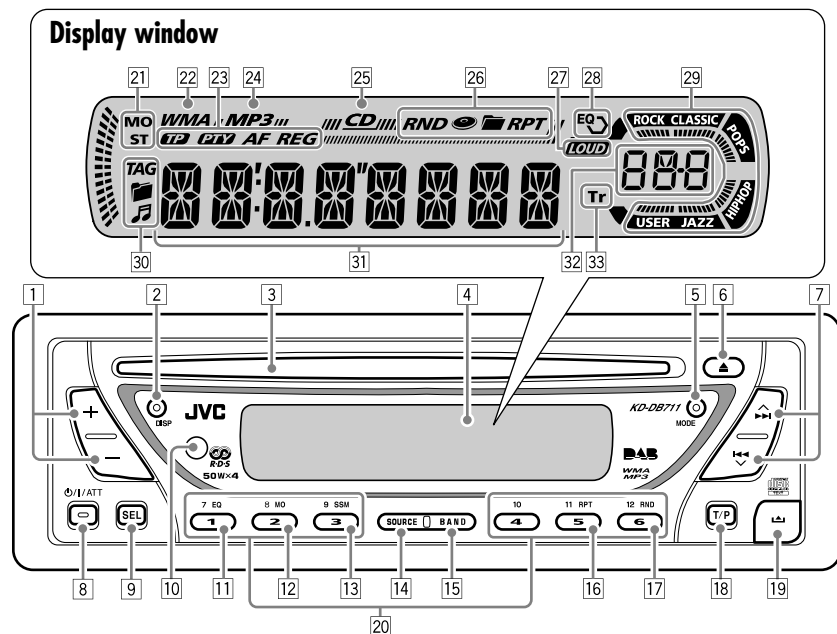

- 1 +/- buttons
- 2 DISP (display) button
- 3 Loading slot
- 4 Display window
- 5 MODE button
- 6 ▲ (eject) button
- 7 ▲▶▶/|◀◀▼ buttons
- 8 ⏻/I/ATT (standby/on/attenuator) button
- 9 SEL (select) button
- 10 Remote sensor
• See page 26.
- 11 EQ (equalizer) button
- 12 MO (monaural) button
- 13 SSM (Strong-station Sequential Memory) button
- 14 SOURCE button
- 15 BAND button
- 16 RPT (repeat) button
- 17 RND (random) button
- 18 T/P (traffic programme/programme type) button
- 19 ⏏ (control panel release) button
- 20 Number buttons

Display window

- 21 Tuner reception indicators—MO (monaural), ST (stereo)
- 22 WMA indicator
- 23 RDS indicators—TP, PTY, AF, REG
- 24 MP3 indicator
- 25 CD indicator
- 26 Playback mode / item indicators—RND (random), (disc), (folder), RPT (repeat)
- 27 LOUD (loudness) indicator
- 28 EQ (equalizer) indicator
- 29 Sound mode (C-EQ: custom equalizer) indicators—ROCK, CLASSIC, POPS, HIP HOP, JAZZ, USER
• also works as the time countdown indicator.
- 30 Disc information indicators—TAG (ID3 Tag), (folder), (track/file)
• also lights up when DLS is shown for a DAB service.
- 31 Main display
- 32 Source display / Volume level indicator
- 33 Tr (track) indicator

Getting started

Basic operations

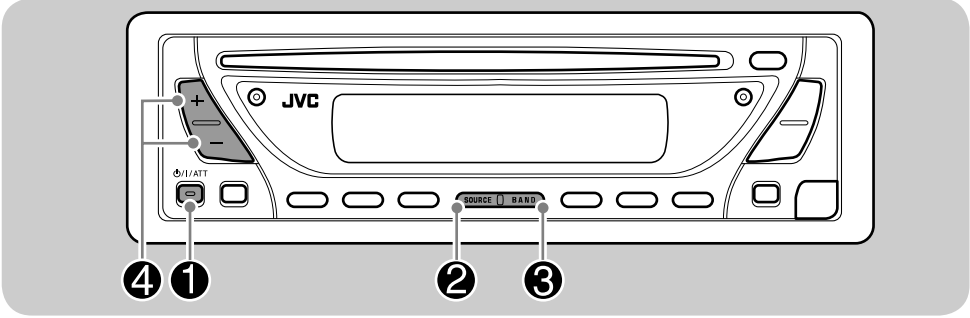

1 Turn on the power.



2 Select a source.

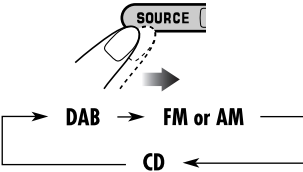

You cannot select some sources if they are not ready.

3 • For FM/AM tuner:



• For DAB tuner:

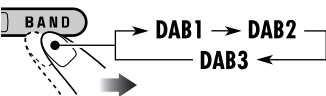

4 Adjust the volume level.

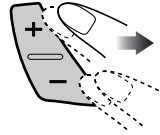

Volume level appears.

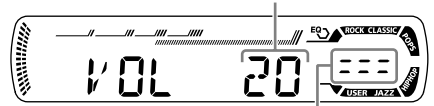

Volume level indicator

5 Adjust the sound as you want.
(See pages 20 and 21.)

To drop the volume in a moment (ATT)



To restore the sound, press it again.

To turn off the power

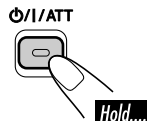

Canceling the display demonstration

If no operations are done for about 20 seconds, display demonstration starts.

[Initial: DEMO ON]—see page 23.

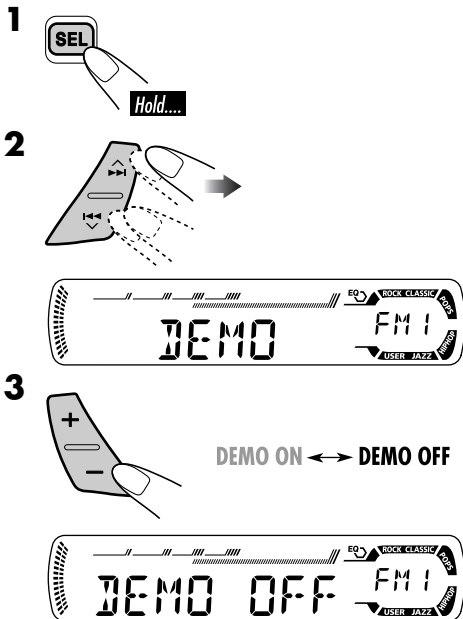

4 Finish the procedure.



To activate the display demonstration

In step **3** above...



Setting the clock

- 1**
- 
- 2** Set the hour, minute, and clock system.
- 1 Select “CLOCK H” (hour), then adjust the hour.
 - 2 Select “CLOCK M” (minute), then adjust the minute.
 - 3 Select “24H/12H,” then select “24H” (hour) or “12H” (hour).

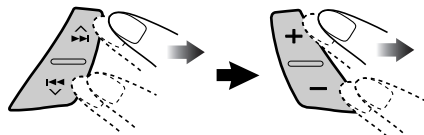

3 Finish the procedure.



To check the current clock time when the power is turned off



Radio operations

Listening to the radio

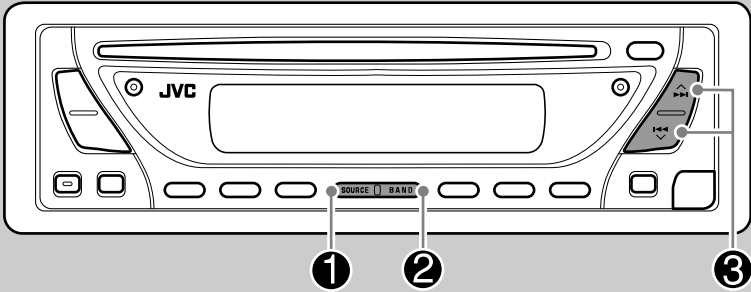

1

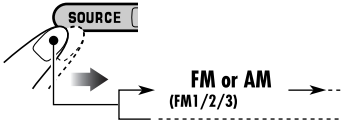

2



Lights up when receiving an FM stereo broadcast with sufficient signal strength.

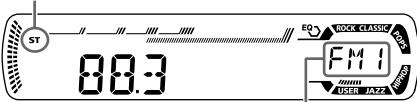

Selected band appears.

3

Start searching for a station.

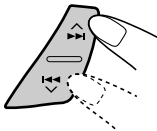

When a station is received, searching stops.

To stop searching, press the same button again.

To tune in to a station manually

In step 3 on the left...

1

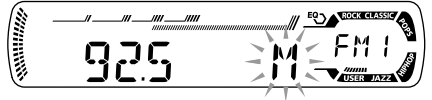
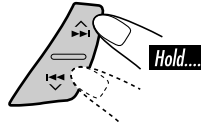

2 Select the desired station frequencies.

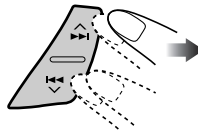

When an FM stereo broadcast is hard to receive

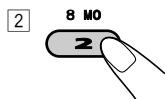
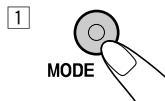

Lights up when monaural mode is activated.

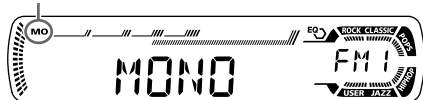

Reception improves, but stereo effect will be lost.

To restore the stereo effect, repeat the same procedure so that "MONO OFF" appears.

- The MO indicator also goes off.

Storing stations in memory

You can preset six stations for each band.

FM station automatic presetting—SSM (Strong-station Sequential Memory)

1

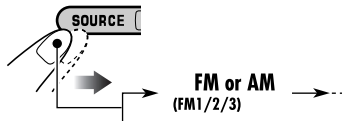

2 Select the FM band (FM1 – FM3) you want to store into.



3

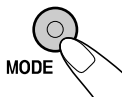

4

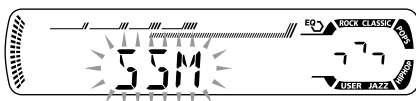
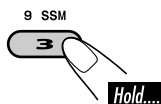

"SSM" flashes, then disappears when automatic presetting is over.

Local FM stations with the strongest signals are searched and stored automatically in the FM band.

Manual presetting

Ex.: Storing FM station of 92.5 MHz into the preset number 4 of the FM1 band.

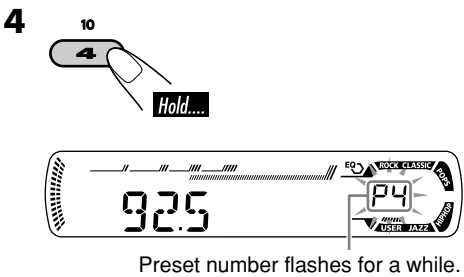
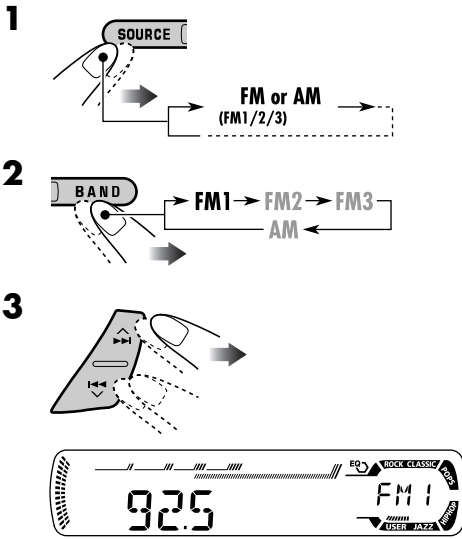

Listening to a preset station

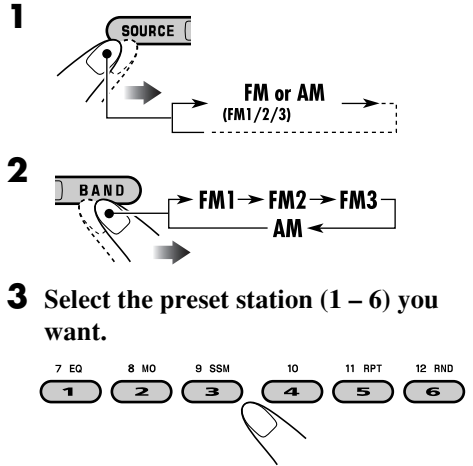

- If the preset station is an FM RDS station, you can use Programme Search (see page 23).

To check the current clock time while listening to an FM (non-RDS) or AM station

- For FM RDS stations, see pages 11 – 13.

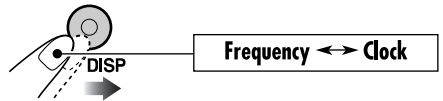

Searching for your favorite FM RDS programme

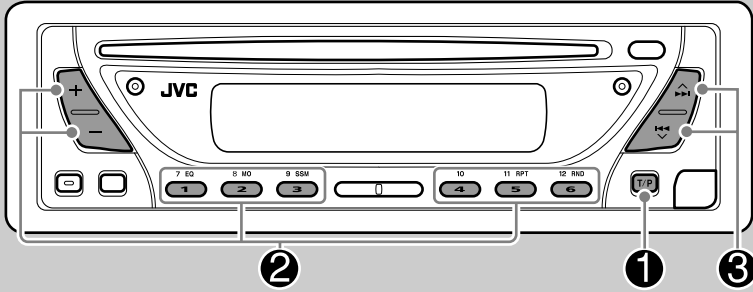

You can tune in to a station broadcasting your favorite programme by searching for a PTY code —PTY Search.

3 Start searching for your favorite programme.

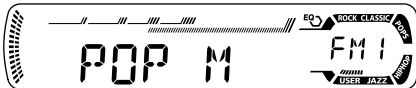

The last selected PTY code appears.

2 Select one of your favorite programme type.



or

Select one of the twenty-nine PTY codes.

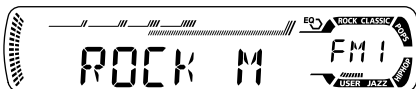
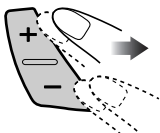

Ex.: When "ROCK M" is selected

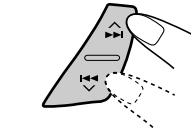

If there is a station broadcasting a programme of the same PTY code as you have selected, that station is tuned in.

PTY codes

NEWS, AFFAIRS, INFO, SPORT, EDUCATE, DRAMA, CULTURE, SCIENCE, VARIED, POP M (music), ROCK M (music), EASY M (music), LIGHT M (music), CLASSICS, OTHER M (music), WEATHER, FINANCE, CHILDREN, SOCIAL, RELIGION, PHONE IN, TRAVEL, LEISURE, JAZZ, COUNTRY, NATION M (music), OLDIES, FOLK M (music), DOCUMENT

What you can do with RDS

Radio Data System (RDS) allows FM stations to send an additional signal along with their regular programme signals. By receiving the RDS data, this receiver can do the following:

- Programme Type (PTY) Search (see page 11)
- Standby Reception of Traffic Announcement—TA (see the following) or PTY (see pages 13 and 23)
- Tracing the same programme automatically—Network-Tracking Reception (see page 13)
- Programme Search (see page 23)

Storing your favorite programmes

You can store six favorite programme types.

Preset programme types in the number buttons (1 to 6):

1	2	3	4	5	6
POP M	ROCK M	EASY M	CLASSICS	AFFAIRS	VARIED

- 1 Select a PTY code (see page 11).
- 2 Select the preset number (1 – 6) you want to store into.

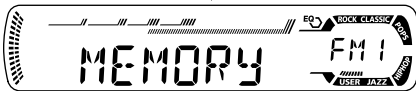
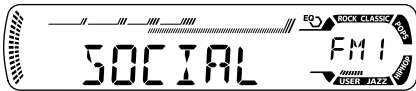

Ex.: When "SOCIAL" is stored

- 3 Repeat steps 1 and 2 to store other PTY codes into other preset numbers.
- 4 Finish the procedure.

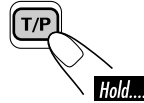

Using the standby receptions

You can use two types of Standby Reception—TA Standby Reception and PTY Standby Reception—both for FM station and DAB services.

TA Standby Reception

TA Standby Reception allows the receiver to switch temporarily to an FM RDS station or a DAB service broadcasting Traffic Announcement from any source other than AM. The volume changes to the preset TA volume level (see page 23).

To activate TA Standby Reception



The TP indicator either lights up or flashes.

- If the TP indicator lights up, TA Standby Reception is activated.
- If the TP indicator flashes, TA Standby Reception is not yet activated.

To activate TA Standby Reception, tune in to another FM RDS station or DAB service providing the signals required for TA Standby Reception. The TP indicator will stop flashing and remain lit.

To deactivate the TA Standby Reception



The TP indicator goes off.

PTY Standby Reception

PTY Standby Reception allows the receiver to switch temporarily to your favorite PTY programme from any source other than AM.

To select your favorite PTY code, and activate the PTY Standby Reception, see page 23.

- PTY Standby Reception also works for searching a DAB service.

The PTY indicator either lights up or flashes.

- If the PTY indicator lights up, PTY Standby Reception is activated.
- If the PTY indicator flashes, PTY Standby Reception is not yet activated.

To activate PTY Standby Reception, tune in to another station or DAB service providing the signals required for PTY Standby Reception. The PTY indicator will stop flashing and remain lit.

To deactivate the PTY Standby Reception, select "OFF" for the PTY code (see page 23). The PTY indicator goes off.

Tracking the same programme— Network-Tracking Reception

When driving in an area where FM reception is not sufficient enough, this receiver automatically tunes in to another FM RDS station of the same network, possibly broadcasting the same programme with stronger signals (see the illustration below).

When shipped from the factory, Network-Tracking Reception is activated.

To change the Network-Tracking Reception setting, see "AF-REG" on page 23.

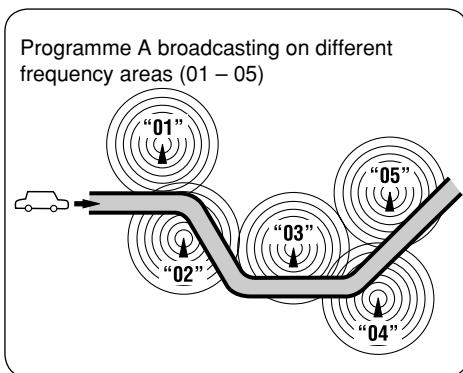

To check the current clock time while listening to an FM RDS station

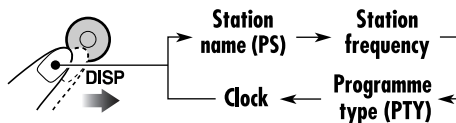

DAB tuner operations

Listening to the DAB tuner

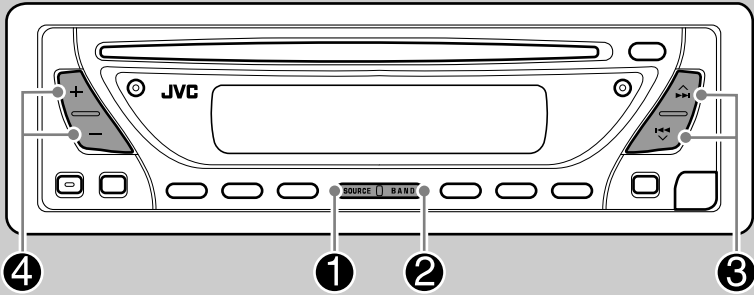

1

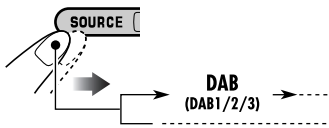

2

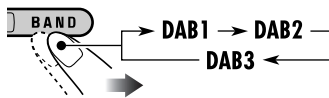

3

Start searching for an ensemble.

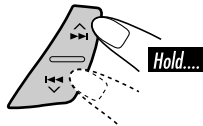

When an ensemble is received, searching stops.

To stop searching, press the same button again.

4

Select a service (either primary or secondary) to listen to.

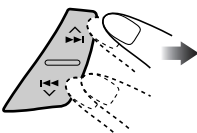

To tune in to an ensemble manually

In step 3 on the left...

1

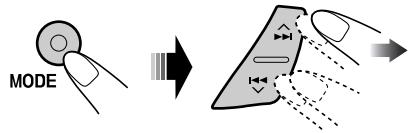

2 Select the desired ensemble frequencies.

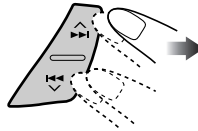

What is DAB system?

DAB can deliver CD quality sound without any annoying interference and signal distortion. Furthermore, it can carry text, pictures, and data. When transmitting, DAB combines several programmes (called “services”) to form one “ensemble.” In addition, each “service”—called “primary service”—can also be divided into its components (called “secondary service”). A typical ensemble has six or more programmes (services) broadcast at the same time.

This receiver can do the following:

- Tracing the same programme automatically —Alternative Frequency Reception (see “DAB AF” on page 24).

Storing DAB services in memory

You can preset six DAB services (primary) for each band.

- 1 Perform steps 1 to 4 on page 14, to select a service you want.
- 2 Select the preset number (1 – 6) you want to store into.

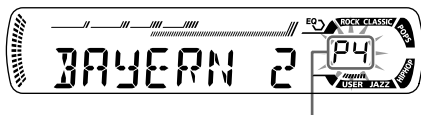
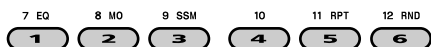

Preset number flashes for a while.

Tracking the same programme— Alternative Frequency Reception

You can keep listening to the same programme by activating the Alternative Frequency Reception.

When shipped from the factory, Alternative Frequency Reception is activated.
To deactivate the Alternative Frequency Reception, see “DAB AF” on page 24.

Other Main DAB Features

■ PTY Search

- Operations are exactly the same as explained on pages 11 and 12 for FM RDS stations.
- You cannot store PTY codes separately for the DAB tuner and for the FM tuner.

■ TA Standby Reception

- Operations are exactly the same as explained on page 12 for FM RDS stations.

■ Changing display information

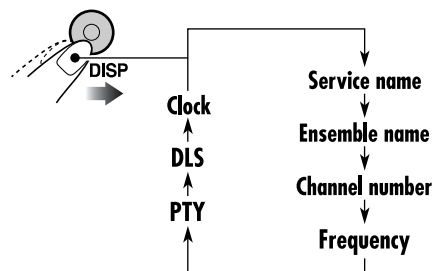

- **When lights on the display:**
 You can check the Dynamic Label Segment (DLS = DAB radio text information).



Tuning in to a preset DAB service

- 1
- 2
- 3 Select the preset DAB service (primary) number (1 – 6) you want.



If the selected primary service has some secondary services, press the same button again will tune in to the secondary services.

Disc operations

Playing a disc

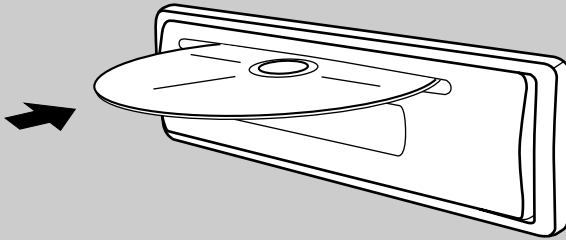

All tracks will be played repeatedly until you change the source or eject the disc.

About MP3 and WMA discs

MP3 and WMA (Windows Media® Audio) “tracks” (words “file” and “track” are used interchangeably) are recorded in “folders.”

- When inserting an MP3 or a WMA disc:

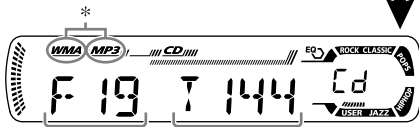

Total folder number

Total file number

Disc information appears automatically (see page 18).

Selected folder number



Elapsed playing time

Current track number

* Either the MP3 or WMA indicator lights up depending on the detected file.

- When inserting an audio CD or a CD Text disc:

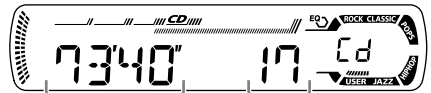

Total playing time of the inserted disc

Total track number of the inserted disc

CD Text: Disc title/performer → Track title appears automatically (see page 18).

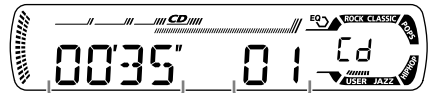

Elapsed playing time

Current track number

To stop play and eject the disc

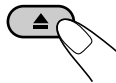

To fast-forward or reverse the track

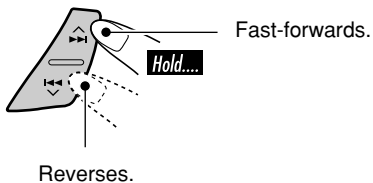

To go to the next or previous tracks

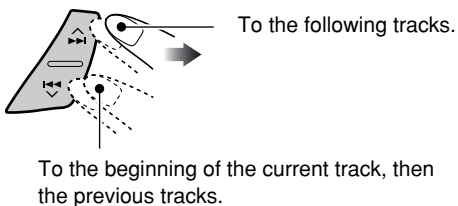

To go to the next or previous folders (only for MP3 or WMA discs)

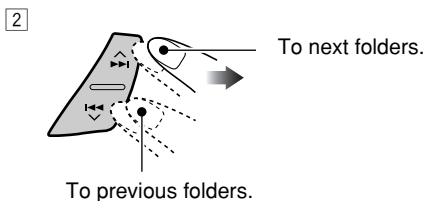
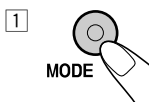

To locate a particular track (for CD) or folder (for MP3 or WMA discs) directly

To select a number from 01 – 06:

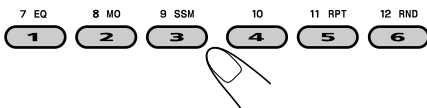

To select a number from 07 – 12:

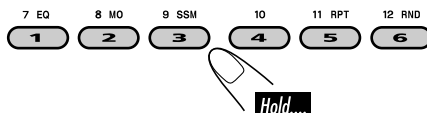

- To use folder search on MP3/WMA discs, it is required that folders are assigned with 2-digits number at the beginning of their folder names—01, 02, 03, and so on.

- To select a particular track in a folder (for MP3 or WMA disc) after selecting a folder:

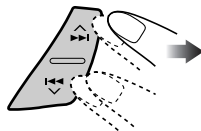

Prohibiting disc ejection

You can lock a disc in the loading slot.

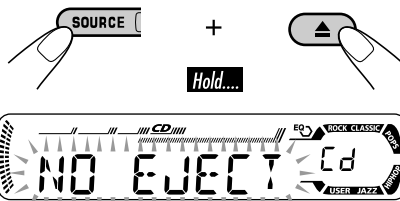

To cancel the prohibition, repeat the same procedure.

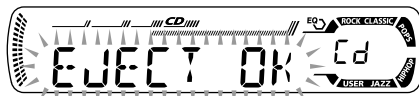

Changing the display information



■ While playing an audio CD or a CD Text

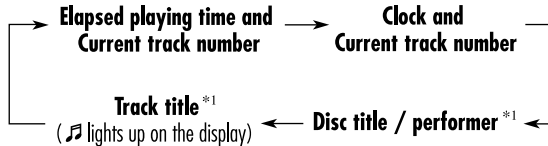

*1 If the current disc is an audio CD, “NO NAME” appears.

■ While playing an MP3 or WMA disc

- When “TAG DISP” is set to “TAG ON” (see page 24)

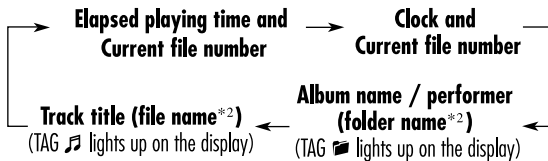

*2 If an MP3/WMA file does not have ID3 tags, folder name and file name appear. In this case, the TAG indicator will not light up.

- When “TAG DISP” is set to “TAG OFF”

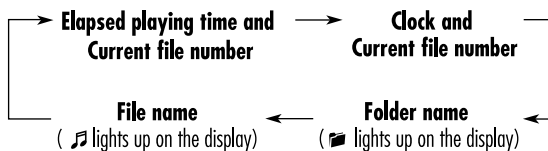

Selecting the playback modes

You can use only one of the following playback modes at a time.

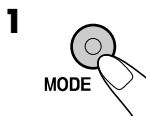

2 Select your desired playback mode.

Repeat play

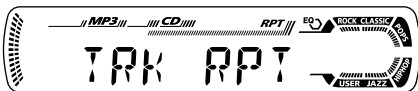
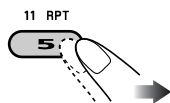

Ex.: When "TRK RPT" is selected while playing an MP3 disc

Mode	Plays repeatedly
TRK RPT:	The current track. <ul style="list-style-type: none"> • RPT lights up.
FLDR RPT*:	All tracks of the current folder. <ul style="list-style-type: none"> • [Folder icon] and RPT light up.
RPT OFF:	Cancels.

Random play

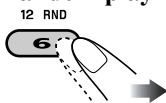

Ex.: When "DISC RND" is selected while playing an MP3 disc

Mode	Plays at random
FLDR RND*:	All tracks of the current folder, then tracks of the next folder and so on. <ul style="list-style-type: none"> • RND and [Folder icon] light up.
DISC RND:	All tracks of the current disc. <ul style="list-style-type: none"> • RND and [Disc icon] light up.
RND OFF:	Cancels.

* Only while playing an MP3 or WMA disc.

Sound adjustments

Selecting preset sound modes (C-EQ: custom equalizer)

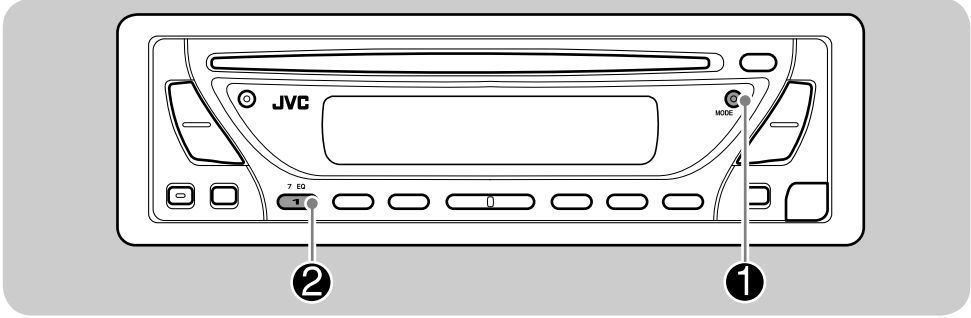

You can select a preset sound mode suitable to the music genre.

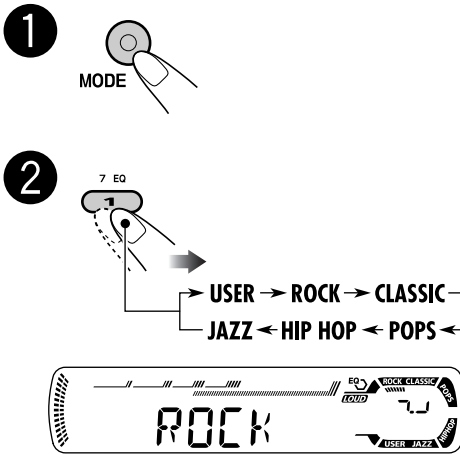

Ex.: When "ROCK" is selected

Indication	For:	Preset values		
		BAS* ¹	TRE* ²	LOUD* ³
USER	(Flat sound)	00	00	OFF
ROCK	Rock or disco music	+03	+01	ON
CLASSIC	Classical music	+01	-02	OFF
POPS	Light music	+04	+01	OFF
HIP HOP	Funk or rap music	+02	00	ON
JAZZ	Jazz music	+02	+03	OFF

*1 BAS: Bass

*2 TRE: Treble

*3 LOUD: Loudness

Indication pattern for each sound mode:

USER	ROCK	CLASSIC
JAZZ	HIP HOP	POPS

Adjusting the sound

You can adjust the sound characteristics to your preference.

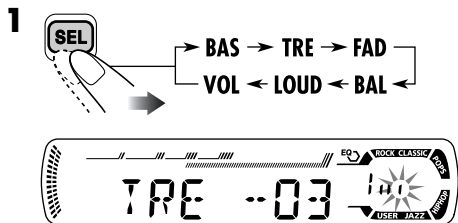

Ex.: When "TRE" is selected

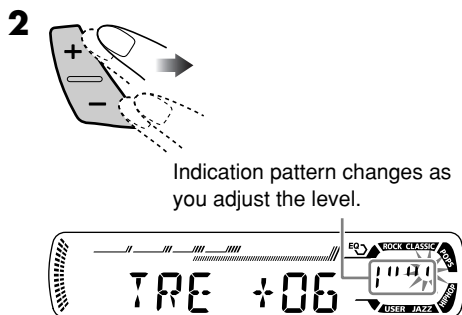

Indication	To do:	Range
BAS*1 (bass)	Adjust the bass.	-06 (min.) to +06 (max.)
TRE*1 (treble)	Adjust the treble.	-06 (min.) to +06 (max.)
FAD*2 (fader)	Adjust the front and rear speaker balance.	R06 (Rear only) to F06 (Front only)
BAL (balance)	Adjust the left and right speaker balance.	L06 (Left only) to R06 (Right only)
LOUD*1 (loudness)	Boost low and high frequencies to produce a well-balanced sound at low volume level.	LOUD ON ↕ LOUD OFF
VOL*3 (volume)	Adjust the volume.	00 (min.) to 30 or 50 (max.)*4

*1 When you adjust the bass, treble, or loudness, the adjustment you have made is stored for the currently selected sound mode (C-EQ) including "USER."

*2 If you are using a two-speaker system, set the fader level to "00."

*3 Normally the +/- buttons work as the volume control. So you do not have to select "VOL" to adjust the volume level.

*4 Depending on the amplifier gain control setting. (See page 24 for details.)

General settings — PSM

Basic procedure

You can change PSM (Preferred Setting Mode) items listed in the table that follows.

1

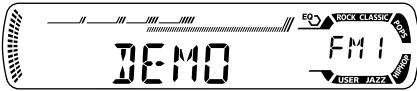

2 Select a PSM item.

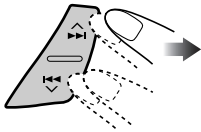

Ex.: When you select "DIMMER"

3 Adjust the PSM item selected.

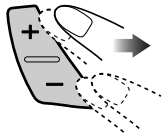

4 Repeat steps 2 and 3 to adjust the other PSM items if necessary.

5 Finish the procedure.



You can note your PSM setting in the table below.

DEMO	
CLOCK H	
CLOCK M	
24H/12H	
CLK ADJ	
AF-REG	
PTY-STBY	
TA VOL	
P-SEARCH	
DAB AF	
DAB VOL	
DAB ANT	
DIMMER	
TEL	
SCROLL	
TAG DISP	
AMP GAIN	

Indications	Selectable settings, [reference page]
DEMO Display demonstration	DEMO ON: [Initial]; Display demonstration will be activated automatically if no operation is done for about 20 seconds, [7]. DEMO OFF: Cancels.
CLOCK H Hour adjustment	0 – 23 (1 – 12), [7] [Initial: 0 (0:00)]
CLOCK M Minute adjustment	00 – 59, [7] [Initial: 00 (0:00)]
24H/12H 24 hours or 12 hours time display	12H \rightleftharpoons 24H, [7] [Initial: 24H]
CLK ADJ Clock adjustment	AUTO: [Initial]; The built-in clock is automatically adjusted using the CT (clock time) data in the RDS signal. OFF: Cancels.
AF-REG Alternative frequency/ regionalization reception	When the received signals from the current station become weak... AF: [Initial]; Switches to another station (the programme may differ from the one currently received), [13]. • The AF indicator lights up. AF REG: Switches to another station broadcasting the same programme. • The AF and REG indicators light up. OFF: Cancels (not selectable when “DAB AF” is set to “AF ON”).
PTY-STBY PTY standby	Activates PTY Standby Reception with one of the 29 PTY codes, [13]. OFF [Initial] → 29 PTY codes, [11] → (back to the beginning)
TA VOL Traffic announcement volume	[Initial: VOL 20]; VOL 00 – VOL 30 or 50* * Depends on the amplifier gain control.
P-SEARCH Programme search	ON: Using the AF data, the receiver tunes in to another frequency broadcasting the same programme as the original preset RDS station is if the preset station signals are not sufficient. OFF: [Initial]; Cancels.

Continued...

Indications	Selectable settings, [reference page]
DAB AF Alternative frequency reception	AF ON: [Initial]; Traces the programme among DAB services and FM RDS stations, [15]. AF OFF: Cancels.
DAB VOL DAB volume adjustment	You can adjust the volume level (VOL -12 — VOL +12) of DAB tuner to match the FM sound level and store it in memory. [Initial: VOL 00]
DAB ANT DAB aerial	You can allow this receiver to supply the power to the DAB aerial with the booster (not supplied). ON: When using the DAB aerial with the booster. OFF: [Initial]; When using the DAB aerial without the booster.
DIMMER Dimmer	ON: Activates dimmer. OFF: [Initial]; Cancels.
TEL Telephone muting	MUTING 1/MUTING 2: Select either one which mutes the sounds while using the cellular phone. OFF: [Initial]; Cancels.
SCROLL* Scroll	ONCE: [Initial]; Scrolls the disc information once. AUTO: Repeats scrolling (5-seconds interval in between). OFF: Cancels. • Pressing DISP for more than one second can scroll the display regardless of the setting.
TAG DISP Tag display	TAG ON: [Initial]; Shows the ID3 tag while playing MP3/WMA tracks, [18]. TAG OFF: Cancels.
AMP GAIN Amplifier gain control	You can change the maximum volume level of this receiver. HIGH PWR: [Initial]; VOL 00 – VOL 50 LOW PWR: VOL 00 – VOL 30 (Select this if the maximum power of the speaker is less than 50 W to prevent them from damaging the speaker.)

* Some characters or symbols will not be shown (and will be blanked) on the display.
(Ex. "ABC&!d#" ⇔ "ABCA D ".)

Detaching the control panel

When detaching or attaching the control panel, be careful not to damage the connectors on the back of the control panel and on the panel holder.

■ Detaching the control panel

Before detaching the control panel, be sure to turn off the power.

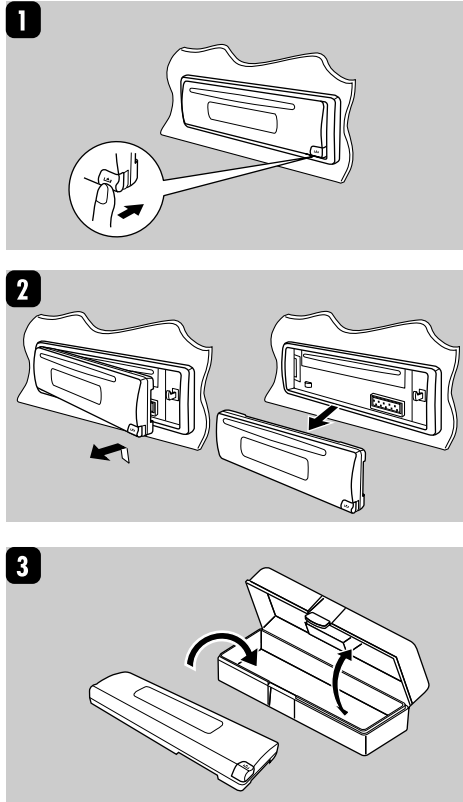

■ Attaching the control panel

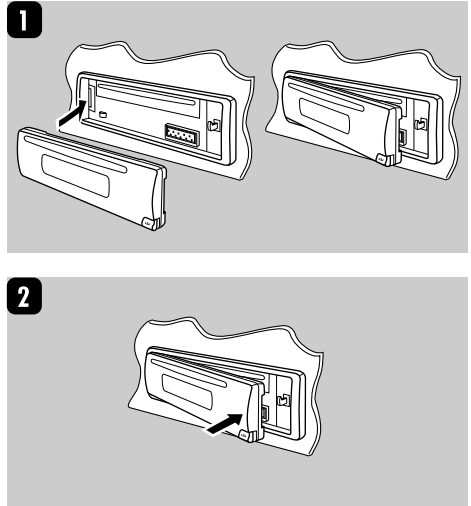

Using the remote controller — RM-RK60

This receiver can be remotely controlled as instructed here (with an optionally purchased remote controller). We recommend that you use remote controller RM-RK60 with your receiver.

- When operating, aim the remote controller directly at the remote sensor on the receiver. Make sure there is no obstacle in between.

■ Installing the lithium coin battery (CR2025)

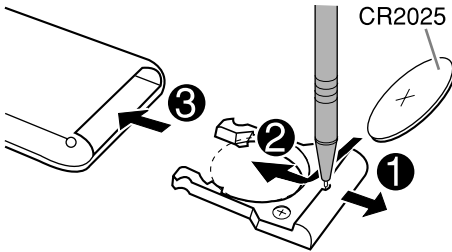

Warning:

- Store the battery in a place where children cannot reach to avoid risk of accident.
- To prevent the battery from over-heating, cracking, or starting a fire:
 - Do not recharge, short, disassemble, or heat the battery or dispose of it in a fire.
 - Do not leave the battery with other metallic materials.
 - Do not poke the battery with tweezers or similar tools.
 - Wrap the battery with tape and insulate when throwing away or saving it.

Caution on remote sensor:

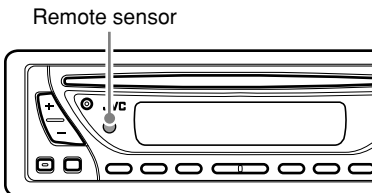

- DO NOT expose the remote sensor to strong light (direct sunlight or artificial lighting).

Main elements and features

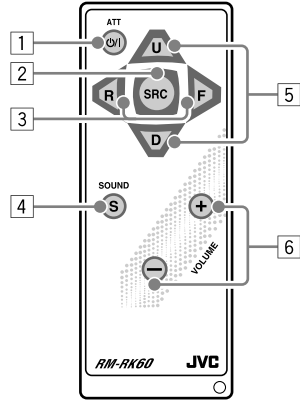

- 1 **⏻/I ATT** (standby/on attenuator) button
 - Turns on and off the power and also attenuates the sound.
- 2 **SRC** (source) button
 - Selects the source.
- 3 **R** (reverse) / **F** (forward) buttons
 - Searches for stations or DAB services if pressed briefly.
 - Searches for ensembles if pressed and held.
 - Fast-forwards or reverses the track if pressed and held.
 - Changes the tracks of the disc.
- 4 **SOUND** button
 - Selects the sound mode (C-EQ: custom equalizer).
- 5 **U** (up) / **D** (down) buttons
 - U (up): Changes the FM/AM/DAB bands.
 - D (down): Changes the preset stations or DAB services.
 - Changes the folder of the MP3/WMA discs.
- 6 **VOLUME +/-** buttons
 - Adjusts the volume level.

The receiver is equipped with the steering wheel remote control function.

- See the Installation/Connection Manual (separate volume) for connection.

Maintenance

How to clean the connectors

Frequent detachment will deteriorate the connectors.

To minimize this possibility, periodically wipe the connectors with a cotton swab or cloth moistened with alcohol, being careful not to damage the connectors.

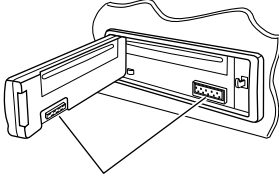

Connector

Moisture condensation

Moisture may condense on the lens inside the CD player in the following cases:

- After starting the heater in the car.
- If it becomes very humid inside the car.

Should this occur, the CD player may malfunction. In this case, eject the disc and leave the receiver turned on for a few hours until the moisture evaporates.

How to handle discs

When removing a disc from its case, press down the center holder of the case and lift the disc out, holding it by the edges.

Center holder



- Always hold the disc by the edges. Do not touch its recording surface.

When storing a disc into its case, gently insert the disc around the center holder (with the printed surface facing up).

- Make sure to store discs into the cases after use.

To keep discs clean

A dirty disc may not play correctly. If a disc does become dirty, wipe it with a soft cloth in a straight line from center to edge.



- Do not use any solvent (for example, conventional record cleaner, spray, thinner, benzine, etc.) to clean discs.

To play new discs

New discs may have some rough spots around the inner and outer edges. If such a disc is used, this receiver may reject the disc.



To remove these rough spots, rub the edges with a pencil or ball-point pen, etc.

Caution:

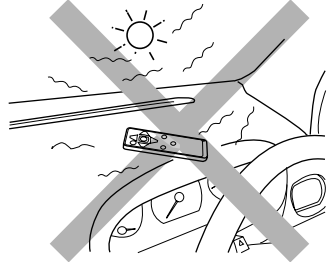

Do not use the following discs:

Warped disc



Sticker



Sticker residue

Disc



Stick-on label

More about this receiver

Basic operations

Turning on the power

- By pressing SOURCE on the receiver, you can also turn on the power.

Turning off the power

- If you turn off the power while listening to a disc, disc play will start from where playback has been stopped previously, next time you turn on the power.

Selecting the sources

- When no disc is loaded in the receiver, “CD” cannot be selected.

Radio operations

Storing stations in memory

- During SSM search...
 - All previously stored stations are erased and stations are stored newly.
 - Received stations are preset in No. 1 (lowest frequency) to No. 6 (highest frequency).
 - When SSM is over, the station stored in No. 1 will be automatically tuned in.
- When storing a station manually, a previously preset station is erased when a new station is stored in the same preset number.

FM RDS operations

- If you want to know more about RDS, visit «<http://www.rds.org.uk>».
- Network-Tracking Reception requires two types of RDS signals—PI (Programme Identification) and AF (Alternative Frequency) to work correctly. Without receiving these data correctly, Network-Tracking Reception will not operate.
- If a Traffic Announcement is received, the volume level (TA Volume) automatically changes to the preset level.
- If Alternative Frequency Reception for DAB services (DAB AF) is activated, Network-Tracking Reception (AF-REG) is also activated automatically. On the other hand, Network-Tracking Reception cannot be deactivated without deactivating Alternative Frequency Reception.

DAB tuner operations

General

- Only primary DAB services can be presetted even you store a secondary service.
- A previously preset DAB service is erased when a new DAB service is stored in the same preset number.
- “NO TEXT” will be shown for the service without DLS if you press and hold DISP.

Disc operations

Caution for DualDisc playback

- The Non-DVD side of a “DualDisc” does not comply with the “Compact Disc Digital Audio” standard. Therefore, the use of Non-DVD side of a DualDisc on this product may not be recommended.

General

- This receiver has been designed to reproduce CDs/CD Texts, and CD-Rs (Recordable)/CD-RWs (Rewritable) in audio CD (CD-DA), MP3 and WMA format.
- When a disc has been loaded, selecting “CD” for the playback source starts disc play.

Inserting a disc

- When a disc is inserted upside down, the disc automatically ejects.
- Do not insert 8 cm discs (single CD) and unusual shape discs (heart, flower, etc.) into the loading slot.

Playing a disc

- While fast-forwarding or reversing on an MP3 or WMA disc, you can only hear intermittent sounds.

Playing a CD-R or CD-RW

- Use only “finalized” CD-Rs or CD-RWs.
- This receiver can play back only the files of the same type which is first detected if a disc includes both audio CD (CD-DA) files and MP3/WMA files.
- This receiver can play back multi-session discs; however, unclosed sessions will be skipped while playing.
- Some CD-Rs or CD-RWs may not play back on this receiver because of their disc characteristics, and for the following causes:
 - Discs are dirty or scratched.
 - Moisture condensation occurs on the lens inside the receiver.
 - The pickup lens inside the receiver is dirty.
 - CD-R/CD-RW on which the files are written with “Packet Write” method.
 - There are improper recording conditions (missing data, etc.) or media conditions (stain, scratch, warp, etc.).
- CD-RWs may require a longer readout time since the reflectance of CD-RWs is lower than that of regular CDs.
- Do not use the following CD-Rs or CD-RWs:
 - Discs with stickers, labels, or protective seal stuck to the surface.
 - Discs on which labels can be directly printed by an ink jet printer.
 Using these discs under high temperatures or high humidities may cause malfunctions or damages to discs.

Playing an MP3/WMA disc

- This receiver can play back MP3/WMA files with the extension code <.mp3> or <.wma> (regardless of the letter case—upper/lower).
- This receiver can show the names of albums, artists (performer), and ID3 Tag (Version 1.0, 1.1, 2.2, 2.3, or 2.4) for MP3 files and for WMA files.
- This receiver can handle only one-byte characters. No other characters can be correctly displayed.
- This receiver can play back MP3/WMA files meeting the conditions below:
 - Bit rate: 8 kbps — 320 kbps
 - Sampling frequency:
 - 48 kHz, 44.1 kHz, 32 kHz (for MPEG-1)
 - 24 kHz, 22.05 kHz, 16 kHz (for MPEG-2)
 - 48 kHz, 44.1 kHz, 32 kHz (for WMA)
 - Disc format: ISO 9660 Level 1/ Level 2, Romeo, Joliet, Windows long file name
- The maximum number of characters for file/folder names vary among the disc format used (includes 4 extension characters—<.mp3> or <.wma>).
 - ISO 9660 Level 1: up to 12 characters
 - ISO 9660 Level 2: up to 31 characters
 - Romeo*: up to 128 (72) characters
 - Joliet*: up to 64 (36) characters
 - Windows long file name*: up to 128 (72) characters

* *The parenthetic figure is the maximum number of characters for file/folder names in case the total number of files and folders is 313 or more.*
- This receiver can recognize the total of 512 files, of 200 folders, and of 8 hierarchies.
- This receiver can play back the files recorded in VBR (variable bit rate).
The files recorded in VBR have a discrepancy in elapsed time display, and do not show the actual elapsed time. Especially, after performing the search function, this difference becomes noticeable.

- This receiver cannot play back the following files:
 - MP3 files encoded with MP3i and MP3 PRO format.
 - MP3 files encoded in an unappropriated format.
 - MP3 files encoded with Layer 1/2.
 - WMA files encoded with lossless, professional, and voice format.
 - WMA files which are not based upon Windows Media® Audio.
 - WMA files copy-protected with DRM.
 - Files which have the data such as WAVE, ATRAC3, etc.
- The search function works but search speed is not constant.

Changing the source

- If you change the source, playback also stops (without ejecting the disc).
Next time you select “CD” for the playback source, disc play starts from where it has been stopped previously.

Ejecting a disc

- If the ejected disc is not removed within 15 seconds, the disc is automatically inserted again into the loading slot to prevent it from dust. (Disc will not play this time.)

General settings—PSM

- If you change the “AMP GAIN” setting from “HIGH PWR” to “LOW PWR” while the volume level is set higher than “VOL 30,” the receiver automatically changes the volume level to “VOL 30.”

Troubleshooting

What appears to be trouble is not always serious. Check the following points before calling a service center.

	Symptoms	Causes	Remedies
General	<ul style="list-style-type: none"> • Sound cannot be heard from the speakers. 	<p>The volume level is set to the minimum level.</p> <p>Connections are incorrect.</p>	<p>Adjust it to the optimum level.</p> <p>Check the cords and connections.</p>
	<ul style="list-style-type: none"> • The receiver does not work at all. 	<p>The built-in microcomputer may have functioned incorrectly due to noise, etc.</p>	<p>Reset the receiver (see page 2).</p>
FM/AM	<ul style="list-style-type: none"> • SSM automatic presetting does not work. 	<p>Signals are too weak.</p>	<p>Store stations manually.</p>
	<ul style="list-style-type: none"> • Static noise while listening to the radio. 	<p>The aerial is not connected firmly.</p>	<p>Connect the aerial firmly.</p>
Disc playback	<ul style="list-style-type: none"> • Disc automatically ejects. 	<p>Disc is inserted upside down.</p>	<p>Insert the disc correctly.</p>
	<ul style="list-style-type: none"> • CD-R/CD-RW cannot be played back. • Tracks on the CD-R/CD-RW cannot be skipped. 	<p>CD-R/CD-RW is not finalized.</p>	<ul style="list-style-type: none"> • Insert a finalized CD-R/CD-RW. • Finalize the CD-R/CD-RW with the component which you used for recording.
	<ul style="list-style-type: none"> • Disc can be neither played back nor ejected. 	<p>Disc is locked.</p>	<p>Unlock the disc (see page 17).</p>
		<p>The CD player may have functioned incorrectly.</p>	<p>Eject the disc forcibly (see page 2).</p>
	<ul style="list-style-type: none"> • Disc sound is sometimes interrupted. 	<p>You are driving on rough roads.</p>	<p>Stop playback while driving on rough roads.</p>
		<p>Disc is scratched.</p>	<p>Change the disc.</p>
<p>Connections are incorrect.</p>		<p>Check the cords and connections.</p>	

	Symptoms	Causes	Remedies
MP3/WMA playback	<ul style="list-style-type: none"> Disc cannot be played back. 	No MP3/WMA tracks are recorded on the disc.	Change the disc.
		MP3/WMA tracks do not have the extension code <.mp3> or <.wma> in their file names.	Add the extension code <.mp3> or <.wma> to their file names.
		MP3/WMA tracks are not recorded in the format compliant with ISO 9660 Level 1, Level 2, Romeo, or Joliet.	Change the disc. (Record MP3/WMA tracks using a compliant application.)
	<ul style="list-style-type: none"> Noise is generated. 	The track played back is not an MP3/WMA track (although it has the extension code <.mp3> or <.wma>).	Skip to another track or change the disc. (Do not add the extension code <.mp3> or <.wma> to non-MP3 or WMA tracks.)
	<ul style="list-style-type: none"> A longer readout time is required (“CHECK” keeps flashing on the display). 	Readout time varies due to the complexity of the folder/file configuration.	Do not use too many hierarchies and folders.
	<ul style="list-style-type: none"> Tracks cannot be played back as you have intended them to play. 	Playback order is determined when the files are recorded.	_____
	<ul style="list-style-type: none"> Elapsed playing time is not correct. 	This sometimes occurs during play. This is caused by how the tracks are recorded on the disc.	_____
	<ul style="list-style-type: none"> “NO FILES” appears on the display. 	The current disc does not contain any MP3/WMA tracks.	Insert a disc that contains MP3/WMA tracks.
<ul style="list-style-type: none"> Correct characters are not displayed (e.g. album name). 	This receiver can only display alphabets (capital: A – Z), numbers, and a limited number of symbols.	_____	

Specifications

AUDIO AMPLIFIER SECTION

Maximum Power Output:

Front: 50 W per channel

Rear: 50 W per channel

Continuous Power Output (RMS):

Front: 19 W per channel into 4 Ω , 40 Hz to 20 000 Hz at no more than 0.8% total harmonic distortion.

Rear: 19 W per channel into 4 Ω , 40 Hz to 20 000 Hz at no more than 0.8% total harmonic distortion.

Load Impedance: 4 Ω (4 Ω to 8 Ω allowance)

Tone Control Range:

Bass: ± 10 dB at 100 Hz

Treble: ± 10 dB at 10 kHz

Frequency Response: 40 Hz to 20 000 Hz

Signal-to-Noise Ratio: 70 dB

Line-Out Level/Impedance:

2 V/20 k Ω load (full scale)

Output Impedance: 1 k Ω

Other Terminal: Steering wheel remote input

TUNER SECTION

Frequency Range:

FM: 87.5 MHz to 108.0 MHz

AM: (MW) 522 kHz to 1 620 kHz

(LW) 144 kHz to 279 kHz

[FM Tuner]

Usable Sensitivity: 11.2 dBf (1.0 μ V/75 Ω)

50 dB Quieting Sensitivity:

16.3 dBf (1.8 μ V/75 Ω)

Alternate Channel Selectivity (400 kHz): 65 dB

Frequency Response: 40 Hz to 15 000 Hz

Stereo Separation: 30 dB

Capture Ratio: 1.5 dB

[MW Tuner]

Sensitivity: 20 μ V

Selectivity: 35 dB

[LW Tuner]

Sensitivity: 50 μ V

[DAB Tuner]

Sensitivity: (Band III) -98 dBm

(L-Band) -96 dBm

Selectivity: 40 dB

CD PLAYER SECTION

Type: Compact disc player

Signal Detection System: Non-contact optical pickup (semiconductor laser)

Number of Channels: 2 channels (stereo)

Frequency Response: 5 Hz to 20 000 Hz

Dynamic Range: 96 dB

Signal-to-Noise Ratio: 98 dB

Wow and Flutter: Less than measurable limit

MP3 Decoding Format:

MPEG1/2 Audio Layer 3

Max. Bit Rate: 320 kbps

WMA (Windows Media[®] Audio) Decoding Format:

Max. Bit Rate: 192 kbps

GENERAL

Power Requirement:

Operating Voltage:

DC 14.4 V (11 V to 16 V allowance)

Grounding System: Negative ground

Allowable Operating Temperature:

0°C to +40°C

Dimensions (W \times H \times D):

Installation Size (approx.):

182 mm \times 52 mm \times 150 mm

Panel Size (approx.):

188 mm \times 58 mm \times 11 mm

Mass (approx.):

1.4 kg (excluding accessories)

Design and specifications are subject to change without notice.

- Microsoft and Windows Media are either registered trademarks or trademarks of Microsoft Corporation in the United States and/or other countries.

Having TROUBLE with operation?

Please reset your unit

Refer to page of How to reset your unit

Vous avez des PROBLÈMES de fonctionnement?

Réinitialisez votre appareil

Référez-vous à la page intitulée Comment réinitialiser votre appareil

Hebt u PROBLEMEN met de bediening?

Stel het apparaat terug

Zie de pagina met de paragraaf Het apparaat terugstellen

JVC



EN, FR, NL

© 2005 Victor Company of Japan, Limited

0105MNMMDWJEIN

ENGLISH

FRANÇAIS

NEDERLANDS

This unit is designed to operate on **12 V DC, NEGATIVE ground electrical systems**. If your vehicle does not have this system, a voltage inverter is required, which can be purchased at JVC IN-CAR ENTERTAINMENT dealer.

Cet appareil est conçu pour fonctionner sur des sources de **courant continu de 12 V à masse NEGATIVE**. Si votre véhicule n'offre pas ce type d'alimentation, il vous faut un convertisseur de tension, que vous pouvez acheter chez un revendeur d'autoradios JVC.

Dit apparaat mag worden gebruikt bij elektrische systemen die werken op 12 V gelijkstroom met negatieve aarding. Als uw auto niet is uitgerust met een dergelijk systeem, is een spanningsomzetter vereist. Dit instrument kan worden aangeschaft bij JVC car audio dealers.

Parts list for installation and connection

The following parts are provided for this receiver. After checking them, please set them correctly.

A / B
Hard case/Control panel
Etui de transport/Panneau de commande
Houder/Bedieningspaneel

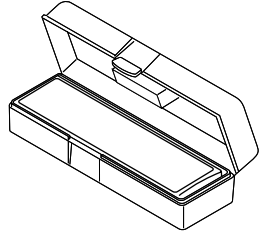

C
Lock nut (M5)
Ecrou d'arrêt (M5)
Contra-moer (M5)



C
Sleeve
Manchon
Huls

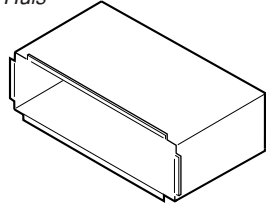

H
Mounting bolt (M5 x 20 mm)
Boulon de montage (M5 x 20 mm)
Bevestigingsbout (M5 x 20 mm)

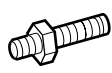

D
Trim plate
Plaque d'assemblage
Sierplaat

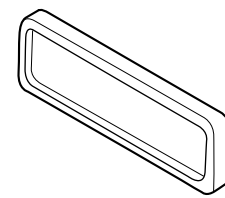

I
Rubber cushion
Amortisseur en caoutchouc
Rubberdop



E
Power cord
Cordon d'alimentation
Stroomkabel

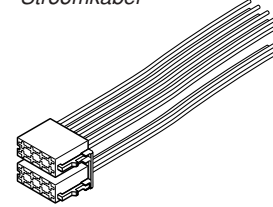

F
Washer (ø5)
Rondelle (ø5)
Slutring (ø5)



J
Handles
Poignées
Hendels

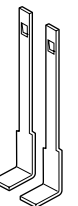

INSTALLATION (IN-DASH MOUNTING)

The following illustration shows a typical installation. If you have any questions or require information regarding installation kits, consult your JVC IN-CAR ENTERTAINMENT dealer or a company supplying kits.

- If you are not sure how to install this unit correctly, have it installed by a qualified technician.

INSTALLATION (MONTAGE DANS LE TABLEAU DE BORD)

L'illustration suivante est un exemple d'installation typique. Si vous avez des questions ou avez besoin d'information sur des kits d'installation, consulter votre revendeur d'autoradios JVC ou une compagnie d'approvisionnement.

- Si vous n'êtes pas sûr de pouvoir installer correctement cet appareil, faites-le installer par un technicien qualifié.

INSTALLATIE (INBOUW IN HET DASHBOARD)

Op de volgende afbeelding kunt u zien hoe de installatie, normaal gesproken, in zijn werk gaat. Neem bij vragen of voor meer bijzonderheden over inbouwpakketten contact op met uw JVC car audio dealer of een dealer of een bedrijf dat inbouwpakketten levert.

- *Als u niet zeker weet hoe u dit apparaat moet installeren, kunt u dit beter door een daartoe gekwalificeerde technicus laten doen.*

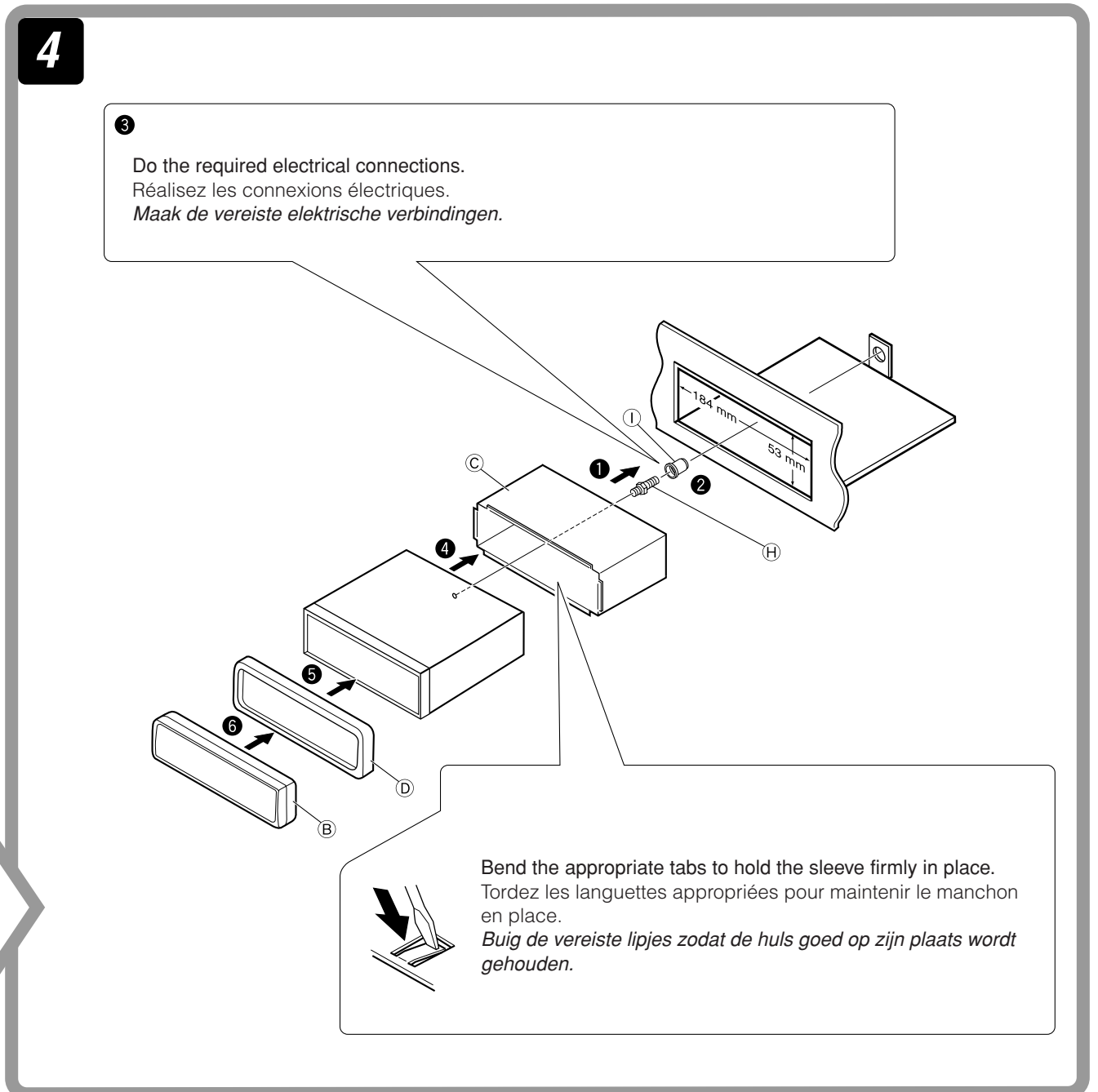
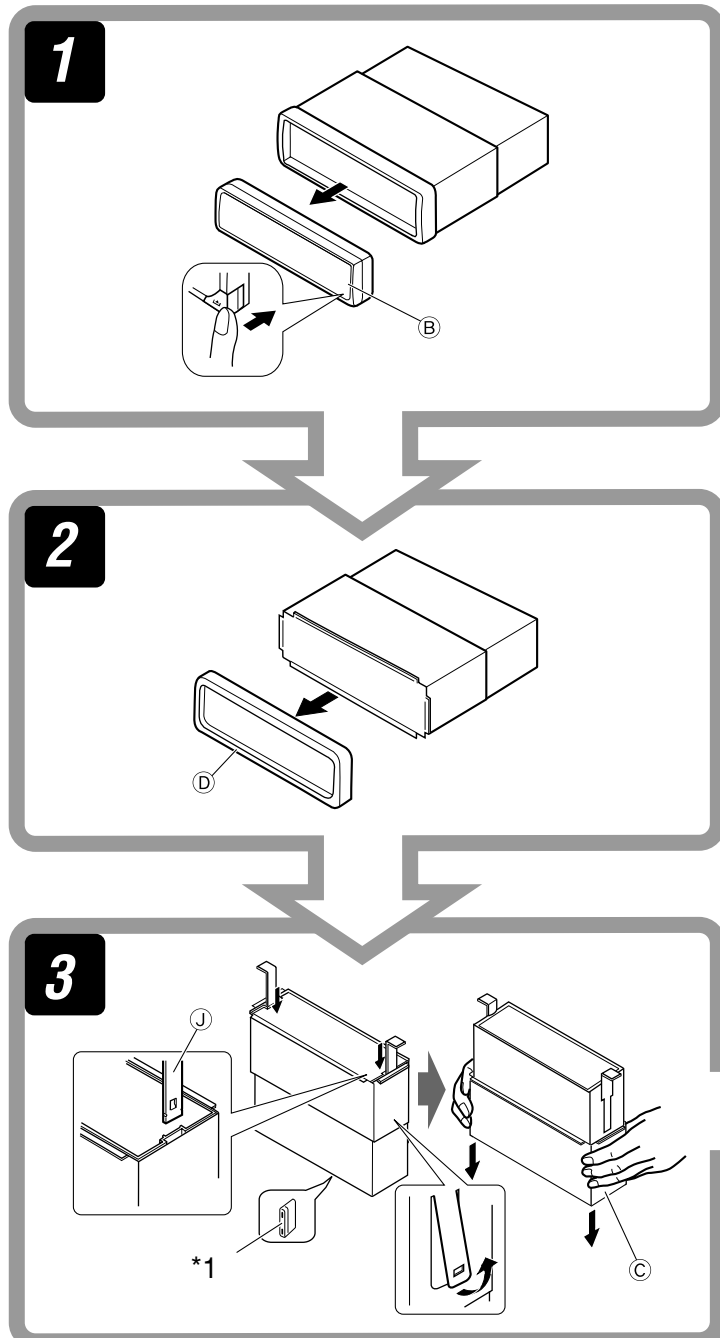

*1 When you stand the unit, be careful not to damage the fuse on the rear.

*1 Lorsque vous mettez l'appareil à la verticale, faire attention de ne pas endommager le fusible situé sur l'arrière.

*1 Wanneer u het apparaat rechtop zet, moet u erop letten dat u de zekering aan de achterkant niet beschadigt.

Removing the receiver

- Before removing the receiver, release the rear section.

Retrait de l'appareil

- Avant de retirer l'appareil, libérez la section arrière.

Verwijderen van de receiver

- Voordat u het apparaat verwijdert, moet u het achtergedeelte losmaken.

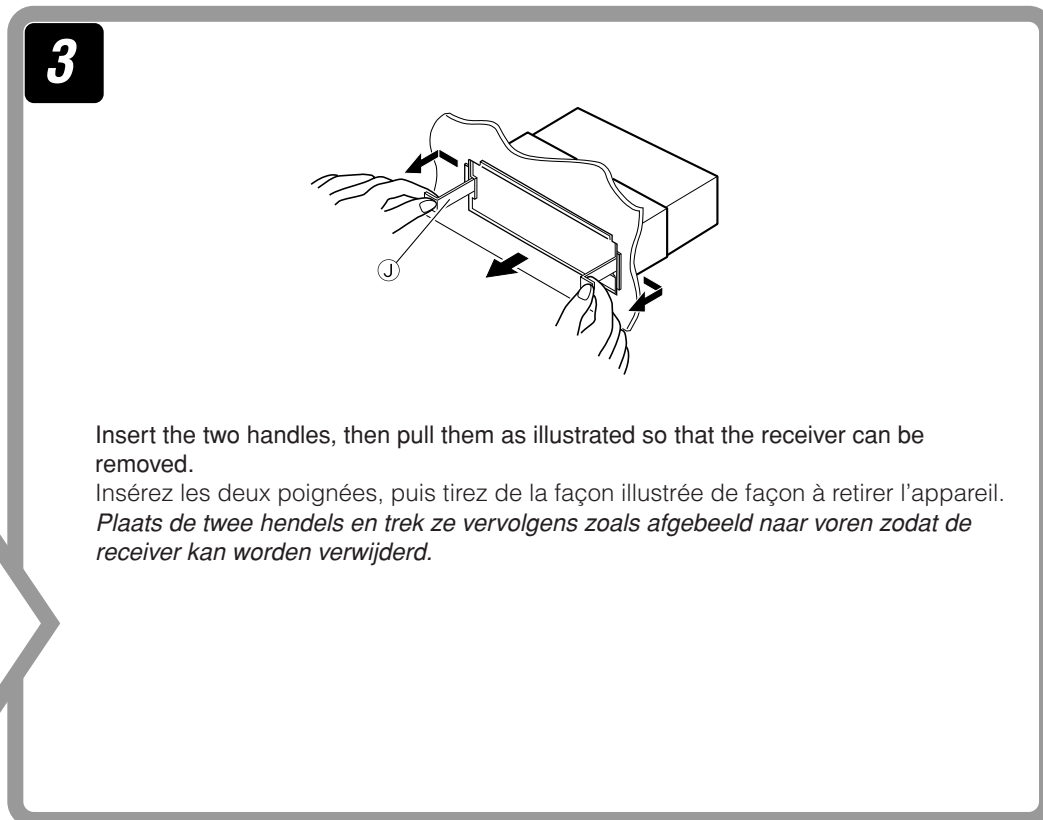
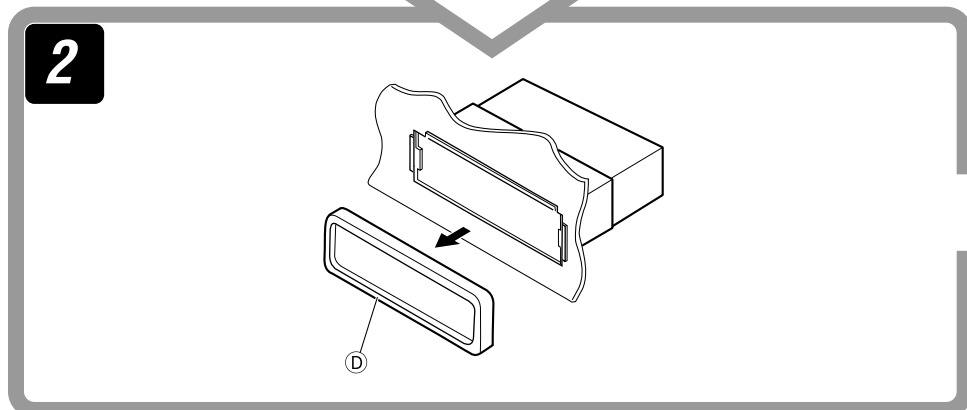
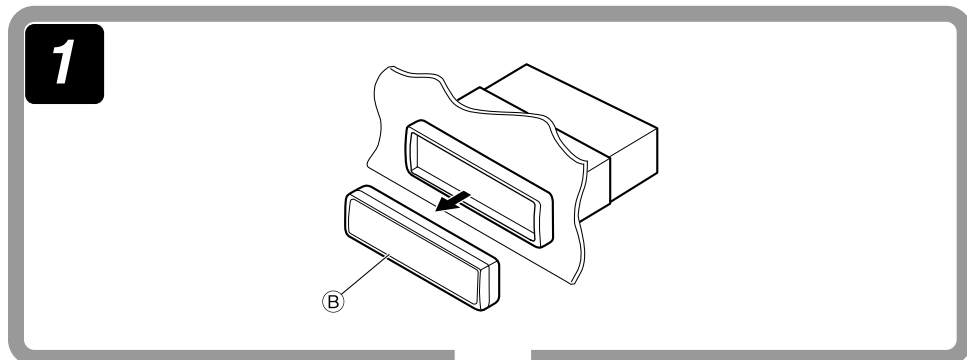

• When using the optional stay / Lors de l'utilisation du hauban en option / Wanneer u de steun gebruikt (facultatief)

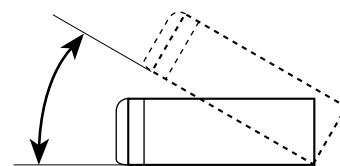
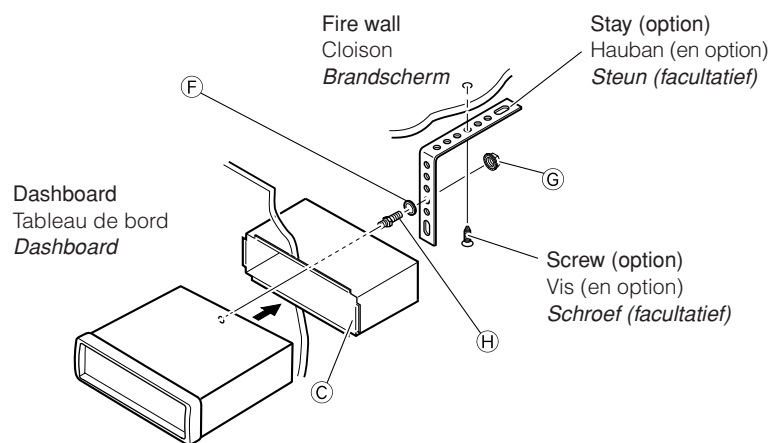

Install the unit at an angle of less than 30°.
Installez l'appareil avec un angle de moins de 30°.
Installeer het apparaat met een hoek kleiner dan 30°.

• When installing the unit without using the sleeve / Lors de l'installation de l'appareil sans utiliser de manchon / Wanneer u het apparaat zonder huls installeert

- In a Toyota for example, first remove the car radio and install the unit in its place.
Par exemple dans une Toyota, retirer d'abord l'autoradio et installer l'appareil à la place.
Voorbeeld: Bij een Toyota moet u eerst de autoradio verwijderen en daarna het apparaat installeren.

Flat type screws (M5 x 8 mm)*
Vis à tête plate (M5 x 8 mm)*
Platkopschroeven (M5 x 8 mm)*

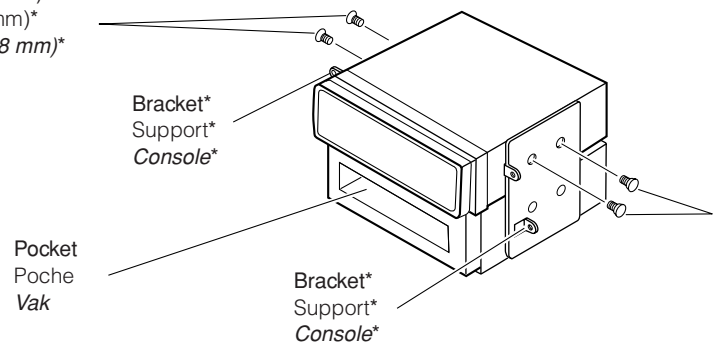

* Not included with this unit.
* Non fourni avec cet appareil.
* Niet meegeleverd.

- Note** : When installing the unit on the mounting bracket, make sure to use the 8 mm-long screws. If longer screws are used, they could damage the receiver.
Remarque : Lors de l'installation de l'appareil sur le support de montage, s'assurer d'utiliser des vis d'une longueur de 8 mm. Si des vis plus longues sont utilisées, elles peuvent endommager l'appareil.
Opmerking : Wanneer u het apparaat aan de bevestigingsklem vastmaakt, moet u de 8 mm lange schroeven gebruiken. Als u langere schroeven gebruikt, kan de receiver worden beschadigd.

TROUBLESHOOTING

- **The fuse blows.**
 - * Are the red and black leads connected correctly?
- **Power cannot be turned on.**
 - * Is the yellow lead connected?
- **No sound from the speakers.**
 - * Is the speaker output lead short-circuited?
- **Sound is distorted.**
 - * Is the speaker output lead grounded?
 - * Are the "-" terminals of L and R speakers grounded in common?
- **Noise interfere with sounds.**
 - * Is the rear ground terminal connected to the car's chassis using shorter and thicker cords?
- **Receiver becomes hot.**
 - * Is the speaker output lead grounded?
 - * Are the "-" terminals of L and R speakers grounded in common?
- **This receiver does not work at all.**
 - * Have you reset your receiver?

EN CAS DE DIFFICULTÉS

- **Le fusible saute.**
 - * Les fils rouge et noir sont-ils raccordés correctement?
- **L'appareil ne peut pas être mise sous tension.**
 - * Le fil jaune est-elle raccordée?
- **Pas de son des enceintes.**
 - * Le fil de sortie d'enceinte est-il court-circuité?
- **Le son est déformé.**
 - * Le fil de sortie d'enceinte est-il à la masse?
 - * Les bornes "-" des enceintes gauche et droit sont-elles mises ensemble à la masse?
- **Interférence avec les sons.**
 - * La prise arrière de mise à la masse est-elle connectée au châssis de la voiture avec un cordon court et épais?
- **L'appareil devient chaud.**
 - * Le fil de sortie d'enceinte est-il à la masse?
 - * Les bornes "-" des enceintes gauche et droite sont-elles mises ensemble à la masse?
- **Cet appareil ne fonctionne pas du tout.**
 - * Avez-vous réinitialisé votre appareil?

PROBLEMEN OPLOSSEN

- **De zekering slaat door.**
 - * Zijn de rode en de zwarte draden op de juiste manier aangesloten?
- **De stroom kan niet worden ingeschakeld.**
 - * Is de gele draad aangesloten?
- **Er komt geen geluid uit de luidsprekers.**
 - * Is de uitgaande luidsprekerdraad kortgesloten?
- **Het geluid wordt vervormd.**
 - * Is de uitgaande luidsprekerdraad geaard?
 - * Zijn de "-" polen van de linker- en de rechterluidsprekers gemeenschappelijk geaard?
- **Geluid wordt door ruis gestoord.**
 - * Is de aarde-aansluiting achter met gebruik van kortere en dikkere snoeren met het chassis van de auto verbonden?
- **De receiver wordt heet.**
 - * Is de uitgaande luidsprekerdraad geaard?
 - * Zijn de "-" polen van de linker- en de rechterluidsprekers gemeenschappelijk geaard?
- **Receiver werkt helemaal niet.**
 - * Heeft u de receiver teruggesteld?

ELECTRICAL CONNECTIONS

To prevent short circuits, we recommend that you disconnect the battery's negative terminal and make all electrical connections before installing the receiver.

- Be sure to ground this unit to the car's chassis again after installation.

Notes:

- Replace the fuse with one of the specified rating. If the fuse blows frequently, consult your JVC IN-CAR ENTERTAINMENT dealer.
- It is recommended to connect to the speakers with maximum power of more than 50 W (both at the rear and at the front, with an impedance of 4 Ω to 8 Ω). If the maximum power is less than 50 W, change "AMP GAIN" setting to prevent the speakers from being damaged (see page 24 of the INSTRUCTIONS).
- To prevent short-circuit, cover the terminals of the UNUSED leads with insulating tape.
- The heat sink becomes very hot after use. Be careful not to touch it when removing this receiver.

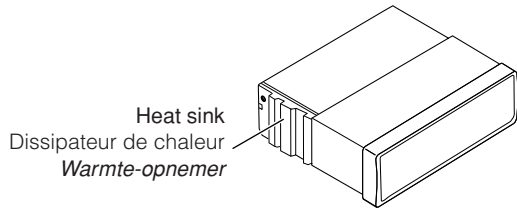

RACCORDEMENTS ELECTRIQUES

Pour éviter tout court-circuit, nous vous recommandons de débrancher la borne négative de la batterie et d'effectuer tous les raccordements électriques avant d'installer l'appareil.

- Assurez-vous de raccorder de nouveau la mise à la masse de cet appareil au châssis de la voiture après l'installation.

Remarques:

- Remplacer le fusible par un de la valeur précisée. Si le fusible saute souvent, consulter votre revendeur d'autoradios JVC.
- Il est recommandé de connecter des enceintes avec une puissance de plus de 50 W (les enceintes arrière et les enceintes avant, avec une impédance comprise entre 4 Ω et 8 Ω). Si la puissance maximum est inférieure à 50 W, changez le réglage "AMP GAIN" pour éviter d'endommager vos enceintes (voir page 24 du MANUEL D'INSTRUCTIONS).
- Pour éviter les court-circuits, couvrir les bornes des fils qui ne sont PAS UTILISÉS avec de la bande isolante.
- Le dissipateur de chaleur devient très chaud après usage. Faire attention de ne pas le toucher en retirant cet appareil.

ELEKTRISCHE VERBINDINGEN

Om kortsluiting te voorkomen adviseren wij u om de minpool van de accu los te maken en alle elektrische verbindingen tot stand te brengen voordat u de receiver in de auto installeert.

- Aard dit apparaat beslist weer op het chassis van de auto na het installeren.

Opmerkingen:

- Vervang de zekering door een exemplaar met het aangegeven vermogen. Als de zekering vaak doorslaat, moet u uw JVC car audio dealer raadplegen.
- Sluit bij voorkeur luidsprekers met een hoger maximaal vermogen dan 50 W (zowel achter als voor, met een impedantie van 4 Ω t/m 8 Ω) aan. Indien het maximale vermogen lager dan 50 W is, moet u "AMP GAIN" in de andere stand stellen zodat de luidsprekers niet kunnen worden beschadigd (zie bladzijde 24 van de GEBRUIKSAANWIJZING).
- Om kortsluiting te voorkomen, moet u de aansluitklemmen van ONGEBRUIKTE gekleurde draden met isolatieband bedekken.
- De warmte-opnemer kan na gebruik erg heet worden. Raak de warmte-opnemer niet aan wanneer u de receiver verwijderd.

A Typical connections / Raccordements typiques / Normale verbindingen

Before connecting: Check the wiring in the vehicle carefully. Incorrect connection may cause serious damage to this receiver.

The leads of the power cord and those of the connector from the car body may be different in color.

- 1 Connect the colored leads of the power cord in the order specified in the illustration below.
- 2 Connect the aerial cord.
- 3 Finally connect the wiring harness to the receiver.

Note: If your vehicle does not have any accessory terminal, move the fuse from the fuse position 1 (initial position) to fuse position 2, and connect the red lead (A7) to the positive (+) battery terminal.

- The yellow lead (A4) is not used in this case.

Avant de commencer la connexion: Vérifiez attentivement le câblage du véhicule. Une connexion incorrecte peut endommager sérieusement l'appareil.

Le fil du cordon d'alimentation et ceux des connecteurs du châssis de la voiture peuvent être différents en couleur.

- 1 Connectez les fils colorés du cordon d'alimentation dans l'ordre spécifié sur l'illustration ci-dessous.
- 2 Connectez le cordon d'antenne.
- 3 Finalement, connectez le faisceau de fils à l'appareil.

Remarque: Si votre véhicule ne possède pas de borne accessoire, déplacez le fusible de la position de fusible 1 (position originale) à la position de fusible 2 et connectez le fil rouge (A7) à la borne positive (+) de la batterie.

- Le fil jaune (A4) n'est pas utilisé dans ce cas.

Alvorens aan te sluiten: Controleer de bedrading van de auto zorgvuldig. De receiver kan ernstig worden beschadigd indien u verkeerde verbindingen maakt.

De draden van het stroomsnoer verschillen mogelijk van kleur met de aansluitingen op het chassis van de auto.

- 1 Verbind de gekleurde draden van het stroomsnoer in de afbeelding hieronder aangegeven volgorde.
- 2 Sluit de antenne aan.
- 3 Verbind de draadbundel daarna met de receiver.

Opmerking: Als uw auto niet beschikt over een accessoire-aansluiting, moet u de zekering verplaatsen van stand 1 (beginstand) naar stand 2 en moet u de rode draad (A7) met de pluspool (+) van de accu verbinden.

- In dit geval wordt de gele draad (A4) niet gebruikt.

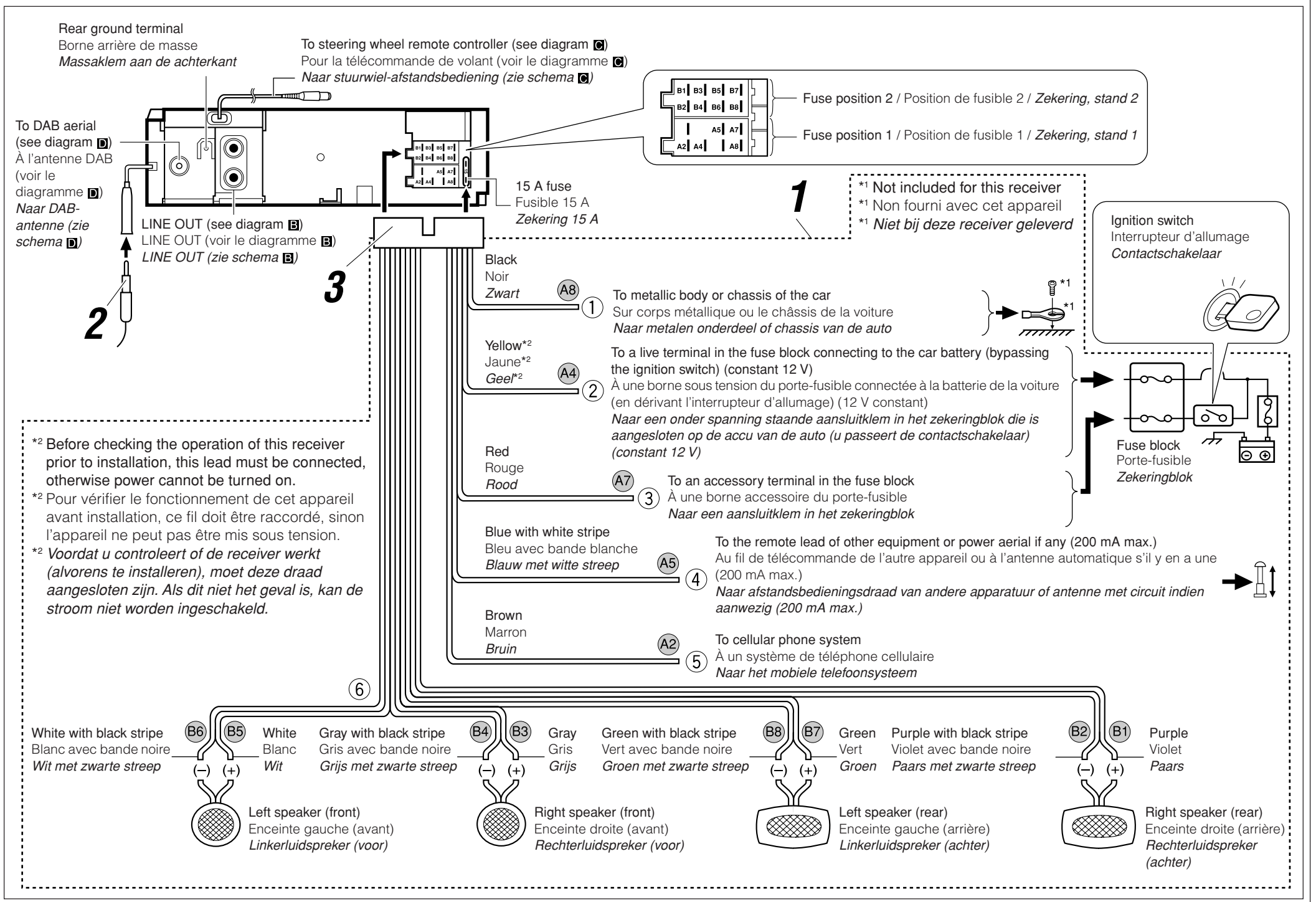

PRECAUTIONS on power supply and speaker connections:

- DO NOT connect the speaker leads of the power cord to the car battery; otherwise, the unit will be seriously damaged.
- BEFORE connecting the speaker leads of the power cord to the speakers, check the speaker wiring in your car.

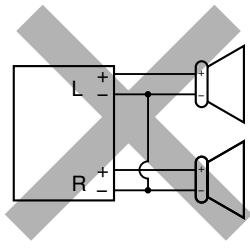

PRECAUTIONS sur l'alimentation et la connexion des enceintes:

- NE CONNECTEZ PAS les fils d'enceintes du cordon d'alimentation à la batterie; sinon, l'appareil serait sérieusement endommagé.
- AVANT de connecter les fils d'enceintes du cordon d'alimentation aux enceintes, vérifiez le câblage des enceintes de votre voiture.

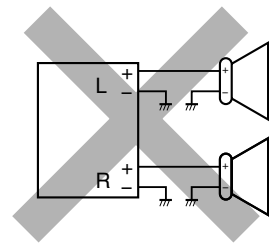

VOORZORGSMAATREGELEN bij het verbinden van de stroomkabel en de luidsprekers:

- Verbind de luidsprekerdraden van de stroomkabel NIET met de accu van de auto; als u dit wel doet, zal het apparaat ernstige schade oplopen.
- VOORDAT u de luidsprekerdraden van de stroomkabel met de luidsprekers verbindt, moet u de bedrading van de luidsprekers in uw auto controleren.

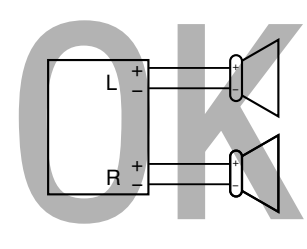

B Connecting the external amplifier / Connexion d'un amplificateur extérieur / Aansluiten van een externe versterker

You can connect an amplifier to upgrade your car stereo system.

- Connect the remote lead (blue with white stripe) to the remote lead of the other equipment so that it can be controlled through this receiver.
- **Disconnect the speakers from this receiver, connect them to the amplifier. Leave the speaker leads of this receiver unused.**

Vous pouvez connecter un amplificateur pour améliorer votre système autoradio.

- Connectez le fil de télécommande (bleu avec bande blanche) au fil de commande à distance de l'autre appareil de façon qu'il puisse être commandé via cet appareil.
- **Déconnectez les enceintes de cet appareil et connectez-les à l'amplificateur. Laissez les fils d'enceintes de cet appareil inutilisés.**

Het is mogelijk om uw autostereosysteem uit te breiden door een versterker aan te sluiten.

- Verbind de afstandsbedieningsdraad (blauw met witte streep) met de afstandsbedieningsdraad van de andere apparatuur zodat deze op afstand via deze receiver kan worden bediend.
- **Ontkoppel de luidsprekers van deze receiver en verbind ze met de versterker. Gebruik de luidsprekerdraden van deze receiver niet.**

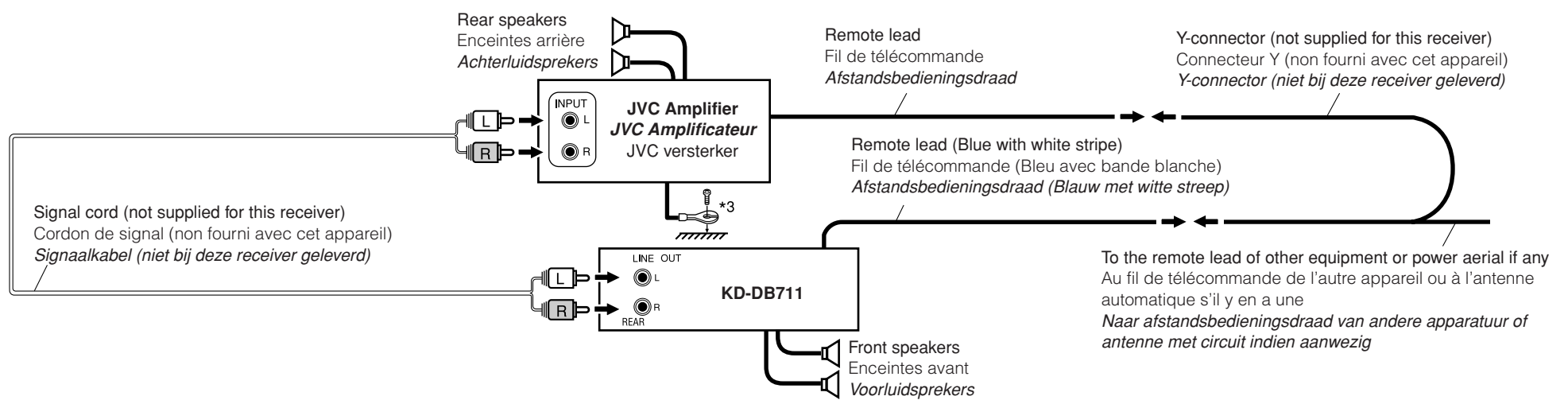

- *3 Firmly attach the ground wire to the metallic body or to the chassis of the car—to the place not coated with paint (if coated with paint, remove the paint before attaching the wire). Failure to do so may cause damage to the receiver.
- *3 Attachez solidement le fil de mise à la masse au châssis métallique de la voiture—à un endroit qui n'est pas recouvert de peinture (s'il est recouvert de peinture, enlevez d'abord la peinture avant d'attacher le fil). L'appareil peut être endommagé si cela n'est pas fait correctement.
- *3 Bevestig de aarddraad goed met een metalen onderdeel of het chassis van de auto—bevestig op een niet-gelakt gedeelte (indien gelakt, schuur dan af alvorens de draad te bevestigen). De receiver kan worden beschadigd indien de aarddraad niet goed is aangesloten.

C Connecting to the steering wheel remote controller / Connexion de la télécommande de volant / Verbinden met de stuurwiel-afstandsbediening

If your car is equipped with the steering wheel remote controller, you can operate this receiver using the controller. To do it, a JVC's OE remote adapter (not supplied) which matches with your car is required. Consult your JVC IN-CAR ENTERTAINMENT dealer for details.

Si votre voiture est munie d'une télécommande de volant, vous pouvez commander cet autoradio en utilisant la télécommande. Pour le faire, un adaptateur pour télécommande de volant JVC (non fourni) correspondant à votre voiture est nécessaire. Consultez votre revendeur d'autoradio JVC pour les détails.

Indien uw auto een stuurwiel-afstandsbediening heeft, kunt u deze receiver met die afstandsbediening bedienen. Hiervoor heeft u echter een JVC adapter voor stuurwiel-afstandsbediening (niet bijgeleverd) nodig die geschikt is voor uw auto. Raadpleeg uw JVC car audio dealer voor details.

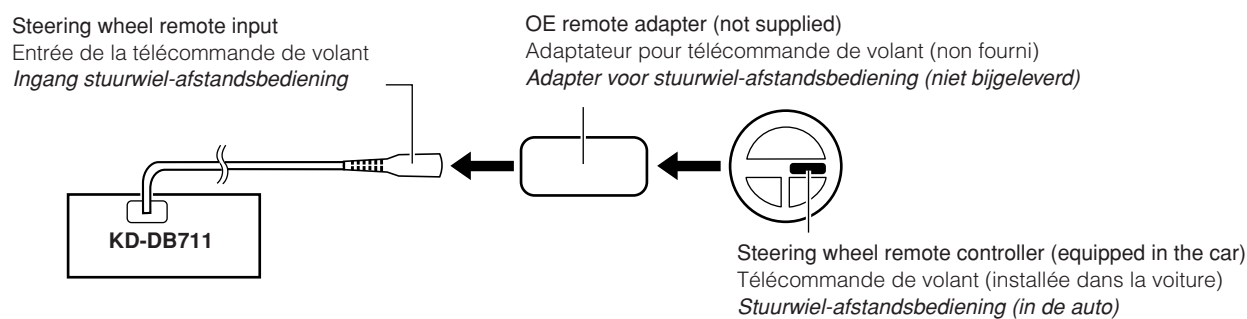

D Connecting to the DAB aerial / Connexion à l'antenne DAB / Verbinden van de DAB-antenne

If you connect the DAB aerial with the booster (not supplied), you can allow this receiver to supply the power to the aerial (see page 24 of the INSTRUCTIONS).

Si vous connectez l'antenne DAB avec un suramplificateur (non fourni), vous pouvez utiliser cet appareil pour alimenter l'antenne (référez-vous à la page 24 du MANUEL D'INSTRUCTIONS).

Indien u een DAB-antenne met spanningsverhoger (niet bijgeleverd) heeft, kunt u stroom via deze receiver naar de antenne sturen (zie bladzijde 24 van de GEBRUIKSAANWIJZING).

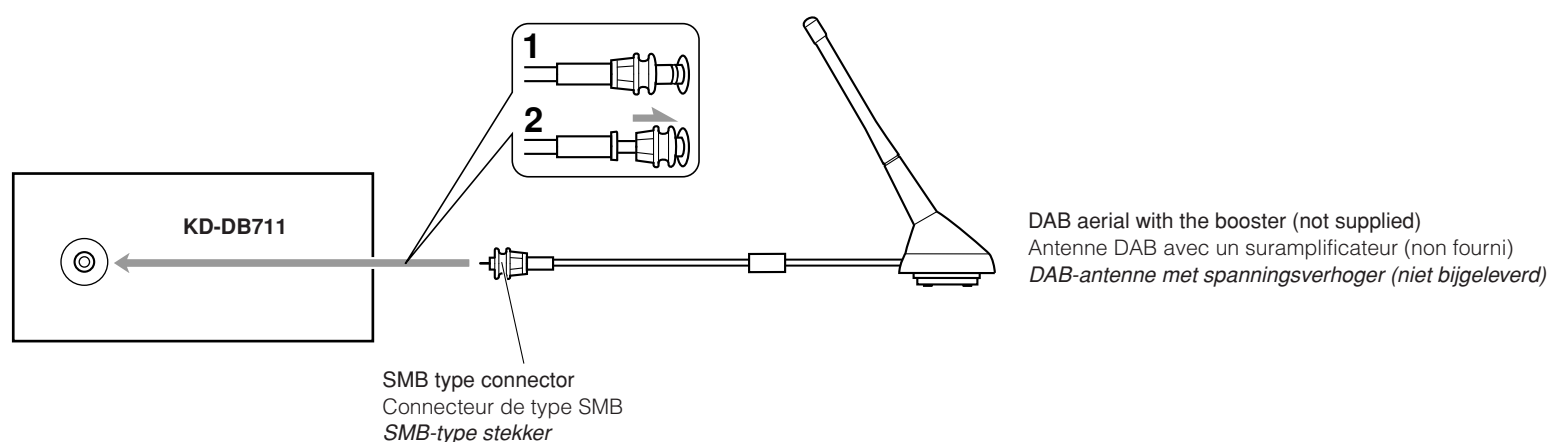

Free Manuals Download Website

<http://myh66.com>

<http://usermanuals.us>

<http://www.somanuals.com>

<http://www.4manuals.cc>

<http://www.manual-lib.com>

<http://www.404manual.com>

<http://www.luxmanual.com>

<http://aubethermostatmanual.com>

Golf course search by state

<http://golfingnear.com>

Email search by domain

<http://emailbydomain.com>

Auto manuals search

<http://auto.somanuals.com>

TV manuals search

<http://tv.somanuals.com>