

JVC



CD RECEIVER
CD-RECEIVER
RECEPTEUR CD
CD-RECEIVER

KD-G202/KD-G201



CD-RW

**COMPACT
disc
DIGITAL AUDIO**



KD-G202

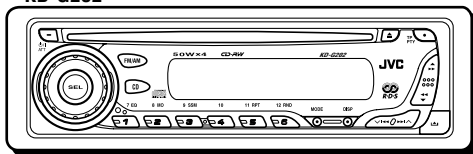

KD-G201

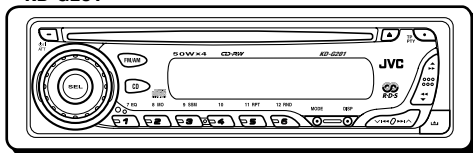

- This unit is equipped with the display demonstration. To cancel it, see page 6.
- Dieses Gerät ist mit einer Demonstrationsfunktion für das Display ausgestattet. Auf Seite 6 wird beschrieben, wie Sie diese Demonstrationsfunktion deaktivieren können.
- Cet appareil est équipé d'une fonction de démonstration des affichages. Pour l'annuler, référez-vous à la page 6.
- Dit toestel heeft een display-demonstratiefunctie. Zie bladzijde 6 voor het annuleren van deze functie.

For installation and connections, refer to the separate manual.

Für den Einbau und die Anschlüsse siehe das eigenständige Handbuch.

Pour l'installation et les raccordements, se référer au manuel séparé.

Bijzonderheden over de installatie en aansluiting van het apparaat vindt u in de desbetreffende handleiding.

INSTRUCTIONS

BEDIENUNGSANLEITUNG
MANUEL D'INSTRUCTIONS
GEBRUIKSAANWIJZING

GET0184-001A
[E/EX]

IMPORTANT FOR LASER PRODUCTS

1. CLASS 1 LASER PRODUCT
2. **CAUTION:** Do not open the top cover. There are no user serviceable parts inside the unit; leave all servicing to qualified service personnel.
3. **CAUTION:** Visible and invisible laser radiation when open and interlock failed or defeated. Avoid direct exposure to beam.
4. REPRODUCTION OF LABEL: CAUTION LABEL, PLACED OUTSIDE THE UNIT.

CAUTION: Visible and invisible laser radiation when open and interlock failed or defeated. AVOID DIRECT EXPOSURE TO BEAM.	ADVARSEL: Synlig og usynlig laserstråling når maskinen er åben eller interlocken fejler. Undgå direkte eksponering til stråling.	VARNING: Synlig og usynlig laserstråling når dækket åbnes og spærren er urkøbt/afslået. Betragt strålen.	VARO: Avattassa ja suojalukitus ohittettuna tai viallisena olet alttina näkyvälle ja näkymättömälle lasersträilylle. Vältä siltien kohdistumista suoraan itseesi. (f)
---	--	---	--

How to reset your unit

While holding SEL (select), press **⏻/I ATT** (standby/on attenuator) for more than 2 seconds. This will reset the built-in microcomputer.

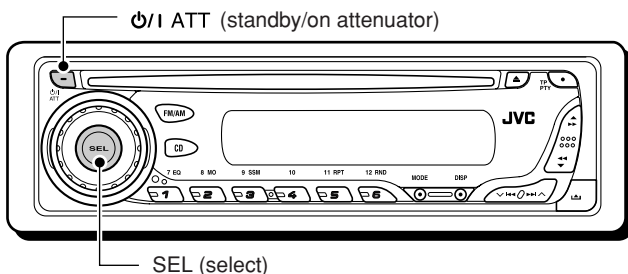

Notes:

- Your preset adjustments—such as preset channels or sound adjustments—will also be erased.
- If a CD is in the unit, it will eject when you reset the unit. Be careful not to drop the CD.

How to use the MODE button

If you press MODE, the unit goes into functions mode, then the number buttons work as different function buttons.

Ex.: When number button 2 works as MO (monaural) button.

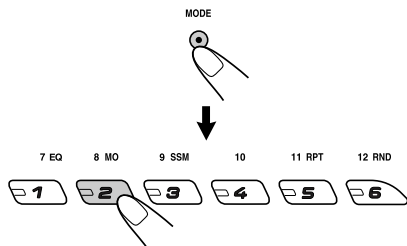

Time countdown indicator

To use these buttons for original functions again after pressing MODE, wait for 5 seconds without pressing any of these buttons until the functions mode is cleared.

- Pressing MODE again also clears the functions mode.

Thank you for purchasing a JVC product. Please read all instructions carefully before operation, to ensure your complete understanding and to obtain the best possible performance from the unit.

CONTENTS

How to reset your unit	2	CD OPERATIONS	19
How to use the MODE button	2	Playing a CD	19
LOCATION OF THE BUTTONS	4	Locating a track or a particular portion on a CD	20
Control panel	4	Selecting CD playback modes	20
BASIC OPERATIONS	5	Prohibiting CD ejection	21
Turning on the power	5	SOUND ADJUSTMENTS	22
Canceling the display demonstration	6	Selecting preset sound modes (C-EQ: custom equalizer)	22
Setting the clock	7	Adjusting the sound	23
RADIO OPERATIONS	8	OTHER MAIN FUNCTIONS	24
Listening to the radio	8	Changing the general settings (PSM)	24
Storing stations in memory	10	Detaching the control panel	26
Tuning in to a preset station	11	TROUBLESHOOTING	27
RDS OPERATIONS	12	MAINTENANCE	28
What you can do with RDS	12	Handling discs	28
Other convenient RDS functions and adjustments	17	SPECIFICATIONS	29

KD-G202 and KD-G201 are equipped with the steering wheel remote control function. If your car is equipped with the steering wheel remote controller, you can operate the unit using the controller.

- See the Installation/Connection Manual (separate volume) for connection to utilize this function.

Note:

For security reasons, a numbered ID card is provided with this unit, and the same ID number is imprinted on the unit's chassis. Keep the card in a safe place, as it will help the authorities to identify your unit if stolen.

BEFORE USE

***For safety...**

- Do not raise the volume level too much, as this will block outside sounds, making driving dangerous.
- Stop the car before performing any complicated operations.

***Temperature inside the car...**

If you have parked the car for a long time in hot or cold weather, wait until the temperature in the car becomes normal before operating the unit.



LOCATION OF THE BUTTONS

Control panel

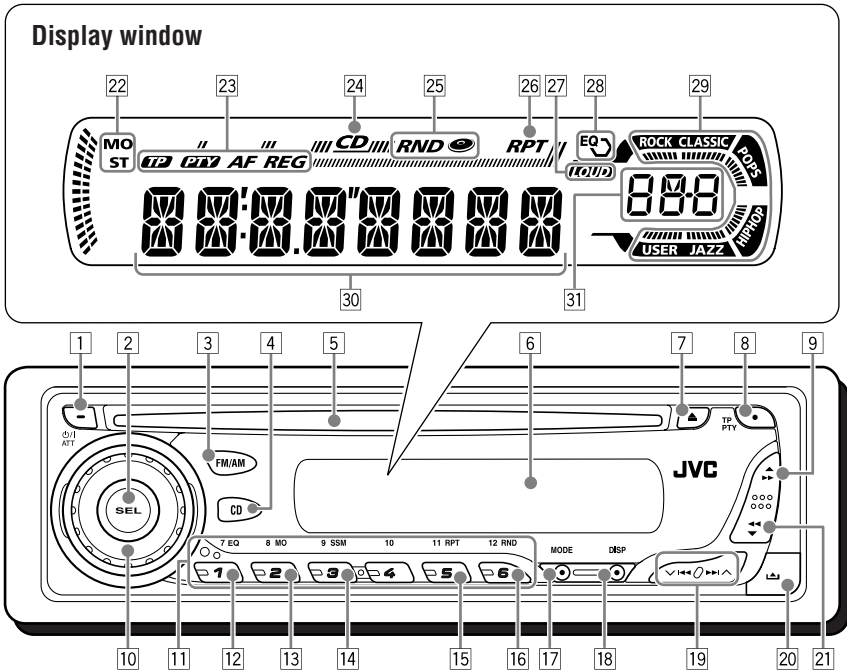

- 1 **⏻/ATT** (standby/on attenuator) button
- 2 **SEL** (select) button
- 3 **FM/AM** button
- 4 **CD** button
- 5 Loading slot
- 6 Display window
- 7 **▲** (eject) button
- 8 **TP PTY** (traffic programme/programme type) button
- 9 **▲** (up) button
▶▶ (fast-forward) button
- 10 Control dial
- 11 Number buttons
- 12 **EQ** (equalizer) button
- 13 **MO** (monaural) button
- 14 **SSM** (Strong-station Sequential Memory) button
- 15 **RPT** (repeat) button
- 16 **RND** (random) button
- 17 **MODE** button
- 18 **DISP** (display) button
- 19 **▼** **◀▶** **▶▶** **▲** buttons

- 20 **⏻** (control panel release) button
- 21 **▼** (down) button
◀◀ (reverse) button

Display window

- 22 Tuner reception indicators
MO (monaural), ST (stereo)
- 23 RDS indicators
TP, PTY, AF, REG
- 24 **CD** indicator
- 25 **RND** (random disc) indicator
- 26 **RPT** (repeat) indicator
- 27 **LOUD** (loudness) indicator
- 28 **EQ** (equalizer) indicator
- 29 Sound mode (**C-EQ**: custom equalizer) indicators
ROCK, CLASSIC, POPS, HIP HOP, JAZZ, USER
- 30 Main display
- 31 Source display
Volume level indicator

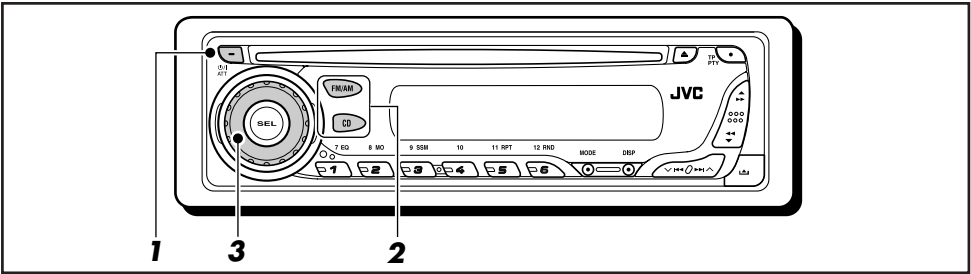

Turning on the power

1 Turn on the power.



Note on One-Touch Operation:

When you select a source in step 2 below, the power automatically comes on. You do not have to press this button to turn on the power.

2 Select the source.

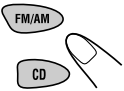

To operate the tuner (FM or AM),
see pages 8 – 18.
To play a CD,
see pages 19 – 21.

3 Adjust the volume.

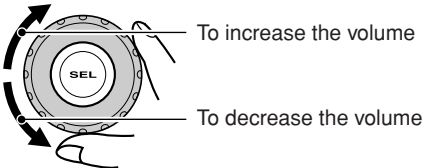

Volume level appears.

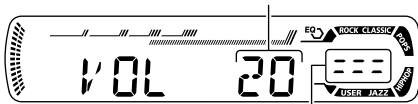

Volume level indicator

4 Adjust the sound as you want. (See pages 22 and 23.)

To drop the volume in a moment

Press **PWR/ATT** briefly while listening to any source. "ATT" starts flashing on the display, and the volume level will drop in a moment.

To resume the previous volume level, press the button briefly again.

- If you turn the control dial, you can also restore the sound.

To turn off the power

Press and hold **PWR/ATT** for more than one second.

"SEE YOU" appears, then the unit turns off.

- **If you turn off the power while listening to a CD,** CD play will start from where playback has been stopped previously, next time you turn on the power.

CAUTION on Volume Setting:

CDs produce very little noise compared with other sources. If the volume level is adjusted for the tuner, for example, the speakers may be damaged by the sudden increase in the output level. Therefore, lower the volume before playing a CD and adjust it as required during playback.

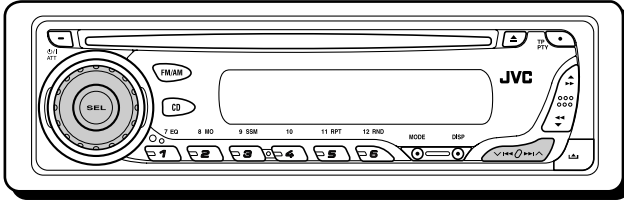

Canceling the display demonstration

When shipped from the factory, display demonstration has been activated, and starts automatically when no operations are done for about 20 seconds.

- It is recommended to cancel the display demonstration before you use the unit for the first time.

To cancel the display demonstration, follow the procedure below:

- 1 Press and hold SEL (select) for more than 2 seconds so that one of the PSM items appears on the display. (PSM: see pages 24 and 25.)**



- 2 Select "DEMO" if not shown on the display.**

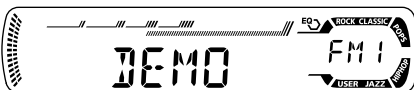
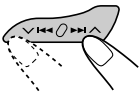

- 3 Select "DEMO OFF."**

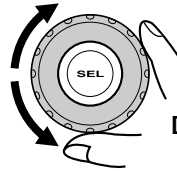

DEMO OFF ↔ DEMO ON



- 4 Finish the setting.**



To activate the display demonstration, repeat the same procedure and select "DEMO ON" in step **3**.

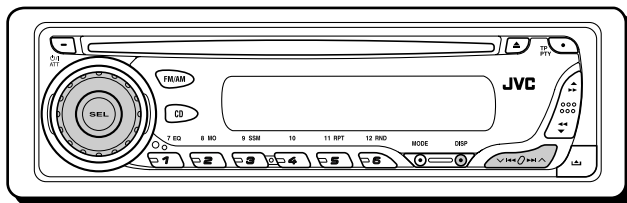

Setting the clock

You can also set the clock system to either 24 hours or 12 hours.

- 1 Press and hold SEL (select) for more than 2 seconds so that one of the PSM items appears on the display. (PSM: see pages 24 and 25.)**



- 2 Set the hour.**

- Select "CLOCK H" (hour) if not shown on the display.
- Adjust the hour.

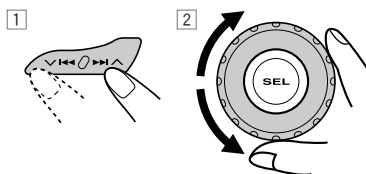

- 3 Set the minute.**

- Select "CLOCK M" (minute).
- Adjust the minute.

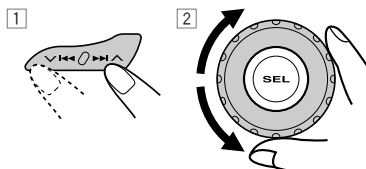

- 4 Set the clock system.**

- Select "24H/12H."
- Select "24H" or "12H."

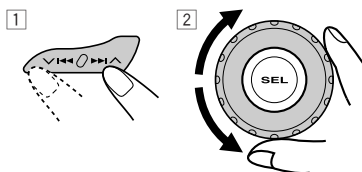

- 5 Finish the setting.**



To check the current clock time or change the display mode

DISP



Press DISP (display) repeatedly. Each time you press the button, the display changes as follows:

- During AM and FM non-RDS station operation:

Frequency ↔ Clock

- During FM RDS Station operation:

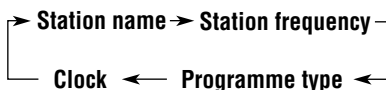

- During CD operation:

Elapsed playing time ↔ Clock

- During power off:

The power turns on and the clock time is shown for 5 seconds, then the power turns off.



RADIO OPERATIONS

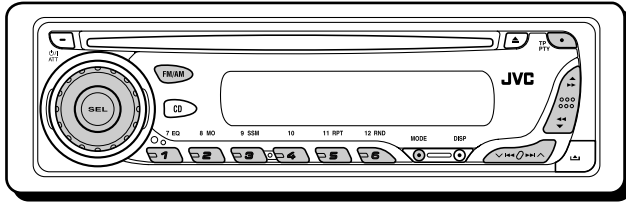

Listening to the radio

You can use either automatic searching or manual searching to tune in to a particular station.

Searching for a station automatically: Auto search

1 Select the band (FM1 – 3, AM).



Each time you press the button, the band changes as follows:

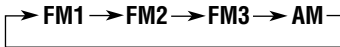

Lights up when receiving an FM stereo broadcast with sufficient signal strength.

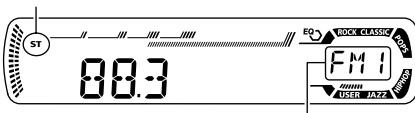

Selected band appears.

Note:

This receiver has three FM bands (FM1, FM2, FM3). You can use any one of them to listen to an FM broadcast.

2 Start searching for a station.



To search for stations of higher frequencies

To search for stations of lower frequencies

When a station is received, searching stops.

To stop searching before a station is received, press the same button you have pressed for searching.

Searching for a station manually: Manual search

1 Select the band (FM1 – 3, AM).



Each time you press the button, the band changes as follows:

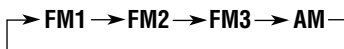

Note:

This receiver has three FM bands (FM1, FM2, FM3). You can use any one of them to listen to an FM broadcast.

2 Press and hold **▶▶|▲** or **▼|◀◀** until “M” (manual) starts flashing on the display.

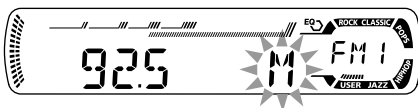
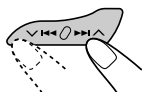

3 Tune in to a station you want while “M” (manual) is still flashing.



To tune in to stations of higher frequencies

To tune in to stations of lower frequencies

- If you release your finger from the button, the manual mode will automatically turn off after 5 seconds.
- If you hold down the button, the frequency keeps changing (in 50 kHz intervals for FM and 9 kHz for AM—MW/LW) until you release the button.

When an FM stereo broadcast is hard to receive

MODE



- 1 Press MODE to enter the functions mode while listening to an FM stereo broadcast.

8 MO



- 2 Press MO (monaural), while “MODE” is still flashing on the display, so that “MONO” appears on the display. Each time you press the button, monaural mode turns on and off alternately.

MO (monaural) indicator

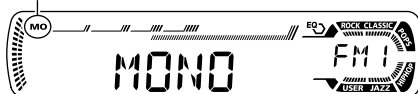

When the MO indicator is lit on the display, the sound you hear becomes monaural but the reception will be improved.



Storing stations in memory

You can use one of the following two methods to store broadcasting stations in memory.

- Automatic preset of FM stations: SSM (Strong-station Sequential Memory)
- Manual preset of both FM and AM stations

FM station automatic preset: SSM

You can preset 6 local FM stations in each FM band (FM1, FM2, and FM3).

- Select the FM band (FM1 – 3) you want to store FM stations into.**



Each time you press the button, the band changes as follows:

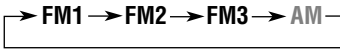

- Press MODE to enter the functions mode.**

MODE



- Press and hold SSM for about 2 seconds.**

SSM

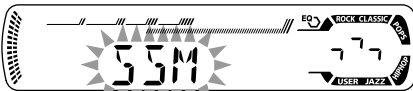
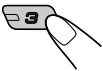

“SSM” flashes, then disappears when automatic preset is over.

Local FM stations with the strongest signals are searched and stored automatically in the band number you have selected (FM1, FM2, or FM3). These stations are preset in the number buttons—No.1 (lowest frequency) to No.6 (highest frequency).

When automatic preset is over, the station stored in number button 1 will be automatically tuned in.

Manual preset

You can preset up to 6 stations in each band (FM1, FM2, FM3, and AM) manually.

Ex.: Storing FM station of 92.5 MHz into the preset number 1 of the FM1 band.

- Select the band (FM1 – 3, AM) you want to store stations into (in this example, FM1).**



Each time you press the button, the band changes as follows:

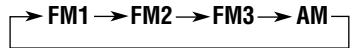

- Tune in to a station (in this example, of 92.5 MHz).**

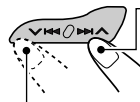

To tune in to stations of higher frequencies

To tune in to stations of lower frequencies

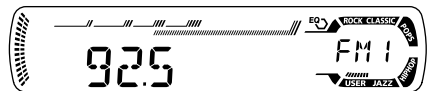

- 3** Press and hold the number button (in this example, 1) for more than 2 seconds.

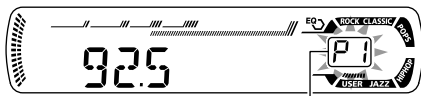
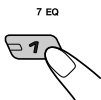

Preset number flashes for a while.

- 4** Repeat the above procedure to store other stations into other preset numbers.

Notes:

- A previously preset station is erased when a new station is stored in the same preset number.
- Preset stations are erased when the power supply to the memory circuit is interrupted (for example, during battery replacement). If this occurs, preset the stations again.

Tuning in to a preset station

You can easily tune in to a preset station. Remember that you must store stations first. If you have not stored them yet, see “Storing stations in memory” on pages 10 and 11.

- 1** Select the band (FM1 – 3, AM).



Each time you press the button, the band changes as follows:

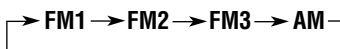

- 2** Select the number (1 – 6) for the preset station you want.

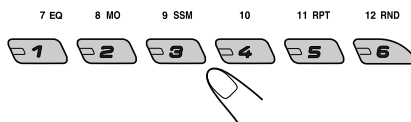

Note:

You can also use the ▲ (up) or ▼ (down) button on the unit to select the next or previous preset stations. Each time you press the ▲ (up) or ▼ (down) button, the next or previous preset station is tuned in.



RDS OPERATIONS

What you can do with RDS

RDS (Radio Data System) allows FM stations to send an additional signal along with their regular programme signals. For example, the stations send their station names, as well as information about what type of programme they broadcast, such as sports or music, etc.

Another advantage of RDS function is called "Enhanced Other Networks." By using the Enhanced Other Networks data sent from a station, you can tune in to a different station of a different network broadcasting your favorite programme or traffic announcement while listening to another programme or to another source such as CD.

By receiving the RDS data, this unit can do the following:

- Tracing the same programme automatically (Network-Tracking Reception)
- Standby Reception of TA (Traffic Announcement) or your favorite programme
- PTY (Programme Type) search
- Programme search
- And some other functions

Tracing the same programme automatically (Network-Tracking Reception)

When driving in an area where FM reception is not good, the tuner built in this unit automatically tunes in to another RDS station, broadcasting the same programme with stronger signals. So, you can continue to listen to the same programme in its finest reception, no matter where you drive. (See the illustration on page 18.)

Two types of the RDS data are used to make Network-Tracking Reception work correctly —PI (Programme Identification) and AF (Alternative Frequency).

Without receiving these data correctly from the RDS station you are listening to, Network-Tracking Reception will not operate.

To use Network-Tracking Reception

You can select the different modes of network-tracking reception to continue listening to the same programme in its finest reception. When shipped from the factory, "AF" is selected.

- **AF:** Network-Tracking Reception is activated with Regionalization set to "off." With this setting, the unit switches to another station within the same network when the received signals from the current station become weak. (In this mode, the programme may differ from the one currently received.) The AF indicator lights up but the REG indicator does not.
- **AF REG:** Network-Tracking Reception is activated with Regionalization set to "on." With this setting, the unit switches to another station, within the same network, broadcasting the same programme when the received signals from the current station become weak. Both the AF indicator and the REG indicator light up.
- **OFF:** Network-Tracking Reception is deactivated. Neither the AF indicator nor the REG indicator lights up.

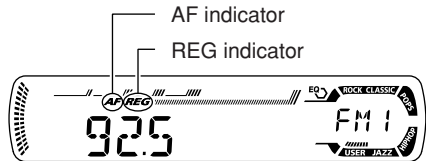



- 1** Press and hold SEL (select) for more than 2 seconds so that one of the PSM items appears on the display. (PSM: see pages 24 and 25.)



- 2** Select “AF-REG” (alternative frequency/regionalization reception) if not shown on the display.

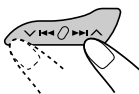

- 3** Select the desired mode—“AF,” “AF REG,” or “OFF.”

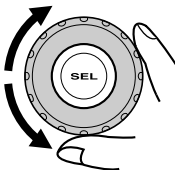

- 4** Finish the setting.



Using TA Standby Reception

TA Standby Reception allows the unit to switch temporarily to Traffic Announcement (TA) from the current source (another FM station or CD).

- TA Standby Reception will not work if you are listening to an AM station.

Press TP PTY to activate TA Standby Reception.



- When the current source is FM, the TP indicator either lights up or flashes.

- If the TP indicator lights up, TA Standby Reception is activated.

If a station starts broadcasting a traffic announcement, “TRAFFIC” appears on the display, and this unit automatically tunes in to the station. The volume changes to the preset TA volume level (see page 17) and the traffic announcement can be heard.

- If the TP indicator flashes, TA Standby Reception is not yet activated since the station being received does not provide the signals used for TA Standby Reception. To activate TA Standby Reception, you need to tune in to another station providing these signals. Press ►►| ^ or v |◄◄ to search for such a station.

When a station providing these signals is tuned in, the TP indicator stops flashing and remains lit. Now TA Standby Reception is activated.

- When the current source is other than FM, the TP indicator lights up.

If a station starts broadcasting a traffic announcement, “TRAFFIC” appears on the display, and this unit automatically changes the source and tunes in to the station.

To deactivate the TA Standby Reception, press TP PTY again. The TP indicator disappears.



Using PTY Standby Reception

PTY Standby Reception allows the unit to switch temporarily to your favorite programme (PTY: Programme Type) from the current source (another FM station or CD).

- *PTY Standby Reception will not work if you are listening to an AM station.*

You can select your favorite programme type for PTY Standby Reception.

When shipped from the factory, PTY Standby Reception is turned off. ("OFF" is selected for PTY Standby Reception.)

- 1 Press and hold SEL (select) for more than 2 seconds so that one of the PSM items appears on the display.** (PSM: see pages 24 and 25.)



- 2 Select "PTY STBY" (standby) if not shown on the display.**

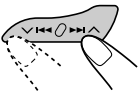

- 3 Select one of the twenty-nine PTY codes. (See page 18.)**

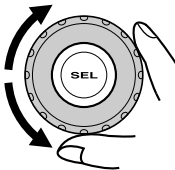

Selected code name appears on the display and is stored into memory.

- 4 Finish the setting.**



- **When the current source is FM,** the PTY indicator either lights up or flashes.
 - **If the PTY indicator lights up,** PTY Standby Reception is activated. If a station starts broadcasting the selected PTY programme, this unit automatically tunes in to the station.
 - **If the PTY indicator flashes,** PTY Standby Reception is not yet activated since the station being received does not provide the signals used for PTY Standby Reception. To activate PTY Standby Reception, you need to tune in to another station providing these signals. Press ►►| ▲ or ▼ |◄◄ to search for such a station. When a station providing these signals is tuned in, the PTY indicator stops flashing and remains lit. Now PTY Standby Reception is activated.
- **When the current source is other than FM,** the PTY indicator lights up. If a station starts broadcasting the selected PTY programme, this unit automatically changes the source and tunes in to the station.

To deactivate the PTY Standby Reception, select "OFF" in step 3 on the left column. The PTY indicator disappears.



Searching your favorite programme

You can search any one of the PTY codes. In addition, you can store your 6 favorite programme types in the number buttons. When shipped from the factory, the following 6 programme types have been stored in the number buttons (1 to 6).

To store your favorite programme types, see below.

To search your favorite programme type, see page 16.

1	2	3
POP M	ROCK M	EASY M
4	5	6
CLASSICS	AFFAIRS	VARIED

To store your favorite programme types

- 1 Press and hold TP PTY for more than 2 seconds while listening to an FM station.

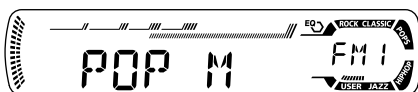

The last selected PTY code appears.

- 2 Select one of the twenty-nine PTY codes. (See page 18.)

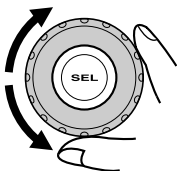

Selected code name appears on the display.

- 3 Press and hold the number button for more than 2 seconds to store the PTY code selected into the preset number you want.

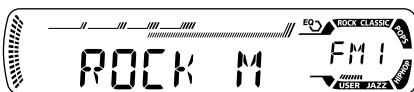
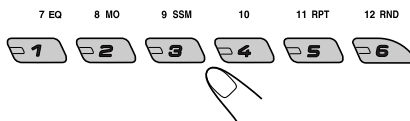

Selected PTY code and "MEMORY" appear alternately for a while.



- 4 Press and hold TP PTY for more than 2 seconds to exit from this mode.





To search your favorite programme type

- 1 Press and hold TP PTY for more than 2 seconds while listening to an FM station.

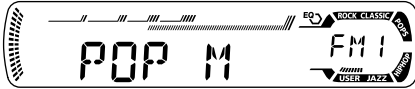

The last selected PTY code appears.

- 2 To select one of your favorite programme type

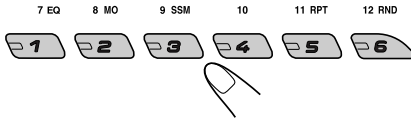

or

To select any one of the twenty-nine PTY codes.

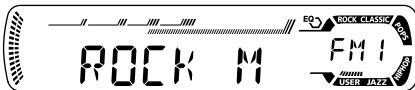
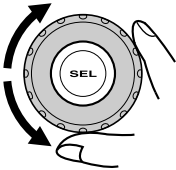

Ex.: When "ROCK M" is selected

- 3 Press $\gg| \wedge$ or $\vee | \ll$ to start PTY search for your favorite programme.

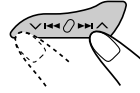

- If there is a station broadcasting a programme of the same PTY code as you selected, that station is tuned in.
- If there is no station broadcasting a programme of the same PTY code as you selected, the station will not change.

Note:

In some areas, the PTY search will not work correctly.



Other convenient RDS functions and adjustments

Automatic selection of the station when using the number buttons

Usually when you press the number button, the preset station is tuned in.

However, when the preset station is an RDS station, something different will happen. If the signals from that preset station are not sufficient for good reception, this unit, using the AF data, tunes in to another frequency broadcasting the same programme as the original preset station is broadcasting. (Programme search)

- The unit takes some time to tune in to another station using programme search.

To activate programme search, follow the procedure below.

- See also “Changing the general settings (PSM)” on page 24.

- 1 Press and hold SEL (select) for more than 2 seconds so that one of the PSM items appears on the display.
- 2 Press ►►| ▲ or ▼ |◄◄ to select “P(Programme)-SEARCH.”
- 3 Turn the control dial clockwise to select “ON.”
Now programme search is activated.
- 4 Press SEL (select) to finish the setting.

To cancel programme search, repeat the same procedure and select “OFF” in step 3 by turning the control dial counterclockwise.

Setting the TA volume level

You can preset the volume level for TA Standby Reception. When a traffic programme is received, the volume level automatically changes to the preset level.

- See also “Changing the general settings (PSM)” on page 24.

- 1 Press and hold SEL (select) for more than 2 seconds so that one of the PSM items appears on the display.
- 2 Press ►►| ▲ or ▼ |◄◄ to select “TA VOL” (volume).
- 3 Turn the control dial to set to the desired volume.
You can set it from “VOL 00” to “VOL 30” or “VOL 50” (depending on the amplifier gain control setting: see page 25).
- 4 Press SEL (select) to finish the setting.

Automatic clock adjustment

When shipped from the factory, the clock built in this unit is set to be readjusted automatically using the CT (Clock Time) data in the RDS signal.

If you do not want to use automatic clock adjustment, follow the procedure below.

- See also “Changing the general settings (PSM)” on page 24.

- 1 Press and hold SEL (select) for more than 2 seconds so that one of the PSM items appears on the display.
- 2 Press ►►| ▲ or ▼ |◄◄ to select “AUTO ADJ” (adjustment).
- 3 Turn the control dial counterclockwise to select “OFF.”
Now automatic clock adjustment is canceled.
- 4 Press SEL (select) to finish the setting.

To reactivate clock adjustment, repeat the same procedure and select “ON” in step 3 by turning the control dial clockwise.

Note:

You must stay tuned to the same station for more than 2 minutes after setting “AUTO ADJ” to “ON.” Otherwise, the clock time will not be adjusted. (This is because the unit takes up to 2 minutes to capture the CT data in the RDS signal.)

**PTY codes**

NEWS:	News	SOCIAL:	Programmes on social activities
AFFAIRS:	Topical programmes expanding on current news or affairs	RELIGION:	Programmes dealing with any aspect of belief or faith, or the nature of existence or ethics
INFO:	Programmes which impart advice on a wide variety of topics	PHONE IN:	Programmes where people can express their views either by phone or in a public forum
SPORT:	Sport events	TRAVEL:	Programmes about travel destinations, package tours, and travel ideas and opportunities
EDUCATE:	Educational programmes	LEISURE:	Programmes concerned with recreational activities such as gardening, cooking, fishing, etc.
DRAMA:	Radio plays	JAZZ:	Jazz music
CULTURE:	Programmes on national or regional culture	COUNTRY:	Country music
SCIENCE:	Programmes on natural science and technology	NATION M:	Current popular music from another nation or region, in that country's language
VARIED:	Other programmes like comedies or ceremonies	OLDIES:	Classic pop music
POP M:	Pop music	FOLK M:	Folk music
ROCK M:	Rock music	DOCUMENT:	Programmes dealing with factual matters, presented in an investigative style
EASY M:	Easy-listening music		
LIGHT M:	Light music		
CLASSICS:	Classical music		
OTHER M:	Other music		
WEATHER:	Weather information		
FINANCE:	Reports on commerce, trading, the Stock Market, etc.		
CHILDREN:	Entertainment programmes for children		

The same programme can be received on different frequencies.

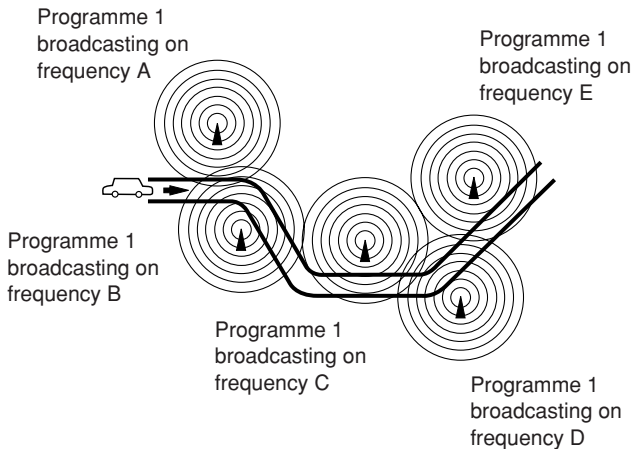

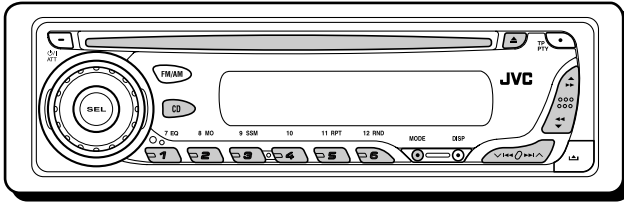

Playing a CD

Insert a CD into the loading slot.

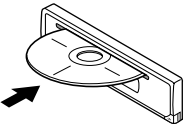

The unit turns on, draws the CD and starts playback automatically.

Note on One-Touch Operation:

When a CD is already in the loading slot, pressing CD turns on the unit and starts playback automatically.

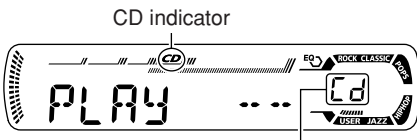

Current source indication ↓

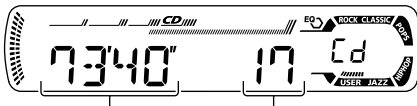

Total playing time of the inserted disc Total track number of the inserted disc ↓

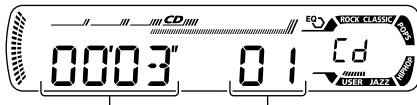

Elapsed playing time Current track number

All tracks will be played repeatedly until you stop playback.

Notes:

- When a CD is inserted upside down, "EJECT" appears on the display and the CD automatically ejects.
- If there is no CD in the loading slot, you cannot select CD as the source. "NO DISC" appears on the display.

To stop play and eject the CD

Press ▲.

CD play stops and the CD automatically ejects from the loading slot. The source changes to the tuner (you will hear the last received station).

- If you change the source, CD play also stops (without ejecting the CD).

Next time you select "CD" as the source, CD play starts from where playback has been stopped previously.

Notes:

- If the ejected CD is not removed for about 15 seconds, the CD is automatically inserted again into the loading slot to protect it from dust. (CD play will not start this time.)
- You can eject the CD even when the unit is turned off.

About mistracking:

Mistracking may result from driving on extremely rough roads. This does not damage the unit and the CD, but will be annoying.

We recommend that you stop CD play while driving on such rough roads.



Locating a track or a particular portion on a CD

To fast-forward or reverse the track

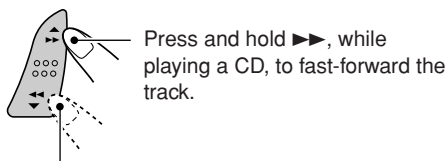

Press and hold ►►, while playing a CD, to fast-forward the track.

Press and hold ◀◀, while playing a CD, to reverse the track.

To go to the next or previous tracks

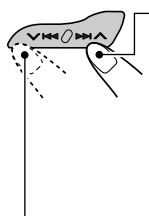

Press ►►|▲ briefly, while playing a CD, to go ahead to the beginning of the next track. Each time you press the button consecutively, the beginning of the next tracks is located and played back.

Press ▼|◀◀ briefly, while playing a CD, to go back to the beginning of the current track. Each time you press the button consecutively, the beginning of the previous tracks is located and played back.

To go to a particular track directly

Press the number button corresponding to the track number to start its playback.

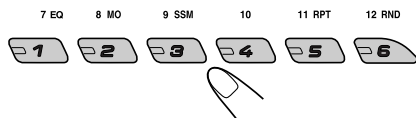

- To select a track number from 1 – 6:
Press 1 (7) – 6 (12) briefly.
- To select a track number from 7 – 12:
Press and hold 1 (7) – 6 (12) for more than one second.

Selecting CD playback modes

To play back tracks at random (Disc Random Play)

You can play back all tracks on the CD at random.

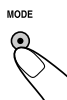

- 1 Press MODE to enter the functions mode while playing a CD.

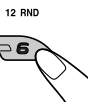

- 2 Press RND (random), while "MODE" is still flashing on the display, so that "DISC RND" appears on the display. Each time you press the button, disc random play mode turns on and off alternately.

RND  (random disc) indicator





When disc random play is turned on, the RND  indicator lights up on the display. A track randomly selected starts playing.



To play back tracks repeatedly (Track Repeat Play)

You can play back the current track repeatedly.

- 1 Press MODE to enter the functions mode while playing a CD. 
- 2 Press RPT (repeat), while "MODE" is still flashing on the display, so that "TRK RPT" appears on the display. Each time you press the button, track repeat play mode turns on and off alternately. 

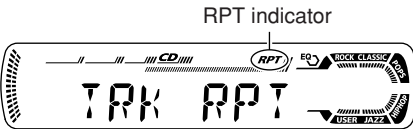

When track repeat play is turned on, the RPT indicator lights up on the display. The current track starts playing repeatedly.

Prohibiting CD ejection

You can prohibit CD ejection and can lock a CD in the loading slot.

While pressing CD, press and hold \blacktriangle for more than 2 seconds.

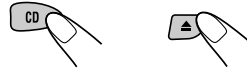

"EJECT" flashes on the display for about 5 seconds, and the CD is locked and cannot be ejected.



To cancel the prohibition and unlock the CD

While pressing CD, press and hold \blacktriangle again for more than 2 seconds.

"EJECT" appears on the display, and the CD ejects from the loading slot.

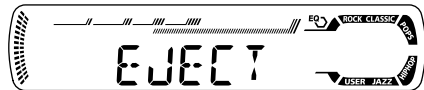

SOUND ADJUSTMENTS

Selecting preset sound modes (C-EQ: custom equalizer)

You can select a preset sound mode (C-EQ: custom equalizer) suitable to the music genre.

- There is a time limit in doing the following procedure. If the setting is canceled before you finish, start from step 1 again.

1 Press MODE to enter the functions mode.

MODE



2 Select the sound mode you want.

7 EQ

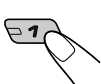

Each time you press the button, the sound modes change as follows:



USER	ROCK	CLASSIC
JAZZ	HIP HOP	POPS

Indication pattern changes for each sound mode except for "USER."

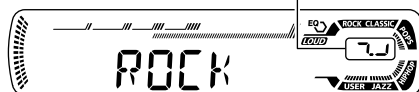

Ex.: When you select "ROCK"

Indication	For:	Preset values		
		BAS	TRE	LOUD
USER	(Flat sound)	00	00	OFF
ROCK	Rock or disco music	+03	+01	ON
CLASSIC	Classical music	+01	-02	OFF
POPS	Light music	+04	+01	OFF
HIP HOP	Funk or rap music	+02	00	ON
JAZZ	Jazz music	+02	+03	OFF

Note:

You can adjust each sound mode to your preference. Once you make an adjustment, it is automatically stored for the currently selected sound mode. See "Adjusting the sound" on page 23.

Adjusting the sound

You can adjust the sound characteristics to your preference.

1 Select the item you want to adjust.



Each time you press the button, the adjustable items change as follows:

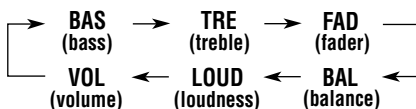

Indication	To do:	Range
BAS* ¹	Adjust the bass.	-06 (min.) +06 (max.)
TRE* ¹	Adjust the treble.	-06 (min.) +06 (max.)
FAD* ²	Adjust the front and rear speaker balance.	R06 (Rear only) F06 (Front only)
BAL	Adjust the left and right speaker balance.	L06 (Left only) R06 (Right only)
LOUD* ¹	Boost low and high frequencies to produce a well-balanced sound at low volume level.	LOUD ON LOUD OFF
VOL* ³	Adjust the volume.	00 (min.) 30 or 50 (max.)* ⁴

*¹ When you adjust the bass, treble, or loudness, the adjustment you have made is stored for the currently selected sound mode (C-EQ) including "USER."

*² If you are using a two-speaker system, set the fader level to "00."

*³ Normally the control dial works as the volume control. So you do not have to select "VOL" to adjust the volume level.

*⁴ Depending on the amplifier gain control setting. (See page 25 for details.)

2 Adjust the setting.

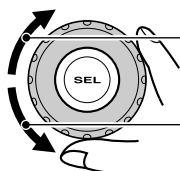

To increase the level or turn on the loudness

To decrease the level or turn off the loudness

Indication pattern changes as you adjust the bass or treble.

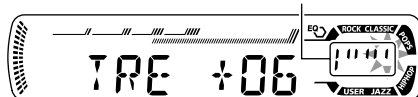

Ex. 1: When you adjust "TRE" (treble)

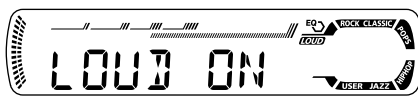

Ex. 2: When you turn on the loudness

3 Repeat steps 1 and 2 to adjust the other items.

To reset each sound mode to the factory settings, repeat the same procedure and reassign the preset values listed in the table on page 22.



OTHER MAIN FUNCTIONS

Changing the general settings (PSM)

You can change the items listed in the table below and page 25 by using the PSM (Preferred Setting Mode) control.

Basic Procedure

1 Press and hold SEL (select) for more than 2 seconds so that one of the PSM items appears on the display. (See below and page 25.)



2 Select the PSM item you want to adjust.

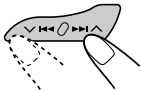

3 Adjust the PSM item selected.

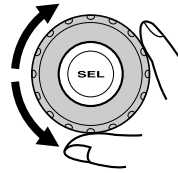

4 Repeat steps 2 and 3 to adjust the other PSM items if necessary.

5 Finish the setting.



Preferred Setting Mode (PSM) items

• For detailed operations of each PSM items, refer to the pages listed in the table.

Indications		Selectable values/items		Factory-preset settings	See page
DEMO	Display demonstration	DEMO OFF	DEMO ON	DEMO ON	6
CLOCK H	Hour adjustment	0 — 23 (1 — 12)		0 (0:00)	7
CLOCK M	Minute adjustment	00 — 59		00 (0:00)	
24H/12H	24/12-hour time display	12H	24H	24H	
AUTO ADJ	Automatic clock setting	OFF	ON	ON	17
AF-REG	Alternative frequency/ Regionalization reception	AF ↕	↔ AF REG OFF ↔	AF	12, 13



Indications		Selectable values/items		Factory-preset settings	See page
PTY STBY	PTY standby	OFF → 29 programme types (see page 18) ↑		OFF	14
TA VOL	Traffic announcement volume	VOL 00 — VOL 30 or 50*		VOL 20	17
P-SEARCH	Programme search	OFF	ON	OFF	17
DIMMER	Dimmer mode	OFF	ON	OFF	25
TEL	Telephone muting	OFF ↔ MUTING 1 ↙ MUTING 2 ↘		OFF	25
AMP GAIN	Amplifier gain control	LOW PWR	HIGH PWR	HIGH PWR	25

* Depending on the amplifier gain control setting. (See below for details.)

To select the dimmer mode—DIMMER

You can dim the display at night (according to your preference).

When shipped from the factory, dimmer is deactivated.

- OFF: Cancels the dimmer.
- ON: Activates the dimmer.

To select the telephone muting—TEL

This mode is used when a cellular phone system is connected. Depending on the phone system used, select either “MUTING 1” or “MUTING 2” whichever mutes the sounds from this unit.

When shipped from the factory, this mode is deactivated.

- MUTING 1: Select if this setting can mute the sounds.
- MUTING 2: Select if this setting can mute the sounds.
- OFF: Cancels the telephone muting.

To select the amplifier gain control—AMP GAIN

You can change the maximum volume level of this unit. When the maximum power of the speakers is less than 50 W, select “LOW PWR” to prevent them from being damaged.

When shipped from the factory, “HIGH PWR” is selected.

- LOW PWR: You can adjust the volume level from “VOL 00” to “VOL 30.”

Note:

If you change the setting from “HIGH PWR” to “LOW PWR” while listening at a volume level more than 30, the unit automatically changes the volume level to “VOL 30.”

- HIGH PWR: You can adjust the volume level from “VOL 00” to “VOL 50.”



Detaching the control panel

You can detach the control panel when leaving the car.

When detaching or attaching the control panel, be careful not to damage the connectors on the back of the control panel and on the panel holder.

Detaching the control panel

Before detaching the control panel, be sure to turn off the power.

- 1** Unlock the control panel.

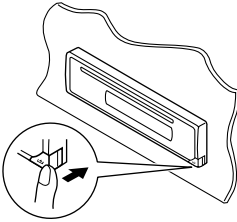

- 2** Lift and pull the control panel out of the unit.

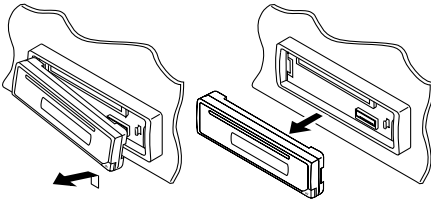

- 3** Put the detached control panel into the provided case.

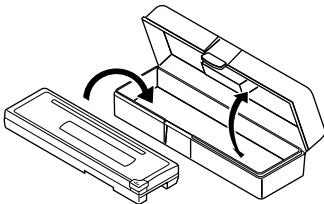

Attaching the control panel

- 1** Insert the left side of the control panel into the groove on the panel holder.

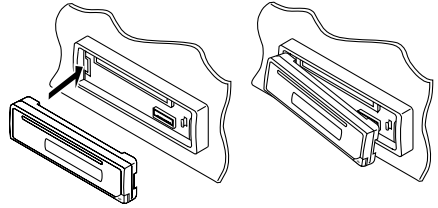

- 2** Press the right side of the control panel to fix it to the panel holder.

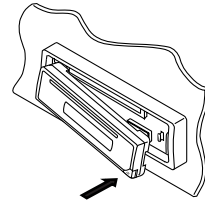

Note on cleaning the connectors:

If you frequently detach the control panel, the connectors will deteriorate.

To minimize this possibility, periodically wipe the connectors with a cotton swab or cloth moistened with alcohol, being careful not to damage the connectors.

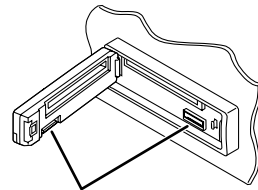

Connectors

TROUBLESHOOTING

What appears to be trouble is not always serious. Check the following points before calling a service center.

	Symptoms	Causes	Remedies
General	<ul style="list-style-type: none"> Sound cannot be heard from the speakers. 	The volume level is set to the minimum level.	Adjust it to the optimum level.
		Connections are incorrect.	Check the cords and connections.
	<ul style="list-style-type: none"> This unit does not work at all. 	The built-in microcomputer may have functioned incorrectly due to noise, etc.	While holding SEL (select), press ⏻/ATT (standby/on attenuator) for more than 2 seconds to reset the unit. (The clock setting and preset stations stored in memory are erased.) (See page 2.)
FM/AM	<ul style="list-style-type: none"> SSM (Strong-station Sequential Memory) automatic preset does not work. 	Signals are too weak.	Store stations manually.
	<ul style="list-style-type: none"> Static noise while listening to the radio. 	The aerial is not connected firmly.	Connect the aerial firmly.
CD Playback	<ul style="list-style-type: none"> CD automatically ejects. 	CD is inserted upside down.	Insert the CD correctly.
	<ul style="list-style-type: none"> CD-R/CD-RW cannot be played back. Tracks on the CD-R/CD-RW cannot be skipped. 	CD-R/CD-RW is not finalized.	<ul style="list-style-type: none"> Insert a finalized CD-R/CD-RW. Finalize the CD-R/CD-RW with the component which you used for recording.
		<ul style="list-style-type: none"> CD can be neither played back nor ejected. 	CD is locked.
	The CD player may have functioned incorrectly.		While holding ⏻/ATT (standby/on attenuator), press ⏏ (eject) for more than 2 seconds. Be careful not to drop the CD when it is ejected.
	<ul style="list-style-type: none"> CD sound is sometimes interrupted. 	You are driving on rough roads.	Stop playback while driving on rough roads.
		CD is scratched.	Change the CD.
		Connections are incorrect.	Check the cords and connections.
	<ul style="list-style-type: none"> "NO DISC" appears on the display. 	No CD in the loading slot.	Insert a CD into the loading slot.
CD is inserted incorrectly.		Insert the CD correctly.	



MAINTENANCE

Handling discs

This unit has been designed to reproduce CDs, CD-Rs (Recordable), and CD-RWs (Rewritable).

• **This unit is not compatible with MP3 discs.**

How to handle discs

When removing a disc from its case, press down the center holder of the case and lift the disc out, holding it by the edges.

- Always hold the disc by the edges. Do not touch its recording surface.

Center holder



When storing a disc into its case, gently insert the disc around the center holder (with the printed surface facing up).

- Make sure to store discs into the cases after use.

To keep discs clean

A dirty disc may not be played correctly. If a disc does become dirty, wipe it with a soft cloth in a straight line from center to edge.



To play new discs

New discs may have some rough spots around the inner and outer edges. If such a disc is used, this unit may reject the disc.



To remove these rough spots, rub the edges with a pencil or ball-point pen, etc.

Moisture condensation

Moisture may condense on the lens inside the CD player in the following cases:

- After starting the heater in the car.
- If it becomes very humid inside the car.

Should this occur, the CD player may malfunction. In this case, eject the disc and leave the unit turned on for a few hours until the moisture evaporates.

When playing a CD-R or CD-RW

Before playing back CD-Rs or CD-RWs, read their instructions or cautions carefully.

- Use only "finalized" CD-Rs or CD-RWs.
- Some CD-Rs or CD-RWs may not be played back on this unit because of their disc characteristics, and for the following reasons:
 - Discs are dirty or scratched.
 - Moisture condensation on the lens inside the unit.
 - The pickup lens inside the unit is dirty.
- CD-RWs may require a longer readout time since the reflectance of CD-RWs is lower than that of regular CDs.
- CD-Rs or CD-RWs are susceptible to high temperatures or high humidity, so do not leave them inside your car.
- Do not use following CD-Rs or CD-RWs:
 - Discs with stickers, labels, or protective seal stuck to the surface.
 - Discs on which labels can be directly printed by an ink jet printer.

Using these discs under high temperatures or high humidity may cause malfunctions or damage to discs. For example,

- Stickers or labels may shrink and warp a disc.
- Stickers or labels may be peeled off so discs cannot be ejected.
- Print on discs may get sticky.

Read instructions or cautions about labels and printable discs carefully.

CAUTIONS:

- Do not insert 8 cm discs (single CDs) into the loading slot. (Such discs cannot be ejected.)
- Do not insert any disc of unusual shape—like a heart or flower; otherwise, it will cause a malfunction.
- Do not expose discs to direct sunlight or any heat source or place them in a place subject to high temperature and humidity. Do not leave them in a car.
- Do not use any solvent (for example, conventional record cleaner, spray, thinner, benzene, etc.) to clean discs.

Warped disc



Sticker



Sticker residue

Disc



Stick-on label

AUDIO AMPLIFIER SECTION

Maximum Power Output:

Front: 50 W per channel

Rear: 50 W per channel

Continuous Power Output (RMS):

Front: 19 W per channel into 4 Ω , 40 Hz to 20 000 Hz at no more than 0.8% total harmonic distortion.

Rear: 19 W per channel into 4 Ω , 40 Hz to 20 000 Hz at no more than 0.8% total harmonic distortion.

Load Impedance: 4 Ω (4 Ω to 8 Ω allowance)

Tone Control Range:

Bass: ± 10 dB at 100 Hz

Treble: ± 10 dB at 10 kHz

Frequency Response: 40 Hz to 20 000 Hz

Signal-to-Noise Ratio: 70 dB

Line-Out Level/Impedance:

2.0 V/20 k Ω load (full scale)

Output Impedance: 1 k Ω

TUNER SECTION

Frequency Range:

FM: 87.5 MHz to 108.0 MHz

AM: (MW) 522 kHz to 1 620 kHz

(LW) 144 kHz to 279 kHz

[FM Tuner]

Usable Sensitivity:

11.3 dBf (1.0 μ V/75 Ω)

50 dB Quieting Sensitivity:

16.3 dBf (1.8 μ V/75 Ω)

Alternate Channel Selectivity (400 kHz):

65 dB

Frequency Response: 40 Hz to 15 000 Hz

Stereo Separation: 30 dB

Capture Ratio: 1.5 dB

[MW Tuner]

Sensitivity: 20 μ V

Selectivity: 35 dB

[LW Tuner]

Sensitivity: 50 μ V

CD PLAYER SECTION

Type: Compact disc player

Signal Detection System: Non-contact optical pickup (semiconductor laser)

Number of channels: 2 channels (stereo)

Frequency Response: 5 Hz to 20 000 Hz

Dynamic Range: 96 dB

Signal-to-Noise Ratio: 98 dB

Wow and Flutter: Less than measurable limit

GENERAL

Power Requirement:

Operating Voltage:

DC 14.4 V (11 V to 16 V allowance)

Grounding System: Negative ground

Allowable Operating Temperature:

0°C to +40°C

Dimensions (W \times H \times D):

Installation Size (approx.):

182 mm \times 52 mm \times 150 mm

Panel Size (approx.):

188 mm \times 58 mm \times 11 mm

Mass (approx.):

1.3 kg (excluding accessories)

Design and specifications are subject to change without notice.

**Having TROUBLE with operation?
Please reset your unit**

Refer to page of How to reset your unit

**Haben Sie PROBLEME mit dem Betrieb?
Bitte setzen Sie Ihr Gerät zurück**

Siehe Seite Zurücksetzen des Geräts

**Vous avez des PROBLÈMES de fonctionnement?
Réinitialisez votre appareil**

Référez-vous à la page intitulée Comment réinitialiser votre appareil

**Hebt u PROBLEMEN met de bediening?
Stel het apparaat terug**

Zie de pagina met de paragraaf Het apparaat terugstellen

JVC

VICTOR COMPANY OF JAPAN, LIMITED



JVC KD-G202/KD-G201

Installation/Connection Manual Einbau/Anschlußanleitung Manuel d'installation/raccordement Handleiding voor installatie/aansluiting

GET0184-005A
[E/EX]

1103KKSMDTJEIN
EN, GE, FR, NL

ENGLISH

This unit is designed to operate on **12 V DC, NEGATIVE ground electrical systems**. If your vehicle does not have this system, a voltage inverter is required, which can be purchased at JVC IN-CAR ENTERTAINMENT dealers.

DEUTSCH

Dieses Gerät ist für einen Betrieb in **elektrischen Anlagen mit 12 V Gleichstrom und (-) Erdung ausgelegt**. Verfügt Ihr Fahrzeug nicht über diese Anlage, ist ein Spannungsinverter erforderlich, der bei JVC Autoradiohändler erworben werden kann.

FRANÇAIS

Cet appareil est conçu pour fonctionner sur des sources de courant continu de **12 V à masse NEGATIVE**. Si votre véhicule n'offre pas ce type d'alimentation, il vous faut un convertisseur de tension, que vous pouvez acheter chez un revendeur d'autoradios JVC.

NEDERLANDS

Dit apparaat mag worden gebruikt bij elektrische systemen die werken op **12 V gelijkstroom met negatieve aarding**. Als uw auto niet is uitgerust met een dergelijk systeem, is een spanningsomzetter vereist. Dit instrument kan worden aangeschaft bij JVC car audio dealers.

Parts list for installation and connection

The following parts are provided for this unit. After checking them, please set them correctly.

Teilleiste für den Einbau und Anschluß

Die folgenden Teile werden zusammen mit diesem Gerät geliefert. Nach ihrer Überprüfung, die Teile richtig einsetzen.

Liste des pièces pour l'installation et raccordement

Les pièces suivantes sont fournies avec cet appareil. Après vérification, veuillez les placer correctement.

Lijst van onderdelen die u bij installatie en aansluiting nodig hebt

De volgende onderdelen worden bij het apparaat geleverd. Installeer ze op de juiste wijze, nadat u ze hebt gecontroleerd.

A / B
Hard case/Control panel
Etui/Schalttafel
Etui de transport/Panneau de commande
Behuizing/Bedieningspaneel

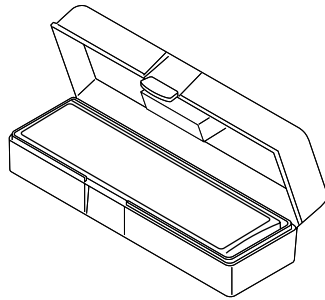

C
Sleeve
Halterung
Manchon
Huis

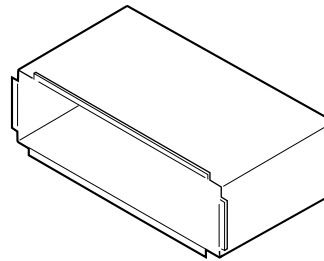

D
Trim plate
Frontrahmen
Plaque d'assemblage
Sierplaat

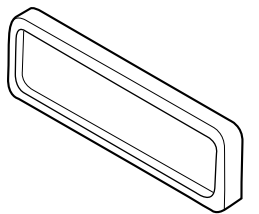

E
Power cord
Stromkabel
Cordon d'alimentation
Stroomkabel

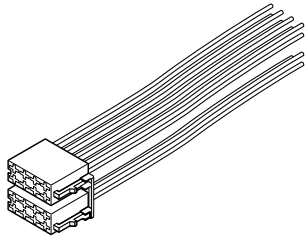

F
Washer (ø5)
Unterlegscheibe (ø5)
Rondelle (ø5)
Sluistring (ø5)



G
Lock nut (M5)
Sicherungsmutter (M5)
Ecrou d'arrêt (M5)
Contra-moer (M5)



H
Mounting bolt (M5 x 20 mm)
Befestigungsschraube (M5 x 20 mm)
Boulon de montage (M5 x 20 mm)
Bevestigingsbout (M5 x 20 mm)

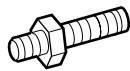

I
Rubber cushion
Gummipuffer
Amortisseur en caoutchouc
Rubberdop



J
Handles
Griffe
Poignées
Hendels

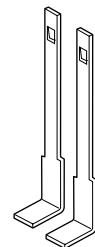

INSTALLATION (IN-DASH MOUNTING)

The following illustration shows a typical installation. If you have any questions or require information regarding installation kits, consult your JVC IN-CAR ENTERTAINMENT dealer or a company supplying kits.

- If you are not sure how to install this unit correctly, have it installed by a qualified technician.

EINBAU (IM ARMATURENBRETT)

Die folgende Abbildung zeigt einen typischen Einbau. Bei irgendwelchen Fragen oder wenn Sie Informationen hinsichtlich des Einbausatzes brauchen, wenden Sie sich an ihren JVC Autoradiohändler oder ein Unternehmen das diese Einbausätze vertreibt.

- Sind Sie sich über den richtigen Einbau des Geräts nicht sicher, lassen Sie es von einem qualifizierten Techniker einbauen.

INSTALLATION (MONTAGE DANS LE TABLEAU DE BORD)

L'illustration suivante est un exemple d'installation typique. Si vous avez des questions ou avez besoin d'information sur des kits d'installation, consulter votre revendeur d'autoradios JVC ou une compagnie d'approvisionnement.

- Si l'on n'est pas sûr de pouvoir installer correctement cet appareil, le faire installer par un technicien qualifié.

INSTALLATIE (INBOUW IN HET DASHBOARD)

Op de volgende afbeelding kunt u zien hoe de installatie, normaal gesproken, in zijn werk gaat. Neem bij vragen of voor meer bijzonderheden over inbouwpakketten contact op met uw JVC car audio dealer of een dealer of een bedrijf dat inbouwpakketten levert.

- Als u niet zeker weet hoe u dit apparaat moet installeren, kunt u dit beter door een daartoe gekwalificeerde technicus laten doen.

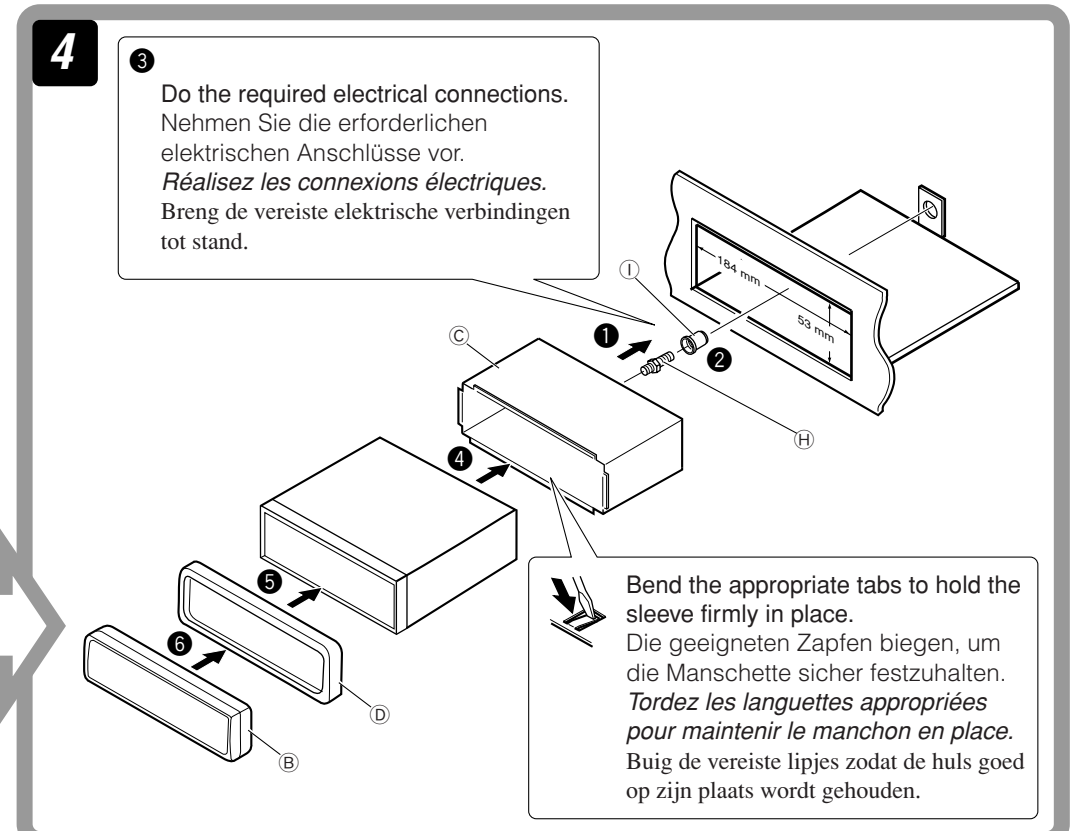
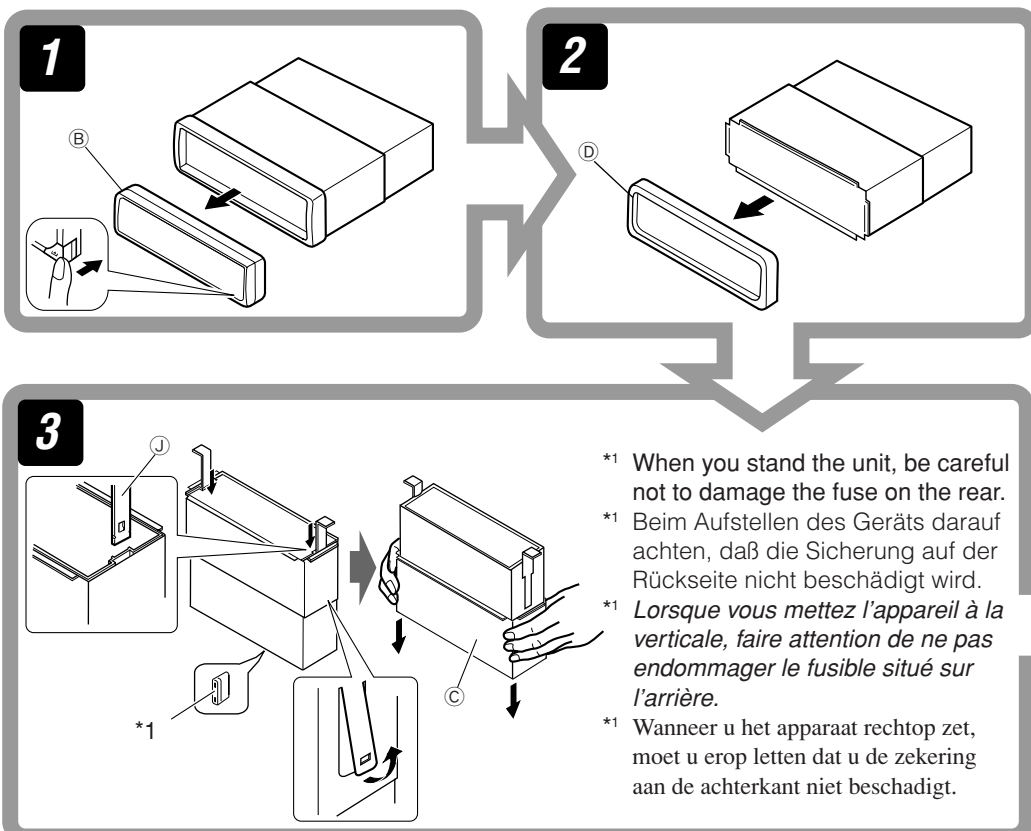

Removing the unit

Before removing the unit, release the rear section.

Ausbau des Geräts

Vor dem Ausbau des Geräts den hinteren Teil freigegeben.

Retrait de l'appareil

Avant de retirer l'appareil, libérer la section arrière.

Verwijderen van het apparaat

Voordat u het apparaat verwijdert, moet u het achtergedeelte losmaken.

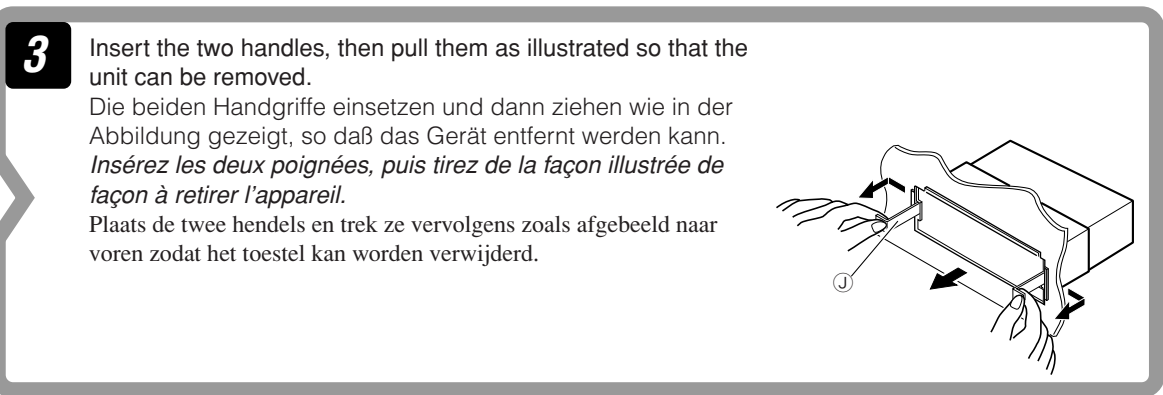
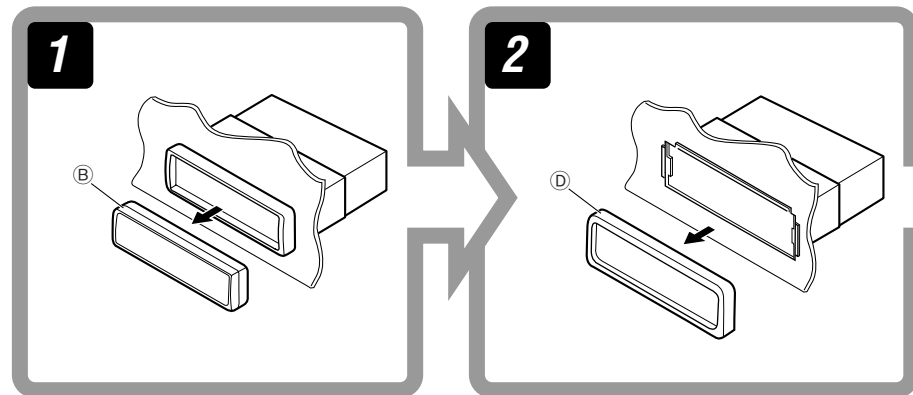

When using the optional stay / Beim Verwenden der Anker-Option / Lors de l'utilisation du hauban en option / Wanneer u de steun gebruikt (facultatief)

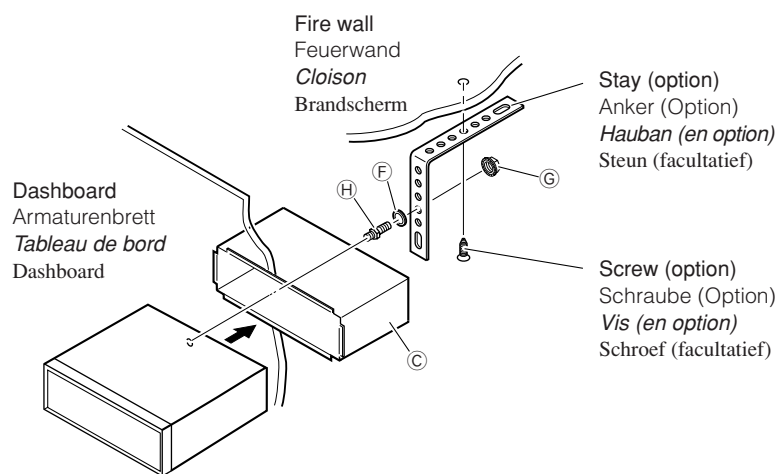

Install the unit at an angle of less than 30°.
Stellen Sie das Gerät mit einem Winkel von weniger als 30° auf.
Installez l'appareil avec un angle de moins de 30°.
Installeer het toestel met een hoek kleiner dan 30°.

When installing the unit without using the sleeve / Beim Einbau des Geräts ohne Halterung / Lors de l'installation de l'appareil sans utiliser de manchon / Wanneer u het apparaat zonder huis installeert

In a Toyota for example, first remove the car radio and install the unit in its place.
Zum Beispiel in einem Toyota zuerst das Autoradio ausbauen und dann das Gerät an seinem Platz einbauen.
Par exemple dans une Toyota, retirer d'abord l'autoradio et installer l'appareil à la place.
Voorbeeld: Bij een Toyota moet u eerst de autoradio verwijderen en daarna het apparaat installeren.

Flat type screws (M5 x 8 mm)*
Senkkopfschrauben (M5 x 8 mm)*
Vis à tête plate (M5 x 8 mm)*
Platkopschroeven (M5 x 8 mm)*

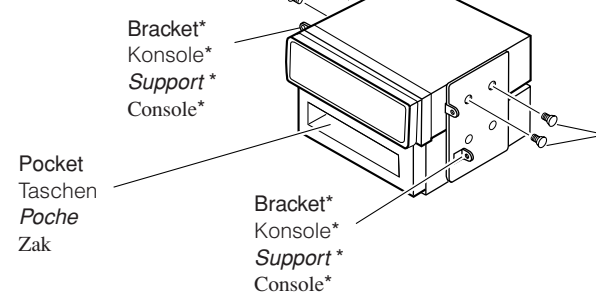

* Not included with this unit.
* Nicht Teil dieses Geräts.
* Non fourni avec cet appareil.
* Niet meegeleverd.

Note : When installing the unit on the mounting bracket, make sure to use the 8 mm-long screws. If longer screws are used, they could damage the unit.

Hinweis : Beim Anbringen des Gerät an der Konsole sicherstellen, daß 8 mm lange Schrauben verwendet werden. Werden längere Schrauben verwendet, können sie das Gerät beschädigen.

Remarque : Lors de l'installation de l'appareil sur le support de montage, s'assurer d'utiliser des vis d'une longueur de 8 mm. Si des vis plus longues sont utilisées, elles peuvent endommager l'appareil.

Opmerking : Wanneer u het apparaat aan de bevestigingsklem vastmaakt, moet u de 8 mm lange schroeven gebruiken. Als u langere schroeven gebruikt, kan het apparaat worden beschadigd.

ELECTRICAL CONNECTIONS

To prevent short circuits, we recommend that you disconnect the battery's negative terminal and make all electrical connections before installing the unit.

- Be sure to ground this unit to the car's chassis again after installation.

Notes:

- Replace the fuse with one of the specified rating. If the fuse blows frequently, consult your JVC IN-CAR ENTERTAINMENT dealer.
- It is recommended to connect to the speakers with maximum power of more than 50 W (both at the rear and at the front, with an impedance of 4 Ω to 8 Ω). If the maximum power is less than 50 W, change "AMP GAIN" setting to prevent the speakers from being damaged (see page 25 of the INSTRUCTIONS).
- To prevent short-circuit, cover the terminals of the UNUSED leads with insulating tape.
- The heat sink becomes very hot after use. Be careful not to touch it when removing this unit.

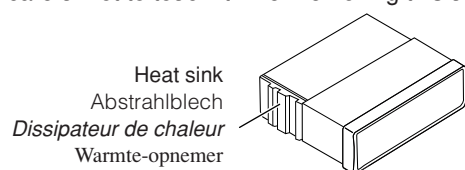

ELEKTRISCHE ANSCHLÜSSE

Zur Vermeidung von Kurzschlüssen empfehlen wir, daß Sie den negativen Batterieanschluß abtrennen und alle elektrischen Anschlüsse herstellen, bevor das Gerät eingebaut wird.

- Sicherstellen, daß das Gerät nach dem Einbau a Chassis des Fahrzeugs geerdet wird.

Hinweise:

- Die Sicherung mit einer der entsprechenden Nennleistung ersetzen. Brennt die Sicherung häufig durch, wenden Sie sich an ihren JVC Autoradiohändler.
- Es wird empfohlen, Lautsprecher mit einer Maximalleistung von mehr als 50 W anzuschließen (sowohl hinten als auch vorne, mit einer Impedanz von 4 Ω bis 8 Ω). Wenn die Maximalleistung weniger als 50 W beträgt, stellen Sie „AMP GAIN“ anders ein, um Schäden an den Lautsprechern zu vermeiden (siehe Seite 25 der BEDIENUNGSANLEITUNG).
- Zur Vermeidung eines Kurzschlusses die Anschlußklemmen der NICHT VERWENDETEN Leitungen mit Isolierklebeband umwickeln.
- Das Abstrahlblech wird nach dem Gebrauch sehr heiß. Beim Ausbau des Geräts darauf achten, das Abstrahlblech nicht zu berühren.

RACCORDEMENTS ELECTRIQUES ELEKTRISCHE VERBINDINGEN

Pour éviter tout court-circuit, nous vous recommandons de débrancher la borne négative de la batterie et d'effectuer tous les raccordements électriques avant d'installer l'appareil.

- Assurez-vous de raccorder de nouveau la mise à la masse de cet appareil au châssis de la voiture après l'installation.

Remarques:

- Remplacer le fusible par un de la valeur précisée. Si le fusible saute souvent, consulter votre revendeur d'autoradios JVC.
- Il est recommandé de connecter des enceintes avec une puissance de plus de 50 W (les enceintes arrière et les enceintes avant, avec une impédance comprise entre 4 Ω et 8 Ω). Si la puissance maximum est inférieure à 50 W, changez "AMP GAIN" pour éviter d'endommager vos enceintes (voir page 25 du MANUEL D'INSTRUCTIONS).
- Pour éviter les court-circuits, couvrir les bornes des fils qui ne sont PAS UTILISÉS avec de la bande isolante.
- Le dissipateur de chaleur devient très chaud après usage. Faire attention de ne pas le toucher en retirant cet appareil.

Om kortsluiting te voorkomen adviseren wij u om de minpool van de accu los te maken en alle elektrische verbindingen tot stand te brengen voordat u het apparaat in de auto installeert.

- Aard dit toestel beslist weer op het chassis van de auto na het installeren.

Opmerkingen:

- Vervang de zekering door een exemplaar met het aangegeven vermogen. Als de zekering vaak doorslaat, moet u uw JVC car audio dealer raadplegen.
- Sluit bij voorkeur luidsprekers met een hoger maximaal vermogen dan 50 W (zowel achter als voor, met een impedantie van 4 Ω t/m 8 Ω) aan. Indien het maximale vermogen lager dan 50 W is, moet u "AMP GAIN" in de andere stand stellen zodat de luidsprekers niet kunnen worden beschadigd (zie bladzijde 25 van de GEBRUIKSAANWIJZING).
- Om kortsluiting te voorkomen, moet u de aansluitklemmen van ONGEBRUIKTE gekleurde draden met isolatieband bedekken.
- De warmte-opnemer kan na gebruik erg heet worden. Raak de warmte-opnemer niet aan wanneer u dit apparaat van zijn plaats haalt.

TROUBLESHOOTING

- **The fuse blows.**
* Are the red and black leads connected correctly?
- **Power cannot be turned on.**
* Is the yellow lead connected?
- **No sound from the speakers.**
* Is the speaker output lead short-circuited?
- **Sound is distorted.**
* Is the speaker output lead grounded?
* Are the "-" terminals of L and R speakers grounded in common?
- **Noise interfere with sounds.**
* Is the rear ground terminal connected to the car's chassis using shorter and thicker cords?
- **Unit becomes hot.**
* Is the speaker output lead grounded?
* Are the "-" terminals of L and R speakers grounded in common?

FEHLERSUCHE

- **Die Sicherung brennt durch.**
* Sind die roten und schwarzen Leitungen richtig angeschlossen?
- **Stromversorgung kann nicht eingeschaltet werden.**
* Ist die gelbe Leitung angeschlossen?
- **Kein Ton aus den Lautsprechern.**
* Ist die LautsprecherAusgangsleitung kurzgeschlossen?
- **Ton verzerrt.**
* Ist die LautsprecherAusgangsleitung geerdet?
* Sind die (-) Anschlußklemmen der linken und rechten Lautsprecher zusammen geerdet?
- **Störgeräusche im Klang.**
* Ist die hintere Erdungsklemme mit kürzeren und dickeren Kabeln an das Fahrzeugchassis angeschlossen?
- **Gerät wird heiß.**
* Ist die LautsprecherAusgangsleitung geerdet?
* Sind die (-) Anschlußklemmen der linken und rechten Lautsprecher zusammen geerdet?

EN CAS DE DIFFICULTES

- **Le fusible saute.**
* Les fils rouge et noir sont-ils raccordés correctement?
- **L'appareil ne peut pas être mise sous tension.**
* Le fil jaune est-elle raccordée?
- **Pas de son des enceintes.**
* Le fil de sortie d'enceinte est-il court-circuité?
- **Le son est déformé.**
* Le fil de sortie d'enceinte est-il à la masse?
* Les bornes "-" des enceintes gauche et droit sont-elles mises ensemble à la masse?
- **Interférence avec les sons.**
* La prise arrière de mise à la terre est-elle connectée au châssis de la voiture avec un cordon court et épais?
- **L'appareil devient chaud.**
* Le fil de sortie d'enceinte est-il à la masse?
* Les bornes "-" des enceintes gauche et droit sont-elles mises ensemble à la masse?

PROBLEMEN OPLOSSEN

- **De zekering slaat door.**
* Zijn de rode en de zwarte draden op de juiste manier aangesloten?
- **De stroom kan niet worden ingeschakeld.**
* Is de gele draad aangesloten?
- **Er komt geen geluid uit de speakers.**
* Is de uitgaande speakerdraad kortgesloten?
- **Het geluid wordt vervormd.**
* Is de uitgaande speakerdraad geaard?
* Zijn de "-" polen van de linker- en de rechterspeakers gemeenschappelijk geaard?
- **Geluid wordt door ruis gestoord.**
* Is de aarde-aansluiting achter met gebruik van kortere en dikkere snoeren met het chassis van de auto verbonden?
- **Het apparaat raakt verhit.**
* Is de uitgaande speakerdraad geaard?
* Zijn de "-" polen van de linker- en de rechterspeakers gemeenschappelijk geaard?

A Typical Connections / Typische Anschlüsse / Raccordements typiques / Normale verbindingen

Before connecting: Check the wiring in the vehicle carefully. Incorrect connection may cause serious damage to this unit.
The leads of the power cord and those of the connector from the car body may be different in color.

- 1 Connect the colored leads of the power cord in the order specified in the illustration below.
 - 2 Connect the aerial cord.
 - 3 Finally connect the wiring harness to the unit.
- Note:** If your vehicle does not have any accessory terminal, move the fuse from the fuse position 1 (initial position) to fuse position 2, and connect the red lead (A7) to the positive (+) battery terminal.
- The yellow lead (A4) is not used in this case.

Vor dem Anschließen: Die Verdrahtung im Fahrzeug sorgfältig überprüfen. Falsche Anschlüsse können ernsthafte Schäden am Gerät hervorrufen.
Die Leiter des Stromkabels und die Leiter des Anschlusses im Fahrzeug können sich farblich unterscheiden.

- 1 Die farbigen Adern des Stromkabels in der Reihenfolge anschließen, wie in der Abbildung unten gezeigt.
 - 2 Das Antennenkabel anschließen.
 - 3 Die Kabelbäume am Gerät anschließen.
- Hinweis:** Verfügt Ihr Fahrzeug nicht über eine Zubehöranschlussterminal, die Sicherung von der 1. Sicherungsposition (Erstposition) in die 2. Sicherungsposition versetzen, die rote Leitung (A7) an der (+) Batterieanschlussterminal anschließen.
- Die gelbe Leitung (A4) wird in diesem Fall nicht verwendet.

Avant de commencer la connexion: Vérifiez attentivement le câblage du véhicule. Une connexion incorrecte peut endommager sérieusement l'appareil.
Le fil du cordon d'alimentation et ceux des connecteurs du châssis de la voiture peuvent être différents en couleur.

- 1 Connectez les fils colorés du cordon d'alimentation dans l'ordre spécifié sur l'illustration ci-dessous.
 - 2 Connectez le cordon d'antenne.
 - 3 Finalement, connectez le faisceau de fils à l'appareil.
- Remarque:** Si votre véhicule ne possède pas de borne accessoire, déplacez le fusible de la position de fusible 1 (position originale) à la position de fusible 2 et connectez le fil rouge (A7) à la borne positive (+) de la batterie.
- Le fil jaune (A4) n'est pas utilisé dans ce cas.

Alvorens de verbindingen tot stand te brengen: Moet u de bedrading in de auto zorgvuldig. Het apparaat kan door verkeerde verbindingen ernstige schade oplopen.
De draden van het stroomsnoer verschillen mogelijk van kleur met de aansluitingen op het chassis van de auto.

- 1 Verbind de gekleurde draden van het stroomsnoer in de afbeelding hieronder aangegeven volgorde.
 - 2 Sluit de antenne aan.
 - 3 Verbind de draadbundel daarna met het apparaat.
- Opmerking:** Als uw voertuig niet beschikt over een aansluitklem, moet u de zekering verplaatsen van stand 1 (beginstand) naar stand 2 en moet u de rode draad (A7) met de pluspool (+) van de accu verbinden.
- In dit geval wordt de gele draad (A4) niet gebruikt.

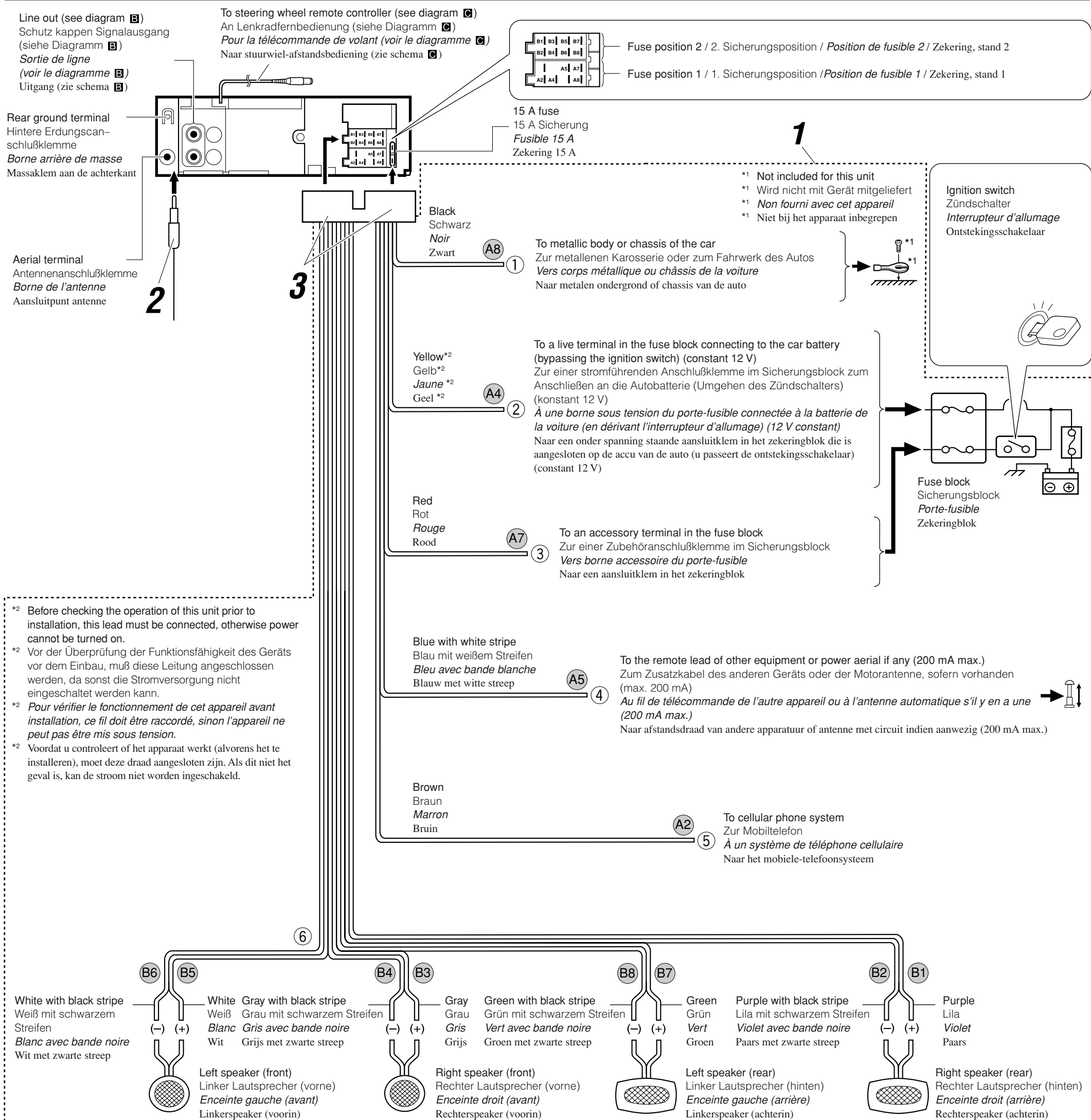

B Connections Adding Other Equipment / Anschlüsse zum Hinzufügen von anderer Ausrüstung / Raccordement pour ajouter d'autres appareils / Aansluitingen voor het toevoegen van andere apparatuur

Amplifier / Verstärker / Amplificateur / Versterker

You can connect an amplifier and other equipment to upgrade your car stereo system.

- Connect the remote lead (blue with white stripe) to the remote lead of the other equipment so that it can be controlled through this unit.
- **For amplifier only:** Disconnect the speakers from this unit, connect them to the amplifier. Leave the speaker leads of this unit unused.

Sie können einen Verstärker oder ein anderes Gerät anschließen, um Ihre Autostereoanlage zu erweitern.

- Schließen Sie das Fernbedienungskabel (blau mit weißem Streifen) an das Fernbedienungskabel des anderen Geräts an, so daß es über dieses Gerät gesteuert werden kann.
- **Nur für den Verstärker:** Die Lautsprecher von diesem Gerät abtrennen und am Verstärker anschließen. Die Lautsprecherleitungen dieses Geräts unbenutzt lassen.

Vous pouvez connecter un amplificateur ou autre appareil pour améliorer votre système autoradio.

- *Connectez le fil de commande à distance (bleu avec bande blanche) au fil de commande à distance de l'autre appareil de façon qu'il puisse être commandé via cet appareil.*
- **Pour l'amplificateur seulement:** Déconnectez les enceintes de cet appareil et connectez-les à l'amplificateur. Laissez les fils d'enceintes de cet appareil inutilisés.

Het is mogelijk om uw autostereosysteem uit te breiden met een versterker of andere apparatuur.

- Verbind de externe kabel (blauw met witte streep) met de externe kabel van het andere apparaat zodat deze op afstand vanaf deze apparaat kan worden bediend.
- **Alleen voor een versterker:** Koppel de speakers van dit apparaat los en verbind ze aan de versterker. Gebruik de speakerdraden van dit apparaat niet.

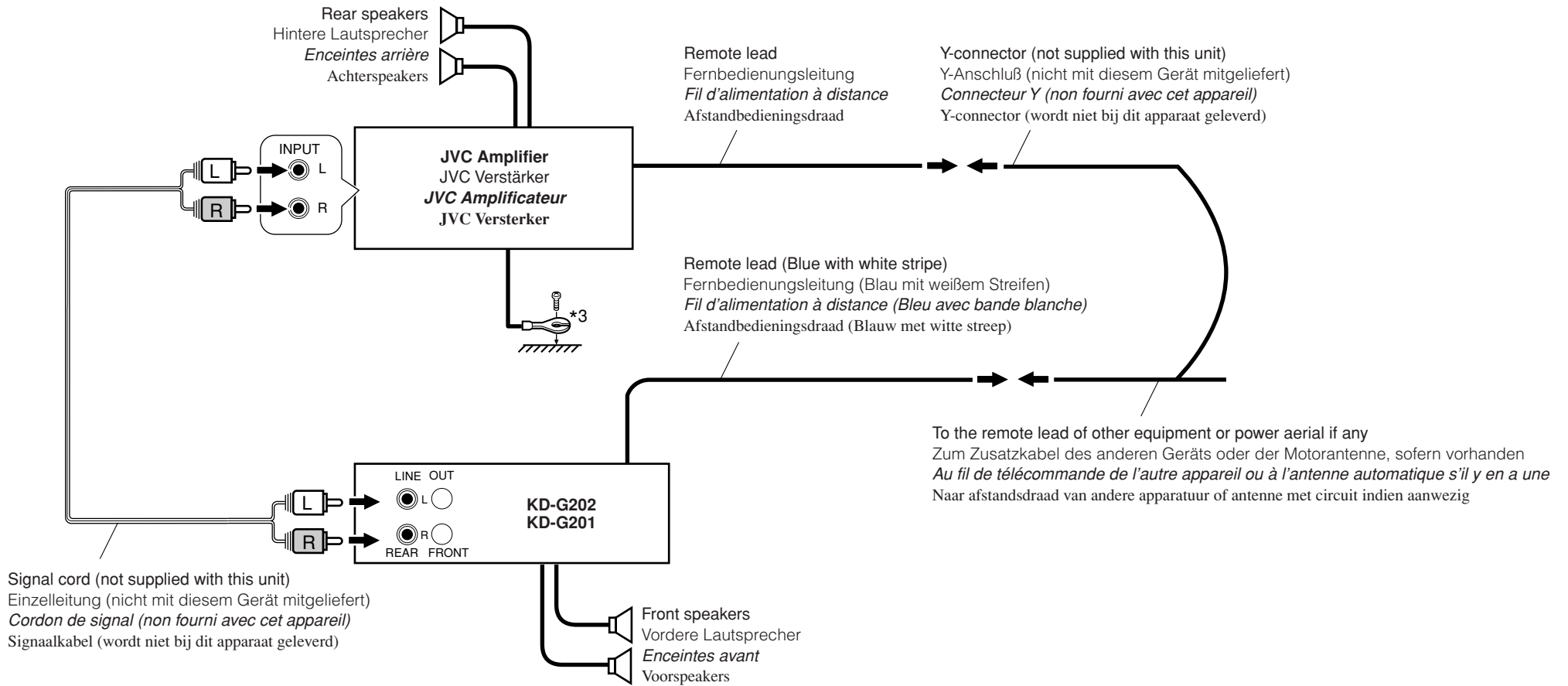

*3 Firmly attach the ground wire to the metallic body or to the chassis of the car—to the place not coated with paint (if coated with paint, remove the paint before attaching the wire). Failure to do so may cause damage to the unit.

*3 Verbinden Sie den Erdungsleiter mit der Karosserie oder dem Rahmen des Fahrzeugs. Die Kontaktstelle darf nicht lackiert sein (sollte die Kontaktstelle lackiert sein, entfernen Sie den Lack der Kontaktstelle, bevor Sie den Leiter befestigen). Wenn der Erdungsleiter nicht ordnungsgemäß angeschlossen wird, kann dieses Gerät beschädigt werden.

*3 Attachez solidement le fil de mise à la masse au châssis métallique de la voiture—à un endroit qui n'est pas recouvert de peinture (s'il est recouvert de peinture, enlevez d'abord la peinture avant d'attacher le fil). L'appareil peut être endommagé si cela n'est pas fait correctement.

*3 Bevestig de aarddraad goed met een metalen onderdeel of het chassis van de auto—bevestig op een niet-gelakt gedeelte (indien gelakt, schuur dan af alvorens de draad te bevestigen). Het toestel kan worden beschadigd indien de aarddraad niet goed is aangesloten.

C Connecting to the steering wheel remote controller / Anschluß an die Lenkradfernbedienung / Connexion de la télécommande de volant / Verbinden met de stuurwiel-afstandsbediening

If your car is equipped with the steering wheel remote controller, you can operate this receiver using the controller. To do it, a JVC's OE remote adapter (not supplied) which matches with your car is required. Consult your JVC IN-CAR ENTERTAINMENT dealer for details.

Wenn Ihr Fahrzeug mit einer Lenkradfernbedienung ausgestattet ist, können Sie damit diesen Receiver steuern. Hierfür ist ein für Ihr Fahrzeug passender Radio-Lenkrad-Fernbedienungsadaption von JVC (nicht im Lieferumfang enthalten) erforderlich. Für weitere Einzelheiten wenden Sie sich an Ihren JVC Autoradiohändler.

Si votre voiture est munie d'une télécommande de volant, vous pouvez commander cet autoradio en utilisant la télécommande. Pour le faire, un adaptateur pour télécommande au volant JVC (non fourni) correspondant à votre voiture est nécessaire. Consultez votre revendeur d'autoradio JVC pour les détails.

Indien uw auto een stuurwiel-afstandsbediening heeft, kunt u deze receiver met die afstandsbediening bedienen. Hiervoor heeft u echter een JVC adapter (niet bijgeleverd) nodig die geschikt is voor de stuurwiel-afstandsbediening van uw auto. Raadpleeg uw JVC car audio dealer voor details.

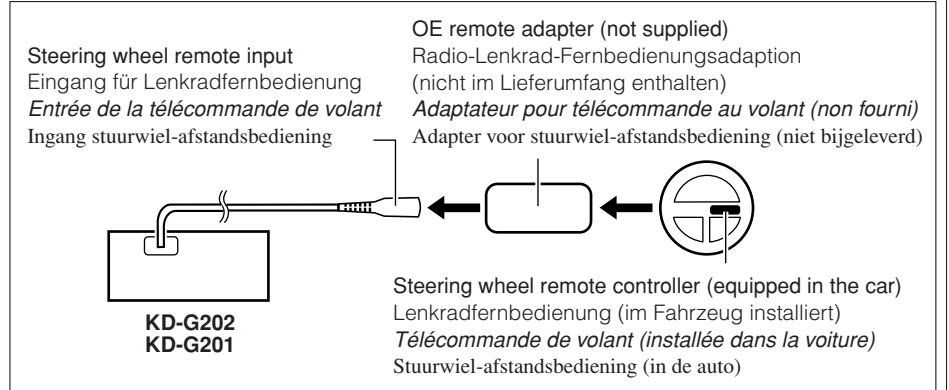

PRECAUTIONS on power supply and speaker connections:

- **DO NOT** connect the speaker leads of the power cord to the car battery; otherwise, the unit will be seriously damaged.
- **BEFORE** connecting the speaker leads of the power cord to the speakers, check the speaker wiring in your car.

VORSICHTSMASSEGELN beim Anschließen der Stromversorgung und Lautsprecher:

- Die Lautsprecherleitungen des Netzkabels **NICHT** an der Autobatterie anschließen, da sonst das Gerät schwer beschädigt wird.
- **VOR** dem Anschließen der Lautsprecherleitungen des Spannungsversorgungskabels an die Lautsprecher, die Lautsprecherverdrahtung in Ihrem Auto überprüfen.

PRECAUTIONS sur l'alimentation et la connexion des enceintes:

- **NE CONNECTEZ PAS** les fils d'enceintes du cordon d'alimentation à la batterie; sinon, l'appareil serait sérieusement endommagé.
- **AVANT** de connecter les fils d'enceintes du cordon d'alimentation aux enceintes, vérifiez le câblage des enceintes de votre voiture.

VOORZORGSMAATREGELEN bij het verbinden van de stroomkabeldraad met de speakers:

- **Verbind de speakerdraden van de stroomkabel NIET met de accu van de auto; als u dit wel doet, zal het apparaat ernstige schade oplopen.**
- **VOORDAT** u de speakerdraden van de stroomkabel met de speakers verbindt, moet u de bedrading van de speakers in uw auto controleren.

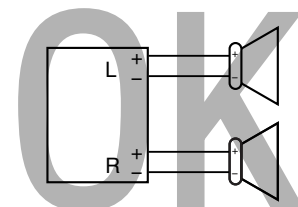
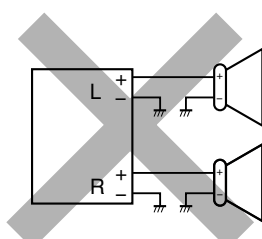
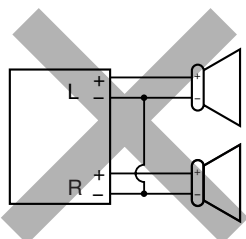

JVC



ENGLISH

РУССКИЙ

CD RECEIVER РЕСИВЕР С ПРОИГРЫВАТЕЛЕМ КОМПАКТ-ДИСКОВ

KD-G207

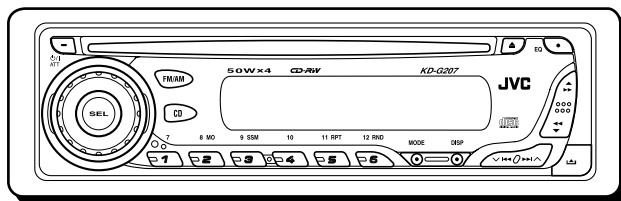
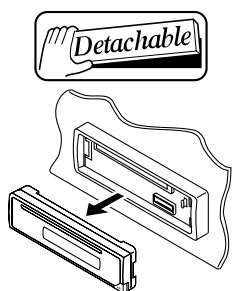

COMPACT
disc
DIGITAL AUDIO **CD-RW**

For installation and connections, refer to the separate manual. Указания по установке и выполнению соединений приводятся в отдельной инструкции.

В соответствии с Законом Российской Федерации “О защите прав потребителей” срок службы (годности) данного товара “по истечении которого он может представлять опасность для жизни, здоровья потребителя, причинять вред его имуществу или окружающей среде” составляет семь (7) лет со дня производства. Этот срок является временем, в течение которого потребитель данного товара может безопасно им пользоваться при условии соблюдения инструкции по эксплуатации данного товара, проводя необходимое обслуживание, включающее замену расходных материалов и/или соответствующее ремонтное обеспечение в специализированном сервисном центре.

Дополнительные косметические материалы к данному товару, поставляемые вместе с ним, могут храниться в течение двух (2) лет со дня его производства.

Срок службы (годности), кроме срока хранения дополнительных косметических материалов, упомянутых в предыдущих двух пунктах, не затрагивает никаких других прав потребителя, в частности, гарантийного свидетельства JVC, которое он может получить в соответствии с законом о правах потребителя или других законов, связанных с ним.

- This unit is equipped with the display demonstration. To cancel it, see page 6.
- Данное устройство имеет функцию демонстрации на экране дисплея. Порядок ее отмены смотрите на странице 6.

INSTRUCTIONS ИНСТРУКЦИИ ПО ЭКСПЛУАТАЦИИ



GET0179-001A
[EE]

IMPORTANT FOR LASER PRODUCTS

1. CLASS 1 LASER PRODUCT
2. **CAUTION:** Do not open the top cover. There are no user serviceable parts inside the unit; leave all servicing to qualified service personnel.
3. **CAUTION:** Visible and invisible laser radiation when open and interlock failed or defeated. Avoid direct exposure to beam.
4. REPRODUCTION OF LABEL: CAUTION LABEL, PLACED OUTSIDE THE UNIT.

CAUTION: Visible and invisible laser radiation when open and interlock failed or defeated. AVOID DIRECT EXPOSURE TO BEAM. (e)	ADVARSEL: Synlig og usynlig laserstråling når maskinen er åben eller interlocken fejler. Undgå direkte eksponering til strålingen. (e)	VARNING: Synlig og osynlig laserstråling når den öppnas och spårren är urkopplad. Betrakta ej strålen. (s)	VARO: Avalttaessa ja suojalukitus ohitettuna tai viallisena olet alittuna näkyvä ja näkymättömälle lasersträilylle. Vältä säteen kohdistumista suoraan iiseesi. (f)
--	---	---	--

How to reset your unit

While holding SEL (select), press **⏻/I ATT** (standby/on attenuator) for more than 2 seconds. This will reset the built-in microcomputer.

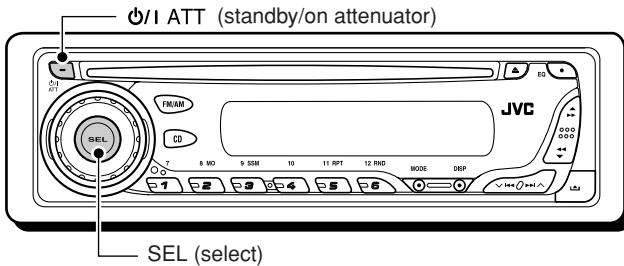

Notes:

- Your preset adjustments—such as preset channels or sound adjustments—will also be erased.
- If a CD is in the unit, it will eject when you reset the unit. Be careful not to drop the CD.

How to use the MODE button

If you press MODE, the unit goes into functions mode, then the number buttons work as different function buttons.

Ex.: When number button 2 works as MO (monaural) button.

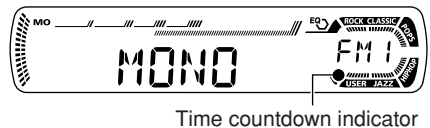
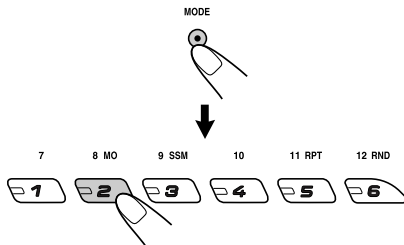

To use these buttons for original functions again after pressing MODE, wait for 5 seconds without pressing any of these buttons until the functions mode is cleared.

- Pressing MODE again also clears the functions mode.

Thank you for purchasing a JVC product. Please read all instructions carefully before operation, to ensure your complete understanding and to obtain the best possible performance from the unit.

CONTENTS

How to reset your unit	2	SOUND ADJUSTMENTS	14
How to use the MODE button	2	Selecting preset sound modes	
LOCATION OF THE BUTTONS	4	(C-EQ: custom equalizer)	14
Control panel	4	Adjusting the sound	15
BASIC OPERATIONS	5	OTHER MAIN FUNCTIONS	16
Turning on the power	5	Changing the general settings (PSM)	16
Canceling the display demonstration	6	Detaching the control panel	18
Setting the clock	7	TROUBLESHOOTING	19
RADIO OPERATIONS	8	MAINTENANCE	20
Listening to the radio	8	Handling discs	20
Storing stations in memory	9	SPECIFICATIONS	21
Tuning in to a preset station	10		
CD OPERATIONS	11		
Playing a CD	11		
Locating a track or a particular portion			
on a CD	12		
Selecting CD playback modes	12		
Prohibiting CD ejection	13		

BEFORE USE

*For safety....

- Do not raise the volume level too much, as this will block outside sounds, making driving dangerous.
- Stop the car before performing any complicated operations.

*Temperature inside the car....

If you have parked the car for a long time in hot or cold weather, wait until the temperature in the car becomes normal before operating the unit.



LOCATION OF THE BUTTONS

Control panel

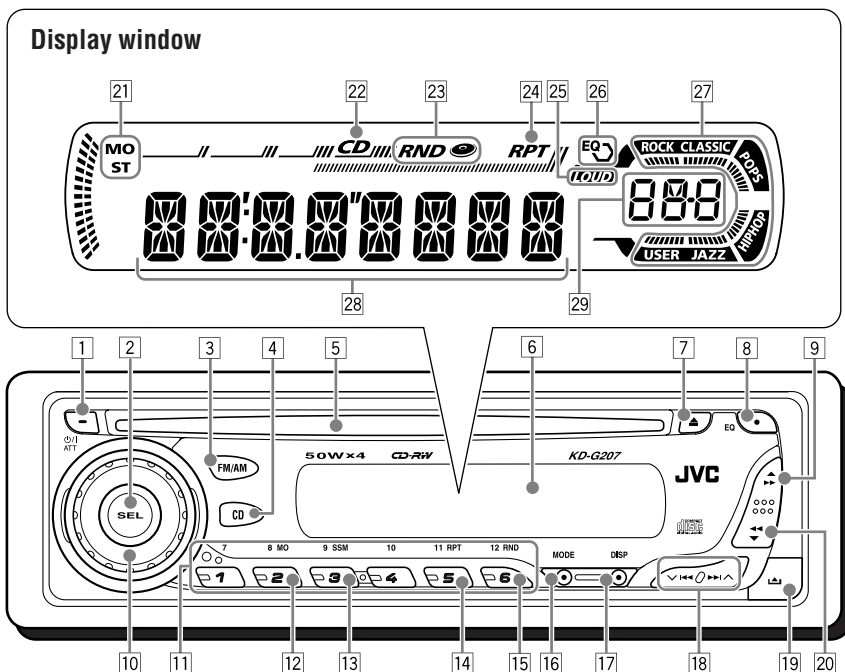

- 1 ATT (standby/on attenuator) button
- 2 SEL (select) button
- 3 FM/AM button
- 4 CD button
- 5 Loading slot
- 6 Display window
- 7 (eject) button
- 8 EQ (equalizer) button
- 9 (up) button
- 10 Control dial
- 11 Number buttons
- 12 MO (monaural) button
- 13 SSM (Strong-station Sequential Memory) button
- 14 RPT (repeat) button
- 15 RND (random) button
- 16 MODE button
- 17 DISP (display) button
- 18 buttons
- 19 (control panel release) button
- 20 (down) button
- (reverse) button

Display window

- 21 Tuner reception indicators—MO (monaural), ST (stereo)
- 22 CD indicator
- 23 RND (random disc) indicator
- 24 RPT (repeat) indicator
- 25 LOUD (loudness) indicator
- 26 EQ (equalizer) indicator
- 27 Sound mode (C-EQ: custom equalizer) indicators—ROCK, CLASSIC, POPS, HIP HOP, JAZZ, USER
- 28 Main display
- 29 Source display
- Volume level indicator

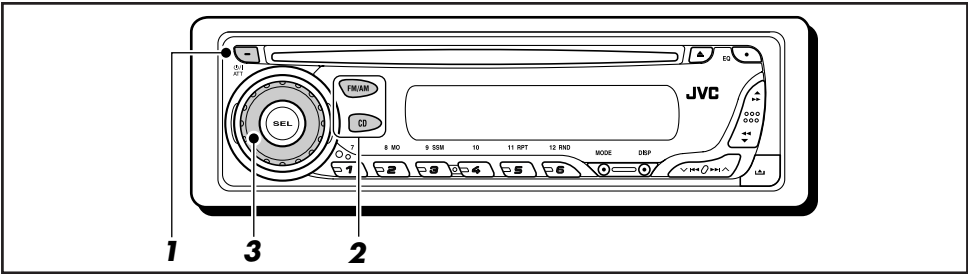

Turning on the power

1 Turn on the power.



Note on One-Touch Operation:

When you select a source in step 2 below, the power automatically comes on. You do not have to press this button to turn on the power.

2 Select the source.

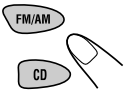

To operate the tuner (FM or AM), see pages 8 – 10.
To play a CD, see pages 11 – 13.

3 Adjust the volume.

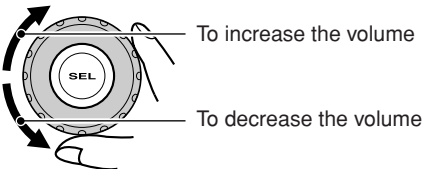

Volume level appears.

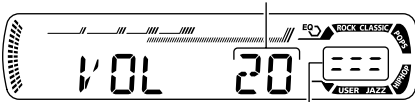

Volume level indicator

4 Adjust the sound as you want. (See pages 14 and 15.)

To drop the volume in a moment

Press **PWR/ATT** briefly while listening to any source. “ATT” starts flashing on the display, and the volume level will drop in a moment.

To resume the previous volume level, press the button briefly again.

- If you turn the control dial, you can also restore the sound.

To turn off the power

Press and hold **PWR/ATT** for more than one second.

“SEE YOU” appears, then the unit turns off.

- **If you turn off the power while listening to a CD,** CD play will start from where playback has been stopped previously, next time you turn on the power.

CAUTION on Volume Setting:

CDs produce very little noise compared with other sources. If the volume level is adjusted for the tuner, for example, the speakers may be damaged by the sudden increase in the output level. Therefore, lower the volume before playing a CD and adjust it as required during playback.

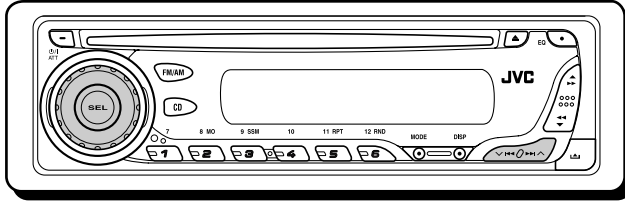

Canceling the display demonstration

When shipped from the factory, display demonstration has been activated, and starts automatically when no operations are done for about 20 seconds.

- It is recommended to cancel the display demonstration before you use the unit for the first time.

To cancel the display demonstration, follow the procedure below:

- Press and hold SEL (select) for more than 2 seconds so that one of the PSM items appears on the display. (PSM: see page 16.)



- Select "DEMO" if not shown on the display.

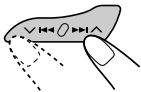

- Select "DEMO OFF."

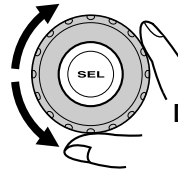

DEMO OFF ↔ DEMO ON

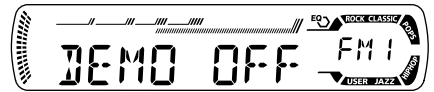

- Finish the setting.



To activate the display demonstration, repeat the same procedure and select "DEMO ON" in step 3.

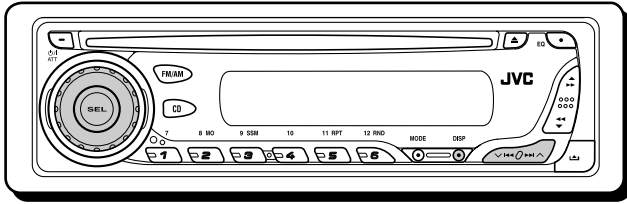

Setting the clock

- 1** Press and hold SEL (select) for more than 2 seconds so that one of the PSM items appears on the display. (PSM: see page 16.)



2 Set the hour.

- 1 Select "CLOCK H" (hour) if not shown on the display.
- 2 Adjust the hour.

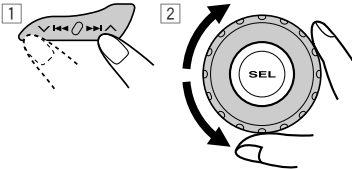

3 Set the minute.

- 1 Select "CLOCK M" (minute).
- 2 Adjust the minute.

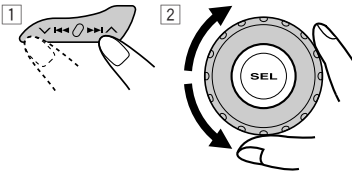

4 Finish the setting.



To check the current clock time or change the display mode



Press DISP (display) repeatedly. Each time you press the button, the display changes as follows:

- During tuner operation:

Frequency ↔ Clock

- During CD operation:

Elapsed playing time ↔ Clock

- During power off:

The power turns on and the clock time is shown for 5 seconds, then the power turns off.



RADIO OPERATIONS

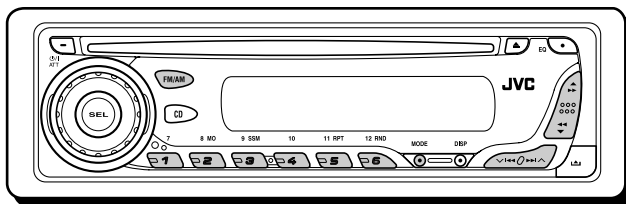

Listening to the radio

You can use either automatic searching or manual searching to tune in to a particular station.

Searching for a station automatically: Auto search

- 1 Select the band (FM1 – 3, AM).



Each time you press the button, the band changes as follows:

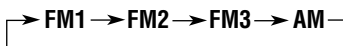

Lights up when receiving an FM stereo broadcast with sufficient signal strength.

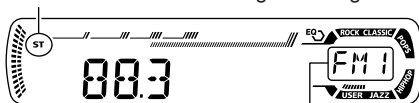

Selected band appears.

Note:

This receiver has three FM bands (FM1, FM2, FM3). You can use any one of them to listen to an FM broadcast.

- 2 Start searching for a station.



To search for stations of higher frequencies

To search for stations of lower frequencies

When a station is received, searching stops.

To stop searching before a station is received, press the same button you have pressed for searching.

Note:

FM1 and FM2: 87.5 MHz – 108.0 MHz
FM3: 65.00 MHz – 74.00 MHz

Searching for a station manually: Manual search

- 1 Select the band (FM1 – 3, AM).



Each time you press the button, the band changes as follows:

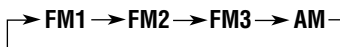

Note:

This receiver has three FM bands (FM1, FM2, FM3). You can use any one of them to listen to an FM broadcast.

- 2 Press and hold **▲** or **▼** until “M” (manual) starts flashing on the display.

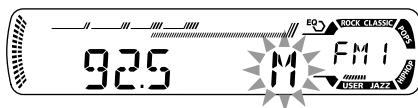
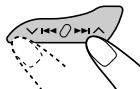

3 Tune in to a station you want while “M” (manual) is still flashing.



To tune in to stations of higher frequencies

To tune in to stations of lower frequencies

- If you release your finger from the button, the manual mode will automatically turn off after 5 seconds.
- If you hold down the button, the frequency keeps changing—in 50 kHz intervals (87.5 MHz – 108.0 MHz for FM 1 and FM 2), in 30 kHz intervals (65.00 MHz – 74.00 MHz for FM 3) and 9 kHz for AM—MW/LW until you release the button.

Storing stations in memory

You can use one of the following two methods to store broadcasting stations in memory.

- Automatic preset of FM stations: SSM (Strong-station Sequential Memory)
- Manual preset of both FM and AM stations

FM station automatic preset: SSM

You can preset 6 local FM stations in each FM band (FM1, FM2, and FM3).

1 Select the FM band (FM1 – 3) you want to store FM stations into.



Each time you press the button, the band changes as follows:

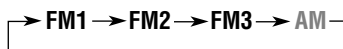

2 Press MODE to enter the functions mode.



3 Press and hold SSM for about 2 seconds.

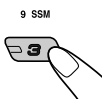

“SSM” flashes, then disappears when automatic preset is over.

Local FM stations with the strongest signals are searched and stored automatically in the band number you have selected (FM1, FM2, or FM3). These stations are preset in the number buttons—No.1 (lowest frequency) to No.6 (highest frequency).

When automatic preset is over, the station stored in number button 1 will be automatically tuned in.

When an FM stereo broadcast is hard to receive

MODE



- 1 Press MODE to enter the functions mode while listening to an FM stereo broadcast.

8 MO



- 2 Press MO (monaural), while “MODE” is still flashing on the display, so that “MONO” appears on the display. Each time you press the button, monaural mode turns on and off alternately.

MO (monaural) indicator



When the MO indicator is lit on the display, the sound you hear becomes monaural but the reception will be improved.



Manual preset

You can preset up to 6 stations in each band (FM1, FM2, FM3, and AM) manually.

Ex.: Storing FM station of 92.5 MHz into the preset number 1 of the FM1 band.

1 Select the band (FM1 – 3, AM) you want to store stations into (in this example, FM1).



Each time you press the button, the band changes as follows:

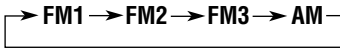

2 Tune in to a station (in this example, of 92.5 MHz).

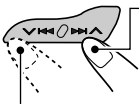

To tune in to stations of higher frequencies

To tune in to stations of lower frequencies

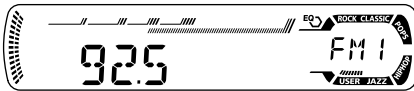

3 Press and hold the number button (in this example, 1) for more than 2 seconds.

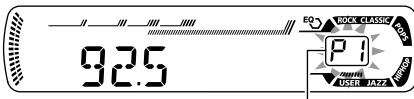
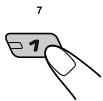

Preset number flashes for a while.

4 Repeat the above procedure to store other stations into other preset numbers.

Notes:

- A previously preset station is erased when a new station is stored in the same preset number.
- Preset stations are erased when the power supply to the memory circuit is interrupted (for example, during battery replacement). If this occurs, preset the stations again.

Tuning in to a preset station

You can easily tune in to a preset station. Remember that you must store stations first. If you have not stored them yet, see “Storing stations in memory” on pages 9 and 10.

1 Select the band (FM1 – 3, AM).



Each time you press the button, the band changes as follows:

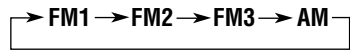

2 Select the number (1 – 6) for the preset station you want.

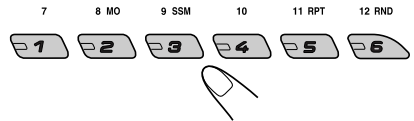

Note:

You can also use the ▲ (up) or ▼ (down) button on the unit to select the next or previous preset stations. Each time you press the ▲ (up) or ▼ (down) button, the next or previous preset station is tuned in.

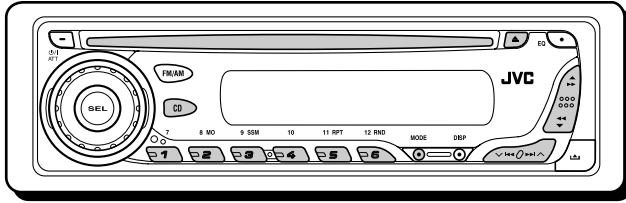

Playing a CD

Insert a CD into the loading slot.

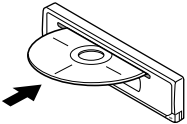

The unit turns on, draws the CD and starts playback automatically.

Note on One-Touch Operation:

When a CD is already in the loading slot, pressing CD turns on the unit and starts playback automatically.

Notes:

- When a CD is inserted upside down, "EJECT" appears on the display and the CD automatically ejects.
- If there is no CD in the loading slot, you cannot select CD as the source. "NO DISC" appears on the display.

To stop play and eject the CD

Press ▲.

CD play stops and the CD automatically ejects from the loading slot. The source changes to the tuner (you will hear the last received station).

- If you change the source, CD play also stops (without ejecting the CD). Next time you select "CD" as the source, CD play starts from where playback has been stopped previously.

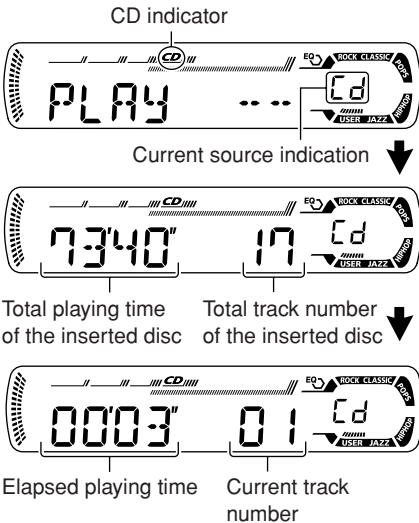

Notes:

- If the ejected CD is not removed for about 15 seconds, the CD is automatically inserted again into the loading slot to protect it from dust. (CD play will not start this time.)
- You can eject the CD even when the unit is turned off.

About mistracking:

Mistracking may result from driving on extremely rough roads. This does not damage the unit and the CD, but will be annoying. We recommend that you stop CD play while driving on such rough roads.

All tracks will be played repeatedly until you stop playback.



Locating a track or a particular portion on a CD

To fast-forward or reverse the track

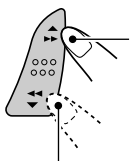

Press and hold **▶▶**, while playing a CD, to fast-forward the track.

Press and hold **◀◀**, while playing a CD, to reverse the track.

To go to the next or previous tracks

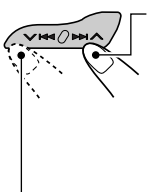

Press **▶▶|▲** briefly, while playing a CD, to go ahead to the beginning of the next track. Each time you press the button consecutively, the beginning of the next tracks is located and played back.

Press **▼|◀◀** briefly, while playing a CD, to go back to the beginning of the current track. Each time you press the button consecutively, the beginning of the previous tracks is located and played back.

To go to a particular track directly

Press the number button corresponding to the track number to start its playback.

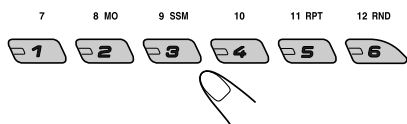

- To select a track number from 1 – 6:
Press 1 (7) – 6 (12) briefly.
- To select a track number from 7 – 12:
Press and hold 1 (7) – 6 (12) for more than one second.

Selecting CD playback modes

To play back tracks at random (Disc Random Play)

You can play back all tracks on the CD at random.

MODE



- 1 Press MODE to enter the functions mode while playing a CD.

12 RND



- 2 Press RND (random), while "MODE" is still flashing on the display, so that "DISC RND" appears on the display. Each time you press the button, disc random play mode turns on and off alternately.

RND  (random disc) indicator



When disc random play is turned on, the RND  indicator lights up on the display. A track randomly selected starts playing.



To play back tracks repeatedly (Track Repeat Play)

You can play back the current track repeatedly.

MODE



- 1 Press MODE to enter the functions mode while playing a CD.

11 RPT



- 2 Press RPT (repeat), while "MODE" is still flashing on the display, so that "TRK RPT" appears on the display. Each time you press the button, track repeat play mode turns on and off alternately.

RPT indicator

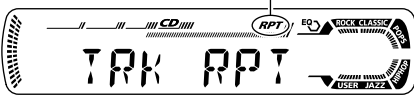

When track repeat play is turned on, the RPT indicator lights up on the display. The current track starts playing repeatedly.

Prohibiting CD ejection

You can prohibit CD ejection and can lock a CD in the loading slot.

While pressing CD, press and hold ▲ for more than 2 seconds.



"EJECT" flashes on the display for about 5 seconds, and the CD is locked and cannot be ejected.



To cancel the prohibition and unlock the CD

While pressing CD, press and hold ▲ again for more than 2 seconds.

"EJECT" appears on the display, and the CD ejects from the loading slot.

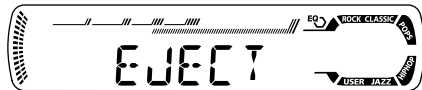



SOUND ADJUSTMENTS

Selecting preset sound modes (C-EQ: custom equalizer)

You can select a preset sound mode (C-EQ: custom equalizer) suitable to the music genre.

Select the sound mode you want.



Each time you press the button, the sound modes change as follows:

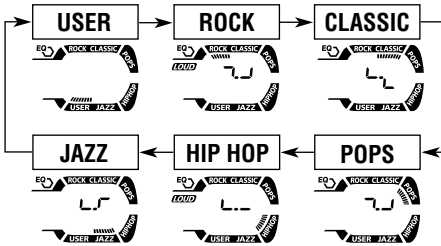

Indication pattern changes for each sound mode except for "USER."

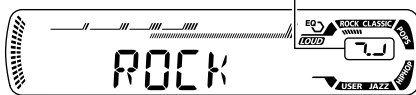

Ex.: When you select "ROCK"

Indication	For:	Preset values		
		BAS	TRE	LOUD
USER	(Flat sound)	00	00	OFF
ROCK	Rock or disco music	+03	+01	ON
CLASSIC	Classical music	+01	-02	OFF
POPS	Light music	+04	+01	OFF
HIP HOP	Funk or rap music	+02	00	ON
JAZZ	Jazz music	+02	+03	OFF

Note:

You can adjust each sound mode to your preference. Once you make an adjustment, it is automatically stored for the currently selected sound mode. See "Adjusting the sound" on page 15.

Adjusting the sound

You can adjust the sound characteristics to your preference.

1 Select the item you want to adjust.



Each time you press the button, the adjustable items change as follows:

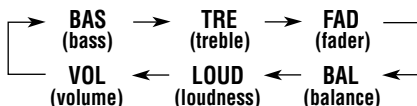

Indication	To do:	Range
BAS* ¹	Adjust the bass.	-06 (min.) +06 (max.)
TRE* ¹	Adjust the treble.	-06 (min.) +06 (max.)
FAD* ²	Adjust the front and rear speaker balance.	R06 (Rear only) F06 (Front only)
BAL	Adjust the left and right speaker balance.	L06 (Left only) R06 (Right only)
LOUD* ¹	Boost low and high frequencies to produce a well-balanced sound at low volume level.	LOUD ON LOUD OFF
VOL* ³	Adjust the volume.	00 (min.) 30 or 50 (max.)* ⁴

*¹ When you adjust the bass, treble, or loudness, the adjustment you have made is stored for the currently selected sound mode (C-EQ) including "USER."

*² If you are using a two-speaker system, set the fader level to "00."

*³ Normally the control dial works as the volume control. So you do not have to select "VOL" to adjust the volume level.

*⁴ Depending on the amplifier gain control setting. (See page 17 for details.)

2 Adjust the setting.

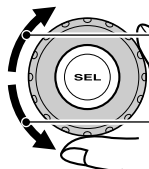

To increase the level or turn on the loudness

To decrease the level or turn off the loudness

Indication pattern changes as you adjust the bass or treble.

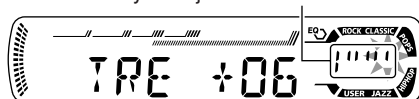

Ex. 1: When you adjust "TRE" (treble)

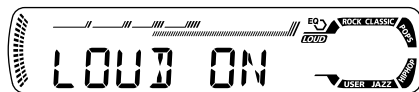

Ex. 2: When you turn on the loudness

3 Repeat steps 1 and 2 to adjust the other items.

To reset each sound mode to the factory settings, repeat the same procedure and reassign the preset values listed in the table on page 14.



OTHER MAIN FUNCTIONS

Changing the general settings (PSM)

You can change the items listed in the table below by using the PSM (Preferred Setting Mode) control.

Basic Procedure

1 Press and hold SEL (select) for more than 2 seconds so that one of the PSM items appears on the display. (See below.)



2 Select the PSM item you want to adjust.

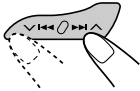

3 Adjust the PSM item selected.

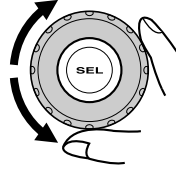

4 Repeat steps 2 and 3 to adjust the other PSM items if necessary.

5 Finish the setting.



Preferred Setting Mode (PSM) items

• For detailed operations of each PSM items, refer to the pages listed in the table.

Indications		Selectable values/items		Factory-preset settings	See page
DEMO	Display demonstration	DEMO OFF	DEMO ON	DEMO ON	6
CLOCK H	Hour adjustment	0 — 23		0 (0:00)	7
CLOCK M	Minute adjustment	00 — 59		00 (0:00)	
DIMMER	Dimmer mode	OFF	ON	OFF	17
TEL	Telephone muting	OFF ↔ MUTING 1 ↕ MUTING 2 ↕		OFF	17
AMP GAIN	Amplifier gain control	LOW PWR	HIGH PWR	HIGH PWR	17



To select the dimmer mode—DIMMER

You can dim the display at night (according to your preference).

When shipped from the factory, dimmer is deactivated.

- OFF: Cancels the dimmer.
- ON: Activates the dimmer.

To select the telephone muting—TEL

This mode is used when a cellular phone system is connected. Depending on the phone system used, select either "MUTING 1" or "MUTING 2" whichever mutes the sounds from this unit.

When shipped from the factory, this mode is deactivated.

- MUTING 1: Select if this setting can mute the sounds.
- MUTING 2: Select if this setting can mute the sounds.
- OFF: Cancels the telephone muting.

To select the amplifier gain control—AMP GAIN

You can change the maximum volume level of this unit. When the maximum power of the speakers is less than 50 W, select "LOW PWR" to prevent them from being damaged.

When shipped from the factory, "HIGH PWR" is selected.

- LOW PWR: You can adjust the volume level from "VOL 00" to "VOL 30."

Note:

If you change the setting from "HIGH PWR" to "LOW PWR" while listening at a volume level more than 30, the unit automatically changes the volume level to "VOL 30."

- HIGH PWR: You can adjust the volume level from "VOL 00" to "VOL 50."



Detaching the control panel

You can detach the control panel when leaving the car.

When detaching or attaching the control panel, be careful not to damage the connectors on the back of the control panel and on the panel holder.

Detaching the control panel

Before detaching the control panel, be sure to turn off the power.

1 Unlock the control panel.

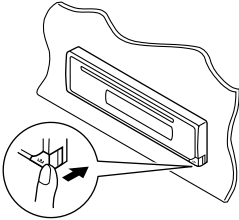

2 Lift and pull the control panel out of the unit.

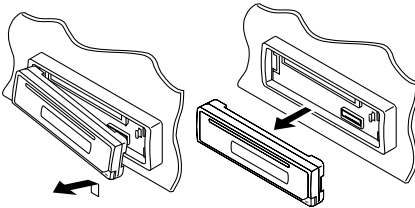

3 Put the detached control panel into the provided case.

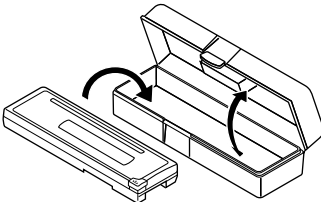

Attaching the control panel

1 Insert the left side of the control panel into the groove on the panel holder.

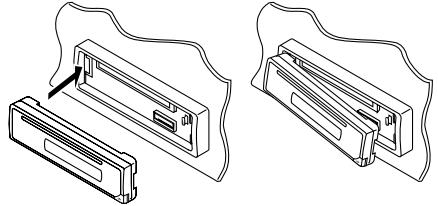

2 Press the right side of the control panel to fix it to the panel holder.

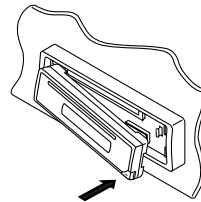

Note on cleaning the connectors:

If you frequently detach the control panel, the connectors will deteriorate.

To minimize this possibility, periodically wipe the connectors with a cotton swab or cloth moistened with alcohol, being careful not to damage the connectors.

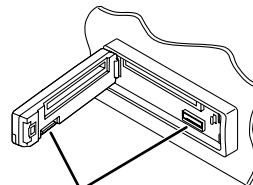

Connectors

TROUBLESHOOTING

What appears to be trouble is not always serious. Check the following points before calling a service center.

	Symptoms	Causes	Remedies
General	<ul style="list-style-type: none"> Sound cannot be heard from the speakers. 	The volume level is set to the minimum level.	Adjust it to the optimum level.
		Connections are incorrect.	Check the cords and connections.
	<ul style="list-style-type: none"> This unit does not work at all. 	The built-in microcomputer may have functioned incorrectly due to noise, etc.	While holding SEL (select), press ⏻/ATT (standby/on attenuator) for more than 2 seconds to reset the unit. (The clock setting and preset stations stored in memory are erased.) (See page 2.)
FM/AM	<ul style="list-style-type: none"> SSM (Strong-station Sequential Memory) automatic preset does not work. 	Signals are too weak.	Store stations manually.
	<ul style="list-style-type: none"> Static noise while listening to the radio. 	The aerial is not connected firmly.	Connect the aerial firmly.
CD Playback	<ul style="list-style-type: none"> CD automatically ejects. 	CD is inserted upside down.	Insert the CD correctly.
	<ul style="list-style-type: none"> CD-R/CD-RW cannot be played back. Tracks on the CD-R/CD-RW cannot be skipped. 	CD-R/CD-RW is not finalized.	<ul style="list-style-type: none"> Insert a finalized CD-R/CD-RW. Finalize the CD-R/CD-RW with the component which you used for recording.
		<ul style="list-style-type: none"> CD can be neither played back nor ejected. 	CD is locked.
	The CD player may have functioned incorrectly.		While holding ⏻/ATT (standby/on attenuator), press ▲ (eject) for more than 2 seconds. Be careful not to drop the CD when it is ejected.
	<ul style="list-style-type: none"> CD sound is sometimes interrupted. 	You are driving on rough roads.	Stop playback while driving on rough roads.
		CD is scratched.	Change the CD.
		Connections are incorrect.	Check the cords and connections.
	<ul style="list-style-type: none"> "NO DISC" appears on the display. 	No CD in the loading slot.	Insert a CD into the loading slot.
CD is inserted incorrectly.		Insert the CD correctly.	



MAINTENANCE

Handling discs

This unit has been designed to reproduce CDs, CD-Rs (Recordable), and CD-RWs (Rewritable).

- **This unit is not compatible with MP3 discs.**

How to handle discs

When removing a disc from its case, press down the center holder of the case and lift the disc out, holding it by the edges.

- Always hold the disc by the edges. Do not touch its recording surface.

When storing a disc into its case, gently insert the disc around the center holder (with the printed surface facing up).

- Make sure to store discs into the cases after use.

Center holder



To keep discs clean

A dirty disc may not be played correctly. If a disc does become dirty, wipe it with a soft cloth in a straight line from center to edge.



To play new discs

New discs may have some rough spots around the inner and outer edges. If such a disc is used, this unit may reject the disc.

To remove these rough spots, rub the edges with a pencil or ball-point pen, etc.



Moisture condensation

Moisture may condense on the lens inside the CD player in the following cases:

- After starting the heater in the car.
- If it becomes very humid inside the car.

Should this occur, the CD player may malfunction. In this case, eject the disc and leave the unit turned on for a few hours until the moisture evaporates.

When playing a CD-R or CD-RW

Before playing back CD-Rs or CD-RWs, read their instructions or cautions carefully.

- Use only "finalized" CD-Rs or CD-RWs.
- Some CD-Rs or CD-RWs may not be played back on this unit because of their disc characteristics, and for the following reasons:
 - Discs are dirty or scratched.
 - Moisture condensation on the lens inside the unit.
 - The pickup lens inside the unit is dirty.
- CD-RWs may require a longer readout time since the reflectance of CD-RWs is lower than that of regular CDs.
- CD-Rs or CD-RWs are susceptible to high temperatures or high humidity, so do not leave them inside your car.
- Do not use following CD-Rs or CD-RWs:
 - Discs with stickers, labels, or protective seal stuck to the surface.
 - Discs on which labels can be directly printed by an ink jet printer.

Using these discs under high temperatures or high humidity may cause malfunctions or damage to discs. For example,

- Stickers or labels may shrink and warp a disc.
- Stickers or labels may be peeled off so discs cannot be ejected.
- Print on discs may get sticky.

Read instructions or cautions about labels and printable discs carefully.

CAUTIONS:

- Do not insert 8 cm discs (single CDs) into the loading slot. (Such discs cannot be ejected.)
- Do not insert any disc of unusual shape—like a heart or flower; otherwise, it will cause a malfunction.
- Do not expose discs to direct sunlight or any heat source or place them in a place subject to high temperature and humidity. Do not leave them in a car.
- Do not use any solvent (for example, conventional record cleaner, spray, thinner, benzene, etc.) to clean discs.

Warped disc



Sticker



Sticker residue

Disc



Stick-on label

AUDIO AMPLIFIER SECTION

Maximum Power Output:

Front: 50 W per channel

Rear: 50 W per channel

Continuous Power Output (RMS):

Front: 19 W per channel into 4 Ω , 40 Hz to 20 000 Hz at no more than 0.8% total harmonic distortion.

Rear: 19 W per channel into 4 Ω , 40 Hz to 20 000 Hz at no more than 0.8% total harmonic distortion.

Load Impedance: 4 Ω (4 Ω to 8 Ω allowance)

Tone Control Range:

Bass: ± 10 dB at 100 Hz

Treble: ± 10 dB at 10 kHz

Frequency Response: 40 Hz to 20 000 Hz

Signal-to-Noise Ratio: 70 dB

Line-Out Level/Impedance:

2.0 V/20 k Ω load (full scale)

Output Impedance: 1 k Ω

TUNER SECTION

Frequency Range:

FM1/FM2: 87.5 MHz to 108.0 MHz

FM3: 65.00 MHz to 74.00 MHz

AM: (MW) 522 kHz to 1 620 kHz

(LW) 144 kHz to 279 kHz

[FM Tuner]

Usable Sensitivity:

11.3 dBf (1.0 μ V/75 Ω)

50 dB Quieting Sensitivity:

16.3 dBf (1.8 μ V/75 Ω)

Alternate Channel Selectivity (400 kHz):

65 dB

Frequency Response: 40 Hz to 15 000 Hz

Stereo Separation: 30 dB

Capture Ratio: 1.5 dB

[MW Tuner]

Sensitivity: 20 μ V

Selectivity: 35 dB

[LW Tuner]

Sensitivity: 50 μ V

CD PLAYER SECTION

Type: Compact disc player

Signal Detection System: Non-contact optical pickup (semiconductor laser)

Number of channels: 2 channels (stereo)

Frequency Response: 5 Hz to 20 000 Hz

Dynamic Range: 96 dB

Signal-to-Noise Ratio: 98 dB

Wow and Flutter: Less than measurable limit

GENERAL

Power Requirement:

Operating Voltage:

DC 14.4 V (11 V to 16 V allowance)

Grounding System: Negative ground

Allowable Operating Temperature:

0°C to +40°C

Dimensions (W \times H \times D):

Installation Size (approx.):

182 mm \times 52 mm \times 150 mm

Panel Size (approx.):

188 mm \times 58 mm \times 11 mm

Mass (approx.):

1.3 kg (excluding accessories)

Design and specifications are subject to change without notice.



**Having TROUBLE with operation?
Please reset your unit**

Refer to page of How to reset your unit

**Затруднения при эксплуатации?
Пожалуйста, перезагрузите Ваше
устройство**

Для получения информации о перезагрузке Вашего устройства обратитесь на соответствующую страницу

JVC

VICTOR COMPANY OF JAPAN, LIMITED



EN, RU

© 2003 VICTOR COMPANY OF JAPAN, LIMITED

1103KKSMdTJEIN

Removing the unit

Before removing the unit, release the rear section.

Удаление устройства

Перед удалением устройства освободите заднюю часть.

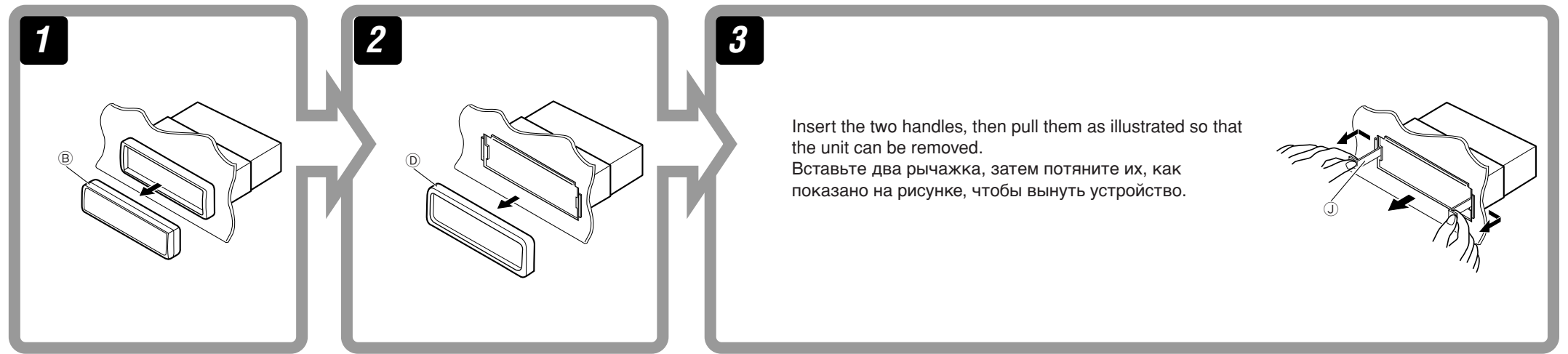

When using the optional stay

При использовании дополнительной стойки

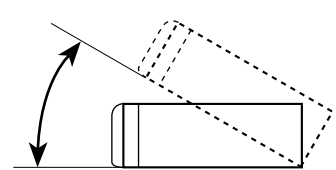
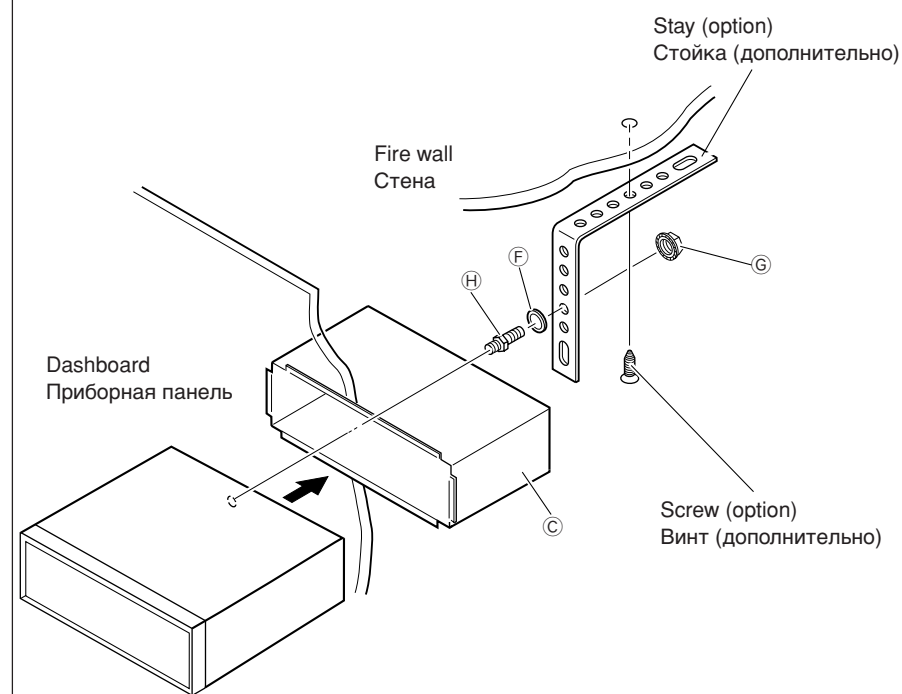

Install the unit at an angle of less than 30°.
Установите устройство под углом менее 30°.

When installing the unit without using the sleeve

При установке устройства без использования муфты

In a Toyota for example, first remove the car radio and install the unit in its place.

В автомобилях "Toyota", например, сначала удалите автомобильную магнитолу, затем установите на ее место это устройство.

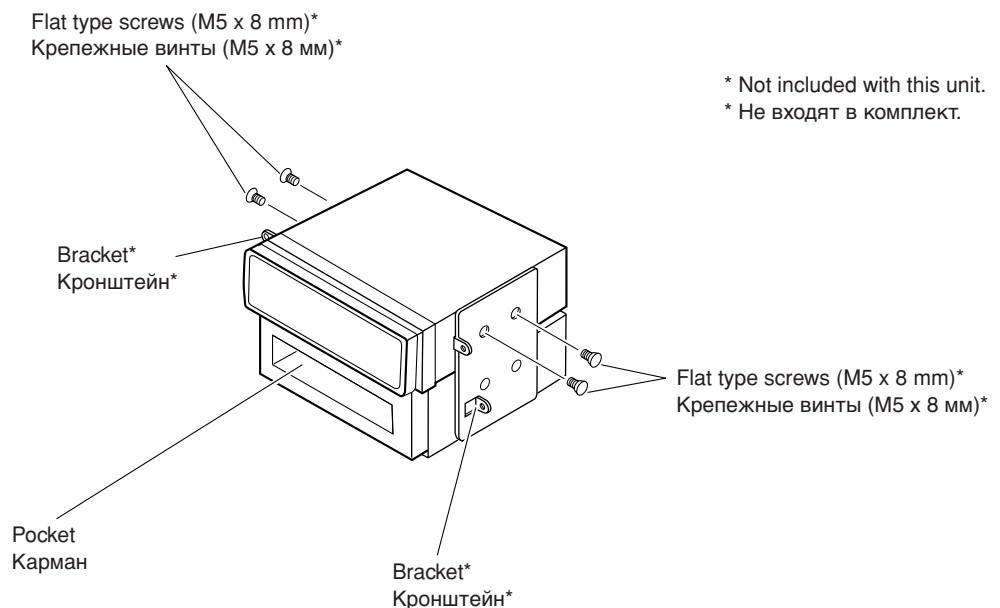

* Not included with this unit.
* Не входят в комплект.

Note : When installing the unit on the mounting bracket, make sure to use the 8 mm-long screws. If longer screws are used, they could damage the unit.
Примечание : При установке устройства на крепежный кронштейн, используйте только винты длиной 8 мм. При использовании более длинных винтов можно повредить устройство.

TROUBLESHOOTING

- **The fuse blows.**
 - * Are the red and black leads connected correctly?
- **Power cannot be turned on.**
 - * Is the yellow lead connected?
- **No sound from the speakers.**
 - * Is the speaker output lead short-circuited?
- **Sound is distorted.**
 - * Is the speaker output lead grounded?
 - * Are the "-" terminals of L and R speakers grounded in common?
- **Noise interfere with sounds.**
 - * Is the rear ground terminal connected to the car's chassis using shorter and thicker cords?
- **Unit becomes hot.**
 - * Is the speaker output lead grounded?
 - * Are the "-" terminals of L and R speakers grounded in common?

ВЫЯВЛЕНИЕ НЕИСПРАВНОСТЕЙ

- **Сработал предохранитель.**
 - * Правильно ли подключены черный и красный провода?
- **Питание не включается.**
 - * Подключен ли желтый провод?
- **Звук не выводится через громкоговорители.**
 - * Нет ли короткого замыкания на кабеле выхода громкоговорителей?
- **Звук искажен.**
 - * Заземлен ли провод выхода громкоговорителей?
 - * Заземлены ли разъемы "-" правого (R) и левого (L) громкоговорителей?
- **Шум мешает звучанию.**
 - * Соединен ли находящийся сзади зажим заземления с шасси автомобиля с помощью более короткого и тонкого шнуров?
- **Устройство нагревается.**
 - * Заземлен ли провод выхода громкоговорителей?
 - * Заземлены ли разъемы "-" правого (R) и левого (L) громкоговорителей?

ELECTRICAL CONNECTIONS

To prevent short circuits, we recommend that you disconnect the battery's negative terminal and make all electrical connections before installing the unit.

- Be sure to ground this unit to the car's chassis again after installation.

Notes:

- Replace the fuse with one of the specified rating. If the fuse blows frequently, consult your JVC IN-CAR ENTERTAINMENT dealer.
- It is recommended to connect to the speakers with maximum power of more than 50 W (both at the rear and at the front, with an impedance of 4 Ω to 8 Ω). If the maximum power is less than 50 W, change "AMP GAIN" setting to prevent the speakers from being damaged (see page 17 of the INSTRUCTIONS).
- To prevent short-circuit, cover the terminals of the UNUSED leads with insulating tape.
- The heat sink becomes very hot after use. Be careful not to touch it when removing this unit.

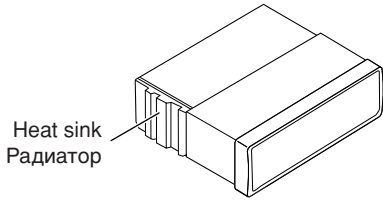

ЭЛЕКТРИЧЕСКИЕ ПОДКЛЮЧЕНИЯ

Для предотвращения коротких замыканий мы рекомендуем Вам отсоединить отрицательный разъем аккумулятора и осуществить все подключения перед установкой устройства.

- После установки обязательно заземлите данное устройство на шасси автомобиля.

Примечания:

- Заменяйте предохранитель другим предохранителем указанного класса. Если предохранитель сгорает слишком часто, обратитесь к дилеру автомобильного специалиста JVC.
- Рекомендуется подключать динамики с максимальной мощностью более 50 Вт (к задней и передней панели устройства, с полным сопротивлением от 4 Ω до 8 Ω). Если максимальная мощность динамиков менее 50 Вт, перейдите в режим "AMP GAIN", чтобы предотвратить их повреждение (см. ИНСТРУКЦИИ ПО ЭКСПЛУАТАЦИИ на стр. 17).
- Для предотвращения короткого замыкания заклейте НЕИСПОЛЬЗУЕМЫЕ концы изолирующей лентой.
- Радиатор во время использования сильно нагревается. Старайтесь его не трогать во время удаления устройства.

A Typical Connections / Типичные подключения

Before connecting: Check the wiring in the vehicle carefully. Incorrect connection may cause serious damage to this unit.

The leads of the power cord and those of the connector from the car body may be different in color.

- 1 Connect the colored leads of the power cord in the order specified in the illustration below.
- 2 Connect the aerial cord.
- 3 Finally connect the wiring harness to the unit.

Note: If your vehicle does not have any accessory terminal, move the fuse from the fuse position 1 (initial position) to fuse position 2, and connect the red lead (A7) to the positive (+) battery terminal.

- The yellow lead (A4) is not used in this case.

Перед началом подключений: Тщательно проверьте проводку в автомобиле. Неправильное подключение может привести к серьезному повреждению устройства. Жилы силового кабеля и жилы соединителя от кузова автомобиля могут быть разного цвета.

- 1 Подсоедините цветные провода шнура питания в указанном ниже порядке.
- 2 Подключите кабель антенны.
- 3 В последнюю очередь подключите электропроводку к устройству.

Примечание: Если в Вашем автомобиле никакого вспомогательного разъема не имеется, переставьте предохранитель из положения 1 предохранителя (первоначальное положение) в положение 2 предохранителя и подключите красный провод (A7) к положительному (+) полюсу аккумулятора.

- Желтый провод (A4) в этом случае не используется.

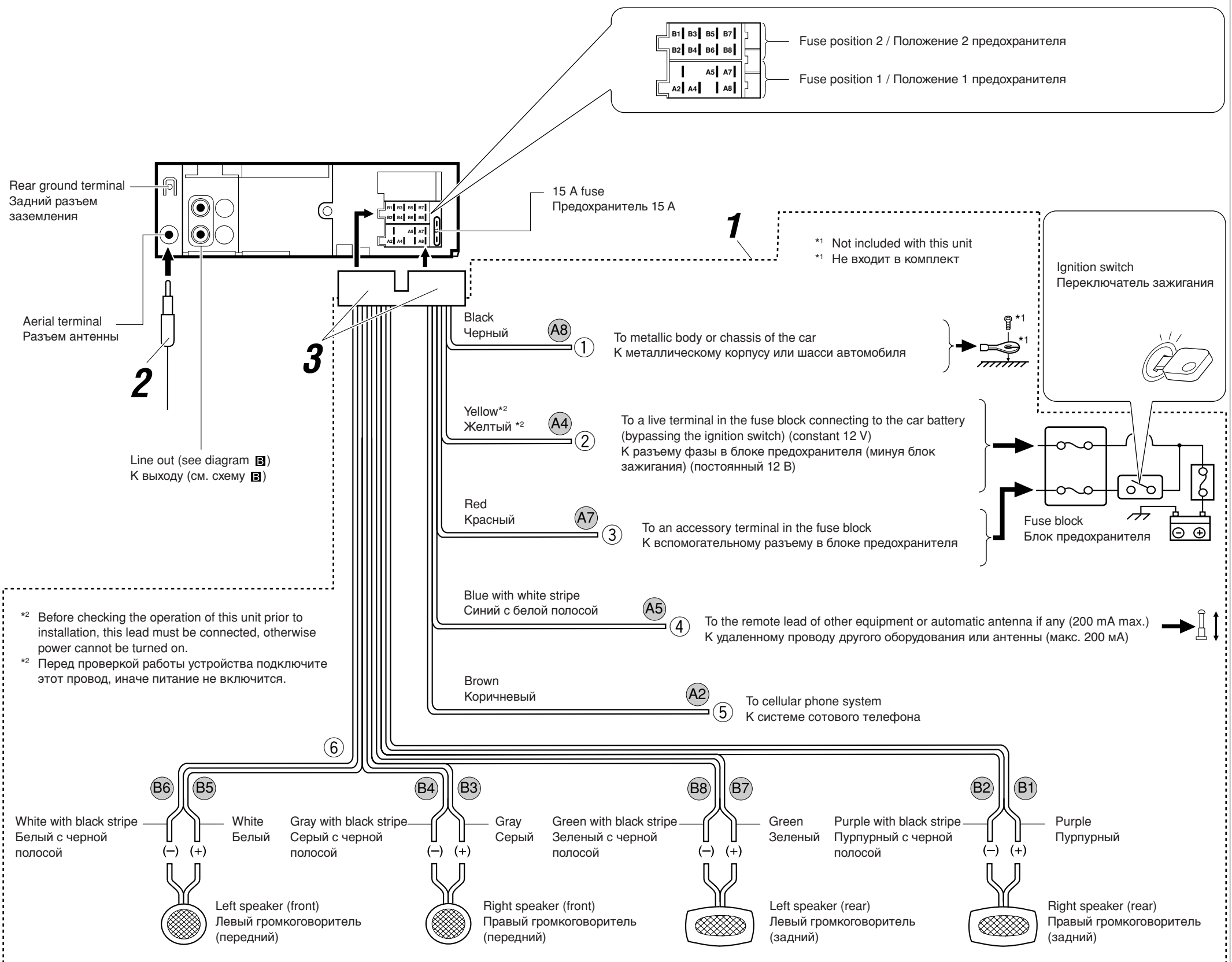

Amplifier / Усилитель

You can connect an amplifier to upgrade your car stereo system.

- Connect the remote lead (blue with white stripe) to the remote lead of the other equipment so that it can be controlled through this unit.
- **Disconnect the speakers from this unit, connect them to the amplifier. Leave the speaker leads of this unit unused.**

Для обновления автомобильной стереосистемы Вы можете подключить усилитель.

- Подсоедините провод внешнего устройства (синий с белой полосой) к проводу внешнего устройства другого оборудования так, чтобы им можно было управлять с этого устройства.
- **Только для усилителя:** Отсоедините громкоговорители от данного устройства, подключите их к усилителю. Оставьте провода громкоговорителей данного устройства неиспользованными.

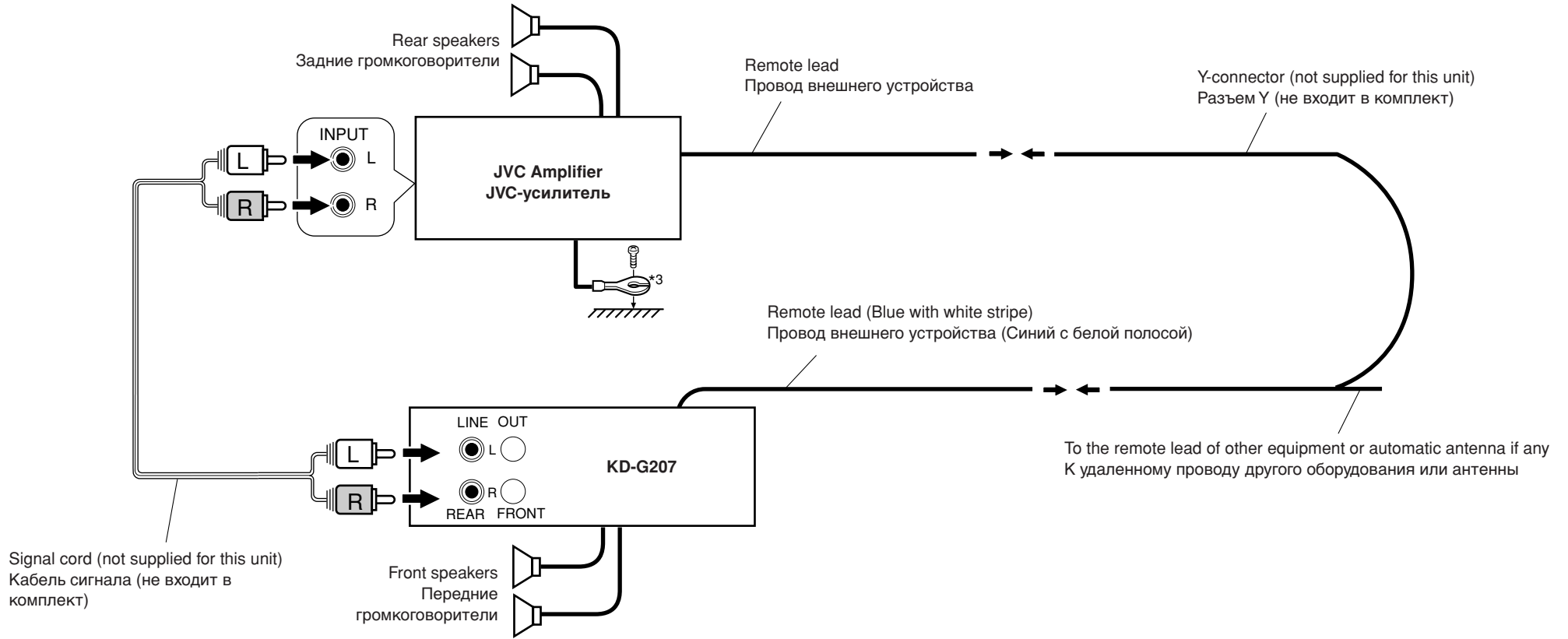

*3 Firmly attach the ground wire to the metallic body or to the chassis of the car—to the place not coated with paint (if coated with paint, remove the paint before attaching the wire). Failure to do so may cause damage to the unit.

*3 Плотно прикрепите заземляющий провод к металлическому кузову или шасси автомобиля—в месте, не покрытом краской (если оно покрыто краской, удалите краску перед тем, как прикреплять провод). Невыполнение этого требования может привести к повреждению данного устройства.

PRECAUTIONS on power supply and speaker connections:

- **DO NOT** connect the speaker leads of the power cord to the car battery; otherwise, the unit will be seriously damaged.
- **BEFORE** connecting the speaker leads of the power cord to the speakers, check the speaker wiring in your car.

ПРЕДОСТЕРЕЖЕНИЯ по питанию и подключению громкоговорителей:

- **НЕ** подключайте провода громкоговорителей к аккумулятору автомобиля, иначе устройство будет повреждено.
- **ПЕРЕД** подключением проводов громкоговорителей к кабелю питания громкоговорителя проверьте схему соединений громкоговорителей в Вашем автомобиле.

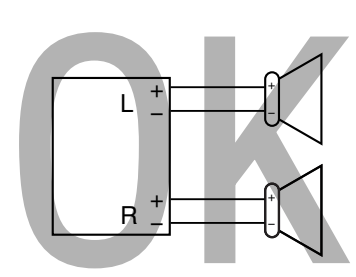
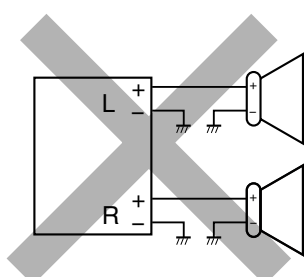
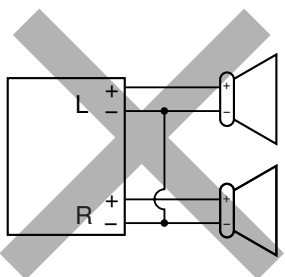

Free Manuals Download Website

<http://myh66.com>

<http://usermanuals.us>

<http://www.somanuals.com>

<http://www.4manuals.cc>

<http://www.manual-lib.com>

<http://www.404manual.com>

<http://www.luxmanual.com>

<http://aubethermostatmanual.com>

Golf course search by state

<http://golfingnear.com>

Email search by domain

<http://emailbydomain.com>

Auto manuals search

<http://auto.somanuals.com>

TV manuals search

<http://tv.somanuals.com>