

# JVC



ENGLISH

FRANÇAIS

## CD RECEIVER RECEPTEUR CD

# KD-G411

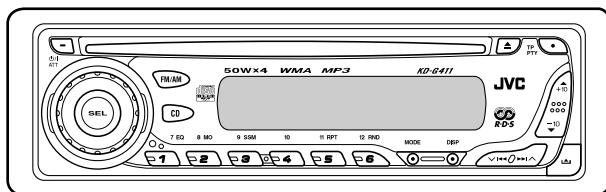
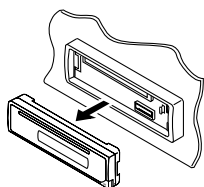

**WMA MP3**



For canceling the display demonstration, see page 7.  
Pour annuler la démonstration des affichages, référez-vous à la page 7.

For installation and connections, refer to the separate manual.  
Pour l'installation et les raccordements, se référer au manuel séparé.

# INSTRUCTIONS

## MANUEL D'INSTRUCTIONS

GET0257-003A  
[EX/EU]

Thank you for purchasing a JVC product.

Please read all instructions carefully before operation, to ensure your complete understanding and to obtain the best possible performance from the unit.

### IMPORTANT FOR LASER PRODUCTS

1. CLASS 1 LASER PRODUCT
2. **CAUTION:** Do not open the top cover. There are no user serviceable parts inside the unit; leave all servicing to qualified service personnel.
3. **CAUTION:** Visible and invisible laser radiation when open and interlock failed or defeated. Avoid direct exposure to beam.
4. REPRODUCTION OF LABEL: CAUTION LABEL, PLACED OUTSIDE THE UNIT.

<b>CAUTION :</b> Visible and invisible laser radiation when open and interlock failed or defeated. AVOID DIRECT EXPOSURE TO BEAM. (e)	<b>ADVARSEL :</b> Synlig og usynlig laserstråling når maskinen er åpen eller interlocken fejler. Undgå direkte eksponering til strålingen. (d)	<b>VARNING :</b> Synlig och osynlig laserstråling när den öppnas och spärren är urkopplad. Beträkta ej strålen. (s)	<b>VARO :</b> Avvattassa ja suojalukitus ohittautuna tai viiväisena ollet antinna näkyvälle ja näkymättömälle lasersäteilylle. Vältä säteeen kohdistumista suoraan itseesi. (f)
---	--	--	---

#### Warning:

If you need to operate the receiver while driving, be sure to look ahead carefully or you may be involved in a traffic accident.

#### How to reset your unit



- This will reset the microcomputer. Your preset adjustments will also be erased.
- If a disc is loaded, it will eject. Be careful not to drop the disc.

#### How to forcibly eject a disc

If a disc cannot be recognized by the receiver or cannot be ejected, ejects the disc as follows.



- If this does not work, try to reset your receiver.
- Be careful not to drop the disc when it ejects.

Note: Only for [EX] model users in UK and European countries

For security reasons, a numbered ID card is provided with this receiver, and the same ID number is imprinted on the receiver's chassis. Keep the card in a safe place, as it will help the authorities to identify your receiver if stolen.

# Contents

How to reset your unit .....	2	<b>Sound adjustments .....</b>	<b>18</b>
How to forcibly eject a disc .....	2	<b>Selecting preset sound modes</b>	
How to read this manual .....	4	<b>(C-EQ: custom equalizer) .....</b>	<b>18</b>
How to use the MODE button .....	4	Adjusting the sound .....	19
<b>Control panel — KD-G411 .....</b>	<b>5</b>	<b>General settings — PSM .....</b>	<b>20</b>
Parts identification .....	5	Basic procedure .....	20
<b>Getting started .....</b>	<b>6</b>	<b>Detaching the control</b>	
<b>Basic operations .....</b>	<b>6</b>	<b>panel .....</b>	<b>22</b>
Canceling the display demonstrations ...	7	<b>Using the remote controller</b>	
Setting the clock .....	7	<b>— RM-RK60 .....</b>	<b>23</b>
<b>Radio operations .....</b>	<b>8</b>	Main elements and features .....	23
<b>Listening to the radio .....</b>	<b>8</b>	<b>Maintenance .....</b>	<b>24</b>
Storing stations in memory .....	9	<b>More about this receiver .....</b>	<b>25</b>
Listening to a preset station .....	9	<b>Troubleshooting .....</b>	<b>27</b>
<b>FM RDS operations .....</b>	<b>10</b>	<b>Specifications .....</b>	<b>29</b>
<b>Searching for your favorite FM RDS</b>			
<b>programme .....</b>	<b>10</b>		
Storing your favorite programmes .....	11		
Using the standby receptions .....	11		
Tracking the same programme			
—Network-Tracking Reception .....	12		
<b>Disc operations .....</b>	<b>13</b>		
<b>Playing a disc .....</b>	<b>13</b>		
Other main functions .....	15		
Changing the display information .....	16		
Selecting the playback modes .....	17		

## \*For safety....

- Do not raise the volume level too much, as this will block outside sounds, making driving dangerous.
- Stop the car before performing any complicated operations.





## \*Temperature inside the car....

If you have parked the car for a long time in hot or cold weather, wait until the temperature in the car becomes normal before operating the unit.

## How to read this manual

The following methods are used to make the explanations simple and easy-to-understand:

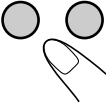
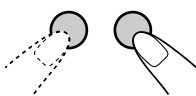
- Some related tips and notes are explained in “More about this receiver” (see page 25).
- Button operations are mainly explained with the illustrations as follows:

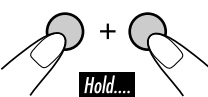
	Press briefly.
	Press repeatedly.
	Press either one.
	
	Press and hold until your desired response begins.
	Press and hold both buttons at the same time.

## How to use the MODE button

If you press MODE, the receiver goes into functions mode, then the number buttons and ▲/▼ buttons work as different function buttons.

Ex.: When number button 2 works as MO (monaural) button.

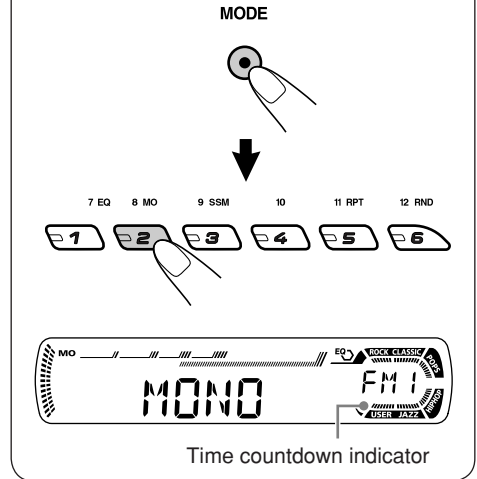

**To use these buttons for original functions again after pressing MODE,** wait for 5 seconds without pressing any of these buttons until the functions mode is cleared.

- Pressing MODE again also clears the functions mode.

## Parts identification

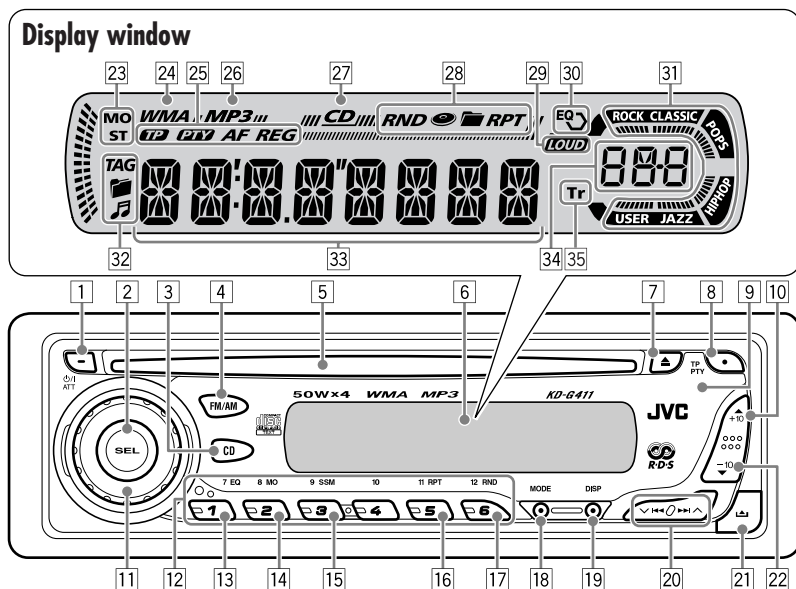

- 1  $\odot$ /I ATT (standby/on attenuator) button
- 2 SEL (select) button
- 3 CD button
- 4 FM/AM button
- 5 Loading slot
- 6 Display window
- 7  $\blacktriangle$  (eject) button
- 8 TP PTY (traffic programme/programme type) button
- 9 Remote sensor
  - You can control this receiver with an optionally purchased remote controller.
  - DO NOT expose the remote sensor to strong light (direct sunlight or artificial lighting).
- 10  $\blacktriangle$  (up) button / +10 button
- 11 Control dial
- 12 Number buttons
- 13 EQ (equalizer) button
- 14 MO (monaural) button
- 15 SSM (Strong-station Sequential Memory) button
- 16 RPT (repeat) button
- 17 RND (random) button
- 18 MODE button
- 19 DISP (display) button

- 20  $\blacktriangledown$   $\ll$   $\lll$   $\ggg$   $\gg$   $\blacktriangle$  buttons
- 21  $\blacktriangle$  (control panel release) button
- 22  $\blacktriangledown$  (down) button / -10 button

### Display window

- 23 Tuner reception indicators—MO (monaural), ST (stereo)
- 24 WMA indicator
- 25 RDS indicators—TP, PTY, AF, REG
- 26 MP3 indicator
- 27 CD indicator
- 28 Playback mode / item indicators—RND (random),  $\odot$  (disc),  $\blacktriangle$  (folder), RPT (repeat)
- 29 LOUD (loudness) indicator
- 30 EQ (equalizer) indicator
- 31 Sound mode (C-EQ: custom equalizer) indicators—ROCK, CLASSIC, POPS, HIP HOP, JAZZ, USER
  - $\text{|||||}$  also works as the time countdown indicator.
- 32 Disc information indicators—TAG (ID3 Tag),  $\blacktriangle$  (folder),  $\text{🎵}$  (track/file)
- 33 Main display
- 34 Source display / Volume level indicator
- 35 Tr (track) indicator

# Getting started

## Basic operations

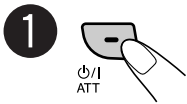
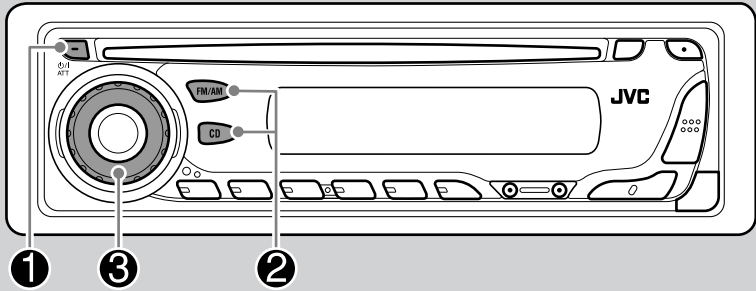

### To drop the volume in a moment (ATT)

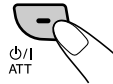

To restore the sound, press it again.

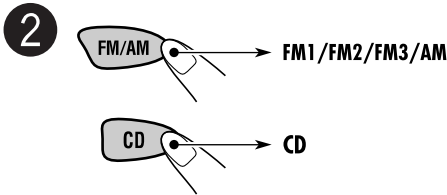

### To turn off the power



You cannot select "CD" as the playback source if there is no disc in the loading slot.

### Caution on volume setting:

Discs produce very little noise compared with other sources. Lower the volume before playing a disc to avoid damaging the speakers by the sudden increase of the output level.

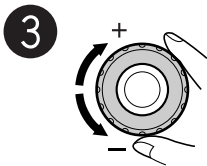

Volume level appears.

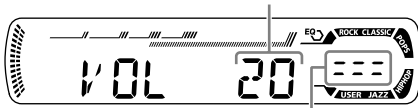

Volume level indicator



## Canceling the display demonstrations

If no operations are done for about 20 seconds, display demonstration starts.

[Initial: DEMO ON]—see page 20.

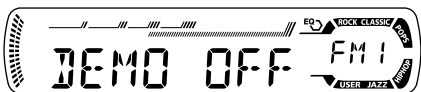
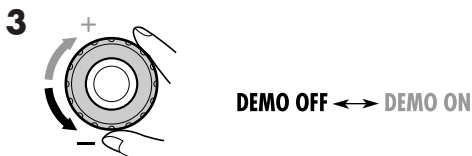
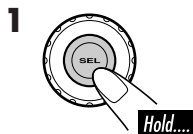

**4** Finish the procedure.



### To activate the display demonstration

In step **3** above...



## Setting the clock

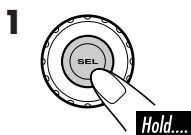

**2** Set the hour, minute, and clock system.

- 1 Select “CLOCK H” (hour), then adjust the hour.
- 2 Select “CLOCK M” (minute), then adjust the minute.
- 3 Select “24H/12H,” then select “24H” (hour) or “12H” (hour).

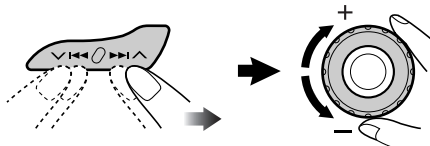

**3** Finish the procedure.



### To check the current clock time when the power is turned off

DISP



# Radio operations

## Listening to the radio

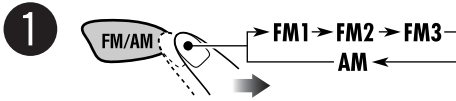
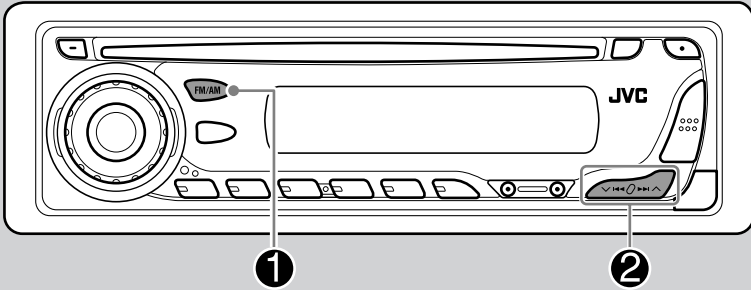

Lights up when receiving an FM stereo broadcast with sufficient signal strength.

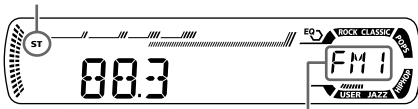

Selected band appears.

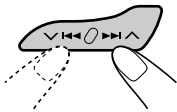

When a station is received, searching stops.

To stop searching, press the same button again.

### To tune in to a station manually

In step 2 above...

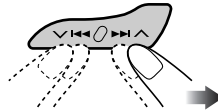
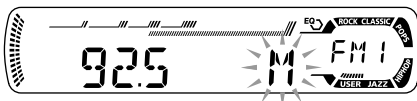
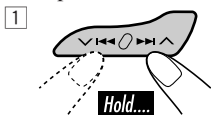

### When an FM stereo broadcast is hard to receive



Lights up when monaural mode is activated.

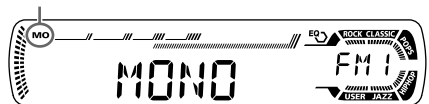

Reception improves, but stereo effect will be lost.

To restore the stereo effect, repeat the same procedure so that the MO indicator goes off.



## Storing stations in memory

You can preset six stations for each band.

### FM station automatic presetting—SSM (Strong-station Sequential Memory)

1 Select the FM band (FM1 – FM3) you want to store into.

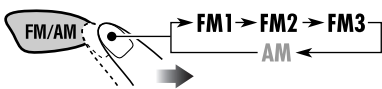

2 MODE



3 9 SSM



“SSM” flashes, then disappears when automatic presetting is over.

Local FM stations with the strongest signals are searched and stored automatically in the FM band.

### Manual presetting

Ex.: Storing FM station of 92.5 MHz into preset number 4 of the FM1 band.



2

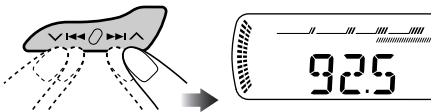

3

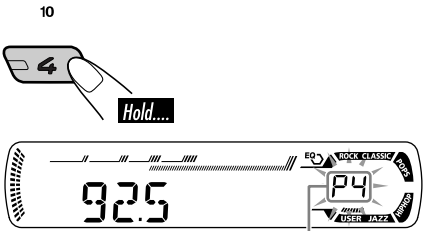

Preset number flashes for a while.

## Listening to a preset station

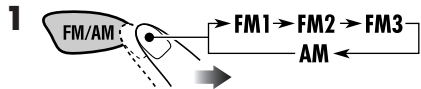

2 Select the preset station (1 – 6) you want.

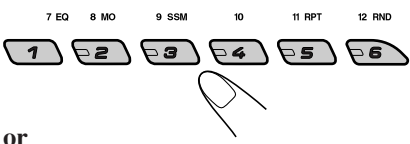

or

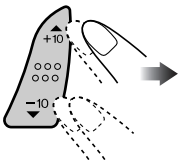

### To check the current clock time while listening to an FM (non-RDS) or AM station

- For FM RDS stations, see page 12.

DISP

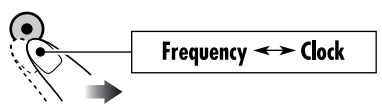

# FM RDS operations

## Searching for your favorite FM RDS programme

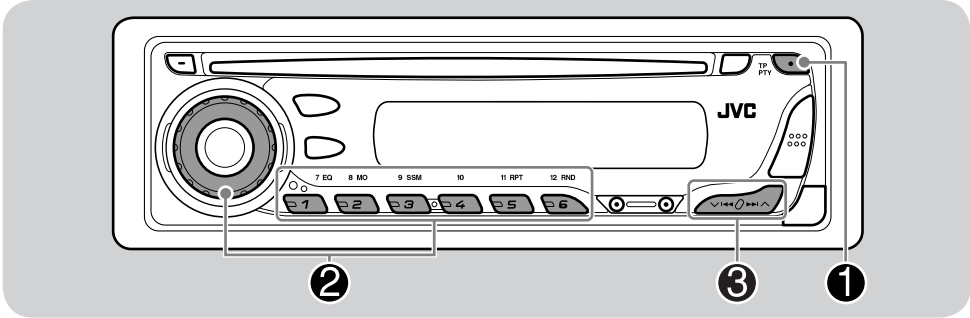

You can tune in to a station broadcasting your favorite programme by searching for a PTY code.

**3** Start searching for your favorite programme.

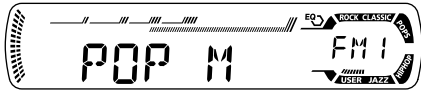
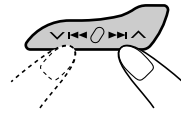
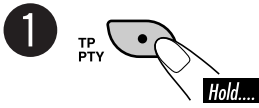

The last selected PTY code appears.

If there is a station broadcasting a programme of the same PTY code as you have selected, that station is tuned in.

**2** Select one of your favorite programme type.

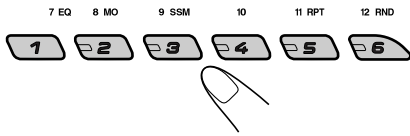

or

Select one of the twenty-nine PTY codes.

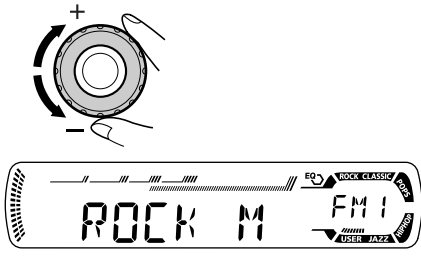

Ex.: When "ROCK M" is selected

**PTY codes**

- NEWS ⇄ AFFAIRS ⇄ INFO ⇄ SPORT ⇄ EDUCATE ⇄ DRAMA ⇄ CULTURE ⇄ SCIENCE ⇄ VARIED ⇄ POP M (music) ⇄ ROCK M (music) ⇄ EASY M (music) ⇄ LIGHT M (music) ⇄ CLASSICS ⇄ OTHER M (music) ⇄ WEATHER ⇄ FINANCE ⇄ CHILDREN ⇄ SOCIAL ⇄ RELIGION ⇄ PHONE IN ⇄ TRAVEL ⇄ LEISURE ⇄ JAZZ ⇄ COUNTRY ⇄ NATION M (music) ⇄ OLDIES ⇄ FOLK M (music) ⇄ DOCUMENT ⇄ OFF ⇄ (back to the beginning)

### What you can do with RDS

RDS (Radio Data System) allows FM stations to send an additional signal along with their regular programme signals. By receiving the RDS data, this receiver can do the following:

- Programme Type (PTY) Search (see page 10)
- Standby Reception of Traffic Announcement —TA (see the following) or your favorite programme (PTY) (see pages 12 and 21)
- Tracing the same programme automatically —Network-Tracking Reception (see page 12)
- Programme Search (see page 21)

**3 Repeat steps 1 and 2 to store other PTY codes into other preset numbers.**

**4 Finish the procedure.**

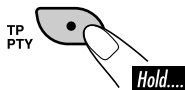

### Using the standby receptions

#### TA Standby Reception

TA Standby Reception allows the receiver to switch temporarily to Traffic Announcement (TA) from any source other than AM. The volume changes to the preset TA volume level (see page 21).

#### To activate TA Standby Reception

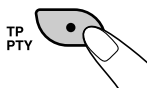

The TP indicator either lights up or flashes.

- If the TP indicator lights up, TA Standby Reception is activated.
- If the TP indicator flashes, TA Standby Reception is not yet activated. (This occurs when you are listening to an FM station without the RDS signals required for TA Standby Reception.)

To activate TA Standby Reception, tune in to another station providing these signals. The TP indicator will stop flashing and remain lit.

#### To deactivate the TA Standby Reception

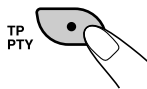

The TP indicator goes off.

### Storing your favorite programmes

You can store six favorite programme types.

Preset programme types in the number buttons (1 – 6):

1	2	3	4	5	6
POP M	ROCK M	EASY M	CLASSICS	AFFAIRS	VARIED

**1 Perform steps 1 and 2 on page 10 to select a PTY code.**

**2 Select the preset number (1 – 6) you want to store into.**

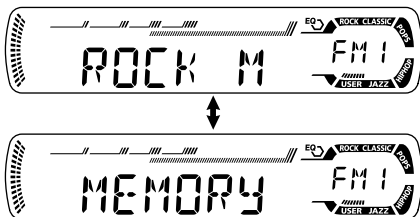
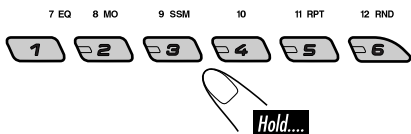

Ex.: When "ROCK M" is selected

## ■ PTY Standby Reception

PTY Standby Reception allows the receiver to switch temporarily to your favorite PTY programme from any source other than AM.

**To activate and select your favorite PTY code for PTY Standby Reception,** see page 21.

The PTY indicator either lights up or flashes.

- If the PTY indicator lights up, PTY Standby Reception is activated.
- If the PTY indicator flashes, PTY Standby Reception is not yet activated.

To activate PTY Standby Reception, tune in to another station providing these signals. The PTY indicator will stop flashing and remain lit.

**To deactivate the PTY Standby Reception,** select "OFF" for the PTY code. The PTY indicator goes off.

## Tracking the same programme— Network-Tracking Reception

When driving in an area where FM reception is not sufficient enough, this receiver automatically tunes in to another FM RDS station of the same network, possibly broadcasting the same programme with stronger signals (see the illustration below).

When shipped from the factory, Network-Tracking Reception is activated.

**To change the Network-Tracking Reception setting,** see page 21.

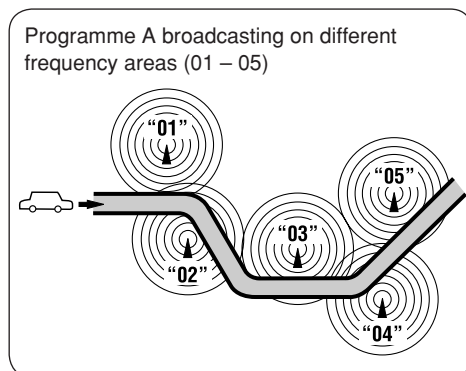

## To check the current clock time while listening to an FM RDS station

DISP

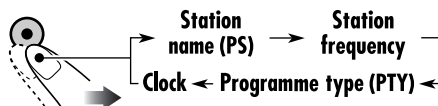

# Disc operations

## Playing a disc

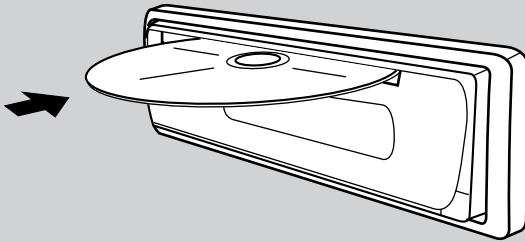

All tracks will be played repeatedly until you stop playback.

### About MP3 and WMA discs

MP3 and WMA (Windows Media® Audio) "tracks" (words "file" and "track" are used interchangeably) are recorded in "folders."

- When inserting an MP3 or a WMA disc:

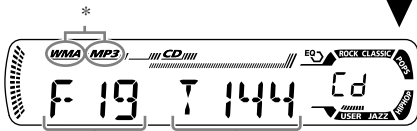
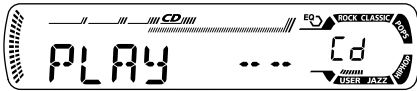

Total folder number

Total file number

When playback starts, disc information will automatically appear (see page 16).

\* Either the MP3 or WMA indicator lights up depending on the first detected file.

- When inserting an audio CD or a CD Text disc:

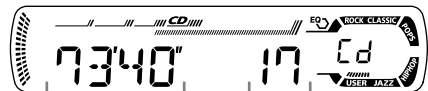

Total playing time of the inserted disc

Total track number of the inserted disc

CD Text: Disc title/performer →  
Track title appear automatically.

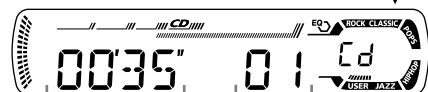

Elapsed playing time

Current track number

### To stop play and eject the disc

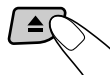

**To fast-forward or reverse the track**

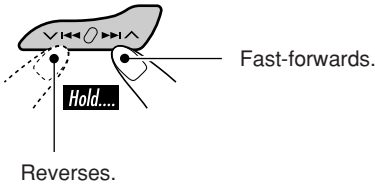

**To go to the next or previous tracks**

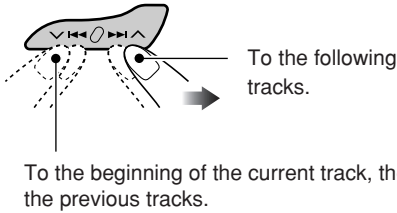

**To go to the next or previous folders (only for MP3 or WMA disc)**

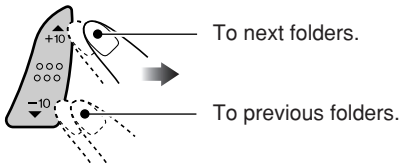

**To locate a particular track (for CD) or folder (for MP3 or WMA discs) directly**

To select a number from 01 – 06:

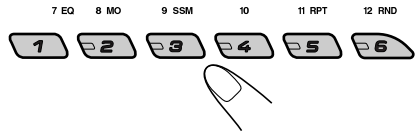

To select a number from 07 – 12:

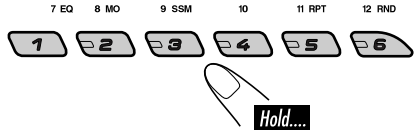

- To select a particular track in a folder (for MP3 or WMA disc) after selecting a folder:

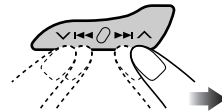

## Other main functions

### ■ Skipping a track quickly during play

- For MP3 or WMA disc, you can skip a track within the same folder.

Ex.: To select track 32 while playing track 6

#### 1 MODE

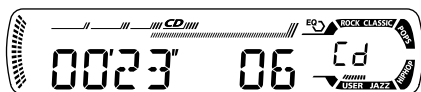

#### 2

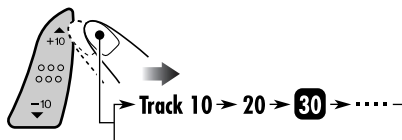

First time you press +10 or -10 button, the track skips to the nearest higher or lower track with a track number of multiple ten (ex. 10th, 20th, 30th).

Then each time you press the button, you can skip 10 tracks.

- After the last track, the first track will be selected and vice versa.

#### 3

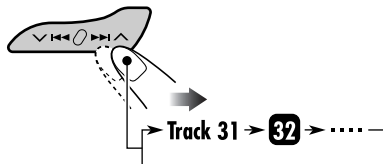

### ■ Prohibiting disc ejection

You can lock a disc in the loading slot.



To cancel the prohibition, repeat the same procedure.



## Changing the display information

DISP

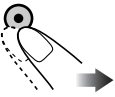

### ■ While playing an audio CD or a CD Text

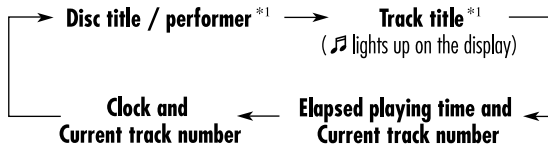

<sup>\*1</sup> If the current disc is an audio CD, “NO NAME” appears.

### ■ While playing an MP3 or WMA disc

- When “TAG DISP” is set to “TAG ON” (see page 21)

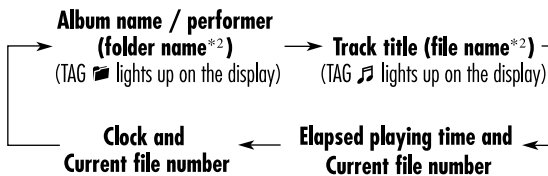

<sup>\*2</sup> If an MP3/WMA file does not have ID3 tags, folder name and file name appear. In this case, the TAG indicator will not light up.

- When “TAG DISP” is set to “TAG OFF”

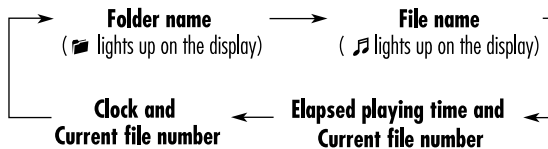



# Selecting the playback modes

You can use only one of the following playback modes at a time.

## 1 MODE



## 2 Select your desired playback mode.

### Repeat play

11 RPT

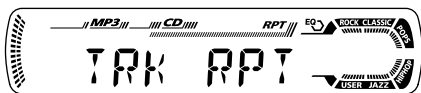

Ex.: When "TRK RPT" is selected while playing an MP3 disc

### Random play

12 RND



Ex.: When "DISC RND" is selected while playing an MP3 disc

Mode	Plays repeatedly
<b>TRK RPT:</b>	The current track. <ul style="list-style-type: none"> <li>• RPT lights up.</li> </ul>
<b>FLDR RPT*:</b>	All tracks of the current folder. <ul style="list-style-type: none"> <li>• [Folder icon] and RPT light up.</li> </ul>
Off:	Cancels repeat play.

Mode	Plays at random
<b>FLDR RND*:</b>	All tracks of the current folder, then tracks of the next folder and so on. <ul style="list-style-type: none"> <li>• RND and [Folder icon] light up.</li> </ul>
<b>DISC RND:</b>	All tracks of the current disc. <ul style="list-style-type: none"> <li>• RND and [Disc icon] light up.</li> </ul>
Off:	Cancels random play.

\* Only while playing an MP3 or WMA disc.

# Sound adjustments

## Selecting preset sound modes (C-EQ: custom equalizer)

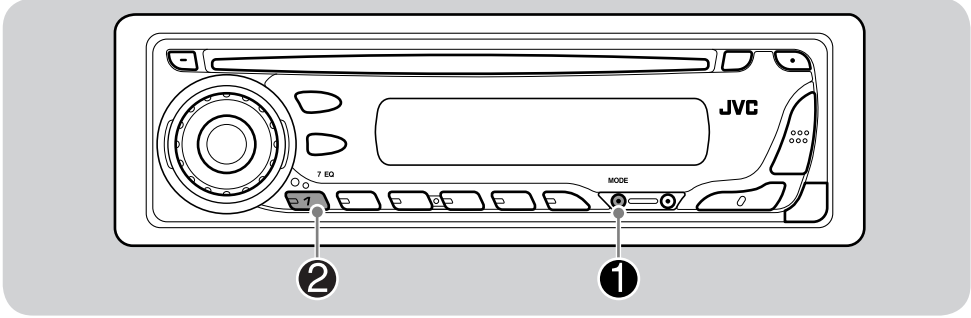

You can select a preset sound mode suitable to the music genre.

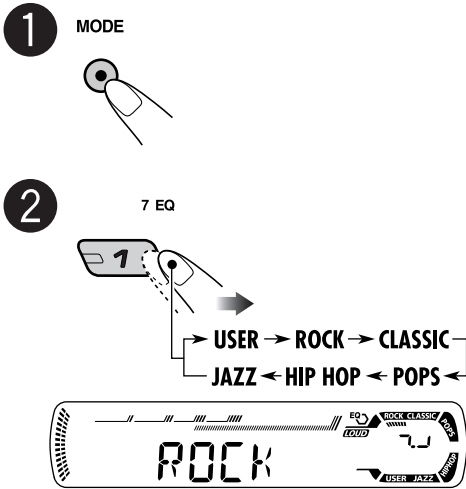

Ex.: When "ROCK" is selected

Indication	For:	Preset values		
		BAS* <sup>1</sup>	TRE* <sup>2</sup>	LOUD* <sup>3</sup>
USER	(Flat sound)	00	00	OFF
ROCK	Rock or disco music	+03	+01	ON
CLASSIC	Classical music	+01	-02	OFF
POPS	Light music	+04	+01	OFF
HIP HOP	Funk or rap music	+02	00	ON
JAZZ	Jazz music	+02	+03	OFF

\*1 BAS: Bass

\*2 TRE: Treble

\*3 LOUD: Loudness

Indication pattern for each sound mode:

USER	ROCK	CLASSIC
JAZZ	HIP HOP	POPS

## Adjusting the sound

You can adjust the sound characteristics to your preference.

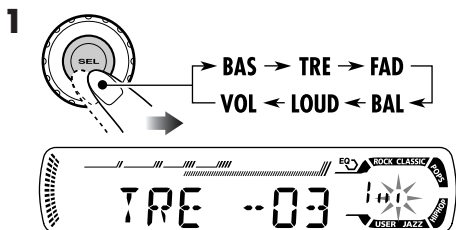

Ex.: When "TRE" is selected

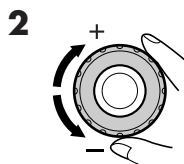

Indication pattern changes as you adjust the level.

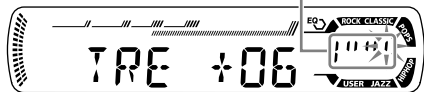

Indication	To do:	Range
BAS*1 (bass)	Adjust the bass.	-06 (min.) to +06 (max.)
TRE*1 (treble)	Adjust the treble.	-06 (min.) to +06 (max.)
FAD*2 (fader)	Adjust the front and rear speaker balance.	R06 (Rear only) to F06 (Front only)
BAL (balance)	Adjust the left and right speaker balance.	L06 (Left only) to R06 (Right only)
LOUD*1 (loudness)	Boost low and high frequencies to produce a well-balanced sound at low volume level.	LOUD ON ↕ LOUD OFF
VOL*3 (volume)	Adjust the volume.	00 (min.) to 30 or 50 (max.)*4

\*1 When you adjust the bass, treble, or loudness, the adjustment you have made is stored for the currently selected sound mode (C-EQ) including "USER."

\*2 If you are using a two-speaker system, set the fader level to "00."

\*3 Normally the control dial works as the volume control. So you do not have to select "VOL" to adjust the volume level.

\*4 Depending on the amplifier gain control setting. (See page 21 for details.)

# General settings — PSM

## Basic procedure

You can change PSM (Preferred Setting Mode) items listed in the table that follows.

1

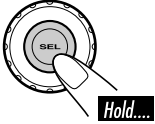

2 Select a PSM item.

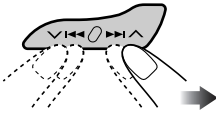

Ex.: When you select "DIMMER"

3 Adjust the PSM item selected.

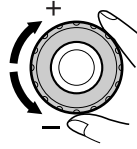

4 Repeat steps 2 and 3 to adjust the other PSM items if necessary.

5 Finish the procedure.



### Indications

### Selectable settings, [reference page]

#### DEMO

Display demonstration

**DEMO ON:** [Initial]; Display demonstration will be activated automatically if no operation is done for about 20 seconds, [7].

**DEMO OFF:** Cancels.

#### CLOCK H

Hour adjustment

0 – 23 (1 – 12), [7]

[Initial: 0 (0:00)]

#### CLOCK M

Minute adjustment

00 – 59, [7]

[Initial: 00 (0:00)]

#### 24H/12H

24 hours or 12 hours time display

12H  $\rightleftharpoons$  24H, [7]

[Initial: 24H]

#### CLK ADJ

Clock adjustment

**AUTO:** [Initial]; The built-in clock is automatically adjusted using the CT (clock time) data in the RDS signal.

**OFF:** Cancels.

Indications	Selectable settings, [reference page]
<b>AF-REG</b> Alternative frequency/ regionalization reception	When the received signals from the current station become weak... <b>AF:</b> <i>[Initial]</i> ; Switches to another station (the programme may differ from the one currently received), [12]. <ul style="list-style-type: none"> <li>• The AF indicator lights up.</li> </ul> <b>AF REG:</b> Switches to another station broadcasting the same programme. <ul style="list-style-type: none"> <li>• The AF and REG indicators light up.</li> </ul> <b>OFF:</b> Cancels.
<b>PTY STBY</b> PTY standby	<i>[Initial: OFF]</i> ; Activates PTY Standby Reception with one of the 29 PTY codes, [12].
<b>TA VOL</b> Traffic announcement volume	<i>[Initial: VOL 20]</i> ; VOL 00 – VOL 30 or 50*, [11] * <i>Depends on the amplifier gain control.</i>
<b>P-SEARCH</b> Programme search	<b>ON:</b> Using the AF data, the receiver tunes in to another frequency broadcasting the same programme as the original preset RDS station is if the preset station signals are not sufficient.  <b>OFF:</b> <i>[Initial]</i> ; Cancels.
<b>DIMMER</b> Dimmer	<b>ON:</b> Activates dimmer. <b>OFF:</b> <i>[Initial]</i> ; Cancels.
<b>TEL</b> Telephone muting	<b>MUTING 1/MUTING 2:</b> Select either one which mutes the sounds while using the cellular phone.  <b>OFF:</b> <i>[Initial]</i> ; Cancels.
<b>SCROLL</b> Scroll	<b>ONCE:</b> <i>[Initial]</i> ; Scrolls the disc information once. <b>AUTO:</b> Repeats scrolling (5-second intervals in between). <b>OFF:</b> Cancels. <ul style="list-style-type: none"> <li>• Pressing DISP for more than one second can scrolls the display regardless of the setting.</li> </ul>
<b>TAG DISP</b> Tag display	<b>TAG ON:</b> <i>[Initial]</i> ; Shows the ID3 tag while playing MP3/WMA tracks, [16]. <b>TAG OFF:</b> Cancels.
<b>AMP GAIN</b> Amplifier gain control	You can change the maximum volume level of this receiver. <b>LOW PWR:</b> VOL 00 – VOL 30 (Select this if the maximum power of the speaker is less than 50 W to prevent them from damaging the speaker.) <b>HIGH PWR:</b> <i>[Initial]</i> ; VOL 00 – VOL 50

# Detaching the control panel

When detaching or attaching the control panel, be careful not to damage the connectors on the back of the control panel and on the panel holder.

## ■ Detaching the control panel

Before detaching the control panel, be sure to turn off the power.

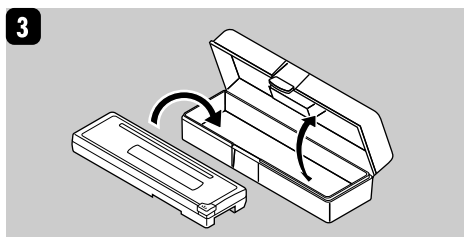
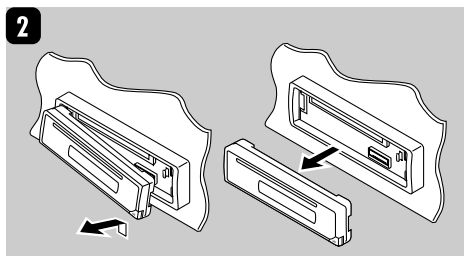
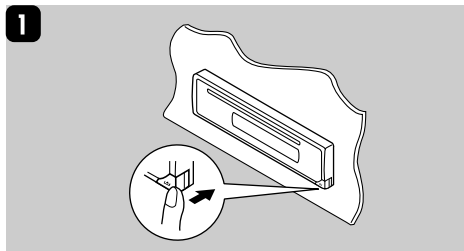

## ■ Attaching the control panel

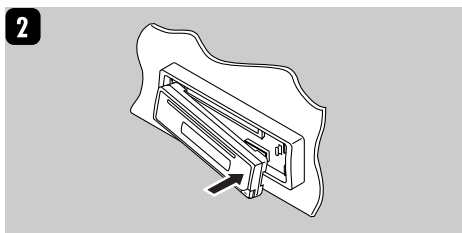
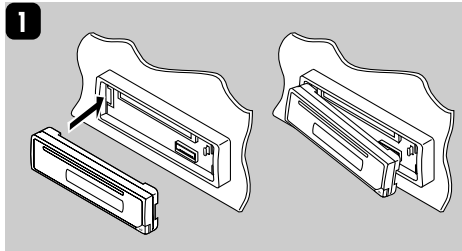

# Using the remote controller — RM-RK60

This receiver can be remotely controlled as instructed here (with an optionally purchased remote controller). We recommend that you use remote controller RM-RK60 with your receiver.

- When operating, aim the remote controller directly at the remote sensor on the receiver. Make sure there is no obstacle in between.

## ■ Installing the lithium coin battery (CR2025)

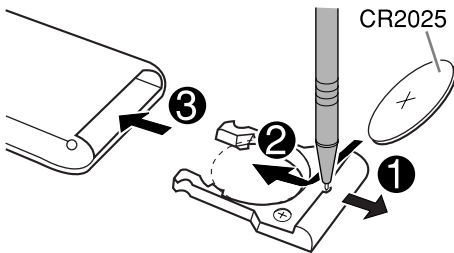

### Warning:

- Store the battery in a place where children cannot reach to avoid risk of accident.
- To prevent the battery from over-heating, cracking, or starting a fire:
  - Do not recharge, short, disassemble, or heat the battery or dispose of it in a fire.
  - Do not leave the battery with other metallic materials.
  - Do not poke the battery with tweezers or similar tools.
  - Wrap the battery with tape and insulate when throwing away or saving it.

### Caution:

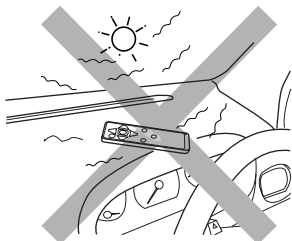

## Main elements and features

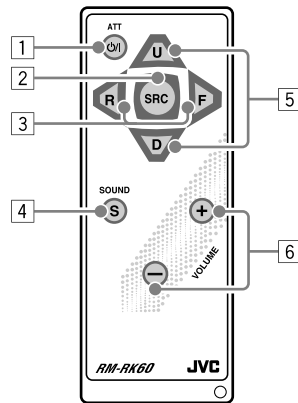

- 1 **⏻/ATT** (standby/on attenuator) button
  - Turns on and off the power and also attenuates the sound.
- 2 **SRC** (source) button
  - Selects the source.
- 3 **R** (reverse) / **F** (forward) buttons
  - Searches for stations if pressed briefly.
  - Fast-forwards or reverses the track if pressed and held.
  - Changes the tracks on the disc.
- 4 **SOUND** button
  - Selects the sound mode (C-EQ: custom equalizer).
- 5 **U** (up) / **D** (down) buttons
  - U (up): Changes the FM/AM bands.
  - D (down): Changes the preset stations.
  - Changes the folder on the MP3/WMA discs.
- 6 **VOLUME +/-** buttons
  - Adjusts the volume level.

The receiver is equipped with the steering wheel remote control function.

- See the Installation/Connection Manual (separate volume) for connection.

# Maintenance

## How to clean the connectors

Frequent detachment will deteriorate the connectors.

To minimize this possibility, periodically wipe the connectors with a cotton swab or cloth moistened with alcohol, being careful not to damage the connectors.

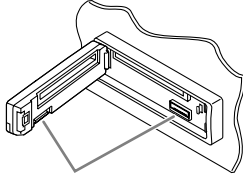

Connector

## Moisture condensation

Moisture may condense on the lens inside the CD player in the following cases:

- After starting the heater in the car.
- If it becomes very humid inside the car.

Should this occur, the CD player may malfunction. In this case, eject the disc and leave the receiver turned on for a few hours until the moisture evaporates.

## How to handle discs

**When removing a disc from its case,** press down the center holder of the case and lift the disc out, holding it by the edges.

Center holder



- Always hold the disc by the edges. Do not touch its recording surface.

**When storing a disc into its case,** gently insert the disc around the center holder (with the printed surface facing up).

- Make sure to store discs into the cases after use.

## To keep discs clean

A dirty disc may not play correctly. If a disc does become dirty, wipe it with a soft cloth in a straight line from center to edge.



- Do not use any solvent (for example, conventional record cleaner, spray, thinner, benzine, etc.) to clean discs.

## To play new discs

New discs may have some rough spots around the inner and outer edges. If such a disc is used, this receiver may reject the disc.



To remove these rough spots, rub the edges with a pencil or ball-point pen, etc.

### Do not use the following discs:

Warped disc



Sticker



Sticker residue

Disc



Stick-on label



# More about this receiver

## Basic operations

### Turning off the power

- If you turn off the power while listening to a disc, disc play will start from where playback has been stopped previously, next time you turn on the power.

## Tuner operations

### Storing stations in memory

- During SSM search...
  - All previously stored stations are erased and stations are stored newly.
  - Received stations are preset in No. 1 (lowest frequency) to No. 6 (highest frequency).
  - When SSM is over, the station stored in No. 1 will be automatically tuned in.
- When storing a station manually, a previously preset station is erased when a new station is stored in the same preset number.

## FM RDS operations

- Network-Tracking Reception requires two types of RDS signals—PI (Programme Identification) and AF (Alternative Frequency) to work correctly. Without receiving these data correctly, Network-Tracking Reception will not operate.
- If a Traffic Announcement is received, the volume level (TA Volume) automatically changes to the preset level.

## Disc operations

### General

- This receiver has been designed to reproduce CDs/CD Texts, and CD-Rs (Recordable)/CD-RWs (Rewritable) in audio CD (CD-DA), MP3 and WMA format.
- When a disc has been loaded, selecting “CD” for the playback source starts disc play.

### Inserting a disc

- When a disc is inserted upside down, the disc automatically ejects.
- Do not insert 8 cm discs (single CD) and unusual shape discs (heart, flower, etc.) into the loading slot.

### Playing a disc

- While fast-forwarding or reversing on an MP3 or WMA disc, you can only hear intermittent sounds.

### Playing a CD-R or CD-RW

- Use only “finalized” CD-Rs or CD-RWs.
- This receiver can play back only the files of the same type which is first detected if a disc includes both audio CD (CD-DA) files and MP3/WMA files.
- This receiver can play back multi-session discs; however, unclosed sessions will be skipped while playing.
- Some CD-Rs or CD-RWs may not play back on this receiver because of their disc characteristics, and for the following causes:
  - Discs are dirty or scratched.
  - Moisture condensation occurs on the lens inside the receiver.
  - The pickup lens inside the receiver is dirty.
  - CD-R/CD-RW on which the files are written with “Packet Write” method.
  - There are improper recording conditions (missing data, etc.) or media conditions (stain, scratch, warp, etc.).
- CD-RWs may require a longer readout time since the reflectance of CD-RWs is lower than that of regular CDs.
- Do not use the following CD-Rs or CD-RWs:
  - Discs with stickers, labels, or protective seal stuck to the surface.
  - Discs on which labels can be directly printed by an ink jet printer.Using these discs under high temperatures or high humidity may cause malfunctions or damage to discs.

## Playing an MP3/WMA disc

- This receiver can play back MP3/WMA files with the extension code <.mp3> or <.wma> (regardless of the letter case—upper/lower).
- This receiver can show the names of albums, artists (performer), and ID3 Tag (Version 1.0, 1.1, 2.2, 2.3, or 2.4) for MP3 files and for WMA files.
- This receiver can handle only one-byte characters. No other characters can be correctly displayed.
- This receiver can play back MP3/WMA files meeting the conditions below:
  - Bit rate: 8 kbps — 320 kbps
  - Sampling frequency:
    - 48 kHz, 44.1 kHz, 32 kHz (for MPEG-1)
    - 24 kHz, 22.05 kHz, 16 kHz (for MPEG-2)
  - Disc format: ISO 9660 Level 1/ Level 2, Romeo, Joliet, Windows long file name
- The maximum number of characters for file/folder names vary among the disc format used (includes 4 extension characters—<.mp3> or <.wma>).
  - ISO 9660 Level 1: up to 12 characters
  - ISO 9660 Level 2: up to 31 characters
  - Romeo\*: up to 128 (72) characters
  - Joliet\*: up to 64 (36) characters
  - Windows long file name\*: up to 128 (72) characters

\* *The parenthesis figure is the maximum number of characters for file/folder names in case the total number of files and folders is 313 or more.*
- This receiver can recognize the total of 512 files, of 200 folders, and of 8 hierarchies.
- This receiver can play back the files recorded in VBR (variable bit rate).  
The files recorded in VBR have a discrepancy in elapsed time display, and do not show the actual elapsed time. Especially, after performing the search function, this difference becomes noticeable.

- This receiver cannot play back the following files:
  - MP3 files encoded with MP3i and MP3 PRO formats.
  - MP3 files encoded in an unappropriated format.
  - MP3 files encoded with Layer 1/2.
  - WMA files encoded with lossless, professional, and voice formats.
  - WMA files which are not based upon Windows Media® Audio.
  - WMA formatted files copy-protected with DRM.
  - Files which have the data such as WAVE, ATRAC3, etc.
- The search function works but search speed is not constant.

## Changing the source

- If you change the source, playback also stops (without ejecting the disc).  
Next time you select “CD” for the playback source, disc play starts from where it has been stopped previously.

## Ejecting a disc

- If the ejected disc is not removed within 15 seconds, the disc is automatically inserted again into the loading slot to prevent it from dust. (Disc will not play this time.)

## General settings—PSM

- If you change the “AMP GAIN” setting from “HIGH PWR” to “LOW PWR” while the volume level is set higher than “VOL 30,” the receiver automatically changes the volume level to “VOL 30.”

# Troubleshooting

What appears to be trouble is not always serious. Check the following points before calling a service center.

	Symptoms	Causes	Remedies
General	<ul style="list-style-type: none"> <li>• Sound cannot be heard from the speakers.</li> </ul>	The volume level is set to the minimum level.	Adjust it to the optimum level.
		Connections are incorrect.	Check the cords and connections.
	<ul style="list-style-type: none"> <li>• The receiver does not work at all.</li> </ul>	The built-in microcomputer may have functioned incorrectly due to noise, etc.	Reset the receiver (see page 2).
FM/AM	<ul style="list-style-type: none"> <li>• SSM automatic presetting does not work.</li> </ul>	Signals are too weak.	Store stations manually.
	<ul style="list-style-type: none"> <li>• Static noise while listening to the radio.</li> </ul>	The aerial is not connected firmly.	Connect the aerial firmly.
Disc playback	<ul style="list-style-type: none"> <li>• Disc automatically ejects.</li> </ul>	Disc is inserted upside down.	Insert the disc correctly.
	<ul style="list-style-type: none"> <li>• CD-R/CD-RW cannot be played back.</li> <li>• Tracks on the CD-R/CD-RW cannot be skipped.</li> </ul>	CD-R/CD-RW is not finalized.	<ul style="list-style-type: none"> <li>• Insert a finalized CD-R/CD-RW.</li> <li>• Finalize the CD-R/CD-RW with the component which you used for recording.</li> </ul>
		<ul style="list-style-type: none"> <li>• Disc can be neither played back nor ejected.</li> </ul>	Disc is locked.
	The CD player may have functioned incorrectly.		Eject the disc forcibly (see page 2).
	<ul style="list-style-type: none"> <li>• Disc sound is sometimes interrupted.</li> </ul>	You are driving on rough roads.	Stop playback while driving on rough roads.
		Disc is scratched.	Change the disc.
		Connections are incorrect.	Check the cords and connections.
	<ul style="list-style-type: none"> <li>• "NO DISC" appears on the display.</li> </ul>	No disc in the loading slot.	Insert a disc into the loading slot.
Disc is inserted incorrectly.		Insert the disc correctly.	

	Symptoms	Causes	Remedies
MP3/WMA playback	<ul style="list-style-type: none"> <li>Disc cannot be played back.</li> </ul>	No MP3/WMA tracks are recorded on the disc.	Change the disc.
		MP3/WMA tracks do not have the extension code <.mp3> or <.wma> in their file names.	Add the extension code <.mp3> or <.wma> to their file names.
		MP3/WMA tracks are not recorded in the format compliant with ISO 9660 Level 1, Level 2, Romeo, or Joliet.	Change the disc. (Record MP3/WMA tracks using a compliant application.)
	<ul style="list-style-type: none"> <li>Noise is generated.</li> </ul>	The track played back is not an MP3/WMA track (although it has the extension code <.mp3> or <.wma>).	Skip to another track or change the disc. (Do not add the extension code <.mp3> or <.wma> to non-MP3 or WMA tracks.)
	<ul style="list-style-type: none"> <li>A longer readout time is required (“CHECK” keeps flashing on the display).</li> </ul>	Readout time varies due to the complexity of the folder/file configuration.	Do not use too many hierarchies and folders.
	<ul style="list-style-type: none"> <li>Tracks cannot be played back as you have intended them to play.</li> </ul>	Playback order is determined when the files are recorded.	_____
	<ul style="list-style-type: none"> <li>Elapsed playing time is not correct.</li> </ul>	This sometimes occurs during play. This is caused by how the tracks are recorded on the disc.	_____
	<ul style="list-style-type: none"> <li>“NO FILES” appears on the display.</li> </ul>	The current disc does not contain any MP3/WMA tracks.	Insert a disc that contains MP3/WMA tracks.
<ul style="list-style-type: none"> <li>Correct characters are not displayed (e.g. album name).</li> </ul>	This receiver can only display alphabets (capital: A – Z), numbers, and a limited number of symbols.	_____	

# Specifications

## AUDIO AMPLIFIER SECTION

Maximum Power Output:

Front: 50 W per channel

Rear: 50 W per channel

Continuous Power Output (RMS):

Front: 19 W per channel into 4  $\Omega$ , 40 Hz to 20 000 Hz at no more than 0.8% total harmonic distortion.

Rear: 19 W per channel into 4  $\Omega$ , 40 Hz to 20 000 Hz at no more than 0.8% total harmonic distortion.

Load Impedance: 4  $\Omega$  (4  $\Omega$  to 8  $\Omega$  allowance)

Tone Control Range:

Bass:  $\pm 10$  dB at 100 Hz

Treble:  $\pm 10$  dB at 10 kHz

Frequency Response: 40 Hz to 20 000 Hz

Signal-to-Noise Ratio: 70 dB

Line-Out Level/Impedance:

2.5 V/20 k $\Omega$  load (full scale)

Output Impedance: 1 k $\Omega$

## TUNER SECTION

Frequency Range:

FM: 87.5 MHz to 108.0 MHz

AM: (MW) 522 kHz to 1 620 kHz  
(LW) 144 kHz to 279 kHz

### [FM Tuner]

Usable Sensitivity: 11.3 dBf (1.0  $\mu$ V/75  $\Omega$ )

50 dB Quieting Sensitivity:

16.3 dBf (1.8  $\mu$ V/75  $\Omega$ )

Alternate Channel Selectivity (400 kHz): 65 dB

Frequency Response: 40 Hz to 15 000 Hz

Stereo Separation: 30 dB

Capture Ratio: 1.5 dB

### [MW Tuner]

Sensitivity: 20  $\mu$ V

Selectivity: 35 dB

### [LW Tuner]

Sensitivity: 50  $\mu$ V

## CD PLAYER SECTION

Type: Compact disc player

Signal Detection System: Non-contact optical pickup (semiconductor laser)

Number of channels: 2 channels (stereo)

Frequency Response: 5 Hz to 20 000 Hz

Dynamic Range: 96 dB

Signal-to-Noise Ratio: 98 dB

Wow and Flutter: Less than measurable limit

MP3 decoding format:

MPEG1/2 Audio Layer 3

Max. Bit Rate: 320 Kbps

WMA (Windows Media® Audio) decoding format:

Max. Bit Rate: 192 Kbps

## GENERAL

Power Requirement:

Operating Voltage:

DC 14.4 V (11 V to 16 V allowance)

Grounding System: Negative ground

Allowable Operating Temperature:

0°C to +40°C

Dimensions (W  $\times$  H  $\times$  D):

Installation Size (approx.):

182 mm  $\times$  52 mm  $\times$  150 mm

Panel Size (approx.):

188 mm  $\times$  58 mm  $\times$  11 mm

Mass (approx.):

1.3 kg (excluding accessories)

*Design and specifications are subject to change without notice.*

- Microsoft and Windows Media are either registered trademarks or trademarks of Microsoft Corporation in the United States and/or other countries.



**Having TROUBLE with operation?**

**Please reset your unit**

**Refer to page of How to reset your unit**

**Vous avez des PROBLÈMES de fonctionnement?**

**Réinitialisez votre appareil**

**Référez-vous à la page intitulée Comment réinitialiser votre appareil**

**JVC**



EN, FR

© 2004 Victor Company of Japan, Limited

1004DTSMDTJEIN

# JVC KD-G41 1

## Installation/Connection Manual Manuel d'installation/raccordement

GET0257-010A  
[EX/EU]

1004DTSMDTJEIN  
EN, FR

### ENGLISH

This receiver is designed to operate on **12 V DC, NEGATIVE ground electrical systems**. If your vehicle does not have this system, a voltage inverter is required, which can be purchased at JVC IN-CAR ENTERTAINMENT dealers.

#### Parts list for installation and connection

The following parts are provided for this receiver. After checking them, please set them correctly.

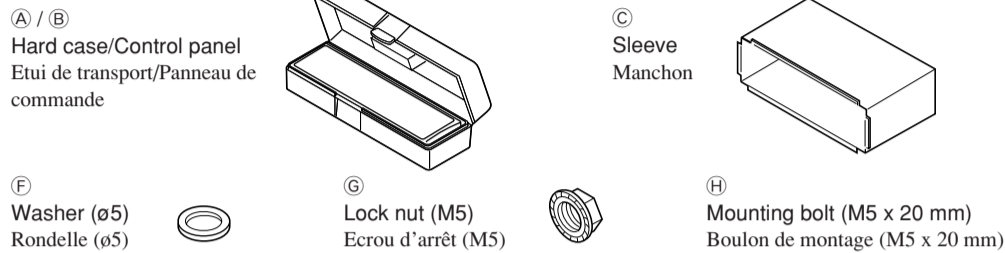

### FRANÇAIS

Cet appareil est conçu pour fonctionner sur des sources de courant continu de **12 V à masse NEGATIVE**. Si votre véhicule n'offre pas ce type d'alimentation, il vous faut un convertisseur de tension, que vous pouvez acheter chez un revendeur d'autoradios JVC.

#### Liste des pièces pour l'installation et raccordement

Les pièces suivantes sont fournies avec cet appareil. Après vérification, veuillez les placer correctement.

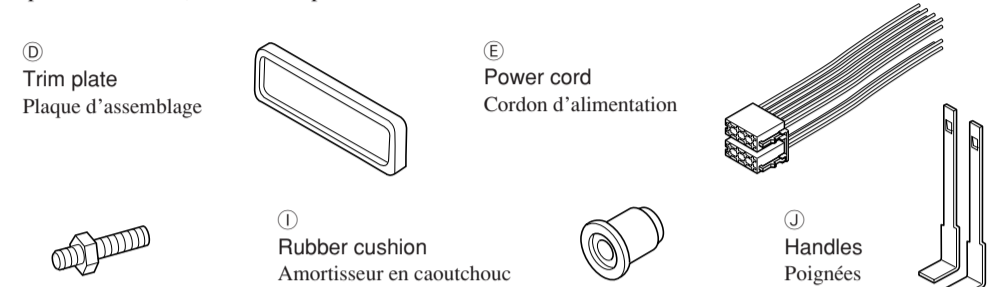

## INSTALLATION (IN-DASH MOUNTING)

The following illustration shows a typical installation. If you have any questions or require information regarding installation kits, consult your JVC IN-CAR ENTERTAINMENT dealer or a company supplying kits.

• If you are not sure how to install this receiver correctly, have it installed by a qualified technician.

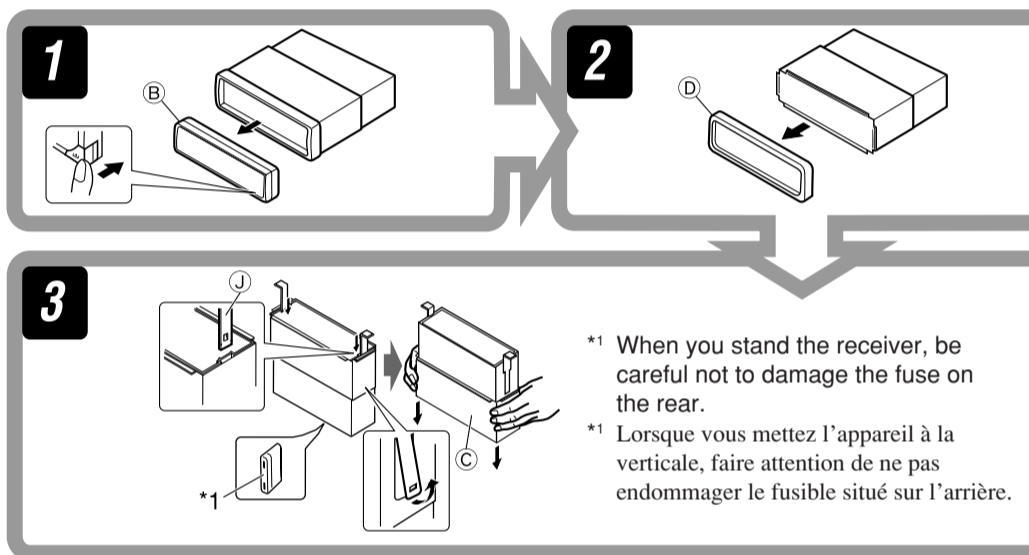

## INSTALLATION (MONTAGE DANS LE TABLEAU DE BORD)

L'illustration suivante est un exemple d'installation typique. Si vous avez des questions ou avez besoin d'information sur des kits d'installation, consultez votre revendeur d'autoradios JVC ou une compagnie d'approvisionnement.

• Si l'on n'est pas sûr de pouvoir installer correctement cet appareil, le faire installer par un technicien qualifié.

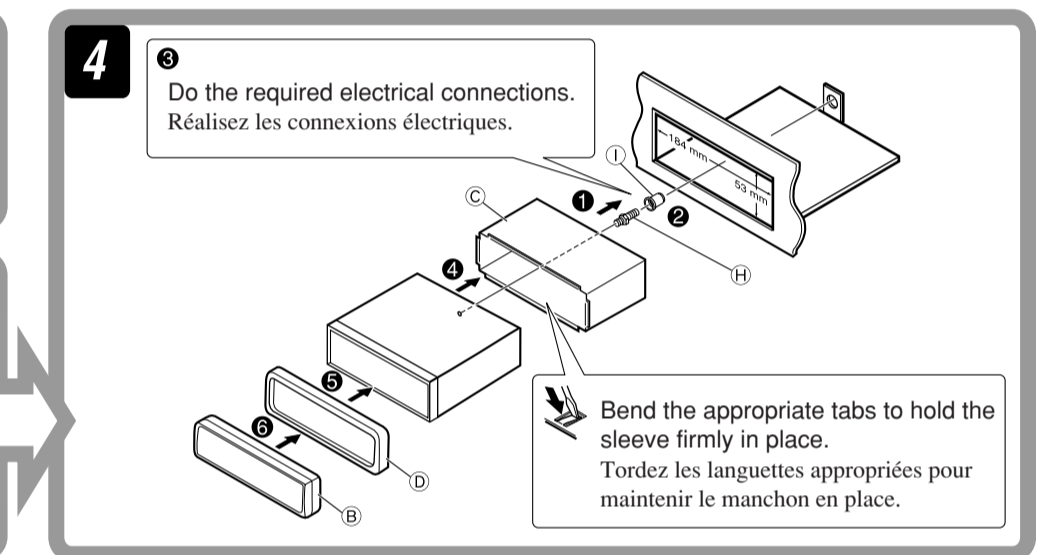

### Removing the receiver / Retrait de l'appareil

Before removing the receiver, release the rear section.

Avant de retirer l'appareil, libérer la section arrière.

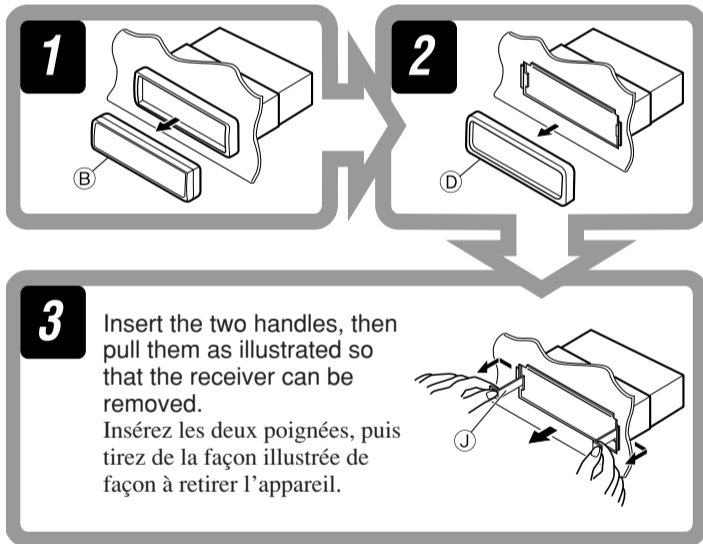

### When using the optional stay / Lors de l'utilisation du hauban en option

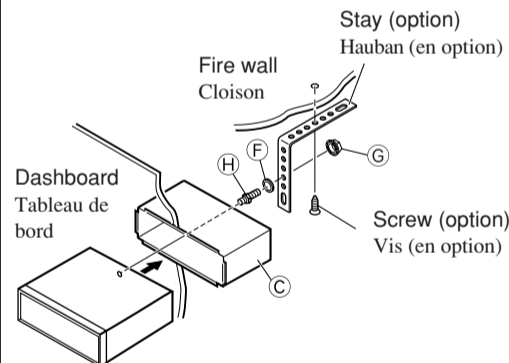

Install the receiver at an angle of less than 30°.  
Installez l'appareil avec un angle de moins de 30°.

### When installing the receiver without using the sleeve / Lors de l'installation de l'appareil sans utiliser de manchon

In a Toyota for example, first remove the car radio and install the receiver in its place.  
Par exemple dans une Toyota, retirer d'abord l'autoradio et installer l'appareil à la place.

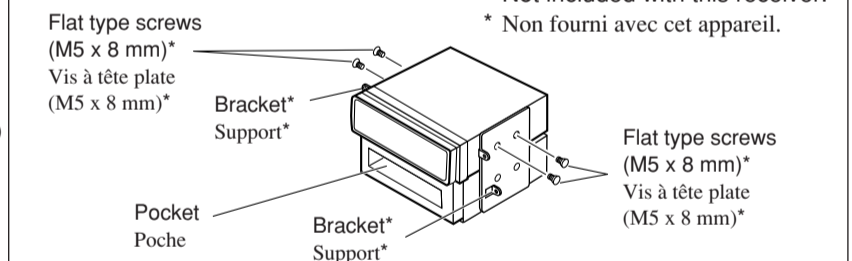

**Note** : When installing the receiver on the mounting bracket, make sure to use the 8 mm-long screws. If longer screws are used, they could damage the receiver.  
**Remarque** : Lors de l'installation de l'appareil sur le support de montage, s'assurer d'utiliser des vis d'une longueur de 8 mm. Si des vis plus longues sont utilisées, elles peuvent endommager l'appareil.

### PRECAUTIONS on power supply and speaker connections:

- **DO NOT** connect the speaker leads of the power cord to the car battery; otherwise, the receiver will be seriously damaged.
- **BEFORE** connecting the speaker leads of the power cord to the speakers, check the speaker wiring in your car.

### PRECAUTIONS sur l'alimentation et la connexion des enceintes:

- **NE CONNECTEZ PAS** les fils d'enceintes du cordon d'alimentation à la batterie; sinon, l'appareil serait sérieusement endommagé.
- **AVANT** de connecter les fils d'enceintes du cordon d'alimentation aux enceintes, vérifiez le câblage des enceintes de votre voiture.

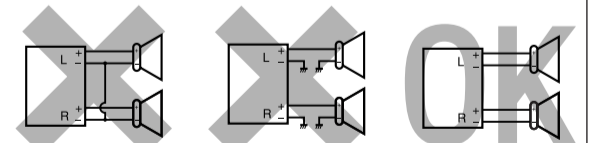

## TROUBLESHOOTING

- **The fuse blows.**  
\* Are the red and black leads connected correctly?
- **Power cannot be turned on.**  
\* Is the yellow lead connected?
- **No sound from the speakers.**  
\* Is the speaker output lead short-circuited?
- **Sound is distorted.**  
\* Is the speaker output lead grounded?  
\* Are the "-" terminals of L and R speakers grounded in common?
- **Noise interferes with sounds.**  
\* Is the rear ground terminal connected to the car's chassis using shorter and thicker cords?
- **Receiver becomes hot.**  
\* Is the speaker output lead grounded?  
\* Are the "-" terminals of L and R speakers grounded in common?
- **This receiver does not work at all.**  
\* Have you reset your receiver?

## EN CAS DE DIFFICULTES

- **Le fusible saute.**  
\* Les fils rouge et noir sont-ils raccordés correctement?
- **L'appareil ne peut pas être mise sous tension.**  
\* Le fil jaune est-elle raccordée?
- **Pas de son des enceintes.**  
\* Le fil de sortie d'enceinte est-il court-circuité?
- **Le son est déformé.**  
\* Le fil de sortie d'enceinte est-il à la masse?  
\* Les bornes "-" des enceintes gauche et droit sont-elles mises ensemble à la masse?
- **Interférence avec les sons.**  
\* La prise arrière de mise à la terre est-elle connectée au châssis de la voiture avec un cordon court et épais?
- **L'appareil devient chaud.**  
\* Le fil de sortie d'enceinte est-il à la masse?  
\* Les bornes "-" des enceintes gauche et droit sont-elles mises ensemble à la masse?
- **Cet appareil ne fonctionne pas du tout.**  
\* Avez-vous réinitialisé votre appareil?

# ELECTRICAL CONNECTIONS

To prevent short circuits, we recommend that you disconnect the battery's negative terminal and make all electrical connections before installing the receiver.

- Be sure to ground this receiver to the car's chassis again after installation.

**Notes:**

- Replace the fuse with one of the specified rating. If the fuse blows frequently, consult your JVC IN-CAR ENTERTAINMENT dealer.
- It is recommended to connect to the speakers with maximum power of more than 50 W (both at the rear and at the front, with an impedance of 4 Ω to 8 Ω). If the maximum power is less than 50 W, change "AMP GAIN" setting to prevent the speakers from being damaged (see page 21 of the INSTRUCTIONS).
- To prevent short-circuit, cover the terminals of the UNUSED leads with insulating tape.
- The heat sink becomes very hot after use. Be careful not to touch it when removing this receiver.

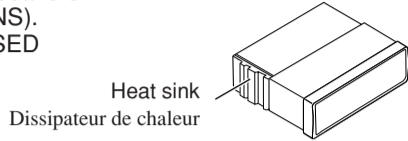

# RACCORDEMENTS ELECTRIQUES

Pour éviter tout court-circuit, nous vous recommandons de débrancher la borne négative de la batterie et d'effectuer tous les raccordements électriques avant d'installer l'appareil.

- Assurez-vous de raccorder de nouveau la mise à la masse de cet appareil au châssis de la voiture après l'installation.

**Remarques:**

- Remplacer le fusible par un de la valeur précisée. Si le fusible saute souvent, consulter votre revendeur d'autoradios JVC.
- Il est recommandé de connecter des enceintes avec une puissance de plus de 50 W (les enceintes arrière et les enceintes avant, avec une impédance comprise entre 4 Ω et 8 Ω). Si la puissance maximum est inférieure à 50 W, changez "AMP GAIN" pour éviter d'endommager vos enceintes (voir page 21 du MANUEL D'INSTRUCTIONS).
- Pour éviter les court-circuits, couvrir les bornes des fils qui ne sont PAS UTILISÉS avec de la bande isolante.
- Le dissipateur de chaleur devient très chaud après usage. Faire attention de ne pas le toucher en retirant cet appareil.

## A Typical connections / Raccordements typiques

**Before connecting:** Check the wiring in the vehicle carefully. Incorrect connection may cause serious damage to this receiver. The leads of the power cord and those of the connector from the car body may be different in color.

- 1 Connect the colored leads of the power cord in the order specified in the illustration below.
- 2 Connect the aerial cord.
- 3 Finally connect the wiring harness to the receiver.

**Note:** If your vehicle does not have any accessory terminal, move the fuse from the fuse position 1 (initial position) to fuse position 2, and connect the red lead (A7) to the positive (+) battery terminal.

- The yellow lead (A4) is not used in this case.

**Avant de commencer la connexion:** Vérifiez attentivement le câblage du véhicule. Une connexion incorrecte peut endommager sérieusement l'appareil.

Le fil du cordon d'alimentation et ceux des connecteurs du châssis de la voiture peuvent être différents en couleur.

- 1 Connectez les fils colorés du cordon d'alimentation dans l'ordre spécifié sur l'illustration ci-dessous.
- 2 Connectez le cordon d'antenne.
- 3 Finalement, connectez le faisceau de fils à l'appareil.

**Remarque:** Si votre véhicule ne possède pas de borne accessoire, déplacez le fusible de la position de fusible 1 (position originale) à la position de fusible 2 et connectez le fil rouge (A7) à la borne positive (+) de la batterie.

- Le fil jaune (A4) n'est pas utilisé dans ce cas.

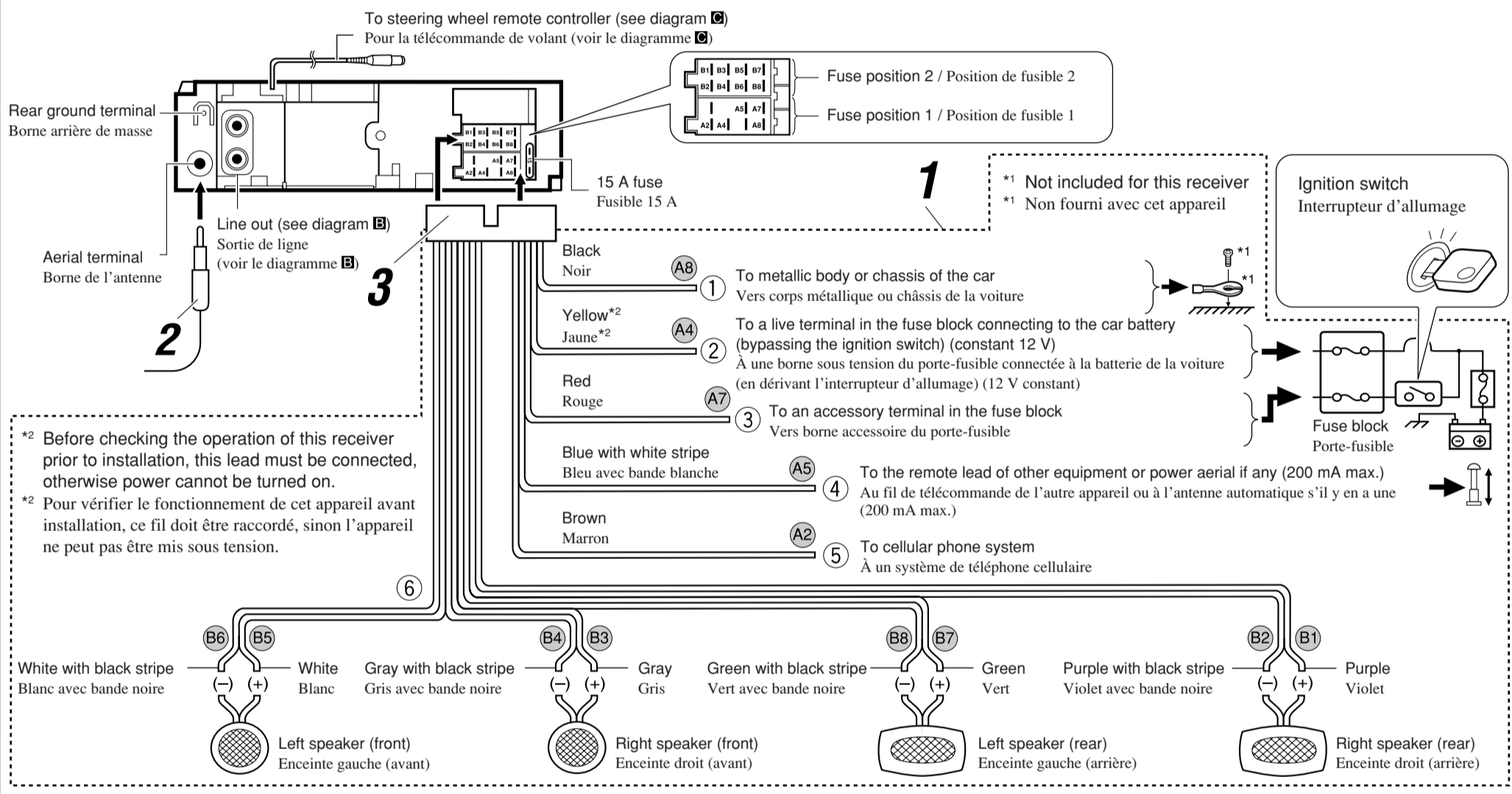

## B Connecting the external amplifier / Connexion d'un amplificateur extérieur

You can connect an amplifier to upgrade your car stereo system.

- Connect the remote lead (blue with white stripe) to the remote lead of the other equipment so that it can be controlled through this receiver.
- Disconnect the speakers from this receiver, connect them to the amplifier. Leave the speaker leads of this receiver unused.

Vous pouvez connecter un amplificateur pour améliorer votre système autoradio.

- Connectez le fil de commande à distance (bleu avec bande blanche) au fil de commande à distance de l'autre appareil de façon qu'il puisse être commandé via cet appareil.
- Déconnectez les enceintes de cet appareil et connectez-les à l'amplificateur. Laissez les fils d'enceintes de cet appareil inutilisés.

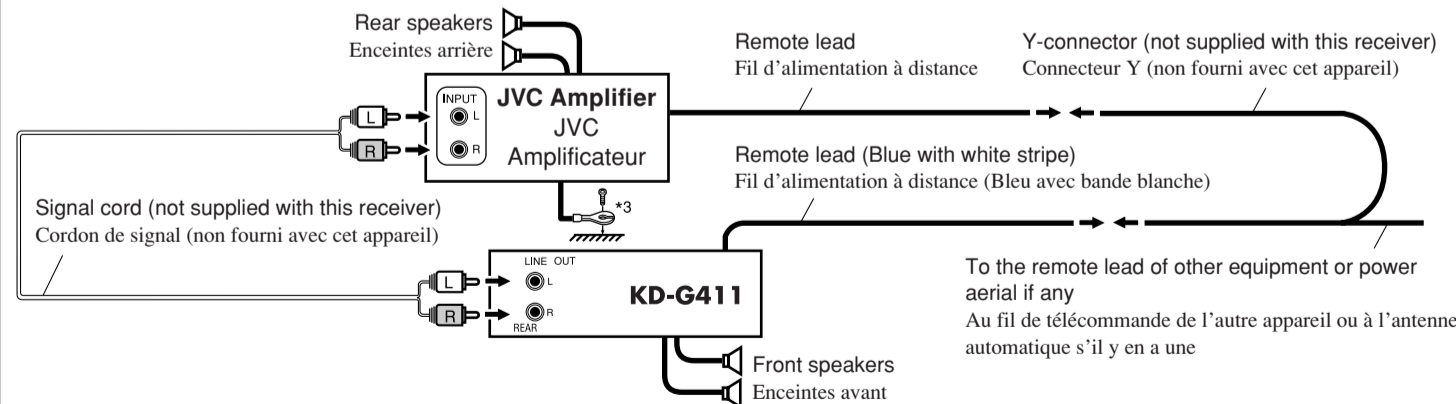

\*3 Firmly attach the ground wire to the metallic body or to the chassis of the car—to the place not coated with paint (if coated with paint, remove the paint before attaching the wire). Failure to do so may cause damage to the receiver.

\*3 Attachez solidement le fil de mise à la masse au châssis métallique de la voiture—à un endroit qui n'est pas recouvert de peinture (s'il est recouvert de peinture, enlevez d'abord la peinture avant d'attacher le fil). L'appareil peut être endommagé si cela n'est pas fait correctement.

## C Connecting to the steering wheel remote controller / Connexion de la télécommande de volant

If your car is equipped with the steering wheel remote controller, you can operate this receiver using the controller. To do it, a JVC's OE remote adapter (not supplied) which matches with your car is required. Consult your JVC IN-CAR ENTERTAINMENT dealer for details.

Si votre voiture est munie d'une télécommande de volant, vous pouvez commander cet autoradio en utilisant la télécommande. Pour le faire, un adaptateur pour télécommande au volant JVC (non fourni) correspondant à votre voiture est nécessaire. Consultez votre revendeur d'autoradio JVC pour les détails.

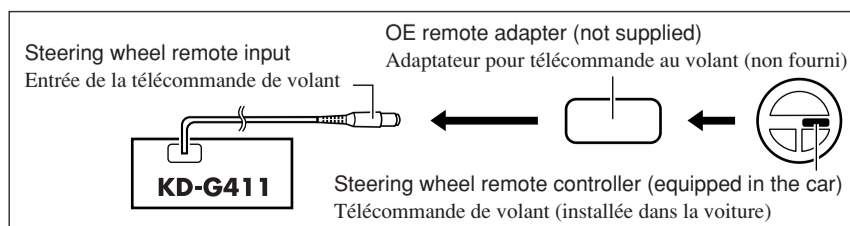



# JVC



ENGLISH

DEUTSCH

РУССКИЙ

## CD RECEIVER CD-RECEIVER

РЕСИВЕР С ПРОИГРЫВАТЕЛЕМ КОМПАКТ-ДИСКОВ

# KD-G411

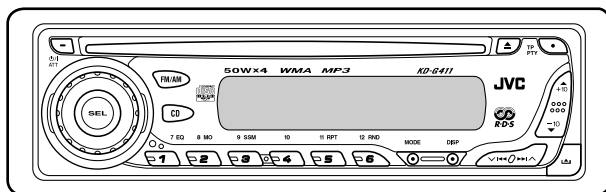
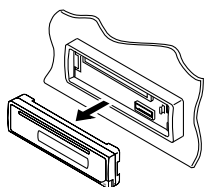

**WMA MP3**



For canceling the display demonstration, see page 7.

Zum Abbrechen der Displaydemonstration siehe Seite 7.

Информацию об отмене демонстрации функций дисплея см. на стр. 7.

For installation and connections, refer to the separate manual.

Für den Einbau und die Anschlüsse siehe das eigenständige Handbuch.

Указания по установке и выполнению соединений приводятся в отдельной инструкции.

# INSTRUCTIONS

BEDIENUNGSANLEITUNG  
ИНСТРУКЦИИ ПО ЭКСПЛУАТАЦИИ

GET0257-006A  
[EY]



Thank you for purchasing a JVC product.

Please read all instructions carefully before operation, to ensure your complete understanding and to obtain the best possible performance from the unit.

## IMPORTANT FOR LASER PRODUCTS

1. CLASS 1 LASER PRODUCT
2. **CAUTION:** Do not open the top cover. There are no user serviceable parts inside the unit; leave all servicing to qualified service personnel.
3. **CAUTION:** Visible and invisible laser radiation when open and interlock failed or defeated. Avoid direct exposure to beam.
4. REPRODUCTION OF LABEL: CAUTION LABEL, PLACED OUTSIDE THE UNIT.

<b>CAUTION:</b> Visible and invisible laser radiation when open and interlock failed or defeated. AVOID DIRECT EXPOSURE TO BEAM.	<b>ADVARSEL:</b> Synlig og usynlig laserstråling når maskinen er åpen eller interlocken fejler. Undgå direkte eksponering til strålingen.	<b>VARNING:</b> Synlig och osynlig laserstrålning när den öppnas och spärren är urkopplad. Beträkta ej strålen.	<b>VARO:</b> Avlåttaessa ja suojalukitus ohjelutuna tai viäläisena ollet antinna näkyväille ja näkymättömille lasersäteilylle. Vältä säteeseen kohdistumista suoraan itseesi. (f)
--	---	---	---

### Warning:

If you need to operate the receiver while driving, be sure to look ahead carefully or you may be involved in a traffic accident.

### How to reset your unit



- This will reset the microcomputer. Your preset adjustments will also be erased.
- If a disc is loaded, it will eject. Be careful not to drop the disc.

### How to forcibly eject a disc

If a disc cannot be recognized by the receiver or cannot be ejected, ejects the disc as follows.



- If this does not work, try to reset your receiver.
- Be careful not to drop the disc when it ejects.

For security reasons, a numbered ID card is provided with this receiver, and the same ID number is imprinted on the receiver's chassis. Keep the card in a safe place, as it will help the authorities to identify your receiver if stolen.

# Contents

How to reset your unit .....	2	<b>Sound adjustments .....</b>	<b>18</b>
How to forcibly eject a disc .....	2	<b>Selecting preset sound modes</b>	
How to read this manual .....	4	<b>(C-EQ: custom equalizer) .....</b>	<b>18</b>
How to use the MODE button .....	4	Adjusting the sound .....	19
<b>Control panel — KD-G411 .....</b>	<b>5</b>	<b>General settings — PSM .....</b>	<b>20</b>
Parts identification .....	5	Basic procedure .....	20
<b>Getting started .....</b>	<b>6</b>	<b>Detaching the control</b>	
<b>Basic operations .....</b>	<b>6</b>	<b>panel .....</b>	<b>22</b>
Canceling the display demonstrations ...	7	<b>Using the remote controller</b>	
Setting the clock .....	7	<b>— RM-RK60 .....</b>	<b>23</b>
<b>Radio operations .....</b>	<b>8</b>	Main elements and features .....	23
<b>Listening to the radio .....</b>	<b>8</b>	<b>Maintenance .....</b>	<b>24</b>
Storing stations in memory .....	9	<b>More about this receiver .....</b>	<b>25</b>
Listening to a preset station .....	9	<b>Troubleshooting .....</b>	<b>27</b>
<b>FM RDS operations .....</b>	<b>10</b>	<b>Specifications .....</b>	<b>29</b>
<b>Searching for your favorite FM RDS</b>			
<b>programme .....</b>	<b>10</b>		
Storing your favorite programmes .....	11		
Using the standby receptions .....	11		
Tracking the same programme			
—Network-Tracking Reception .....	12		
<b>Disc operations .....</b>	<b>13</b>		
<b>Playing a disc .....</b>	<b>13</b>		
Other main functions .....	15		
Changing the display information .....	16		
Selecting the playback modes .....	17		

## \*For safety....

- Do not raise the volume level too much, as this will block outside sounds, making driving dangerous.
- Stop the car before performing any complicated operations.





## \*Temperature inside the car....

If you have parked the car for a long time in hot or cold weather, wait until the temperature in the car becomes normal before operating the unit.

## How to read this manual

The following methods are used to make the explanations simple and easy-to-understand:

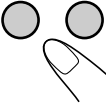
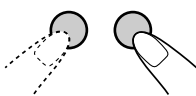
- Some related tips and notes are explained in “More about this receiver” (see page 25).
- Button operations are mainly explained with the illustrations as follows:

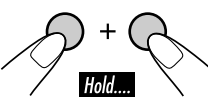
	Press briefly.
	Press repeatedly.
	Press either one.
	
	Press and hold until your desired response begins.
	Press and hold both buttons at the same time.

## How to use the MODE button

If you press MODE, the receiver goes into functions mode, then the number buttons and ▲/▼ buttons work as different function buttons.

Ex.: When number button 2 works as MO (monaural) button.

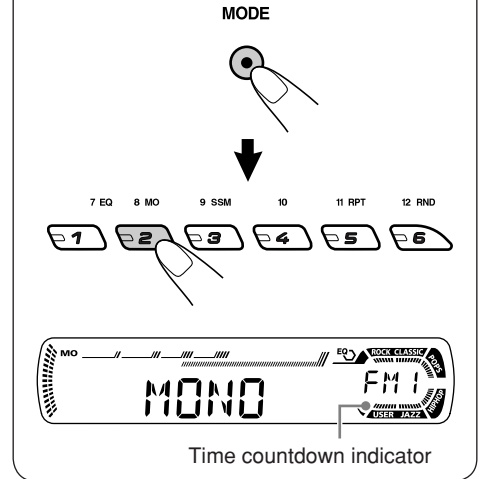

**To use these buttons for original functions again after pressing MODE**, wait for 5 seconds without pressing any of these buttons until the functions mode is cleared.

- Pressing MODE again also clears the functions mode.

## Parts identification

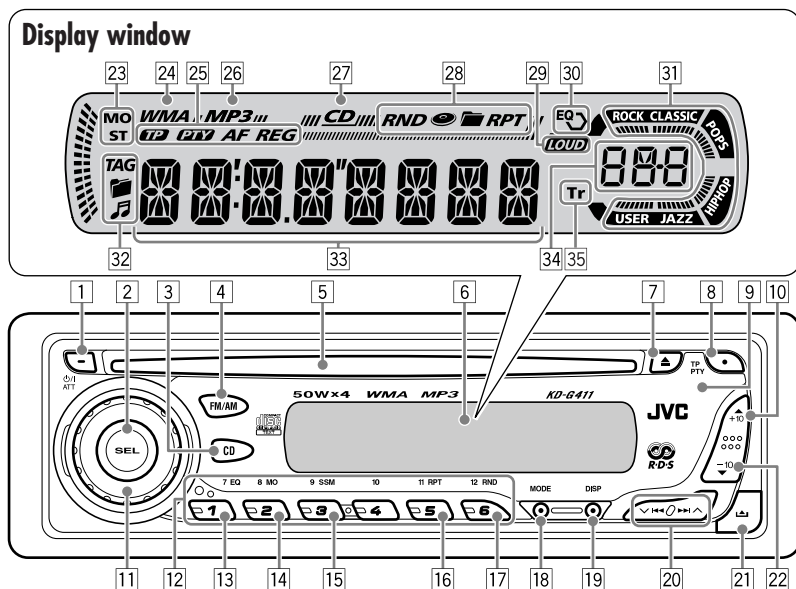

- 1  $\odot$ /I ATT (standby/on attenuator) button
- 2 SEL (select) button
- 3 CD button
- 4 FM/AM button
- 5 Loading slot
- 6 Display window
- 7  $\blacktriangle$  (eject) button
- 8 TP PTY (traffic programme/programme type) button
- 9 Remote sensor
  - You can control this receiver with an optionally purchased remote controller.
  - DO NOT expose the remote sensor to strong light (direct sunlight or artificial lighting).
- 10  $\blacktriangle$  (up) button / +10 button
- 11 Control dial
- 12 Number buttons
- 13 EQ (equalizer) button
- 14 MO (monaural) button
- 15 SSM (Strong-station Sequential Memory) button
- 16 RPT (repeat) button
- 17 RND (random) button
- 18 MODE button
- 19 DISP (display) button

- 20  $\blacktriangledown$   $\lll$   $\lll$   $\ggg$   $\ggg$   $\blacktriangle$  buttons
- 21  $\blacktriangle$  (control panel release) button
- 22  $\blacktriangledown$  (down) button / -10 button

### Display window

- 23 Tuner reception indicators—MO (monaural), ST (stereo)
- 24 WMA indicator
- 25 RDS indicators—TP, PTY, AF, REG
- 26 MP3 indicator
- 27 CD indicator
- 28 Playback mode / item indicators—RND (random),  $\odot$  (disc),  $\blacktriangle$  (folder), RPT (repeat)
- 29 LOUD (loudness) indicator
- 30 EQ (equalizer) indicator
- 31 Sound mode (C-EQ: custom equalizer) indicators—ROCK, CLASSIC, POPS, HIP HOP, JAZZ, USER
  - $\text{|||||}$  also works as the time countdown indicator.
- 32 Disc information indicators—TAG (ID3 Tag),  $\blacktriangle$  (folder),  $\text{🎵}$  (track/file)
- 33 Main display
- 34 Source display / Volume level indicator
- 35 Tr (track) indicator

# Getting started

## Basic operations

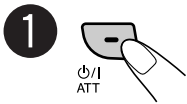
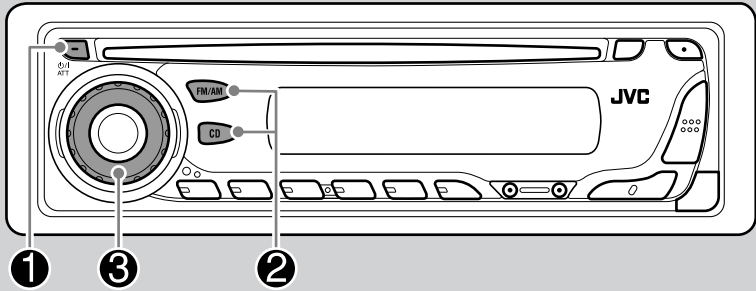

### To drop the volume in a moment (ATT)

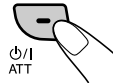

To restore the sound, press it again.

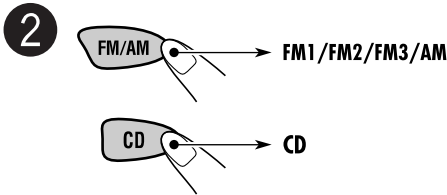

### To turn off the power



You cannot select "CD" as the playback source if there is no disc in the loading slot.

### Caution on volume setting:

Discs produce very little noise compared with other sources. Lower the volume before playing a disc to avoid damaging the speakers by the sudden increase of the output level.

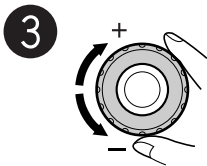

Volume level appears.

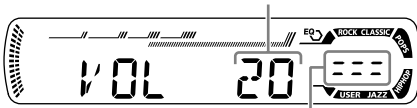

Volume level indicator



## Canceling the display demonstrations

If no operations are done for about 20 seconds, display demonstration starts.

[Initial: DEMO ON]—see page 20.

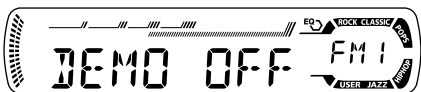
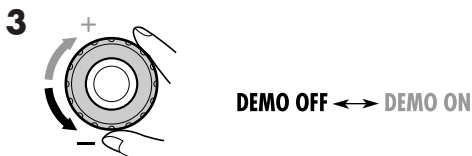
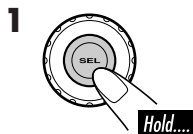

**4** Finish the procedure.



## To activate the display demonstration

In step **3** above...



## Setting the clock

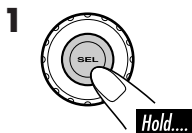

**2** Set the hour, minute, and clock system.

- 1 Select “CLOCK H” (hour), then adjust the hour.
- 2 Select “CLOCK M” (minute), then adjust the minute.
- 3 Select “24H/12H,” then select “24H” (hour) or “12H” (hour).

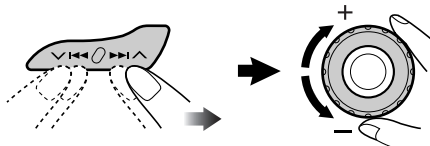

**3** Finish the procedure.



## To check the current clock time when the power is turned off

DISP



# Radio operations

## Listening to the radio

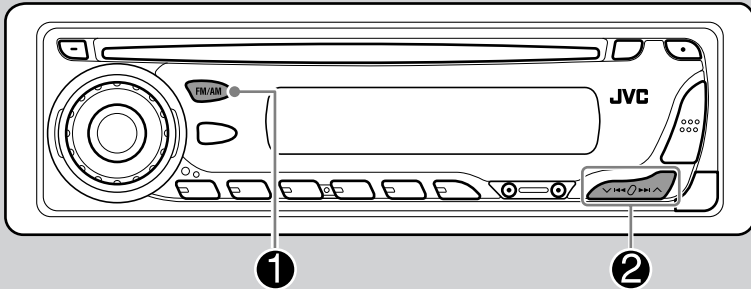

1

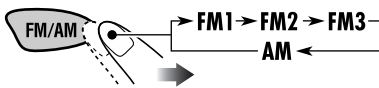

Lights up when receiving an FM stereo broadcast with sufficient signal strength.

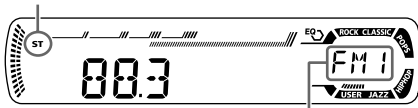

Selected band appears.

2

Start searching for a station.

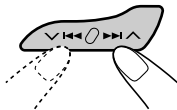

When a station is received, searching stops.

To stop searching, press the same button again.

### To tune in to a station manually

In step 2 above...

1

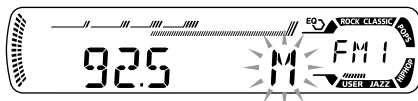
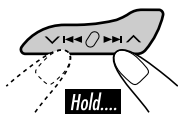

2 Select the desired station frequencies.

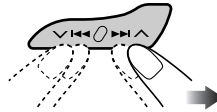

### When an FM stereo broadcast is hard to receive

1 MODE



2 8 MO



Lights up when monaural mode is activated.

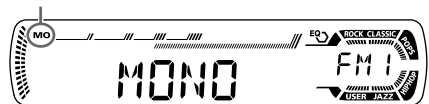

Reception improves, but stereo effect will be lost.

To restore the stereo effect, repeat the same procedure so that the MO indicator goes off.



## Storing stations in memory

You can preset six stations for each band.

### FM station automatic presetting—SSM (Strong-station Sequential Memory)

**1** Select the FM band (FM1 – FM3) you want to store into.

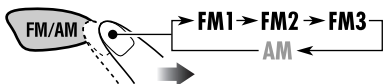

**2** MODE



**3** 9 SSM



“SSM” flashes, then disappears when automatic presetting is over.

Local FM stations with the strongest signals are searched and stored automatically in the FM band.

### Manual presetting

Ex.: Storing FM station of 92.5 MHz into preset number 4 of the FM1 band.

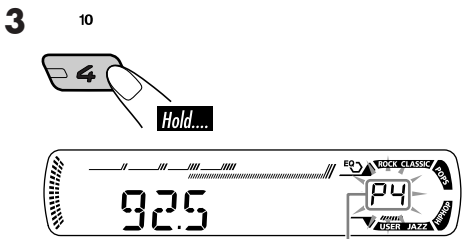
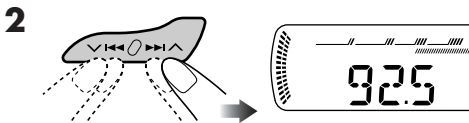

Preset number flashes for a while.

## Listening to a preset station

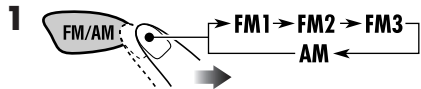

**2** Select the preset station (1 – 6) you want.

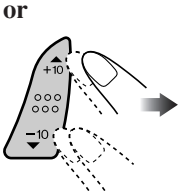
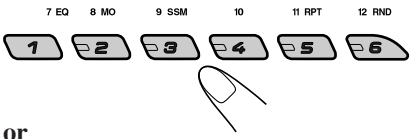

### To check the current clock time while listening to an FM (non-RDS) or AM station

- For FM RDS stations, see page 12.

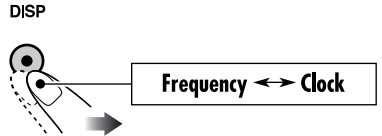

# FM RDS operations

## Searching for your favorite FM RDS programme

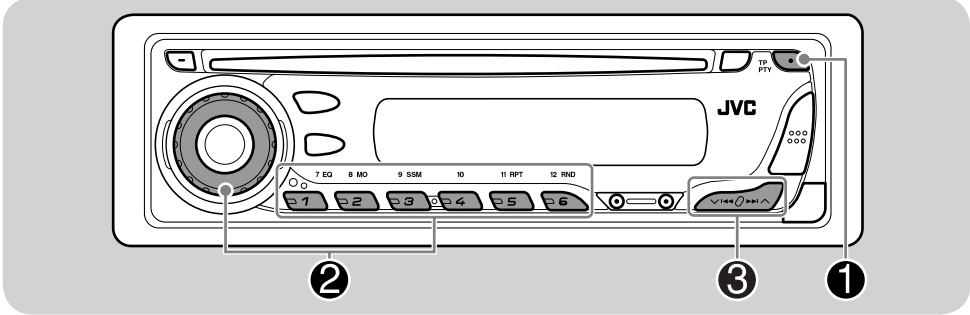

You can tune in to a station broadcasting your favorite programme by searching for a PTY code.

**3** Start searching for your favorite programme.

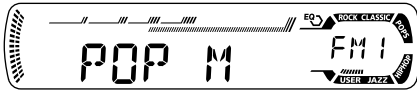
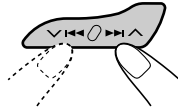
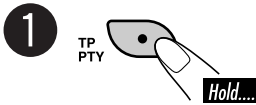

The last selected PTY code appears.



If there is a station broadcasting a programme of the same PTY code as you have selected, that station is tuned in.

**2** Select one of your favorite programme type.

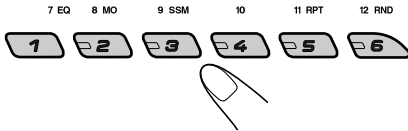

or

Select one of the twenty-nine PTY codes.

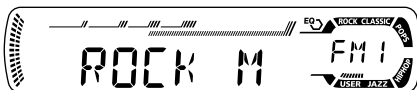
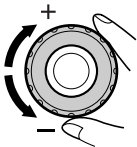

Ex.: When "ROCK M" is selected

### PTY codes

- NEWS ⇄ AFFAIRS ⇄ INFO ⇄ SPORT ⇄ EDUCATE ⇄ DRAMA ⇄ CULTURE ⇄ SCIENCE ⇄ VARIED ⇄ POP M (music) ⇄ ROCK M (music) ⇄ EASY M (music) ⇄ LIGHT M (music) ⇄ CLASSICS ⇄ OTHER M (music) ⇄ WEATHER ⇄ FINANCE ⇄ CHILDREN ⇄ SOCIAL ⇄ RELIGION ⇄ PHONE IN ⇄ TRAVEL ⇄ LEISURE ⇄ JAZZ ⇄ COUNTRY ⇄ NATION M (music) ⇄ OLDIES ⇄ FOLK M (music) ⇄ DOCUMENT ⇄ OFF ⇄ (back to the beginning)

### What you can do with RDS

RDS (Radio Data System) allows FM stations to send an additional signal along with their regular programme signals. By receiving the RDS data, this receiver can do the following:

- Programme Type (PTY) Search (see page 10)
- Standby Reception of Traffic Announcement —TA (see the following) or your favorite programme (PTY) (see pages 12 and 21)
- Tracing the same programme automatically —Network-Tracking Reception (see page 12)
- Programme Search (see page 21)

**3 Repeat steps 1 and 2 to store other PTY codes into other preset numbers.**

**4 Finish the procedure.**

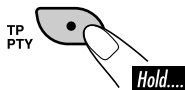

### Using the standby receptions

#### TA Standby Reception

TA Standby Reception allows the receiver to switch temporarily to Traffic Announcement (TA) from any source other than AM. The volume changes to the preset TA volume level (see page 21).

#### To activate TA Standby Reception

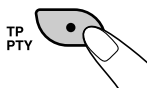

The TP indicator either lights up or flashes.

- If the TP indicator lights up, TA Standby Reception is activated.
- If the TP indicator flashes, TA Standby Reception is not yet activated. (This occurs when you are listening to an FM station without the RDS signals required for TA Standby Reception.)

To activate TA Standby Reception, tune in to another station providing these signals. The TP indicator will stop flashing and remain lit.

#### To deactivate the TA Standby Reception

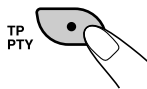

The TP indicator goes off.

### Storing your favorite programmes

You can store six favorite programme types.

Preset programme types in the number buttons (1 – 6):

1	2	3	4	5	6
POP M	ROCK M	EASY M	CLASSICS	AFFAIRS	VARIED

**1 Perform steps 1 and 2 on page 10 to select a PTY code.**

**2 Select the preset number (1 – 6) you want to store into.**

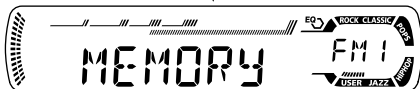
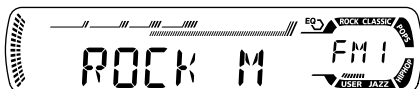
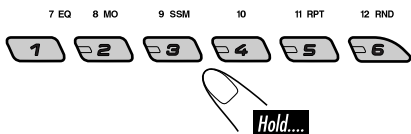

Ex.: When "ROCK M" is selected

## ■ PTY Standby Reception

PTY Standby Reception allows the receiver to switch temporarily to your favorite PTY programme from any source other than AM.

**To activate and select your favorite PTY code for PTY Standby Reception,** see page 21.

The PTY indicator either lights up or flashes.

- If the PTY indicator lights up, PTY Standby Reception is activated.
- If the PTY indicator flashes, PTY Standby Reception is not yet activated.

To activate PTY Standby Reception, tune in to another station providing these signals. The PTY indicator will stop flashing and remain lit.

**To deactivate the PTY Standby Reception,** select "OFF" for the PTY code. The PTY indicator goes off.

## Tracking the same programme— Network-Tracking Reception

When driving in an area where FM reception is not sufficient enough, this receiver automatically tunes in to another FM RDS station of the same network, possibly broadcasting the same programme with stronger signals (see the illustration below).

When shipped from the factory, Network-Tracking Reception is activated.

**To change the Network-Tracking Reception setting,** see page 21.

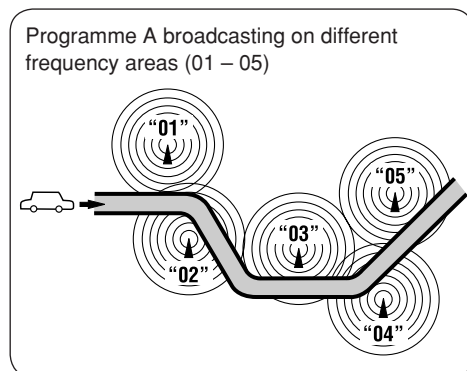

## To check the current clock time while listening to an FM RDS station

DISP

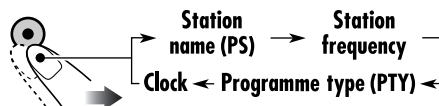

# Disc operations

## Playing a disc

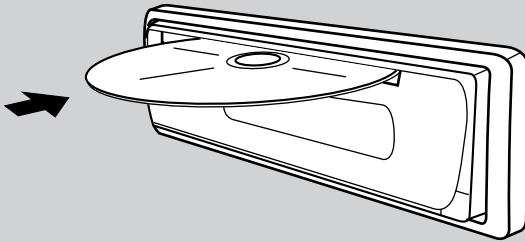

All tracks will be played repeatedly until you stop playback.

### About MP3 and WMA discs

MP3 and WMA (Windows Media® Audio) "tracks" (words "file" and "track" are used interchangeably) are recorded in "folders."

- When inserting an MP3 or a WMA disc:

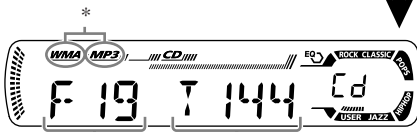
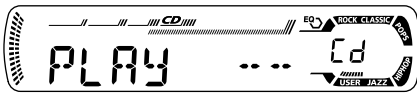

Total folder number

Total file number

When playback starts, disc information will automatically appear (see page 16).

\* Either the MP3 or WMA indicator lights up depending on the first detected file.

- When inserting an audio CD or a CD Text disc:

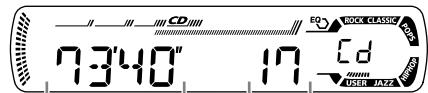

Total playing time of the inserted disc

Total track number of the inserted disc

CD Text: Disc title/performer →  
Track title appear automatically.

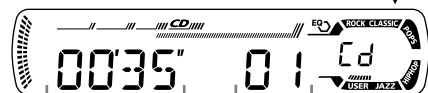

Elapsed playing time

Current track number

### To stop play and eject the disc

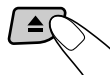

**To fast-forward or reverse the track**

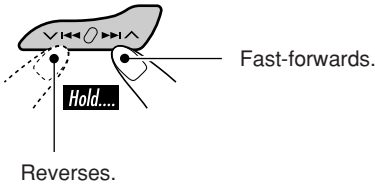

**To go to the next or previous tracks**

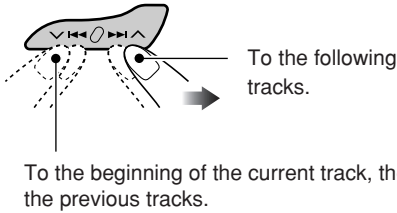

**To go to the next or previous folders (only for MP3 or WMA disc)**

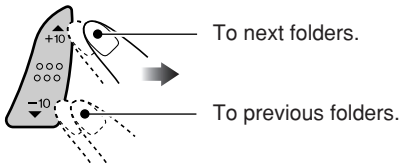

**To locate a particular track (for CD) or folder (for MP3 or WMA discs) directly**

To select a number from 01 – 06:

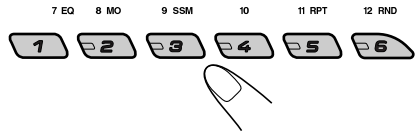

To select a number from 07 – 12:

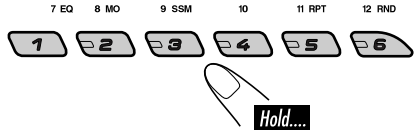

- To select a particular track in a folder (for MP3 or WMA disc) after selecting a folder:

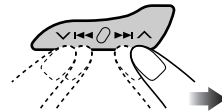

## Other main functions

### ■ Skipping a track quickly during play

- For MP3 or WMA disc, you can skip a track within the same folder.

Ex.: To select track 32 while playing track 6

#### 1 MODE

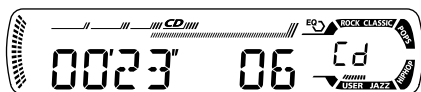

#### 2

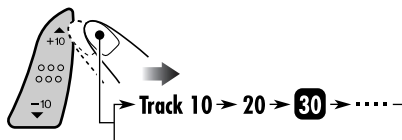

First time you press +10 or -10 button, the track skips to the nearest higher or lower track with a track number of multiple ten (ex. 10th, 20th, 30th).

Then each time you press the button, you can skip 10 tracks.

- After the last track, the first track will be selected and vice versa.

#### 3

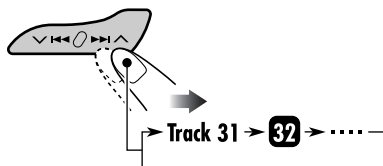

### ■ Prohibiting disc ejection

You can lock a disc in the loading slot.



To cancel the prohibition, repeat the same procedure.



## Changing the display information

DISP

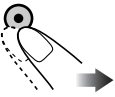

### ■ While playing an audio CD or a CD Text

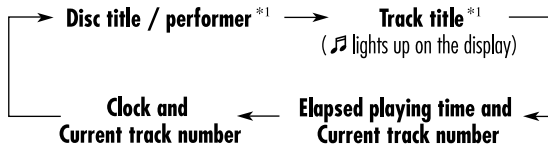

\*1 If the current disc is an audio CD, "NO NAME" appears.

### ■ While playing an MP3 or WMA disc

- When "TAG DISP" is set to "TAG ON" (see page 21)

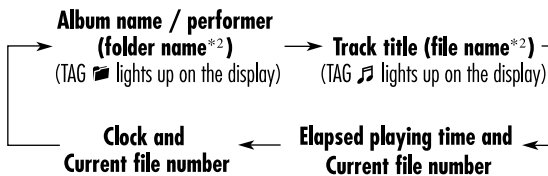

\*2 If an MP3/WMA file does not have ID3 tags, folder name and file name appear. In this case, the TAG indicator will not light up.

- When "TAG DISP" is set to "TAG OFF"

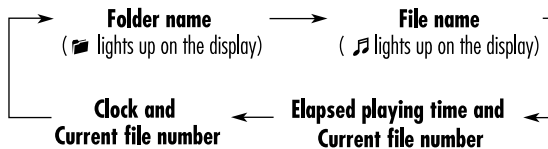



# Selecting the playback modes

You can use only one of the following playback modes at a time.

## 1 MODE



## 2 Select your desired playback mode.

### Repeat play

11 RPT

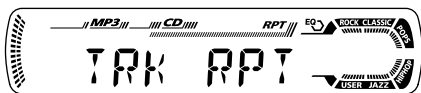

Ex.: When "TRK RPT" is selected while playing an MP3 disc

### Random play

12 RND



Ex.: When "DISC RND" is selected while playing an MP3 disc

Mode	Plays repeatedly
<b>TRK RPT:</b>	The current track. <ul style="list-style-type: none"> <li>• RPT lights up.</li> </ul>
<b>FLDR RPT*:</b>	All tracks of the current folder. <ul style="list-style-type: none"> <li>• [Folder icon] and RPT light up.</li> </ul>
Off:	Cancels repeat play.

Mode	Plays at random
<b>FLDR RND*:</b>	All tracks of the current folder, then tracks of the next folder and so on. <ul style="list-style-type: none"> <li>• RND and [Folder icon] light up.</li> </ul>
<b>DISC RND:</b>	All tracks of the current disc. <ul style="list-style-type: none"> <li>• RND and [Disc icon] light up.</li> </ul>
Off:	Cancels random play.

\* Only while playing an MP3 or WMA disc.

# Sound adjustments

## Selecting preset sound modes (C-EQ: custom equalizer)

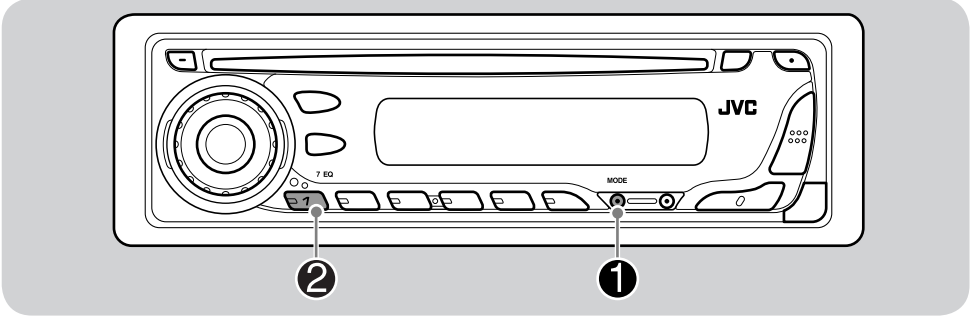

You can select a preset sound mode suitable to the music genre.

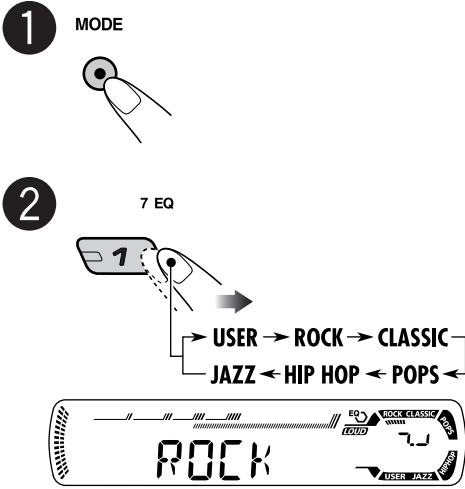

Ex.: When "ROCK" is selected

Indication	For:	Preset values		
		BAS* <sup>1</sup>	TRE* <sup>2</sup>	LOUD* <sup>3</sup>
USER	(Flat sound)	00	00	OFF
ROCK	Rock or disco music	+03	+01	ON
CLASSIC	Classical music	+01	-02	OFF
POPS	Light music	+04	+01	OFF
HIP HOP	Funk or rap music	+02	00	ON
JAZZ	Jazz music	+02	+03	OFF

\*1 BAS: Bass  
 \*2 TRE: Treble  
 \*3 LOUD: Loudness

Indication pattern for each sound mode:

USER	ROCK	CLASSIC
JAZZ	HIP HOP	POPS

## Adjusting the sound

You can adjust the sound characteristics to your preference.

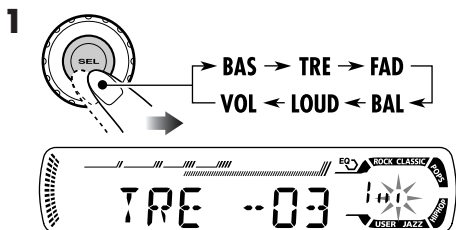

Ex.: When "TRE" is selected

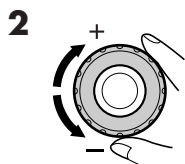

Indication pattern changes as you adjust the level.

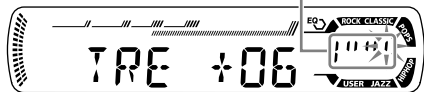

Indication	To do:	Range
BAS*1 (bass)	Adjust the bass.	-06 (min.) to +06 (max.)
TRE*1 (treble)	Adjust the treble.	-06 (min.) to +06 (max.)
FAD*2 (fader)	Adjust the front and rear speaker balance.	R06 (Rear only) to F06 (Front only)
BAL (balance)	Adjust the left and right speaker balance.	L06 (Left only) to R06 (Right only)
LOUD*1 (loudness)	Boost low and high frequencies to produce a well-balanced sound at low volume level.	LOUD ON ↕ LOUD OFF
VOL*3 (volume)	Adjust the volume.	00 (min.) to 30 or 50 (max.)*4

\*1 When you adjust the bass, treble, or loudness, the adjustment you have made is stored for the currently selected sound mode (C-EQ) including "USER."

\*2 If you are using a two-speaker system, set the fader level to "00."

\*3 Normally the control dial works as the volume control. So you do not have to select "VOL" to adjust the volume level.

\*4 Depending on the amplifier gain control setting. (See page 21 for details.)

# General settings — PSM

## Basic procedure

You can change PSM (Preferred Setting Mode) items listed in the table that follows.

1

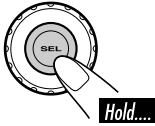

2 Select a PSM item.

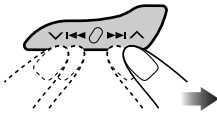

Ex.: When you select "DIMMER"

3 Adjust the PSM item selected.

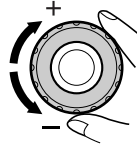

4 Repeat steps 2 and 3 to adjust the other PSM items if necessary.

5 Finish the procedure.



### Indications

### Selectable settings, [reference page]

#### DEMO

Display demonstration

**DEMO ON:** [Initial]; Display demonstration will be activated automatically if no operation is done for about 20 seconds, [7].

**DEMO OFF:** Cancels.

#### CLOCK H

Hour adjustment

0 – 23 (1 – 12), [7]

[Initial: 0 (0:00)]

#### CLOCK M

Minute adjustment

00 – 59, [7]

[Initial: 00 (0:00)]

#### 24H/12H

24 hours or 12 hours time display

12H  $\rightleftharpoons$  24H, [7]

[Initial: 24H]

#### CLK ADJ

Clock adjustment

**AUTO:** [Initial]; The built-in clock is automatically adjusted using the CT (clock time) data in the RDS signal.

**OFF:** Cancels.

Indications	Selectable settings, [reference page]
<b>AF-REG</b> Alternative frequency/ regionalization reception	When the received signals from the current station become weak... <b>AF:</b> [Initial]; Switches to another station (the programme may differ from the one currently received), [12]. • The AF indicator lights up. <b>AF REG:</b> Switches to another station broadcasting the same programme. • The AF and REG indicators light up. <b>OFF:</b> Cancels.
<b>PTY STBY</b> PTY standby	[Initial: OFF]; Activates PTY Standby Reception with one of the 29 PTY codes, [12].
<b>TA VOL</b> Traffic announcement volume	[Initial: VOL 20]; VOL 00 – VOL 30 or 50*, [11] * Depends on the amplifier gain control.
<b>P-SEARCH</b> Programme search	<b>ON:</b> Using the AF data, the receiver tunes in to another frequency broadcasting the same programme as the original preset RDS station is if the preset station signals are not sufficient. <b>OFF:</b> [Initial]; Cancels.
<b>DIMMER</b> Dimmer	<b>ON:</b> Activates dimmer. <b>OFF:</b> [Initial]; Cancels.
<b>TEL</b> Telephone muting	<b>MUTING 1/MUTING 2:</b> Select either one which mutes the sounds while using the cellular phone. <b>OFF:</b> [Initial]; Cancels.
<b>SCROLL</b> Scroll	<b>ONCE:</b> [Initial]; Scrolls the disc information once. <b>AUTO:</b> Repeats scrolling (5-second intervals in between). <b>OFF:</b> Cancels. • Pressing DISP for more than one second can scrolls the display regardless of the setting.
<b>TAG DISP</b> Tag display	<b>TAG ON:</b> [Initial]; Shows the ID3 tag while playing MP3/WMA tracks, [16]. <b>TAG OFF:</b> Cancels.
<b>AMP GAIN</b> Amplifier gain control	You can change the maximum volume level of this receiver. <b>LOW PWR:</b> VOL 00 – VOL 30 (Select this if the maximum power of the speaker is less than 50 W to prevent them from damaging the speaker.) <b>HIGH PWR:</b> [Initial]; VOL 00 – VOL 50

# Detaching the control panel

When detaching or attaching the control panel, be careful not to damage the connectors on the back of the control panel and on the panel holder.

## ■ Detaching the control panel

Before detaching the control panel, be sure to turn off the power.

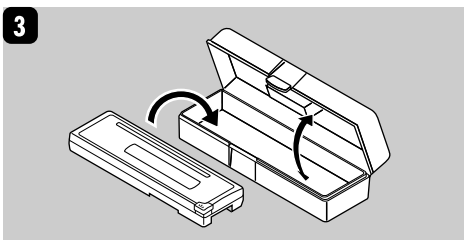
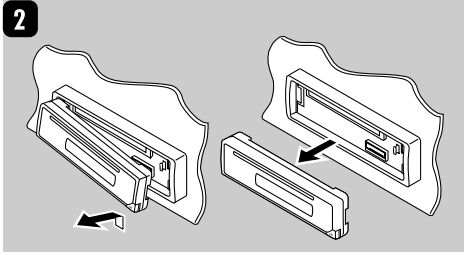
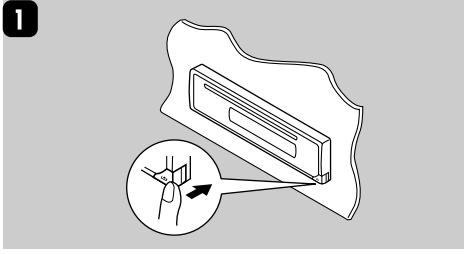

## ■ Attaching the control panel

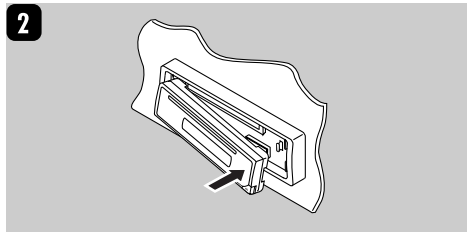
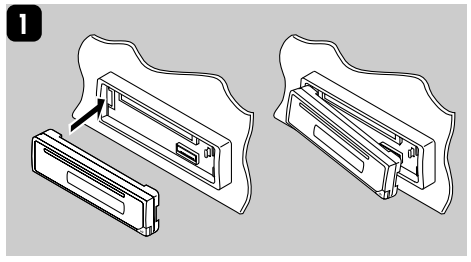

# Using the remote controller — RM-RK60

This receiver can be remotely controlled as instructed here (with an optionally purchased remote controller). We recommend that you use remote controller RM-RK60 with your receiver.

- When operating, aim the remote controller directly at the remote sensor on the receiver. Make sure there is no obstacle in between.

## ■ Installing the lithium coin battery (CR2025)

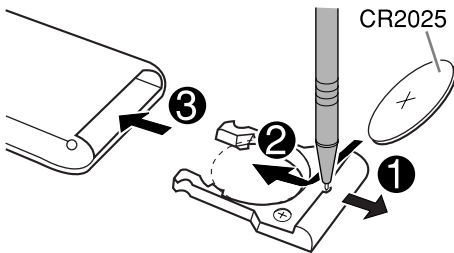

### Warning:

- Store the battery in a place where children cannot reach to avoid risk of accident.
- To prevent the battery from over-heating, cracking, or starting a fire:
  - Do not recharge, short, disassemble, or heat the battery or dispose of it in a fire.
  - Do not leave the battery with other metallic materials.
  - Do not poke the battery with tweezers or similar tools.
  - Wrap the battery with tape and insulate when throwing away or saving it.

### Caution:

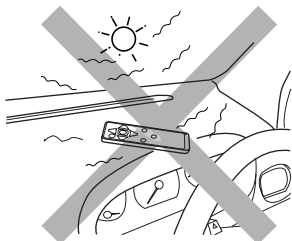

## Main elements and features

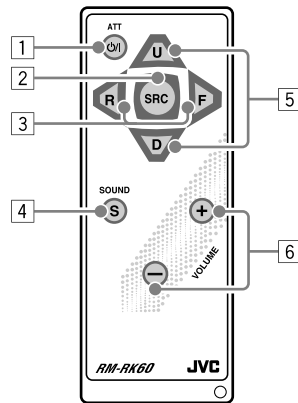

- 1 **ATT** (standby/on attenuator) button
  - Turns on and off the power and also attenuates the sound.
- 2 **SRC** (source) button
  - Selects the source.
- 3 **R** (reverse) / **F** (forward) buttons
  - Searches for stations if pressed briefly.
  - Fast-forwards or reverses the track if pressed and held.
  - Changes the tracks on the disc.
- 4 **SOUND** button
  - Selects the sound mode (C-EQ: custom equalizer).
- 5 **U** (up) / **D** (down) buttons
  - **U** (up): Changes the FM/AM bands.
  - **D** (down): Changes the preset stations.
  - Changes the folder on the MP3/WMA discs.
- 6 **VOLUME +/-** buttons
  - Adjusts the volume level.

The receiver is equipped with the steering wheel remote control function.

- See the Installation/Connection Manual (separate volume) for connection.

# Maintenance

## How to clean the connectors

Frequent detachment will deteriorate the connectors.

To minimize this possibility, periodically wipe the connectors with a cotton swab or cloth moistened with alcohol, being careful not to damage the connectors.

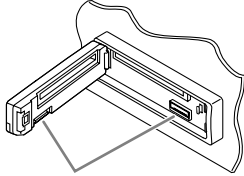

Connector

## Moisture condensation

Moisture may condense on the lens inside the CD player in the following cases:

- After starting the heater in the car.
- If it becomes very humid inside the car.

Should this occur, the CD player may malfunction. In this case, eject the disc and leave the receiver turned on for a few hours until the moisture evaporates.

## How to handle discs

**When removing a disc from its case,** press down the center holder of the case and lift the disc out, holding it by the edges.

Center holder



- Always hold the disc by the edges. Do not touch its recording surface.

**When storing a disc into its case,** gently insert the disc around the center holder (with the printed surface facing up).

- Make sure to store discs into the cases after use.

## To keep discs clean

A dirty disc may not play correctly. If a disc does become dirty, wipe it with a soft cloth in a straight line from center to edge.



- Do not use any solvent (for example, conventional record cleaner, spray, thinner, benzine, etc.) to clean discs.

## To play new discs

New discs may have some rough spots around the inner and outer edges. If such a disc is used, this receiver may reject the disc.



To remove these rough spots, rub the edges with a pencil or ball-point pen, etc.

### Do not use the following discs:

Warped disc



Sticker



Sticker residue

Disc



Stick-on label



# More about this receiver

## Basic operations

### Turning off the power

- If you turn off the power while listening to a disc, disc play will start from where playback has been stopped previously, next time you turn on the power.

## Tuner operations

### Storing stations in memory

- During SSM search...
  - All previously stored stations are erased and stations are stored newly.
  - Received stations are preset in No. 1 (lowest frequency) to No. 6 (highest frequency).
  - When SSM is over, the station stored in No. 1 will be automatically tuned in.
- When storing a station manually, a previously preset station is erased when a new station is stored in the same preset number.

## FM RDS operations

- Network-Tracking Reception requires two types of RDS signals—PI (Programme Identification) and AF (Alternative Frequency) to work correctly. Without receiving these data correctly, Network-Tracking Reception will not operate.
- If a Traffic Announcement is received, the volume level (TA Volume) automatically changes to the preset level.

## Disc operations

### General

- This receiver has been designed to reproduce CDs/CD Texts, and CD-Rs (Recordable)/CD-RWs (Rewritable) in audio CD (CD-DA), MP3 and WMA format.
- When a disc has been loaded, selecting “CD” for the playback source starts disc play.

### Inserting a disc

- When a disc is inserted upside down, the disc automatically ejects.
- Do not insert 8 cm discs (single CD) and unusual shape discs (heart, flower, etc.) into the loading slot.

### Playing a disc

- While fast-forwarding or reversing on an MP3 or WMA disc, you can only hear intermittent sounds.

### Playing a CD-R or CD-RW

- Use only “finalized” CD-Rs or CD-RWs.
- This receiver can play back only the files of the same type which is first detected if a disc includes both audio CD (CD-DA) files and MP3/WMA files.
- This receiver can play back multi-session discs; however, unclosed sessions will be skipped while playing.
- Some CD-Rs or CD-RWs may not play back on this receiver because of their disc characteristics, and for the following causes:
  - Discs are dirty or scratched.
  - Moisture condensation occurs on the lens inside the receiver.
  - The pickup lens inside the receiver is dirty.
  - CD-R/CD-RW on which the files are written with “Packet Write” method.
  - There are improper recording conditions (missing data, etc.) or media conditions (stain, scratch, warp, etc.).
- CD-RWs may require a longer readout time since the reflectance of CD-RWs is lower than that of regular CDs.
- Do not use the following CD-Rs or CD-RWs:
  - Discs with stickers, labels, or protective seal stuck to the surface.
  - Discs on which labels can be directly printed by an ink jet printer.Using these discs under high temperatures or high humidity may cause malfunctions or damage to discs.

## Playing an MP3/WMA disc

- This receiver can play back MP3/WMA files with the extension code <.mp3> or <.wma> (regardless of the letter case—upper/lower).
- This receiver can show the names of albums, artists (performer), and ID3 Tag (Version 1.0, 1.1, 2.2, 2.3, or 2.4) for MP3 files and for WMA files.
- This receiver can handle only one-byte characters. No other characters can be correctly displayed.
- This receiver can play back MP3/WMA files meeting the conditions below:
  - Bit rate: 8 kbps — 320 kbps
  - Sampling frequency:
    - 48 kHz, 44.1 kHz, 32 kHz (for MPEG-1)
    - 24 kHz, 22.05 kHz, 16 kHz (for MPEG-2)
  - Disc format: ISO 9660 Level 1/ Level 2, Romeo, Joliet, Windows long file name
- The maximum number of characters for file/folder names vary among the disc format used (includes 4 extension characters—<.mp3> or <.wma>).
  - ISO 9660 Level 1: up to 12 characters
  - ISO 9660 Level 2: up to 31 characters
  - Romeo\*: up to 128 (72) characters
  - Joliet\*: up to 64 (36) characters
  - Windows long file name\*: up to 128 (72) characters

\* *The parenthesis figure is the maximum number of characters for file/folder names in case the total number of files and folders is 313 or more.*
- This receiver can recognize the total of 512 files, of 200 folders, and of 8 hierarchies.
- This receiver can play back the files recorded in VBR (variable bit rate).  
The files recorded in VBR have a discrepancy in elapsed time display, and do not show the actual elapsed time. Especially, after performing the search function, this difference becomes noticeable.

- This receiver cannot play back the following files:
  - MP3 files encoded with MP3i and MP3 PRO formats.
  - MP3 files encoded in an unappropriated format.
  - MP3 files encoded with Layer 1/2.
  - WMA files encoded with lossless, professional, and voice formats.
  - WMA files which are not based upon Windows Media® Audio.
  - WMA formatted files copy-protected with DRM.
  - Files which have the data such as WAVE, ATRAC3, etc.
- The search function works but search speed is not constant.

## Changing the source

- If you change the source, playback also stops (without ejecting the disc).  
Next time you select “CD” for the playback source, disc play starts from where it has been stopped previously.

## Ejecting a disc

- If the ejected disc is not removed within 15 seconds, the disc is automatically inserted again into the loading slot to prevent it from dust. (Disc will not play this time.)

## General settings—PSM

- If you change the “AMP GAIN” setting from “HIGH PWR” to “LOW PWR” while the volume level is set higher than “VOL 30,” the receiver automatically changes the volume level to “VOL 30.”

# Troubleshooting

What appears to be trouble is not always serious. Check the following points before calling a service center.

	Symptoms	Causes	Remedies
General	• Sound cannot be heard from the speakers.	The volume level is set to the minimum level.	Adjust it to the optimum level.
		Connections are incorrect.	Check the cords and connections.
	• The receiver does not work at all.	The built-in microcomputer may have functioned incorrectly due to noise, etc.	Reset the receiver (see page 2).
FM/AM	• SSM automatic presetting does not work.	Signals are too weak.	Store stations manually.
	• Static noise while listening to the radio.	The aerial is not connected firmly.	Connect the aerial firmly.
Disc playback	• Disc automatically ejects.	Disc is inserted upside down.	Insert the disc correctly.
	• CD-R/CD-RW cannot be played back.	CD-R/CD-RW is not finalized.	• Insert a finalized CD-R/CD-RW.
	• Tracks on the CD-R/CD-RW cannot be skipped.		• Finalize the CD-R/CD-RW with the component which you used for recording.
	• Disc can be neither played back nor ejected.	Disc is locked.	Unlock the disc (see page 15).
		The CD player may have functioned incorrectly.	Eject the disc forcibly (see page 2).
	• Disc sound is sometimes interrupted.	You are driving on rough roads.	Stop playback while driving on rough roads.
		Disc is scratched.	Change the disc.
		Connections are incorrect.	Check the cords and connections.
• "NO DISC" appears on the display.	No disc in the loading slot.	Insert a disc into the loading slot.	
	Disc is inserted incorrectly.	Insert the disc correctly.	

	Symptoms	Causes	Remedies
MP3/WMA playback	<ul style="list-style-type: none"> <li>Disc cannot be played back.</li> </ul>	No MP3/WMA tracks are recorded on the disc.	Change the disc.
		MP3/WMA tracks do not have the extension code <.mp3> or <.wma> in their file names.	Add the extension code <.mp3> or <.wma> to their file names.
		MP3/WMA tracks are not recorded in the format compliant with ISO 9660 Level 1, Level 2, Romeo, or Joliet.	Change the disc. (Record MP3/WMA tracks using a compliant application.)
	<ul style="list-style-type: none"> <li>Noise is generated.</li> </ul>	The track played back is not an MP3/WMA track (although it has the extension code <.mp3> or <.wma>).	Skip to another track or change the disc. (Do not add the extension code <.mp3> or <.wma> to non-MP3 or WMA tracks.)
	<ul style="list-style-type: none"> <li>A longer readout time is required (“CHECK” keeps flashing on the display).</li> </ul>	Readout time varies due to the complexity of the folder/file configuration.	Do not use too many hierarchies and folders.
	<ul style="list-style-type: none"> <li>Tracks cannot be played back as you have intended them to play.</li> </ul>	Playback order is determined when the files are recorded.	_____
	<ul style="list-style-type: none"> <li>Elapsed playing time is not correct.</li> </ul>	This sometimes occurs during play. This is caused by how the tracks are recorded on the disc.	_____
	<ul style="list-style-type: none"> <li>“NO FILES” appears on the display.</li> </ul>	The current disc does not contain any MP3/WMA tracks.	Insert a disc that contains MP3/WMA tracks.
<ul style="list-style-type: none"> <li>Correct characters are not displayed (e.g. album name).</li> </ul>	This receiver can only display alphabets (capital: A – Z), numbers, and a limited number of symbols.	_____	

# Specifications

## AUDIO AMPLIFIER SECTION

Maximum Power Output:

Front: 50 W per channel

Rear: 50 W per channel

Continuous Power Output (RMS):

Front: 19 W per channel into 4  $\Omega$ , 40 Hz to 20 000 Hz at no more than 0.8% total harmonic distortion.

Rear: 19 W per channel into 4  $\Omega$ , 40 Hz to 20 000 Hz at no more than 0.8% total harmonic distortion.

Load Impedance: 4  $\Omega$  (4  $\Omega$  to 8  $\Omega$  allowance)

Tone Control Range:

Bass:  $\pm 10$  dB at 100 Hz

Treble:  $\pm 10$  dB at 10 kHz

Frequency Response: 40 Hz to 20 000 Hz

Signal-to-Noise Ratio: 70 dB

Line-Out Level/Impedance:

2.5 V/20 k $\Omega$  load (full scale)

Output Impedance: 1 k $\Omega$

## TUNER SECTION

Frequency Range:

FM: 87.5 MHz to 108.0 MHz

AM: (MW) 522 kHz to 1 620 kHz  
(LW) 144 kHz to 279 kHz

### [FM Tuner]

Usable Sensitivity: 11.3 dBf (1.0  $\mu$ V/75  $\Omega$ )

50 dB Quieting Sensitivity:

16.3 dBf (1.8  $\mu$ V/75  $\Omega$ )

Alternate Channel Selectivity (400 kHz): 65 dB

Frequency Response: 40 Hz to 15 000 Hz

Stereo Separation: 30 dB

Capture Ratio: 1.5 dB

### [MW Tuner]

Sensitivity: 20  $\mu$ V

Selectivity: 35 dB

### [LW Tuner]

Sensitivity: 50  $\mu$ V

## CD PLAYER SECTION

Type: Compact disc player

Signal Detection System: Non-contact optical pickup (semiconductor laser)

Number of channels: 2 channels (stereo)

Frequency Response: 5 Hz to 20 000 Hz

Dynamic Range: 96 dB

Signal-to-Noise Ratio: 98 dB

Wow and Flutter: Less than measurable limit

MP3 decoding format:

MPEG1/2 Audio Layer 3

Max. Bit Rate: 320 Kbps

WMA (Windows Media® Audio) decoding format:

Max. Bit Rate: 192 Kbps

## GENERAL

Power Requirement:

Operating Voltage:

DC 14.4 V (11 V to 16 V allowance)

Grounding System: Negative ground

Allowable Operating Temperature:

0°C to +40°C

Dimensions (W  $\times$  H  $\times$  D):

Installation Size (approx.):

182 mm  $\times$  52 mm  $\times$  150 mm

Panel Size (approx.):

188 mm  $\times$  58 mm  $\times$  11 mm

Mass (approx.):

1.3 kg (excluding accessories)

*Design and specifications are subject to change without notice.*

- Microsoft and Windows Media are either registered trademarks or trademarks of Microsoft Corporation in the United States and/or other countries.



**Having TROUBLE with operation?**

**Please reset your unit**

**Refer to page of How to reset your unit**

**Haben Sie PROBLEME mit dem Betrieb?**

**Bitte setzen Sie Ihr Gerät zurück**

**Siehe Seite Zurücksetzen des Geräts**

**Затруднения при эксплуатации?**

**Пожалуйста, перезагрузите Ваше устройство**

**Для получения информации о перезагрузке Вашего устройства обратитесь на соответствующую страницу**

**JVC**



EN, GE, RU

© 2004 Victor Company of Japan, Limited

1004DTSMDTJEIN

#### ENGLISH

This receiver is designed to operate on **12 V DC, NEGATIVE ground electrical systems**. If your vehicle does not have this system, a voltage inverter is required, which can be purchased at JVC IN-CAR ENTERTAINMENT dealers.

#### DEUTSCH

Dieses Gerät ist für einen Betrieb in **elektrischen Anlagen mit 12 V Gleichstrom und (-) Erdung ausgelegt**. Verfügt Ihr Fahrzeug nicht über diese Anlage, ist ein Spannungsinverter erforderlich, der bei JVC Autoradiohändler erworben werden kann.

#### РУССКИЙ

Это устройство разработано для эксплуатации на **12 В постоянного напряжения с минусом на массе**. Если Ваш автомобиль не имеет этой системы, требуется инвертор напряжения, который может быть приобретен у дилера автомобильного специалиста JVC.

#### Parts list for installation and connection

The following parts are provided for this receiver. After checking them, please set them correctly.

#### Teileliste für den Einbau und Anschluß

Die folgenden Teile werden zusammen mit diesem Gerät geliefert. Nach ihrer Überprüfung, die Teile richtig einsetzen.

#### Список деталей для установки и подключения

Следующие детали поставлены в комплекте с устройством. После проверки комплектации, пожалуйста, установите их правильно.

(A) / (B)  
Hard case/Control panel  
Etui/Schalttafel  
Жесткий футляр/панель управления

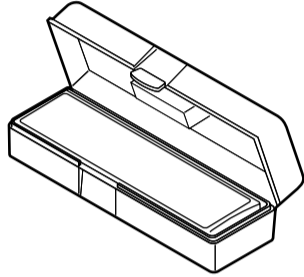

(C)  
Sleeve  
Halterung  
Муфта

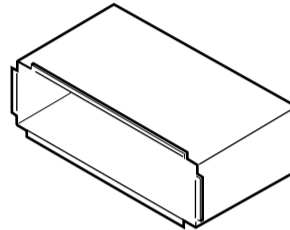

(D)  
Trim plate  
Frontrahmen  
Декоративную панель

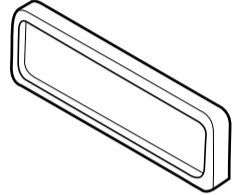

(E)  
Power cord  
Stromkable  
Кабель питания

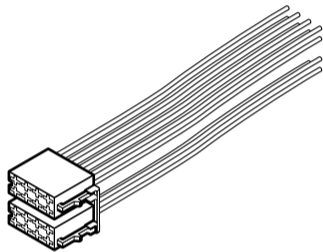

(F)  
Washer (ø5)  
Unterlegscheibe (ø5)  
Шайба (н5)



(G)  
Lock nut (M5)  
Sicherungsmutter (M5)  
Фиксирующая гайка (M5)



(H)  
Mounting bolt (M5 x 20 mm)  
Befestigungsschraube (M5 x 20 mm)  
Крепежный болт (M5 x 20 мм)

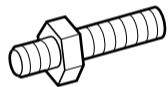

(I)  
Rubber cushion  
Gummipuffer  
Резиновый чехол



(J)  
Handles  
Griffe  
Рычаги

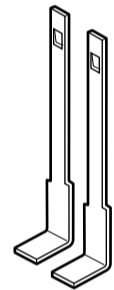

## INSTALLATION (IN-DASH MOUNTING)

The following illustration shows a typical installation. If you have any questions or require information regarding installation kits, consult your JVC IN-CAR ENTERTAINMENT dealer or a company supplying kits.

- If you are not sure how to install this receiver correctly, have it installed by a qualified technician.

## EINBAU (IM ARMATURENBRETT)

Die folgende Abbildung zeigt einen typischen Einbau. Bei irgendwelchen Fragen oder wenn Sie Informationen hinsichtlich des Einbausatzes brauchen, wenden Sie sich an ihren JVC Autoradiohändler oder ein Unternehmen das diese Einbausätze vertreibt.

- Sind Sie sich über den richtigen Einbau des Geräts nicht sicher, lassen Sie es von einem qualifizierten Techniker einbauen.

## УСТАНОВКА (УСТАНОВКА В ПРИБОРНУЮ ПАНЕЛЬ)

На следующих иллюстрациях показана типовая установка. Если у Вас есть какие-либо вопросы, касающиеся установки, обратитесь к Вашему дилеру автомобильного специалиста JVC или в компанию, поставляющую соответствующие принадлежности.

- Если Вы не знаете точно, как следует устанавливать это устройство, обратитесь к квалифицированному специалисту.

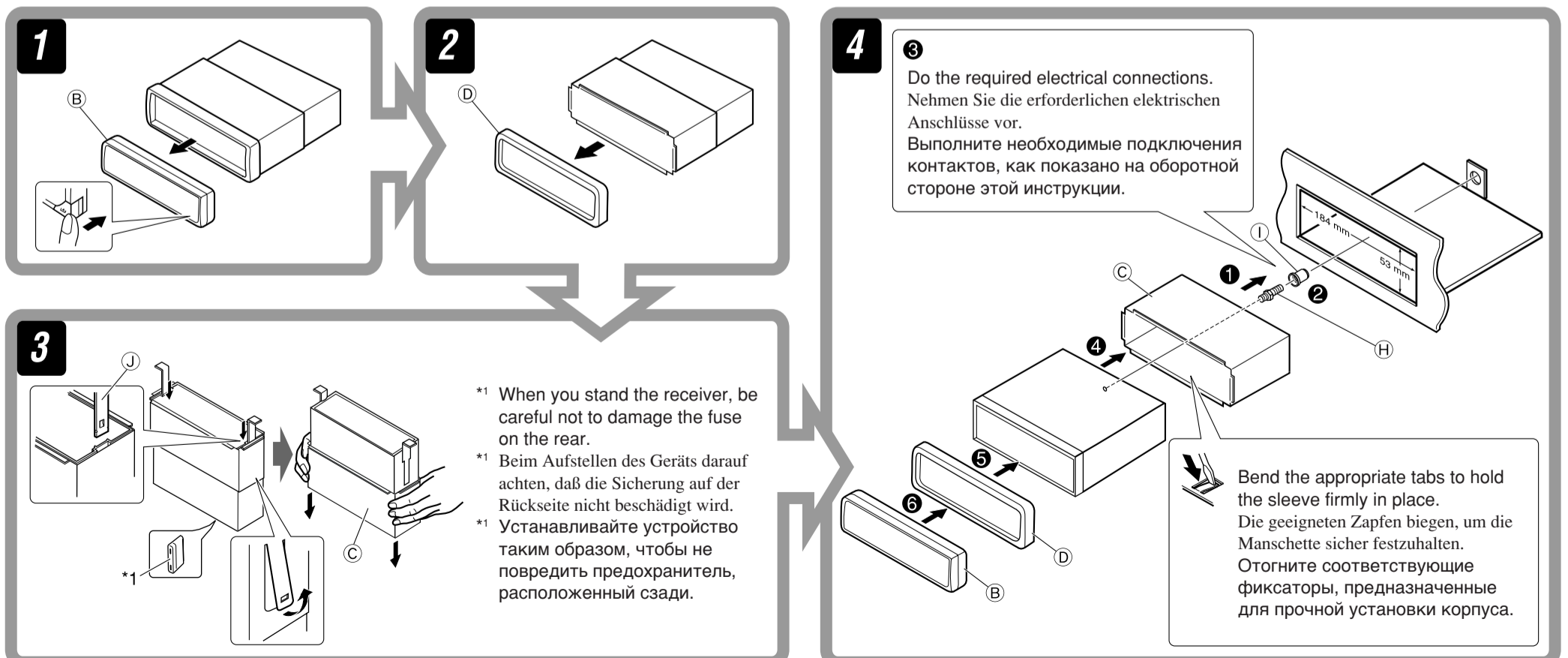

## Removing the receiver

Before removing the receiver, release the rear section.

## Ausbau des Geräts

Vor dem Ausbau des Geräts den hinteren Teil freigeben.

## Удаление устройства

Перед удалением устройства освободите заднюю часть.

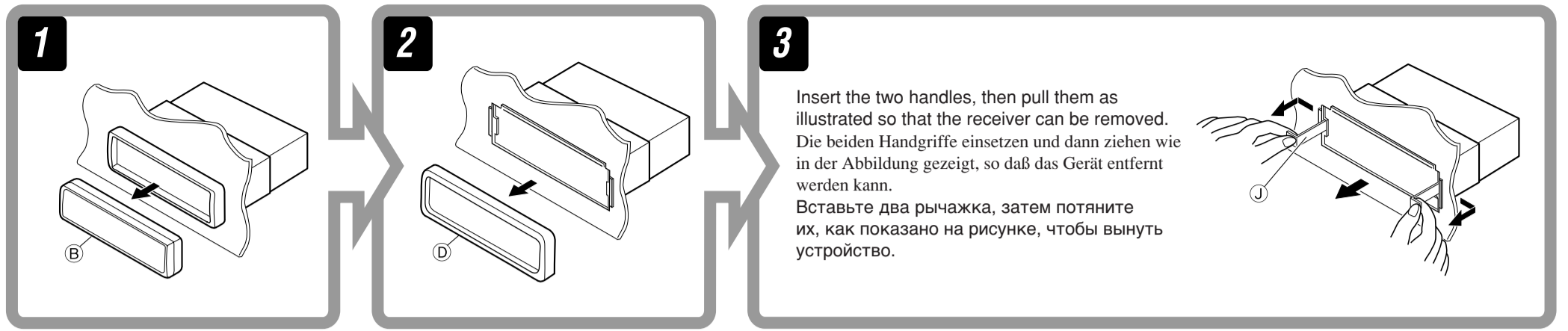

### When using the optional stay / Beim Verwenden der Anker-Option / При использовании дополнительной стойки

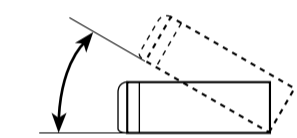
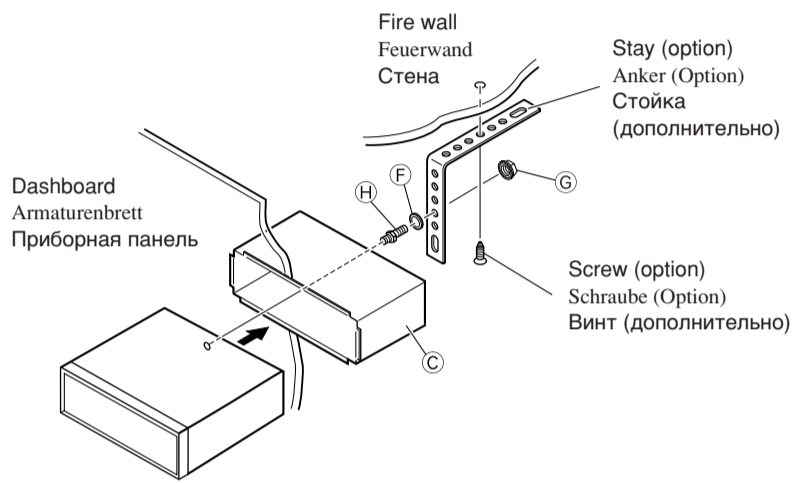

Install the receiver at an angle of less than 30°. Stellen Sie das Gerät mit einem Winkel von weniger als 30° auf. Установите устройство под углом менее 30°.

### When installing the receiver without using the sleeve / Beim Einbau des Geräts ohne Halterung / При установке устройства без использования муфты

In a Toyota for example, first remove the car radio and install the receiver in its place.

Zum Beispiel in einem Toyota zuerst das Autoradio ausbauen und dann das Gerät an seinem Platz einbauen.

В автомобилях "Toyota", например, сначала удалите автомобильную магнитолу, затем установите на ее место это устройство.

Flat type screws (M5 x 8 mm)\*  
Senkkopfschrauben (M5 x 8 mm)\*  
Крепежные винты (M5 x 8 мм)\*

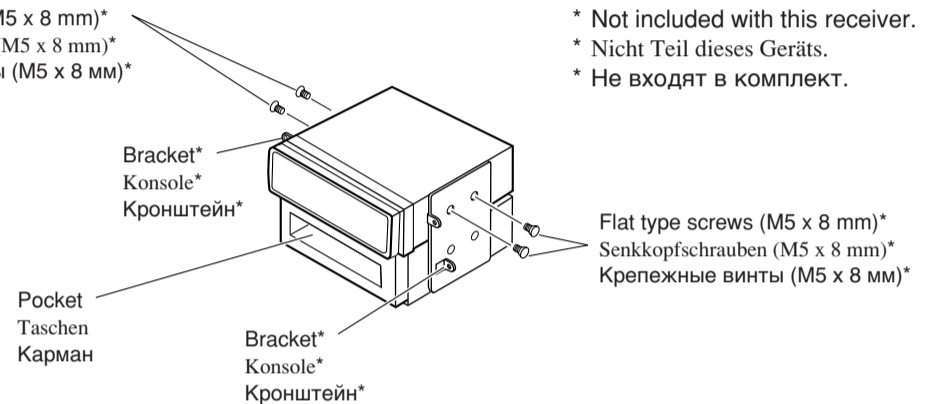

\* Not included with this receiver.  
\* Nicht Teil dieses Geräts.  
\* Не входят в комплект.

#### Note

: When installing the receiver on the mounting bracket, make sure to use the 8 mm-long screws. If longer screws are used, they could damage the receiver.

#### Hinweis

: Beim Anbringen des Gerät an der Konsole sicherstellen, daß 8 mm lange Schrauben verwendet werden. Werden längere Schrauben verwendet, können sie das Gerät beschädigen.

#### Примечание

: При установке устройства на крепежный кронштейн, используйте только винты длиной 8 мм. При использовании более длинных винтов можно повредить устройство.

## ELECTRICAL CONNECTIONS

To prevent short circuits, we recommend that you disconnect the battery's negative terminal and make all electrical connections before installing the receiver.

- Be sure to ground this receiver to the car's chassis again after installation.

#### Notes:

- Replace the fuse with one of the specified rating. If the fuse blows frequently, consult your JVC IN-CAR ENTERTAINMENT dealer.
- It is recommended to connect to the speakers with maximum power of more than 50 W (both at the rear and at the front, with an impedance of 4 Ω to 8 Ω). If the maximum power is less than 50 W, change "AMP GAIN" setting to prevent the speakers from being damaged (see page 21 of the INSTRUCTIONS).
- To prevent short-circuit, cover the terminals of the UNUSED leads with insulating tape.
- The heat sink becomes very hot after use. Be careful not to touch it when removing this receiver.

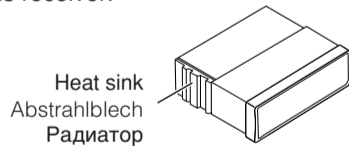

## ELEKTRISCHE ANSCHLÜSSE

Zur Vermeidung von Kurzschlüssen empfehlen wir, daß Sie den negativen Batterieanschluß abtrennen und alle elektrischen Anschlüsse herstellen, bevor das Gerät eingebaut wird.

- Sicherstellen, daß das Gerät nach dem Einbau an Chassis des Fahrzeugs geerdet wird.

#### Hinweise:

- Die Sicherung mit einer der entsprechenden Nennleistung ersetzen. Brennt die Sicherung häufig durch, wenden Sie sich an ihren JVC Autoradiohändler.
- Es wird empfohlen, Lautsprecher mit einer Maximalleistung von mehr als 50 W anzuschließen (sowohl hinten als auch vorne, mit einer Impedanz von 4 Ω bis 8 Ω). Wenn die Maximalleistung weniger als 50 W beträgt, stellen Sie „AMP GAIN“ anders ein, um Schäden an den Lautsprechern zu vermeiden (siehe Seite 21 der BEDIENUNGSANLEITUNG).
- Zur Vermeidung eines Kurzschlusses die Anschlußklemmen der NICHT VERWENDETEN Leitungen mit Isolierklebeband umwickeln.
- Das Abstrahlblech wird nach dem Gebrauch sehr heiß. Beim Ausbau des Geräts darauf achten, das Abstrahlblech nicht zu berühren.

## ЭЛЕКТРИЧЕСКИЕ ПОДКЛЮЧЕНИЯ

Для предотвращения коротких замыканий мы рекомендуем Вам отсоединить отрицательный разъем аккумулятора и осуществить все подключения перед установкой устройства.

- После установки обязательно заземлите данное устройство на шасси автомобиля.

#### Примечания:

- Заменяйте предохранитель другим предохранителем указанного класса. Если предохранитель сгорает слишком часто, обратитесь к дилеру автомобильного специалиста JVC.
- Рекомендуется подключать динамики с максимальной мощностью более 50 Вт (к задней и передней панели устройства, с полным сопротивлением от 4 Ω до 8 Ω). Если максимальная мощность динамиков менее 50 Вт, перейдите в режим "AMP GAIN", чтобы предотвратить их повреждение (см. ИНСТРУКЦИИ ПО ЭКСПЛУАТАЦИИ на стр. 21).
- Для предотвращения короткого замыкания заклейте НЕИСПОЛЬЗУЕМЫЕ концы изолирующей лентой.
- Радиатор во время использования сильно нагревается. Старайтесь его не трогать во время удаления устройства.

## TROUBLESHOOTING

#### • The fuse blows.

- \* Are the red and black leads connected correctly?

#### • Power cannot be turned on.

- \* Is the yellow lead connected?

#### • No sound from the speakers.

- \* Is the speaker output lead short-circuited?

#### • Sound is distorted.

- \* Is the speaker output lead grounded?
- \* Are the "-" terminals of L and R speakers grounded in common?

#### • Noise interfere with sounds.

- \* Is the rear ground terminal connected to the car's chassis using shorter and thicker cords?

#### • Receiver becomes hot.

- \* Is the speaker output lead grounded?
- \* Are the "-" terminals of L and R speakers grounded in common?

#### • This receiver does not work at all.

- \* Have you reset your receiver?

## FEHLERSUCHE

#### • Die Sicherung brennt durch.

- \* Sind die roten und schwarzen Leitungen richtig angeschlossen?

#### • Stromversorgung kann nicht eingeschaltet werden.

- \* Ist die gelbe Leitung angeschlossen?

#### • Kein Ton aus den Lautsprechern.

- \* Ist die LautsprecherAusgangsleitung kurzgeschlossen?

#### • Ton verzerrt.

- \* Ist die LautsprecherAusgangsleitung geerdet?
- \* Sind die (-) Anschlußklemmen der linken und rechten Lautsprecher zusammen geerdet?

#### • Störgeräusche im Klang.

- \* Ist die hintere Erdungsklemme mit kürzeren und dickeren Kabeln an das Fahrzeugchassis angeschlossen?

#### • Gerät wird heiß.

- \* Ist die LautsprecherAusgangsleitung geerdet?
- \* Sind die (-) Anschlußklemmen der linken und rechten Lautsprecher zusammen geerdet?

#### • Dieser Receiver funktioniert überhaupt nicht.

- \* Haben Sie einen Reset am Receiver vorgenommen?

## ВЫЯВЛЕНИЕ НЕИСПРАВНОСТЕЙ

#### • Сработал предохранитель.

- \* Правильно ли подключены черный и красный провода?

#### • Питание не включается.

- \* Подключен ли желтый провод?

#### • Звук не выводится через громкоговорители.

- \* Нет ли короткого замыкания на кабеле выхода громкоговорителей?

#### • Звук искажен.

- \* Заземлен ли провод выхода громкоговорителей?
- \* Заземлены ли разъемы "-" правого (R) и левого (L) громкоговорителей?

#### • Шум мешает звучанию.

- \* Соединен ли находящийся сзади зажим заземления с шасси автомобиля с помощью более короткого и тонкого шнура?

#### • Устройство нагревается.

- \* Заземлен ли провод выхода громкоговорителей?
- \* Заземлены ли разъемы "-" правого (R) и левого (L) громкоговорителей?

#### • Приемник не работает.

- \* Выполнена ли перенастройка приемника?



**A Typical Connections / Typische Anschlüsse / Типичные подключения**

**Before connecting:** Check the wiring in the vehicle carefully. Incorrect connection may cause serious damage to this receiver.

The leads of the power cord and those of the connector from the car body may be different in color.

- 1 Connect the colored leads of the power cord in the order specified in the illustration below.
- 2 Connect the aerial cord.
- 3 Finally connect the wiring harness to the receiver.

**Note:** If your vehicle does not have any accessory terminal, move the fuse from the fuse position 1 (initial position) to fuse position 2, and connect the red lead (A7) to the positive (+) battery terminal.

- The yellow lead (A4) is not used in this case.

**Vor dem Anschließen:** Die Verdrahtung im Fahrzeug sorgfältig überprüfen. Falsche Anschlüsse können ernsthafte Schäden am Gerät hervorrufen.

Die Leiter des Stromkabels und die Leiter des Anschlusses im Fahrzeug können sich farblich unterscheiden.

- 1 Die farbigen Adern des Stromkabels in der Reihenfolge anschließen, wie in der Abbildung unten gezeigt.
- 2 Das Antennenkabel anschließen.
- 3 Die Kabelbäume am Gerät anschließen.

**Hinweis:** Verfügt Ihr Fahrzeug nicht über eine Zubehöransteckklemme, die Sicherung von der 1. Sicherungsposition (Erstposition) in die 2. Sicherungsposition versetzen, die rote Leitung (A7) an der (+) Batterieanschlusssklemme anschließen.

- Die gelbe Leitung (A4) wird in diesem Fall nicht verwendet.

**Перед началом подключений:** Тщательно проверьте проводку в автомобиле. Неправильное подключение может привести к серьезному повреждению устройства. Жилы силового кабеля и жилы соединителя от кузова автомобиля могут быть разного цвета.

- 1 Подсоедините цветные провода шнура питания в указанном ниже порядке.
- 2 Подключите кабель антенны.
- 3 В последнюю очередь подключите электропроводку к устройству.

**Примечание:** Если в Вашем автомобиле никакого вспомогательного разъема не имеется, переставьте предохранитель из положения 1 предохранителя (первоначальное положение) в положение 2 предохранителя и подключите красный провод (A7) к положительному (+) полюсу аккумулятора.

- Желтый провод (A4) в этом случае не используется.

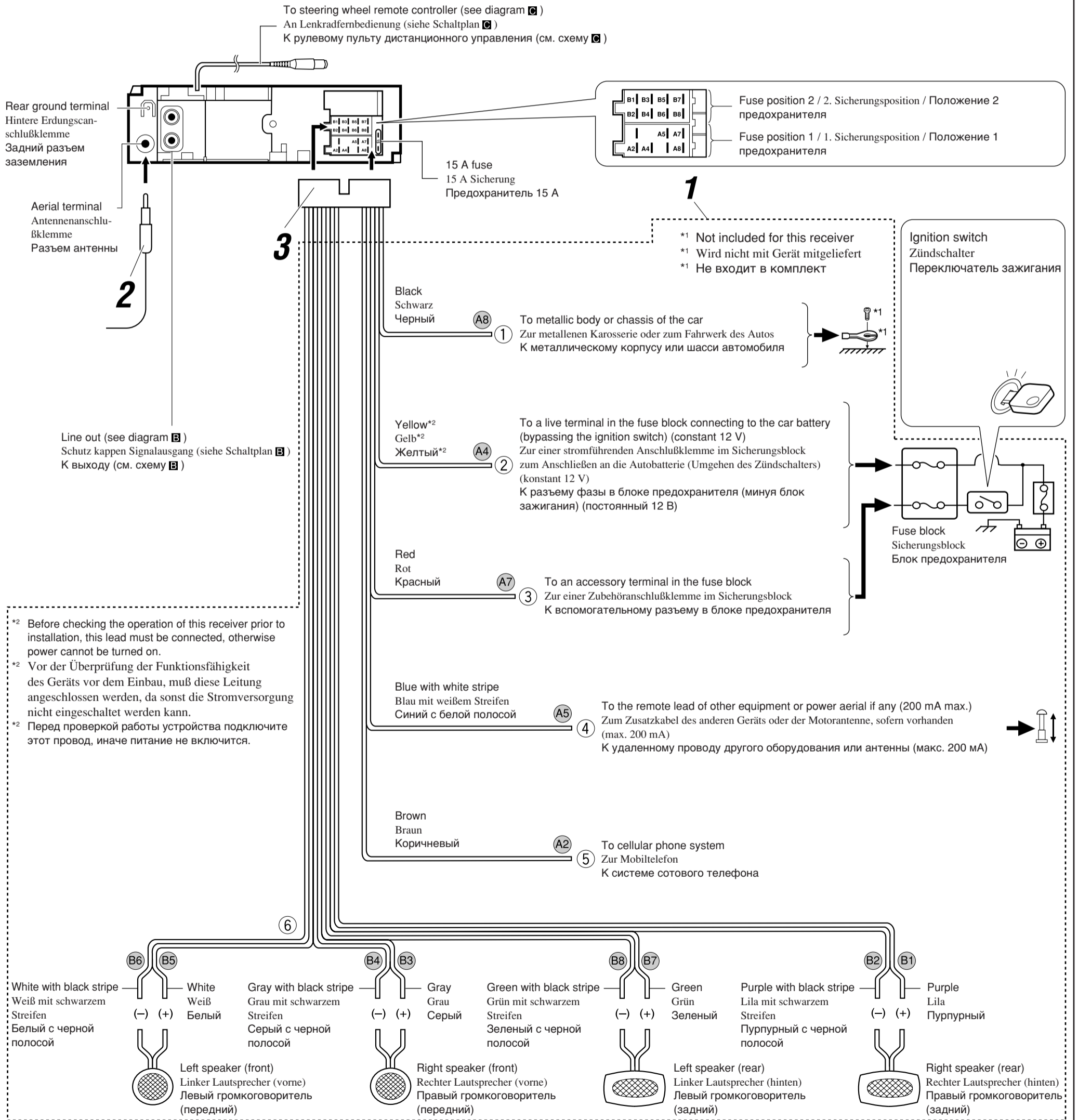

## B Connecting the external amplifier / Anschließen des externen Verstärkers / Подключение внешнего усилителя

You can connect an amplifier to upgrade your car stereo system.

- Connect the remote lead (blue with white stripe) to the remote lead of the other equipment so that it can be controlled through this receiver.
- **Disconnect the speakers from this receiver, connect them to the amplifier. Leave the speaker leads of this receiver unused.**

Sie können einen Verstärker anschließen, um Ihre Autostereoanlage zu erweitern.

- Schließen Sie das Fernbedienungskabel (blau mit weißem Streifen) an das Fernbedienungskabel des anderen Geräts an, so daß es über dieses Gerät gesteuert werden kann.
- **Die Lautsprecher von diesem Gerät abtrennen und am Verstärker anschließen. Die Lautsprecherleitungen dieses Geräts unbenutzt lassen.**

Можно подключить усилитель для обновления автомобильной стереосистемы.

- Подсоедините провод внешнего устройства (синий с белой полосой) к проводу внешнего устройства другого оборудования так, чтобы им можно было управлять с этого устройства.
- **Отсоедините громкоговорители от данного устройства, подключите их к усилителю. Оставьте провода громкоговорителей данного устройства неиспользованными.**

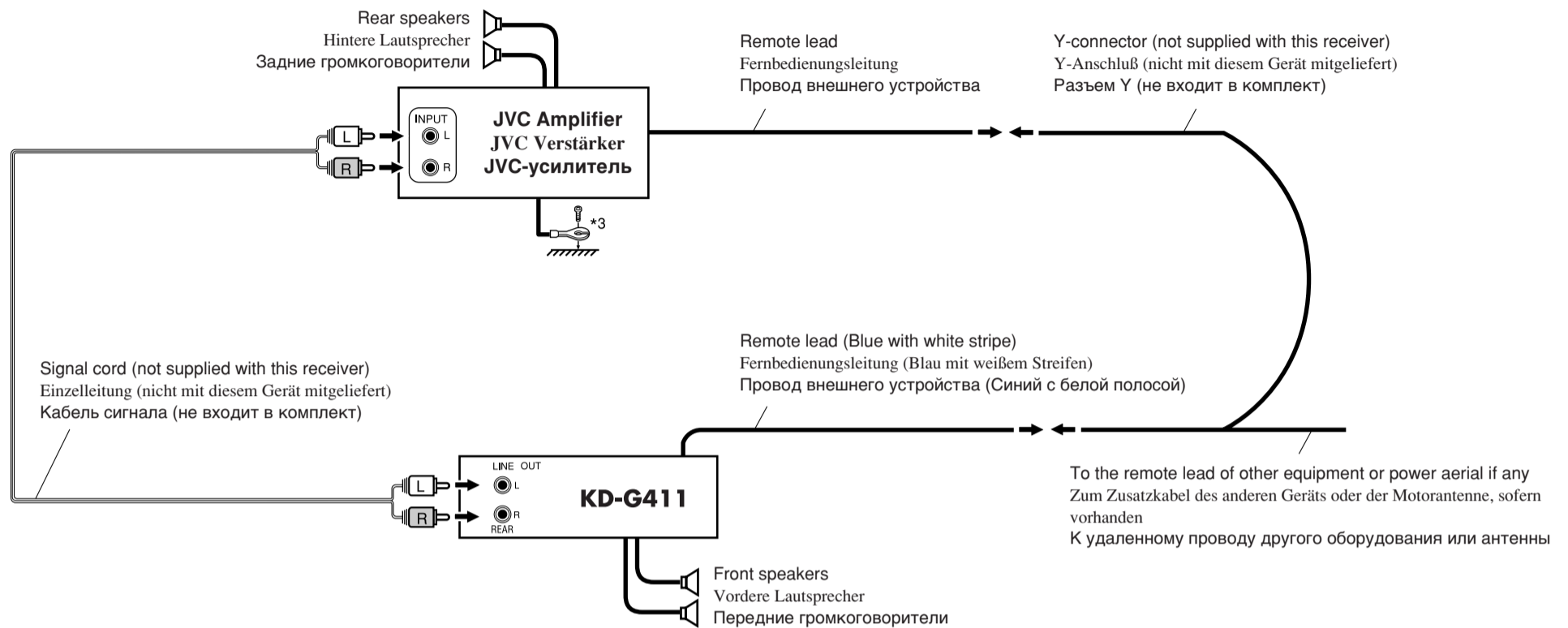

\*3 Firmly attach the ground wire to the metallic body or to the chassis of the car—to the place not coated with paint (if coated with paint, remove the paint before attaching the wire). Failure to do so may cause damage to the receiver.

\*3 Verbinden Sie den Erdungsleiter mit der Karosserie oder dem Rahmen des Fahrzeugs. Die Kontaktstelle darf nicht lackiert sein (sollte die Kontaktstelle lackiert sein, entfernen Sie den Lack der Kontaktstelle, bevor Sie den Leiter befestigen). Wenn der Erdungsleiter nicht ordnungsgemäß angeschlossen wird, kann dieses Gerät beschädigt werden.

\*3 Плотно прикрепите заземляющий провод к металлическому кузову или шасси автомобиля—в месте, не покрытом краской (если оно покрыто краской, удалите краску перед тем, как прикреплять провод). Невыполнение этого требования может привести к повреждению данного устройства.

## C Connecting to the steering wheel remote controller / Anschluß an die Lenkradfernbedienung / Подключение к рулевому пульту дистанционного управления

If your car is equipped with the steering wheel remote controller, you can operate this receiver using the controller. To do it, a JVC's OE remote adapter (not supplied) which matches with your car is required. Consult your JVC IN-CAR ENTERTAINMENT dealer for details.

Wenn Ihr Fahrzeug mit einer Lenkradfernbedienung ausgestattet ist, können Sie damit diesen Receiver steuern. Hierfür ist ein für Ihr Fahrzeug passender Radio-Lenkrad-Fernbedienungsadapter von JVC (nicht im Lieferumfang enthalten) erforderlich. Für weitere Einzelheiten wenden Sie sich an Ihren JVC Autoradiohändler.

Если автомобиль оборудован рулевым пультом дистанционного управления, его можно использовать для управления данным устройством. Для этого необходим адаптер рулевого пульта дистанционного управления JVC OE (не поставляется), подходящий для Вашего автомобиля. За более подробной информацией обратитесь к поставщику автомобильных аудиосистем компании JVC.

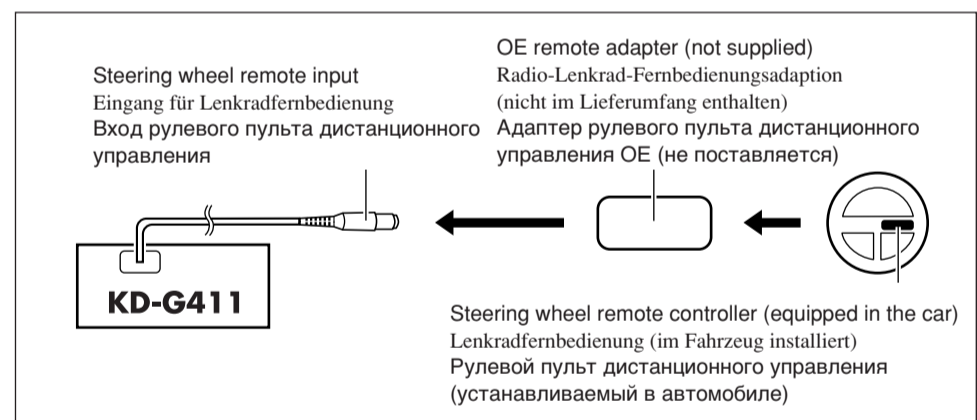

### PRECAUTIONS on power supply and speaker connections:

- **DO NOT** connect the speaker leads of the power cord to the car battery; otherwise, the receiver will be seriously damaged.
- **BEFORE** connecting the speaker leads of the power cord to the speakers, check the speaker wiring in your car.

### VORSICHTSMASSREGELN beim Anschließen der Stromversorgung und Lautsprecher:

- Die Lautsprecherleitungen des Netzkabels **NICHT** an der Autobatterie anschließen, da sonst das Gerät schwer beschädigt wird.
- VOR dem Anschließen der Lautsprecherleitungen des Spannungsversorgungskabels an die Lautsprecher, die Lautsprecherverdrahtung in Ihrem Auto überprüfen.

### ПРЕДОСТЕРЕЖЕНИЯ по питанию и подключению громкоговорителей:

- **НЕ** подключайте провода громкоговорителей к аккумулятору автомобиля, иначе устройство будет повреждено.
- **ПЕРЕД** подключением проводов громкоговорителей к кабелю питания громкоговорителя проверьте схему соединений громкоговорителей в Вашем автомобиле.

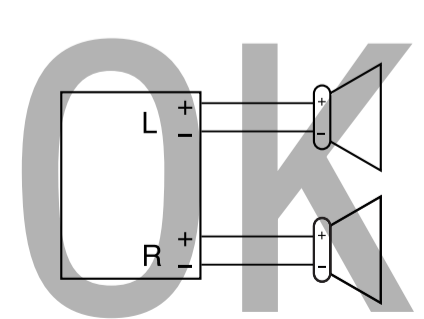
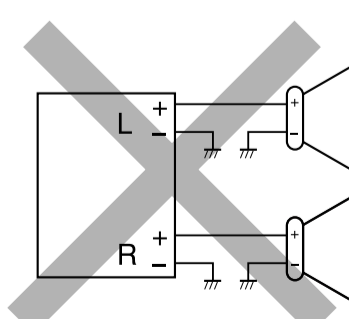
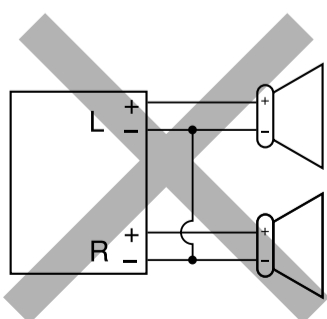

## Free Manuals Download Website

<http://myh66.com>

<http://usermanuals.us>

<http://www.somanuals.com>

<http://www.4manuals.cc>

<http://www.manual-lib.com>

<http://www.404manual.com>

<http://www.luxmanual.com>

<http://aubethermostatmanual.com>

Golf course search by state

<http://golfingnear.com>

Email search by domain

<http://emailbydomain.com>

Auto manuals search

<http://auto.somanuals.com>

TV manuals search

<http://tv.somanuals.com>