

JVC



CD RECEIVER

KD-AR470/KD-G420

ENGLISH

RECEPTOR CON CD

KD-AR470/KD-G420

ESPAÑOL

RECEPTEUR CD

KD-AR470/KD-G420

FRANÇAIS



**MP3
WMA**

**SAT
RADIO
READY**

**COMPACT
DISC
DIGITAL AUDIO
TEXT**

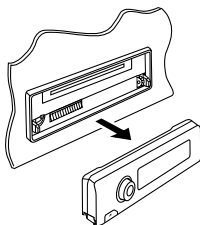
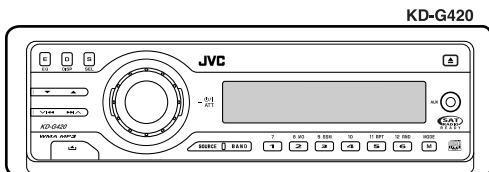
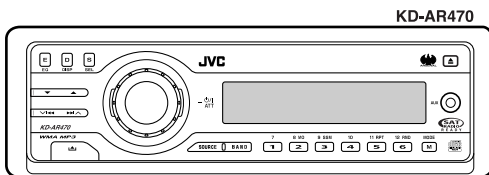

For canceling the display demonstration, see page 7.

Para cancelar la demostración en pantalla, consulte la página 7.

Pour annuler la démonstration des affichages, référez-vous à la page 7.

For installation and connections, refer to the separate manual.

Para la instalación y las conexiones, refiérase al manual separado.

Pour l'installation et les raccordements, se référer au manuel séparé.

For customer Use:

Enter below the Model No. and Serial No. which are located on the top or bottom of the cabinet. Retain this information for future reference.

Model No. _____

Serial No. _____

INSTRUCTIONS

MANUAL DE INSTRUCCIONES
MANUEL D'INSTRUCTIONS

GET0336-001A

[J]

Thank you for purchasing a JVC product.

Please read all instructions carefully before operation, to ensure your complete understanding and to obtain the best possible performance from the unit.

INFORMATION (For U.S.A.)

This equipment has been tested and found to comply with the limits for a Class B digital device, pursuant to Part 15 of the FCC Rules. These limits are designed to provide reasonable protection against harmful interference in a residential installation. This equipment generates, uses, and can radiate radio frequency energy and, if not installed and used in accordance with the instructions, may cause harmful interference to radio communications. However, there is no guarantee that interference will not occur in a particular installation. If this equipment does cause harmful interference to radio or television reception, which can be determined by turning the equipment off and on, the user is encouraged to try to correct the interference by one or more of the following measures:

- Reorient or relocate the receiving antenna.
- Increase the separation between the equipment and receiver.
- Connect the equipment into an outlet on a circuit different from that to which the receiver is connected.
- Consult the dealer or an experienced radio/TV technician for help.

IMPORTANT FOR LASER PRODUCTS

1. CLASS 1 LASER PRODUCT
2. **CAUTION:** Do not open the top cover. There are no user serviceable parts inside the unit; leave all servicing to qualified service personnel.
3. **CAUTION:** Visible and invisible laser radiation when open and interlock failed or defeated. Avoid direct exposure to beam.

How to reset your unit

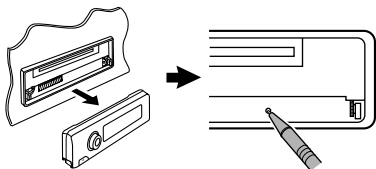

Your preset adjustments will also be erased.

How to forcibly eject a disc



“PLEASE” and “EJECT” appear alternately on the display.

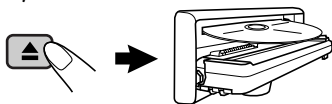

- If this does not work, reset your unit.
- Be careful not to drop the disc when it ejects.

How to use the M MODE button

If you press M MODE, the unit goes into functions mode, then the number buttons and ▲/▼ buttons work as different function buttons.



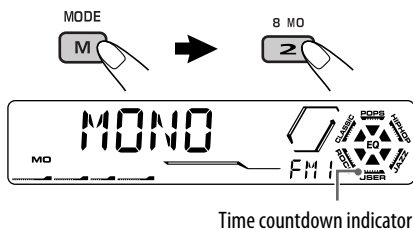

Ex.: When number button 2 works as MO (monaural) button.





To use these buttons for their original functions again after pressing M MODE, wait for 5 seconds without pressing any of these buttons until the functions mode is cleared or press M MODE again.

How to read this manual

- Button operations are mainly explained with the illustrations in the table below.
- Some related tips and notes are explained in “More about this unit” (see pages 20 – 22).

	Press briefly.
	Press repeatedly.
	Press either one.
	Press and hold until your desired response begins.
	Press and hold both buttons at the same time.

The following marks are used to indicate...

-  : Built-in CD player operations.
-  : External CD changer operations.
-  : Indicator displayed for the corresponding operation.

How to detach/attach the control panel

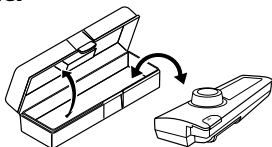

Detaching...

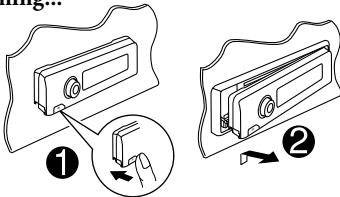

Attaching...

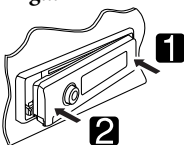

CONTENTS

Control panel — KD-AR470 and KD-G420	4
Remote controller — RM-RK50	5
Getting started	6
Basic operations.....	6
Radio operations	7
Disc operations	8
Playing a disc in the unit	8
Playing discs in the CD changer	9
Sound adjustments	11
General settings — PSM	12
Title assignment	15
External component operations	16
Satellite radio operations	17
More about this unit	20
Maintenance	22
Troubleshooting	23
Specifications	25

Warning:

If you need to operate the unit while driving, be sure to look ahead carefully or you may be involved in a traffic accident.

For safety...

- Do not raise the volume level too much, as this will block outside sounds, making driving dangerous.
- Stop the car before performing any complicated operations.

Temperature inside the car...

If you have parked the car for a long time in hot or cold weather, wait until the temperature in the car becomes normal before operating the unit.

Control panel — KD-AR470 and KD-G420

Parts identification

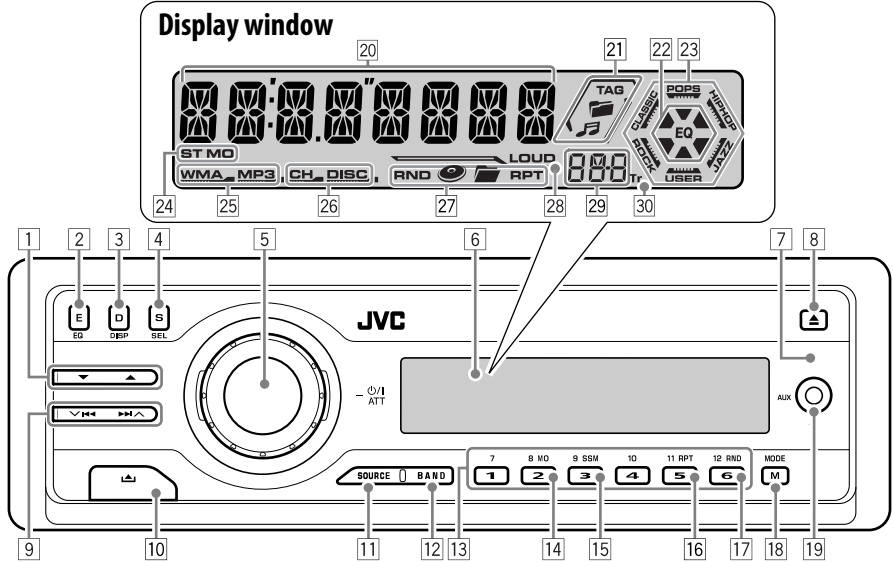

- 1 ▲ (up) / ▼ (down) buttons
- 2 E EQ (equalizer) button
- 3 D DISP (display) button
- 4 S SEL (select) button
- 5 • Control dial
 - ⏸/ATT (standby/on attenuator) button
- 6 Display window
- 7 Remote sensor
 - *DO NOT* expose the remote sensor to strong light (direct sunlight or artificial lighting).
- 8 ▲ (eject) button
- 9 ▼ ◀▶▶▶▶ ▲ buttons
- 10 🗑️ (control panel release) button
- 11 SOURCE button
- 12 BAND button
- 13 Number buttons
- 14 MO (monaural) button
- 15 SSM (Strong-station Sequential Memory) button
- 16 RPT (repeat) button
- 17 RND (random) button
- 18 M MODE button
- 19 AUX (auxiliary) input jack

Display window

- 20 Main display
- 21 Disc information indicators—TAG (ID3 Tag), 📁 (folder), 🎵 (track/file)
- 22 EQ (equalizer) indicator
- 23 Sound mode (C-EQ: custom equalizer) indicators—ROCK, CLASSIC, POPS, HIP HOP, JAZZ, USER
 - 🕒 also works as the time countdown indicator and level meter during play (see page 13).
- 24 Tuner reception indicators—ST (stereo), MO (monaural)
- 25 Disc type indicators—WMA, MP3
- 26 Playback source indicators—
 - CH: *Lights up only when CD-CH is selected as the playback source.*
 - DISC: *Lights up for the built-in CD player.*
- 27 Playback mode / item indicators—RND (random), 🎵 (disc), 📁 (folder), RPT (repeat)
- 28 LOUD (loudness) indicator
- 29 Source display / Volume level indicator
- 30 Tr (track) indicator

Remote controller — RM-RK50

RM-RK50 is supplied for KD-AR470. KD-G420 can be remotely controlled as instructed here (with an optionally purchased remote controller). We recommend you to use RM-RK50 or RM-RK60 with your unit.

Installing the lithium coin battery (CR2025)

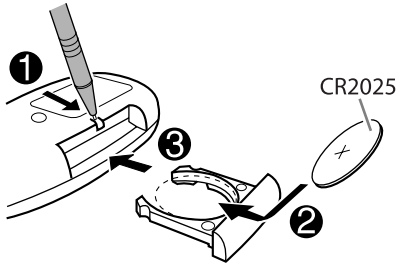

Aim the remote controller directly at the remote sensor on the unit. Make sure there is no obstacle in between.

Warning:

- Do not install any battery other than CR2025 or its equivalent; otherwise, it may explode.
- Store the battery in a place where children cannot reach to avoid risk of accident.
- To prevent the battery from over-heating, cracking, or starting a fire:
 - Do not recharge, short, disassemble, heat the battery, or dispose of it in a fire.
 - Do not leave the battery with other metallic materials.
 - Do not poke the battery with tweezers or similar tools.
 - Wrap the battery with tape and insulate when throwing away or saving it.

Caution:

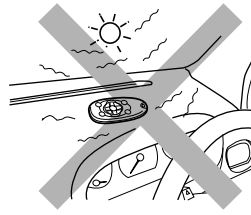

Main elements and features

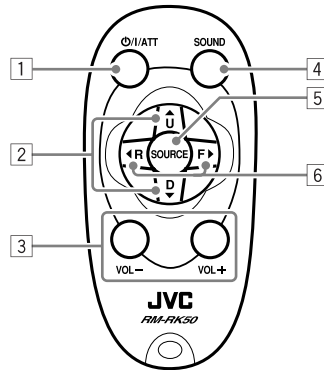

- 1 **⏻/I/ATT** (standby/on/attenuator) button
 - Turns the power on if pressed briefly or attenuates the sound when power is on.
 - Turns the power off if pressed and held.
- 2 **▲ U (up) / D (down) ▼** buttons
 - Changes the FM/AM bands with **▲ U** only.
 - Changes the preset stations with **D ▼** only.
 - Changes the folder of the MP3/WMA discs.
 - While playing an MP3 disc on an MP3-compatible CD changer:
 - Changes the disc if pressed briefly.
 - Changes the folder if pressed and held.
 - While listening to the satellite (SIRIUS or XM) radio:
 - Changes the categories.

To be continued...

- 3 VOL - / VOL + buttons
 - Adjusts the volume level.
- 4 SOUND button
 - Selects the sound mode (C-EQ: custom equalizer).
- 5 SOURCE button
 - Selects the source.
- 6 ◀ R (reverse) / F (forward) ▶ buttons
 - Searches for stations if pressed briefly.
 - Fast-forwards or reverses the track if pressed and held.
 - Changes the tracks of the disc if pressed briefly.
 - While listening to the satellite radio:
 - Changes the channels if pressed briefly.
 - Changes the channels rapidly if pressed and held.

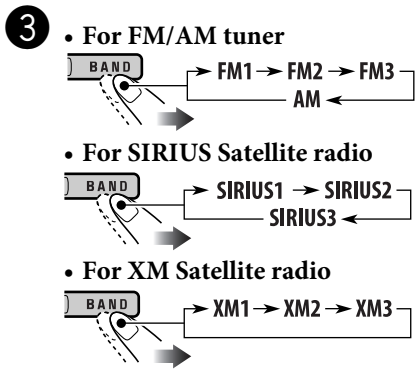

4 Adjust the volume.

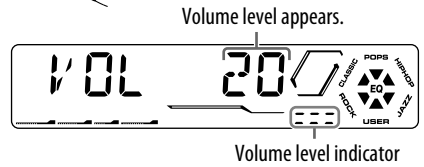
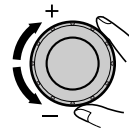

5 Adjust the sound as you want. (See pages 11 and 12.)

Getting started

Basic operations

1 Turn on the power.

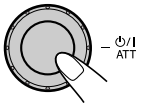

2

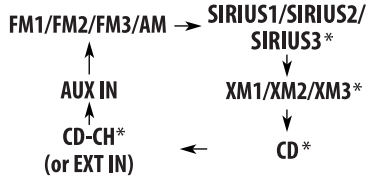

- Select "CD-CH" when using an Apple iPod® or a JVC D. player (see page 16).
iPod is a trademark of Apple Computer, Inc., registered in the U.S. and other countries.
- * You cannot select these sources if they are not ready or not connected.

Caution on volume setting:

Discs produce very little noise compared with other sources. Lower the volume before playing a disc to avoid damaging the speakers by the sudden increase of the output level.

<p>To drop the volume in a moment (ATT)</p> <p>To restore the sound, press it again.</p>	
<p>To turn off the power</p>	

Basic settings

- See also “General settings — PSM” on pages 12 – 14.

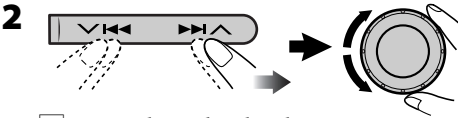

- 1 Canceling the display demonstrations**
Select “DEMO,” then “DEMO OFF.”
- 2 Setting the clock**
Select “CLOCK H” (hour), then adjust the hour.
Select “CLOCK M” (minute), then adjust the minute.

3 Finish the procedure.



To check the current clock time when the power is turned off



Radio operations

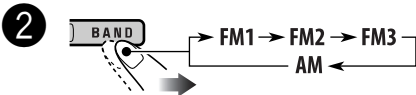
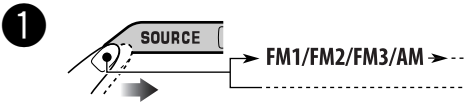

Lights up when receiving an FM stereo broadcast with sufficient signal strength.

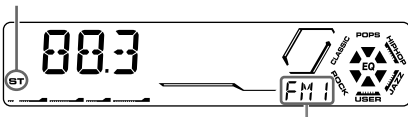

Selected band appears.

3 Start searching for a station.

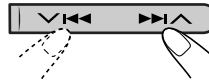

When a station is received, searching stops.

To stop searching, press the same button again.

To tune in to a station manually

In step 3 above...

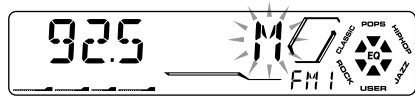
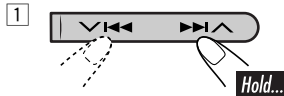

2 Select the desired station frequencies.

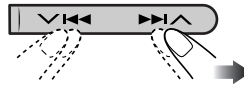

When an FM stereo broadcast is hard to receive



Lights up when monaural mode is activated.

Reception improves, but stereo effect will be lost.

To restore the stereo effect, repeat the same procedure. “MONO OFF” appears and the MO indicator goes off.

Storing stations in memory

You can preset six stations for each band.

FM station automatic presetting—SSM (Strong-station Sequential Memory)

- 1 Select the FM band (FM1 – FM3) you want to store into.



- 2 MODE button is pressed to enter memory mode (M).

- 3 9 SSM button is pressed and held. The display shows "SSM" with a "Hold...." indicator.

"SSM" flashes, then disappears when automatic presetting is over.

Local FM stations with the strongest signals are searched and stored automatically in the FM band.

Manual presetting

Ex.: Storing FM station of 92.5 MHz into preset number 4 of the FM1 band.

- 1 BAND button is pressed to select the FM1 band.

- 2 The frequency 92.5 is entered using the numeric keypad.

- 3 The 10 button (4) is pressed and held. The display shows "P4" and a recycling symbol with "POPS FREE", "CLASSED", "EQ", "RECYCLED", "SPEED", "OVER" text.

Preset number flashes for a while.

Listening to a preset station

- 1 BAND button is pressed to select a band (FM1, FM2, or FM3).

- 2 Select the preset station (1 – 6) you want.

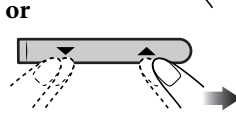

To check the other information while listening to an FM or AM station



Clock → Station name* → Frequency →
(back to the beginning)

* If no title is assigned to a station, "NO NAME" appears. To assign a title to a station, see page 15.

Disc operations

Playing a disc in the unit

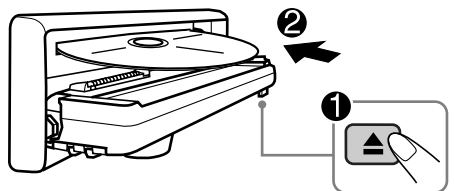

All tracks will be played repeatedly until you change the source or eject the disc.

To stop play and eject the disc



Playing discs in the CD changer

All discs in the magazine will be played repeatedly until you change the source.

- Ejecting the magazine will also stop playing.

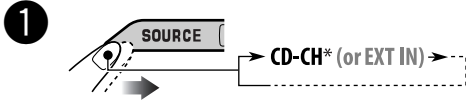

* If you have changed "EXT IN" setting to "EXT IN" (see page 14), you cannot select the CD changer.
See page 16 when using an iPod or JVC D. player.

2 Select a disc.

For disc number from 01 – 06:

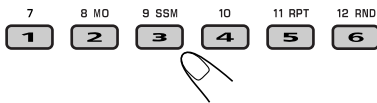

For disc number from 07 – 12:

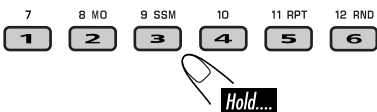

About MP3 and WMA discs

MP3 and WMA "tracks" (words "file" and "track" are used interchangeably) are recorded in "folders."

About the CD changer

It is recommended to use a JVC MP3-compatible CD changer with your unit.

- You can also connect other CH-X series CD changers (except CH-X99 and CH-X100). These units are not compatible with MP3 discs.
- You cannot play any WMA disc in the CD changer.
- You cannot use the KD-MK series CD changers with this unit.
- Disc text information recorded in the CD Text can be displayed when a JVC CD Text compatible CD changer is connected.
- For connection, see Installation/Connection Manual (separate volume).

To fast-forward or reverse the track



To go to the next or previous tracks

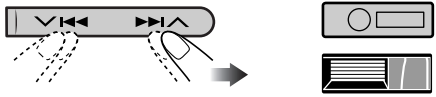

To go to the next or previous folders (only for MP3 or WMA discs)

For MP3 discs:  

For WMA discs: 

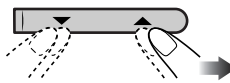

To locate a particular track (for CD) or folder (for MP3 or WMA discs) directly



To select a number from 01 – 06:

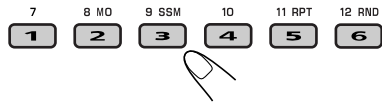

To select a number from 07 – 12:

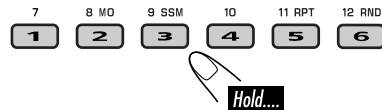

- To use folder search on MP3/WMA discs, it is required that folders are assigned with 2-digit numbers at the beginning of their folder names—01, 02, 03, and so on.

- To select a particular track in a folder (for MP3 or WMA disc):

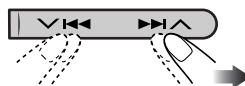

Other main functions

■ Skipping a track quickly during play



Only possible on JVC MP3-compatible CD changer

- For MP3 or WMA disc, you can skip a track within the same folder.

Ex.: To select track 32 while playing a track whose number is a single digit (1 to 9)

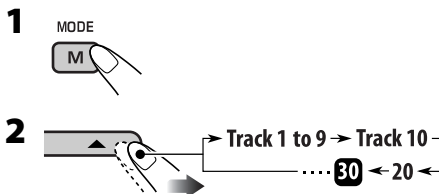

Each time you press the button, you can skip 10 tracks.

- After the last track, the first track will be selected and vice versa.



■ Prohibiting disc ejection



You can lock a disc in the loading slot.

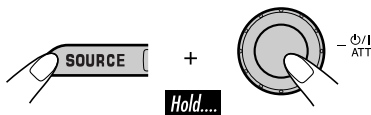

To cancel the prohibition, repeat the same procedure.



Changing the display information



■ While playing an audio CD or a CD Text



■ While playing an MP3 or a WMA*2 disc

- When "TAG DISP" is set to "TAG ON" (see page 14)

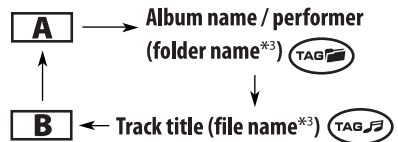

- When "TAG DISP" is set to "TAG OFF"

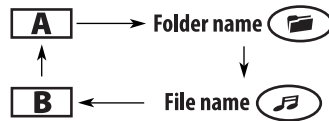

- A** : Clock with the current track number
- B** : Elapsed playing time with the current track number

*1 If the current disc is an audio CD,

"NO NAME" appears.

*2 Only for the built-in CD player.

*3 If an MP3/WMA file does not have ID3 tags, folder name and file name appear. In this case, the TAG indicator will not light up.

Selecting the playback modes

You can use only one of the following playback modes at a time.

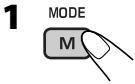

2 Select your desired playback mode.

Repeat play



Mode	Plays repeatedly
TRK RPT	: The current track.
FLDR RPT*1	: All tracks of the current folder.
DISC RPT*2	: All tracks of the current disc.
RPT OFF	: Cancels.

Random play

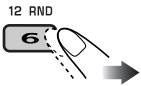

Mode	Plays at random
FLDR RND*1	: All tracks of the current folder, then tracks of the next folder and so on.
DISC RND	: All tracks of the current disc.
MAG RND*2	: All tracks of the inserted discs.
RND OFF	: Cancels.

*1 Only while playing an MP3 or a WMA disc.

*2 Only while playing discs in the CD changer.

Sound adjustments

You can select a preset sound mode suitable to the music genre (C-EQ: custom equalizer).



Preset values	BAS (bass)	TRE (treble)	LOUD (loudness)
USER (Flat sound)	00	00	OFF
ROCK (Rock or disco music)	+03	+01	ON
CLASSIC (Classical music)	+01	-02	OFF
POPS (Light music)	+04	+01	OFF
HIP HOP (Funk or rap music)	+02	00	ON
JAZZ (Jazz music)	+02	+03	OFF

Adjusting the sound

You can adjust the sound characteristics to your preference.

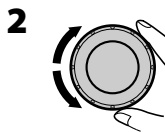
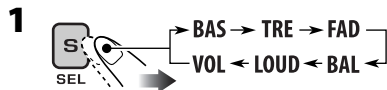

Indication pattern changes as you adjust the level.

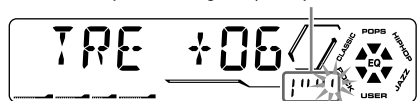

Ex.: When "TRE" is selected

To be continued...

Indication [Range]**BAS***1 (bass)

Adjust the bass. [-06 to +06]

TRE*1 (treble)

Adjust the treble. [-06 to +06]

FAD*2 (fader)Adjust the front and rear speaker balance.
[R06 to F06]**BAL** (balance)Adjust the left and right speaker balance.
[L06 to R06]**LOUD***1 (loudness)Boost low and high frequencies to produce a well-balanced sound at low volume level.
[LOUD ON or LOUD OFF]**VOL** (volume)Adjust the volume. [00 to 30 or 50*³]

*1 When you adjust the bass, treble, or loudness, the adjustment you have made is stored for the currently selected sound mode (C-EQ) including "USER."

*2 If you are using a two-speaker system, set the fader level to "00."

*3 Depending on the amplifier gain control setting. (See page 14 for details.)

General settings — PSM

You can change PSM (Preferred Setting Mode) items listed (except "SID") in the table that follows.

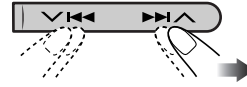
1**2** Select a PSM item.

Ex.: When you select "DIMMER"

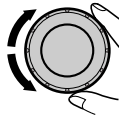
3 Adjust the PSM item selected.**4** Repeat steps 2 and 3 to adjust other PSM items if necessary.**5** Finish the procedure.

Indications	Selectable settings, [reference page]
DEMO Display demonstration	DEMO ON : [Initial]; Display demonstration will be activated automatically if no operation is done for about 20 seconds, [7]. DEMO OFF : Cancels.
CLOCK H Hour adjustment	1 – 12, [7] [Initial: 1 (1:00)]
CLOCK M Minute adjustment	00 – 59, [7] [Initial: 00 (1:00)]
CLK ADJ *1 Clock adjustment	AUTO : [Initial]; The built-in clock is automatically adjusted using the clock data provided via the satellite radio channel. OFF : Cancels.
T-ZONE *1, *2 Time zone	Select your residential area from one of the following time zone for clock adjustment. EASTERN [Initial] ⇄ ATLANTIC ⇄ NEWFOUND ⇄ ALASKA ⇄ PACIFIC ⇄ MOUNTAIN ⇄ CENTRAL ⇄ (back to the beginning)
DST *1, *2 Daylight savings time	Activates this if your residential area is subject to DST. ON : [Initial]; Activates daylight savings time. OFF : Cancels.
SID *3 SIRIUS ID	The 12-digit SIRIUS identification number scrolls on the display 5 seconds after “SID” is selected, [17]. • Press S SEL to resume the previous display.
LEVEL Audio level meter	ON : [Initial]; Activates the audio level indicator. OFF : Cancels; sound mode indicator is shown.
DIMMER Dimmer	AUTO : [Initial]; Dims the display when you turn on the headlights. ON : Activates dimmer. OFF : Cancels.
TEL *4 Telephone muting	MUTING 1/MUTING 2 : Select either one which mutes the sounds while using the cellular phone. OFF : [Initial]; Cancels.

*1 Displayed only when SIRIUS Satellite radio or XM Satellite radio is connected.

*2 Displayed only when “CLK ADJ” is set to “AUTO.”

*3 Displayed only when SIRIUS Satellite radio is connected.

*4 Only for KD-AR470.

To be continued...

Indications	Selectable settings, [reference page]
SCROLL *1 Scroll	ONCE : [Initial]; Scrolls the disc information once. AUTO : Repeats scrolling (5-second intervals in between). OFF : Cancels. • Pressing D DISP for more than one second can scroll the display regardless of the setting.
EXT IN *2 External input	CHANGER : [Initial]; To use a JVC CD changer, [9], an Apple iPod or a JVC D. player, [16], a JVC compatible satellite (SIRIUS/XM) tuner, [17]. EXT IN : To use any other component than the above, [16].
AUX ADJ Auxiliary input level adjustment	A.ADJ 00 – A.ADJ 05 : Adjust the auxiliary input level accordingly, to avoid the sudden increase of the output level when changing the source from the external component connected to the AUX input jack on the control panel. [Initial: A.ADJ 00]
TAG DISP Tag display	TAG ON : [Initial]; Shows the ID3 tag while playing MP3/WMA tracks, [10]. TAG OFF : Cancels.
AMP GAIN Amplifier gain control	You can change the maximum volume level of this unit. LOW PWR : VOL 00 – VOL 30 (Select this if the maximum power of the speaker is less than 50 W to prevent them from damaging the speaker.) HIGH PWR : [Initial]; VOL 00 – VOL 50
AREA Tuner channel interval	AREA US : [Initial]; Select this when using the unit in North or South America, except for Middle South America. (FM: 200 kHz; AM: 10 kHz) AREA EU : Select this when using the unit in any other area than North, Middle South, and South America. (FM: 50 kHz—manual tuning, 100 kHz—auto search; AM: 9 kHz) AREA SA : Select this when using the unit in Middle South America. (FM: 100 kHz; AM: 10 kHz)

*1 Some characters or symbols will not be shown correctly (or will be blanked) on the display.

*2 Displayed only when one of the following sources is selected—FM, AM, CD, or AUX IN.

Title assignment

You can assign titles to station frequencies and CDs (both in this unit and in the CD changer).

Sources	Maximum number of characters
FM/AM tuner	Up to 8 characters (up to 30 station frequencies including both FM and AM)
CDs/CD-CH	Up to 32 characters (up to 30 discs)

• You cannot assign a title to a CD Text or an MP3/WMA disc.

1 Select the sources.

- For FM/AM tuner: Tune into a station.
- For a CD in this unit: Insert a CD.
- For CDs in the CD changer: Select "CD-CH," then select a disc number.

2 Enter the title assignment mode.



Ex.: When you select "CD" as the source

3 Assign a title.

1 Select a character.



A	B	C	D	E	F	G	H	I	J	K	L	M	N
O	P	Q	R	S	T	U	V	W	X	Y	Z	0	1
2	3	4	5	6	7	8	9	-	/	<	>	space	

2 Move to the next (or previous) character position.

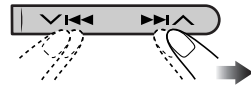

3 Repeat steps 1 and 2 until you finish entering the title.

4 Finish the procedure.



To erase the entire title

In step 2 on the left...



This unit is ready for operating an Apple iPod® or a JVC D. player from the control panel.

- For details, refer also to the manual supplied with the interface adapter for iPod®—KS-PD100 or D. player—KS-PD500.

External component operations

You can connect an external component to...

- CD changer jack on the rear using:
 - **Line Input Adapter**—KS-U57 (not supplied) or **AUX Input Adapter**—KS-U58 (not supplied) for any other components (except iPod and D. player).
 - **Interface adapter for iPod®**—KS-PD100 (not supplied) for controlling iPod.
 - **D. player interface adapter**—KS-PD500 (not supplied) for controlling D. player.
- AUX (auxiliary) input jack on the control panel.

For connection, see Installation/Connection Manual (separate volume).

Connecting an external component to the AUX input jack

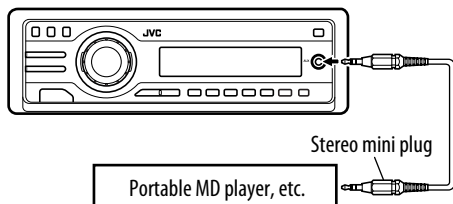

- 1 For selecting the external component connected to...
 - **AUX input jack**

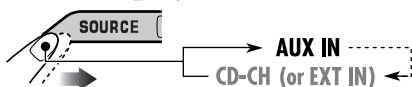

- **CD changer jack on the rear using KS-U57 or KS-U58**

If "EXT IN" does not appear, see page 14 and select the external input ("EXT IN").

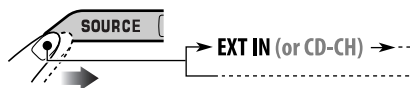

- **CD changer jack on the rear using interface adapter for iPod—KS-PD100 or for D. player—KS-PD500**

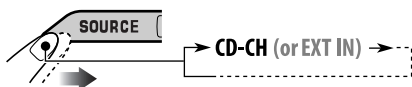

- 2 Turn on the connected component and start playing the source.

- 3 Adjust the volume.

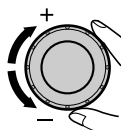

- 4 Adjust the sound as you want. (See pages 11 and 12.)

To check the other information while listening to an external component



Clock ↔ AUX IN, EXT IN, or CD-CH*

* See "While playing an MP3 or WMA disc" on page 10 for details.

Satellite radio operations

This unit is Satellite (SAT) Radio Ready—compatible with both SIRIUS Satellite radio and XM Satellite radio.

Before operating your satellite radio:

- For connection, see Installation/Connection Manual (separate volume).
- Refer also to the Instructions supplied with your SIRIUS Satellite radio or XM Satellite radio.
- “SIRIUS” and the SIRIUS dog logo are registered trademarks of SIRIUS Satellite Radio Inc.
- XM and its corresponding logos are registered trademarks of XM Satellite Radio Inc.
- “SAT Radio,” the SAT Radio logo and all related marks are trademarks of SIRIUS Satellite Radio Inc., and XM Satellite Radio, Inc.

Listening to the satellite radio

Connect either one of the following (separately purchased) to the CD changer jack on the rear of this unit.

- **JVC SIRIUS radio DLP**—Down Link Processor, for listening to the SIRIUS Satellite radio.
- **XMDirect™ Universal Tuner Box using a JVC Smart Digital Adapter**—XMDJVC100 (not supplied), for listening to the XM Satellite radio.

GCI (Global Control Information) update:

- If channels are updated after subscription, updating starts automatically. “UPDATING” flashes and no sound can be heard.
- Update takes a few minutes to complete.
- During update, you cannot operate your satellite radio.

Activate your SIRIUS subscription after connection:

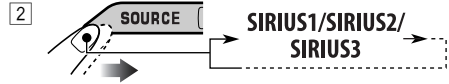
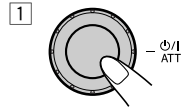

JVC DLP starts updating all the SIRIUS channels.

Once completed, JVC DLP tunes in to the preset channel, CH184.

- 3 **Check your SIRIUS ID, see page 13.**
- 4 **Contact SIRIUS on the internet at <<http://activate.siriusradio.com/>> to activate your subscription, or you can call SIRIUS toll-free at 1-888-539-SIRIUS (7474).** “SUB UPDT PRESS ANY KEY” scrolls on the display once subscription has been completed.

Activate your XM subscription after connection:

- Only Channel 0, 1, and 247 are available before activation.

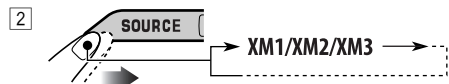
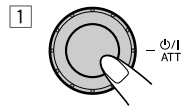

XMDirect™ Universal Tuner Box starts updating all the XM channels. “Channel 1” is tuned in automatically.

To be continued...

- 3 Check your XM Satellite radio ID labelled on the casing of the XMDirect™ Universal Tuner Box, or tune into “Channel 0” (see page 19).
- 4 Contact XM Satellite radio on the internet at <<http://xmradio.com/activation/>> to activate your subscription, or you can call 1-800-XM-RADIO (1-800-967-2346). Once completed, the unit tunes in to one of the available channels (Channel 4 or higher).

Listening to the SIRIUS Satellite radio

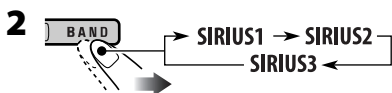
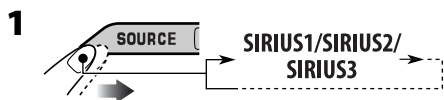

- 3 Select a category.

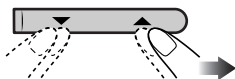

You can tune in to all the channels of every category by selecting “ALL.”

Selecting a particular category (SPORTS, ENTERTAINMENT, etc.) allows you to enjoy only the channels from the selected category.

- 4 Select a channel for listening.

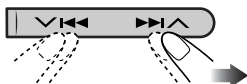

Holding the button changes the channels rapidly.

- When changing the category or channel, invalid and unsubscribed channels are skipped.

Listening to the XM Satellite radio

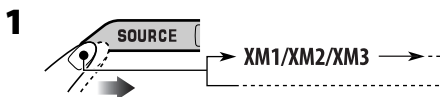

- 3 Select a channel for listening.

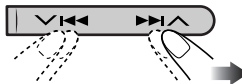

Holding the button changes the channels rapidly.

Category/channel search

You can search for programs by category (Category Search) or channel number (Channel Search).

- In **Category Search**, you can tune in to the channels of the selected category. Category Search begins from the currently selected channel. The selected channel number flashes on the display.
- In **Channel Search**, you can tune in to all channels (including non-categorised channels).

- 1 Select a category (Category Search).

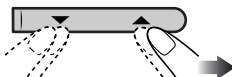

- 2 Select a channel for listening.

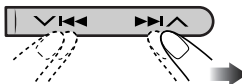

Current channel number

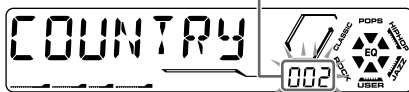

Ex.: When you select “COUNTRY” for Category Search

If no operation is done for about 15 seconds, Category Search is canceled.

In Channel Search, channel name and channel number appear on the display during search.

- While searching, invalid and unsubscribed channels are skipped.

Checking the XM Satellite radio ID

While selecting “XM1,” “XM2,” or “XM3,” select “Channel 0.”

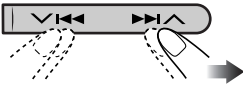

The display alternately shows “RADIO ID” and the 8-digit (alphanumeric) ID number.

To cancel the ID number display, select any channel other than “Channel 0.”

Listening to a preset channel

- 1 Select either SIRIUS Satellite radio or XM Satellite radio.



- 2 Select the preset channel (1 – 6) you want.

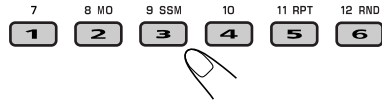

To change the display information while listening to a channel



Clock → Category name → Channel name → Artist name → Composer name* → Song/program name/title → (back to the beginning)

* Only for SIRIUS Satellite radio.

Storing channels in memory

You can preset six channels for each band.

Ex.: Storing a channel into preset number 4.

- 1 Tune in to a channel you want.

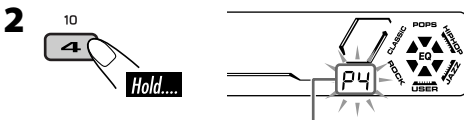

Preset number flashes for a while.

More about this unit

Basic operations

Turning on the power

- By pressing SOURCE on the unit, you can also turn on the power. If the source is ready, playback also starts.

Turning off the power

- If you turn off the power while listening to a disc, disc play will start from where playback has been stopped previously, next time you turn on the power.

Selecting the sources

- When no disc is loaded in the unit, “CD” cannot be selected.
- “SIRIUS,” “XM,” or “CD-CH” cannot be selected when the target component is not connected.

Tuner operations

Storing stations in memory

- During SSM search...
 - All previously stored stations are erased and stations are stored newly.
 - Received stations are preset in No. 1 (lowest frequency) to No. 6 (highest frequency).
 - When SSM is over, the station stored in No. 1 will be automatically tuned in.
- When storing a station manually, a previously preset station is erased when a new station is stored in the same preset number.

Disc operations

Caution for DualDisc playback

- The Non-DVD side of a “DualDisc” does not comply with the “Compact Disc Digital Audio” standard. Therefore, the use of Non-DVD side of a DualDisc on this product may not be recommended.

General

- This unit has been designed to reproduce CDs/CD Texts, and CD-Rs (Recordable)/CD-RWs (Rewritable) in audio CD (CD-DA), MP3 and WMA formats.
- When a disc has been loaded, selecting “CD” for the playback source starts disc play.

Inserting a disc

- When a disc is inserted upside down, “PLEASE” and “EJECT” appear alternately on the display. Press ▲ to eject the disc.
- Do not insert 8 cm discs (single CD) and unusual shape discs (heart, flower, etc.) into the loading slot.

Playing a disc

- While fast-forwarding or reversing on an MP3 or WMA disc, you can only hear intermittent sounds.

Playing a CD-R or CD-RW

- Use only “finalized” CD-Rs or CD-RWs.
- This unit can play back only the files of the same type which is first detected if a disc includes both audio CD (CD-DA) files and MP3/WMA files.
- This unit can play back multi-session discs; however, unclosed sessions will be skipped while playing.
- Some CD-Rs or CD-RWs may not play back on this unit because of their disc characteristics, and for the following causes:
 - Discs are dirty or scratched.
 - Moisture condensation occurs on the lens inside the unit.
 - The pickup lens inside the unit is dirty.
 - CD-R/CD-RW on which the files are written with “Packet Write” method.
 - There are improper recording conditions (missing data, etc.) or media conditions (stain, scratch, warp, etc.).
- CD-RWs may require a longer readout time since the reflectance of CD-RWs is lower than that of regular CDs.

- Do not use the following CD-Rs or CD-RWs:
 - Discs with stickers, labels, or protective seal stuck to the surface.
 - Discs on which labels can be directly printed by an ink jet printer.
- Using these discs under high temperatures or high humidities may cause malfunctions or damages to the unit.

Playing an MP3/WMA disc

- This unit can play back MP3/WMA files with the extension code <.mp3> or <.wma> (regardless of the letter case—upper/lower).
- This unit can show the names of albums, artists (performer), and ID3 Tag (Version 1.0, 1.1, 2.2, 2.3, or 2.4) for MP3 files and for WMA files.
- This unit can display only one-byte characters. No other characters can be correctly displayed.
- This unit can play back MP3/WMA files meeting the conditions below:
 - Bit rate: 8 kbps — 320 kbps
 - Sampling frequency:
 - 48 kHz, 44.1 kHz, 32 kHz (for MPEG-1)
 - 24 kHz, 22.05 kHz, 16 kHz (for MPEG-2)
 - Disc format: ISO 9660 Level 1/ Level 2, Romeo, Joliet, Windows long file name
- The maximum number of characters for file/folder names vary among the disc format used (includes 4 extension characters—<.mp3> or <.wma>).
 - ISO 9660 Level 1: up to 12 characters
 - ISO 9660 Level 2: up to 31 characters
 - Romeo*: up to 128 (72) characters
 - Joliet*: up to 64 (36) characters
 - Windows long file name*: up to 128 (72) characters

* *The parenthetic figure is the maximum number of characters for file/folder names in case the total number of files and folders is 313 or more.*
- This unit can play back the files recorded in VBR (variable bit rate).
The files recorded in VBR have a discrepancy in elapsed time display, and do not show the actual elapsed time. Especially, after performing the search function, this difference becomes noticeable.

- This unit can recognize the total of 512 files, of 200 folders, and of 8 hierarchies.
- This unit cannot play back the following files:
 - MP3 files encoded with MP3i and MP3 PRO format.
 - MP3 files encoded in an unappropriated format.
 - MP3 files encoded with Layer 1/2.
 - WMA files encoded with lossless, professional, and voice format.
 - WMA files which are not based upon Windows Media® Audio.
 - WMA files copy-protected with DRM.
 - Files which have the data such as WAVE, ATRAC3, etc.
- The search function works but search speed is not constant.

Changing the source

- If you change the source, playback also stops (without ejecting the disc).
Next time you select “CD” for the playback source, disc play starts from where it has been stopped previously.

Ejecting a disc

- If the ejected disc is not removed within 15 seconds, the disc is automatically inserted again into the loading slot to protect it from dust. (Disc will not play this time.)

General settings—PSM

- If you change the “AMP GAIN” setting from “HIGH PWR” to “LOW PWR” while the volume level is set higher than “VOL 30,” the unit automatically changes the volume level to “VOL 30.”

Other main functions

- If you try to assign a title to a 31st disc or to a 31st station frequency, “NAMEFULL” flashes on the display. Delete unwanted titles before assignment.
- Titles assigned to discs in the CD changer can also be shown if you play back the disc from the unit.

To be continued....

Satellite radio operations

- You can also connect the JVC SIRIUS radio PnP (Plug and Play), using the JVC SIRIUS radio adapter, KS-U100K (not supplied) to the CD changer jack on the rear. By turning on/off the power of the unit, you can turn on/off the JVC PnP. However, you cannot control it from this unit.
- To know more about SIRIUS Satellite radio or to sign up, visit «<http://www.sirius.com>».
- For the latest channel listings and programming information, or to sign up for XM Satellite radio, visit «<http://www.xmradio.com>».

Maintenance

How to clean the connectors

Frequent detachment will deteriorate the connectors.

To minimize this possibility, periodically wipe the connectors with a cotton swab or cloth moistened with alcohol, being careful not to damage the connectors.

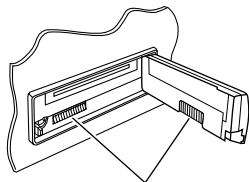

Connector

Moisture condensation

Moisture may condense on the lens inside the CD player in the following cases:

- After starting the heater in the car.
- If it becomes very humid inside the car.

Should this occur, the CD player may malfunction. In this case, eject the disc and leave the unit turned on for a few hours until the moisture evaporates.

How to handle discs

When removing a disc from its case, press down the center holder of the case and lift the disc out, holding it by the edges.



- Always hold the disc by the edges. Do not touch its recording surface.

When storing a disc into its case, gently insert the disc around the center holder (with the printed surface facing up).

- Make sure to store discs into the cases after use.

To keep discs clean

A dirty disc may not play correctly. If a disc does become dirty, wipe it with a soft cloth in a straight line from center to edge.



- Do not use any solvent (for example, conventional record cleaner, spray, thinner, benzene, etc.) to clean discs.

To play new discs

New discs may have some rough spots around the inner and outer edges. If such a disc is used, this unit may reject the disc.



To remove these rough spots, rub the edges with a pencil or ball-point pen, etc.

Do not use the following discs:

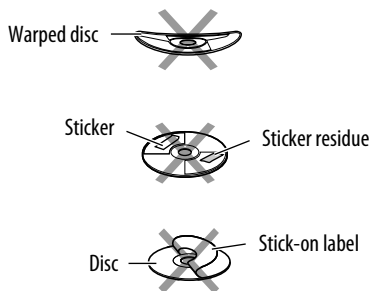

Troubleshooting

What appears to be trouble is not always serious. Check the following points before calling a service center.

	Symptoms	Remedies/Causes
General	<ul style="list-style-type: none"> • Sound cannot be heard from the speakers. 	<ul style="list-style-type: none"> • Adjust the volume to the optimum level. • Check the cords and connections.
	<ul style="list-style-type: none"> • The unit does not work at all. 	Reset the unit (see page 2).
FM/AM	<ul style="list-style-type: none"> • SSM automatic presetting does not work. 	Store stations manually.
	<ul style="list-style-type: none"> • Static noise while listening to the radio. 	Connect the antenna firmly.
Disc playback	<ul style="list-style-type: none"> • Disc cannot be played back. 	Insert the disc correctly.
	<ul style="list-style-type: none"> • CD-R/CD-RW cannot be played back. • Tracks on the CD-R/CD-RW cannot be skipped. 	<ul style="list-style-type: none"> • Insert a finalized CD-R/CD-RW. • Finalize the CD-R/CD-RW with the component which you used for recording.
	<ul style="list-style-type: none"> • Disc can be neither played back nor ejected. 	<ul style="list-style-type: none"> • Unlock the disc (see page 10). • Eject the disc forcibly (see page 2).
	<ul style="list-style-type: none"> • Disc sound is sometimes interrupted. 	<ul style="list-style-type: none"> • Stop playback while driving on rough roads. • Change the disc. • Check the cords and connections.
MP3/WMA playback	<ul style="list-style-type: none"> • Disc cannot be played back. 	<ul style="list-style-type: none"> • Use a disc with MP3/WMA tracks recorded in the format compliant with ISO 9660 Level 1, Level 2, Romeo, or Joliet. • Add the extension code <.mp3> or <.wma> to the file names.
	<ul style="list-style-type: none"> • Noise is generated. 	Skip to another track or change the disc. (Do not add the extension code <.mp3> or <.wma> to non-MP3 or WMA tracks.)
	<ul style="list-style-type: none"> • A longer readout time is required ("CHECK" keeps flashing on the display). 	Do not use too many hierarchies and folders.
	<ul style="list-style-type: none"> • Tracks do not play back in the order you have intended them to play. 	Playback order is determined when the files are recorded.
	<ul style="list-style-type: none"> • Elapsed playing time is not correct. 	This sometimes occurs during play. This is caused by how the tracks are recorded on the disc.
	<ul style="list-style-type: none"> • "NO FILES" appears on the display. 	Insert a disc that contains MP3/WMA tracks.
	<ul style="list-style-type: none"> • Correct characters are not displayed (e.g. album name). 	This unit can only display alphabets (upper case), numbers, and a limited number of symbols.

To be continued...

	Symptoms	Remedies/Causes
CD changer	• “NO DISC” appears on the display.	Insert a disc into the magazine.
	• “NO MAG” appears on the display.	Insert the magazine.
	• “RESET 8” appears on the display.	Connect this unit and the CD changer correctly and press the reset button of the CD changer.
	• “RESET 1” – “RESET 7” appears on the display.	Press the reset button of the CD changer.
	• The CD changer does not work at all.	Reset the unit (see page 2).
Satellite radio	• “CALL 1-888-539-SIRIUS TO SUBSCRIBE” scrolls on the display while listening to the SIRIUS Satellite radio.	Starts subscribing SIRIUS Satellite radio (see page 17).
	• No sound can be heard. “UPDATING” appears on the display.	The unit is updating the channel information and it takes a few minutes to complete.
	• Either “NO SIGNAL” scrolls or “NO SIGL” appears on the display.	Move to an area where signals are stronger.
	• Either “NO ANTENNA” scrolls or “ANTENNA” appears on the display.	Connect the antenna firmly.
	• “NO CH” appears on the display for about 5 seconds, then returns to the previous display while listening to the SIRIUS Satellite radio.	No broadcast on the selected channel. Select another channel or continue listening to the previous channel.
	• “NO (information)*” scrolls on the display while listening to the SIRIUS Satellite radio.	No text information for the selected channel.
	• “---” appears on the display while listening to the XM Satellite radio.	
	• “---” appears on the display for about 2 seconds, then returns to the previous channel while listening to the XM Satellite radio.	Selected channel is no longer available or unauthorized. Select another channel or continue listening to the previous channel.
	• “OFF AIR” appears on the display while listening to the XM Satellite radio.	Selected channel is not broadcasting at this time. Select another channel or continue listening to the previous channel.
• “LOADING” appears on the display while listening to the XM Satellite radio.	The unit is loading the channel information and audio. Text information are temporary unavailable.	
• “RESET 8” appears on the display.	Reconnect this unit and the satellite radio correctly and press the reset button of this unit.	
• Satellite radio does not work at all.		

* NO CATEGORY, NO ARTIST, NO COMPOSER, and NO SONG/PROGRAM

Specifications

AUDIO AMPLIFIER SECTION

Power Output:

20 W RMS × 4 Channels at 4 Ω
and ≤ 1% THD+N

Signal to Noise Ratio:

80 dBA (reference: 1 W into 4 Ω)



Load Impedance: 4 Ω (4 Ω to 8 Ω allowance)

Tone Control Range:

Bass: ±10 dB at 100 Hz

Treble: ±10 dB at 10 kHz

Frequency Response: 40 Hz to 20 000 Hz

Line-Out Level/Impedance:

KD-AR470: 4.0 V/20 kΩ load (full scale)

KD-G420: 2.5 V/20 kΩ load (full scale)

Output Impedance: 1 kΩ

Other Terminals: CD changer

AUX (auxiliary) input jack

TUNER SECTION

Frequency Range:

FM: 87.5 MHz to 107.9 MHz

(with channel interval set to 100 kHz
or 200 kHz)

87.5 MHz to 108.0 MHz

(with channel interval set to 50 kHz)

AM: 530 kHz to 1 710 kHz

(with channel interval set to 10 kHz)

531 kHz to 1 602 kHz

(with channel interval set to 9 kHz)

[FM Tuner]

Usable Sensitivity: 11.3 dBf (1.0 μV/75 Ω)

50 dB Quieting Sensitivity:

16.3 dBf (1.8 μV/75 Ω)

Alternate Channel Selectivity (400 kHz): 65 dB

Frequency Response: 40 Hz to 15 000 Hz

Stereo Separation: 35 dB

Capture Ratio: 1.5 dB

[AM Tuner]

Sensitivity: 20 μV

Selectivity: 35 dB

CD PLAYER SECTION

Type: Compact disc player

Signal Detection System: Non-contact optical
pickup (semiconductor laser)

Number of Channels: 2 channels (stereo)

Frequency Response: 5 Hz to 20 000 Hz

Dynamic Range: 96 dB

Signal-to-Noise Ratio: 98 dB

Wow and Flutter: Less than measurable limit

MP3 Decoding Format:

MPEG1/2 Audio Layer 3

Max. Bit Rate: 320 kbps

WMA (Windows Media® Audio) Decoding
Format:

Max. Bit Rate: 192 kbps

GENERAL

Power Requirement:

Operating Voltage:

DC 14.4 V (11 V to 16 V allowance)

Grounding System: Negative ground

Allowable Operating Temperature:

0°C to +40°C (32°F to 104°F)

Dimensions (W × H × D):

Installation Size (approx.):

182 mm × 52 mm × 150 mm

(7-3/16" × 2-1/16" × 5-15/16")

Panel Size (approx.):

188 mm × 58 mm × 11 mm

(7-7/16" × 2-5/16" × 7/16")

Mass (approx.):

1.5 kg (3.3 lbs) (excluding accessories)

*Design and specifications are subject to change
without notice.*

If a kit is necessary for your car, consult your
telephone directory for the nearest car audio
specialty shop.

- Microsoft and Windows Media are either registered trademarks or trademarks of Microsoft Corporation in the United States and/or other countries.



Having TROUBLE with operation?
Please reset your unit
Refer to page of How to reset your unit
Still having trouble??

USA ONLY

Call 1-800-252-5722

<http://www.jvc.com>

We can help you!

JVC



EN, SP, FR

© 2005 Victor Company of Japan, Limited

1005DTSMDTJEIN

JVC KD-AR470/KD-G420

Installation/Connection Manual

Manual de instalación/conexión

Manuel d'installation/raccordement

GET0336-002A
[J]

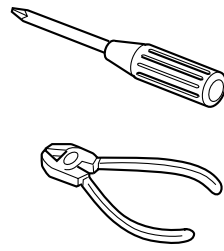

1005DTSMDTJEIN
EN, SP,FR

© 2005 Victor Company of Japan, Limited

ENGLISH

This unit is designed to operate on **12 V DC, NEGATIVE ground electrical systems**. If your vehicle does not have this system, a voltage inverter is required, which can be purchased at JVC car audio dealers.

WARNINGS

To prevent short circuits, we recommend that you disconnect the battery's negative terminal and make all electrical connections before installing the unit.

- **Be sure to ground this unit to the car's chassis again after installation.**

Notes:

- Replace the fuse with one of the specified rating. If the fuse blows frequently, consult your JVC car audio dealer.
- It is recommended to connect to the speakers with maximum power of more than 50 W (both at the rear and at the front, with an impedance of **4 Ω to 8 Ω**). If the maximum power is less than 50 W, change "AMP GAIN" setting to prevent the speakers from being damaged (see page 14 of the INSTRUCTIONS).
- To prevent short-circuit, cover the terminals of the UNUSED leads with insulating tape.
- The heat sink becomes very hot after use. Be careful not to touch it when removing this unit.

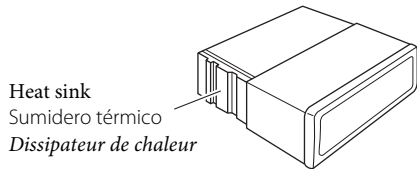

ESPAÑOL

Esta unidad está diseñada para funcionar con **12 V de CC, con sistemas eléctricos de masa NEGATIVA**. Si su vehículo no posee este sistema, será necesario un inversor de tensión, que puede ser adquirido en los concesionarios de JVC de equipos de audio para automóviles.

ADVERTENCIAS

Para evitar cortocircuitos, recomendamos que desconecte el terminal negativo de la batería y que efectúe todas las conexiones eléctricas antes de instalar la unidad.

- **Asegúrese de volver a conectar a masa esta unidad al chasis del automóvil después de la instalación.**

Notas:

- Reemplace el fusible por uno con la corriente especificada. Si el fusible se quemase frecuentemente consulte con su concesionario de JVC de equipos de audio para automóviles.
- Se recomienda conectar los altavoces con una potencia máxima de más de 50 W (tanto atrás como adelante, con una impedancia de **4 Ω a 8 Ω**). Si la potencia máxima es de menos de 50 W, cambie "AMP GAIN" para evitar daños en los altavoces (consulte la página 14 del MANUAL DE INSTRUCCIONES).
- Para evitar cortocircuitos, cubra los cables NO UTILIZADOS con cinta aislante.
- El sumidero térmico estará muy caliente después del uso. Asegúrese de no tocarlo al desmontar esta unidad.

FRANÇAIS

Cet appareil est conçu pour fonctionner sur des sources de **courant continu de 12 V à masse NEGATIVE**. Si votre véhicule n'offre pas ce type d'alimentation, il vous faut un convertisseur de tension, que vous pouvez acheter chez un revendeur d'autoradios JVC.

AVERTISSEMENTS

Pour éviter tout court-circuit, nous vous recommandons de débrancher la borne négative de la batterie et d'effectuer tous les raccordements électriques avant d'installer l'appareil.

- **Assurez-vous de raccorder de nouveau la mise à la masse de cet appareil au châssis de la voiture après l'installation.**

Remarques:

- Remplacer le fusible par un de la valeur précisée. Si le fusible saute souvent, consulter votre revendeur d'autoradios JVC.
- Il est recommandé de connecter des enceintes avec une puissance de plus de 50 W (les enceintes arrière et les enceintes avant, avec une impédance comprise entre **4 Ω et 8 Ω**). Si la puissance maximum est inférieure à 50 W, changez "AMP GAIN" pour éviter d'endommager vos enceintes (voir page 14 du MANUAL D'INSTRUCTIONS).
- Pour éviter les court-circuits, couvrir les bornes des fils qui ne sont PAS UTILISÉS avec de la bande isolante.
- Le dissipateur de chaleur devient très chaud après usage. Faire attention de ne pas le toucher en retirant cet appareil.

PRECAUTIONS on power supply and speaker connections:

- **DO NOT connect the speaker leads of the power cord to the car battery; otherwise, the unit will be seriously damaged.**
- BEFORE connecting the speaker leads of the power cord to the speakers, check the speaker wiring in your car.

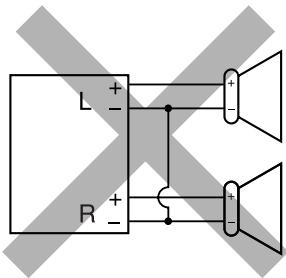

PRECAUCIONES sobre las conexiones de la fuente de alimentación y de los altavoces:

- **NO conecte los conductores de altavoz del cable de alimentación a la batería de automóvil, pues podrían producirse graves daños en la unidad.**
- ANTES de conectar a los altavoces los conductores de altavoz del cable de alimentación, verifique el conexionado de altavoz de su automóvil.

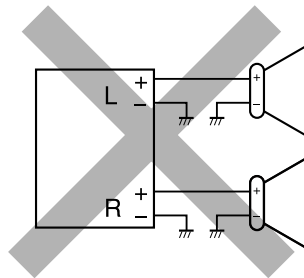

PRECAUTIONS sur l'alimentation et la connexion des enceintes:

- **NE CONNECTEZ PAS les fils d'enceintes du cordon d'alimentation à la batterie; sinon, l'appareil serait sérieusement endommagé.**
- AVANT de connecter les fils d'enceintes du cordon d'alimentation aux enceintes, vérifiez le câblage des enceintes de votre voiture.

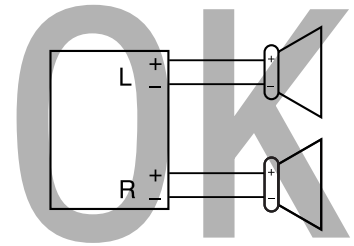

Parts list for installation and connection

The following parts are provided for this unit. After checking them, please set them correctly.

- (A) / (B)
Hard case/Control panel
Estuche duro/Panel de control
Etui de transport/Panneau de commande

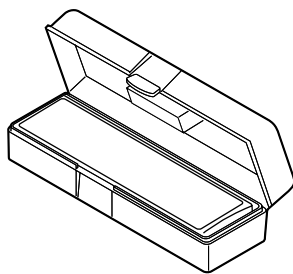

- (C)
Sleeve
Cubierta
Manchon

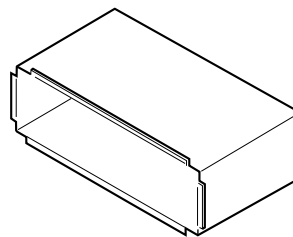

- (D)
Trim plate
Placa de guarnición
Plaque d'assemblage

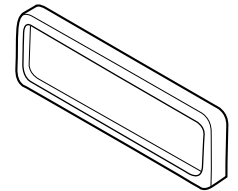

- (E)
Power cord
Cordón de alimentación
Cordon d'alimentation

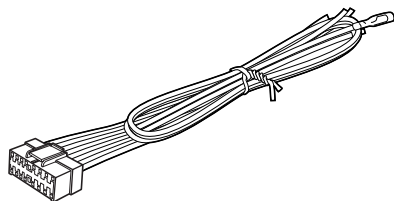

- (F)
Washer (ø5)
Arandela (ø5)
Rondelle (ø5)



- (G)
Lock nut (M5)
Tuerca de seguridad (M5)
Ecrou d'arrêt (M5)



- (H)
Mounting bolt—M5 × 20 mm (M5 × 13/16")
Perno de montaje—M5 × 20 mm (M5 × 13/16 pulgadas)
Boulon de montage—M5 × 20 mm (M5 × 13/16 pouces)

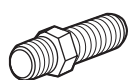

- (I)
Rubber cushion
Cojín de goma
Amortisseur en caoutchouc



- (J)
Handles
Manijas
Poignées

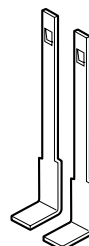

Only for KD-AR470 / Sólo para KD-AR470 / Seulement pour le KD-AR470

- (K)
Remote controller
Control remoto
Télécommande

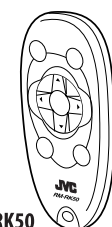

- (L)
Battery
Pila
Pile



RM-RK50

CR2025

INSTALLATION (IN-DASH MOUNTING)

The following illustration shows a typical installation. If you have any questions or require information regarding installation kits, consult your JVC car audio dealer or a company supplying kits.

- If you are not sure how to install this unit correctly, have it installed by a qualified technician.

INSTALACION (MONTAJE EN EL TABLERO DE INSTRUMENTOS)

La siguiente ilustración muestra una instalación típica. Si tiene alguna pregunta o necesita información acerca de las herramientas para instalación, consulte con su concesionario de JVC de equipos de audio para automóviles o a una compañía que suministra tales herramientas.

- Si usted no está seguro de cómo instalar correctamente la unidad, hágala instalar por un técnico cualificado.

INSTALLATION (MONTAGE DANS LE TABLEAU DE BORD)

L'illustration suivante est un exemple d'installation typique. Si vous avez des questions ou avez besoin d'information sur des kits d'installation, consulter votre revendeur d'autoradios JVC ou une compagnie d'approvisionnement.

- Si l'on n'est pas sûr de pouvoir installer correctement cet appareil, le faire installer par un technicien qualifié.

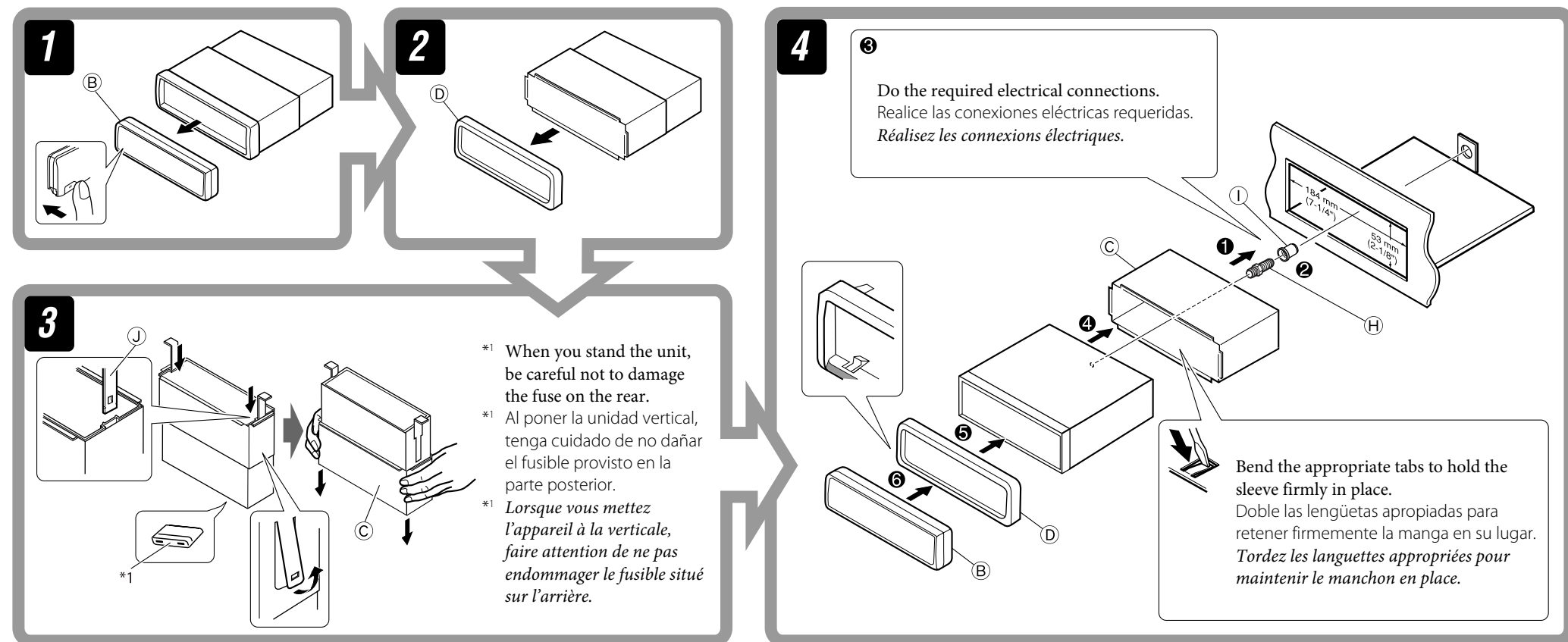

Removing the unit

Before removing the unit, release the rear section.

Extracción de la unidad

Antes de extraer la unidad, libere la sección trasera.

Retrait de l'appareil

Avant de retirer l'appareil, libérer la section arrière.

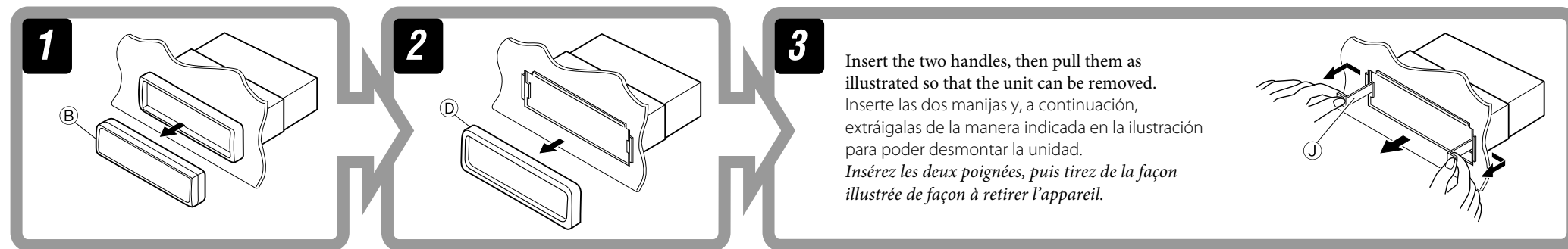

When using the optional stay / Cuando emplea un soporte opcional / Lors de l'utilisation du hauban en option

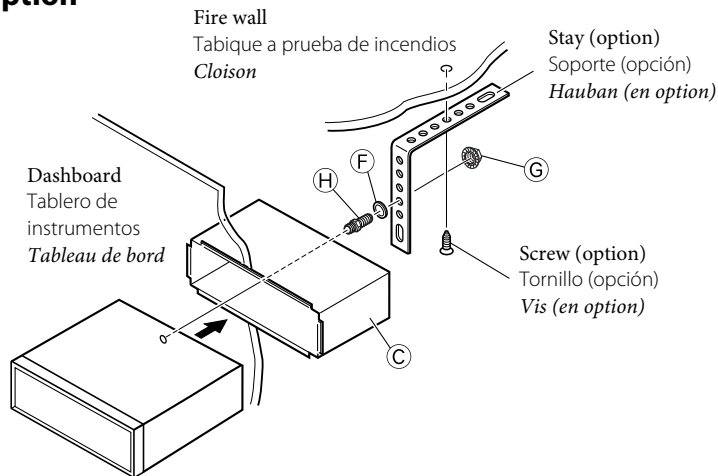

Install the unit at an angle of less than 30°.
Instale la unidad a un ángulo de menos de 30°.
Installez l'appareil avec un angle de moins de 30°.

When installing the unit without using the sleeve / Instalación de la unidad sin utilizar la cubierta / Lors de l'installation de l'appareil sans utiliser de manchon

In a Toyota car for example, first remove the car radio and install the unit in its place.
En un automóvil Toyota, por ejemplo, en primer lugar desmonte el autorradio e instale la unidad en su lugar.
Dans une voiture Toyota, par exemple, retirez d'abord l'autoradio et installez l'appareil à sa place.

Flat type screws—M5 × 8 mm
(M5 × 3/8")*
Tornillos tipo plano—M5 × 8 mm
(M5 × 3/8 pulgada)*
Vis à tête plate—M5 × 8 mm
(M5 × 3/8 pouces)*

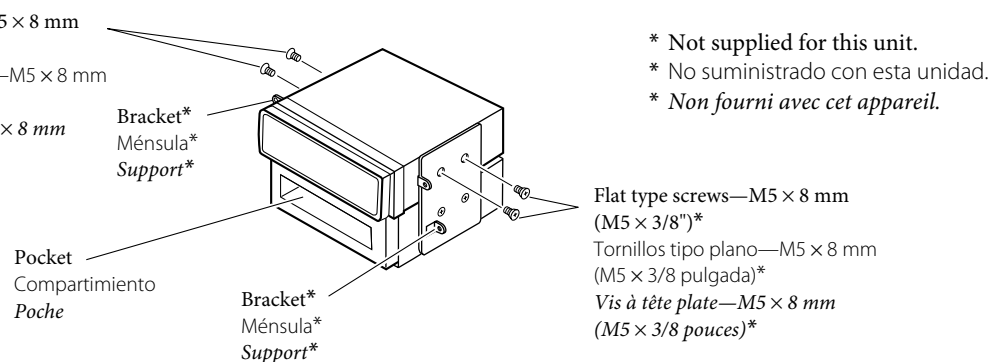

* Not supplied for this unit.
* No suministrado con esta unidad.
* Non fourni avec cet appareil.

- Note** : When installing the unit on the mounting bracket, make sure to use the 8 mm (3/8") -long screws. If longer screws are used, they could damage the unit.
- Nota** : Cuando instala la unidad en la ménsula de montaje, asegúrese de utilizar los tornillos de 8 mm (3/8 pulgada) de longitud. Si se utilizan tornillos más largos, éstos pueden dañar la unidad.
- Remarque** : Lors de l'installation de l'appareil sur le support de montage, s'assurer d'utiliser des vis d'une longueur de 8 mm (3/8 pouces). Si des vis plus longues sont utilisées, elles peuvent endommager l'appareil.

TROUBLESHOOTING

- **The fuse blows.**
 - * Are the red and black leads connected correctly?
- **Power cannot be turned on.**
 - * Is the yellow lead connected?
- **No sound from the speakers.**
 - * Is the speaker output lead short-circuited?
- **Sound is distorted.**
 - * Is the speaker output lead grounded?
 - * Are the "-" terminals of L and R speakers grounded in common?
- **Noise interferes with sounds.**
 - * Is the rear ground terminal connected to the car's chassis using shorter and thicker cords?
- **Unit becomes hot.**
 - * Is the speaker output lead grounded?
 - * Are the "-" terminals of L and R speakers grounded in common?
- **This unit does not work at all.**
 - * Have you reset your unit?

LOCALIZACION DE AVERIAS

- **El fusible se quema.**
 - * ¿Están los conductores rojo y negro correctamente conectados?
- **No es posible conectar la alimentación.**
 - * ¿Está el cable amarillo conectado?
- **No sale sonido de los altavoces.**
 - * ¿Está el cable de salida del altavoz cortocircuitado?
- **El sonido presenta distorsión.**
 - * ¿Está el cable de salida del altavoz conectado a masa?
 - * ¿Están los terminales "-" de los altavoces L y R conectados a una masa común?
- **Perturbación de ruido.**
 - * ¿El terminal de tierra trasero está conectado al chasis del automóvil utilizando los cordones más corto y más grueso?
- **La unidad se calienta.**
 - * ¿Está el cable de salida del altavoz conectado a masa?
 - * ¿Están los terminales "-" de los altavoces L y R conectados a una masa común?
- **Este receptor no funciona en absoluto.**
 - * ¿Reinicializó el receptor?

Download from www.Somanuals.com. All Manuals Search And Download.

EN CAS DE DIFFICULTES

- **Le fusible saute.**
 - * Les fils rouge et noir sont-ils raccordés correctement?
- **L'appareil ne peut pas être mise sous tension.**
 - * Le fil jaune est-elle raccordée?
- **Pas de son des enceintes.**
 - * Le fil de sortie d'enceinte est-il court-circuité?
- **Le son est déformé.**
 - * Le fil de sortie d'enceinte est-il à la masse?
 - * Les bornes "-" des enceintes gauche et droit sont-elles mises ensemble à la masse?
- **Interférence avec les sons.**
 - * La prise arrière de mise à la terre est-elle connectée au châssis de la voiture avec un cordon court et épais?
- **L'appareil devient chaud.**
 - * Le fil de sortie d'enceinte est-il à la masse?
 - * Les bornes "-" des enceintes gauche et droit sont-elles mises ensemble à la masse?
- **Cet appareil ne fonctionne pas du tout.**
 - * Avez-vous réinitialisé votre appareil?

ELECTRICAL CONNECTIONS

CONEXIONES ELECTRICAS

RACCORDEMENTS ELECTRIQUES

A Typical connections / Conexiones típicas / Raccordements typiques

Before connecting: Check the wiring in the vehicle carefully. Incorrect connection may cause serious damage to this unit. The leads of the power cord and those of the connector from the car body may be different in color.

- 1 Connect the colored leads of the power cord in the order specified in the illustration below.
- 2 Connect the antenna cord.
- 3 Finally connect the wiring harness to the unit.

Antes de la conexión: Verifique atentamente el conexionado del vehículo. Una conexión incorrecta podría producir daños graves en la unidad. Los cordones del cable de alimentación y los del conector procedentes de la carrocería del automóvil podrían ser de diferentes en color.

- 1 Conecte los conductores de color del cable de alimentación en el orden especificado en la ilustración de abajo.
- 2 Conecte el cable de antena.
- 3 Por último, conecte el cable de alimentación a la unidad.

Avant de commencer la connexion: Vérifiez attentivement le câblage du véhicule. Une connexion incorrecte peut endommager sérieusement l'appareil. Le fil du cordon d'alimentation et ceux des connecteurs du châssis de la voiture peuvent être différents en couleur.

- 1 Connectez les fils colorés du cordon d'alimentation dans l'ordre spécifié sur l'illustration ci-dessous.
- 2 Connectez le cordon d'antenne.
- 3 Finalement, connectez le faisceau de fils à l'appareil.

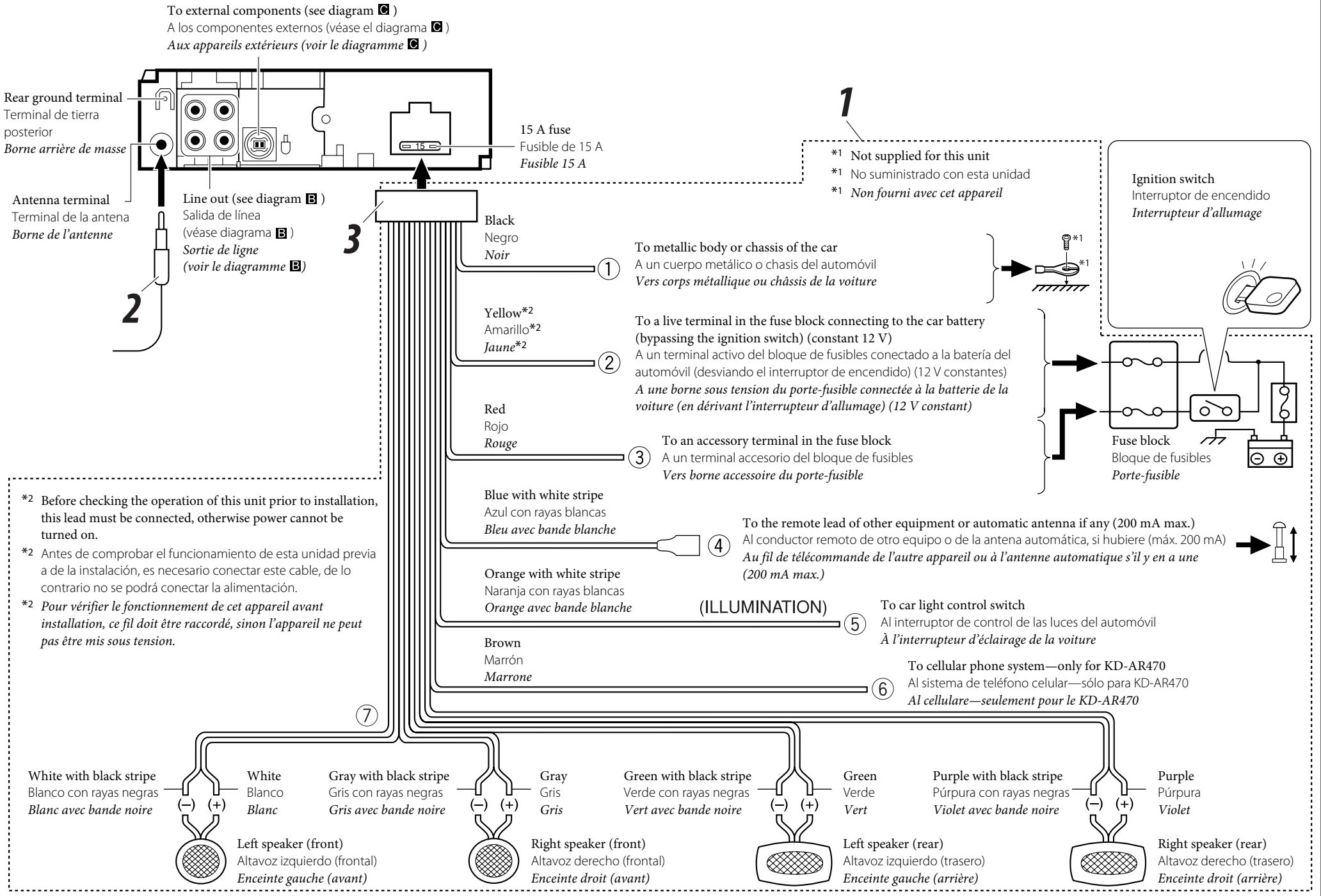

B Connecting the external amplifiers / Conexión a los amplificadores externos / Connexion d'amplificateurs extérieurs

You can connect amplifiers to upgrade your car stereo system.

- Connect the remote lead (blue with white stripe) to the remote lead of the other equipment so that it can be controlled through this unit.
- **Disconnect the speakers from this unit, connect them to the amplifier. Leave the speaker leads of this unit unused.**
- For KD-AR470: The line output level of this unit is kept high to maintain the hi-fi sounds reproduced from this unit. When connecting an external amplifier to this unit, turn down the gain control on the external amplifier to obtain the best performance from this unit.

Usted podrá conectar amplificadores para mejorar el sistema estéreo de su automóvil.

- Conecte el conductor remoto (azul con rayas blancas) al conductor remoto del otro equipo para poderlo controlar a través de esta unidad.
- **Desconecte los altavoces de esta unidad y conéctelos al amplificador. Los cables de los altavoces de esta unidad quedan sin usar.**
- Para KD-AR470: El nivel de salida de línea de esta unidad permanece alto para que corresponda con los sonidos de alta fidelidad reproducidos por esta unidad. Cuando conecte un amplificador externo a esta unidad, disminuya el control de ganancia del amplificador externo para obtener un óptimo rendimiento de esta unidad.

Vous pouvez connecter des amplificateurs pour améliorer votre système autoradio.

- Connectez le fil de commande à distance (bleu avec bande blanche) au fil de commande à distance de l'autre appareil de façon qu'il puisse être commandé via cet appareil.
- **Déconnectez les enceintes de cet appareil et connectez-les à l'amplificateur. Laissez les fils d'enceintes de cet appareil inutilisés.**
- Pour le KD-AR470: Le niveau de sortie de ligne de cet appareil est maintenu à un niveau élevé pour maintenir une qualité Hi-Fi pour les sons reproduits par cet appareil. Lors de la connexion d'un amplificateur extérieur à cet appareil, diminuez le réglage du gain sur l'amplificateur extérieur pour obtenir les meilleures performances de cet appareil.

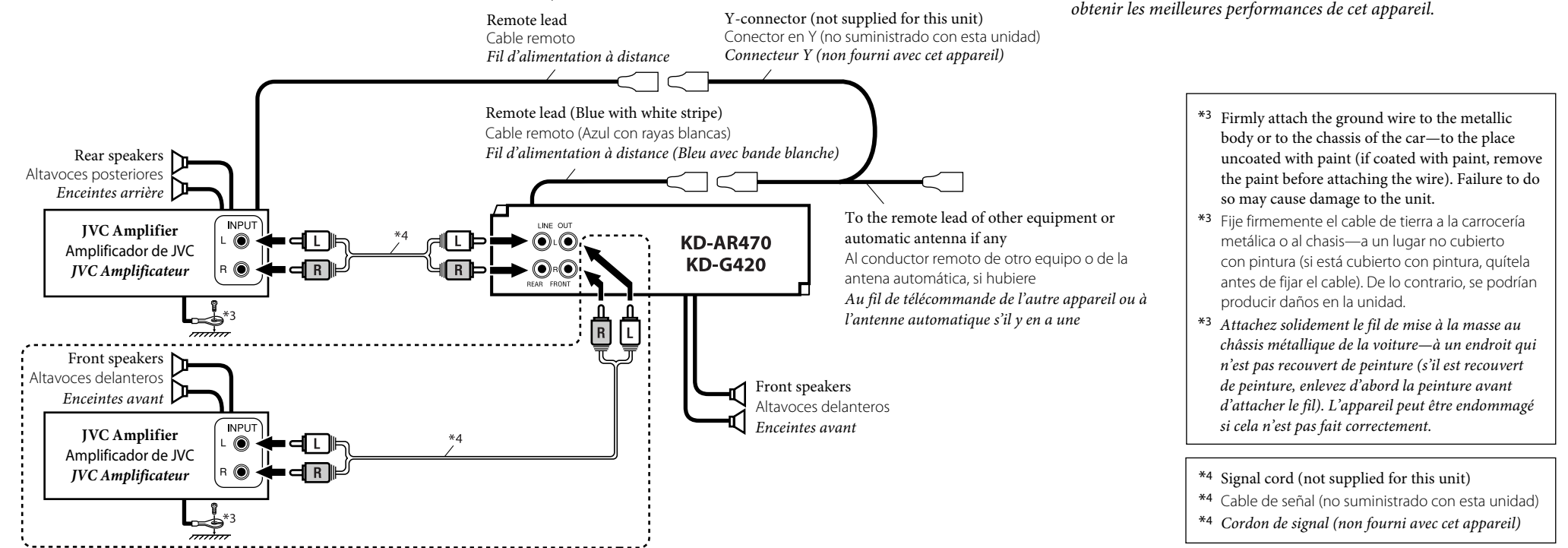

C Connecting other external components / Conexión de otros componentes externos / Connexion d'un autre appareil extérieur

• Set "EXT IN" to "CHANGER" (See page 14 of the INSTRUCTIONS.) / Ajuste "EXT IN" a "CHANGER" (Consulte la página 14 del MANUAL DE INSTRUCCIONES.) / Réglez "EXT IN" sur "CHANGER" (Voir la page 14 du MANUEL D'INSTRUCTIONS.)

JVC CD changer, SIRIUS Satellite radio, XM Satellite radio, Apple iPod®, or JVC D. player / Cambiador de CD de JVC, radio satelital SIRIUS, radio satelital XM, iPod® de Apple o reproductor JVC D. / Changeur de CD JVC, radio satellite SIRIUS, radio satellite XM, iPod® Apple ou lecteur D. JVC

You can connect these components in series as illustrated below.

- For listening to the SIRIUS Satellite radio, connect a JVC DLP —Down Link Processor (separately purchased) to this unit.
- The iPod®*5 or D. player can be connected using an interface adapter (not supplied)—KS-PD100 (for iPod) or KS-PD500 (for D. player).

Estos componentes se pueden conectar en serie, tal como se muestra en la ilustración de abajo.

- Para escuchar la radio satelital SIRIUS, conecte un DLP (Down Link Processor) de JVC (adquirido por separado) al receptor.
- Puede conectar el iPod®*5 o el reproductor D. usando un adaptador de interfaz (no suministrado)—KS-PD100 (para iPod) o KS-PD500 (para el reproductor D.).

Vous pouvez connecter ces appareils en série comme montrée sur l'illustration.

- Pour écouter la radio satellite SIRIUS, connectez un processeur DLP JVC —Processeur de signaux satellite-terre (vendu séparément) à cet appareil.
- Le iPod®*5 ou le lecteur D. peut être connecté en utilisant un adaptateur d'interface (non fourni)—KS-PD100 (pour iPod) ou KS-PD500 (pour le lecteur D.).

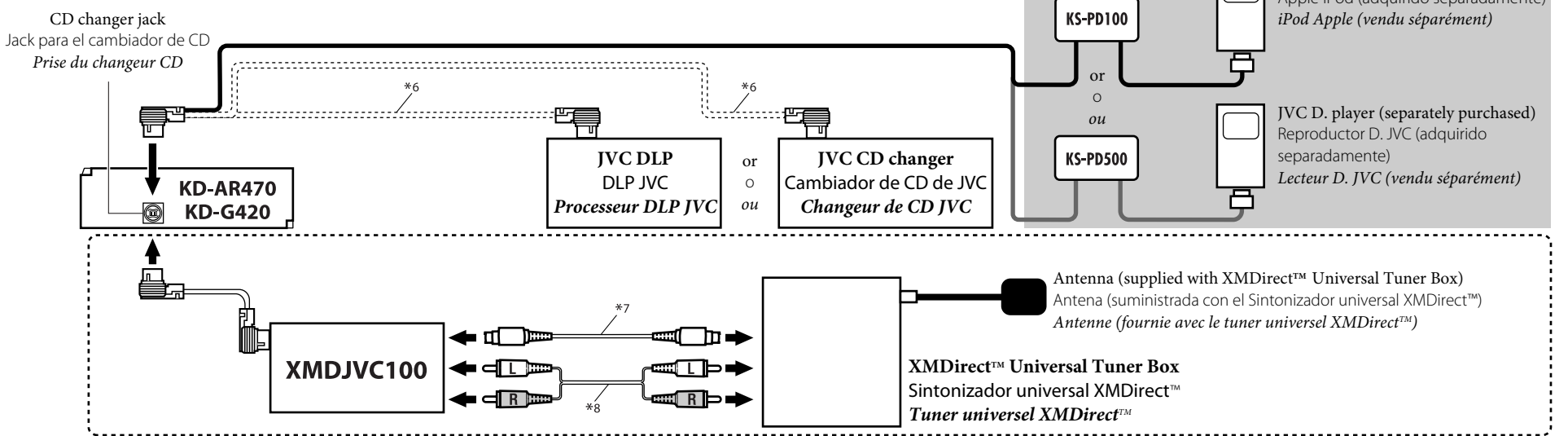
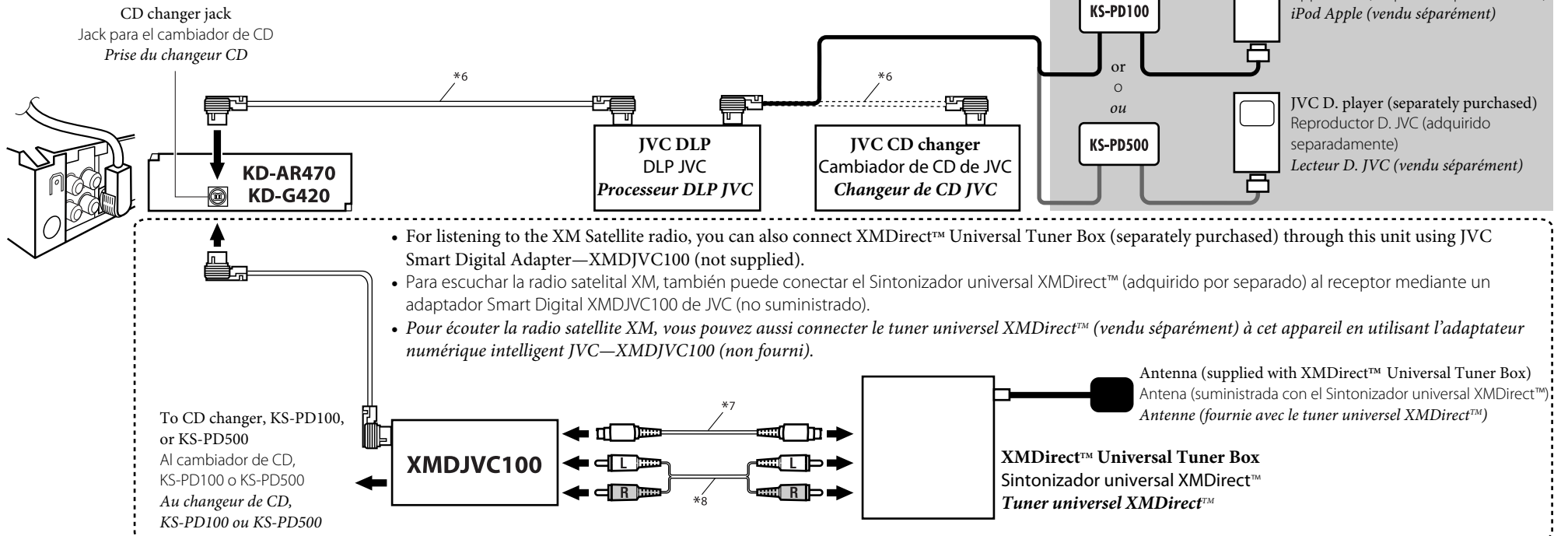

CAUTION / PRECAUCION / PRECAUTION:

- Before connecting the external components, make sure that the unit is turned off.
- Antes de conectar los componentes externos, asegúrese de que la unidad esté apagada.
- Avant de connecter les appareils extérieurs, assurez-vous que l'appareil est hors tension.

- *5 iPod is a trademark of Apple Computer, Inc., registered in the U.S. and other countries.
- *5 iPod es una marca comercial de Apple Computer, Inc., registrada en los EE.UU. y otros países.
- *5 iPod est une marque de commerce d'Apple Computer, Inc., enregistrée aux États-Unis et dans les autres pays.

- *6 Signal cord supplied with your JVC CD changer or DLP
- *6 Cable de señal suministrado con su cambiador de CD o DLP JVC
- *6 Cordon de signal fourni avec votre changeur de CD ou processeur DLP JVC

- *7 Signal cord supplied with your Smart Digital Adapter
- *7 Cable de señal suministrado con el adaptador Smart Digital
- *7 Cordon de signal fourni avec votre adaptateur numérique intelligent

- *8 Audio signal cord supplied with your Smart Digital Adapter
- *8 Cable de señal de audio suministrado con el adaptador Smart Digital
- *8 Cordon audio fourni avec votre adaptateur numérique intelligent

• Set "EXT IN" to "EXT IN" (See page 14 of the INSTRUCTIONS.) / Ajuste "EXT IN" a "EXT IN" (Consulte la página 14 del MANUAL DE INSTRUCCIONES.) / Réglez "EXT IN" sur "EXT IN" (Voir la page 14 du MANUEL D'INSTRUCTIONS.)

JVC PnP (Plug and Play) / PnP ("Plug and Play") JVC / PnP ("Plug and Play") JVC

You can also connect JVC PnP through this unit using JVC SIRIUS radio adapter, KS-U100K (not supplied).

- Turning on/off the unit can also turns on/off the JVC PnP.

También podrá conectar la PnP JVC a través de este receptor utilizando el adaptador para radio SIRIUS JVC, KS-U100K (no suministrado).

- Al encender/apagar el receptor también se enciende/apaga la PnP JVC.

Vous pouvez aussi connecter le PnP JVC à cet autoradio en utilisant l'adaptateur de radio SIRIUS JVC KS-U100K (non fourni).

- Mettre sous/hors tension l'autoradio peut aussi mettre sous/hors tension le PnP JVC.

Other external component / Otro componente externo / Autre appareil extérieur

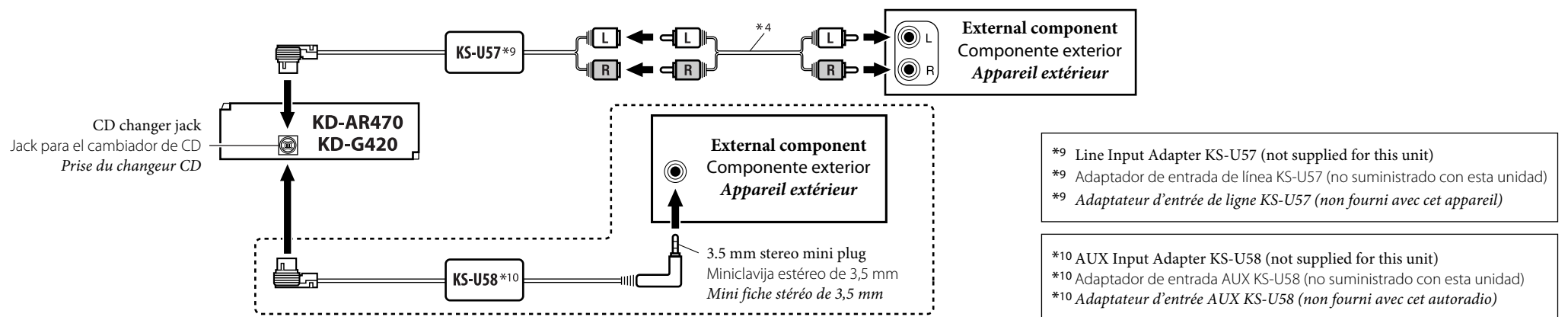

JVC



ENGLISH

FRANÇAIS

**CD RECEIVER
RECEPTEUR CD**

KD-G521

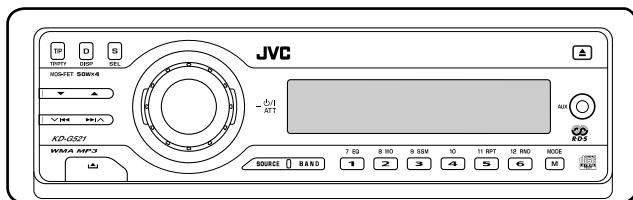
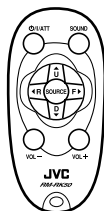
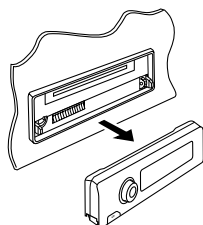

WMA

MP3



For canceling the display demonstration, see page 6.

Pour annuler la démonstration des affichages, référez-vous à la page 6.

For installation and connections, refer to the separate manual.

Pour l'installation et les raccordements, se référer au manuel séparé.

INSTRUCTIONS

MANUEL D'INSTRUCTIONS

GET0339-003A
[EX/EU]

Thank you for purchasing a JVC product.

Please read all instructions carefully before operation, to ensure your complete understanding and to obtain the best possible performance from the unit.

IMPORTANT FOR LASER PRODUCTS

1. CLASS 1 LASER PRODUCT
2. **CAUTION:** Do not open the top cover. There are no user serviceable parts inside the unit; leave all servicing to qualified service personnel.
3. **CAUTION:** Visible and invisible laser radiation when open and interlock failed or defeated. Avoid direct exposure to beam.
4. REPRODUCTION OF LABEL: CAUTION LABEL, PLACED OUTSIDE THE UNIT.

CAUTION: Visible and invisible laser radiation when open and interlock failed or defeated. AVOID DIRECT EXPOSURE TO BEAM.	ADVARSEL: Synlig og usynlig laserstråling når maskinen er åben eller interlocken fejler. Undgå direkte eksponering til strålingen.	WARNING: Synlig och osynlig laserstråling när den öppnas och spärren är urkopplad. Beträkta ej strålen.	VARO: Avtäckning och synlig laserstråling när enheten är öppen eller spärrarna är urkopplade. Undvik direkt exponering för strålen.
--	---	--	--

How to reset your unit

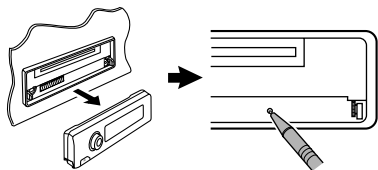

Your preset adjustments will also be erased.

How to forcibly eject a disc



“PLEASE” and “EJECT” appear alternately on the display.

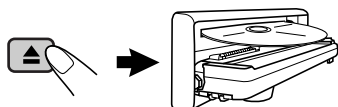

- If this does not work, reset your unit.
- Be careful not to drop the disc when it ejects.

How to detach/attach the control panel

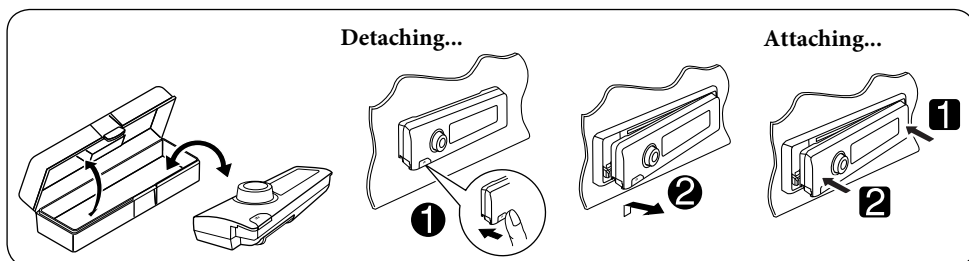

How to use the M MODE button

If you press M MODE, the unit goes into functions mode, then the number buttons and ▲/▼ buttons work as different function buttons.



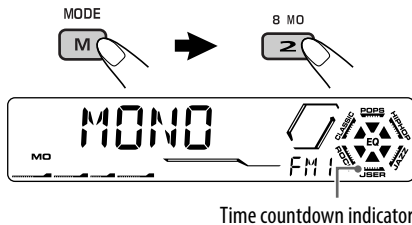

Ex.: When number button 2 works as MO (monaural) button.



To use these buttons for their original functions again after pressing M MODE, wait for 5 seconds without pressing any of these buttons until the functions mode is cleared or press M MODE again.

How to read this manual

- Button operations are mainly explained with the illustrations in the table below.
- Some related tips and notes are explained in “More about this unit” (see pages 19 – 21).

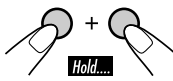
	Press briefly.
	Press repeatedly.
	Press either one.
	Press and hold until your desired response begins.
	Press and hold both buttons at the same time.

The following marks are used to indicate...

 : Built-in CD player operations.

 : External CD changer operations.

 : Indicator displayed for the corresponding operation.

Warning:

If you need to operate the unit while driving, be sure to look ahead carefully or you may be involved in a traffic accident.

Caution on volume setting:

Discs produce very little noise compared with other sources. Lower the volume before playing a disc to avoid damaging the speakers by the sudden increase of the output level.

CONTENTS

Control panel	4
Remote controller — RM-RK50	5
Getting started	6
Basic operations.....	6
Radio operations	7
FM RDS operations	8
Searching for your favorite FM RDS programme ...	8
Disc operations	10
Playing a disc in the unit	10
Playing discs in the CD changer	10
Sound adjustments	13
General settings — PSM	14
External component operations	17
DAB tuner operations	18
More about this unit	19
Maintenance	22
Troubleshooting	23
Specifications	25

Note: Only for [EX] model users in UK and European countries

For security reasons, a numbered ID card is provided with this unit, and the same ID number is imprinted on the unit's chassis. Keep the card in a safe place, as it will help the authorities to identify your unit if stolen.

For safety...

- Do not raise the volume level too much, as this will block outside sounds, making driving dangerous.
- Stop the car before performing any complicated operations.

Temperature inside the car...

If you have parked the car for a long time in hot or cold weather, wait until the temperature in the car becomes normal before operating the unit.

Control panel

Parts identification

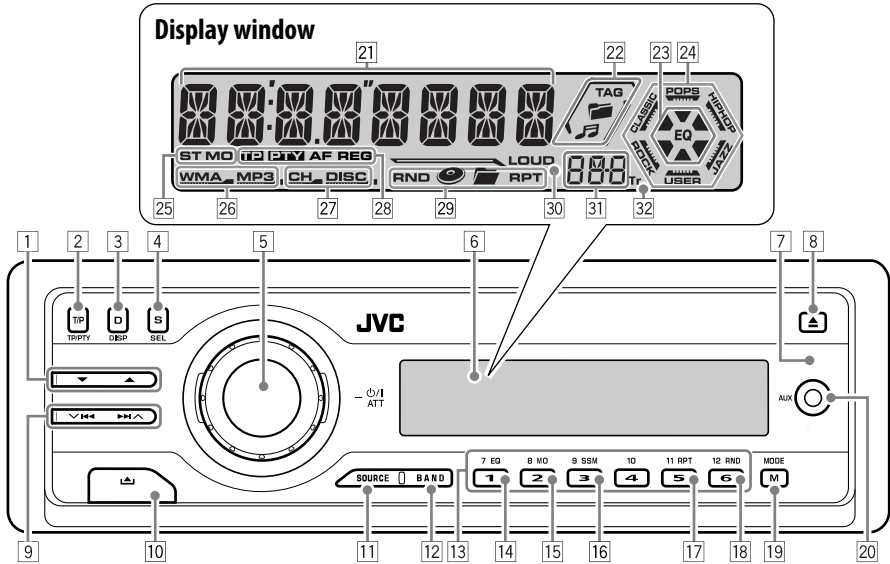

- 1 ▲ (up) / ▼ (down) buttons
- 2 T/P TP/PTY (traffic programme/ programme type) button
- 3 D DISP (display) button
- 4 S SEL (select) button
- 5 • Control dial
- 6 • ϕ /I ATT (standby/on attenuator) button
- 6 Display window
- 7 Remote sensor
 - DO NOT expose the remote sensor to strong light (direct sunlight or artificial lighting).
- 8 ▲ (eject) button
- 9 ▼ |◀▶▶▶|▲ buttons
- 10 ▲ (control panel release) button
- 11 SOURCE button
- 12 BAND button
- 13 Number buttons
- 14 EQ (equalizer) button
- 15 MO (monaural) button
- 16 SSM (Strong-station Sequential Memory) button
- 17 RPT (repeat) button
- 18 RND (random) button
- 19 M MODE button
- 20 AUX (auxiliary) input jack

Display window

- 21 Main display
- 22 Disc information indicators—TAG (ID3 Tag), (folder), (track/file)
- 23 EQ (equalizer) indicator
- 24 Sound mode (C-EQ: custom equalizer) indicators—ROCK, CLASSIC, POPS, HIP HOP, JAZZ, USER
 - also works as the time countdown indicator and level meter during play (see page 16).
- 25 Tuner reception indicators—ST (stereo), MO (monaural)
- 26 Disc type indicators—WMA, MP3
- 27 Playback source indicators—
 - CH: Lights up only when CD-CH is selected as the playback source.
 - DISC: Lights up for the built-in CD player.
- 28 RDS indicators—TP, PTY, AF, REG
- 29 Playback mode / item indicators—
 - RND (random), (disc), (folder), RPT (repeat)
- 30 LOUD (loudness) indicator
- 31 Source display / Volume level indicator
- 32 Tr (track) indicator

Installing the lithium coin battery (CR2025)

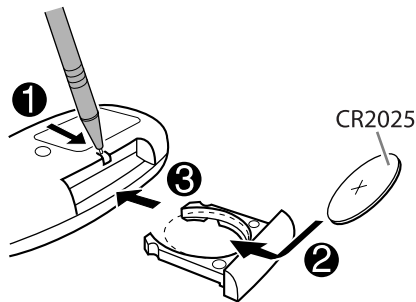

Aim the remote controller directly at the remote sensor on the unit. Make sure there is no obstacle in between.

Warning:

- Do not install any battery other than CR2025 or its equivalent; otherwise, it may explode.
- Store the battery in a place where children cannot reach to avoid risk of accident.
- To prevent the battery from over-heating, cracking, or starting a fire:
 - Do not recharge, short, disassemble, heat the battery, or dispose of it in a fire.
 - Do not leave the battery with other metallic materials.
 - Do not poke the battery with tweezers or similar tools.
 - Wrap the battery with tape and insulate when throwing away or saving it.

Caution:

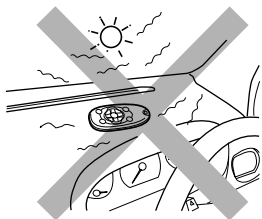

Main elements and features

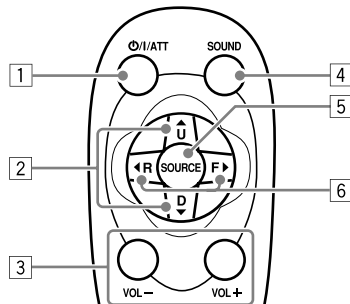

- 1 **⏻/ATT** (standby/on/attenuator) button
 - Turns the power on if pressed briefly or attenuates the sound when power is on.
 - Turns the power off if pressed and held.
- 2 **▲ U (up) / D (down) ▼** buttons
 - Changes the FM/AM/DAB bands with ▲ U only.
 - Changes the preset stations (or services) with D ▼ only.
 - Changes the folder of the MP3/WMA discs.
 - While playing an MP3 disc on an MP3-compatible CD changer:
 - Changes the disc if pressed briefly.
 - Changes the folder if pressed and held.
- 3 **VOL – / VOL +** buttons
 - Adjusts the volume level.
- 4 **SOUND** button
 - Selects the sound mode (C-EQ: custom equalizer).
- 5 **SOURCE** button
 - Selects the source.
- 6 **◀ R (reverse) / F (forward) ▶** buttons
 - Searches for stations (or services) if pressed briefly.
 - Searches for ensembles if pressed and held.
 - Fast-forwards or reverses the track if pressed and held.
 - Changes the tracks of the disc if pressed briefly.

The unit is equipped with the steering wheel remote control function.

- See the Installation/Connection Manual (separate volume) for connection.

Getting started

Basic operations

1 Turn on the power.

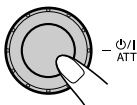

2

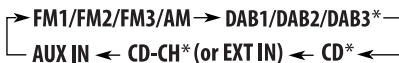

- Select “CD-CH” when using an Apple iPod® or a JVC D. player (see page 17).

iPod is a trademark of Apple Computer, Inc., registered in the U.S. and other countries.

* You cannot select these sources if they are not ready.

3

• For FM/AM tuner



• For DAB tuner



4

Adjust the volume.

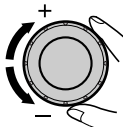

Volume level appears.



Volume level indicator

5

Adjust the sound as you want. (See pages 13 and 14.)

To drop the volume in a moment (ATT)

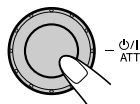

To restore the sound, press it again.

To turn off the power



Basic settings

- See also “General settings — PSM” on pages 14 – 16.

1



2

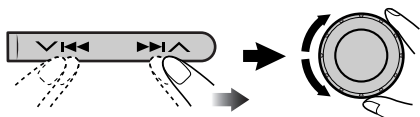

1 Canceling the display demonstrations

Select “DEMO,” then “DEMO OFF.”

2 Setting the clock

Select “CLOCK H” (hour), then adjust the hour.

Select “CLOCK M” (minute), then adjust the minute.

Select “24H/12H,” then “24H” (hour) or “12H” (hour).

3 Finish the procedure.



To check the current clock time when the power is turned off



Radio operations

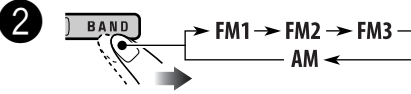
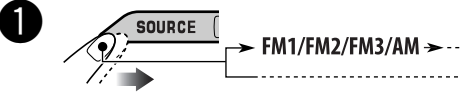

Lights up when receiving an FM stereo broadcast with sufficient signal strength.

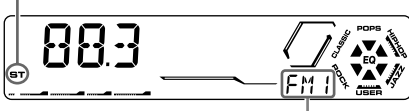

Selected band appears.

3 **Start searching for a station.**

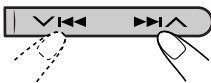

When a station is received, searching stops.

To stop searching, press the same button again.

To tune in to a station manually

In step 3 above...

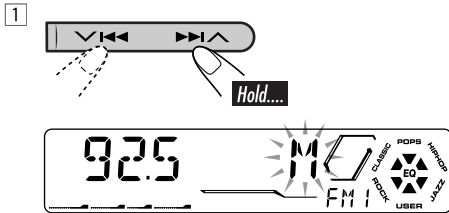

2 **Select the desired station frequencies.**

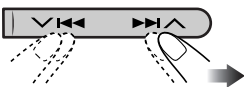

When an FM stereo broadcast is hard to receive

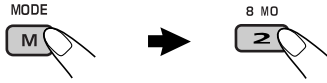

Lights up when monaural mode is activated.

Reception improves, but stereo effect will be lost.

To restore the stereo effect, repeat the same procedure. "MONO OFF" appears and the MO indicator goes off.

Storing stations in memory

You can preset six stations for each band.

FM station automatic presetting—SSM (Strong-station Sequential Memory)

1 **Select the FM band (FM1 – FM3) you want to store into.**



"SSM" flashes, then disappears when automatic presetting is over.

Local FM stations with the strongest signals are searched and stored automatically in the FM band.

Manual presetting

Ex.: Storing FM station of 92.5 MHz into preset number 4 of the FM1 band.

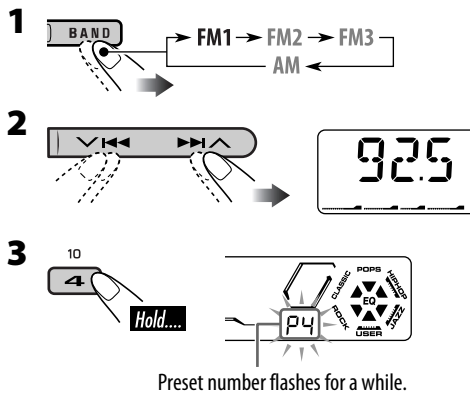

Listening to a preset station

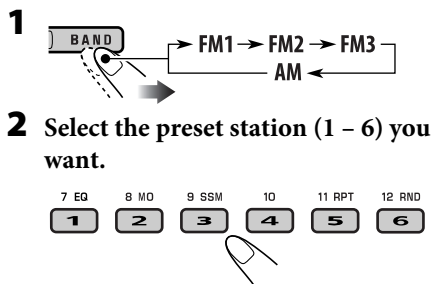

To check the current clock time while listening to an FM (non-RDS) or AM station

- For FM RDS stations, see page 10.



FM RDS operations

What you can do with RDS

RDS (Radio Data System) allows FM stations to send an additional signal along with their regular programme signals. By receiving the RDS data, this unit can do the following:

- Programme Type (PTY) Search (see the following)
- TA (Traffic Announcement) and PTY Standby Receptions (see pages 9 and 15)
- Tracing the same programme automatically —Network-Tracking Reception (see page 10)
- Programme Search (see page 15)

Searching for your favorite FM RDS programme

You can tune in to a station broadcasting your favorite programme by searching for a PTY code.

- To store your favorite programme types, see page 9.

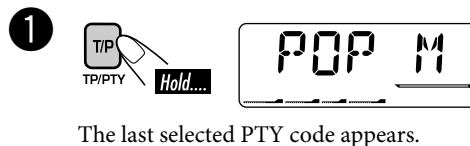

2 Select one of your favorite programme types.

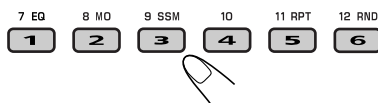

or

Select one of the PTY codes (see page 10).

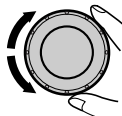

Using the standby receptions

TA Standby Reception

TA Standby Reception allows the unit to switch temporarily to Traffic Announcement (TA) from any source other than AM. The volume changes to the preset TA volume level (see page 15).

To activate TA Standby Reception



The TP (Traffic Programme) indicator either lights up or flashes.

- If the TP indicator lights up, TA Standby Reception is activated.
- If the TP indicator flashes, TA Standby Reception is not yet activated. (This occurs when you are listening to an FM station without the RDS signals required for TA Standby Reception.)
To activate TA Standby Reception, tune in to another station providing these signals. The TP indicator will stop flashing and remain lit.

To deactivate the TA Standby Reception



The TP indicator goes off.

PTY Standby Reception

PTY Standby Reception allows the unit to switch temporarily to your favorite PTY programme from any source other than AM.

To activate and select your favorite PTY code for PTY Standby Reception, see page 15. The PTY indicator either lights up or flashes.

- If the PTY indicator lights up, PTY Standby Reception is activated.
- If the PTY indicator flashes, PTY Standby Reception is not yet activated.
To activate PTY Standby Reception, tune in to another station providing these signals. The PTY indicator will stop flashing and remain lit.

To deactivate the PTY Standby Reception, select "OFF" for the PTY code (see page 15). The PTY indicator goes off.

3 Start searching for your favorite programme.

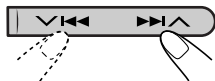

If there is a station broadcasting a programme of the same PTY code as you have selected, that station is tuned in.

Storing your favorite programme types

You can store six favorite programme types.

Preset programme types in the number buttons (1 to 6):

1	2	3	4	5	6
POP M	ROCK M	EASY M	CLASSICS	AFFAIRS	VARIED

- 1 Select a PTY code (see page 8).
- 2 Select the preset number (1 – 6) you want to store into.



Ex.: When "ROCK M" is selected

- 3 Repeat steps 1 and 2 to store other PTY codes into other preset numbers.
- 4 Finish the procedure.



Tracing the same programme— Network-Tracking Reception

When driving in an area where FM reception is not sufficient enough, this unit automatically tunes in to another FM RDS station of the same network, possibly broadcasting the same programme with stronger signals (see the illustration below).

When shipped from the factory, Network-Tracking Reception is activated.

To change the Network-Tracking Reception setting, see “AF-REG” on page 15.

Programme A broadcasting on different frequency areas (01 – 05)

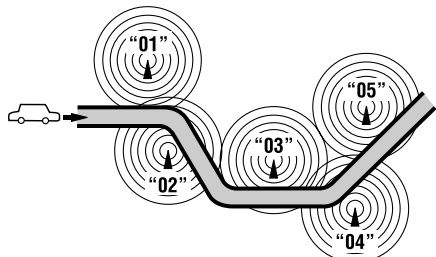

To check the current clock time while listening to an FM RDS station



**Station name (PS) → Station
Frequency → Programme type
(PTY) → Clock →** (back to the
beginning)

PTY codes

NEWS, AFFAIRS, INFO, SPORT, EDUCATE,
DRAMA, CULTURE, SCIENCE, VARIED,
POP M (music), ROCK M (music), EASY
M (music), LIGHT M (music), CLASSICS,
OTHER M (music), WEATHER, FINANCE,
CHILDREN, SOCIAL, RELIGION, PHONE
IN, TRAVEL, LEISURE, JAZZ, COUNTRY,
NATION M (music), OLDIES, FOLK M
(music), DOCUMENT

Disc operations

Playing a disc in the unit

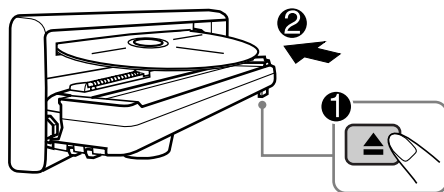

All tracks will be played repeatedly until you change the source or eject the disc.

To stop play and eject the disc



Playing discs in the CD changer

All discs in the magazine will be played repeatedly until you change the source.

- Ejecting the magazine will also stop playing.

1

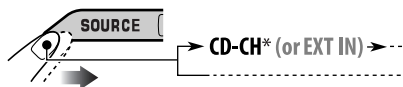

* If you have changed “EXT IN” setting to “EXT IN” (see page 16), you cannot select the CD changer.

See also page 17 when using an iPod or JVC D. player.

2

Select a disc.

For disc number from 01 – 06:



For disc number from 07 – 12:



About MP3 and WMA discs

MP3 and WMA “tracks” (words “file” and “track” are used interchangeably) are recorded in “folders.”

About the CD changer

It is recommended to use a JVC MP3-compatible CD changer with your unit.

- You can also connect other CH-X series CD changers (except CH-X99 and CH-X100). These units are not compatible with MP3 discs.
- You cannot play any WMA disc in the CD changer.
- You cannot use the KD-MK series CD changers with this unit.
- Disc text information recorded in the CD Text can be displayed when a JVC CD Text compatible CD changer is connected.
- For connection, see Installation/Connection Manual (separate volume).

To fast-forward or reverse the track



To go to the next or previous tracks



To go to the next or previous folders (only for MP3 or WMA discs)

For MP3 discs:  

For WMA discs: 

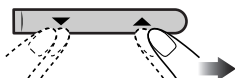

To locate a particular track (for CD) or folder (for MP3 or WMA discs) directly



To select a number from 01 – 06:



To select a number from 07 – 12:

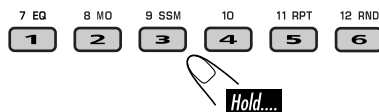

- To use folder search on MP3/WMA discs, it is required that folders are assigned with 2-digit numbers at the beginning of their folder names—01, 02, 03, and so on.

• To select a particular track in a folder (for MP3 or WMA disc):

Other main functions

■ Skipping a track quickly during play



Only possible on JVC
MP3-compatible CD changer

- For MP3 or WMA disc, you can skip a track within the same folder.

Ex.: To select track 32 while playing track 6

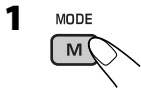

Each time you press the button, you can skip 10 tracks.

- After the last track, the first track will be selected and vice versa.



■ Prohibiting disc ejection



You can lock a disc in the loading slot.

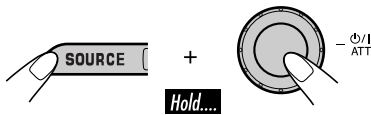

To cancel the prohibition, repeat the same procedure.



Changing the display information



■ While playing an audio CD or a CD Text



■ While playing an MP3 or WMA*2 disc

- When "TAG DISP" is set to "TAG ON"
(see page 16)

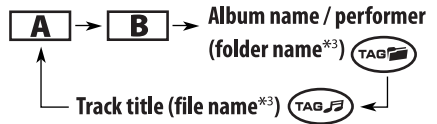

- When "TAG DISP" is set to "TAG OFF"

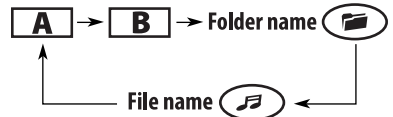

A : Elapsed playing time with the current track number

B : Clock with the current track number

*1 If the current disc is an audio CD, "NO NAME" appears.

*2 Only for the built-in CD player.

*3 If an MP3/WMA file does not have ID3 tags, folder name and file name appear. In this case, the TAG indicator will not light up.

Selecting the playback modes

You can use only one of the following playback modes at a time.



2 Select your desired playback mode.

Repeat play

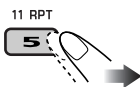

Mode	Plays repeatedly
TRK RPT	: The current track.
FLDR RPT*1	: All tracks of the current folder.
DISC RPT*2	: All tracks of the current disc.
RPT OFF	: Cancels.

Random play



Mode	Plays at random
FLDR RND*1	: All tracks of the current folder, then tracks of the next folder and so on.
DISC RND	: All tracks of the current disc.
MAG RND*2	: All tracks of the inserted discs.
RND OFF	: Cancels.

*1 Only while playing an MP3 or WMA disc.

*2 Only while playing discs in the CD changer.

Sound adjustments

You can select a preset sound mode suitable to the music genre (C-EQ: custom equalizer).

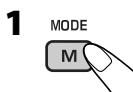

Preset values	BAS (bass)	TRE (treble)	LOUD (loudness)
USER (Flat sound)	00	00	OFF
ROCK (Rock or disco music)	+03	+01	ON
CLASSIC (Classical music)	+01	-02	OFF
POPS (Light music)	+04	+01	OFF
HIP HOP (Funk or rap music)	+02	00	ON
JAZZ (Jazz music)	+02	+03	OFF

Adjusting the sound

You can adjust the sound characteristics to your preference.

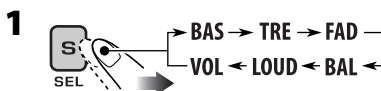

To be continued...

2

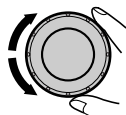

Indication pattern changes as you adjust the level.



Ex.: When "TRE" is selected

Indication [Range]

BAS*1 (bass)

Adjust the bass. [-06 to +06]

TRE*1 (treble)

Adjust the treble. [-06 to +06]

FAD*2 (fader)

Adjust the front and rear speaker balance.
[R06 to F06]

BAL (balance)

Adjust the left and right speaker balance.
[L06 to R06]

LOUD*1 (loudness)

Boost low and high frequencies to produce
a well-balanced sound at low volume level.
[LOUD ON or LOUD OFF]

VOL (volume)

Adjust the volume. [00 to 30 or 50*3]

*1 When you adjust the bass, treble, or loudness, the adjustment you have made is stored for the currently selected sound mode (C-EQ) including "USER."

*2 If you are using a two-speaker system, set the fader level to "00."

*3 Depending on the amplifier gain control setting. (See page 16 for details.)

General settings — PSM

You can change PSM (Preferred Setting Mode) items listed in the table that follows.

1



2 Select a PSM item.

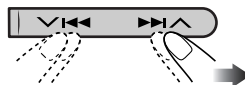

Ex.: When you select "DIMMER"

3 Adjust the PSM item selected.

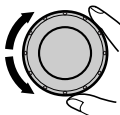

4 Repeat steps 2 and 3 to adjust the other PSM items if necessary.

5 Finish the procedure.



Indications	Selectable settings, [reference page]
DEMO Display demonstration	DEMO ON : [Initial]; Display demonstration will be activated automatically if no operation is done for about 20 seconds, [6]. DEMO OFF : Cancels.
CLOCK H Hour adjustment	0 – 23 (1 – 12), [6] [Initial: 0 (0:00)]
CLOCK M Minute adjustment	00 – 59, [6] [Initial: 00 (0:00)]
24H/12H Time display mode	12H ⇄ 24H, [6] [Initial: 24H]
CLK ADJ Clock adjustment	AUTO : [Initial]; The built-in clock is automatically adjusted using the CT (clock time) data in the RDS signal. OFF : Cancels.
AF-REG *5 Alternative frequency/ regionalization reception	When the received signals from the current FM RDS station or DAB service become weak.. AF : [Initial]; Switches to another station (or service) (the programme may differ from the one currently received), [10, 19]. • The AF indicator lights up. AF REG : Switches to another station broadcasting the same programme. • The AF and REG indicators light up. OFF : Cancels (not selectable when “DAB AF” is set to “AF ON”).
PTY-STBY *5 PTY standby	Activates PTY Standby Reception with one of the PTY codes, [9]. OFF [Initial] → PTY codes, [10] → (back to the beginning)
TA VOL Traffic announcement volume	[Initial: VOL 15]; VOL 00 — VOL 30 or 50*4, [9]
P-SEARCH *5 Programme search	ON : Using the AF data, the unit tunes in to another frequency broadcasting the same programme as the original preset RDS station is if the preset station signals are not sufficient. OFF : [Initial]; Cancels.
DAB AF *6 Alternative frequency reception	AF ON : [Initial]; Traces the programme among DAB services and FM RDS stations, [10, 19]. AF OFF : Cancels.

*4 Depends on the amplifier gain control.

*5 Only for FM RDS stations.

*6 Displayed only when DAB tuner is connected.

To be continued...

Indications	Selectable settings, [reference page]
DAB VOL * ₁ DAB volume adjustment	You can adjust the volume level (VOL -12 — VOL +12) of DAB tuner to match the FM sound level and store it in memory. [Initial: VOL 00]
LEVEL Audio level meter	ON : [Initial]; Activates the audio level indicator. OFF : Cancels; sound mode indicator is shown.
DIMMER Dimmer	AUTO : [Initial]; Dims the display when you turn on the headlights. ON : Activates dimmer. OFF : Cancels.
TEL Telephone muting	MUTING 1/MUTING 2 : Select either one which mutes the sounds while using the cellular phone. OFF : [Initial]; Cancels.
SCROLL * ₂ Scroll	ONCE : [Initial]; Scrolls the disc information once. AUTO : Repeats scrolling (5-second intervals in between). OFF : Cancels. • Pressing D DISP for more than one second can scroll the display regardless of the setting.
EXT IN * ₃ External input	CHANGER : [Initial]; To use a JVC CD changer, [10], an Apple iPod, a JVC D. player, [17], and/or DAB tuner, [18]. EXT IN : To use another external component, [17].
AUX ADJ Auxiliary input level adjustment	A.ADJ 00 – A.ADJ 05 : Adjust the auxiliary input level to avoid the sudden increase of the output level when changing the source from external component connected to the AUX input jack on the control panel. [Initial: A.ADJ 00]
TAG DISP Tag display	TAG ON : [Initial]; Shows the ID3 tag while playing MP3/WMA tracks, [12]. TAG OFF : Cancels.
AMP GAIN Amplifier gain control	You can change the maximum volume level of this unit. LOW PWR : VOL 00 – VOL 30 (Select this if the maximum power of the speaker is less than 50 W to prevent them from damaging the speaker.) HIGH PWR : [Initial]; VOL 00 – VOL 50

*₁ Displayed only when DAB tuner is connected.

*₂ Some characters or symbols will not be shown correctly (or will be blanked) on the display.

*₃ Displayed only when one of the following sources is selected—FM, AM, CD, or AUX IN.

External component operations

You can connect an external component to...

- CD changer jack on the rear using:
 - Line Input Adapter—KS-U57 (not supplied) or AUX Input Adapter—KS-U58 (not supplied) for any other components (except iPod and D. player).
 - Interface adapter for iPod®—KS-PD100 (not supplied) for controlling iPod.
 - D. player interface adapter—KS-PD500 (not supplied) for controlling D. player.
- AUX (auxiliary) input jack on the control panel.

For connection, see Installation/Connection Manual (separate volume).

Connecting an external component to the AUX input jack

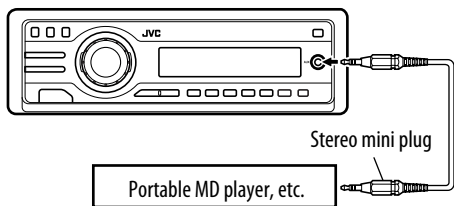

- 1 For selecting the external component connected to...
 - AUX input jack

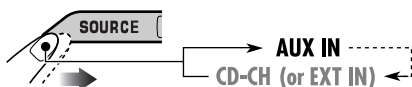

- CD changer jack on the rear using KS-U57 or KS-U58
If "EXT IN" does not appear, see page 16 and select the external input ("EXT IN").

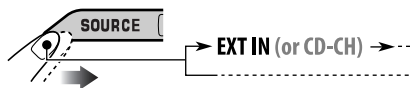

- CD changer jack on the rear using interface adapter for iPod—KS-PD100 or for D. player—KS-PD500

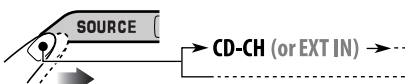

- 2 Turn on the connected component and start playing the source.

- 3 Adjust the volume.

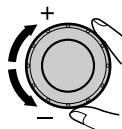

- 4 Adjust the sound as you want. (See pages 13 and 14.)

To check the clock time while listening to an external component



AUX IN, EXT IN, or CD-CH* ↔ Clock

* See "While playing an MP3 or WMA disc" on page 12 for details.

DAB tuner operations

What is DAB system?

Digital Audio Broadcasting (DAB) can deliver digital quality sound without any annoying interference and signal distortion. Furthermore, it can carry text, pictures, and data. When transmitting, DAB combines several programmes (called “services”) to form one “ensemble.” In addition, each “service”—called “primary service”—can also be divided into its components (called “secondary service”). A typical ensemble has six or more programmes (services) broadcast at the same time.

By connecting the DAB tuner, this unit can do the following:

- Tracing the same programme automatically —Alternative Frequency Reception (see “DAB AF” on page 15).

It is recommended to use DAB tuner KT-DB1000 with your unit. If you have another DAB tuner, consult your JVC IN-CAR ENTERTAINMENT dealer.

- Refer also to the Instructions supplied for your DAB tuner.

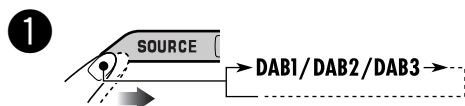

3 Start searching for an ensemble.

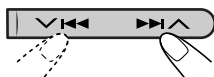

When an ensemble is received, searching stops.

To stop searching, press the same button again.

4 Select a service (either primary or secondary) to listen to.

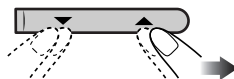

To tune in to an ensemble manually

Start searching for an ensemble, as in step 3 on the left column...

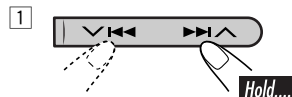

2 Select the desired ensemble frequencies.

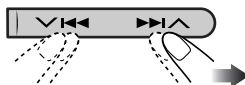

Storing DAB services in memory

You can preset six DAB services (primary) for each band.

1 Select a service you want (see steps 1 to 4 above).

2 Select the preset number (1 – 6) you want to store into.

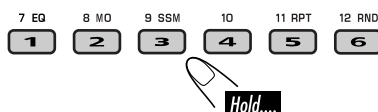

Preset number flashes for a while.

Tuning in to a preset DAB service

- 
- Select the preset DAB service (primary) number (1 – 6) you want.

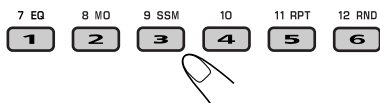

If the selected primary service has some secondary services, pressing the same button again will tune in to the secondary services.

Tracing the same programme— Alternative Frequency Reception

You can keep listening to the same programme by activating the Alternative Frequency Reception.

- **While receiving a DAB service:**
When driving in an area where a service cannot be received, this unit automatically tunes in to another ensemble or FM RDS station, broadcasting the same programme.
- **While receiving an FM RDS station:**
When driving in an area where a DAB service is broadcasting the same programme as the FM RDS station is broadcasting, this unit automatically tunes in to the DAB service.

When shipped from the factory, Alternative Frequency Reception is activated.

To deactivate the Alternative Frequency Reception, see page 15.

To change the display information while tuning to an ensemble



Service name → Ensemble name → Channel number → Frequency → Clock → (back to the beginning)

More about this unit

Basic operations

Turning on the power

- By pressing SOURCE on the unit, you can also turn on the power. If the source is ready, playback also starts.

Turning off the power

- If you turn off the power while listening to a disc, disc play will start from where playback has been stopped previously, next time you turn on the power.

Selecting the sources

- When no disc is loaded in the unit, “CD” cannot be selected.
- “CD-CH” or “DAB” cannot be selected when the target component is not connected.

Tuner operations

Storing stations in memory

- During SSM search...
 - All previously stored stations are erased and stations are stored newly.
 - Received stations are preset in No. 1 (lowest frequency) to No. 6 (highest frequency).
 - When SSM is over, the station stored in No. 1 will be automatically tuned in.
- When storing a station manually, a previously preset station is erased when a new station is stored in the same preset number.

FM RDS operations

- Network-Tracking Reception requires two types of RDS signals—PI (Programme Identification) and AF (Alternative Frequency) to work correctly. Without receiving these data correctly, Network-Tracking Reception will not operate correctly.

To be continued...

- If a Traffic Announcement is received by TA Standby Reception, the volume level (TA VOL) automatically changes to the preset level.
- When Alternative Frequency Reception is activated (with AF selected), Network-Tracking Reception is also activated automatically. On the other hand, Network-Tracking Reception cannot be deactivated without deactivating Alternative Frequency Reception. (See page 15.)
- If you want to know more about RDS, visit «<http://www.rds.org.uk>».

Disc operations

Caution for DualDisc playback

- The Non-DVD side of a “DualDisc” does not comply with the “Compact Disc Digital Audio” standard. Therefore, the use of Non-DVD side of a DualDisc on this product may not be recommended.

General

- This unit has been designed to reproduce CDs/CD Texts, and CD-Rs (Recordable)/CD-RWs (Rewritable) in audio CD (CD-DA), MP3 and WMA formats.
- When a disc has been loaded, selecting “CD” for the playback source starts disc play.

Inserting a disc

- When a disc is inserted upside down, “PLEASE” and “EJECT” appear alternately on the display. Press ▲ to eject the disc.
- Do not insert 8 cm discs (single CD) and unusual shape discs (heart, flower, etc.) into the loading slot.

Playing a disc

- While fast-forwarding or reversing on an MP3 or WMA disc, you can only hear intermittent sounds.

Playing a CD-R or CD-RW

- Use only “finalized” CD-Rs or CD-RWs.
- This unit can play back only the files of the same type which is first detected if a disc includes both audio CD (CD-DA) files and MP3/WMA files.
- This unit can play back multi-session discs; however, unclosed sessions will be skipped while playing.
- Some CD-Rs or CD-RWs may not play back on this unit because of their disc characteristics, and for the following causes:
 - Discs are dirty or scratched.
 - Moisture condensation occurs on the lens inside the unit.
 - The pickup lens inside the unit is dirty.
 - CD-R/CD-RW on which the files are written with “Packet Write” method.
 - There are improper recording conditions (missing data, etc.) or media conditions (stain, scratch, warp, etc.).
- CD-RWs may require a longer readout time since the reflectance of CD-RWs is lower than that of regular CDs.
- Do not use the following CD-Rs or CD-RWs:
 - Discs with stickers, labels, or protective seal stuck to the surface.
 - Discs on which labels can be directly printed by an ink jet printer.
 Using these discs under high temperatures or high humidities may cause malfunctions or damages to the unit.

Playing an MP3/WMA disc

- This unit can play back MP3/WMA files with the extension code <.mp3> or <.wma> (regardless of the letter case—upper/lower).
- This unit can show the names of albums, artists (performer), and ID3 Tag (Version 1.0, 1.1, 2.2, 2.3, or 2.4) for MP3 files and for WMA files.
- This unit can display only one-byte characters. No other characters can be correctly displayed.
- This unit can play back MP3/WMA files meeting the conditions below:
 - Bit rate: 8 kbps — 320 kbps
 - Sampling frequency:
 - 48 kHz, 44.1 kHz, 32 kHz (for MPEG-1)
 - 24 kHz, 22.05 kHz, 16 kHz (for MPEG-2)
 - Disc format: ISO 9660 Level 1/ Level 2, Romeo, Joliet, Windows long file name
- The maximum number of characters for file/folder names vary among the disc format used (includes 4 extension characters—<.mp3> or <.wma>).
 - ISO 9660 Level 1: up to 12 characters
 - ISO 9660 Level 2: up to 31 characters
 - Romeo*: up to 128 (72) characters
 - Joliet*: up to 64 (36) characters
 - Windows long file name*: up to 128 (72) characters

* *The parenthetic figure is the maximum number of characters for file/folder names in case the total number of files and folders is 313 or more.*

- This unit can recognize the total of 512 files, of 200 folders, and of 8 hierarchies.
- This unit can play back the files recorded in VBR (variable bit rate).

The files recorded in VBR have a discrepancy in elapsed time display, and do not show the actual elapsed time. Especially, after performing the search function, this difference becomes noticeable.

- This unit cannot play back the following files:
 - MP3 files encoded with MP3i and MP3 PRO format.
 - MP3 files encoded in an unappropriated format.
 - MP3 files encoded with Layer 1/2.
 - WMA files encoded with lossless, professional, and voice format.
 - WMA files which are not based upon Windows Media® Audio.
 - WMA files copy-protected with DRM.
 - Files which have the data such as WAVE, ATRAC3, etc.
- The search function works but search speed is not constant.

Changing the source

- If you change the source, playback also stops (without ejecting the disc). Next time you select “CD” for the playback source, disc play starts from where it has been stopped previously.

Ejecting a disc

- If the ejected disc is not removed within 15 seconds, the disc is automatically inserted again into the loading slot to protect it from dust. (Disc will not play this time.)

General settings—PSM

- If you change the “AMP GAIN” setting from “HIGH PWR” to “LOW PWR” while the volume level is set higher than “VOL 30,” the unit automatically changes the volume level to “VOL 30.”

DAB tuner operations

- Only primary DAB services can be presetted even when you store a secondary service.
- A previously preset DAB service is erased when a new DAB service is stored in the same preset number.

Maintenance

How to clean the connectors

Frequent detachment will deteriorate the connectors.

To minimize this possibility, periodically wipe the connectors with a cotton swab or cloth moistened with alcohol, being careful not to damage the connectors.

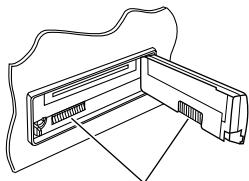

Connector

Moisture condensation

Moisture may condense on the lens inside the CD player in the following cases:

- After starting the heater in the car.
- If it becomes very humid inside the car.

Should this occur, the CD player may malfunction. In this case, eject the disc and leave the unit turned on for a few hours until the moisture evaporates.

How to handle discs

When removing a disc from its case, press down the center holder of the case and lift the disc out, holding it by the edges.

- Always hold the disc by the edges. Do not touch its recording surface.

When storing a disc into its case, gently insert the disc around the center holder (with the printed surface facing up).

- Make sure to store discs into the cases after use.

Center holder



To keep discs clean

A dirty disc may not play correctly. If a disc does become dirty, wipe it with a soft cloth in a straight line from center to edge.



- Do not use any solvent (for example, conventional record cleaner, spray, thinner, benzene, etc.) to clean discs.

To play new discs

New discs may have some rough spots around the inner and outer edges. If such a disc is used, this unit may reject the disc.



To remove these rough spots, rub the edges with a pencil or ball-point pen, etc.

Do not use the following discs:



Troubleshooting

What appears to be trouble is not always serious. Check the following points before calling a service center.

	Symptoms	Remedies/Causes
General	<ul style="list-style-type: none"> • Sound cannot be heard from the speakers. 	<ul style="list-style-type: none"> • Adjust the volume to the optimum level. • Check the cords and connections.
	<ul style="list-style-type: none"> • The unit does not work at all. 	Reset the unit (see page 2).
FM/AM	<ul style="list-style-type: none"> • SSM automatic presetting does not work. 	Store stations manually.
	<ul style="list-style-type: none"> • Static noise while listening to the radio. 	Connect the aerial firmly.
Disc playback	<ul style="list-style-type: none"> • Disc cannot be played back. 	Insert the disc correctly.
	<ul style="list-style-type: none"> • CD-R/CD-RW cannot be played back. • Tracks on the CD-R/CD-RW cannot be skipped. 	<ul style="list-style-type: none"> • Insert a finalized CD-R/CD-RW. • Finalize the CD-R/CD-RW with the component which you used for recording.
	<ul style="list-style-type: none"> • Disc can be neither played back nor ejected. 	<ul style="list-style-type: none"> • Unlock the disc (see page 12). • Eject the disc forcibly (see page 2).
	<ul style="list-style-type: none"> • Disc sound is sometimes interrupted. 	<ul style="list-style-type: none"> • Stop playback while driving on rough roads. • Change the disc. • Check the cords and connections.
MP3/WMA playback	<ul style="list-style-type: none"> • Disc cannot be played back. 	<ul style="list-style-type: none"> • Use a disc with MP3/WMA tracks recorded in the format compliant with ISO 9660 Level 1, Level 2, Romeo, or Joliet. • Add the extension code <.mp3> or <.wma> to the file names.
	<ul style="list-style-type: none"> • Noise is generated. 	Skip to another track or change the disc. (Do not add the extension code <.mp3> or <.wma> to non-MP3 or WMA tracks.)

To be continued...

	Symptoms	Remedies/Causes
MP3/WMA playback	<ul style="list-style-type: none"> • A longer readout time is required (“CHECK” keeps flashing on the display). 	Do not use too many hierarchies and folders.
	<ul style="list-style-type: none"> • Tracks do not play back in the order you have intended them to play. 	Playback order is determined when the files are recorded.
	<ul style="list-style-type: none"> • Elapsed playing time is not correct. 	This sometimes occurs during play. This is caused by how the tracks are recorded on the disc.
	<ul style="list-style-type: none"> • “NO FILES” appears on the display. 	Insert a disc that contains MP3/WMA tracks.
	<ul style="list-style-type: none"> • Correct characters are not displayed (e.g. album name). 	This unit can only display alphabets (upper case), numbers, and a limited number of symbols.
CD changer	<ul style="list-style-type: none"> • “NO DISC” appears on the display. 	Insert a disc into the magazine.
	<ul style="list-style-type: none"> • “NO MAG” appears on the display. 	Insert the magazine.
	<ul style="list-style-type: none"> • “RESET 8” appears on the display. 	Connect this unit and the CD changer correctly and press the reset button of the CD changer.
	<ul style="list-style-type: none"> • “RESET 1” – “RESET 7” appears on the display. 	Press the reset button of the CD changer.
	<ul style="list-style-type: none"> • The CD changer does not work at all. 	Reset the unit (see page 2).
DAB	<ul style="list-style-type: none"> • “noSIGNAL” appears on the display. 	Move to an area with stronger signals.
	<ul style="list-style-type: none"> • “RESET 8” appears on the display. 	Connect this unit and the DAB tuner correctly and reset the unit (see page 2).
	<ul style="list-style-type: none"> • “ANTENANG” appears on the display. 	Check the cords and connections.
	<ul style="list-style-type: none"> • The DAB tuner does not work at all. 	Reconnect this unit and the DAB tuner correctly and reset the unit (see page 2).

- Microsoft and Windows Media are either registered trademarks or trademarks of Microsoft Corporation in the United States and/or other countries.

Specifications

AUDIO AMPLIFIER SECTION

Maximum Power Output:

Front: 50 W per channel

Rear: 50 W per channel

Continuous Power Output (RMS):

Front: 19 W per channel into 4 Ω , 40 Hz to 20 000 Hz at no more than 0.8% total harmonic distortion.

Rear: 19 W per channel into 4 Ω , 40 Hz to 20 000 Hz at no more than 0.8% total harmonic distortion.

Load Impedance: 4 Ω (4 Ω to 8 Ω allowance)

Tone Control Range:

Bass: ± 10 dB at 100 Hz

Treble: ± 10 dB at 10 kHz

Frequency Response: 40 Hz to 20 000 Hz

Signal-to-Noise Ratio: 70 dB

Line-Out Level/Impedance:

2.5 V/20 k Ω load (full scale)

Output Impedance: 1 k Ω

Other Terminals:

CD changer, Steering wheel remote input, AUX (auxiliary) input jack

TUNER SECTION

Frequency Range:

FM: 87.5 MHz to 108.0 MHz

AM: (MW) 522 kHz to 1 620 kHz

(LW) 144 kHz to 279 kHz

[FM Tuner]

Usable Sensitivity: 11.3 dBf (1.0 μ V/75 Ω)

50 dB Quieting Sensitivity:

16.3 dBf (1.8 μ V/75 Ω)

Alternate Channel Selectivity (400 kHz): 65 dB

Frequency Response: 40 Hz to 15 000 Hz

Stereo Separation: 35 dB

Capture Ratio: 1.5 dB

[MW Tuner]

Sensitivity: 20 μ V

Selectivity: 35 dB

[LW Tuner]

Sensitivity: 50 μ V

CD PLAYER SECTION

Type: Compact disc player

Signal Detection System: Non-contact optical pickup (semiconductor laser)

Number of Channels: 2 channels (stereo)

Frequency Response: 5 Hz to 20 000 Hz

Dynamic Range: 96 dB

Signal-to-Noise Ratio: 98 dB

Wow and Flutter: Less than measurable limit

MP3 Decoding Format:

MPEG1/2 Audio Layer 3

Max. Bit Rate: 320 kbps

WMA (Windows Media[®] Audio) Decoding

Format:

Max. Bit Rate: 192 kbps

GENERAL

Power Requirement:

Operating Voltage:

DC 14.4 V (11 V to 16 V allowance)

Grounding System: Negative ground

Allowable Operating Temperature:

0°C to +40°C

Dimensions (W \times H \times D):

Installation Size (approx.):

182 mm \times 52 mm \times 150 mm

Panel Size (approx.):

188 mm \times 58 mm \times 11 mm

Mass (approx.):

1.5 kg (excluding accessories)

Design and specifications are subject to change without notice.



Having TROUBLE with operation?

Please reset your unit

Refer to page of How to reset your unit

**Vous avez des PROBLÈMES de
fonctionnement?**

Réinitialisez votre appareil

Référez-vous à la page intitulée Comment réinitialiser votre appareil

JVC



EN, FR

© 2005 Victor Company of Japan, Limited

0905DTSMDTJEIN

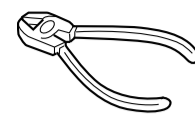
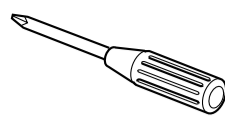

ENGLISH

This unit is designed to operate on **12 V DC, NEGATIVE ground electrical systems**. If your vehicle does not have this system, a voltage inverter is required, which can be purchased at JVC IN-CAR ENTERTAINMENT dealers.

WARNINGS

To prevent short circuits, we recommend that you disconnect the battery's negative terminal and make all electrical connections before installing the unit.

- **Be sure to ground this unit to the car's chassis again after installation.**

Notes:

- Replace the fuse with one of the specified rating. If the fuse blows frequently, consult your JVC IN-CAR ENTERTAINMENT dealer.
- It is recommended to connect to the speakers with maximum power of more than 50 W (both at the rear and at the front, with an impedance of **4 Ω to 8 Ω**). If the maximum power is less than 50 W, change "AMP GAIN" setting to prevent the speakers from being damaged (see page 16 of the INSTRUCTIONS).
- To prevent short-circuit, cover the terminals of the UNUSED leads with insulating tape.
- The heat sink becomes very hot after use. Be careful not to touch it when removing this unit.

Heat sink
Dissipateur de chaleur

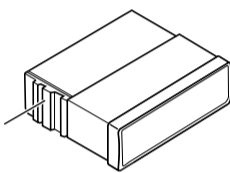

FRANÇAIS

Cet appareil est conçu pour fonctionner sur des sources de **courant continu de 12 V à masse NEGATIVE**. Si votre véhicule n'offre pas ce type d'alimentation, il vous faut un convertisseur de tension, que vous pouvez acheter chez un revendeur d'autoradios JVC.

AVERTISSEMENTS

Pour éviter tout court-circuit, nous vous recommandons de débrancher la borne négative de la batterie et d'effectuer tous les raccordements électriques avant d'installer l'appareil.

- **Assurez-vous de raccorder de nouveau la mise à la masse de cet appareil au châssis de la voiture après l'installation.**

Remarques:

- Remplacer le fusible par un de la valeur précisée. Si le fusible saute souvent, consulter votre revendeur d'autoradios JVC.
- Il est recommandé de connecter des enceintes avec une puissance de plus de 50 W (les enceintes arrière et les enceintes avant, avec une impédance comprise entre **4 Ω et 8 Ω**). Si la puissance maximum est inférieure à 50 W, changez "AMP GAIN" pour éviter d'endommager vos enceintes (voir page 16 du MANUEL D'INSTRUCTIONS).
- Pour éviter les court-circuits, couvrir les bornes des fils qui ne sont PAS UTILISÉS avec de la bande isolante.
- Le dissipateur de chaleur devient très chaud après usage. Faire attention de ne pas le toucher en retirant cet appareil.

PRECAUTIONS on power supply and speaker connections:

- **DO NOT connect the speaker leads of the power cord to the car battery; otherwise, the unit will be seriously damaged.**
- BEFORE connecting the speaker leads of the power cord to the speakers, check the speaker wiring in your car.

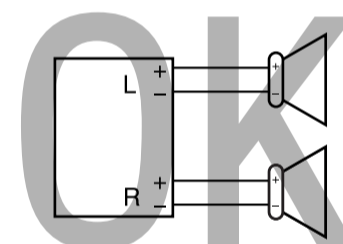
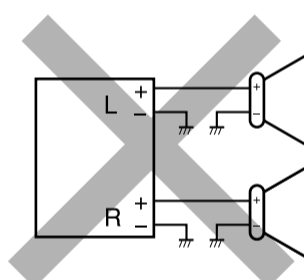
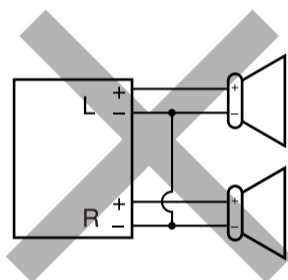

PRECAUTIONS sur l'alimentation et la connexion des enceintes:

- **NE CONNECTEZ PAS les fils d'enceintes du cordon d'alimentation à la batterie; sinon, l'appareil serait sérieusement endommagé.**
- AVANT de connecter les fils d'enceintes du cordon d'alimentation aux enceintes, vérifiez le câblage des enceintes de votre voiture.

Parts list for installation and connection

The following parts are provided for this unit. After checking them, please set them correctly.

Liste des pièces pour l'installation et raccordement

Les pièces suivantes sont fournies avec cet appareil. Après vérification, veuillez les placer correctement.

(A) / (B)
Hard case/Control panel
Etui de transport/Panneau de commande

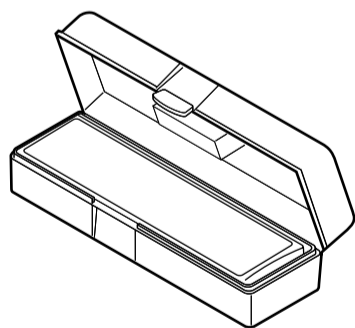

(C)
Sleeve
Manchon

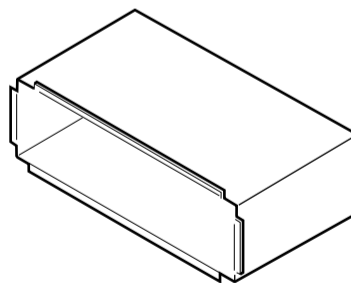

(D)
Trim plate
Plaque d'assemblage

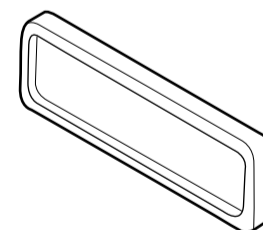

(E)
Power cord
Cordon d'alimentation

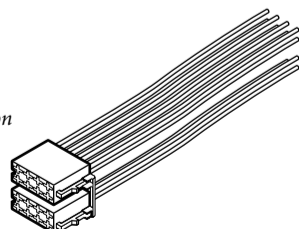

(F)
Washer (ø5)
Rondelle (ø5)



(G)
Lock nut (M5)
Ecroû d'arrêt (M5)



(H)
Mounting bolt (M5 × 20 mm)
Boulon de montage (M5 × 20 mm)

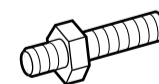

(I)
Rubber cushion
Amortisseur en caoutchouc



(J)
Handles
Poignées

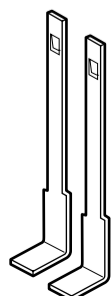

(K)
Remote controller
Télécommande



RM-RK50

(L)
Battery
Pile



CR2025

INSTALLATION (IN-DASH MOUNTING)

The following illustration shows a typical installation. If you have any questions or require information regarding installation kits, consult your JVC IN-CAR ENTERTAINMENT dealer or a company supplying kits.

- If you are not sure how to install this unit correctly, have it installed by a qualified technician.

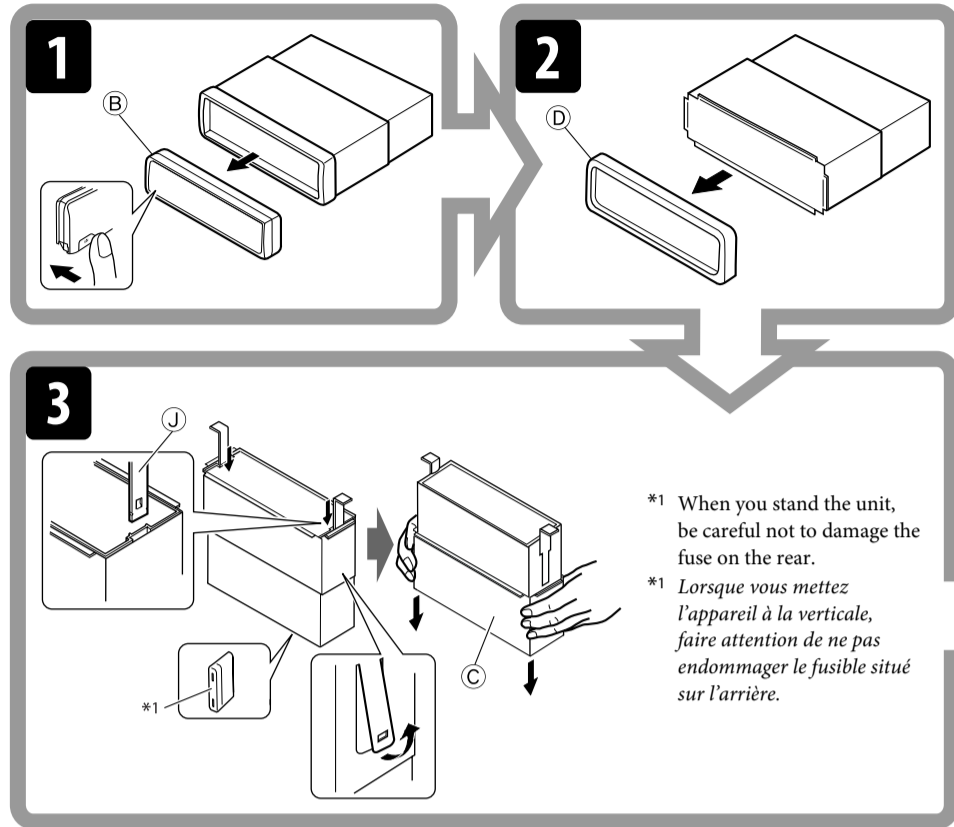

INSTALLATION (MONTAGE DANS LE TABLEAU DE BORD)

L'illustration suivante est un exemple d'installation typique. Si vous avez des questions ou avez besoin d'information sur des kits d'installation, consulter votre revendeur d'autoradios JVC ou une compagnie d'approvisionnement.

- Si l'on n'est pas sûr de pouvoir installer correctement cet appareil, le faire installer par un technicien qualifié.

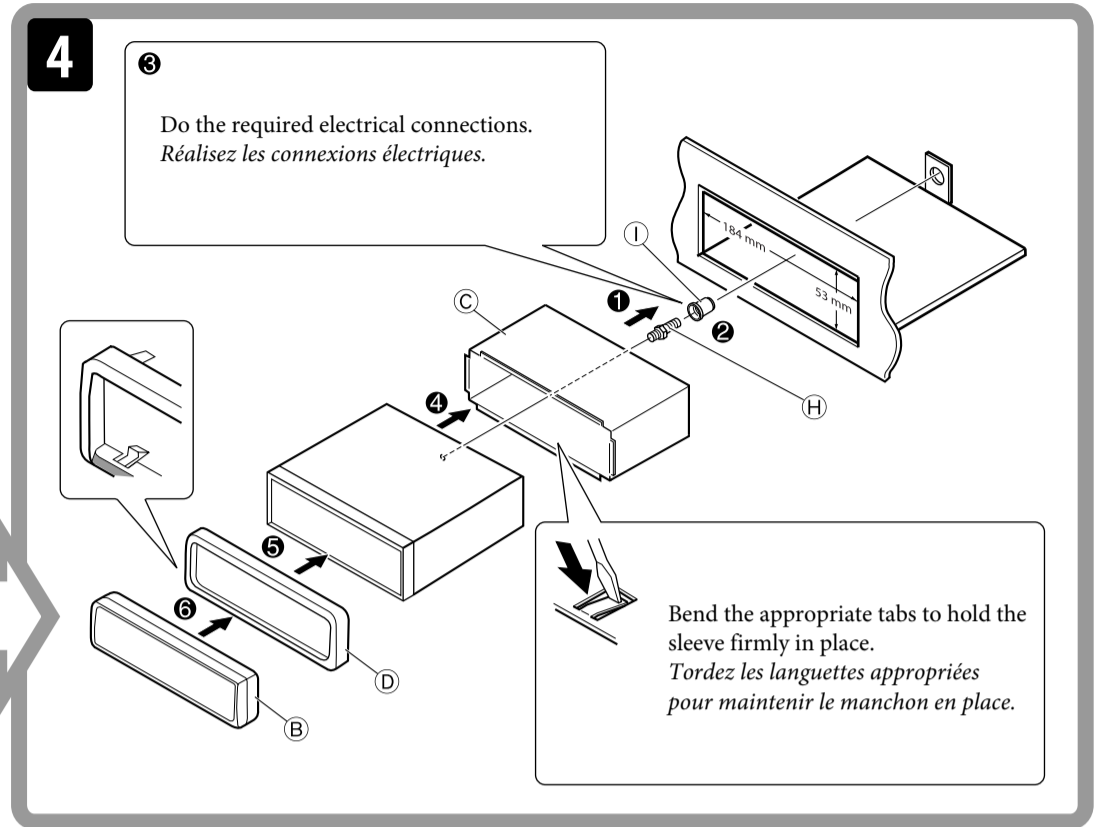

Removing the unit

Before removing the unit, release the rear section.

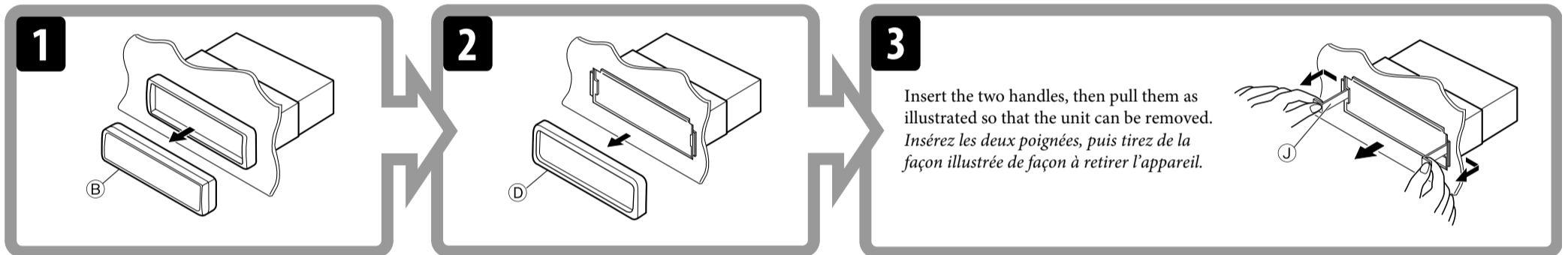

Retrait de l'appareil

Avant de retirer l'appareil, libérer la section arrière.

When using the optional stay / Lors de l'utilisation du hauban en option

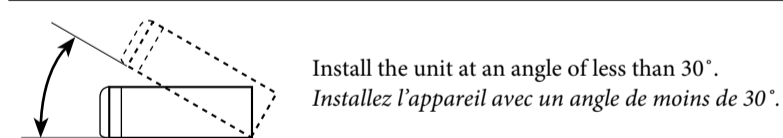
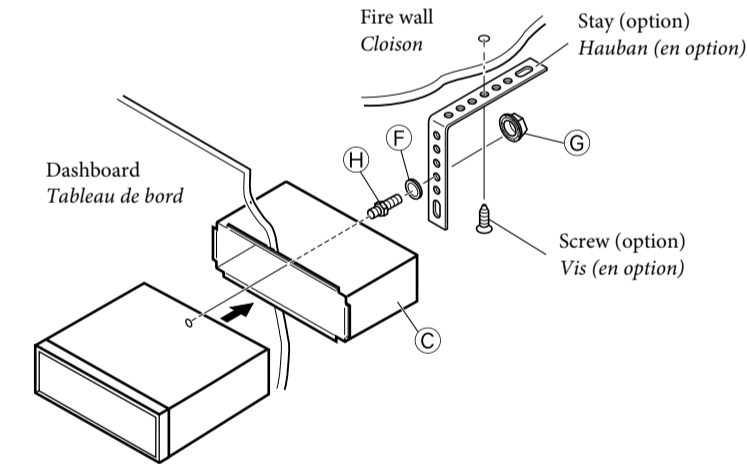

When installing the unit without using the sleeve / Lors de l'installation de l'appareil sans utiliser de manchon

In a Toyota for example, first remove the car radio and install the unit in its place. Par exemple dans une Toyota, retirer d'abord l'autoradio et installer l'appareil à la place.

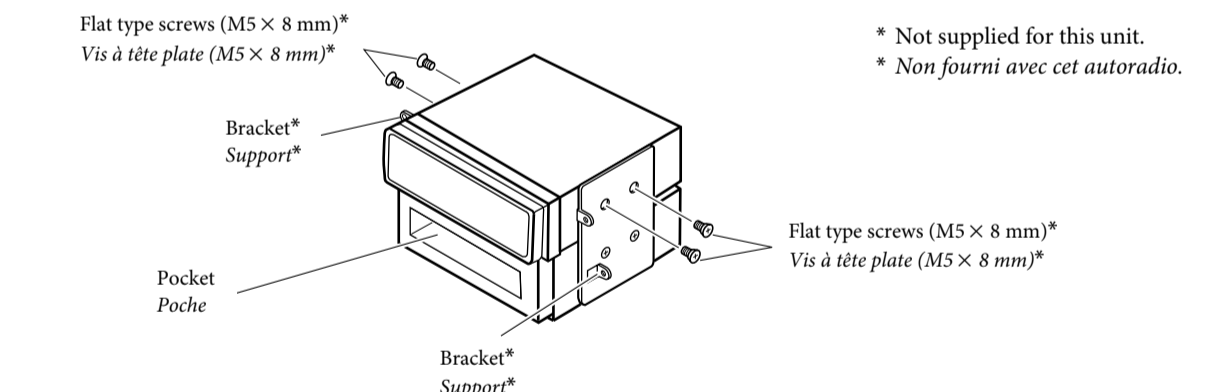

Note : When installing the unit on the mounting bracket, make sure to use the 8 mm-long screws. If longer screws are used, they could damage the unit.
Remarque : Lors de l'installation de l'appareil sur le support de montage, s'assurer d'utiliser des vis d'une longueur de 8 mm. Si des vis plus longues sont utilisées, elles peuvent endommager l'appareil.

TROUBLESHOOTING

- **The fuse blows.**
 - * Are the red and black leads connected correctly?
- **Power cannot be turned on.**
 - * Is the yellow lead connected?
- **No sound from the speakers.**
 - * Is the speaker output lead short-circuited?
- **Sound is distorted.**
 - * Is the speaker output lead grounded?
 - * Are the "-" terminals of L and R speakers grounded in common?
- **Noise interfere with sounds.**
 - * Is the rear ground terminal connected to the car's chassis using shorter and thicker cords?
- **This unit becomes hot.**
 - * Is the speaker output lead grounded?
 - * Are the "-" terminals of L and R speakers grounded in common?
- **This unit does not work at all.**
 - * Have you reset your unit?

EN CAS DE DIFFICULTES

- **Le fusible saute.**
 - * Les fils rouge et noir sont-ils raccordés correctement?
- **L'appareil ne peut pas être mise sous tension.**
 - * Le fil jaune est-elle raccordée?
- **Pas de son des enceintes.**
 - * Le fil de sortie d'enceinte est-il court-circuité?
- **Le son est déformé.**
 - * Le fil de sortie d'enceinte est-il à la masse?
 - * Les bornes "-" des enceintes gauche et droit sont-elles mises ensemble à la masse?
- **Interférence avec les sons.**
 - * La prise arrière de mise à la terre est-elle connectée au châssis de la voiture avec un cordon court et épais?
- **L'appareil devient chaud.**
 - * Le fil de sortie d'enceinte est-il à la masse?
 - * Les bornes "-" des enceintes gauche et droit sont-elles mises ensemble à la masse?
- **Cet appareil ne fonctionne pas du tout.**
 - * Avez-vous réinitialisé votre appareil?

ELECTRICAL CONNECTIONS

RACCORDEMENTS ELECTRIQUES

A Typical Connections / Raccordements typiques

Before connecting: Check the wiring in the vehicle carefully. Incorrect connection may cause serious damage to this unit.
The leads of the power cord and those of the connector from the car body may be different in color.

- 1 Connect the colored leads of the power cord in the order specified in the illustration below.
- 2 Connect the aerial cord.
- 3 Finally connect the wiring harness to the unit.

Note: If your vehicle does not have any accessory terminal, move the fuse from the fuse position 1 (initial position) to fuse position 2, and connect the red lead (A7) to the positive (+) battery terminal.
• The yellow lead (A4) is not used in this case.

Avant de commencer la connexion: Vérifiez attentivement le câblage du véhicule. Une connexion incorrecte peut endommager sérieusement l'appareil.
Le fil du cordon d'alimentation et ceux des connecteurs du châssis de la voiture peuvent être différents en couleur.

- 1 Connectez les fils colorés du cordon d'alimentation dans l'ordre spécifié sur l'illustration ci-dessous.
- 2 Connectez le cordon d'antenne.
- 3 Finalement, connectez le faisceau de fils à l'appareil.

Remarque: Si votre véhicule ne possède pas de borne accessoire, déplacez le fusible de la position de fusible 1 (position originale) à la position de fusible 2 et connectez le fil rouge (A7) à la borne positive (+) de la batterie.
• Le fil jaune (A4) n'est pas utilisé dans ce cas.

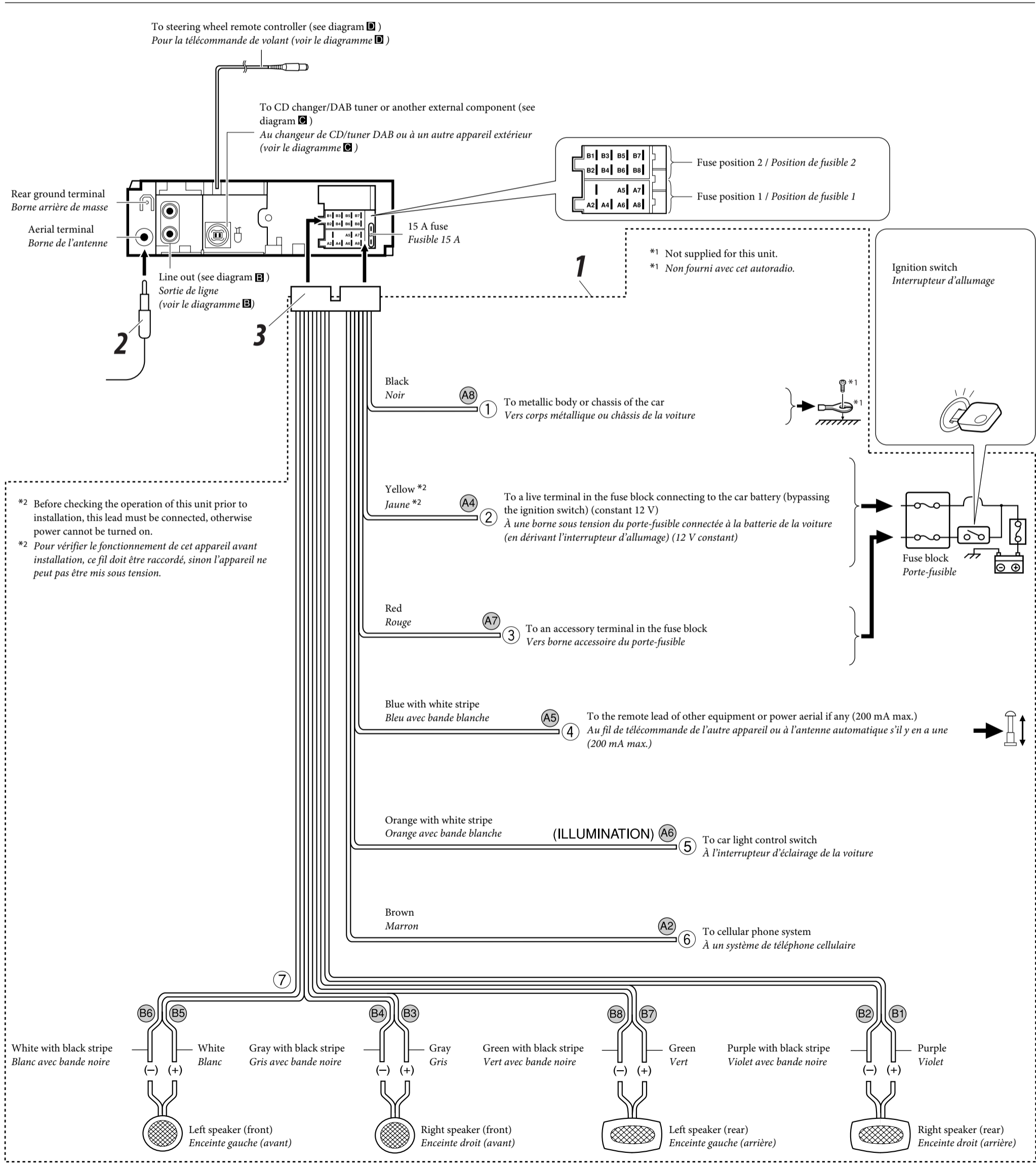

B Connecting the external amplifier / Connexion d'un amplificateur extérieur

You can connect an amplifier to upgrade your car stereo system.

- Connect the remote lead (blue with white stripe) to the remote lead of the other equipment so that it can be controlled through this unit.
- **Disconnect the speakers from this unit, connect them to the amplifier. Leave the speaker leads of this unit unused.**

Vous pouvez connecter un amplificateur pour améliorer votre système autoradio.

- Connectez le fil de commande à distance (bleu avec bande blanche) au fil de commande à distance de l'autre appareil de façon qu'il puisse être commandé via cet appareil.
- **Déconnectez les enceintes de cet appareil et connectez-les à l'amplificateur. Laissez les fils d'enceintes de cet appareil inutilisés.**

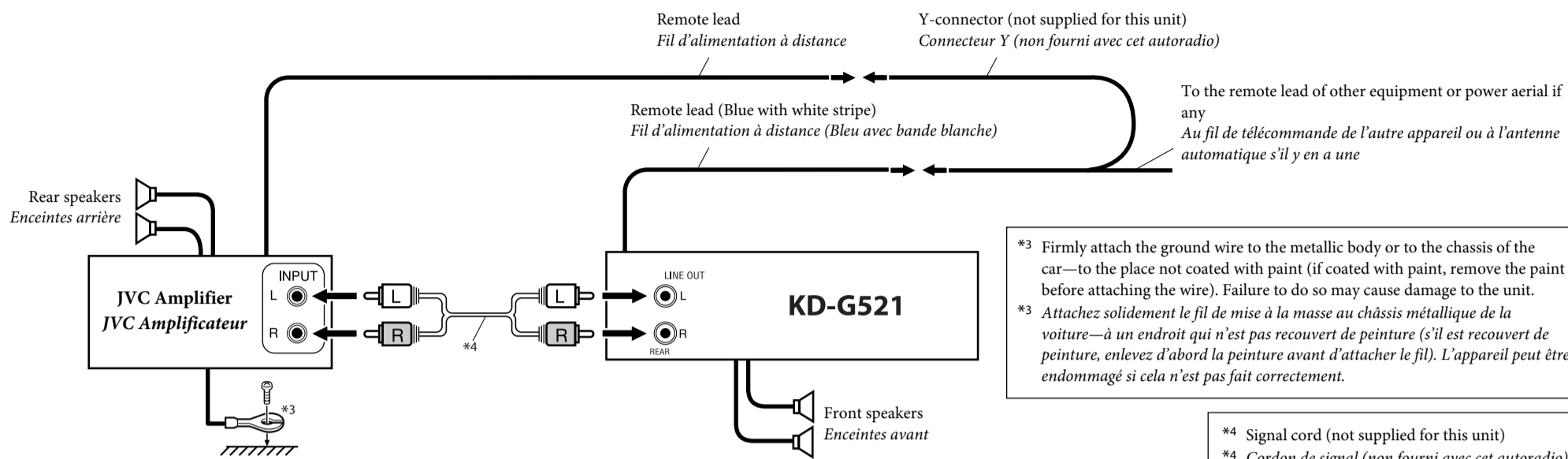

C Connecting the external components / Connexion des appareils extérieurs

- Set "CHANGER" for the external input setting (see page 16 of the INSTRUCTIONS.) / Choisissez "CHANGER" pour le réglage de l'entrée extérieure (référez-vous à la page 16 du MANUEL D'INSTRUCTIONS).

CD changer, DAB tuner, Apple iPod®, or JVC D. player / Changeur de CD, tuner DAB, iPod, Apple® ou lecteur D. JVC

You can connect these components in series as illustrated below. The iPod®5 or D. player can be connected using an interface adapter (not supplied)—KS-PD100 (for iPod) or KS-PD500 (for D. player).

Vous pouvez connecter ces appareils en série comme montrée sur l'illustration. Le iPod®5 ou le lecteur D. peut être connecté en utilisant un adaptateur d'interface (non fourni)—KS-PD100 (pour iPod) ou KS-PD500 (pour le lecteur D.).

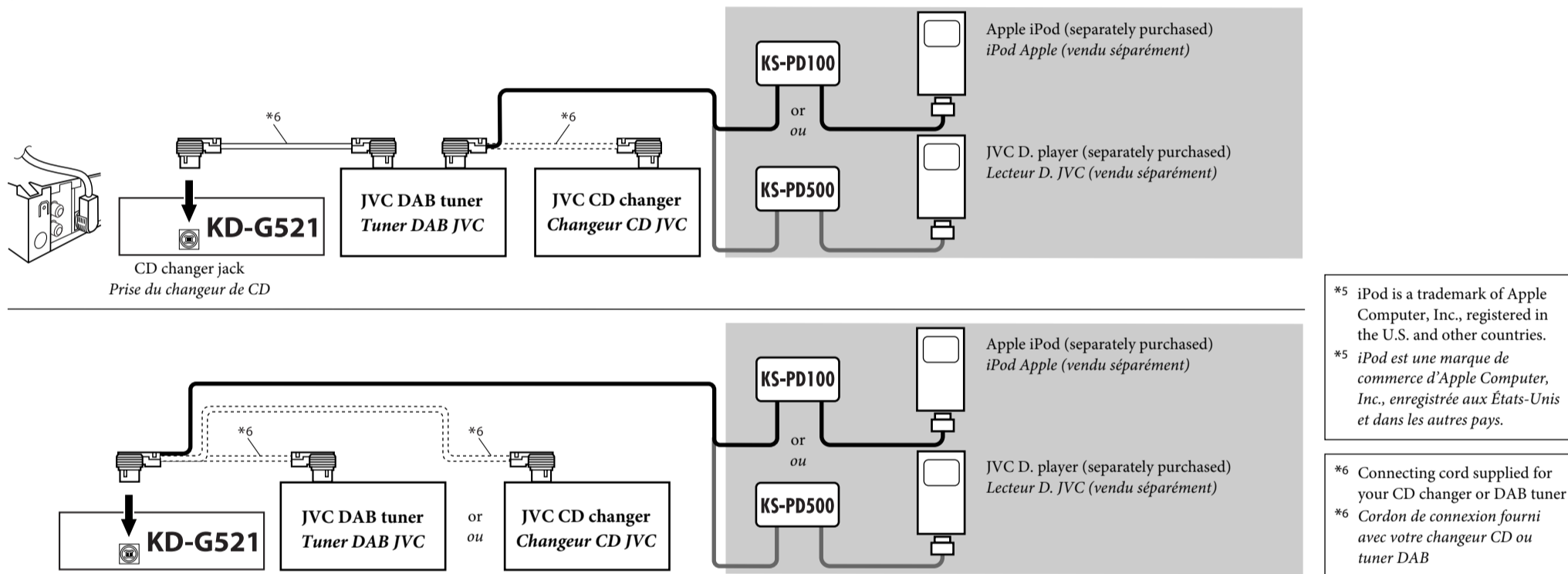

CAUTION / PRECAUTION:

- Before connecting the external components, make sure that the unit is turned off.
- Avant de connecter les appareils extérieurs, assurez-vous que l'appareil est hors tension.

- Set "EXT IN" for the external input setting (see page 16 of the INSTRUCTIONS.) / Choisissez "EXT IN" pour le réglage de l'entrée extérieure (référez-vous à la page 16 du MANUEL D'INSTRUCTIONS).

External Component / Appareil extérieur

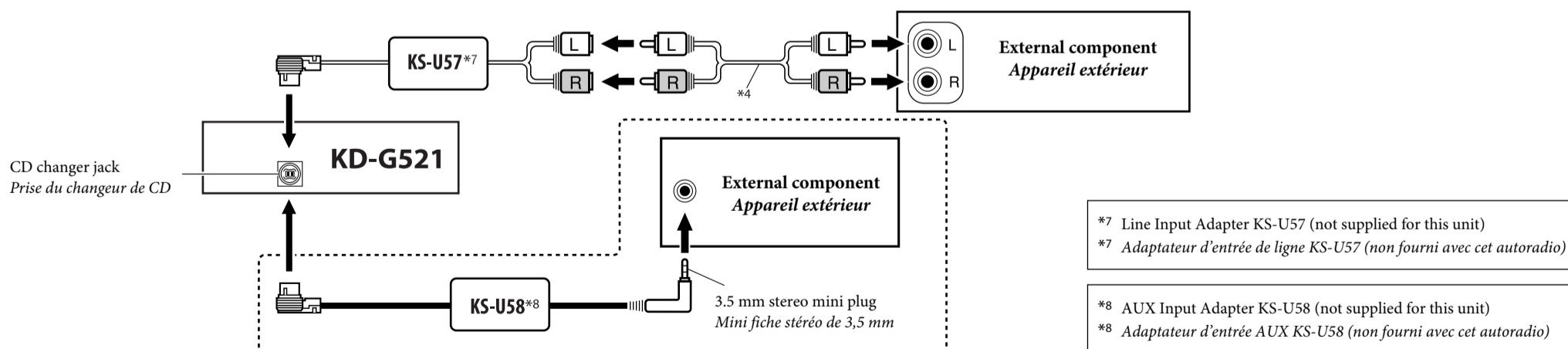

D Connecting to the steering wheel remote controller / Connexion de la télécommande de volant

If your car is equipped with the steering wheel remote controller, you can operate this unit using the controller. To do it, a JVC's OE remote adapter (not supplied) which matches with your car is required. Consult your JVC IN-CAR ENTERTAINMENT dealer for details.

Si votre voiture est munie d'une télécommande de volant, vous pouvez commander cet autoradio en utilisant la télécommande. Pour le faire, un adaptateur pour télécommande au volant JVC (non fourni) correspondant à votre voiture est nécessaire. Consultez votre revendeur d'autoradio JVC pour les détails.

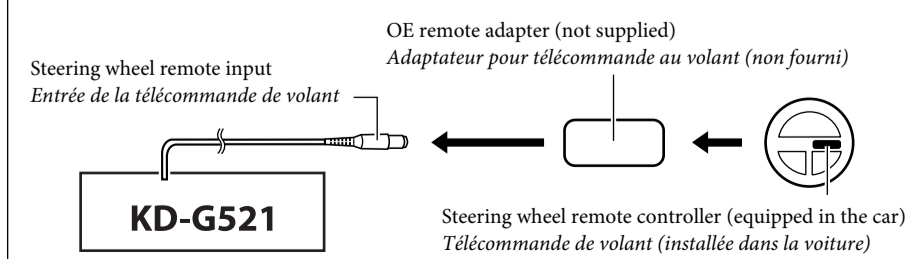

JVC



CD RECEIVER

KD-G524

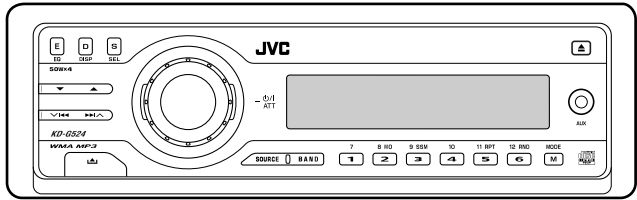
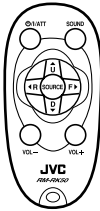
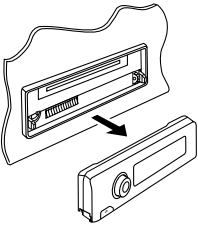

WMA MP3



For canceling the display demonstration, see page 6.

For installation and connections, refer to the separate manual.



INSTRUCTIONS

GET0338-001A
[U]

Thank you for purchasing a JVC product.

Please read all instructions carefully before operation, to ensure your complete understanding and to obtain the best possible performance from the unit.

IMPORTANT FOR LASER PRODUCTS

1. CLASS 1 LASER PRODUCT
2. **CAUTION:** Do not open the top cover. There are no user serviceable parts inside the unit; leave all servicing to qualified service personnel.
3. **CAUTION:** Visible and invisible laser radiation when open and interlock failed or defeated. Avoid direct exposure to beam.
4. REPRODUCTION OF LABEL: CAUTION LABEL, PLACED OUTSIDE THE UNIT.

CAUTION : Visible and invisible laser radiation when open and interlock failed or defeated. AVOID DIRECT EXPOSURE TO BEAM. (e)	ADVARSEL : Synlig og usynlig laserstråling når maskinen er åben eller interlocken fejler. Undgå direkte eksponering til strålingen. (d)	VARNING : Synlig och osynlig laserstråling när den öppnas och spärran är urkopplad. Beträkta strålen. (s)	VARO : Avtättsa ja suojalukitus ohitettuna tai välillänsä olet alttina näkyvälle ja näkymättömälle lasersäteilylle. Vältä säteen kohdistumista suoraan itseesi. (f)
---	--	--	--

How to reset your unit

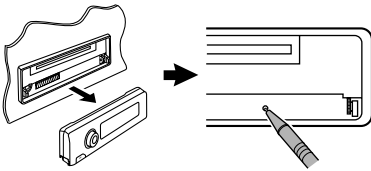

Your preset adjustments will also be erased.

How to forcibly eject a disc



“PLEASE” and “EJECT” appear alternately on the display.

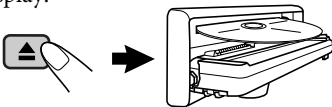

- If this does not work, reset your unit.
- Be careful not to drop the disc when it ejects.

How to detach/attach the control panel

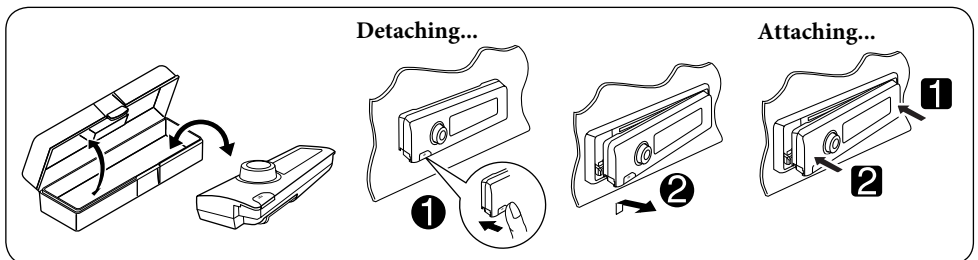

How to use the M MODE button

If you press M MODE, the unit goes into functions mode, then the number buttons and ▲/▼ buttons work as different function buttons.



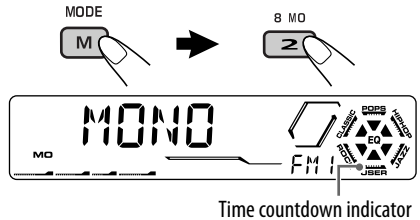

Ex.: When number button 2 works as MO (monaural) button.

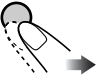

To use these buttons for their original functions again after pressing M MODE, wait for 5 seconds without pressing any of these buttons until the functions mode is cleared or press M MODE again.

How to read this manual

- Button operations are mainly explained with the illustrations in the table below.
- Some related tips and notes are explained in “More about this unit” (see pages 16 and 17).

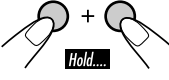
	Press briefly.
	Press repeatedly.
 	Press either one.
	Press and hold until your desired response begins.
	Press and hold both buttons at the same time.

The following marks are used to indicate...

 : Built-in CD player operations.

 : External CD changer operations.

 : Indicator displayed for the corresponding operation.

Warning:

If you need to operate the unit while driving, be sure to look ahead carefully or you may be involved in a traffic accident.

Caution on volume setting:

Discs produce very little noise compared with other sources. Lower the volume before playing a disc to avoid damaging the speakers by the sudden increase of the output level.

CONTENTS

Control panel	4
Remote controller — RM-RK50	5
Getting started.....	6
Basic operations.....	6
Radio operations	7
Disc operations	8
Playing a disc in the unit	8
Playing discs in the CD changer	8
Sound adjustments.....	11
General settings — PSM	12
Title assignment	14
External component operations	15
More about this unit	16
Maintenance	18
Troubleshooting	19
Specifications	21

For safety...

- Do not raise the volume level too much, as this will block outside sounds, making driving dangerous.
- Stop the car before performing any complicated operations.

Temperature inside the car...

If you have parked the car for a long time in hot or cold weather, wait until the temperature in the car becomes normal before operating the unit.

Parts identification

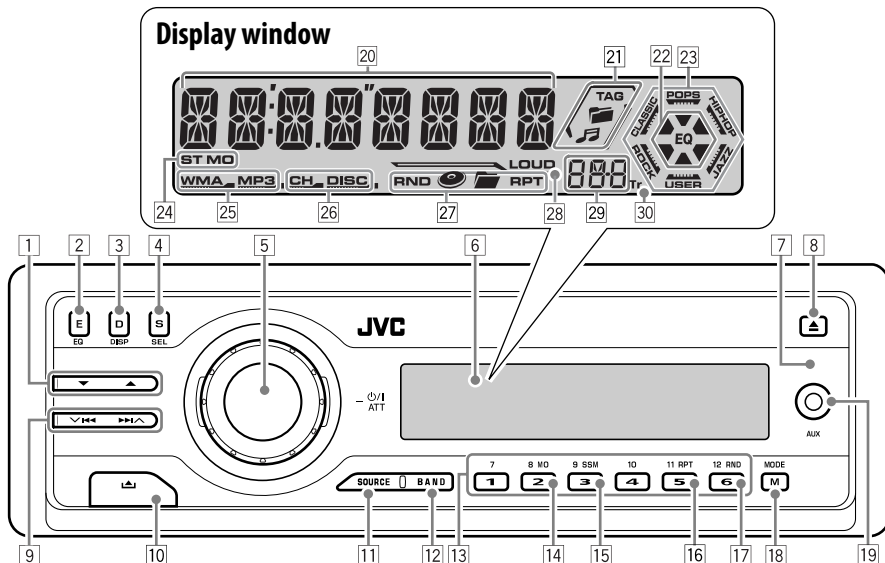

- 1 ▲ (up) / ▼ (down) buttons
- 2 E EQ (equalizer) button
- 3 D DISP (display) button
- 4 S SEL (select) button
- 5
 - Control dial
 - Φ /I ATT (standby/on attenuator) button
- 6 Display window
- 7 Remote sensor
 - *DO NOT expose the remote sensor to strong light (direct sunlight or artificial lighting).*
- 8 ▲ (eject) button
- 9 ▼ |◀◀/▶▶| ▲ buttons
- 10 ▲ (control panel release) button
- 11 SOURCE button
- 12 BAND button
- 13 Number buttons
- 14 MO (monaural) button
- 15 SSM (Strong-station Sequential Memory) button
- 16 RPT (repeat) button
- 17 RND (random) button
- 18 M MODE button
- 19 AUX (auxiliary) input jack

Display window

- 20 Main display
- 21 Disc information indicators—TAG (ID3 Tag), (folder), (track/file)
- 22 EQ (equalizer) indicator
- 23 Sound mode (C-EQ: custom equalizer) indicators—ROCK, CLASSIC, POPS, HIP HOP, JAZZ, USER
 - also works as the time countdown indicator and level meter during play (see page 13).
- 24 Tuner reception indicators—ST (stereo), MO (monaural)
- 25 Disc type indicators—WMA, MP3
- 26 Playback source indicators—CH: *Lights up only when CD-CH is selected as the playback source.* DISC: *Lights up for the built-in CD player.*
- 27 Playback mode / item indicators—RND (random), (disc), (folder), RPT (repeat)
- 28 LOUD (loudness) indicator
- 29 Source display / Volume level indicator
- 30 Tr (track) indicator

Installing the lithium coin battery (CR2025)

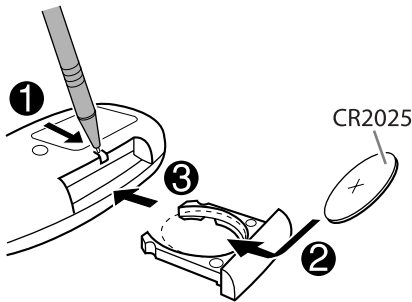

Aim the remote controller directly at the remote sensor on the unit. Make sure there is no obstacle in between.

Warning:

- Do not install any battery other than CR2025 or its equivalent; otherwise, it may explode.
- Store the battery in a place where children cannot reach to avoid risk of accident.
- To prevent the battery from over-heating, cracking, or starting a fire:
 - Do not recharge, short, disassemble, heat the battery, or dispose of it in a fire.
 - Do not leave the battery with other metallic materials.
 - Do not poke the battery with tweezers or similar tools.
 - Wrap the battery with tape and insulate when throwing away or saving it.

Caution:

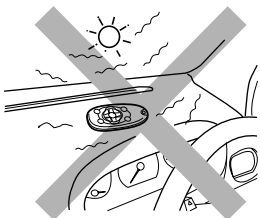

Main elements and features

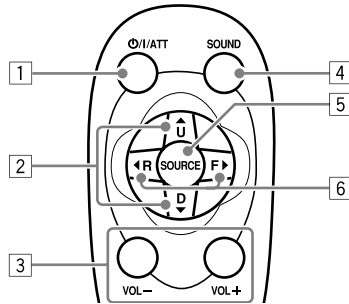

- 1 **⏻/I/ATT** (standby/on/attenuator) button
 - Turns the power on if pressed briefly or attenuates the sound when power is on.
 - Turns the power off if pressed and held.
- 2 **▲ U (up) / D (down) ▼** buttons
 - Changes the FM/AM bands with ▲ U only.
 - Changes the preset stations with D ▼ only.
 - Changes the folder of the MP3/WMA discs.
 - While playing an MP3 disc on an MP3-compatible CD changer:
 - Changes the disc if pressed briefly.
 - Changes the folder if pressed and held.
- 3 **VOL - / VOL +** buttons
 - Adjusts the volume level.
- 4 **SOUND** button
 - Selects the sound mode (C-EQ: custom equalizer).
- 5 **SOURCE** button
 - Selects the source.
- 6 **◀ R (reverse) / F (forward) ▶** buttons
 - Searches for stations if pressed briefly.
 - Fast-forwards or reverses the track if pressed and held.
 - Changes the tracks of the disc if pressed briefly.

Getting started

Basic operations

- 1 Turn on the power.

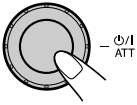

- Select “CD-CH” when using an Apple iPod® or a JVC D. player (see page 15).

iPod is a trademark of Apple Computer, Inc., registered in the U.S. and other countries.

* You cannot select these sources if they are not ready.

- 3 For FM/AM tuner



- 4 Adjust the volume.

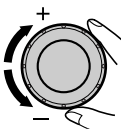

Volume level appears.



Volume level indicator

- 5 Adjust the sound as you want. (See pages 11 and 12.)

To drop the volume in a moment (ATT)

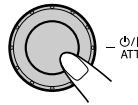

To restore the sound, press it again.

To turn off the power

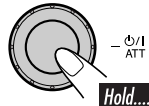

Basic settings

- See also “General settings — PSM” on pages 12 and 13.

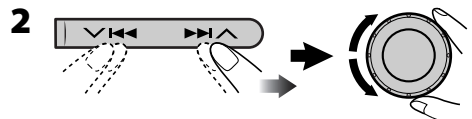

- 1 **Canceling the display demonstrations**
Select “DEMO,” then “DEMO OFF.”

- 2 **Setting the clock**
Select “CLOCK H” (hour), then adjust the hour.
Select “CLOCK M” (minute), then adjust the minute.

- 3 **Finish the procedure.**



To check the current clock time when the power is turned off



Radio operations

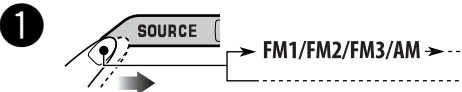

Lights up when receiving an FM stereo broadcast with sufficient signal strength.

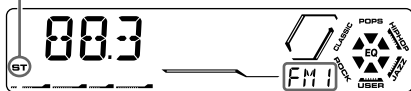

Selected band appears.

3 **Start searching for a station.**

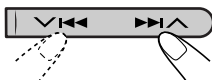

When a station is received, searching stops.

To stop searching, press the same button again.

To tune in to a station manually

In step 3 above...

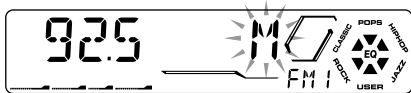
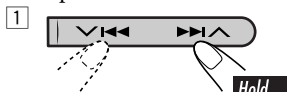

2 **Select the desired station frequencies.**

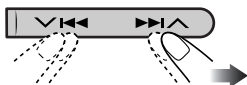

When an FM stereo broadcast is hard to receive

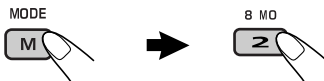

Lights up when monaural mode is activated.

Reception improves, but stereo effect will be lost.

To restore the stereo effect, repeat the same procedure. "MONO OFF" appears and the MO indicator goes off.

Storing stations in memory

You can preset six stations for each band.

FM station automatic presetting—SSM (Strong-station Sequential Memory)

1 **Select the FM band (FM1 – FM3) you want to store into.**

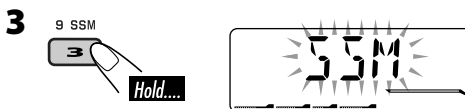

"SSM" flashes, then disappears when automatic presetting is over.

Local FM stations with the strongest signals are searched and stored automatically in the FM band.

Manual presetting

Ex.: Storing FM station of 92.5 MHz into preset number 4 of the FM1 band.

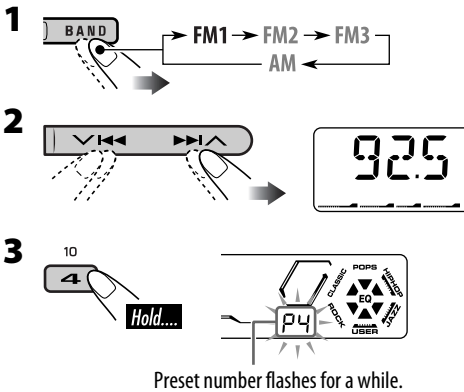

Listening to a preset station

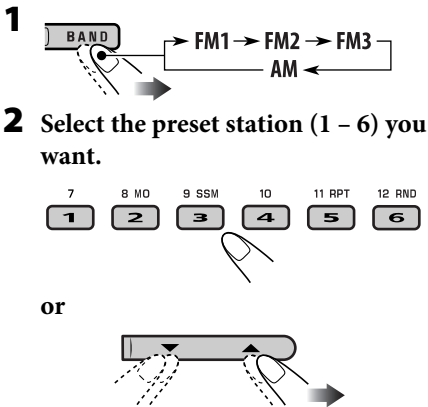

To check the other information while listening to an FM or AM station



Clock → **Station name*** → **Frequency** →
(back to the beginning)

* If no title is assigned to a station, “NO NAME” appears. To assign a title to a station, see page 14.

Disc operations

Playing a disc in the unit

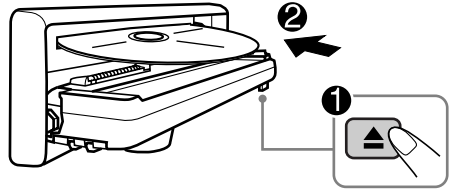

All tracks will be played repeatedly until you change the source or eject the disc.

To stop play and eject the disc



Playing discs in the CD changer

All discs in the magazine will be played repeatedly until you change the source.

- Ejecting the magazine will also stop playing.

1

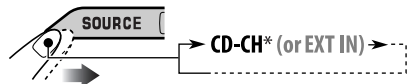

* If you have changed “EXT IN” setting to “EXT IN” (see page 13), you cannot select the CD changer.

See also page 15 when using an iPod or JVC D. player.

2

Select a disc.

For disc number from 01 – 06:

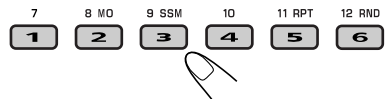

For disc number from 07 – 12:

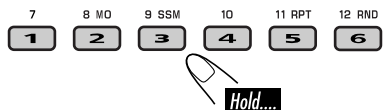

About MP3 and WMA discs

MP3 and WMA “tracks” (words “file” and “track” are used interchangeably) are recorded in “folders.”

About the CD changer

It is recommended to use a JVC MP3-compatible CD changer with your unit.

- You can also connect other CH-X series CD changers (except CH-X99 and CH-X100). These units are not compatible with MP3 discs.
- You cannot play any WMA disc in the CD changer.
- You cannot use the KD-MK series CD changers with this unit.
- Disc text information recorded in the CD Text can be displayed when a JVC CD Text compatible CD changer is connected.

To fast-forward or reverse the track

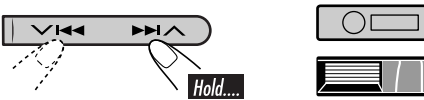

To go to the next or previous tracks

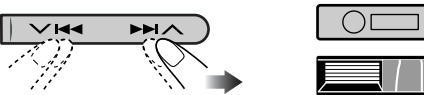

To go to the next or previous folders (only for MP3 or WMA discs)

For MP3 discs:  

For WMA discs: 

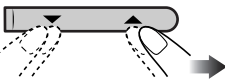

To locate a particular track (for CD) or folder (for MP3 or WMA discs) directly



To select a number from 01 – 06:

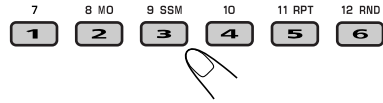

To select a number from 07 – 12:

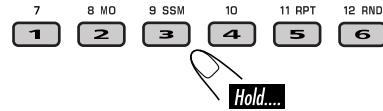

- To use folder search on MP3/WMA discs, it is required that folders are assigned with 2-digit numbers at the beginning of their folder names—01, 02, 03, and so on.

- To select a particular track in a folder (for MP3 or WMA disc):

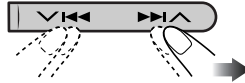

Other main functions

■ Skipping a track quickly during play



**Only possible on JVC
MP3-compatible CD changer**

- For MP3 or WMA disc, you can skip a track within the same folder.

Ex.: To select track 32 while playing track 6

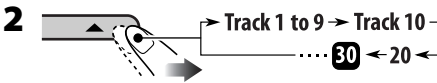
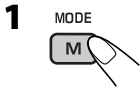

Each time you press the button, you can skip 10 tracks.

- After the last track, the first track will be selected and vice versa.

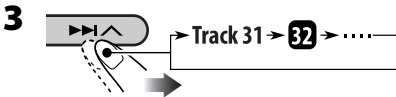

■ Prohibiting disc ejection



You can lock a disc in the loading slot.

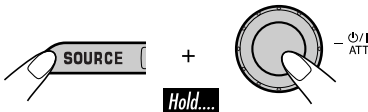

To cancel the prohibition, repeat the same procedure.

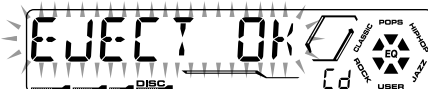

Changing the display information



■ While playing an audio CD or a CD Text



■ While playing an MP3 or WMA*2 disc

- When “TAG DISP” is set to “TAG ON” (see page 13)



- When “TAG DISP” is set to “TAG OFF”

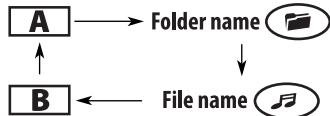

- A** : Clock with the current track number
- B** : Elapsed playing time with the current track number

*1 If the current disc is an audio CD, “NO NAME” appears.

*2 Only for the built-in CD player.

*3 If an MP3/WMA file does not have ID3 tags, folder name and file name appear. In this case, the TAG indicator will not light up.

Selecting the playback modes

You can use only one of the following playback modes at a time.

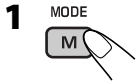

2 Select your desired playback mode.

Repeat play



Mode	Plays repeatedly
TRK RPT	: The current track.
FLDR RPT *1	: All tracks of the current folder.
DISC RPT *2	: All tracks of the current disc.
RPT OFF	: Cancels.

Random play

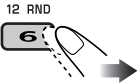

Mode	Plays at random
FLDR RND *1	: All tracks of the current folder, then tracks of the next folder and so on.
DISC RND	: All tracks of the current disc.
MAG RND *2	: All tracks of the inserted discs.
RND OFF	: Cancels.

*1 Only while playing an MP3 or WMA disc.

*2 Only while playing discs in the CD changer.

Sound adjustments

You can select a preset sound mode suitable to the music genre (C-EQ: custom equalizer).



Preset values	BAS (bass)	TRE (treble)	LOUD (loudness)
USER (Flat sound)	00	00	OFF
ROCK (Rock or disco music)	+03	+01	ON
CLASSIC (Classical music)	+01	-02	OFF
POPS (Light music)	+04	+01	OFF
HIP HOP (Funk or rap music)	+02	00	ON
JAZZ (Jazz music)	+02	+03	OFF

Adjusting the sound

You can adjust the sound characteristics to your preference.

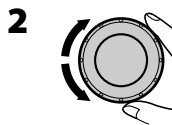
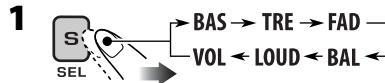

Indication pattern changes as you adjust the level.



Ex.: When "TRE" is selected

To be continued...

Indication [Range]

BAS*¹ (bass)

Adjust the bass. [-06 to +06]

TRE*¹ (treble)

Adjust the treble. [-06 to +06]

FAD*² (fader)

Adjust the front and rear speaker balance.
[R06 to F06]

BAL (balance)

Adjust the left and right speaker balance.
[L06 to R06]

LOUD*¹ (loudness)

Boost low and high frequencies to produce a well-balanced sound at low volume level.
[LOUD ON or LOUD OFF]

VOL (volume)

Adjust the volume. [00 to 30 or 50*³]

*¹ When you adjust the bass, treble, or loudness, the adjustment you have made is stored for the currently selected sound mode (C-EQ) including "USER."

*² If you are using a two-speaker system, set the fader level to "00."

*³ Depending on the amplifier gain control setting. (See page 13 for details.)

General settings — PSM

You can change PSM (Preferred Setting Mode) items listed in the table that follows.

1



2 Select a PSM item.

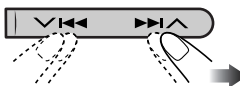

Ex.: When you select "DIMMER"

3 Adjust the PSM item selected.

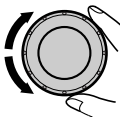

4 Repeat steps **2** and **3** to adjust the other PSM items if necessary.

5 Finish the procedure.



Indications	Selectable settings, [reference page]
DEMO Display demonstration	DEMO ON : [Initial]; Display demonstration will be activated automatically if no operation is done for about 20 seconds, [6]. DEMO OFF : Cancels.
CLOCK H Hour adjustment	1 – 12, [6] [Initial: 1 (1:00)]
CLOCK M Minute adjustment	00 – 59, [6] [Initial: 00 (1:00)]
LEVEL Audio level meter	ON : [Initial]; Activates the audio level indicator. OFF : Cancels; sound mode indicator is shown.
DIMMER Dimmer	AUTO : [Initial]; Dims the display when you turn on the headlights. ON : Activates dimmer. OFF : Cancels.
SCROLL *1 Scroll	ONCE : [Initial]; Scrolls the disc information once. AUTO : Repeats scrolling (5-second intervals in between). OFF : Cancels. • Pressing D DISP for more than one second can scroll the display regardless of the setting.
EXT IN *2 External input	CHANGER : [Initial]; To use a JVC CD changer, [8], an Apple iPod or a JVC D. player, [15]. EXT IN : To use another external component, [15].
AUX ADJ Auxiliary input level adjustment	A.ADJ 00 – A.ADJ 05 : Adjust the auxiliary input level to avoid the sudden increase of the output level when changing the source from external component connected to the AUX input jack on the control panel. [Initial: A.ADJ 00]
TAG DISP Tag display	TAG ON : [Initial]; Shows the ID3 tag while playing MP3/WMA tracks, [10]. TAG OFF : Cancels.
AMP GAIN Amplifier gain control	You can change the maximum volume level of this unit. LOW PWR : VOL 00 – VOL 30 (Select this if the maximum power of the speaker is less than 50 W to prevent them from damaging the speaker.) HIGH PWR : [Initial]; VOL 00 – VOL 50

*1 Some characters or symbols will not be shown correctly (or will be blanked) on the display.

*2 Displayed only when one of the following sources is selected—FM, AM, CD, or AUX IN.

Title assignment

You can assign titles to station frequencies and CDs (both in the unit and the CD changer).

Sources	Maximum number of characters
FM/AM tuner	Up to 8 characters (up to 30 station frequencies including both FM and AM)
CDs/CD-CH	Up to 32 characters (up to 30 discs)

* You cannot assign a title to a CD Text or an MP3/WMA disc.

1 Select the sources.

- For FM/AM tuner: Tune into a station.
- For CDs in this unit: Insert a CD.
- For CDs in the CD changer: Select “CD-CH,” then select a disc number.

2 Enter the title assignment mode.

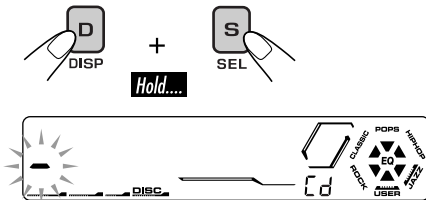

Ex.: When you select “CD” as the source

3 Assign a title.

1 Select a character.

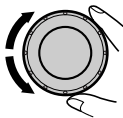

A	B	C	D	E	F	G	H	I	J	K	L	M	N
O	P	Q	R	S	T	U	V	W	X	Y	Z	0	1
2	3	4	5	6	7	8	9	-	/	<	>	space	

2 Move to the next (or previous) character position.

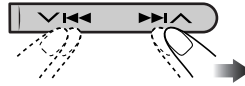

3 Repeat steps 1 and 2 until you finish entering the title.

4 Finish the procedure.



To erase the entire title

In step 2 on the left...



External component operations

You can connect an external component to...

- CD changer jack on the rear using:
 - Line Input Adapter—KS-U57 (not supplied) or AUX Input Adapter—KS-U58 (not supplied) for any other components (except iPod and D. player).
 - Interface adapter for iPod®—KS-PD100 (not supplied) for controlling iPod.
 - D. player interface adapter—KS-PD500 (not supplied) for controlling D. player.
- AUX (auxiliary) input jack on the control panel.

For connection, see Installation/Connection Manual (separate volume).

Connecting an external component to the AUX input jack

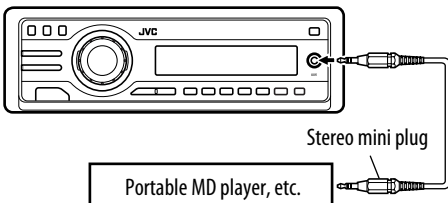

- 1 For selecting the external component connected to...
 - AUX input jack

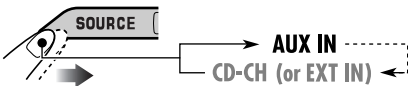

- CD changer jack on the rear using KS-U57 or KS-U58

If “EXT IN” does not appear, see page 13 and select the external input (“EXT IN”).

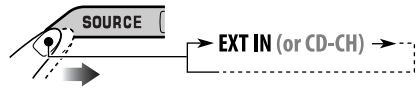

- CD changer jack on the rear using interface adapter for iPod—KS-PD100 or for D. player—KS-PD500

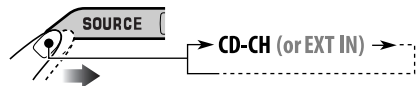

- 2 Turn on the connected component and start playing the source.

- 3 Adjust the volume.

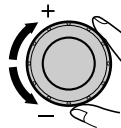

- 4 Adjust the sound as you want. (See pages 11 and 12.)

To check the other information while listening to an external component



Clock ↔ AUX IN, EXT IN, or CD-CH*

* See “While playing an MP3 or WMA disc” on page 10 for details.

More about this unit

Basic operations

Turning on the power

- By pressing SOURCE on the unit, you can also turn on the power. If the source is ready, playback also starts.

Turning off the power

- If you turn off the power while listening to a disc, disc play will start from where playback has been stopped previously, next time you turn on the power.

Selecting the sources

- When no disc is loaded in the unit, “CD” cannot be selected.
- “CD-CH” cannot be selected when the target component is not connected.

Tuner operations

Storing stations in memory

- During SSM search...
 - All previously stored stations are erased and stations are stored newly.
 - Received stations are preset in No. 1 (lowest frequency) to No. 6 (highest frequency).
 - When SSM is over, the station stored in No. 1 will be automatically tuned in.
- When storing a station manually, a previously preset station is erased when a new station is stored in the same preset number.

Disc operations

Caution for DualDisc playback

- The Non-DVD side of a “DualDisc” does not comply with the “Compact Disc Digital Audio” standard. Therefore, the use of Non-DVD side of a DualDisc on this product may not be recommended.

General

- This unit has been designed to reproduce CDs/CD Texts, and CD-Rs (Recordable)/CD-RWs (Rewritable) in audio CD (CD-DA), MP3 and WMA formats.
- When a disc has been loaded, selecting “CD” for the playback source starts disc play.

Inserting a disc

- When a disc is inserted upside down, “PLEASE” and “EJECT” appear alternately on the display. Press ▲ to eject the disc.
- Do not insert 8 cm discs (single CD) and unusual shape discs (heart, flower, etc.) into the loading slot.

Playing a disc

- While fast-forwarding or reversing on an MP3 or WMA disc, you can only hear intermittent sounds.

Playing a CD-R or CD-RW

- Use only “finalized” CD-Rs or CD-RWs.
- This unit can play back only the files of the same type which is first detected if a disc includes both audio CD (CD-DA) files and MP3/WMA files.
- This unit can play back multi-session discs; however, unclosed sessions will be skipped while playing.
- Some CD-Rs or CD-RWs may not play back on this unit because of their disc characteristics, and for the following causes:
 - Discs are dirty or scratched.
 - Moisture condensation occurs on the lens inside the unit.
 - The pickup lens inside the unit is dirty.
 - CD-R/CD-RW on which the files are written with “Packet Write” method.
 - There are improper recording conditions (missing data, etc.) or media conditions (stain, scratch, warp, etc.).
- CD-RWs may require a longer readout time since the reflectance of CD-RWs is lower than that of regular CDs.

- Do not use the following CD-Rs or CD-RWs:
 - Discs with stickers, labels, or protective seal stuck to the surface.
 - Discs on which labels can be directly printed by an ink jet printer.
- Using these discs under high temperatures or high humidities may cause malfunctions or damages to the unit.

Playing an MP3/WMA disc

- This unit can play back MP3/WMA files with the extension code <.mp3> or <.wma> (regardless of the letter case—upper/lower).
 - This unit can show the names of albums, artists (performer), and ID3 Tag (Version 1.0, 1.1, 2.2, 2.3, or 2.4) for MP3 files and for WMA files.
 - This unit can display only one-byte characters. No other characters can be correctly displayed.
 - This unit can play back MP3/WMA files meeting the conditions below:
 - Bit rate: 8 kbps — 320 kbps
 - Sampling frequency:
 - 48 kHz, 44.1 kHz, 32 kHz (for MPEG-1)
 - 24 kHz, 22.05 kHz, 16 kHz (for MPEG-2)
 - Disc format: ISO 9660 Level 1/ Level 2, Romeo, Joliet, Windows long file name
 - The maximum number of characters for file/folder names vary among the disc format used (includes 4 extension characters—<.mp3> or <.wma>).
 - ISO 9660 Level 1: up to 12 characters
 - ISO 9660 Level 2: up to 31 characters
 - Romeo*: up to 128 (72) characters
 - Joliet*: up to 64 (36) characters
 - Windows long file name*: up to 128 (72) characters
- * *The parenthetic figure is the maximum number of characters for file/folder names in case the total number of files and folders is 313 or more.*
- This unit can play back the files recorded in VBR (variable bit rate).
The files recorded in VBR have a discrepancy in elapsed time display, and do not show the actual elapsed time. Especially, after performing the search function, this difference becomes noticeable.

- This unit can recognize the total of 512 files, of 200 folders, and of 8 hierarchies.
- This unit cannot play back the following files:
 - MP3 files encoded with MP3i and MP3 PRO format.
 - MP3 files encoded in an unappropriated format.
 - MP3 files encoded with Layer 1/2.
 - WMA files encoded with lossless, professional, and voice format.
 - WMA files which are not based upon Windows Media® Audio.
 - WMA files copy-protected with DRM.
 - Files which have the data such as WAVE, ATRAC3, etc.
- The search function works but search speed is not constant.

Changing the source

- If you change the source, playback also stops (without ejecting the disc).
Next time you select “CD” for the playback source, disc play starts from where it has been stopped previously.

Ejecting a disc

- If the ejected disc is not removed within 15 seconds, the disc is automatically inserted again into the loading slot to protect it from dust. (Disc will not play this time.)

General settings—PSM

- If you change the “AMP GAIN” setting from “HIGH PWR” to “LOW PWR” while the volume level is set higher than “VOL 30,” the unit automatically changes the volume level to “VOL 30.”

Other main functions

- If you try to assign a title to a 31st disc or to the 31st station frequency, “NAMEFULL” flashes on the display. Delete unwanted titles before assignment.
- Titles assigned to discs in the CD changer can also be shown if you playback the disc from the unit.

Maintenance

How to clean the connectors

Frequent detachment will deteriorate the connectors.

To minimize this possibility, periodically wipe the connectors with a cotton swab or cloth moistened with alcohol, being careful not to damage the connectors.

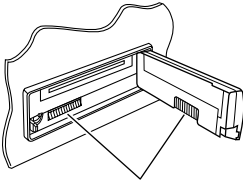

Connector

Moisture condensation

Moisture may condense on the lens inside the CD player in the following cases:

- After starting the heater in the car.
- If it becomes very humid inside the car.

Should this occur, the CD player may malfunction. In this case, eject the disc and leave the unit turned on for a few hours until the moisture evaporates.

How to handle discs

When removing a disc from its case, press down the center holder of the case and lift the disc out, holding it by the edges.

- Always hold the disc by the edges. Do not touch its recording surface.

When storing a disc into its case, gently insert the disc around the center holder (with the printed surface facing up).

- Make sure to store discs into the cases after use.

Center holder



To keep discs clean

A dirty disc may not play correctly. If a disc does become dirty, wipe it with a soft cloth in a straight line from center to edge.

- Do not use any solvent (for example, conventional record cleaner, spray, thinner, benzene, etc.) to clean discs.



To play new discs

New discs may have some rough spots around the inner and outer edges. If such a disc is used, this unit may reject the disc.

To remove these rough spots, rub the edges with a pencil or ball-point pen, etc.



Do not use the following discs:



Warped disc



Sticker

Sticker residue



Disc

Stick-on label

Troubleshooting

What appears to be trouble is not always serious. Check the following points before calling a service center.

	Symptoms	Remedies/Causes
General	<ul style="list-style-type: none"> • Sound cannot be heard from the speakers. 	<ul style="list-style-type: none"> • Adjust the volume to the optimum level. • Check the cords and connections.
	<ul style="list-style-type: none"> • The unit does not work at all. 	Reset the unit (see page 2).
FM/AM	<ul style="list-style-type: none"> • SSM automatic presetting does not work. 	Store stations manually.
	<ul style="list-style-type: none"> • Static noise while listening to the radio. 	Connect the antenna firmly.
Disc playback	<ul style="list-style-type: none"> • Disc cannot be played back. 	Insert the disc correctly.
	<ul style="list-style-type: none"> • CD-R/CD-RW cannot be played back. • Tracks on the CD-R/CD-RW cannot be skipped. 	<ul style="list-style-type: none"> • Insert a finalized CD-R/CD-RW. • Finalize the CD-R/CD-RW with the component which you used for recording.
	<ul style="list-style-type: none"> • Disc can be neither played back nor ejected. 	<ul style="list-style-type: none"> • Unlock the disc (see page 10). • Eject the disc forcibly (see page 2).
	<ul style="list-style-type: none"> • Disc sound is sometimes interrupted. 	<ul style="list-style-type: none"> • Stop playback while driving on rough roads. • Change the disc. • Check the cords and connections.
MP3/WMA playback	<ul style="list-style-type: none"> • Disc cannot be played back. 	<ul style="list-style-type: none"> • Use a disc with MP3/WMA tracks recorded in the format compliant with ISO 9660 Level 1, Level 2, Romeo, or Joliet. • Add the extension code <.mp3> or <.wma> to the file names.
	<ul style="list-style-type: none"> • Noise is generated. 	Skip to another track or change the disc. (Do not add the extension code <.mp3> or <.wma> to non-MP3 or WMA tracks.)

To be continued...

	Symptoms	Remedies/Causes
MP3/WMA playback	<ul style="list-style-type: none"> • A longer readout time is required (“CHECK” keeps flashing on the display). 	Do not use too many hierarchies and folders.
	<ul style="list-style-type: none"> • Tracks do not play back in the order you have intended them to play. 	Playback order is determined when the files are recorded.
	<ul style="list-style-type: none"> • Elapsed playing time is not correct. 	This sometimes occurs during play. This is caused by how the tracks are recorded on the disc.
	<ul style="list-style-type: none"> • “NO FILES” appears on the display. 	Insert a disc that contains MP3/WMA tracks.
	<ul style="list-style-type: none"> • Correct characters are not displayed (e.g. album name). 	This unit can only display alphabets (upper case), numbers, and a limited number of symbols.
CD changer	<ul style="list-style-type: none"> • “NO DISC” appears on the display. 	Insert a disc into the magazine.
	<ul style="list-style-type: none"> • “NO MAG” appears on the display. 	Insert the magazine.
	<ul style="list-style-type: none"> • “RESET 8” appears on the display. 	Connect this unit and the CD changer correctly and press the reset button of the CD changer.
	<ul style="list-style-type: none"> • “RESET 1” – “RESET 7” appears on the display. 	Press the reset button of the CD changer.
	<ul style="list-style-type: none"> • The CD changer does not work at all. 	Reset the unit (see page 2).

- Microsoft and Windows Media are either registered trademarks or trademarks of Microsoft Corporation in the United States and/or other countries.

Specifications

AUDIO AMPLIFIER SECTION

Maximum Power Output:

Front: 50 W per channel

Rear: 50 W per channel

Continuous Power Output (RMS):

Front: 19 W per channel into 4 Ω , 40 Hz to 20 000 Hz at no more than 0.8% total harmonic distortion.

Rear: 19 W per channel into 4 Ω , 40 Hz to 20 000 Hz at no more than 0.8% total harmonic distortion.

Load Impedance: 4 Ω (4 Ω to 8 Ω allowance)

Tone Control Range:

Bass: ± 10 dB at 100 Hz

Treble: ± 10 dB at 10 kHz

Frequency Response: 40 Hz to 20 000 Hz

Signal-to-Noise Ratio: 70 dB

Line-Out Level/Impedance:

2.5 V/20 k Ω load (full scale)

Output Impedance: 1 k Ω

Other Terminals:

CD changer, AUX (auxiliary) input jack

TUNER SECTION

Frequency Range:

FM: 87.5 MHz to 108.0 MHz

AM: 531 kHz to 1 602 kHz

[FM Tuner]

Usable Sensitivity: 11.3 dBf (1.0 μ V/75 Ω)

50 dB Quieting Sensitivity:

16.3 dBf (1.8 μ V/75 Ω)

Alternate Channel Selectivity (400 kHz): 65 dB

Frequency Response: 40 Hz to 15 000 Hz

Stereo Separation: 35 dB

Capture Ratio: 1.5 dB

[AM Tuner]

Sensitivity: 20 μ V

Selectivity: 35 dB

CD PLAYER SECTION

Type: Compact disc player

Signal Detection System: Non-contact optical pickup (semiconductor laser)

Number of Channels: 2 channels (stereo)

Frequency Response: 5 Hz to 20 000 Hz

Dynamic Range: 96 dB

Signal-to-Noise Ratio: 98 dB

Wow and Flutter: Less than measurable limit

MP3 Decoding Format:

MPEG1/2 Audio Layer 3

Max. Bit Rate: 320 kbps

WMA (Windows Media® Audio) Decoding Format:

Max. Bit Rate: 192 kbps

GENERAL

Power Requirement:

Operating Voltage:

DC 14.4 V (11 V to 16 V allowance)

Grounding System: Negative ground

Allowable Operating Temperature:

0°C to +40°C

Dimensions (W \times H \times D):

Installation Size (approx.):

182 mm \times 52 mm \times 150 mm

Panel Size (approx.):

188 mm \times 58 mm \times 11 mm

Mass (approx.):

1.5 kg (excluding accessories)

Design and specifications are subject to change without notice.



Having TROUBLE with operation?
Please reset your unit
Refer to page of How to reset your unit

JVC



JVC KD-G524

Installation/Connection Manual

GET0338-002A
[U]

0905DTSMDTJEIN
EN

© 2005 Victor Company of Japan, Limited

This unit is designed to operate on **12 V DC, NEGATIVE ground electrical systems**. If your vehicle does not have this system, a voltage inverter is required, which can be purchased at JVC car audio dealers.

WARNINGS

To prevent short circuits, we recommend that you disconnect the battery's negative terminal and make all electrical connections before installing the unit.

• **Be sure to ground this unit to the car's chassis again after installation.**

Notes:

- Replace the fuse with one of the specified rating. If the fuse blows frequently, consult your JVC car audio dealers.
- It is recommended to connect to the speakers with maximum power of more than 50 W (both at the rear and at the front, with an impedance of **4 Ω to 8 Ω**). If the maximum power is less than 50 W, change "AMP GAIN" setting to prevent the speakers from being damaged (see page 13 of the INSTRUCTIONS).
- To prevent short-circuit, cover the terminals of the UNUSED leads with insulating tape.
- The heat sink becomes very hot after use. Be careful not to touch it when removing this unit.

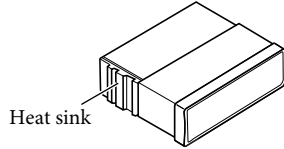

PRECAUTIONS on power supply and speaker connections:

- **DO NOT connect the speaker leads of the power cord to the car battery; otherwise, the unit will be seriously damaged.**
- BEFORE connecting the speaker leads of the power cord to the speakers, check the speaker wiring in your car.

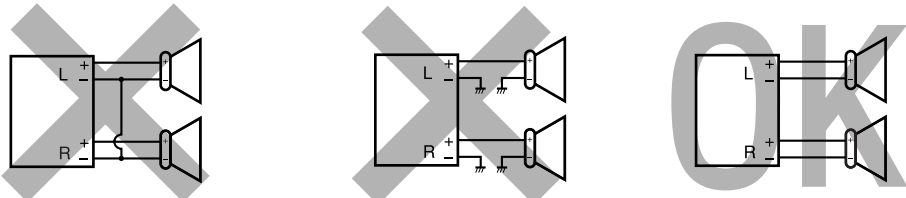

Parts list for installation and connection

The following parts are provided for this unit. After checking them, please set them correctly.

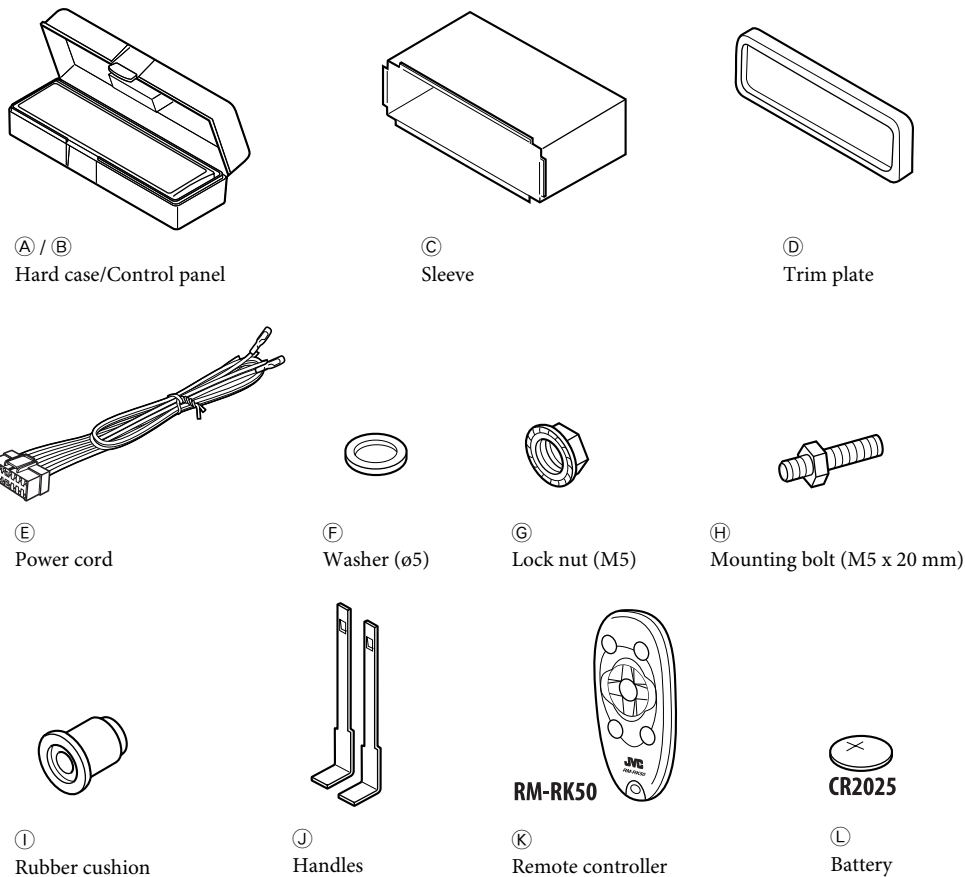

TROUBLESHOOTING

- **The fuse blows.**
 - * Are the red and black leads connected correctly?
- **Power cannot be turned on.**
 - * Is the yellow lead connected?
- **No sound from the speakers.**
 - * Is the speaker output lead short-circuited?
- **Sound is distorted.**
 - * Is the speaker output lead grounded?
 - * Are the "-" terminals of L and R speakers grounded in common?
- **Noise interfere with sounds.**
 - * Is the rear ground terminal connected to the car's chassis using shorter and thicker cords?
- **This unit becomes hot.**
 - * Is the speaker output lead grounded?
 - * Are the "-" terminals of L and R speakers grounded in common?
- **This unit does not work at all.**
 - * Have you reset your unit?

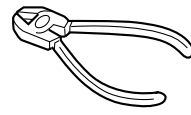
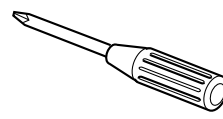

INSTALLATION (IN-DASH MOUNTING)

The following illustration shows a typical installation. If you have any questions or require information regarding installation kits, consult your JVC car audio dealers or a company supplying kits.

- If you are not sure how to install this unit correctly, have it installed by a qualified technician.

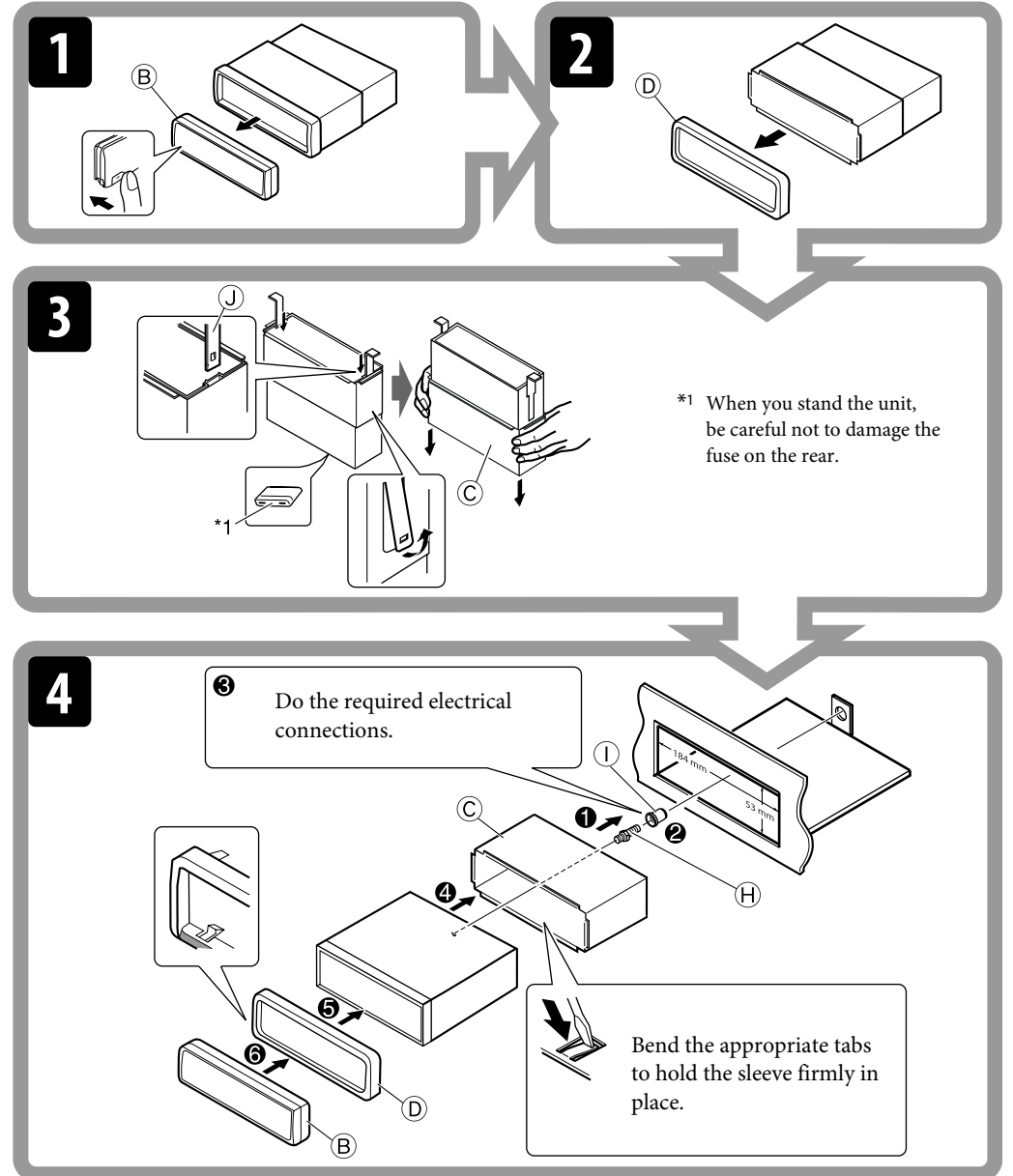

Removing the unit

Before removing the unit, release the rear section.

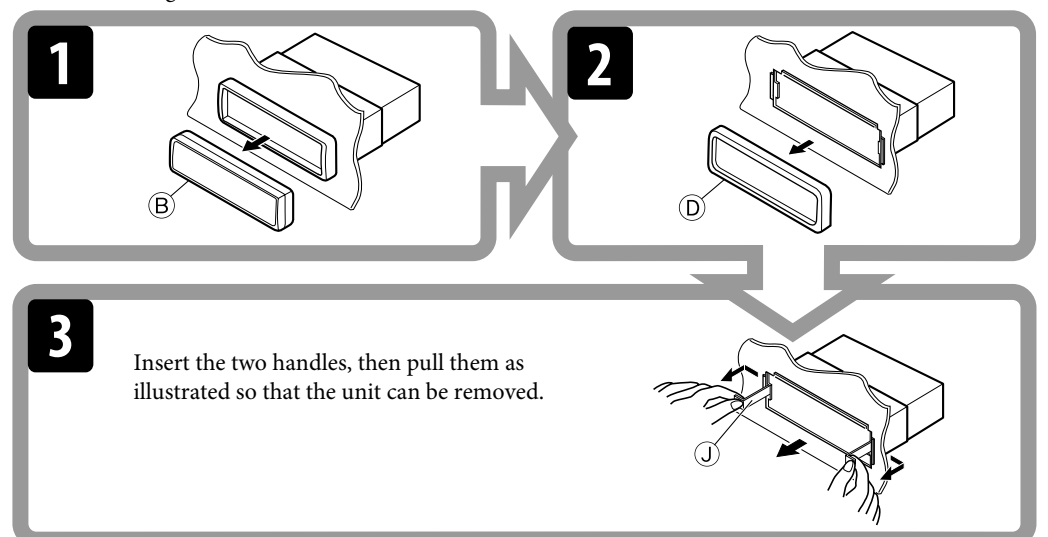

When using the optional stay

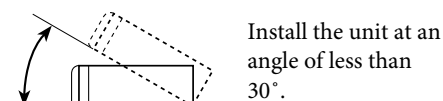
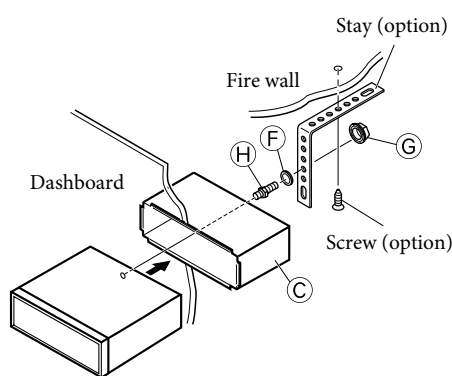

When installing the unit without using the sleeve

In a Toyota for example, first remove the car radio and install the unit in its place.

* Not supplied for this unit.

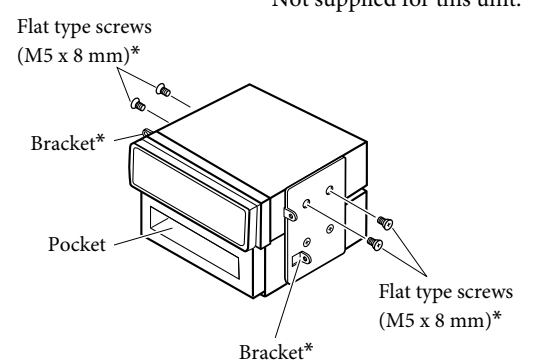

Note : When installing the unit on the mounting bracket, make sure to use the 8 mm-long screws. If longer screws are used, they could damage the unit.

ELECTRICAL CONNECTIONS

A Typical Connections

Before connecting: Check the wiring in the vehicle carefully. Incorrect connection may cause serious damage to this unit. The leads of the power cord and those of the connector from the car body may be different in color.

- 1 Connect the colored leads of the power cord in the order specified in the illustration below.
- 2 Connect the antenna cord.
- 3 Finally connect the wiring harness to the unit.

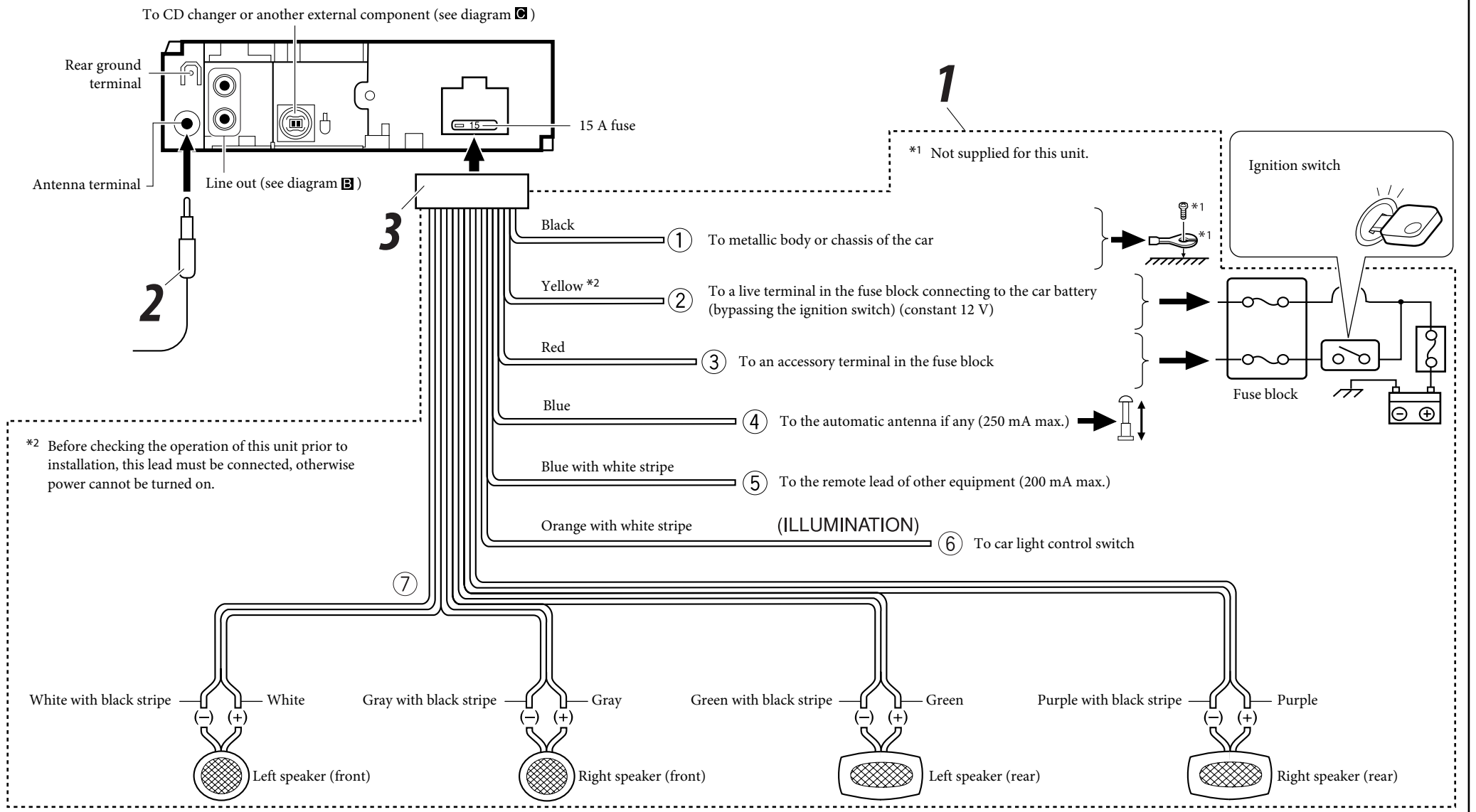

B Connecting the external amplifier

You can connect amplifiers to upgrade your car stereo system.

- Connect the remote lead (blue with white stripe) to the remote lead of the other equipment so that it can be controlled through this unit.
- **Disconnect the speakers from this unit, connect them to the amplifier. Leave the speaker leads of this unit unused.**

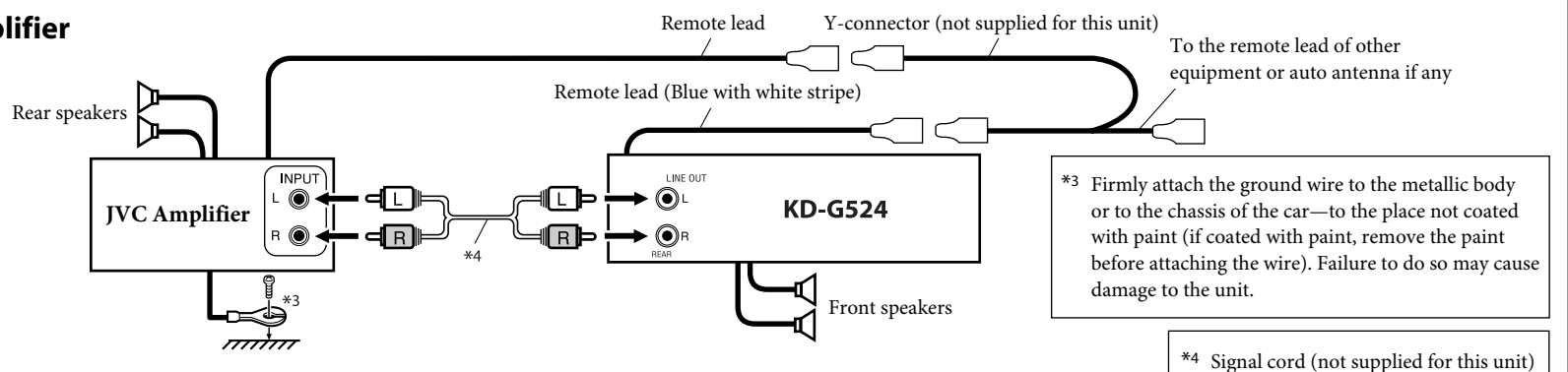

C Connecting the external components

- Set "CHANGER" for the external input setting (see page 13 of the INSTRUCTIONS.)

CD changer, Apple iPod®, or JVC D. player

You can connect these components as illustrated below. The iPod*5 or D. player can be connected using an interface adapter (not supplied)—KS-PD100 (for iPod) or KS-PD500 (for D. player).

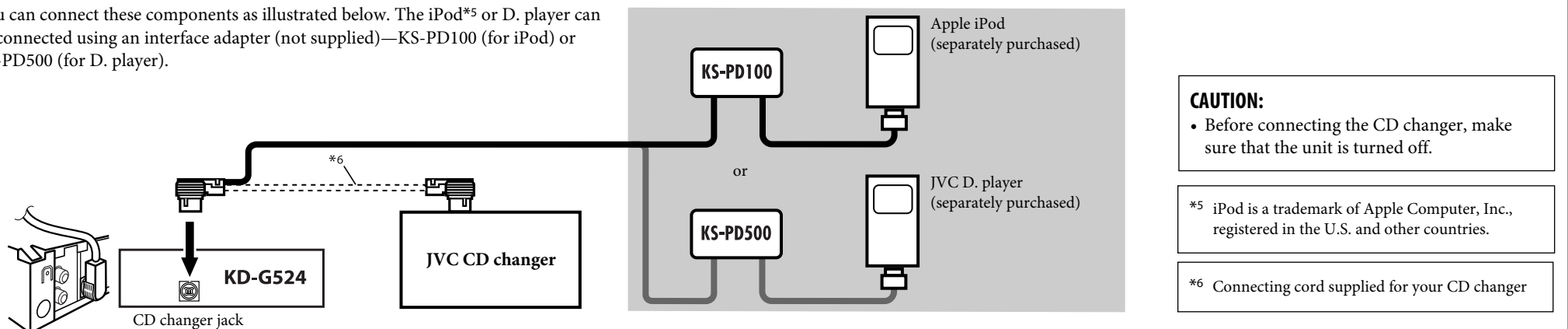

- Set "EXT IN" for the external input setting (see page 13 of the INSTRUCTIONS.)

External Component

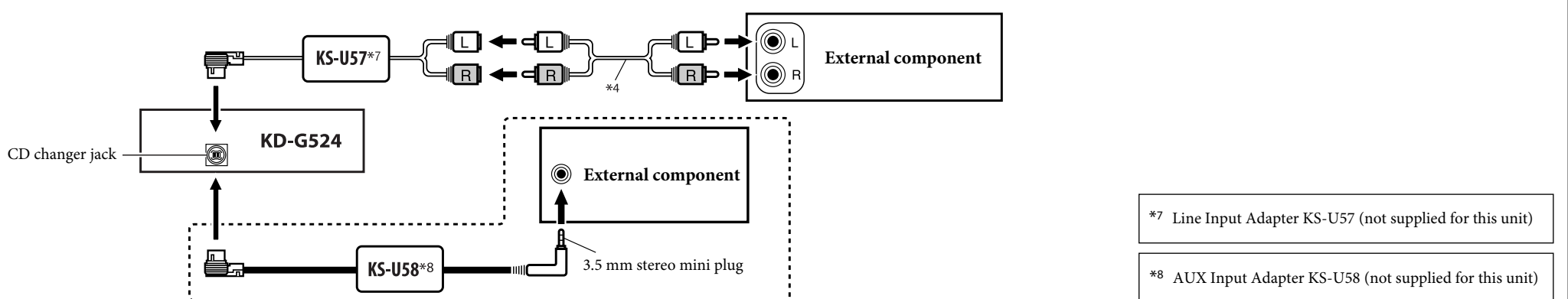

JVC



CD RECEIVER

KD-G525

ENGLISH

เครื่องเล่น CD

KD-G525

ไทย

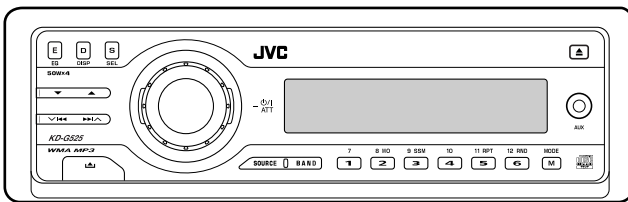
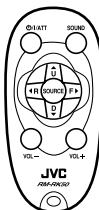
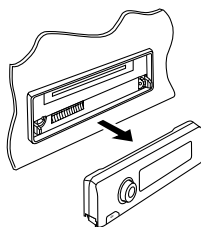

WMA MP3



For canceling the display demonstration, see page 6.

ดูที่หน้า 6 เพื่อยกเลิกการสาธิตภาพประกอบ

For installation and connections, refer to the separate manual.

กรุณาดูคู่มือที่แยกต่างหาก ในการติดตั้งและการเชื่อมต่อ

INSTRUCTIONS

คำแนะนำ

GET0337-001A
[U/UH]

Thank you for purchasing a JVC product.

Please read all instructions carefully before operation, to ensure your complete understanding and to obtain the best possible performance from the unit.

IMPORTANT FOR LASER PRODUCTS

1. CLASS 1 LASER PRODUCT
2. **CAUTION:** Do not open the top cover. There are no user serviceable parts inside the unit; leave all servicing to qualified service personnel.
3. **CAUTION:** Visible and invisible laser radiation when open and interlock failed or defeated. Avoid direct exposure to beam.
4. REPRODUCTION OF LABEL: CAUTION LABEL, PLACED OUTSIDE THE UNIT.

CAUTION : Visible and invisible laser radiation when open and interlock failed or defeated. AVOID DIRECT EXPOSURE TO BEAM.	ADVARSEL : Synlig og usynlig laserstråling når maskinen er åpen eller interlocken feiler. Undgå direkte eksponering til stråling.	VARNING : Synlig og usynlig laserstråling når den åpnes og spærren er turkoppplad. Betrakta ej strålen.	VARO : Avattassa ja suojalukitus ohjettuna tai viallisena olet alttiina näkyvälle ja näkymättömälle lasersträilylle. Vältä säteen kohdistumista suoraan itseesi, (f)
---	--	--	---

How to reset your unit

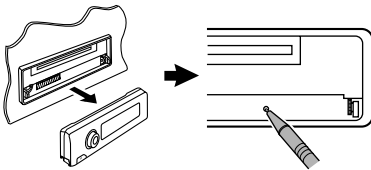

Your preset adjustments will also be erased.

How to forcibly eject a disc



“PLEASE” and “EJECT” appear alternately on the display.

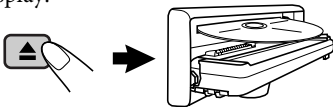

- If this does not work, reset your unit.
- Be careful not to drop the disc when it ejects.

How to detach/attach the control panel

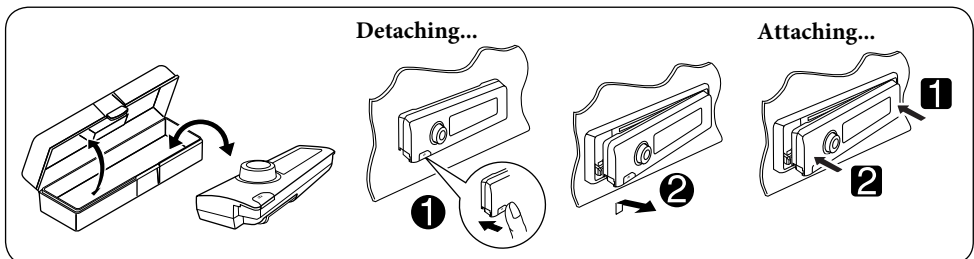

How to use the M MODE button

If you press M MODE, the unit goes into functions mode, then the number buttons and ▲/▼ buttons work as different function buttons.



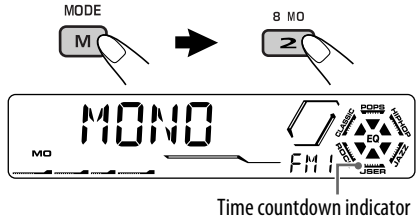

Ex.: When number button 2 works as MO (monaural) button.



To use these buttons for their original functions again after pressing M MODE, wait for 5 seconds without pressing any of these buttons until the functions mode is cleared or press M MODE again.

How to read this manual

- Button operations are mainly explained with the illustrations in the table below.
- Some related tips and notes are explained in “More about this unit” (see pages 16 and 17).

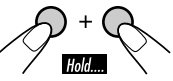
	Press briefly.
	Press repeatedly.
	Press either one.
	Press and hold until your desired response begins.
	Press and hold both buttons at the same time.

The following marks are used to indicate...

 : Built-in CD player operations.

 : External CD changer operations.

 : Indicator displayed for the corresponding operation.

Warning:

If you need to operate the unit while driving, be sure to look ahead carefully or you may be involved in a traffic accident.

Caution on volume setting:

Discs produce very little noise compared with other sources. Lower the volume before playing a disc to avoid damaging the speakers by the sudden increase of the output level.

CONTENTS

Control panel	4
Remote controller — RM-RK50	5
Getting started.....	6
Basic operations.....	6
Radio operations	7
Disc operations	8
Playing a disc in the unit	8
Playing discs in the CD changer	8
Sound adjustments.....	11
General settings — PSM	12
Title assignment	14
External component operations	15
More about this unit	16
Maintenance	18
Troubleshooting	19
Specifications	21

For safety...

- Do not raise the volume level too much, as this will block outside sounds, making driving dangerous.
- Stop the car before performing any complicated operations.

Temperature inside the car...

If you have parked the car for a long time in hot or cold weather, wait until the temperature in the car becomes normal before operating the unit.

Control panel

Parts identification

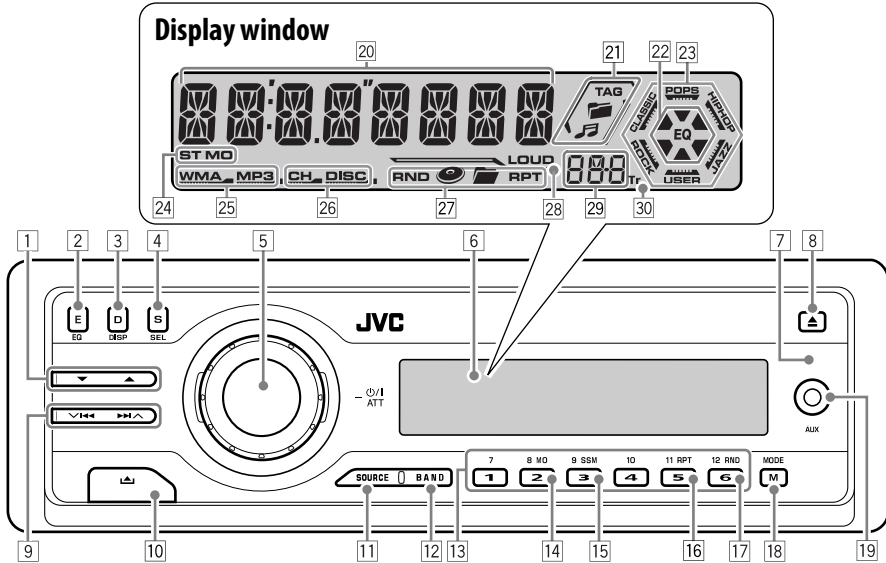

- 1 ▲ (up) / ▼ (down) buttons
- 2 E EQ (equalizer) button
- 3 D DISP (display) button
- 4 S SEL (select) button
- 5 • Control dial
 - Φ /I ATT (standby/on attenuator) button
- 6 Display window
- 7 Remote sensor
 - **DO NOT** expose the remote sensor to strong light (direct sunlight or artificial lighting).
- 8 ▲ (eject) button
- 9 ▼ ◀▶▶▶ ▲ buttons
- 10 ▲ (control panel release) button
- 11 SOURCE button
- 12 BAND button
- 13 Number buttons
- 14 MO (monaural) button
- 15 SSM (Strong-station Sequential Memory) button
- 16 RPT (repeat) button
- 17 RND (random) button
- 18 M MODE button
- 19 AUX (auxiliary) input jack

Display window

- 20 Main display
- 21 Disc information indicators—TAG (ID3 Tag), (folder), (track/file)
- 22 EQ (equalizer) indicator
- 23 Sound mode (C-EQ: custom equalizer) indicators—ROCK, CLASSIC, POPS, HIP HOP, JAZZ, USER
 - also works as the time countdown indicator and level meter during play (see page 13).
- 24 Tuner reception indicators—ST (stereo), MO (monaural)
- 25 Disc type indicators—WMA, MP3
- 26 Playback source indicators—
 - CH: Lights up only when CD-CH is selected as the playback source.
 - DISC: Lights up for the built-in CD player.
- 27 Playback mode / item indicators—
 - RND (random), (disc), (folder), RPT (repeat)
- 28 LOUD (loudness) indicator
- 29 Source display / Volume level indicator
- 30 Tr (track) indicator

Installing the lithium coin battery (CR2025)

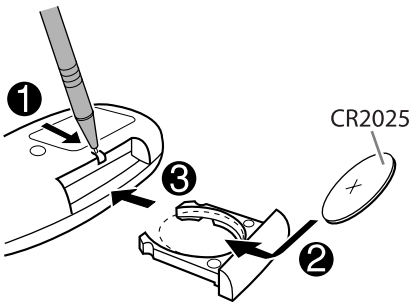

Aim the remote controller directly at the remote sensor on the unit. Make sure there is no obstacle in between.

Warning:

- Do not install any battery other than CR2025 or its equivalent; otherwise, it may explode.
- Store the battery in a place where children cannot reach to avoid risk of accident.
- To prevent the battery from over-heating, cracking, or starting a fire:
 - Do not recharge, short, disassemble, heat the battery, or dispose of it in a fire.
 - Do not leave the battery with other metallic materials.
 - Do not poke the battery with tweezers or similar tools.
 - Wrap the battery with tape and insulate when throwing away or saving it.

Caution:

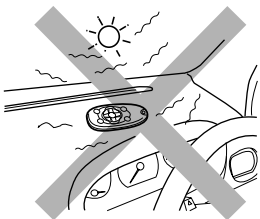

Main elements and features

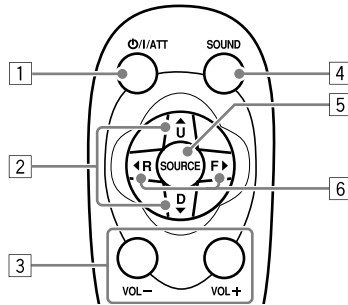

- 1 **⏻/I/ATT** (standby/on/attenuator) button
 - Turns the power on if pressed briefly or attenuates the sound when power is on.
 - Turns the power off if pressed and held.
- 2 **▲ U (up) / D (down) ▼** buttons
 - Changes the FM/AM bands with ▲ U only.
 - Changes the preset stations with D ▼ only.
 - Changes the folder of the MP3/WMA discs.
 - While playing an MP3 disc on an MP3-compatible CD changer:
 - Changes the disc if pressed briefly.
 - Changes the folder if pressed and held.
- 3 **VOL - / VOL +** buttons
 - Adjusts the volume level.
- 4 **SOUND** button
 - Selects the sound mode (C-EQ: custom equalizer).
- 5 **SOURCE** button
 - Selects the source.
- 6 **◀ R (reverse) / F (forward) ▶** buttons
 - Searches for stations if pressed briefly.
 - Fast-forwards or reverses the track if pressed and held.
 - Changes the tracks of the disc if pressed briefly.

Getting started

Basic operations

1 Turn on the power.

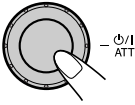

2



- Select “CD-CH” when using an Apple iPod® or a JVC D. player (see page 15).

iPod is a trademark of Apple Computer, Inc., registered in the U.S. and other countries.

* You cannot select these sources if they are not ready.

3 For FM/AM tuner



4 Adjust the volume.

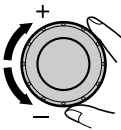

Volume level appears.



Volume level indicator

5 Adjust the sound as you want. (See pages 11 and 12.)

To drop the volume in a moment (ATT)

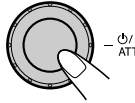

To restore the sound, press it again.

To turn off the power



Hold....

Basic settings

- See also “General settings — PSM” on pages 12 and 13.

1



Hold....

2

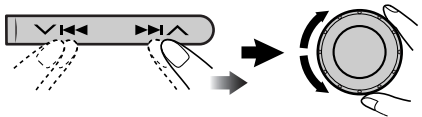

1 Canceling the display demonstrations

Select “DEMO,” then “DEMO OFF.”

2 Setting the clock

Select “CLOCK H” (hour), then adjust the hour.

Select “CLOCK M” (minute), then adjust the minute.

3 Finish the procedure.



SEL

To check the current clock time when the power is turned off



DISP

Radio operations

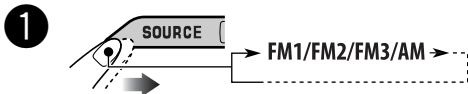

Lights up when receiving an FM stereo broadcast with sufficient signal strength.



Selected band appears.

3 Start searching for a station.

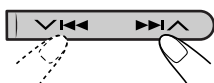

When a station is received, searching stops.

To stop searching, press the same button again.

To tune in to a station manually

In step 3 above...

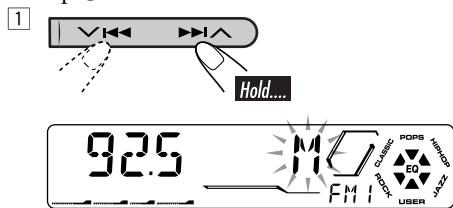

2 Select the desired station frequencies.

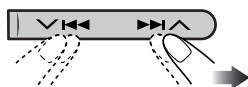

When an FM stereo broadcast is hard to receive

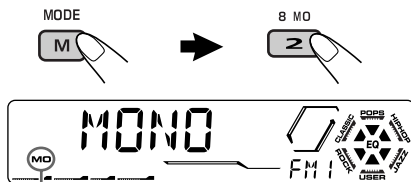

Lights up when monaural mode is activated.

Reception improves, but stereo effect will be lost.

To restore the stereo effect, repeat the same procedure. "MONO OFF" appears and the MO indicator goes off.

Storing stations in memory

You can preset six stations for each band.

FM station automatic presetting—SSM (Strong-station Sequential Memory)

1 Select the FM band (FM1 - FM3) you want to store into.

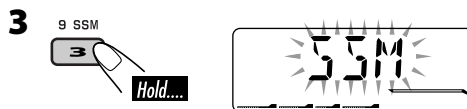

"SSM" flashes, then disappears when automatic presetting is over.

Local FM stations with the strongest signals are searched and stored automatically in the FM band.

Manual presetting

Ex.: Storing FM station of 92.5 MHz into preset number 4 of the FM1 band.

-
-
- Preset number flashes for a while.

Listening to a preset station

-
- Select the preset station (1 - 6) you want.

7	8 MO	9 SSM	10	11 RPT	12 RND
1	2	3	4	5	6

or

To check the other information while listening to an FM or AM station



Clock → **Station name*** → **Frequency** →
(back to the beginning)

* If no title is assigned to a station, "NO NAME" appears. To assign a title to a station, see page 14.

Disc operations

Playing a disc in the unit

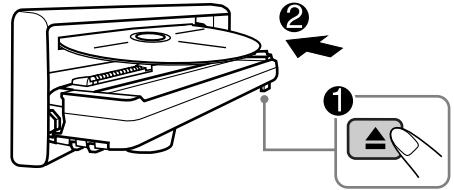

All tracks will be played repeatedly until you change the source or eject the disc.

To stop play and eject the disc



Playing discs in the CD changer

All discs in the magazine will be played repeatedly until you change the source.
• Ejecting the magazine will also stop playing.

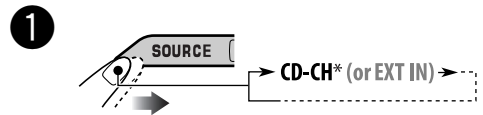

* If you have changed "EXT IN" setting to "EXT IN" (see page 13), you cannot select the CD changer.
See also page 15 when using an iPod or JVC D. player.

2 Select a disc.

For disc number from 01 - 06:

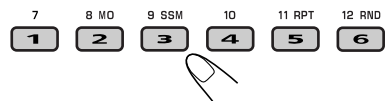

For disc number from 07 - 12:

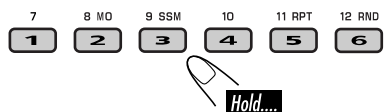

About MP3 and WMA discs

MP3 and WMA “tracks” (words “file” and “track” are used interchangeably) are recorded in “folders.”

About the CD changer

It is recommended to use a JVC MP3-compatible CD changer with your unit.

- You can also connect other CH-X series CD changers (except CH-X99 and CH-X100). These units are not compatible with MP3 discs.
- You cannot play any WMA disc in the CD changer.
- You cannot use the KD-MK series CD changers with this unit.
- Disc text information recorded in the CD Text can be displayed when a JVC CD Text compatible CD changer is connected.

To locate a particular track (for CD) or folder (for MP3 or WMA discs) directly



To select a number from 01 – 06:

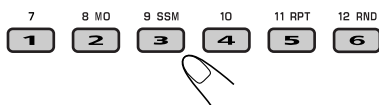

To select a number from 07 – 12:

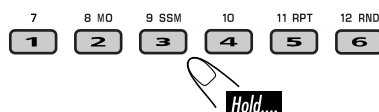

- To use folder search on MP3/WMA discs, it is required that folders are assigned with 2-digit numbers at the beginning of their folder names—01, 02, 03, and so on.

To fast-forward or reverse the track



To go to the next or previous tracks

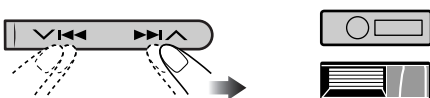

To go to the next or previous folders (only for MP3 or WMA discs)

For MP3 discs:

For WMA discs:

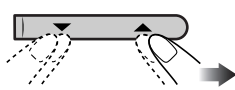

• To select a particular track in a folder (for MP3 or WMA disc):

Other main functions

■ Skipping a track quickly during play



Only possible on JVC
MP3-compatible CD changer

- For MP3 or WMA disc, you can skip a track within the same folder.

Ex.: To select track 32 while playing track 6

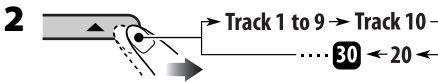
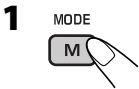

Each time you press the button, you can skip 10 tracks.

- After the last track, the first track will be selected and vice versa.



■ Prohibiting disc ejection



You can lock a disc in the loading slot.

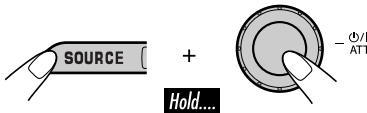

To cancel the prohibition, repeat the same procedure.

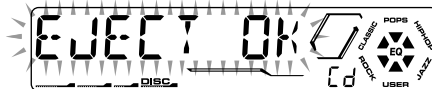

Changing the display information



■ While playing an audio CD or a CD Text

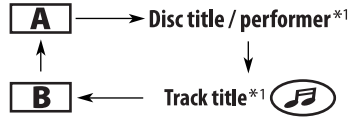

■ While playing an MP3 or WMA*2 disc

- When "TAG DISP" is set to "TAG ON" (see page 13)

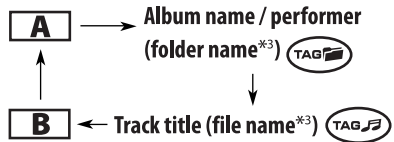

- When "TAG DISP" is set to "TAG OFF"

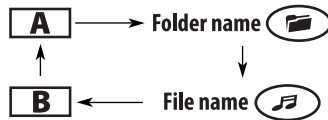

- A** : Clock with the current track number
- B** : Elapsed playing time with the current track number

*1 If the current disc is an audio CD, "NO NAME" appears.

*2 Only for the built-in CD player.

*3 If an MP3/WMA file does not have ID3 tags, folder name and file name appear. In this case, the TAG indicator will not light up.

Selecting the playback modes

You can use only one of the following playback modes at a time.

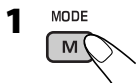

2 Select your desired playback mode.

Repeat play

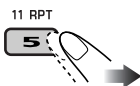

Mode	Plays repeatedly
TRK RPT	: The current track.
FLDR RPT *1	: All tracks of the current folder.
DISC RPT *2	: All tracks of the current disc.
RPT OFF	: Cancels.

Random play



Mode	Plays at random
FLDR RND *1	: All tracks of the current folder, then tracks of the next folder and so on.
DISC RND	: All tracks of the current disc.
MAG RND *2	: All tracks of the inserted discs.
RND OFF	: Cancels.

*1 Only while playing an MP3 or WMA disc.

*2 Only while playing discs in the CD changer.

Sound adjustments

You can select a preset sound mode suitable to the music genre (C-EQ: custom equalizer).



Preset values	BAS (bass)	TRE (treble)	LOUD (loudness)
USER (Flat sound)	00	00	OFF
ROCK (Rock or disco music)	+03	+01	ON
CLASSIC (Classical music)	+01	-02	OFF
POPS (Light music)	+04	+01	OFF
HIP HOP (Funk or rap music)	+02	00	ON
JAZZ (jazz music)	+02	+03	OFF

Adjusting the sound

You can adjust the sound characteristics to your preference.

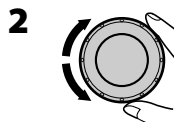

Indication pattern changes as you adjust the level.

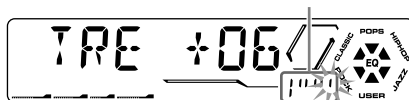

Ex.: When "TRE" is selected

To be continued...

Indication [Range]**BAS***1 (bass)

Adjust the bass. [-06 to +06]

TRE*1 (treble)

Adjust the treble. [-06 to +06]

FAD*2 (fader)Adjust the front and rear speaker balance.
[R06 to F06]**BAL** (balance)Adjust the left and right speaker balance.
[L06 to R06]**LOUD***1 (loudness)Boost low and high frequencies to produce a well-balanced sound at low volume level.
[LOUD ON or LOUD OFF]**VOL** (volume)

Adjust the volume. [00 to 30 or 50*3]

*1 When you adjust the bass, treble, or loudness, the adjustment you have made is stored for the currently selected sound mode (C-EQ) including "USER."

*2 If you are using a two-speaker system, set the fader level to "00."

*3 Depending on the amplifier gain control setting. (See page 13 for details.)

General settings — PSM

You can change PSM (Preferred Setting Mode) items listed in the table that follows.

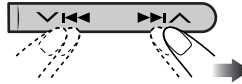
**2** Select a PSM item.

Ex.: When you select "DIMMER"

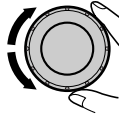
3 Adjust the PSM item selected.**4** Repeat steps 2 and 3 to adjust the other PSM items if necessary.**5** Finish the procedure.

Indications	Selectable settings, [reference page]
DEMO Display demonstration	<p>DEMO ON : [Initial]; Display demonstration will be activated automatically if no operation is done for about 20 seconds, [6].</p> <p>DEMO OFF : Cancels.</p>
CLOCK H Hour adjustment	<p>1 – 12, [6] [Initial: 1 (1:00)]</p>
CLOCK M Minute adjustment	<p>00 – 59, [6] [Initial: 00 (1:00)]</p>
LEVEL Audio level meter	<p>ON : [Initial]; Activates the audio level indicator.</p> <p>OFF : Cancels; sound mode indicator is shown.</p>
DIMMER Dimmer	<p>AUTO : [Initial]; Dims the display when you turn on the headlights.</p> <p>ON : Activates dimmer.</p> <p>OFF : Cancels.</p>
SCROLL *1 Scroll	<p>ONCE : [Initial]; Scrolls the disc information once.</p> <p>AUTO : Repeats scrolling (5-second intervals in between).</p> <p>OFF : Cancels.</p> <ul style="list-style-type: none"> Pressing D DISP for more than one second can scroll the display regardless of the setting.
EXT IN *2 External input	<p>CHANGER : [Initial]; To use a JVC CD changer, [8], an Apple iPod or a JVC D. player, [15].</p> <p>EXT IN : To use another external component, [15].</p>
AUX ADJ Auxiliary input level adjustment	<p>A.ADJ 00 – A.ADJ 05: Adjust the auxiliary input level to avoid the sudden increase of the output level when changing the source from external component connected to the AUX input jack on the control panel. [Initial: A.ADJ 00]</p>
TAG DISP Tag display	<p>TAG ON : [Initial]; Shows the ID3 tag while playing MP3/WMA tracks, [10].</p> <p>TAG OFF : Cancels.</p>
AMP GAIN Amplifier gain control	<p>You can change the maximum volume level of this unit.</p> <p>LOW PWR : VOL 00 – VOL 30 (Select this if the maximum power of the speaker is less than 50 W to prevent them from damaging the speaker.)</p> <p>HIGH PWR : [Initial]; VOL 00 – VOL 50</p>

*1 Some characters or symbols will not be shown correctly (or will be blanked) on the display.

*2 Displayed only when one of the following sources is selected—FM, AM, CD, or AUX IN.

Title assignment

You can assign titles to station frequencies and CDs (both in the unit and the CD changer).

Sources	Maximum number of characters
FM/AM tuner	Up to 8 characters (up to 30 station frequencies including both FM and AM)
CDs/CD-CH	Up to 32 characters (up to 30 discs)

* You cannot assign a title to a CD Text or an MP3/WMA disc.

1 Select the sources.

- For FM/AM tuner: Tune into a station.
- For CDs in this unit: Insert a CD.
- For CDs in the CD changer: Select "CD-CH," then select a disc number.

2 Enter the title assignment mode.

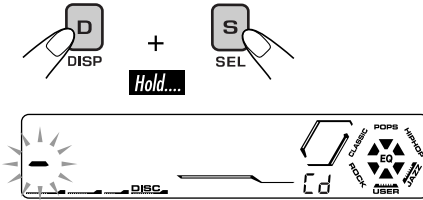

Ex.: When you select "CD" as the source

3 Assign a title.

1 Select a character.

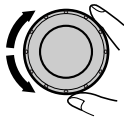

A	B	C	D	E	F	G	H	I	J	K	L	M	N
O	P	Q	R	S	T	U	V	W	X	Y	Z	0	1
2	3	4	5	6	7	8	9	- /	<	>	space		

2 Move to the next (or previous) character position.

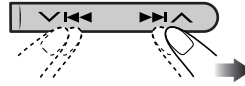

3 Repeat steps 1 and 2 until you finish entering the title.

4 Finish the procedure.



To erase the entire title

In step 2 on the left...



This unit is ready for operating an Apple iPod® or a JVC D. player from the control panel.

- For details, refer also to the manual supplied with the interface adapter for iPod®—KS-PD100 or D. player—KS-PD500.

External component operations

You can connect an external component to...

- CD changer jack on the rear using:
 - **Line Input Adapter**—KS-U57 (not supplied) or **AUX Input Adapter**—KS-U58 (not supplied) for any other components (except iPod and D. player).
 - **Interface adapter for iPod®**—KS-PD100 (not supplied) for controlling iPod.
 - **D. player interface adapter**—KS-PD500 (not supplied) for controlling D. player.
- AUX (auxiliary) input jack on the control panel.

For connection, see Installation/Connection Manual (separate volume).

Connecting an external component to the AUX input jack

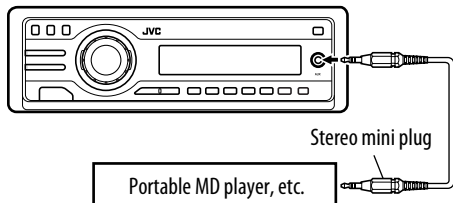

- 1 For selecting the external component connected to...
 - **AUX input jack**

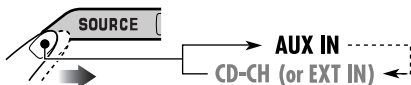

- **CD changer jack on the rear using KS-U57 or KS-U58**

If “EXT IN” does not appear, see page 13 and select the external input (“EXT IN”).

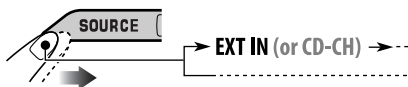

- **CD changer jack on the rear using interface adapter for iPod—KS-PD100 or for D. player—KS-PD500**

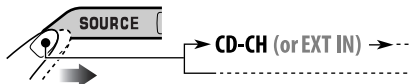

- 2 Turn on the connected component and start playing the source.
- 3 Adjust the volume.

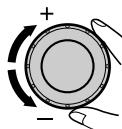

- 4 Adjust the sound as you want. (See pages 11 and 12.)

To check the other information while listening to an external component



Clock ↔ AUX IN, EXT IN, or CD-CH*

* See “While playing an MP3 or WMA disc” on page 10 for details.

More about this unit

Basic operations

Turning on the power

- By pressing SOURCE on the unit, you can also turn on the power. If the source is ready, playback also starts.

Turning off the power

- If you turn off the power while listening to a disc, disc play will start from where playback has been stopped previously, next time you turn on the power.

Selecting the sources

- When no disc is loaded in the unit, “CD” cannot be selected.
- “CD-CH” cannot be selected when the target component is not connected.

Tuner operations

Storing stations in memory

- During SSM search...
 - All previously stored stations are erased and stations are stored newly.
 - Received stations are preset in No. 1 (lowest frequency) to No. 6 (highest frequency).
 - When SSM is over, the station stored in No. 1 will be automatically tuned in.
- When storing a station manually, a previously preset station is erased when a new station is stored in the same preset number.

Disc operations

Caution for DualDisc playback

- The Non-DVD side of a “DualDisc” does not comply with the “Compact Disc Digital Audio” standard. Therefore, the use of Non-DVD side of a DualDisc on this product may not be recommended.

General

- This unit has been designed to reproduce CDs/CD Texts, and CD-Rs (Recordable)/CD-RWs (Rewritable) in audio CD (CD-DA), MP3 and WMA formats.
- When a disc has been loaded, selecting “CD” for the playback source starts disc play.

Inserting a disc

- When a disc is inserted upside down, “PLEASE” and “EJECT” appear alternately on the display. Press ▲ to eject the disc.
- Do not insert 8 cm discs (single CD) and unusual shape discs (heart, flower, etc.) into the loading slot.

Playing a disc

- While fast-forwarding or reversing on an MP3 or WMA disc, you can only hear intermittent sounds.

Playing a CD-R or CD-RW

- Use only “finalized” CD-Rs or CD-RWs.
- This unit can play back only the files of the same type which is first detected if a disc includes both audio CD (CD-DA) files and MP3/WMA files.
- This unit can play back multi-session discs; however, unclosed sessions will be skipped while playing.
- Some CD-Rs or CD-RWs may not play back on this unit because of their disc characteristics, and for the following causes:
 - Discs are dirty or scratched.
 - Moisture condensation occurs on the lens inside the unit.
 - The pickup lens inside the unit is dirty.
 - CD-R/CD-RW on which the files are written with “Packet Write” method.
 - There are improper recording conditions (missing data, etc.) or media conditions (stain, scratch, warp, etc.).
- CD-RWs may require a longer readout time since the reflectance of CD-RWs is lower than that of regular CDs.

- Do not use the following CD-Rs or CD-RWs:
 - Discs with stickers, labels, or protective seal stuck to the surface.
 - Discs on which labels can be directly printed by an ink jet printer.
 Using these discs under high temperatures or high humidities may cause malfunctions or damages to the unit.

Playing an MP3/WMA disc

- This unit can play back MP3/WMA files with the extension code <.mp3> or <.wma> (regardless of the letter case—upper/lower).
 - This unit can show the names of albums, artists (performer), and ID3 Tag (Version 1.0, 1.1, 2.2, 2.3, or 2.4) for MP3 files and for WMA files.
 - This unit can display only one-byte characters. No other characters can be correctly displayed.
 - This unit can play back MP3/WMA files meeting the conditions below:
 - Bit rate: 8 kbps — 320 kbps
 - Sampling frequency:
 - 48 kHz, 44.1 kHz, 32 kHz (for MPEG-1)
 - 24 kHz, 22.05 kHz, 16 kHz (for MPEG-2)
 - Disc format: ISO 9660 Level 1/ Level 2, Romeo, Joliet, Windows long file name
 - The maximum number of characters for file/folder names vary among the disc format used (includes 4 extension characters—<.mp3> or <.wma>).
 - ISO 9660 Level 1: up to 12 characters
 - ISO 9660 Level 2: up to 31 characters
 - Romeo*: up to 128 (72) characters
 - Joliet*: up to 64 (36) characters
 - Windows long file name*: up to 128 (72) characters
- * *The parenthetic figure is the maximum number of characters for file/folder names in case the total number of files and folders is 313 or more.*
- This unit can play back the files recorded in VBR (variable bit rate).
The files recorded in VBR have a discrepancy in elapsed time display, and do not show the actual elapsed time. Especially, after performing the search function, this difference becomes noticeable.

- This unit can recognize the total of 512 files, of 200 folders, and of 8 hierarchies.
- This unit cannot play back the following files:
 - MP3 files encoded with MP3i and MP3 PRO format.
 - MP3 files encoded in an unappropriated format.
 - MP3 files encoded with Layer 1/2.
 - WMA files encoded with lossless, professional, and voice format.
 - WMA files which are not based upon Windows Media® Audio.
 - WMA files copy-protected with DRM.
 - Files which have the data such as WAVE, AT3AC3, etc.
- The search function works but search speed is not constant.

Changing the source

- If you change the source, playback also stops (without ejecting the disc).
Next time you select “CD” for the playback source, disc play starts from where it has been stopped previously.

Ejecting a disc

- If the ejected disc is not removed within 15 seconds, the disc is automatically inserted again into the loading slot to protect it from dust. (Disc will not play this time.)

General settings—PSM

- If you change the “AMP GAIN” setting from “HIGH PWR” to “LOW PWR” while the volume level is set higher than “VOL 30,” the unit automatically changes the volume level to “VOL 30.”

Other main functions

- If you try to assign a title to a 31st disc or to the 31st station frequency, “NAMEFULL” flashes on the display. Delete unwanted titles before assignment.
- Titles assigned to discs in the CD changer can also be shown if you playback the disc from the unit.

Maintenance

How to clean the connectors

Frequent detachment will deteriorate the connectors.

To minimize this possibility, periodically wipe the connectors with a cotton swab or cloth moistened with alcohol, being careful not to damage the connectors.

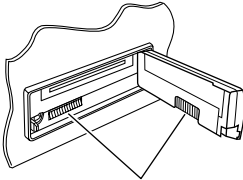

Connector

Moisture condensation

Moisture may condense on the lens inside the CD player in the following cases:

- After starting the heater in the car.
- If it becomes very humid inside the car.

Should this occur, the CD player may malfunction. In this case, eject the disc and leave the unit turned on for a few hours until the moisture evaporates.

How to handle discs

When removing a disc from its case, press down the center holder of the case and lift the disc out, holding it by the edges.

Center holder



- Always hold the disc by the edges. Do not touch its recording surface.

When storing a disc into its case, gently insert the disc around the center holder (with the printed surface facing up).

- Make sure to store discs into the cases after use.

To keep discs clean

A dirty disc may not play correctly. If a disc does become dirty, wipe it with a soft cloth in a straight line from center to edge.



- Do not use any solvent (for example, conventional record cleaner, spray, thinner, benzene, etc.) to clean discs.

To play new discs

New discs may have some rough spots around the inner and outer edges. If such a disc is used, this unit may reject the disc.



To remove these rough spots, rub the edges with a pencil or ball-point pen, etc.

Do not use the following discs:



Troubleshooting

What appears to be trouble is not always serious. Check the following points before calling a service center.

	Symptoms	Remedies/Causes
General	<ul style="list-style-type: none"> • Sound cannot be heard from the speakers. 	<ul style="list-style-type: none"> • Adjust the volume to the optimum level. • Check the cords and connections.
	<ul style="list-style-type: none"> • The unit does not work at all. 	Reset the unit (see page 2).
FM/AM	<ul style="list-style-type: none"> • SSM automatic presetting does not work. 	Store stations manually.
	<ul style="list-style-type: none"> • Static noise while listening to the radio. 	Connect the antenna firmly.
Disc playback	<ul style="list-style-type: none"> • Disc cannot be played back. 	Insert the disc correctly.
	<ul style="list-style-type: none"> • CD-R/CD-RW cannot be played back. • Tracks on the CD-R/CD-RW cannot be skipped. 	<ul style="list-style-type: none"> • Insert a finalized CD-R/CD-RW. • Finalize the CD-R/CD-RW with the component which you used for recording.
	<ul style="list-style-type: none"> • Disc can be neither played back nor ejected. 	<ul style="list-style-type: none"> • Unlock the disc (see page 10). • Eject the disc forcibly (see page 2).
	<ul style="list-style-type: none"> • Disc sound is sometimes interrupted. 	<ul style="list-style-type: none"> • Stop playback while driving on rough roads. • Change the disc. • Check the cords and connections.
MP3/WMA playback	<ul style="list-style-type: none"> • Disc cannot be played back. 	<ul style="list-style-type: none"> • Use a disc with MP3/WMA tracks recorded in the format compliant with ISO 9660 Level 1, Level 2, Romeo, or Joliet. • Add the extension code <.mp3> or <.wma> to the file names.
	<ul style="list-style-type: none"> • Noise is generated. 	Skip to another track or change the disc. (Do not add the extension code <.mp3> or <.wma> to non-MP3 or WMA tracks.)

To be continued...

	Symptoms	Remedies/Causes
MP3/WMA playback	<ul style="list-style-type: none"> • A longer readout time is required (“CHECK” keeps flashing on the display). 	Do not use too many hierarchies and folders.
	<ul style="list-style-type: none"> • Tracks do not play back in the order you have intended them to play. 	Playback order is determined when the files are recorded.
	<ul style="list-style-type: none"> • Elapsed playing time is not correct. 	This sometimes occurs during play. This is caused by how the tracks are recorded on the disc.
	<ul style="list-style-type: none"> • “NO FILES” appears on the display. 	Insert a disc that contains MP3/WMA tracks.
	<ul style="list-style-type: none"> • Correct characters are not displayed (e.g. album name). 	This unit can only display alphabets (upper case), numbers, and a limited number of symbols.
CD changer	<ul style="list-style-type: none"> • “NO DISC” appears on the display. 	Insert a disc into the magazine.
	<ul style="list-style-type: none"> • “NO MAG” appears on the display. 	Insert the magazine.
	<ul style="list-style-type: none"> • “RESET 8” appears on the display. 	Connect this unit and the CD changer correctly and press the reset button of the CD changer.
	<ul style="list-style-type: none"> • “RESET 1” – “RESET 7” appears on the display. 	Press the reset button of the CD changer.
	<ul style="list-style-type: none"> • The CD changer does not work at all. 	Reset the unit (see page 2).

- Microsoft and Windows Media are either registered trademarks or trademarks of Microsoft Corporation in the United States and/or other countries.

AUDIO AMPLIFIER SECTION

Maximum Power Output:

Front: 50 W per channel

Rear: 50 W per channel

Continuous Power Output (RMS):

Front: 19 W per channel into 4 Ω , 40 Hz to 20 000 Hz at no more than 0.8% total harmonic distortion.

Rear: 19 W per channel into 4 Ω , 40 Hz to 20 000 Hz at no more than 0.8% total harmonic distortion.

Load Impedance: 4 Ω (4 Ω to 8 Ω allowance)

Tone Control Range:

Bass: ± 10 dB at 100 Hz

Treble: ± 10 dB at 10 kHz

Frequency Response: 40 Hz to 20 000 Hz

Signal-to-Noise Ratio: 70 dB

Line-Out Level/Impedance:

2.5 V/20 k Ω load (full scale)

Output Impedance: 1 k Ω

Other Terminals:

CD changer, AUX (auxiliary) input jack

TUNER SECTION

Frequency Range:

FM: 87.5 MHz to 108.0 MHz

AM: 531 kHz to 1 602 kHz

[FM Tuner]

Usable Sensitivity: 11.3 dBf (1.0 μ V/75 Ω)

50 dB Quieting Sensitivity:

16.3 dBf (1.8 μ V/75 Ω)

Alternate Channel Selectivity (400 kHz): 65 dB

Frequency Response: 40 Hz to 15 000 Hz

Stereo Separation: 35 dB

Capture Ratio: 1.5 dB

[AM Tuner]

Sensitivity: 20 μ V

Selectivity: 35 dB

CD PLAYER SECTION

Type: Compact disc player

Signal Detection System: Non-contact optical pickup (semiconductor laser)

Number of Channels: 2 channels (stereo)

Frequency Response: 5 Hz to 20 000 Hz

Dynamic Range: 96 dB

Signal-to-Noise Ratio: 98 dB

Wow and Flutter: Less than measurable limit

MP3 Decoding Format:

MPEG1/2 Audio Layer 3

Max. Bit Rate: 320 kbps

WMA (Windows Media[®] Audio) Decoding Format:

Max. Bit Rate: 192 kbps

GENERAL

Power Requirement:

Operating Voltage:

DC 14.4 V (11 V to 16 V allowance)

Grounding System: Negative ground

Allowable Operating Temperature:

0°C to +40°C

Dimensions (W \times H \times D):

Installation Size (approx.):

182 mm \times 52 mm \times 150 mm

Panel Size (approx.):

188 mm \times 58 mm \times 11 mm

Mass (approx.):

1.5 kg (excluding accessories)

Design and specifications are subject to change without notice.



Having TROUBLE with operation?

Please reset your unit

Refer to page of How to reset your unit

หากมีปัญหาในการใช้งาน
กรุณาคัดปุ่มตั้งค่าเริ่มต้นใหม่
กรุณาดูหน้าวิธีตั้งค่าเครื่องใหม่

JVC



EN, TH

© 2005 Victor Company of Japan, Limited

0905DTSMMDTJEIN

JVC KD-G525

Installation/Connection Manual

การติดตั้ง/คู่มือการติดตั้ง

GET0337-006A
[U/UH]

0905DTSMDTJEIN
EN, TH

© 2005 Victor Company of Japan, Limited

ENGLISH

This unit is designed to operate on **12 V DC, NEGATIVE ground electrical systems**. If your vehicle does not have this system, a voltage inverter is required, which can be purchased at JVC car audio dealers.

WARNINGS

To prevent short circuits, we recommend that you disconnect the battery's negative terminal and make all electrical connections before installing the unit.

- **Be sure to ground this unit to the car's chassis again after installation.**

Notes:

- Replace the fuse with one of the specified rating. If the fuse blows frequently, consult your JVC car audio dealers.
- It is recommended to connect to the speakers with maximum power of more than 50 W (both at the rear and at the front, with an impedance of **4 Ω to 8 Ω**). If the maximum power is less than 50 W, change "AMP GAIN" setting to prevent the speakers from being damaged (see page 13 of the INSTRUCTIONS).
- To prevent short-circuit, cover the terminals of the UNUSED leads with insulating tape.
- The heat sink becomes very hot after use. Be careful not to touch it when removing this unit.

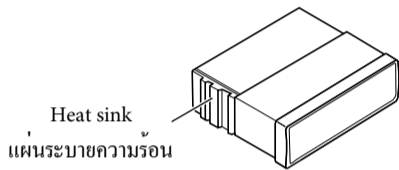

ไทย

ชุดประกอบนี้ได้รับการออกแบบมาเพื่อใช้งานกับระบบ กระแสไฟฟ้าสายดินขั้วลบกระแสตรง **12 โวลต์** หากรถยนต์ของคุณไม่ใช้ระบบนี้ ต้องใช้เครื่องแปลงกระแสไฟด้วย ซึ่งสามารถหาซื้อได้จากร้านขายเครื่องเสียงรถยนต์ JVC

คำเตือน

เพื่อป้องกันการเกิดไฟฟ้าลัดวงจรขอแนะนำให้ปลดขั้วแบตเตอรี่ลบออกแล้วจึงต่อสายไฟก่อนติดตั้งเครื่อง

- ตรวจสอบให้แน่ใจว่าได้เดินสายดินต่อระหว่างเครื่องกับตัวถัง รถยนต์ใหม่แล้วหลังจากติดตั้ง

หมายเหตุ:

- ใช้ฟิวส์เฉพาะแทนฟิวส์ หากฟิวส์ขาดบ่อย ให้ปรึกษา ร้านขายเครื่องเสียงรถยนต์ JVC.
- ขอแนะนำให้ต่อลำโพง ที่มีกำลังขับสูงสุดเกินกว่า 50 W (ทั้งด้านหน้าและด้านหลัง มีความต้านทาน **4 Ω ถึง 8 Ω**) ถ้ากำลังขับต่ำกว่า 50 W ให้เปลี่ยนค่า "AMP GAIN" เพื่อป้องกันไม่ให้ลำโพงชำรุด (ดูหน้า 13 คำแนะนำ)
- การป้องกันการลัดวงจร จะต้องพันขั้วสายตะกั่ว **ที่ไม่ใช้แล้ว** ด้วยเทปพันสายไฟ
- แผ่นระบายความร้อนจะร้อนมากหลังจากใช้ ระวังอย่าไป สัมผัสเมื่อถอดชุดประกอบนี้

PRECAUTIONS on power supply and speaker connections:

- **DO NOT connect the speaker leads of the power cord to the car battery; otherwise, the unit will be seriously damaged.**
- BEFORE connecting the speaker leads of the power cord to the speakers, check the speaker wiring in your car.

ข้อควรระวังสำหรับการต่อแหล่งจ่ายกำลังและลำโพง:

- อย่าต่อสายตะกั่วเคเบิลกำลังของลำโพงเข้ากับแบตเตอรี่รถยนต์ มิฉะนั้น ชุดประกอบจะได้รับความเสียหายมาก
- ก่อนที่จะต่อสายตะกั่วเคเบิลกำลังของลำโพงเข้ากับลำโพง ให้ตรวจสอบการเดินสายไฟลำโพงในรถของคุณให้เรียบร้อยเสียก่อน

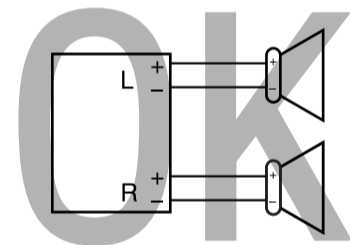
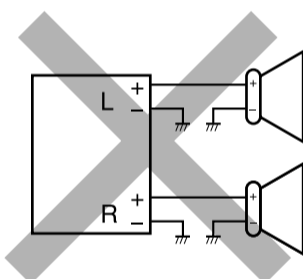
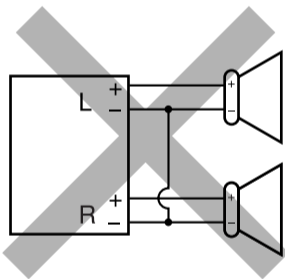

Parts list for installation and connection

The following parts are provided for this unit. After checking them, please set them correctly.

รายการส่วนประกอบสำหรับติดตั้งและเชื่อมต่อกัน

ส่วนประกอบต่อไปนี้ใหม่กับชุดประกอบนี้ หลังจากตรวจสอบแล้ว ปรับตั้งเครื่องให้ถูกต้อง

(A) / (B)
Hard case/Control panel
ลิ้นบรรจุ/หน้าปัด

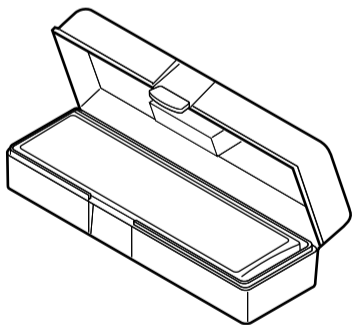

(C)
Sleeve
ปลอกหุ้ม

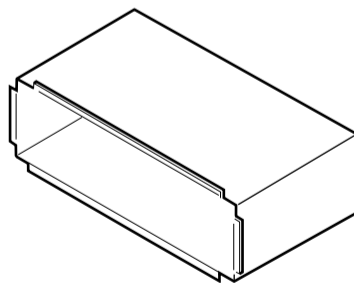

(D)
Trim plate
แผ่นโลหะขอบแต่ง

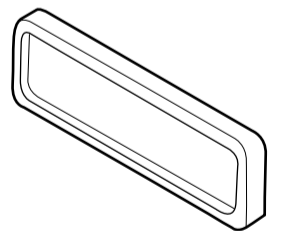

(E)
Power cord
สายเคเบิลกำลัง

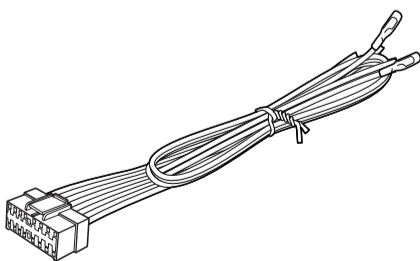

(F)
Washer (ø5)
ประเก็นวงแหวน (ø5)



(G)
Lock nut (M5)
นอตล็อก (M5)



(H)
Mounting bolt (M5 × 20 mm)
สลักติด (M5 × 20 มม.)

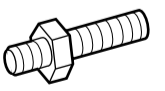

(I)
Rubber cushion
ยางกันกระแทก



(J)
Handles
คันบังคับ

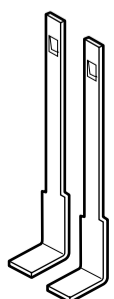

(K)
Remote controller
รีโมทคอนโทรล



RM-RK50

(L)
Battery
แบตเตอรี่



CR2025

INSTALLATION (IN-DASH MOUNTING)

The following illustration shows a typical installation. If you have any questions or require information regarding installation kits, consult your JVC car audio dealers or a company supplying kits.

- If you are not sure how to install this unit correctly, have it installed by a qualified technician.

การติดตั้ง (การประกอบแผงหน้าปัด)

ภาพตัวอย่างต่อไปนี้แสดงถึงการติดตั้งแบบทั่วไป หากคุณมีปัญหาหรือต้องการข้อมูลเกี่ยวกับชุดติดตั้ง กรุณาปรึกษากับผู้ขายเครื่องเสียงรถยนต์ JVC ของท่านหรือบริษัท

- ชุดประกอบ ถ้าคุณไม่แน่ใจว่าติดตั้งชุดประกอบนี้ถูกต้องหรือไม่ ให้หาช่างผู้เชี่ยวชาญเป็นผู้ติดตั้ง

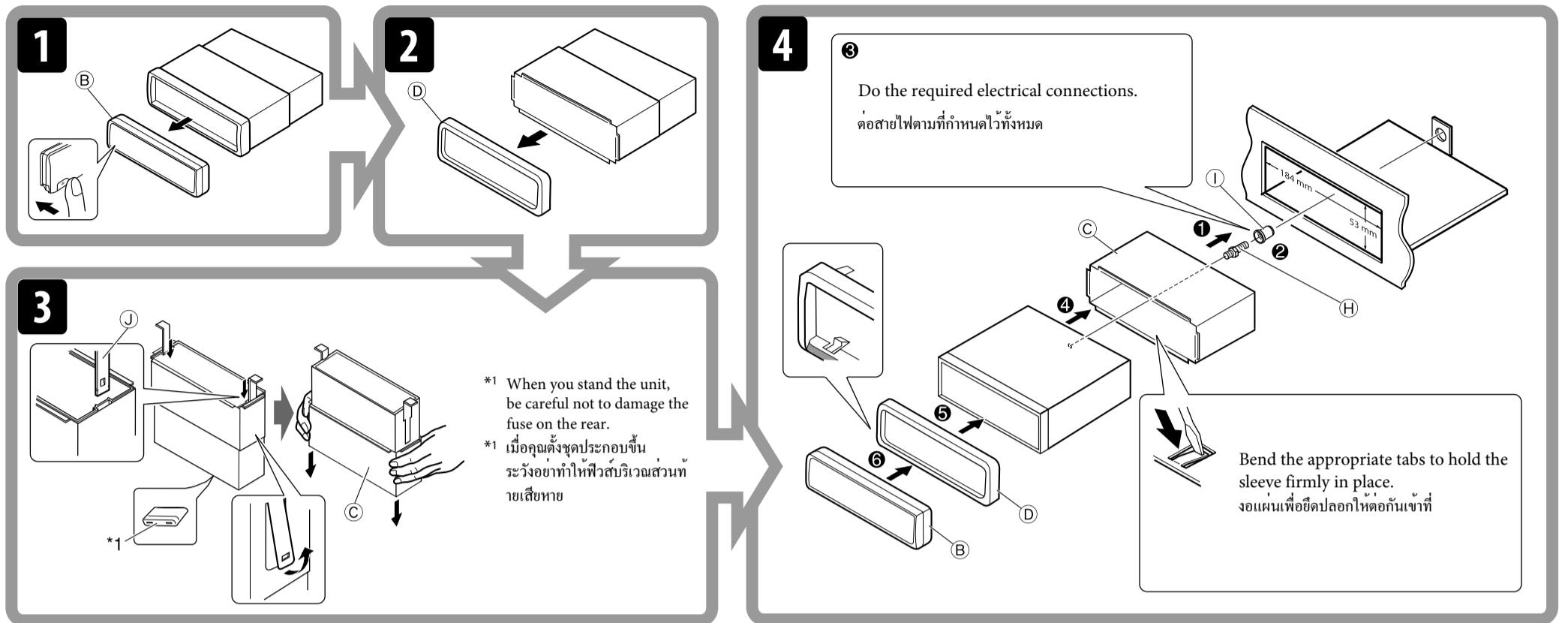

Removing the unit

Before removing the unit, release the rear section.

การถอดชุดประกอบ

ก่อนจะถอดชุดประกอบ ให้ปลดหน้าตัดส่วนท้ายก่อน

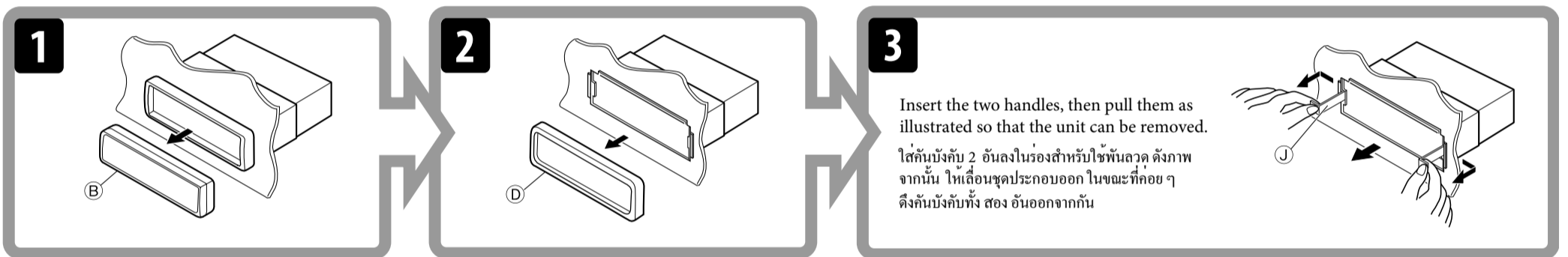

When using the optional stay / เมื่อใช้ตัวยึดแบบเลือกได้

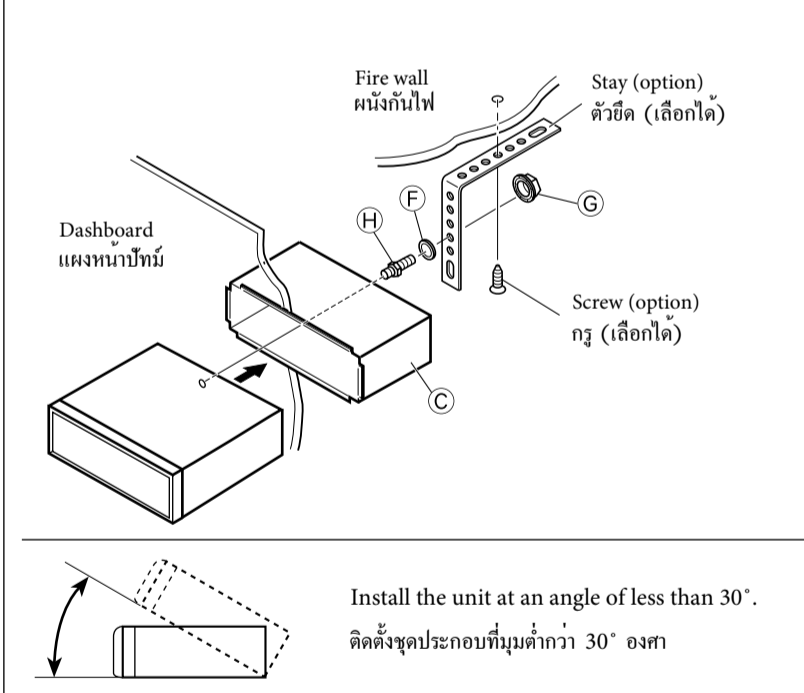

When installing the unit without using the sleeve / เมื่อติดตั้งชุดประกอบโดยไม่ใช้ปลอกหุ้ม

In a Toyota for example, first remove the car radio and install the unit in its place.

ตัวอย่างเช่น ในรถยนต์โตโยต้า ให้ถอดวิทยุติดรถยนต์ออกก่อนและติดตั้งชุดประกอบนี้เข้าไปแทน

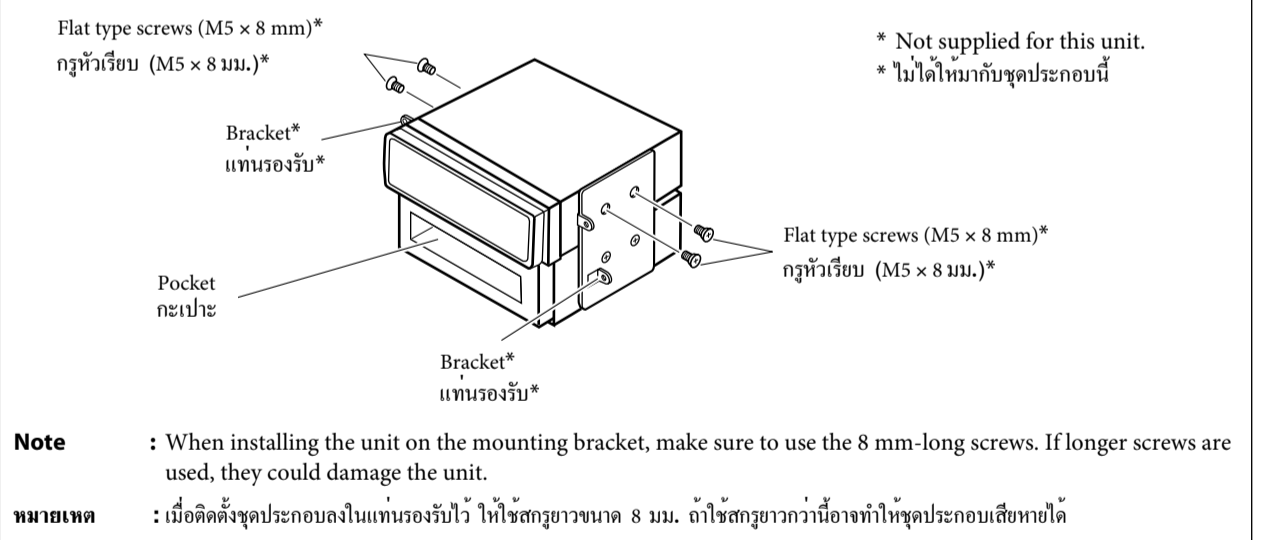

TROUBLESHOOTING

- **The fuse blows.**
* Are the red and black leads connected correctly?
- **Power cannot be turned on.**
* Is the yellow lead connected?
- **No sound from the speakers.**
* Is the speaker output lead short-circuited?
- **Sound is distorted.**
* Is the speaker output lead grounded?
* Are the “-” terminals of L and R speakers grounded in common?
- **Noise interfere with sounds.**
* Is the rear ground terminal connected to the car’s chassis using shorter and thicker cords?
- **This unit becomes hot.**
* Is the speaker output lead grounded?
* Are the “-” terminals of L and R speakers grounded in common?
- **This unit does not work at all.**
* Have you reset your unit?

การตรวจสอบปัญหาขัดข้อง

- **ฟิวส์ขาด**
* มีการเชื่อม ขั้วตะกั่วสีดำและสีแดงอย่างถูกต้องหรือไม่
- **ไม่สามารถเปิดเครื่องได้**
* มีการเชื่อมสายตะกั่วสีเหลืองหรือไม่
- **ไม่มีเสียงออกจากลำโพง**
* สายตะกั่วส่วนที่ออกทางลำโพงเกิดไฟฟ้าลัดวงจรหรือไม่
- **เสียงเพี้ยน**
* สายตะกั่วส่วนที่ออกทางลำโพงต่อลงดินหรือไม่
* สายขั้วลบ “-” ของลำโพงด้านซ้ายและขวาต่อลงดินตามปกติหรือไม่
- **เสียงรบกวน**
* มีการใช้สายสั้นๆ หรือหนาๆ ต่อจากเครื่องส่วนที่ติดตั้ง ไว้บนพื้นด้านหลังกับตัวถังรถยนต์หรือไม่
- **ชุดประกอบร้อนขึ้น**
* สายตะกั่วส่วนที่ออกทางลำโพงต่อลงดินหรือไม่
* สายขั้วลบ “-” ของลำโพงด้านซ้ายและขวาต่อลงดินตามปกติหรือไม่
- **เครื่องรับนี้ทำงานไม่**
* ท่านได้ตั้งเครื่องใหม่แล้วหรือยัง

ELECTRICAL CONNECTIONS

การเชื่อมต่อโดยใช้ไฟฟ้า

A Typical Connections / การเชื่อมต่อแบบปกติ

Before connecting: Check the wiring in the vehicle carefully. Incorrect connection may cause serious damage to this unit.

The leads of the power cord and those of the connector from the car body may be different in color.

- 1 Connect the colored leads of the power cord in the order specified in the illustration below.
- 2 Connect the antenna cord.
- 3 Finally connect the wiring harness to the unit.

ก่อนทำการเชื่อมต่อ: ตรวจสอบสายไฟในรถอย่างละเอียดอย่างระมัดระวังอย่าให้ผิดพลาดโลกาการเชื่อมต่อชุดประกอบชุดที่ภาคเชื่อมต่อผิดพลาดอาจทำให้เกิดความเสียหายร้ายแรงแก่ชุดประกอบ

ถอดที่ได้นัดต่อกับของ ายไฟ และของอุปกรณ์ต่อเชื่อมจากตัวรถ ังคอาจมี ที่ไม่เหมือนกัน

- 1 ต่อสายไฟสีตามลำดับที่ระบุในรูปด้านล่าง
- 2 เชื่อมต่อกับสายอากาศ
- 3 สุดท้าย ต่อส่วนควบคุมการเดินสายไฟเข้ากับชุดประกอบชุดนี้

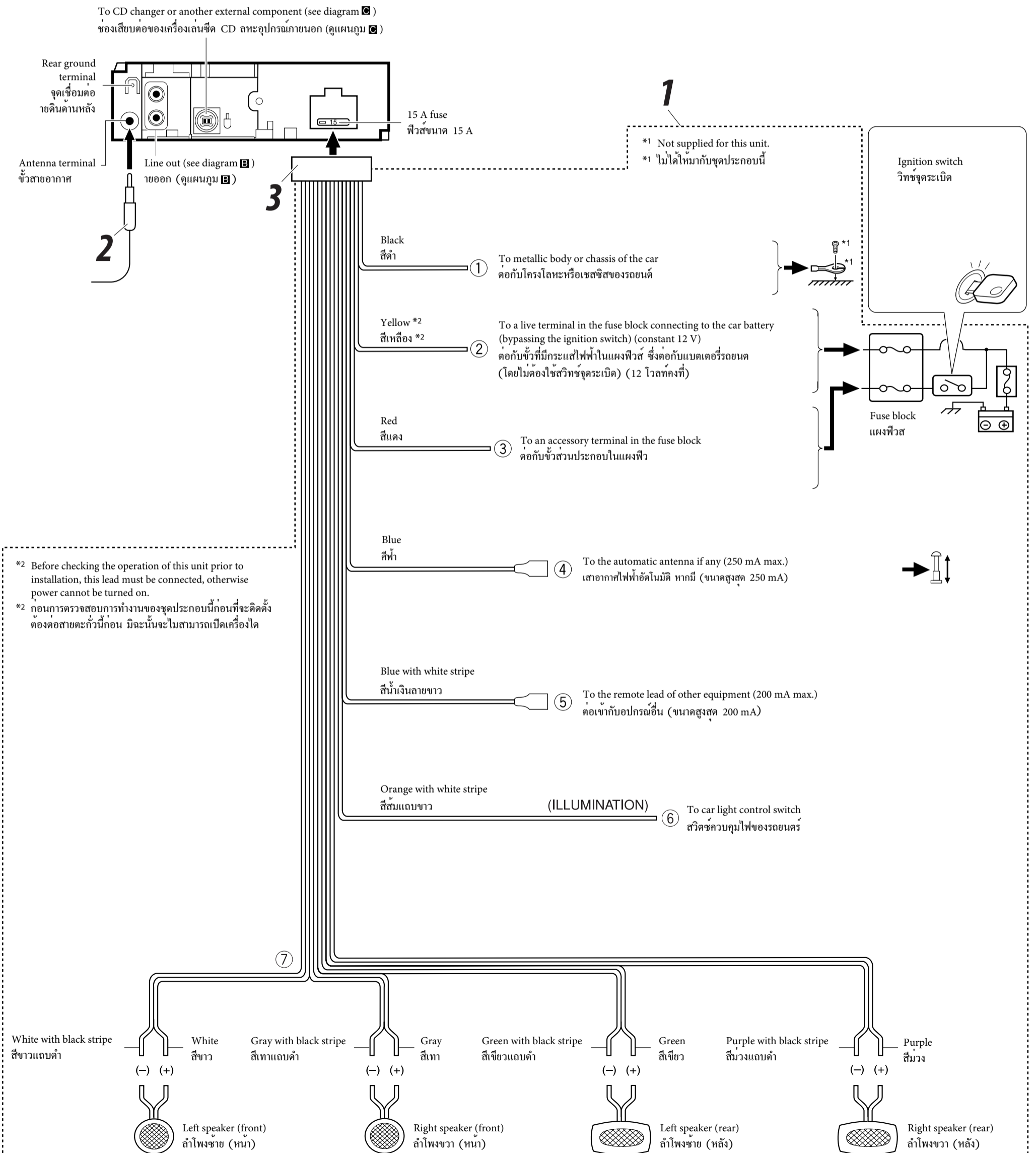

B Connecting the external amplifier / การต่อเพิ่มเติมเข้ากับอุปกรณ์อื่น

You can connect an amplifier to upgrade your car stereo system.

- Connect the remote lead (blue with white stripe) to the remote lead of the other equipment so that it can be controlled through this unit.
- **Disconnect the speakers from this unit, connect them to the amplifier. Leave the speaker leads of this unit unused.**

คุณสามารถต่อกับแอมพลิฟายเออร์ เพื่อเพิ่มคุณภาพเสียงให้กับระบบสเตอริโอของรถยนต์

- ต่อสายตัวกระตุ้น (สีน้ำเงินลายขาว) เข้ากับสายตัวกระตุ้นของอุปกรณ์อื่น ๆ เพื่อจะสามารถควบคุมโดยชุดประกอบนี้ได้
- **ถอดลำโพงออกจากชุดประกอบนี้ แล้วต่อเข้ากับเครื่องขยาย ทั้งสายตัวกระตุ้นลำโพงของชุดประกอบนี้ไว้**

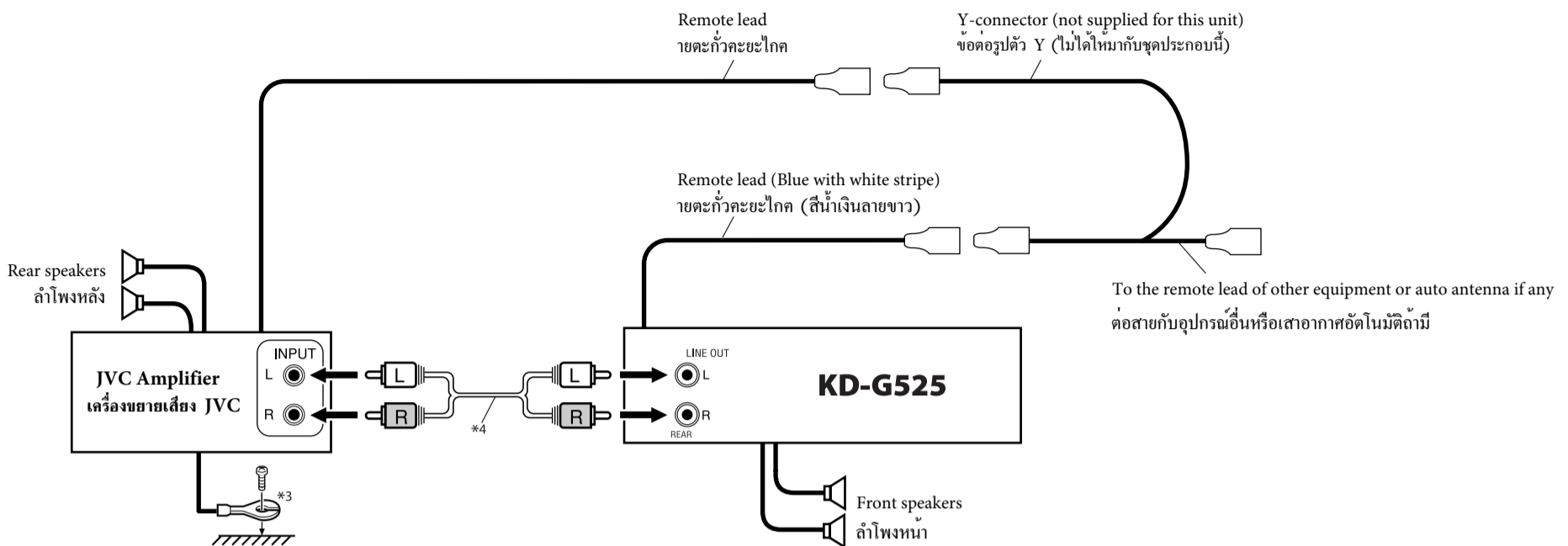

*4 Signal cord (not supplied for this unit)
*4 สายเคเบิลสัญญาณ (ไม่ได้ให้มากับชุดประกอบนี้)

*3 Firmly attach the ground wire to the metallic body or to the chassis of the car—to the place not coated with paint (if coated with paint, remove the paint before attaching the wire). Failure to do so may cause damage to the unit.
*3 ต่อลวดสายดินให้แน่นเข้ากับตัวถังเหล็ก หรือตัวถังรถ—ตรงส่วน ที่ไม่มีสีเคลือบ (หากมีสีเคลือบอยู่ ให้ขูดสีออกก่อน ก่อนต่อลวดสายดิน) หากไม่ปฏิบัติตามคำแนะนำนี้ เครื่องอาจชำรุดหรือเสียหายได้

C Connecting the external components / การต่อเพิ่มเติมเข้ากับอุปกรณ์อื่นๆ

- Set "CHANGER" for the external input setting (see page 13 of the INSTRUCTIONS.) / ตั้งค่า "CHANGER" เป็นการตั้งค่ารับสัญญาณอุปกรณ์ภายนอก (ดูหน้า 13 คำแนะนำ)

CD changer, Apple iPod®, or JVC D. player / CD เชนเจอร์, Apple iPod® หรือเครื่องเล่น JVC D.

You can connect these components as illustrated below.

The iPod*5 or D. player can be connected using an interface adapter (not supplied)—KS-PD100 (for iPod) or KS-PD500 (for D. player).

ท่านสามารถต่ออุปกรณ์ดังกล่าวตามภาพแสดงด้านล่าง

ท่านสามารถเชื่อมต่อ iPod*5 หรือเครื่องเล่น D. โดยใช้อินเทอร์เฟซอะแดปเตอร์ (ไม่มีมาให้)—KS-PD100 (สำหรับ iPod) หรือ KS-PD500 (สำหรับเครื่องเล่น D.)

CAUTION / ข้อควรระวัง:

- Before connecting the external components, make sure that the unit is turned off.
- ก่อนจะเชื่อมต่อกับอุปกรณ์ภายนอก กรุณาตรวจสอบให้แน่ใจว่าปิดเครื่องอยู่

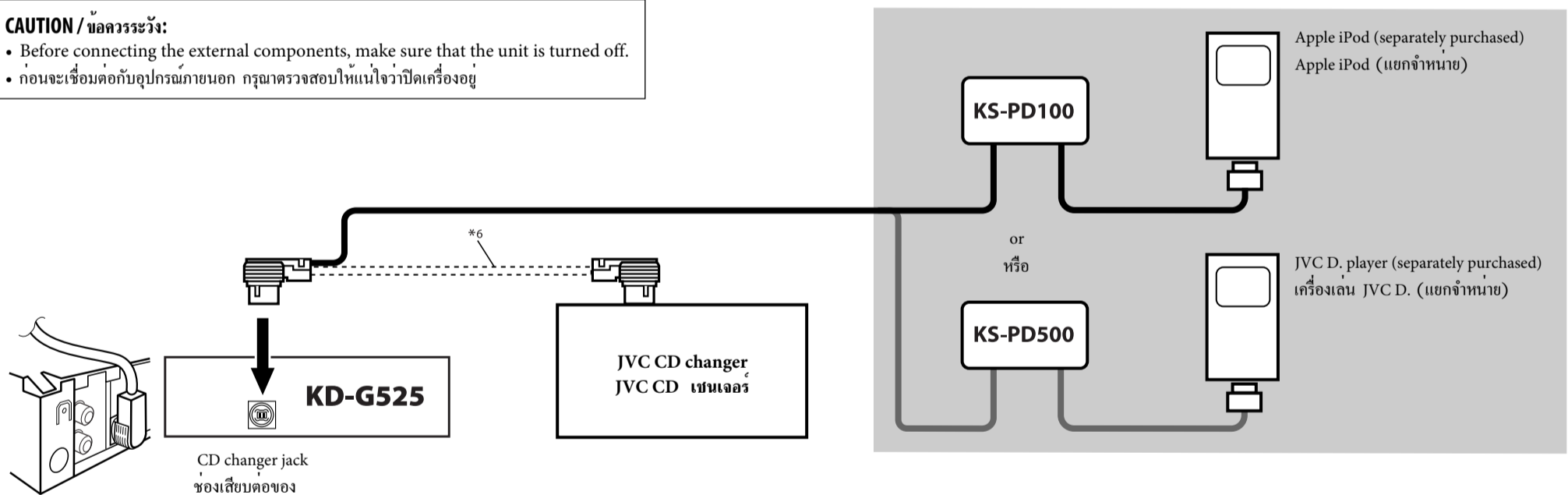

*5 iPod is a trademark of Apple Computer, Inc., registered in the U.S. and other countries.
*5 iPod เป็นเครื่องหมายการค้าของ Apple Computer, Inc. ซึ่งจดทะเบียนการค้าในสหรัฐอเมริกาและประเทศอื่นๆ

*6 Connecting cord supplied for your CD changer
*6 ต่อสายที่ให้มาสำหรับ CD เชนเจอร์

- Set "EXT IN" for the external input setting (see page 13 of the INSTRUCTIONS.) / ตั้งค่า "EXT IN" เป็นการตั้งค่ารับสัญญาณอุปกรณ์ภายนอก (ดูหน้า 13 คำแนะนำ)

External Component / อุปกรณ์ภายนอก

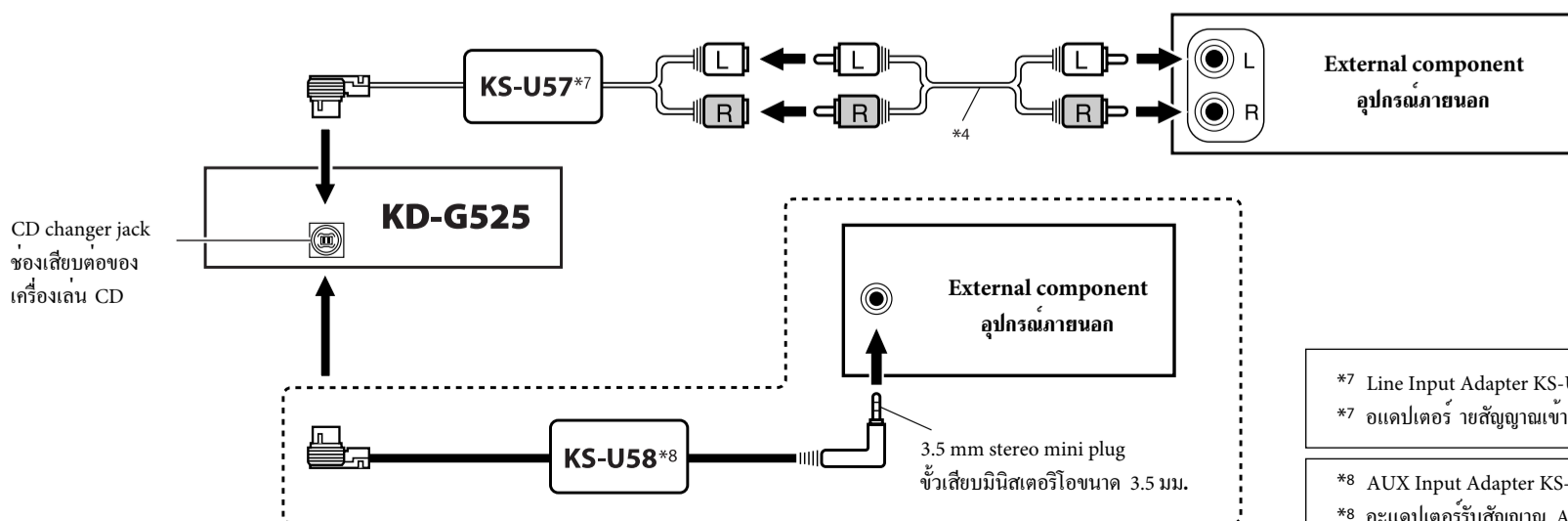

*7 Line Input Adapter KS-U57 (not supplied for this unit)
*7 อะแดปเตอร์ ายสัญญาณเข้า KS-U57 (ไม่ได้ให้มากับชุดประกอบนี้)

*8 AUX Input Adapter KS-U58 (not supplied for this unit)
*8 อะแดปเตอร์รับสัญญาณ AUX รุ่น KS-U58 (ไม่ได้ให้มากับชุดประกอบนี้)

JVC



CD RECEIVER РЕСИВЕР С ПРОИГРЫВАТЕЛЕМ КОМПАКТ-ДИСКОВ

KD-G527

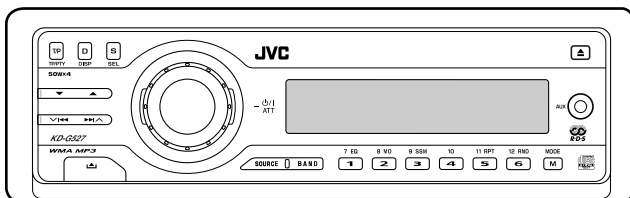
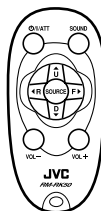
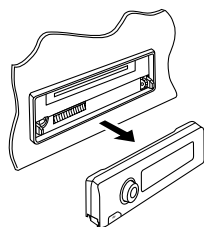

WMA MP3



В соответствии с Законом Российской Федерации “О защите прав потребителей” срок службы (годности) данного товара “по истечении которого он может представлять опасность для жизни, здоровья потребителя, причинять вред его имуществу или окружающей среде” составляет семь (7) лет со дня производства. Этот срок является временем, в течение которого потребитель данного товара может безопасно им пользоваться при условии соблюдения инструкции по эксплуатации данного товара, проводя необходимое обслуживание, включающее замену расходных материалов и/или соответствующее ремонтное обеспечение в специализированном сервисном центре.

Дополнительные косметические материалы к данному товару, поставляемые вместе с ним, могут храниться в течение двух (2) лет со дня его производства.

Срок службы (годности), кроме срока хранения дополнительных косметических материалов, упомянутых в предыдущих двух пунктах, не затрагивает никаких других прав потребителя, в частности, гарантийного свидетельства JVC, которое он может получить в соответствии с законом о правах потребителя или других законов, связанных с ним.

For canceling the display demonstration, see page 6.

Информацию об отмене демонстрации функций дисплея см. на стр. 6.

For installation and connections, refer to the separate manual.

Указания по установке и выполнению соединений приводятся в отдельной инструкции.

INSTRUCTIONS ИНСТРУКЦИИ ПО ЭКСПЛУАТАЦИИ



GET0340-001A

[EE]

Thank you for purchasing a JVC product.

Please read all instructions carefully before operation, to ensure your complete understanding and to obtain the best possible performance from the unit.

IMPORTANT FOR LASER PRODUCTS

1. CLASS 1 LASER PRODUCT
2. **CAUTION:** Do not open the top cover. There are no user serviceable parts inside the unit; leave all servicing to qualified service personnel.
3. **CAUTION:** Visible and invisible laser radiation when open and interlock failed or defeated. Avoid direct exposure to beam.
4. REPRODUCTION OF LABEL: CAUTION LABEL, PLACED OUTSIDE THE UNIT.

CAUTION: Visible and invisible laser radiation when open and interlock failed or defeated. AVOID DIRECT EXPOSURE TO BEAM. (e)	ADVARSEL: Synlig og usynlig laserstråling når maskinen er åpen eller interlocken fejler. Undgå direkte eksponering til stråling. (d)	WARNING: Synlig och osynlig laserstråling när elen öppnas och spärren är urkopplad. Betrakta strålen. (s)	VARO: Avarbassa ja suojalukitus ohitettuna tai viallisena olet alttina näkyvälle ja näkymättömälle lasersäteilylle. Vältä säteen kohdistumista suoraan itseesi. (f)
--	---	--	--

How to reset your unit

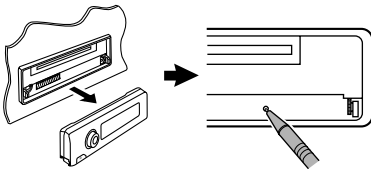

Your preset adjustments will also be erased.

How to forcibly eject a disc



“PLEASE” and “EJECT” appear alternately on the display.

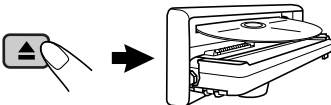

- If this does not work, reset your unit.
- Be careful not to drop the disc when it ejects.

How to detach/attach the control panel

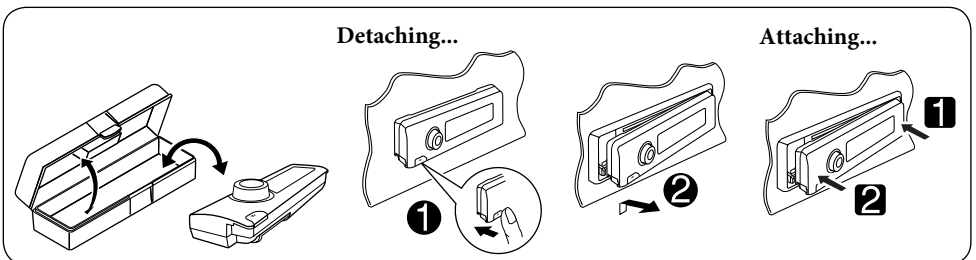

How to use the M MODE button

If you press M MODE, the unit goes into functions mode, then the number buttons and ▲/▼ buttons work as different function buttons.

Ex.: When number button 2 works as MO (monaural) button.

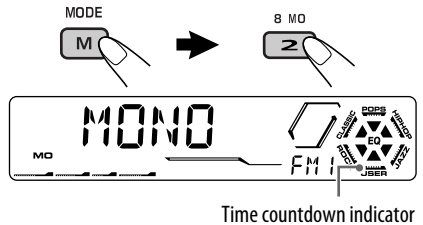





To use these buttons for their original functions again after pressing M MODE, wait for 5 seconds without pressing any of these buttons until the functions mode is cleared or press M MODE again.

CONTENTS



Control panel	4
Remote controller — RM-RK50	5
Getting started.....	6
Basic operations.....	6
Radio operations	7
FM RDS operations.....	8
Searching for your favorite FM RDS programme ...	8
Disc operations.....	10
Playing a disc in the unit	10
Playing discs in the CD changer	10
Sound adjustments.....	13
General settings — PSM	14
External component operations	17
DAB tuner operations.....	18
More about this unit	19
Maintenance	22
Troubleshooting.....	23
Specifications	25

How to read this manual

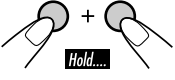
- Button operations are mainly explained with the illustrations in the table below.
- Some related tips and notes are explained in “More about this unit” (see pages 19 – 21).

	Press briefly.
	Press repeatedly.
	Press either one.
	Press and hold until your desired response begins.
	Press and hold both buttons at the same time.

The following marks are used to indicate...

-  : Built-in CD player operations.
-  : External CD changer operations.
-  : Indicator displayed for the corresponding operation.

Warning:

If you need to operate the unit while driving, be sure to look ahead carefully or you may be involved in a traffic accident.

Caution on volume setting:

Discs produce very little noise compared with other sources. Lower the volume before playing a disc to avoid damaging the speakers by the sudden increase of the output level.

For safety...

- Do not raise the volume level too much, as this will block outside sounds, making driving dangerous.
- Stop the car before performing any complicated operations.

Temperature inside the car...

If you have parked the car for a long time in hot or cold weather, wait until the temperature in the car becomes normal before operating the unit.

Control panel

Parts identification

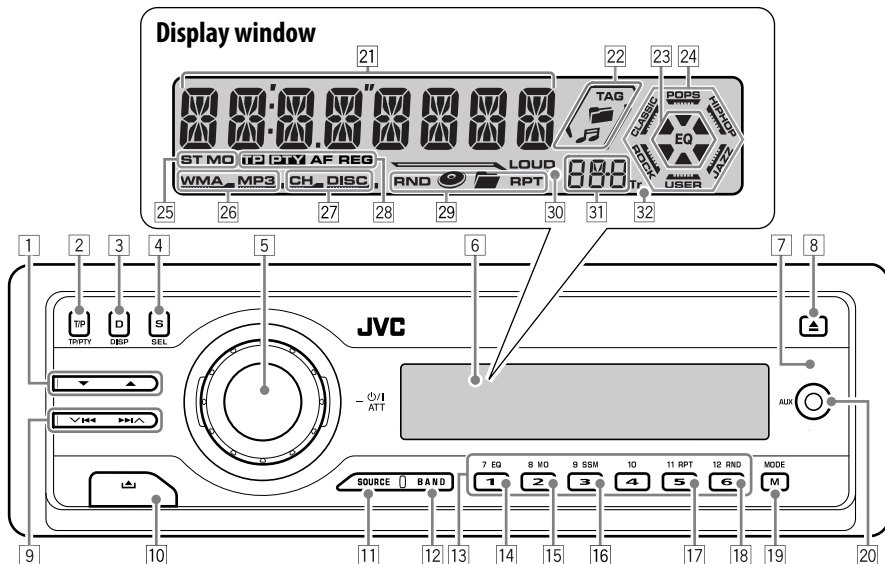

- 1 ▲ (up) / ▼ (down) buttons
- 2 T/P TP/PTY (traffic programme/ programme type) button
- 3 D DISP (display) button
- 4 S SEL (select) button
- 5 • Control dial
 - Φ /I ATT (standby/on attenuator) button
- 6 Display window
- 7 Remote sensor
 - **DO NOT** expose the remote sensor to strong light (direct sunlight or artificial lighting).
- 8 ▲ (eject) button
- 9 ▼ ◀▶▶▶ ▲ buttons
- 10 ▲ (control panel release) button
- 11 SOURCE button
- 12 BAND button
- 13 Number buttons
- 14 EQ (equalizer) button
- 15 MO (monaural) button
- 16 SSM (Strong-station Sequential Memory) button
- 17 RPT (repeat) button
- 18 RND (random) button
- 19 M MODE button
- 20 AUX (auxiliary) input jack

Display window

- 21 Main display
- 22 Disc information indicators—TAG (ID3 Tag), (folder), (track/file)
- 23 EQ (equalizer) indicator
- 24 Sound mode (C-EQ: custom equalizer) indicators—ROCK, CLASSIC, POPS, HIP HOP, JAZZ, USER
 - also works as the time countdown indicator and level meter during play (see page 16).
- 25 Tuner reception indicators—ST (stereo), MO (monaural)
- 26 Disc type indicators—WMA, MP3
- 27 Playback source indicators—CH: *Lights up only when CD-CH is selected as the playback source.* DISC: *Lights up for the built-in CD player.*
- 28 RDS indicators—TP, PTY, AF, REG
- 29 Playback mode / item indicators—RND (random), (disc), (folder), RPT (repeat)
- 30 LOUD (loudness) indicator
- 31 Source display / Volume level indicator
- 32 Tr (track) indicator

Installing the lithium coin battery (CR2025)

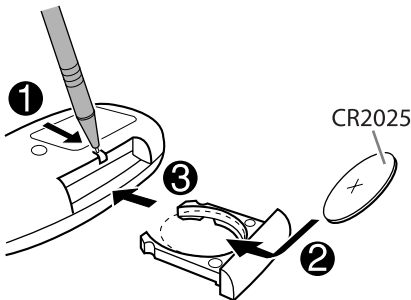

Aim the remote controller directly at the remote sensor on the unit. Make sure there is no obstacle in between.

Warning:

- Do not install any battery other than CR2025 or its equivalent; otherwise, it may explode.
- Store the battery in a place where children cannot reach to avoid risk of accident.
- To prevent the battery from over-heating, cracking, or starting a fire:
 - Do not recharge, short, disassemble, heat the battery, or dispose of it in a fire.
 - Do not leave the battery with other metallic materials.
 - Do not poke the battery with tweezers or similar tools.
 - Wrap the battery with tape and insulate when throwing away or saving it.

Caution:

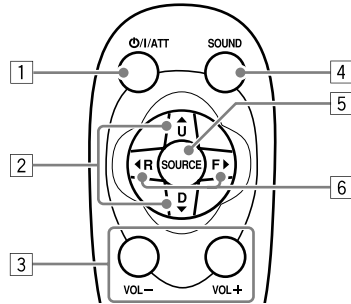
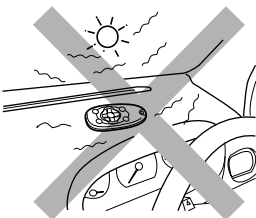

- 1 **⏻/I/ATT** (standby/on/attenuator) button
 - Turns the power on if pressed briefly or attenuates the sound when power is on.
 - Turns the power off if pressed and held.
- 2 **▲ U (up) / D (down) ▼** buttons
 - Changes the FM/AM/DAB bands with ▲ U only.
 - Changes the preset stations (or services) with D ▼ only.
 - Changes the folder of the MP3/WMA discs.
 - While playing an MP3 disc on an MP3-compatible CD changer:
 - Changes the disc if pressed briefly.
 - Changes the folder if pressed and held.
- 3 **VOL - / VOL +** buttons
 - Adjusts the volume level.
- 4 **SOUND** button
 - Selects the sound mode (C-EQ: custom equalizer).
- 5 **SOURCE** button
 - Selects the source.
- 6 **◀ R (reverse) / F (forward) ▶** buttons
 - Searches for stations (or services) if pressed briefly.
 - Searches for ensembles if pressed and held.
 - Fast-forwards or reverses the track if pressed and held.
 - Changes the tracks of the disc if pressed briefly.

Getting started

Basic operations

- 1** Turn on the power.

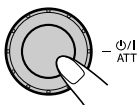

2

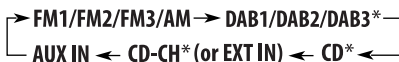

- Select “CD-CH” when using an Apple iPod® or a JVC D. player (see page 17).

iPod is a trademark of Apple Computer, Inc., registered in the U.S. and other countries.

* You cannot select these sources if they are not ready.

3

- For FM/AM tuner



- For DAB tuner



4

- Adjust the volume.

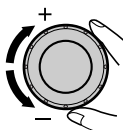

Volume level appears.



Volume level indicator

- 5** Adjust the sound as you want. (See pages 13 and 14.)

To drop the volume in a moment (ATT)

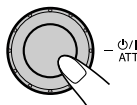

To restore the sound, press it again.

To turn off the power

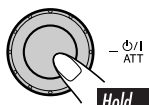

Basic settings

- See also “General settings — PSM” on pages 14 – 16.

1



2

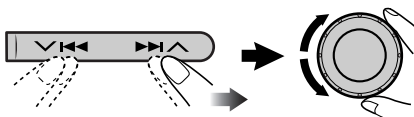

- 1** Canceling the display demonstrations

Select “DEMO,” then “DEMO OFF.”

- 2** Setting the clock

Select “CLOCK H” (hour), then adjust the hour.

Select “CLOCK M” (minute), then adjust the minute.

Select “24H/12H,” then “24H” (hour) or “12H” (hour).

- 3** Finish the procedure.



To check the current clock time when the power is turned off



Radio operations

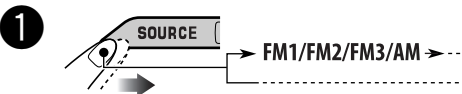

Lights up when receiving an FM stereo broadcast with sufficient signal strength.

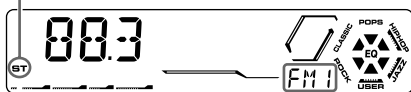

Selected band appears.

3 Start searching for a station.

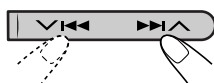

When a station is received, searching stops.

To stop searching, press the same button again.

Note:

FM1 and FM2: 87.5 MHz – 108.0 MHz
 FM3: 65.00 MHz – 74.00 MHz

To tune in to a station manually

In step 3 above...

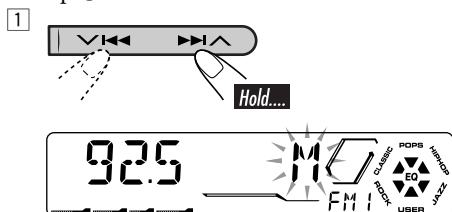

2 Select the desired station frequencies.

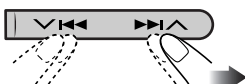

When an FM stereo broadcast is hard to receive

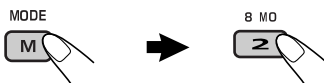

Lights up when monaural mode is activated.

Reception improves, but stereo effect will be lost.

To restore the stereo effect, repeat the same procedure. “MONO OFF” appears and the MO indicator goes off.

Storing stations in memory

You can preset six stations for each band.

FM station automatic presetting—SSM (Strong-station Sequential Memory)

1 Select the FM band (FM1 – FM3) you want to store into.



“SSM” flashes, then disappears when automatic presetting is over.

Local FM stations with the strongest signals are searched and stored automatically in the FM band.

Manual presetting

Ex.: Storing FM station of 92.5 MHz into preset number 4 of the FM1 band.

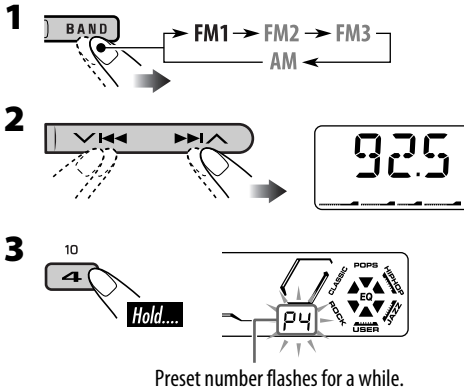

Listening to a preset station

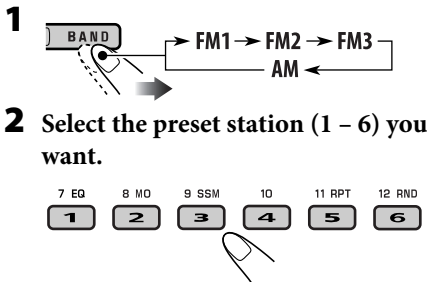

To check the current clock time while listening to an FM (non-RDS) or AM station

- For FM RDS stations, see page 10.



FM RDS operations

What you can do with RDS

RDS (Radio Data System) allows FM stations to send an additional signal along with their regular programme signals.

By receiving the RDS data, this unit can do the following:

- Programme Type (PTY) Search (see the following)
- TA (Traffic Announcement) and PTY Standby Receptions (see pages 9 and 15)
- Tracing the same programme automatically —Network-Tracking Reception (see page 10)
- Programme Search (see page 15)

Searching for your favorite FM RDS programme

You can tune in to a station broadcasting your favorite programme by searching for a PTY code.

- To store your favorite programme types, see page 9.

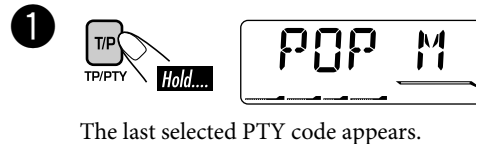

2 Select one of your favorite programme types.

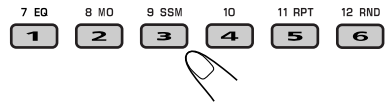

or

Select one of the PTY codes (see page 10).

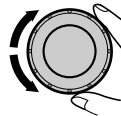

- Start searching for your favorite programme.

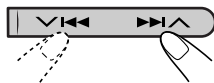

If there is a station broadcasting a programme of the same PTY code as you have selected, that station is tuned in.

Storing your favorite programme types

You can store six favorite programme types.

Preset programme types in the number buttons (1 to 6):

1	2	3	4	5	6
POP M	ROCK M	EASY M	CLASSICS	AFFAIRS	VARIED

- Select a PTY code (see page 8).
- Select the preset number (1 – 6) you want to store into.



Ex.: When "ROCK M" is selected

- Repeat steps 1 and 2 to store other PTY codes into other preset numbers.
- Finish the procedure.



Using the standby receptions

TA Standby Reception

TA Standby Reception allows the unit to switch temporarily to Traffic Announcement (TA) from any source other than AM.

The volume changes to the preset TA volume level (see page 15).

To activate TA Standby Reception



The TP (Traffic Programme) indicator either lights up or flashes.

- If the TP indicator lights up, TA Standby Reception is activated.
- If the TP indicator flashes, TA Standby Reception is not yet activated. (This occurs when you are listening to an FM station without the RDS signals required for TA Standby Reception.)

To activate TA Standby Reception, tune in to another station providing these signals. The TP indicator will stop flashing and remain lit.

To deactivate the TA Standby Reception



The TP indicator goes off.

PTY Standby Reception

PTY Standby Reception allows the unit to switch temporarily to your favorite PTY programme from any source other than AM.

To activate and select your favorite PTY code for PTY Standby Reception, see page 15.

The PTY indicator either lights up or flashes.

- If the PTY indicator lights up, PTY Standby Reception is activated.
- If the PTY indicator flashes, PTY Standby Reception is not yet activated. To activate PTY Standby Reception, tune in to another station providing these signals. The PTY indicator will stop flashing and remain lit.

To deactivate the PTY Standby Reception, select "OFF" for the PTY code (see page 15). The PTY indicator goes off.

Tracing the same programme— Network-Tracking Reception

When driving in an area where FM reception is not sufficient enough, this unit automatically tunes in to another FM RDS station of the same network, possibly broadcasting the same programme with stronger signals (see the illustration below).

When shipped from the factory, Network-Tracking Reception is activated.

To change the Network-Tracking Reception setting, see “AF-REG” on page 15.

Programme A broadcasting on different frequency areas (01 – 05)

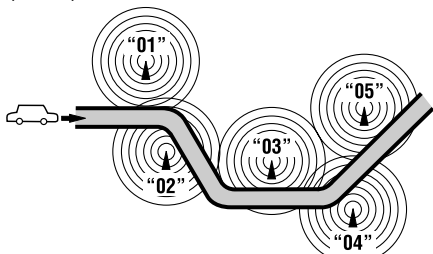

To check the current clock time while listening to an FM RDS station



Station name (PS) → Station Frequency → Programme type (PTY) → Clock → (back to the beginning)

PTY codes

NEWS, AFFAIRS, INFO, SPORT, EDUCATE, DRAMA, CULTURE, SCIENCE, VARIED, POP M (music), ROCK M (music), EASY M (music), LIGHT M (music), CLASSICS, OTHER M (music), WEATHER, FINANCE, CHILDREN, SOCIAL, RELIGION, PHONE IN, TRAVEL, LEISURE, JAZZ, COUNTRY, NATION M (music), OLDIES, FOLK M (music), DOCUMENT

Disc operations

Playing a disc in the unit

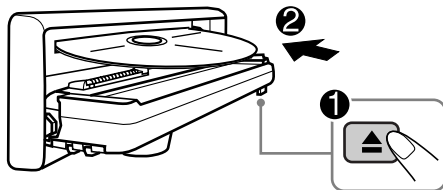

All tracks will be played repeatedly until you change the source or eject the disc.

To stop play and eject the disc



Playing discs in the CD changer

All discs in the magazine will be played repeatedly until you change the source.

- Ejecting the magazine will also stop playing.

1

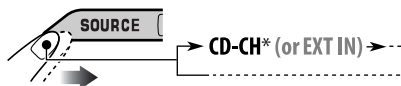

* If you have changed “EXT IN” setting to “EXT IN” (see page 16), you cannot select the CD changer.

See also page 17 when using an iPod or JVC D. player.

2

Select a disc.

For disc number from 01 – 06:



For disc number from 07 – 12:



Hold....

About MP3 and WMA discs

MP3 and WMA “tracks” (words “file” and “track” are used interchangeably) are recorded in “folders.”

About the CD changer

It is recommended to use a JVC MP3-compatible CD changer with your unit.

- You can also connect other CH-X series CD changers (except CH-X99 and CH-X100). These units are not compatible with MP3 discs.
- You cannot play any WMA disc in the CD changer.
- You cannot use the KD-MK series CD changers with this unit.
- Disc text information recorded in the CD Text can be displayed when a JVC CD Text compatible CD changer is connected.
- For connection, see Installation/Connection Manual (separate volume).

To fast-forward or reverse the track



To go to the next or previous tracks



To go to the next or previous folders (only for MP3 or WMA discs)

For MP3 discs:  

For WMA discs: 

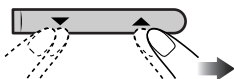

To locate a particular track (for CD) or folder (for MP3 or WMA discs) directly



To select a number from 01 – 06:

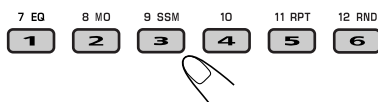

To select a number from 07 – 12:

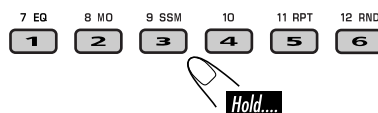

- To use folder search on MP3/WMA discs, it is required that folders are assigned with 2-digit numbers at the beginning of their folder names—01, 02, 03, and so on.

- To select a particular track in a folder (for MP3 or WMA disc):

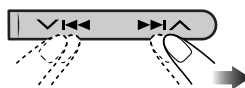

Other main functions

■ Skipping a track quickly during play



Only possible on JVC
MP3-compatible CD changer

- For MP3 or WMA disc, you can skip a track within the same folder.

Ex.: To select track 32 while playing track 6



Each time you press the button, you can skip 10 tracks.

- After the last track, the first track will be selected and vice versa.



■ Prohibiting disc ejection



You can lock a disc in the loading slot.

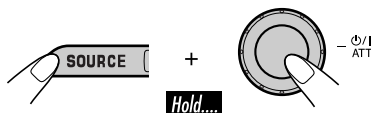

To cancel the prohibition, repeat the same procedure.



Changing the display information



■ While playing an audio CD or a CD Text



■ While playing an MP3 or WMA^{*2} disc

- When "TAG DISP" is set to "TAG ON"
(see page 16)

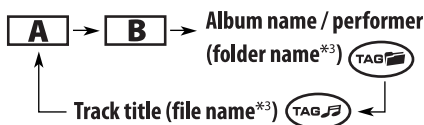

- When "TAG DISP" is set to "TAG OFF"

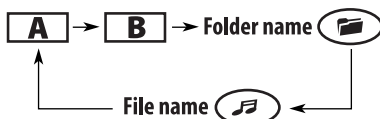

A : Elapsed playing time with the current track number

B : Clock with the current track number

*1 If the current disc is an audio CD, "NO NAME" appears.

*2 Only for the built-in CD player.

*3 If an MP3/WMA file does not have ID3 tags, folder name and file name appear. In this case, the TAG indicator will not light up.

Selecting the playback modes

You can use only one of the following playback modes at a time.

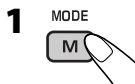

2 Select your desired playback mode.

Repeat play

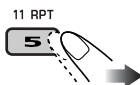

Mode	Plays repeatedly
TRK RPT	: The current track.
FLDR RPT *1	: All tracks of the current folder.
DISC RPT *2	: All tracks of the current disc.
RPT OFF	: Cancels.

Random play

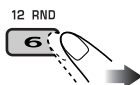

Mode	Plays at random
FLDR RND *1	: All tracks of the current folder, then tracks of the next folder and so on.
DISC RND	: All tracks of the current disc.
MAG RND *2	: All tracks of the inserted discs.
RND OFF	: Cancels.

*1 Only while playing an MP3 or WMA disc.

*2 Only while playing discs in the CD changer.

Sound adjustments

You can select a preset sound mode suitable to the music genre (C-EQ: custom equalizer).

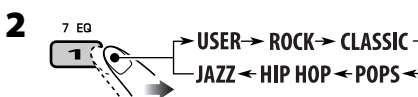
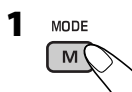

Preset values	BAS (bass)	TRE (treble)	LOUD (loudness)
USER (Flat sound)	00	00	OFF
ROCK (Rock or disco music)	+03	+01	ON
CLASSIC (Classical music)	+01	-02	OFF
POPS (Light music)	+04	+01	OFF
HIP HOP (Funk or rap music)	+02	00	ON
JAZZ (Jazz music)	+02	+03	OFF

Adjusting the sound

You can adjust the sound characteristics to your preference.

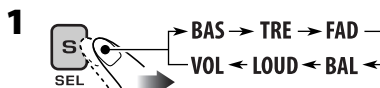

To be continued...

2



Indication pattern changes as you adjust the level.

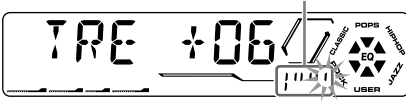

Ex.: When "TRE" is selected

Indication [Range]

BAS*1 (bass)

Adjust the bass. [-06 to +06]

TRE*1 (treble)

Adjust the treble. [-06 to +06]

FAD*2 (fader)

Adjust the front and rear speaker balance.
[R06 to F06]

BAL (balance)

Adjust the left and right speaker balance.
[L06 to R06]

LOUD*1 (loudness)

Boost low and high frequencies to produce a well-balanced sound at low volume level.
[LOUD ON or LOUD OFF]

VOL (volume)

Adjust the volume. [00 to 30 or 50*3]

*1 When you adjust the bass, treble, or loudness, the adjustment you have made is stored for the currently selected sound mode (C-EQ) including "USER."

*2 If you are using a two-speaker system, set the fader level to "00."

*3 Depending on the amplifier gain control setting. (See page 16 for details.)

General settings — PSM

You can change PSM (Preferred Setting Mode) items listed in the table that follows.

1



2 Select a PSM item.

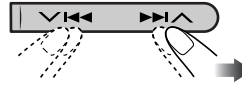

Ex.: When you select "DIMMER"

3 Adjust the PSM item selected.

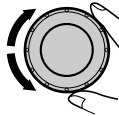

4 Repeat steps 2 and 3 to adjust the other PSM items if necessary.

5 Finish the procedure.



Indications	Selectable settings, [reference page]
DEMO Display demonstration	DEMO ON : [Initial]; Display demonstration will be activated automatically if no operation is done for about 20 seconds, [6]. DEMO OFF : Cancels.
CLOCK H Hour adjustment	0 – 23 (1 – 12), [6] [Initial: 0 (0:00)]
CLOCK M Minute adjustment	00 – 59, [6] [Initial: 00 (0:00)]
24H/12H Time display mode	12H $\overline{\text{---}}$ 24H, [6] [Initial: 24H]
CLK ADJ Clock adjustment	AUTO : [Initial]; The built-in clock is automatically adjusted using the CT (clock time) data in the RDS signal. OFF : Cancels.
AF-REG *5 Alternative frequency/ regionalization reception	When the received signals from the current FM RDS station or DAB service become weak... AF : [Initial]; Switches to another station (or service) (the programme may differ from the one currently received), [10, 19]. • The AF indicator lights up. AF REG : Switches to another station broadcasting the same programme. • The AF and REG indicators light up. OFF : Cancels (not selectable when “DAB AF” is set to “AF ON”).
PTY-STBY *5 PTY standby	Activates PTY Standby Reception with one of the PTY codes, [9]. OFF [Initial] → PTY codes, [10] → (back to the beginning)
TA VOL Traffic announcement volume	[Initial: VOL 15]; VOL 00 — VOL 30 or 50*4, [9]
P-SEARCH *5 Programme search	ON : Using the AF data, the unit tunes in to another frequency broadcasting the same programme as the original preset RDS station is if the preset station signals are not sufficient. OFF : [Initial]; Cancels.
DAB AF *6 Alternative frequency reception	AF ON : [Initial]; Traces the programme among DAB services and FM RDS stations, [10, 19]. AF OFF : Cancels.

*4 Depends on the amplifier gain control.

*5 Only for FM RDS stations.

*6 Displayed only when DAB tuner is connected.

To be continued...

Indications	Selectable settings, [reference page]
DAB VOL *1 DAB volume adjustment	You can adjust the volume level (VOL -12 — VOL +12) of DAB tuner to match the FM sound level and store it in memory. [Initial: VOL 00]
LEVEL Audio level meter	ON : [Initial]; Activates the audio level indicator. OFF : Cancels; sound mode indicator is shown.
DIMMER Dimmer	AUTO : [Initial]; Dims the display when you turn on the headlights. ON : Activates dimmer. OFF : Cancels.
TEL Telephone muting	MUTING 1/MUTING 2 : Select either one which mutes the sounds while using the cellular phone. OFF : [Initial]; Cancels.
SCROLL *2 Scroll	ONCE : [Initial]; Scrolls the disc information once. AUTO : Repeats scrolling (5-second intervals in between). OFF : Cancels. • Pressing D DISP for more than one second can scroll the display regardless of the setting.
EXT IN *3 External input	CHANGER : [Initial]; To use a JVC CD changer, [10], an Apple iPod, a JVC D. player, [17], and/or DAB tuner, [18]. EXT IN : To use another external component, [17].
AUX ADJ Auxiliary input level adjustment	A.ADJ 00 – A.ADJ 05 : Adjust the auxiliary input level to avoid the sudden increase of the output level when changing the source from external component connected to the AUX input jack on the control panel. [Initial: A.ADJ 00]
TAG DISP Tag display	TAG ON : [Initial]; Shows the ID3 tag while playing MP3/WMA tracks, [12]. TAG OFF : Cancels.
AMP GAIN Amplifier gain control	You can change the maximum volume level of this unit. LOW PWR : VOL 00 – VOL 30 (Select this if the maximum power of the speaker is less than 50 W to prevent them from damaging the speaker.) HIGH PWR : [Initial]; VOL 00 – VOL 50

*1 Displayed only when DAB tuner is connected.

*2 Some characters or symbols will not be shown correctly (or will be blanked) on the display.

*3 Displayed only when one of the following sources is selected—FM, AM, CD, or AUX IN.

External component operations

You can connect an external component to...

- CD changer jack on the rear using:
 - Line Input Adapter—KS-U57 (not supplied) or AUX Input Adapter—KS-U58 (not supplied) for any other components (except iPod and D. player).
 - Interface adapter for iPod®—KS-PD100 (not supplied) for controlling iPod.
 - D. player interface adapter—KS-PD500 (not supplied) for controlling D. player.
- AUX (auxiliary) input jack on the control panel.

For connection, see Installation/Connection Manual (separate volume).

Connecting an external component to the AUX input jack

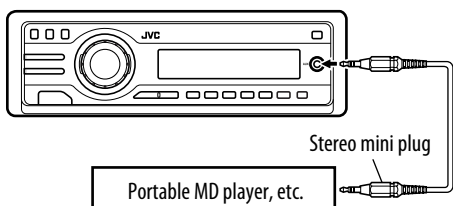

- 1 For selecting the external component connected to...
 - AUX input jack

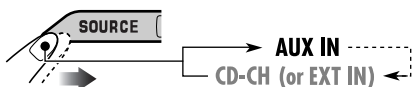

- CD changer jack on the rear using KS-U57 or KS-U58
If "EXT IN" does not appear, see page 16 and select the external input ("EXT IN").

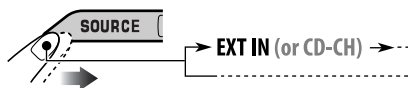

- CD changer jack on the rear using interface adapter for iPod—KS-PD100 or for D. player—KS-PD500

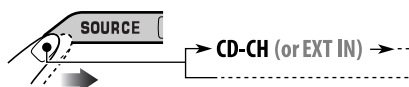

- 2 Turn on the connected component and start playing the source.

- 3 Adjust the volume.

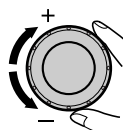

- 4 Adjust the sound as you want. (See pages 13 and 14.)

To check the clock time while listening to an external component



AUX IN, EXT IN, or CD-CH* ↔ Clock

* See "While playing an MP3 or WMA disc" on page 12 for details.

DAB tuner operations

What is DAB system?

Digital Audio Broadcasting (DAB) can deliver digital quality sound without any annoying interference and signal distortion. Furthermore, it can carry text, pictures, and data. When transmitting, DAB combines several programmes (called “services”) to form one “ensemble.” In addition, each “service”—called “primary service”—can also be divided into its components (called “secondary service”). A typical ensemble has six or more programmes (services) broadcast at the same time.

By connecting the DAB tuner, this unit can do the following:

- Tracing the same programme automatically —Alternative Frequency Reception (see “DAB AF” on page 15).

It is recommended to use DAB tuner KT-DB1000 with your unit. If you have another DAB tuner, consult your JVC IN-CAR ENTERTAINMENT dealer.

- Refer also to the Instructions supplied for your DAB tuner.

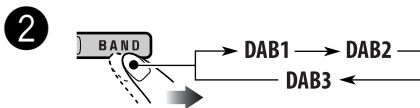
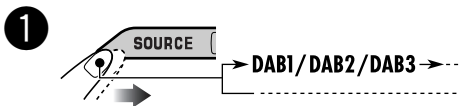

3 Start searching for an ensemble.

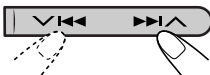

When an ensemble is received, searching stops.

To stop searching, press the same button again.

4 Select a service (either primary or secondary) to listen to.

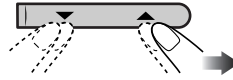

To tune in to an ensemble manually

Start searching for an ensemble, as in step 3 on the left column...

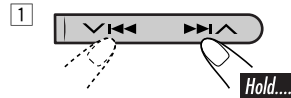

2 Select the desired ensemble frequencies.

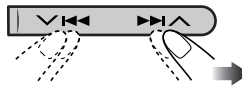

Storing DAB services in memory

You can preset six DAB services (primary) for each band.

1 Select a service you want (see steps 1 to 4 above).

2 Select the preset number (1 – 6) you want to store into.



Preset number flashes for a while.

Tuning in to a preset DAB service

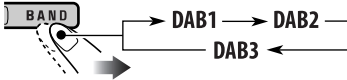
- 
- Select the preset DAB service (primary) number (1 – 6) you want.

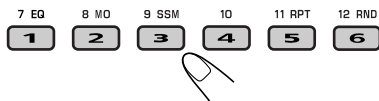

If the selected primary service has some secondary services, pressing the same button again will tune in to the secondary services.

Tracing the same programme— Alternative Frequency Reception

You can keep listening to the same programme by activating the Alternative Frequency Reception.

- While receiving a DAB service:**
 When driving in an area where a service cannot be received, this unit automatically tunes in to another ensemble or FM RDS station, broadcasting the same programme.
- While receiving an FM RDS station:**
 When driving in an area where a DAB service is broadcasting the same programme as the FM RDS station is broadcasting, this unit automatically tunes in to the DAB service.

When shipped from the factory, Alternative Frequency Reception is activated.

To deactivate the Alternative Frequency Reception, see page 15.

To change the display information while tuning to an ensemble



Service name → Ensemble name → Channel number → Frequency → Clock → (back to the beginning)

More about this unit

Basic operations

Turning on the power

- By pressing SOURCE on the unit, you can also turn on the power. If the source is ready, playback also starts.

Turning off the power

- If you turn off the power while listening to a disc, disc play will start from where playback has been stopped previously, next time you turn on the power.

Selecting the sources

- When no disc is loaded in the unit, “CD” cannot be selected.
- “CD-CH” or “DAB” cannot be selected when the target component is not connected.

Tuner operations

Storing stations in memory

- During SSM search...
 - All previously stored stations are erased and stations are stored newly.
 - Received stations are preset in No. 1 (lowest frequency) to No. 6 (highest frequency).
 - When SSM is over, the station stored in No. 1 will be automatically tuned in.
- When storing a station manually, a previously preset station is erased when a new station is stored in the same preset number.

FM RDS operations

- Network-Tracking Reception requires two types of RDS signals—PI (Programme Identification) and AF (Alternative Frequency) to work correctly. Without receiving these data correctly, Network-Tracking Reception will not operate correctly.
- If a Traffic Announcement is received by TA Standby Reception, the volume level (TA VOL) automatically changes to the preset level.

To be continued...

- When Alternative Frequency Reception is activated (with AF selected), Network-Tracking Reception is also activated automatically. On the other hand, Network-Tracking Reception cannot be deactivated without deactivating Alternative Frequency Reception. (See page 15.)
- If you want to know more about RDS, visit «<http://www.rds.org.uk>».
- This unit can play back multi-session discs; however, unclosed sessions will be skipped while playing.
- Some CD-Rs or CD-RWs may not play back on this unit because of their disc characteristics, and for the following causes:
 - Discs are dirty or scratched.
 - Moisture condensation occurs on the lens inside the unit.
 - The pickup lens inside the unit is dirty.
 - CD-R/CD-RW on which the files are written with “Packet Write” method.
 - There are improper recording conditions (missing data, etc.) or media conditions (stain, scratch, warp, etc.).

Disc operations

Caution for DualDisc playback

- The Non-DVD side of a “DualDisc” does not comply with the “Compact Disc Digital Audio” standard. Therefore, the use of Non-DVD side of a DualDisc on this product may not be recommended.

General

- This unit has been designed to reproduce CDs/CD Texts, and CD-Rs (Recordable)/CD-RWs (Rewritable) in audio CD (CD-DA), MP3 and WMA formats.
- When a disc has been loaded, selecting “CD” for the playback source starts disc play.

Inserting a disc

- When a disc is inserted upside down, “PLEASE” and “EJECT” appear alternately on the display. Press ▲ to eject the disc.
- Do not insert 8 cm discs (single CD) and unusual shape discs (heart, flower, etc.) into the loading slot.

Playing a disc

- While fast-forwarding or reversing on an MP3 or WMA disc, you can only hear intermittent sounds.

Playing a CD-R or CD-RW

- Use only “finalized” CD-Rs or CD-RWs.
- This unit can play back only the files of the same type which is first detected if a disc includes both audio CD (CD-DA) files and MP3/WMA files.

- CD-RWs may require a longer readout time since the reflectance of CD-RWs is lower than that of regular CDs.
- Do not use the following CD-Rs or CD-RWs:
 - Discs with stickers, labels, or protective seal stuck to the surface.
 - Discs on which labels can be directly printed by an ink jet printer.

Using these discs under high temperatures or high humidities may cause malfunctions or damages to the unit.

Playing an MP3/WMA disc

- This unit can play back MP3/WMA files with the extension code <.mp3> or <.wma> (regardless of the letter case—upper/lower).
- This unit can show the names of albums, artists (performer), and ID3 Tag (Version 1.0, 1.1, 2.2, 2.3, or 2.4) for MP3 files and for WMA files.
- This unit can display only one-byte characters. No other characters can be correctly displayed.
- This unit can play back MP3/WMA files meeting the conditions below:
 - Bit rate: 8 kbps — 320 kbps
 - Sampling frequency:
 - 48 kHz, 44.1 kHz, 32 kHz (for MPEG-1)
 - 24 kHz, 22.05 kHz, 16 kHz (for MPEG-2)
 - Disc format: ISO 9660 Level 1/ Level 2, Romeo, Joliet, Windows long file name

- The maximum number of characters for file/folder names vary among the disc format used (includes 4 extension characters—<.mp3> or <.wma>).
 - ISO 9660 Level 1: up to 12 characters
 - ISO 9660 Level 2: up to 31 characters
 - Romeo*: up to 128 (72) characters
 - Joliet*: up to 64 (36) characters
 - Windows long file name*: up to 128 (72) characters
- * *The parenthetic figure is the maximum number of characters for file/folder names in case the total number of files and folders is 313 or more.*

- This unit can recognize the total of 512 files, of 200 folders, and of 8 hierarchies.
- This unit can play back the files recorded in VBR (variable bit rate).
The files recorded in VBR have a discrepancy in elapsed time display, and do not show the actual elapsed time. Especially, after performing the search function, this difference becomes noticeable.
- This unit cannot play back the following files:
 - MP3 files encoded with MP3i and MP3 PRO format.
 - MP3 files encoded in an unappropriated format.
 - MP3 files encoded with Layer 1/2.
 - WMA files encoded with lossless, professional, and voice format.
 - WMA files which are not based upon Windows Media® Audio.
 - WMA files copy-protected with DRM.
 - Files which have the data such as WAVE, ATAC3, etc.
- The search function works but search speed is not constant.

Changing the source

- If you change the source, playback also stops (without ejecting the disc).
Next time you select “CD” for the playback source, disc play starts from where it has been stopped previously.

Ejecting a disc

- If the ejected disc is not removed within 15 seconds, the disc is automatically inserted again into the loading slot to protect it from dust. (Disc will not play this time.)

General settings—PSM

- If you change the “AMP GAIN” setting from “HIGH PWR” to “LOW PWR” while the volume level is set higher than “VOL 30,” the unit automatically changes the volume level to “VOL 30.”

DAB tuner operations

- Only primary DAB services can be presetted even when you store a secondary service.
- A previously preset DAB service is erased when a new DAB service is stored in the same preset number.

Available characters on the display

This unit can display Roman alphabets, Cyrillic alphabets, numbers, and a limited number of symbols (see below).

- These characters are used to show various information on the display.

А	Б	В	Г	Д	Е	Ж	З	И	Й	К	Л	М
А	Б	В	Г	Д	Е	Ж	З	И	Й	К	Л	М

Н	О	П	Р	С	Т	У	Ф	Х	Ц	Ч	Ш	Щ
Н	О	П	Р	С	Т	У	Ф	Х	Ц	Ч	Ш	Щ

Ъ	Ы	Ь	Э	Ю	Я	Ё	А	В	С	Д	Е	Ф
Ъ	Ы	Ь	Э	Ю	Я	Ё	А	В	С	Д	Е	Ф

G	H	I	J	K	L	M	N	O	P	Q	R	S
G	H	I	J	K	L	M	N	O	P	Q	R	S

T	U	V	W	X	Y	Z	0	1	2	3	4	5
T	U	V	W	X	Y	Z	0	1	2	3	4	5

6	7	8	9	-	/	<	>	space
6	7	8	9	-	/	<	>	

Maintenance

How to clean the connectors

Frequent detachment will deteriorate the connectors.

To minimize this possibility, periodically wipe the connectors with a cotton swab or cloth moistened with alcohol, being careful not to damage the connectors.

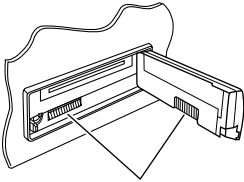

Connector

Moisture condensation

Moisture may condense on the lens inside the CD player in the following cases:

- After starting the heater in the car.
- If it becomes very humid inside the car.

Should this occur, the CD player may malfunction. In this case, eject the disc and leave the unit turned on for a few hours until the moisture evaporates.

How to handle discs

When removing a disc from its case, press down the center holder of the case and lift the disc out, holding it by the edges.

- Always hold the disc by the edges. Do not touch its recording surface.

When storing a disc into its case, gently insert the disc around the center holder (with the printed surface facing up).

- Make sure to store discs into the cases after use.

Center holder



To keep discs clean

A dirty disc may not play correctly. If a disc does become dirty, wipe it with a soft cloth in a straight line from center to edge.

- Do not use any solvent (for example, conventional record cleaner, spray, thinner, benzene, etc.) to clean discs.



To play new discs

New discs may have some rough spots around the inner and outer edges. If such a disc is used, this unit may reject the disc.

To remove these rough spots, rub the edges with a pencil or ball-point pen, etc.



Do not use the following discs:



Troubleshooting

What appears to be trouble is not always serious. Check the following points before calling a service center.

	Symptoms	Remedies/Causes
General	<ul style="list-style-type: none"> • Sound cannot be heard from the speakers. 	<ul style="list-style-type: none"> • Adjust the volume to the optimum level. • Check the cords and connections.
	<ul style="list-style-type: none"> • The unit does not work at all. 	Reset the unit (see page 2).
FM/AM	<ul style="list-style-type: none"> • SSM automatic presetting does not work. 	Store stations manually.
	<ul style="list-style-type: none"> • Static noise while listening to the radio. 	Connect the aerial firmly.
Disc playback	<ul style="list-style-type: none"> • Disc cannot be played back. 	Insert the disc correctly.
	<ul style="list-style-type: none"> • CD-R/CD-RW cannot be played back. • Tracks on the CD-R/CD-RW cannot be skipped. 	<ul style="list-style-type: none"> • Insert a finalized CD-R/CD-RW. • Finalize the CD-R/CD-RW with the component which you used for recording.
	<ul style="list-style-type: none"> • Disc can be neither played back nor ejected. 	<ul style="list-style-type: none"> • Unlock the disc (see page 12). • Eject the disc forcibly (see page 2).
	<ul style="list-style-type: none"> • Disc sound is sometimes interrupted. 	<ul style="list-style-type: none"> • Stop playback while driving on rough roads. • Change the disc. • Check the cords and connections.
MP3/WMA playback	<ul style="list-style-type: none"> • Disc cannot be played back. 	<ul style="list-style-type: none"> • Use a disc with MP3/WMA tracks recorded in the format compliant with ISO 9660 Level 1, Level 2, Romeo, or Joliet. • Add the extension code <.mp3> or <.wma> to the file names.
	<ul style="list-style-type: none"> • Noise is generated. 	Skip to another track or change the disc. (Do not add the extension code <.mp3> or <.wma> to non-MP3 or WMA tracks.)

To be continued...

	Symptoms	Remedies/Causes
MP3/WMA playback	<ul style="list-style-type: none"> A longer readout time is required (“CHECK” keeps flashing on the display). 	Do not use too many hierarchies and folders.
	<ul style="list-style-type: none"> Tracks do not play back in the order you have intended them to play. 	Playback order is determined when the files are recorded.
	<ul style="list-style-type: none"> Elapsed playing time is not correct. 	This sometimes occurs during play. This is caused by how the tracks are recorded on the disc.
	<ul style="list-style-type: none"> “NO FILES” appears on the display. 	Insert a disc that contains MP3/WMA tracks.
	<ul style="list-style-type: none"> Correct characters are not displayed (e.g. album name). 	This unit can only display Roman alphabets, Cyrillic alphabets, numbers, and a limited number of symbols (see page 21).
CD changer	<ul style="list-style-type: none"> “NO DISC” appears on the display. 	Insert a disc into the magazine.
	<ul style="list-style-type: none"> “NO MAG” appears on the display. 	Insert the magazine.
	<ul style="list-style-type: none"> “RESET 8” appears on the display. 	Connect this unit and the CD changer correctly and press the reset button of the CD changer.
	<ul style="list-style-type: none"> “RESET 1” – “RESET 7” appears on the display. 	Press the reset button of the CD changer.
	<ul style="list-style-type: none"> The CD changer does not work at all. 	Reset the unit (see page 2).
DAB	<ul style="list-style-type: none"> “noSIGNAL” appears on the display. 	Move to an area with stronger signals.
	<ul style="list-style-type: none"> “RESET 8” appears on the display. 	Connect this unit and the DAB tuner correctly and reset the unit (see page 2).
	<ul style="list-style-type: none"> “ANTENANG” appears on the display. 	Check the cords and connections.
	<ul style="list-style-type: none"> The DAB tuner does not work at all. 	Reconnect this unit and the DAB tuner correctly and reset the unit (see page 2).

- Microsoft and Windows Media are either registered trademarks or trademarks of Microsoft Corporation in the United States and/or other countries.

AUDIO AMPLIFIER SECTION

Maximum Power Output:

Front: 50 W per channel

Rear: 50 W per channel

Continuous Power Output (RMS):

Front: 19 W per channel into 4 Ω , 40 Hz to 20 000 Hz at no more than 0.8% total harmonic distortion.

Rear: 19 W per channel into 4 Ω , 40 Hz to 20 000 Hz at no more than 0.8% total harmonic distortion.

Load Impedance: 4 Ω (4 Ω to 8 Ω allowance)

Tone Control Range:

Bass: ± 10 dB at 100 Hz

Treble: ± 10 dB at 10 kHz

Frequency Response: 40 Hz to 20 000 Hz

Signal-to-Noise Ratio: 70 dB

Line-Out Level/Impedance:

2.5 V/20 k Ω load (full scale)

Output Impedance: 1 k Ω

Other Terminals:

CD changer, AUX (auxiliary) input jack

TUNER SECTION

Frequency Range:

FM1/FM2: 87.5 MHz to 108.0 MHz

FM3: 65.00 MHz to 74.00 MHz

AM: (MW) 522 kHz to 1 620 kHz
(LW) 144 kHz to 279 kHz

[FM Tuner]

Usable Sensitivity: 11.3 dBf (1.0 μ V/75 Ω)

50 dB Quietening Sensitivity:

16.3 dBf (1.8 μ V/75 Ω)

Alternate Channel Selectivity (400 kHz): 65 dB

Frequency Response: 40 Hz to 15 000 Hz

Stereo Separation: 35 dB

Capture Ratio: 1.5 dB

[MW Tuner]

Sensitivity: 20 μ V

Selectivity: 35 dB

[LW Tuner]

Sensitivity: 50 μ V

CD PLAYER SECTION

Type: Compact disc player

Signal Detection System: Non-contact optical pickup (semiconductor laser)

Number of Channels: 2 channels (stereo)

Frequency Response: 5 Hz to 20 000 Hz

Dynamic Range: 96 dB

Signal-to-Noise Ratio: 98 dB

Wow and Flutter: Less than measurable limit

MP3 Decoding Format:

MPEG1/2 Audio Layer 3

Max. Bit Rate: 320 kbps

WMA (Windows Media[®] Audio) Decoding Format:

Max. Bit Rate: 192 kbps

GENERAL

Power Requirement:

Operating Voltage:

DC 14.4 V (11 V to 16 V allowance)

Grounding System: Negative ground

Allowable Operating Temperature:

0°C to +40°C

Dimensions (W \times H \times D):

Installation Size (approx.):

182 mm \times 52 mm \times 150 mm

Panel Size (approx.):

188 mm \times 58 mm \times 11 mm

Mass (approx.):

1.5 kg (excluding accessories)

Design and specifications are subject to change without notice.



Having TROUBLE with operation?

Please reset your unit

Refer to page of How to reset your unit

Затруднения при эксплуатации?

Пожалуйста, перезагрузите Ваше устройство

Для получения информации о перезагрузке Вашего устройства
обратитесь на соответствующую страницу

JVC



EN, RU

© 2005 Victor Company of Japan, Limited

0905DTSMDTJEIN

JVC KD-G527

Installation/Connection Manual

Руководство по установке/подключению

GET0340-002A
[EE]

0905DTSMDTJEIN
EN, RU

© 2005 Victor Company of Japan, Limited

ENGLISH

This unit is designed to operate on **12 V DC, NEGATIVE ground electrical systems**. If your vehicle does not have this system, a voltage inverter is required, which can be purchased at JVC IN-CAR ENTERTAINMENT dealers.

WARNINGS

To prevent short circuits, we recommend that you disconnect the battery's negative terminal and make all electrical connections before installing the unit.

- **Be sure to ground this unit to the car's chassis again after installation.**

Notes:

- Replace the fuse with one of the specified rating. If the fuse blows frequently, consult your JVC IN-CAR ENTERTAINMENT dealer.
- It is recommended to connect to the speakers with maximum power of more than 50 W (both at the rear and at the front, with an impedance of **4 Ω to 8 Ω**). If the maximum power is less than 50 W, change "AMP GAIN" setting to prevent the speakers from being damaged (see page 16 of the INSTRUCTIONS).
- To prevent short-circuit, cover the terminals of the UNUSED leads with insulating tape.
- The heat sink becomes very hot after use. Be careful not to touch it when removing this unit.

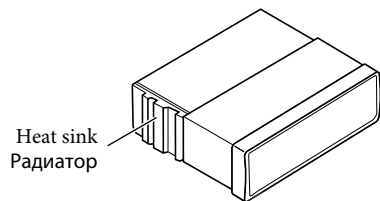

PRECAUTIONS on power supply and speaker connections:

- **DO NOT connect the speaker leads of the power cord to the car battery; otherwise, the unit will be seriously damaged.**
- BEFORE connecting the speaker leads of the power cord to the speakers, check the speaker wiring in your car.

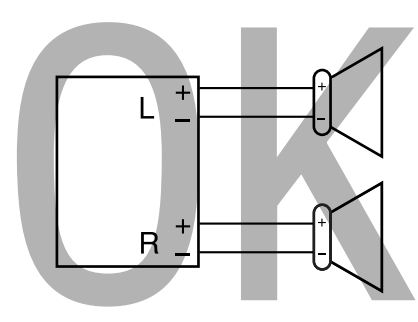
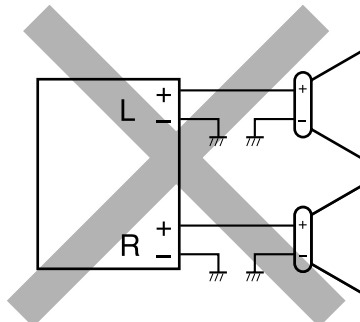
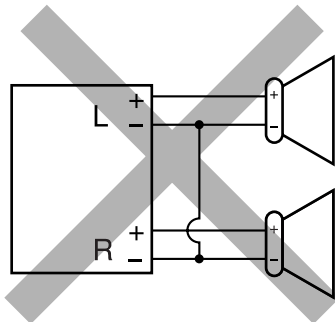

ПРЕДОСТЕРЕЖЕНИЯ по питанию и подключению громкоговорителей:

- **НЕ подключайте провода громкоговорителей к аккумулятору автомобиля, иначе устройство будет повреждено.**
- ПЕРЕД подключением проводов громкоговорителей к кабелю питания громкоговорителя проверьте схему соединений громкоговорителей в Вашем автомобиле.

Parts list for installation and connection

The following parts are provided for this unit.
After checking them, please set them correctly.

(A) / (B)
Hard case/Control panel
Жесткий футляр/панель управления

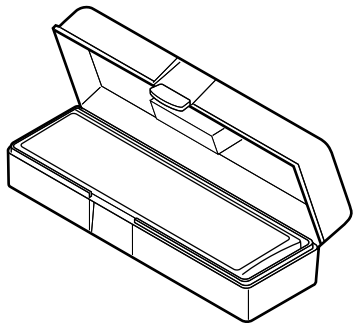

(C)
Sleeve
Муфта

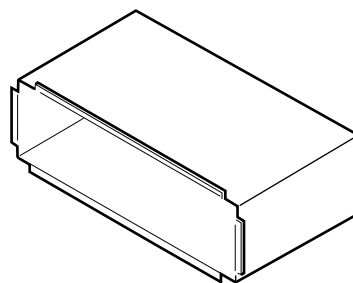

(D)
Trim plate
Декоративную панель

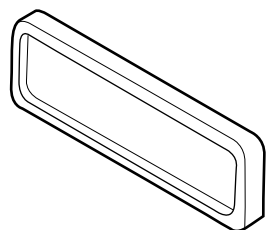

(E)
Power cord
Кабель питания

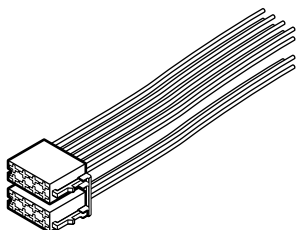

(F)
Washer (ø5)
Шайба (№5)



(G)
Lock nut (M5)
Фиксирующая гайка (M5)



(H)
Mounting bolt (M5 x 20 mm)
Крепежный болт (M5 x 20 мм)

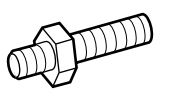

(I)
Rubber cushion
Резиновый чехол



(J)
Handles
Рычаги

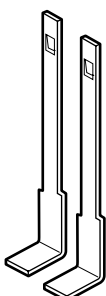

(K)
Remote controller
дистанционного управления

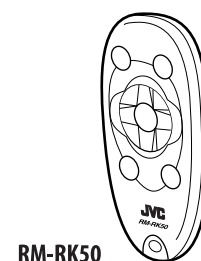

(L)
Battery
Батарейка



CR2025

РУССКИЙ

Это устройство разработано для эксплуатации на **12 В постоянного напряжения с минусом на массе**. Если Ваш автомобиль не имеет этой системы, требуется инвертор напряжения, который может быть приобретен у дилера автомобильного специалиста JVC.

ПРЕДУПРЕЖДЕНИЯ

Для предотвращения коротких замыканий мы рекомендуем Вам отсоединить отрицательный разъем аккумулятора и осуществить все подключения перед установкой устройства.

- **После установки обязательно заземлите данное устройство на шасси автомобиля.**

Примечания:

- Заменяйте предохранитель другим предохранителем указанного класса. Если предохранитель сгорает слишком часто, обратитесь к дилеру автомобильного специалиста JVC.
- Рекомендуется подключать динамики с максимальной мощностью более 50 Вт (к задней и передней панели устройства, с полным сопротивлением от **4 Ω до 8 Ω**). Если максимальная мощность динамиков менее 50 Вт, перейдите в режим "AMP GAIN", чтобы предотвратить их повреждение (см. ИНСТРУКЦИИ ПО ЭКСПЛУАТАЦИИ на стр. 16).
- Для предотвращения короткого замыкания заклейте НЕИСПОЛЬЗУЕМЫЕ концы изолирующей лентой.
- Радиатор во время использования сильно нагревается. Старайтесь его не трогать во время удаления устройства.

INSTALLATION (IN-DASH MOUNTING)

The following illustration shows a typical installation. If you have any questions or require information regarding installation kits, consult your JVC IN-CAR ENTERTAINMENT dealer or a company supplying kits.

- If you are not sure how to install this unit correctly, have it installed by a qualified technician.

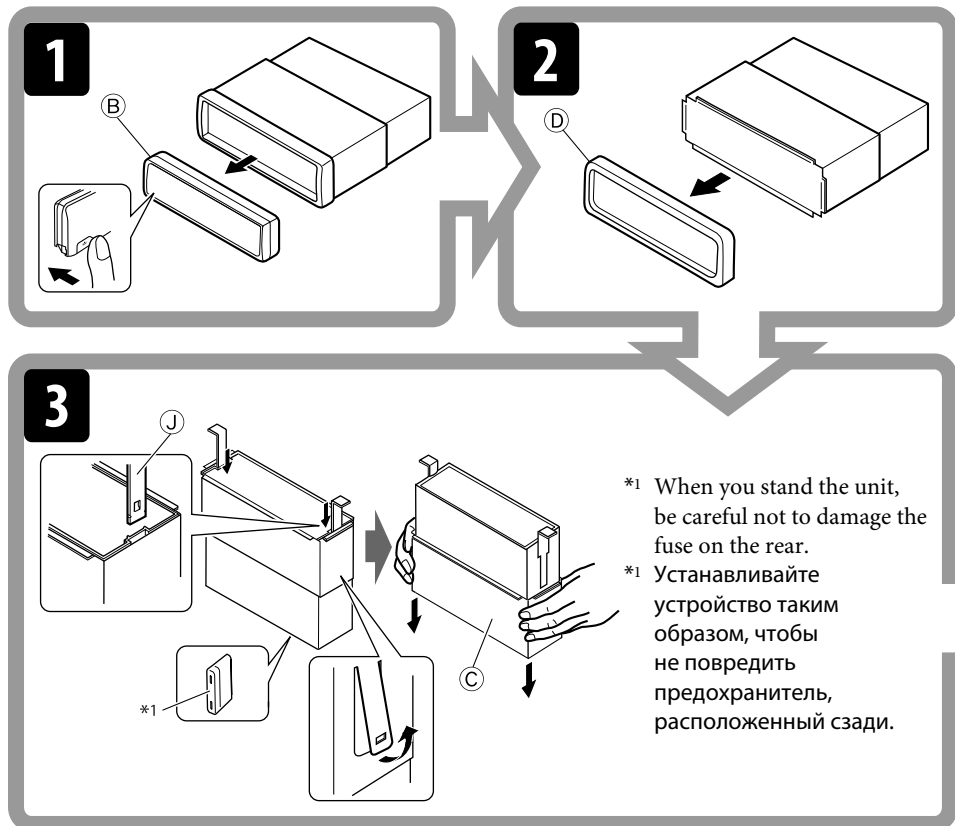

УСТАНОВКА (УСТАНОВКА В ПРИБОРНУЮ ПАНЕЛЬ)

На следующих иллюстрациях показана типовая установка. Если у Вас есть какие-либо вопросы, касающиеся установки, обратитесь к Вашему дилеру автомобильного специалиста JVC или в компанию, поставляющую соответствующие принадлежности.

- Если Вы не знаете точно, как следует устанавливать это устройство, обратитесь к квалифицированному специалисту.

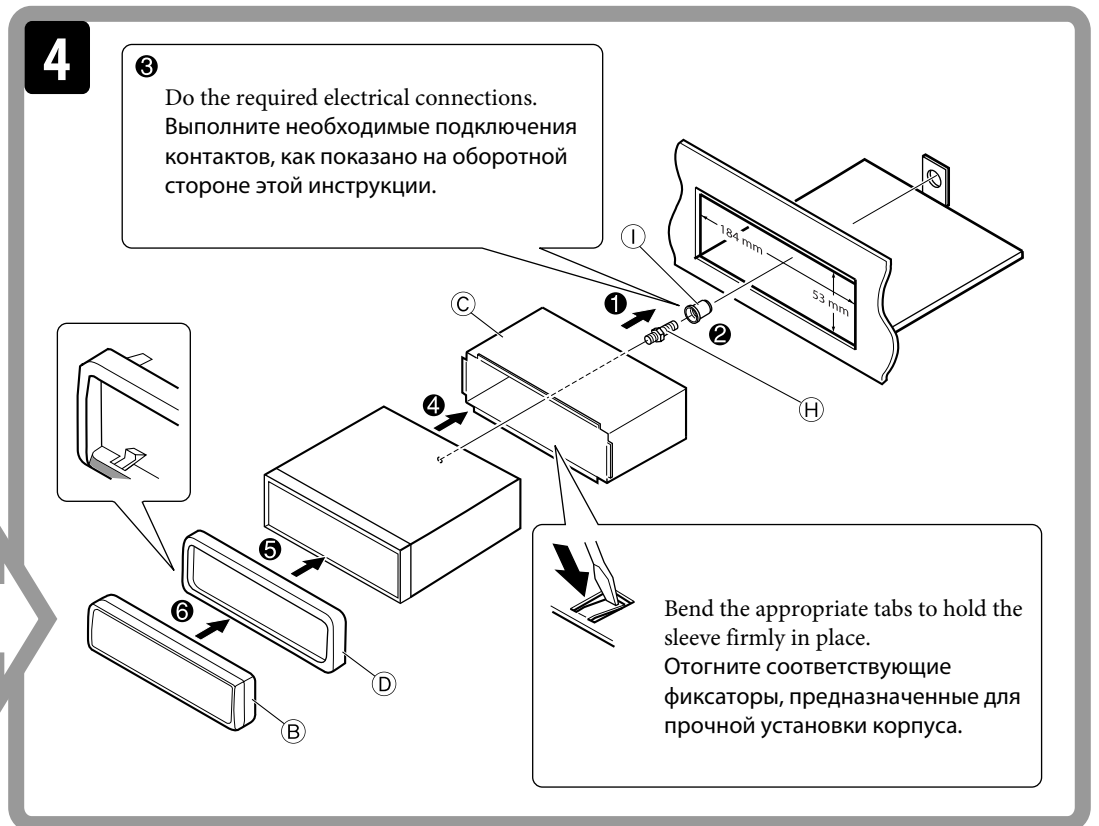

Removing the unit

Before removing the unit, release the rear section.

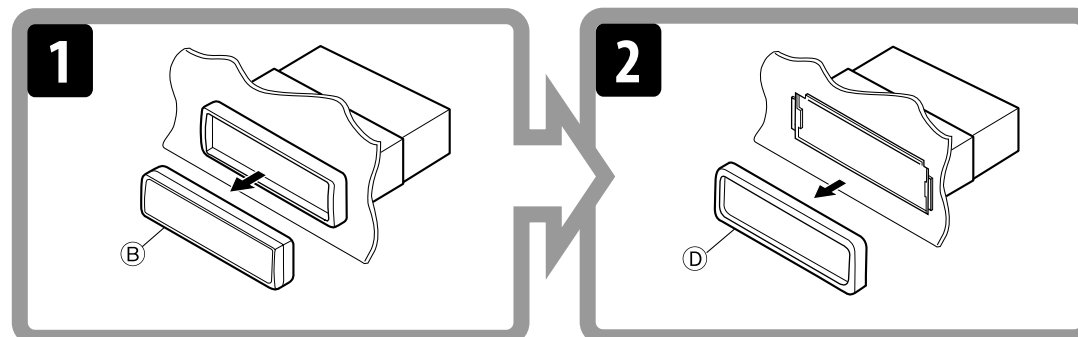

Удаление устройства

Перед удалением устройства освободите заднюю часть.

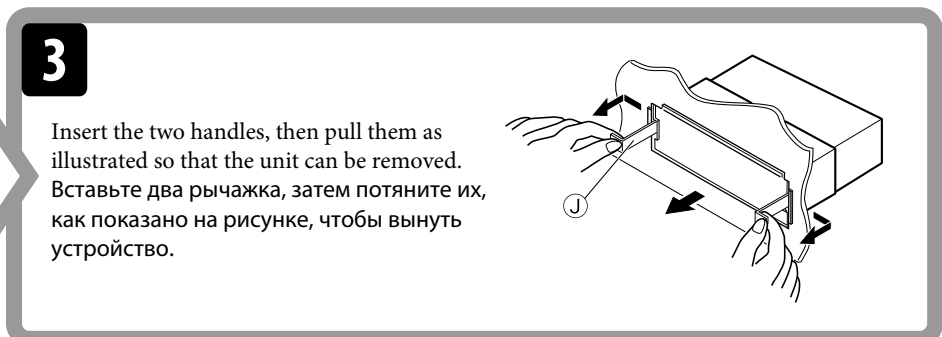

When using the optional stay / При использовании дополнительной стойки

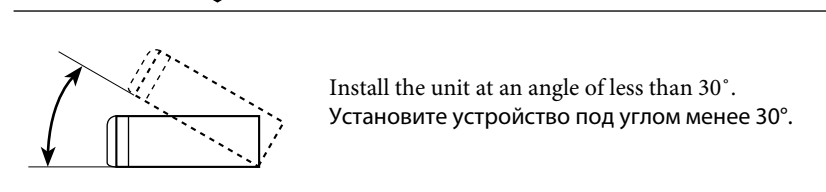
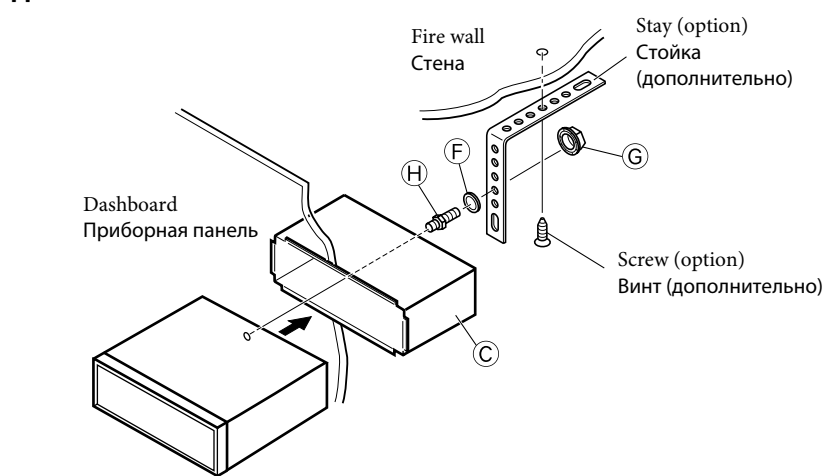

When installing the unit without using the sleeve / При установке устройства без использования муфты

In a Toyota for example, first remove the car radio and install the unit in its place.

В автомобилях "Toyota", например, сначала удалите автомобильную магнитолу, затем установите на ее место это устройство.

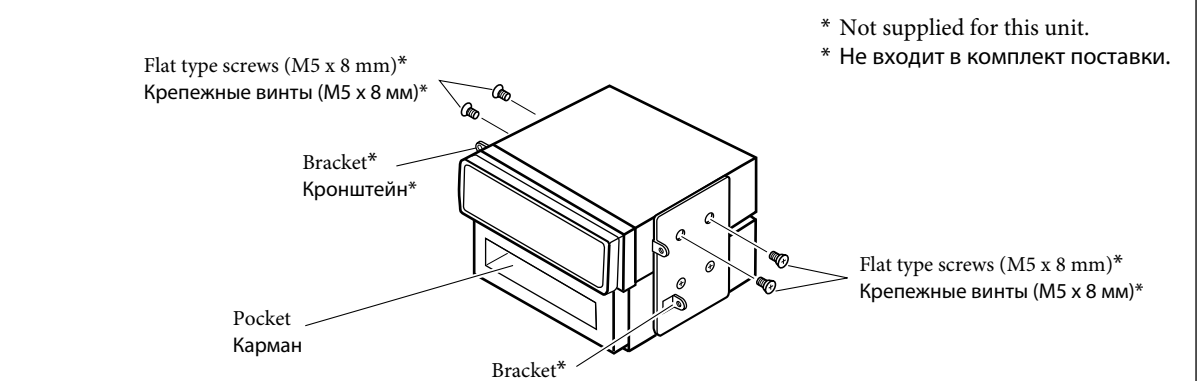

Note

Примечание

- When installing the unit on the mounting bracket, make sure to use the 8 mm-long screws. If longer screws are used, they could damage the unit.
- При установке устройства на крепежный кронштейн, используйте только винты длиной 8 мм. При использовании более длинных винтов можно повредить устройство.

TROUBLESHOOTING

- **The fuse blows.**
 - * Are the red and black leads connected correctly?
- **Power cannot be turned on.**
 - * Is the yellow lead connected?
- **No sound from the speakers.**
 - * Is the speaker output lead short-circuited?
- **Sound is distorted.**
 - * Is the speaker output lead grounded?
 - * Are the "-" terminals of L and R speakers grounded in common?
- **Noise interfere with sounds.**
 - * Is the rear ground terminal connected to the car's chassis using shorter and thicker cords?
- **Unit becomes hot.**
 - * Is the speaker output lead grounded?
 - * Are the "-" terminals of L and R speakers grounded in common?
- **This unit does not work at all.**
 - * Have you reset your unit?

ВЫЯВЛЕНИЕ НЕИСПРАВНОСТЕЙ

- **Сработал предохранитель.**
 - * Правильно ли подключены черный и красный провода?
- **Питание не включается.**
 - * Подключен ли желтый провод?
- **Звук не выводится через громкоговорители.**
 - * Нет ли короткого замыкания на кабеле выхода громкоговорителей?
- **Звук искажен.**
 - * Заземлен ли провод выхода громкоговорителей?
 - * Заземлены ли разъемы "-" правого (R) и левого (L) громкоговорителей?
- **Шум мешает звучанию.**
 - * Соединен ли находящийся сзади зажим заземления с шасси автомобиля с помощью более короткого и тонкого шнура?
- **Устройство нагревается.**
 - * Заземлен ли провод выхода громкоговорителей?
 - * Заземлены ли разъемы "-" правого (R) и левого (L) громкоговорителей?
- **Приемник не работает.**
 - * Выполнена ли перенастройка приемника?

A Typical Connections / Типичные подключения

Before connecting: Check the wiring in the vehicle carefully. Incorrect connection may cause serious damage to this unit.
The leads of the power cord and those of the connector from the car body may be different in color.

- 1 Connect the colored leads of the power cord in the order specified in the illustration below.
- 2 Connect the aerial cord.
- 3 Finally connect the wiring harness to the unit.

Note: If your vehicle does not have any accessory terminal, move the fuse from the fuse position 1 (initial position) to fuse position 2, and connect the red lead (A7) to the positive (+) battery terminal.
• The yellow lead (A4) is not used in this case.

Перед началом подключений: Тщательно проверьте проводку в автомобиле. Неправильное подключение может привести к серьезному повреждению устройства.
Жилы силового кабеля и жилы соединителя от кузова автомобиля могут быть разного цвета.

- 1 Подсоедините цветные провода шнура питания в указанном ниже порядке.
- 2 Подключите кабель антенны.
- 3 В последнюю очередь подключите электропроводку к устройству.

Примечание: Если в Вашем автомобиле никакого вспомогательного разъема не имеется, переставьте предохранитель из положения 1 предохранителя (первоначальное положение) в положение 2 предохранителя и подключите красный провод (A7) к положительному (+) полюсу аккумулятора.
• Желтый провод (A4) в этом случае не используется.

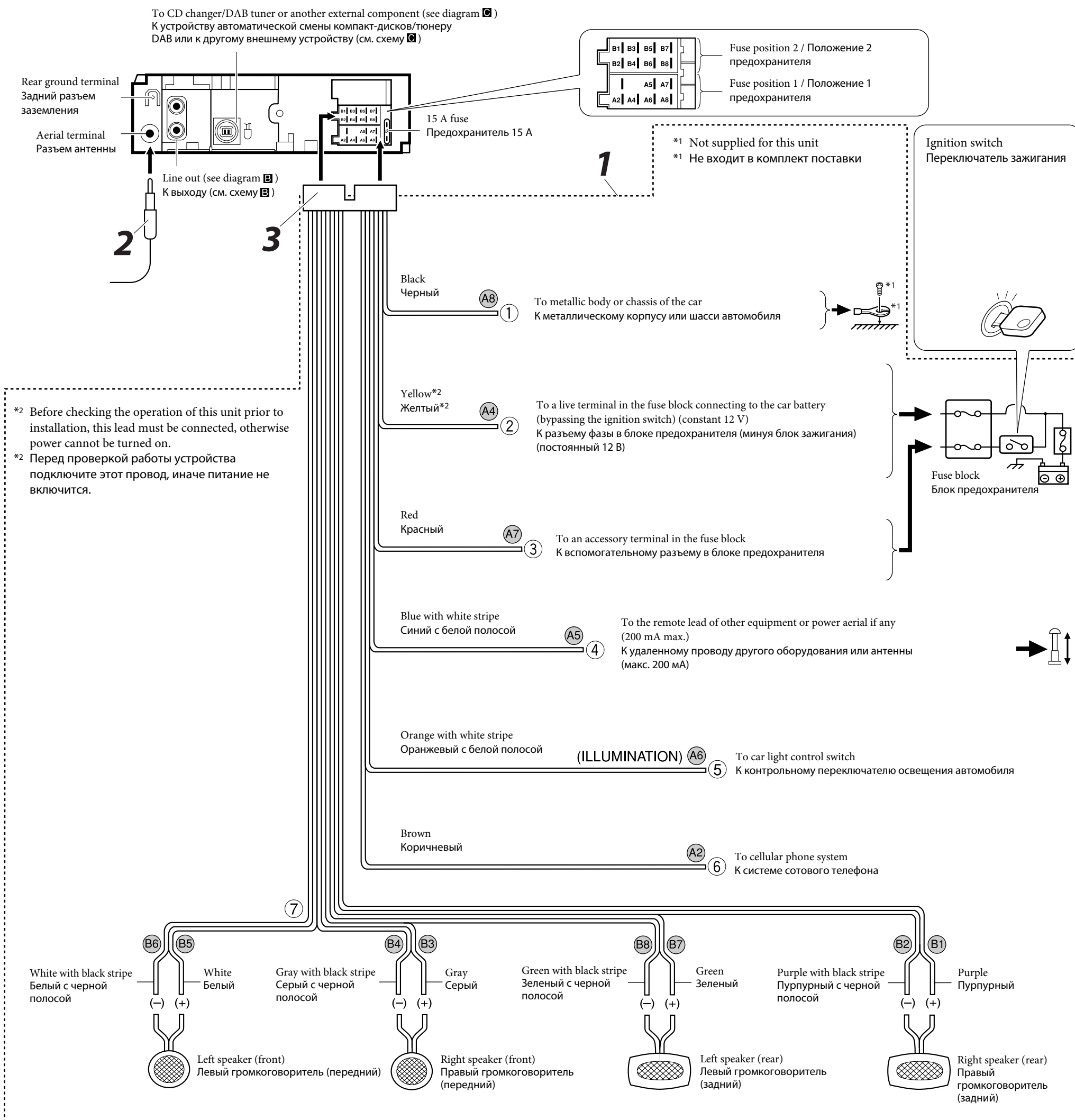

B Connecting the external amplifier / Подключение внешних усилителей

You can connect an amplifier to upgrade your car stereo system.

- Connect the remote lead (blue with white stripe) to the remote lead of the other equipment so that it can be controlled through this unit.
- **Disconnect the speakers from this unit, connect them to the amplifier. Leave the speaker leads of this unit unused.**

Можно подключить усилители для обновления автомобильной стереосистемы.

- Подсоедините провод внешнего устройства (синий с белой полосой) к проводу внешнего устройства другого оборудования так, чтобы им можно было управлять с этого устройства.
- **Отсоедините громкоговорители от данного устройства, подключите их к усилителю. Оставьте провода громкоговорителей данного устройства неиспользованными.**

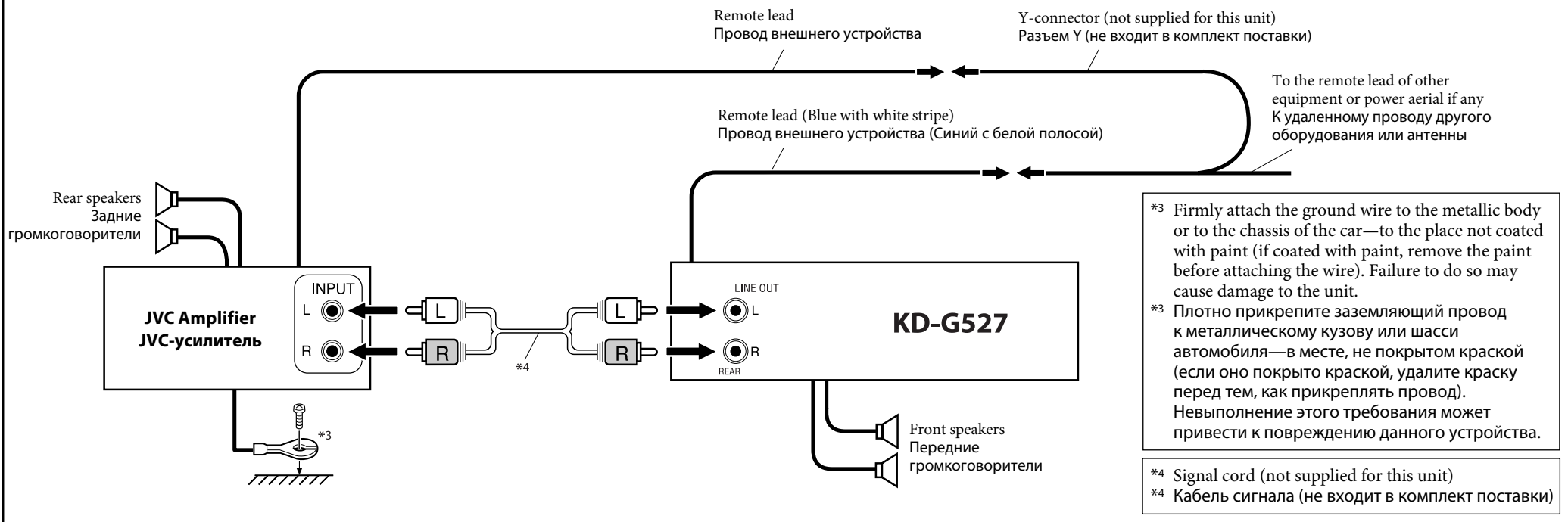

C Connecting the external components / Подключение внешних устройств

- Set "CHANGER" for the external input setting (see page 16 of the INSTRUCTIONS.) / Установите для внешнего входа значение „CHANGER“ (см. ИНСТРУКЦИИ ПО ЭКСПЛУАТАЦИИ на стр. 16).

CD changer, DAB tuner, Apple iPod®, or JVC D. player / Устройство автоматической смены компакт-дисков, тюнер DAB, Apple iPod® или проигрыватель JVC D.

- You can connect both components in series as illustrated below. The iPod® or D. player can be connected using an interface adapter (not supplied)—KS-PD100 (for iPod) or KS-PD500 (for D. player).
- Эти внешние устройства можно подключать параллельно, как показано на рисунке. Проигрыватель iPod® или D. можно подключить с помощью интерфейсного адаптера (не входит в комплект поставки)—KS-PD100 (для iPod) или KS-PD500 (для проигрывателя D.).

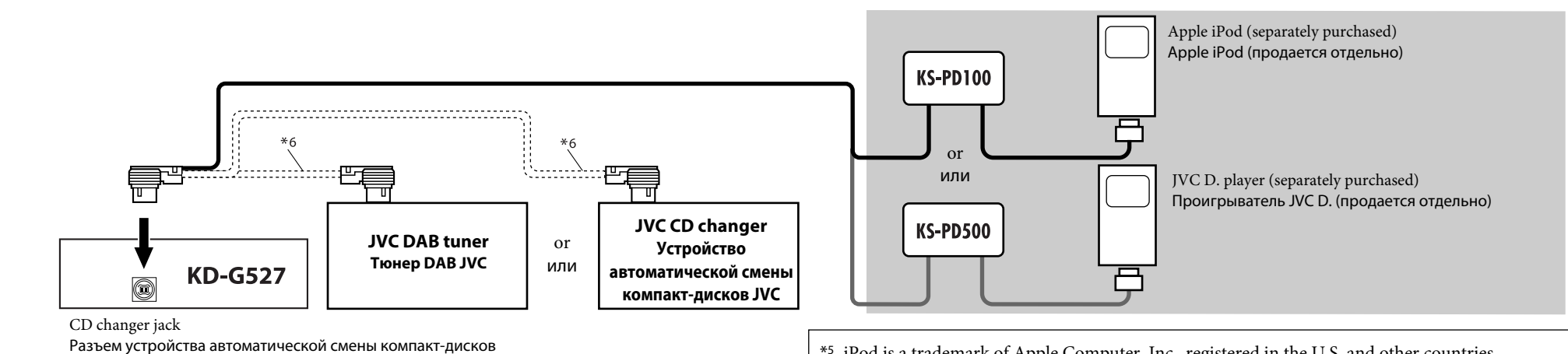
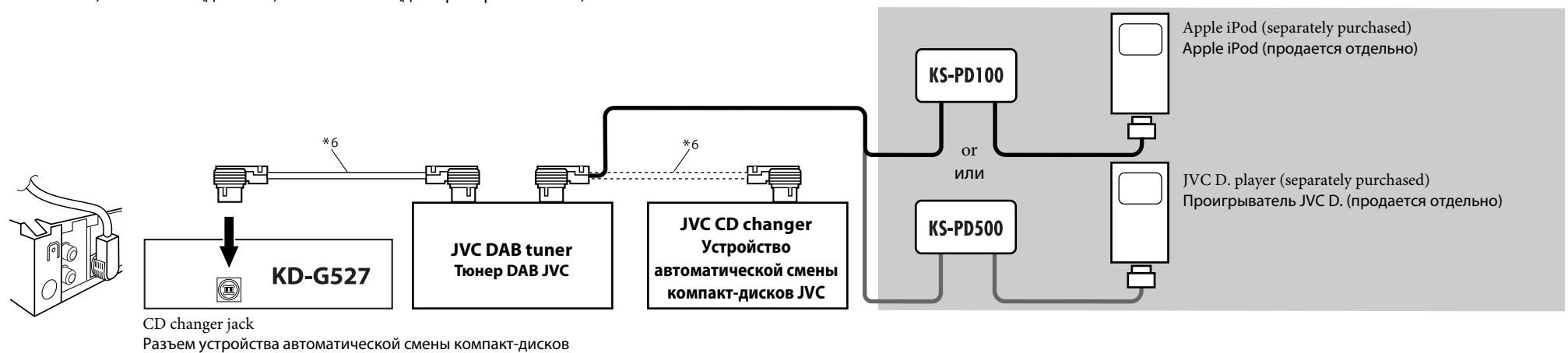

- *5 iPod is a trademark of Apple Computer, Inc., registered in the U.S. and other countries.
*5 iPod является торговой маркой Apple Computer, Inc., зарегистрированной в США и других странах.

- *6 Connecting cord supplied for your CD changer or DAB tuner
*6 Подключение кабеля, входящего в комплект поставки устройства автоматической смены компакт-дисков или тюнера DAB

CAUTION / ПРЕДОСТЕРЕЖЕНИЕ:

- Before connecting the external components, make sure that the unit is turned off.
- Перед подключением внешних компонентов убедитесь в том, что устройство выключено.

- Set "EXT IN" for the external input setting (see page 16 of the INSTRUCTIONS.) / Установите для внешнего входа значение „EXT IN“ (см. ИНСТРУКЦИИ ПО ЭКСПЛУАТАЦИИ на стр. 16).

External Component / Внешнее устройство

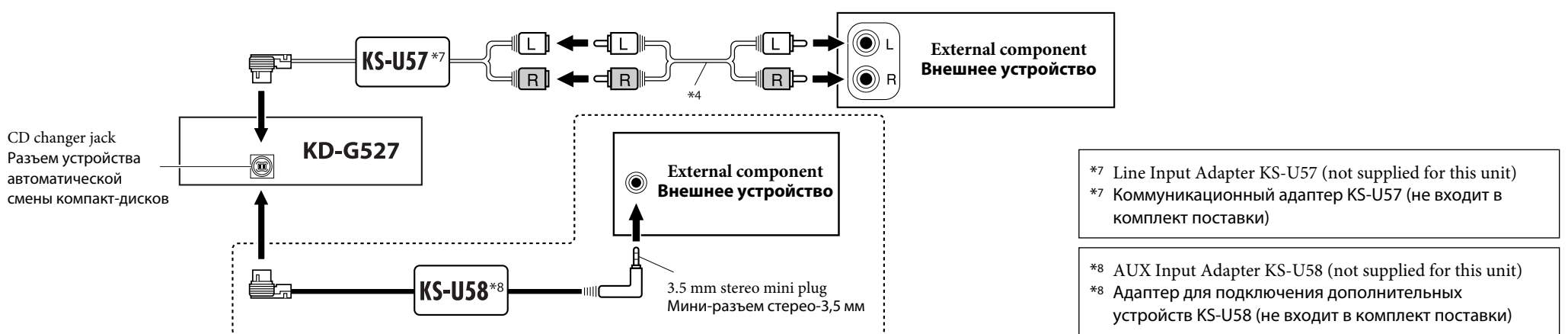

Free Manuals Download Website

<http://myh66.com>

<http://usermanuals.us>

<http://www.somanuals.com>

<http://www.4manuals.cc>

<http://www.manual-lib.com>

<http://www.404manual.com>

<http://www.luxmanual.com>

<http://aubethermostatmanual.com>

Golf course search by state

<http://golfingnear.com>

Email search by domain

<http://emailbydomain.com>

Auto manuals search

<http://auto.somanuals.com>

TV manuals search

<http://tv.somanuals.com>