

JVC



CD RECEIVER

KD-AR760/KD-G710

ENGLISH

RECEPTOR CON CD

KD-AR760/KD-G710

ESPAÑOL

RECEPTEUR CD

KD-AR760/KD-G710

FRANÇAIS



SIRIUS
READY

COMPACT
disc
DIGITAL AUDIO
TEXT

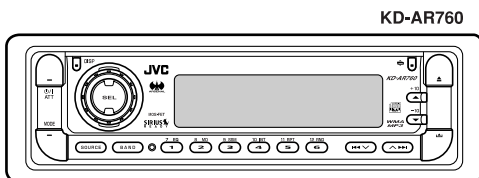

KD-AR760

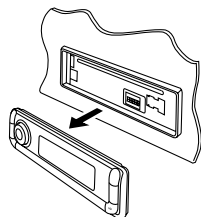

MP3
WMA

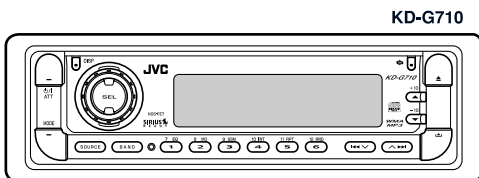

KD-G710

For canceling the display demonstration, see page 8.

Para cancelar la demostración en pantalla, consulte la página 8.

Pour annuler la démonstration des affichages, référez-vous à la page 8.

For installation and connections, refer to the separate manual.

Para la instalación y las conexiones, refiérase al manual separado.

Pour l'installation et les raccordements, se référer au manuel séparé.

For customer Use:

Enter below the Model No. and Serial No. which are located on the top or bottom of the cabinet. Retain this information for future reference.

Model No. _____

Serial No. _____

INSTRUCTIONS

MANUAL DE INSTRUCCIONES
MANUEL D'INSTRUCTIONS

GET0247-001A

[J]

Thank you for purchasing a JVC product.

Please read all instructions carefully before operation, to ensure your complete understanding and to obtain the best possible performance from the unit.

INFORMATION (For U.S.A.)

This equipment has been tested and found to comply with the limits for a Class B digital device, pursuant to Part 15 of the FCC Rules. These limits are designed to provide reasonable protection against harmful interference in a residential installation. This equipment generates, uses, and can radiate radio frequency energy and, if not installed and used in accordance with the instructions, may cause harmful interference to radio communications. However, there is no guarantee that interference will not occur in a particular installation. If this equipment does cause harmful interference to radio or television reception, which can be determined by turning the equipment off and on, the user is encouraged to try to correct the interference by one or more of the following measures:

- Reorient or relocate the receiving antenna.
- Increase the separation between the equipment and receiver.
- Connect the equipment into an outlet on a circuit different from that to which the receiver is connected.
- Consult the dealer or an experienced radio/TV technician for help.

IMPORTANT FOR LASER PRODUCTS

1. CLASS 1 LASER PRODUCT
2. **CAUTION:** Do not open the top cover. There are no user serviceable parts inside the unit; leave all servicing to qualified service personnel.
3. **CAUTION:** Visible and invisible laser radiation when open and interlock failed or defeated. Avoid direct exposure to beam.

Warning:

If you need to operate the receiver while driving, be sure to look ahead carefully or you may be involved in a traffic accident.

How to reset your unit

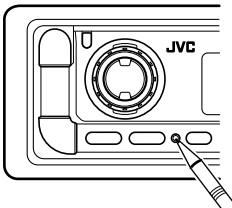

This will reset the microcomputer. Your preset adjustments will also be erased.

How to forcibly eject a disc

If a disc cannot be recognized by the receiver or cannot be ejected, ejects the disc as follows.



If this does not work, try to reset your receiver.

How to reset your unit	2	Sound adjustments	17
How to forcibly eject a disc	2	Selecting preset sound modes	
How to read this manual	4	(iEQ: intelligent equalizer)	17
How to use the MODE button	4	Adjusting the sound	18
		Storing your own sound adjustments.....	19
Control panel		General settings — PSM	20
— KD-AR760/KD-G710	5	Basic procedure	20
Parts identification	5	Other main functions	23
Remote controller — RM-RK50 ...	6	Assigning titles to the sources	23
Main elements and features	6	Changing the control panel angle	24
Getting started	7	Detaching the control panel	24
Basic operations	7	External component operations... 25	
Canceling the display demonstrations ...	8	Playing an external component	25
Setting the clock	8	SIRIUS® radio operations..... 26	
Radio operations	9	Listening to the SIRIUS® radio	27
Listening to the radio.....	9	Storing channels in memory	28
Storing stations in memory	10	Listening to a preset channel	28
Listening to a preset station	10	Maintenance	29
Disc operations	11	More about this receiver	30
Playing a disc in the receiver	11	Troubleshooting	32
Playing discs in the CD changer	12	Specifications	35
Other main functions	14		
Changing the display information	15		
Selecting the playback modes.....	16		

Caution on volume setting:

Discs produce very little noise compared with other sources. Lower the volume before playing a disc to avoid damaging the speakers by the sudden increase of the output level.

Caution:

Do not insert your finger behind the control panel.

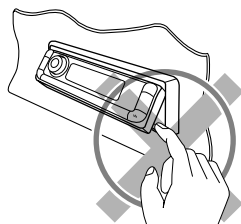

***For safety....**

- Do not raise the volume level too much, as this will block outside sounds, making driving dangerous.
- Stop the car before performing any complicated operations.



***Temperature inside the car....**

If you have parked the car for a long time in hot or cold weather, wait until the temperature in the car becomes normal before operating the unit.

How to read this manual

The following methods are used to make the explanations simple and easy-to-understand:

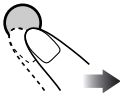
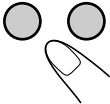
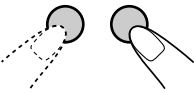
- Some related tips and notes are explained in “More about this receiver” (see page 30).
- Button operations are mainly explained with the illustrations as follows:

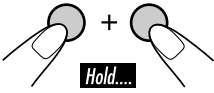
	Press briefly.
	Press repeatedly.
	Press either one.
	
	Press and hold until your desired response begins.
	Press and hold both buttons at the same time.

The following marks are used to indicate...

 : Built-in CD player operations.

 : External CD changer operations.

How to use the MODE button

If you press MODE, the receiver goes into functions mode, then the number buttons and ▲/▼ buttons work as different function buttons.

Ex.: When number button 2 works as MO (monaural) button.

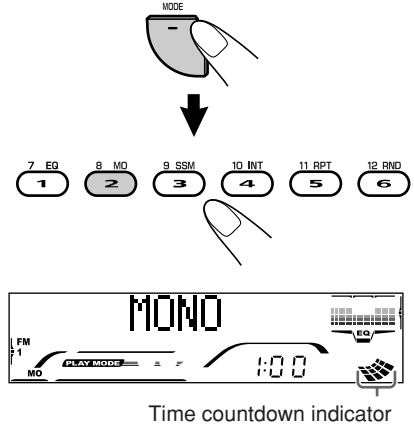

To use these buttons for original functions again after pressing MODE, wait for 5 seconds without pressing any of these buttons until the functions mode is cleared.

- Pressing MODE again also clears the functions mode.

Parts identification

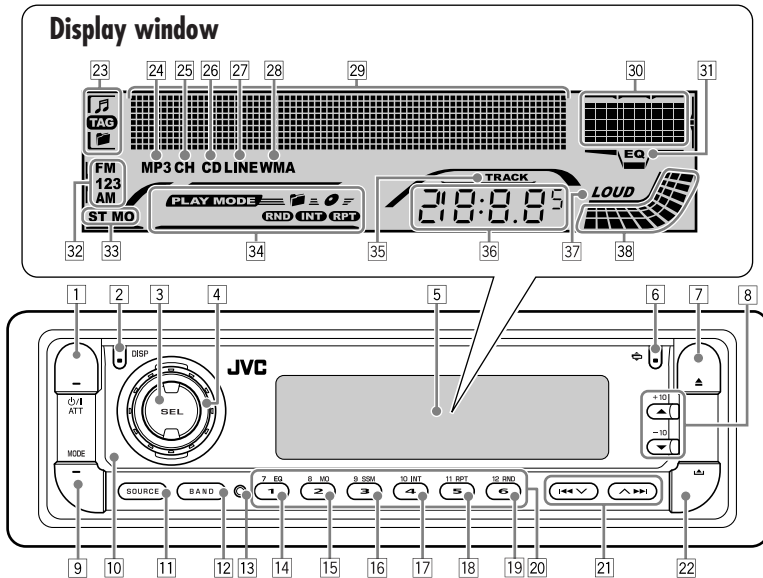

- 1 **⏻** ATT (standby/on attenuator) button
- 2 DISP (display) button
- 3 SEL (select) button
- 4 Control dial
- 5 Display window
- 6 **↶** (angle) button
- 7 **▲** (eject) button
- 8 **▲** (up) button / +10 button
▼ (down) button / -10 button
- 9 MODE button
- 10 Remote sensor
 - *DO NOT expose the remote sensor to strong light (direct sunlight or artificial lighting).*
- 11 SOURCE button
- 12 BAND button
- 13 Reset button
- 14 EQ (equalizer) button
- 15 MO (monaural) button
- 16 SSM (Strong-station Sequential Memory) button
- 17 INT (intro) button
- 18 RPT (repeat) button
- 19 RND (random) button
- 20 Number buttons
- 21 **⏮** **⏪** **⏩** **⏭** buttons
- 22 **⏏** (control panel release) button

Display window

- 23 Disc information indicators—TAG (ID3 Tag), **📁** (track/file), **📁** (folder)
- 24 MP3 indicator
- 25 CH (CD changer) indicator
 - *Lights up only when CD-CH is selected for the playback source.*
- 26 CD indicator
- 27 LINE indicator—Only for KD-AR760
- 28 WMA indicator
- 29 Main display
- 30 Equalizer pattern indicator
Audio level indicator
- 31 EQ (equalizer) indicator
- 32 Band indicators—FM1, FM2, FM3, AM
- 33 Tuner reception indicators—ST (stereo), MO (monaural)
- 34 Playback mode / item indicators—**📁** (folder), **📀** (disc), RND (random), INT (intro), RPT (repeat)
- 35 TRACK indicator
- 36 Source / clock display
- 37 LOUD (loudness) indicator
- 38 Audio level indicator / Volume level indicator

Remote controller — RM-RK50

Installing the lithium coin battery (CR2025)

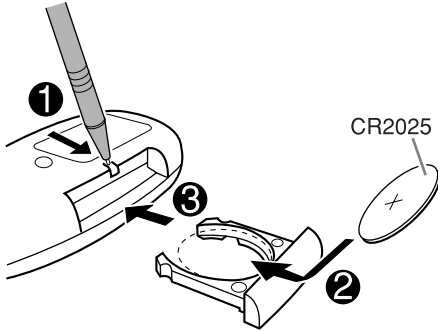

- When operating, aim the remote controller directly at the remote sensor on the receiver. Make sure there is no obstacle in between.

Warning:

- Store the battery in a place where children cannot reach to avoid risk of accident.
- To prevent the battery from over-heating, cracking, or starting a fire:
 - Do not recharge, short, disassemble, or heat the battery or dispose of it in a fire.
 - Do not leave the battery with other metallic materials.
 - Do not poke the battery with tweezers or similar tools.
 - Wrap the battery with tape and insulate when throwing away or saving it.

Caution:

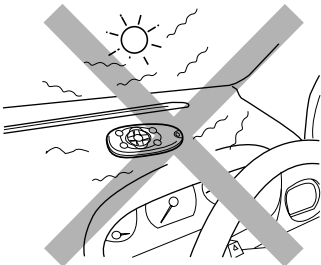

Main elements and features

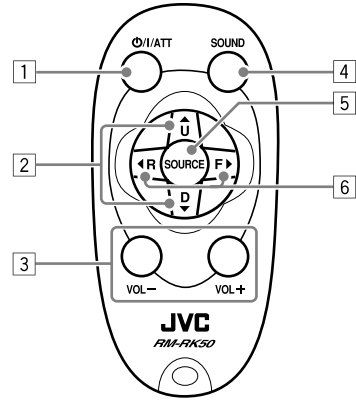

- 1** \odot /I/ATT (standby/on/attenuator) button
 - Turns on and off the power and also attenuates the sound.
- 2** \blacktriangle U (up) / D (down) \blacktriangledown buttons
 - \blacktriangle U: Changes the FM/AM bands.
 - D \blacktriangledown : Changes the preset stations.
 - Changes the folder on the MP3/WMA discs.
 - While playing an MP3 disc on an MP3-compatible CD changer:
 - Changes the disc if pressed briefly.
 - Changes the folder if pressed and held.
 - While listening to the SIRIUS radio:
 - Changes the categories.
- 3** VOL – / VOL + buttons
 - Adjusts the volume level.
- 4** SOUND button
 - Selects the sound mode (iEQ: intelligent equalizer).
- 5** SOURCE button
 - Selects the source.
- 6** \blacktriangleleft R (reverse) / F (forward) \blacktriangleright buttons
 - Searches for stations if pressed briefly.
 - Fast-forwards or reverses the track if pressed and held.
 - Changes the tracks on the disc.
 - While listening to the SIRIUS radio:
 - Changes the channels if pressed briefly.
 - Changes the channels rapidly if pressed and held.

Basic operations

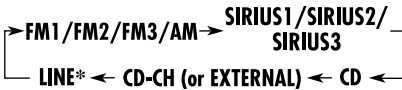
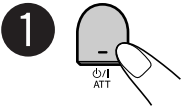
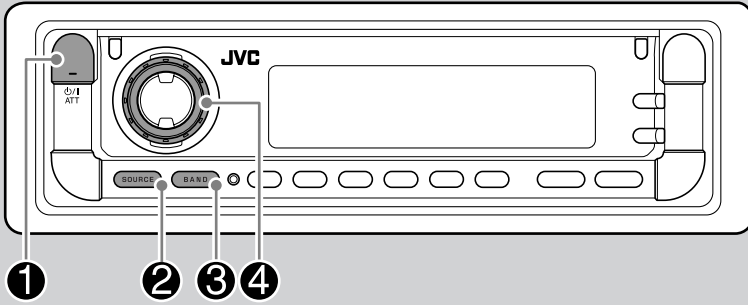

You cannot select some sources if they are not ready.

* Only for KD-AR760.

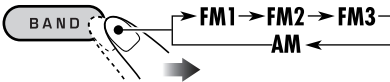

- For SIRIUS® radio only

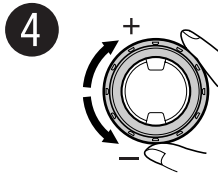
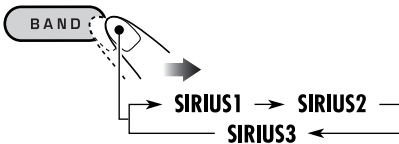

Volume level appears.

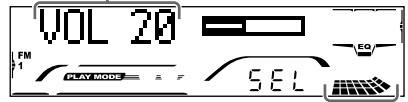

Volume level indicator



To drop the volume in a moment (ATT)

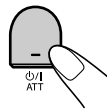

To restore the sound, press it again.

To turn off the power

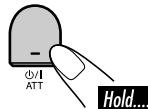

Canceling the display demonstrations

If no operations are done for about 20 seconds, display demonstration starts.

[Initial: DEMO ON]—see page 20.

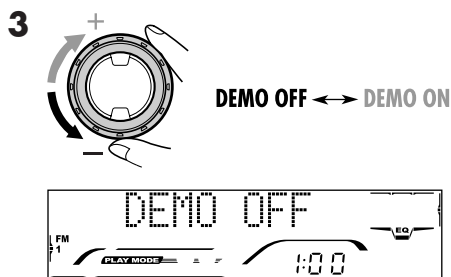
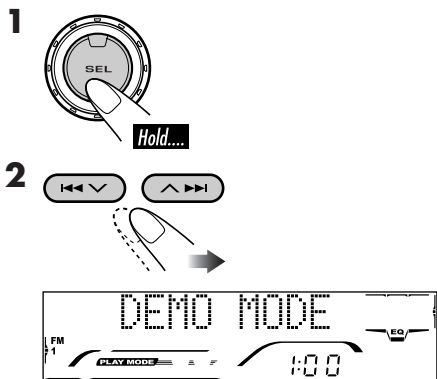

4 Finish the procedure.



To activate the display demonstration

In step **3** above...

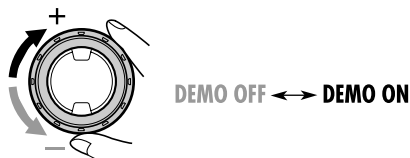

Setting the clock

- 1**
-
- Hold...**
- 2** Set the hour and minute.
- 1** Select “CLOCK HOUR,” then adjust the hour.
 - 2** Select “CLOCK MINUTE,” then adjust the minute.
-
-
- 3** Finish the procedure.



To check the current clock time when the power is turned off

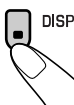

Listening to the radio

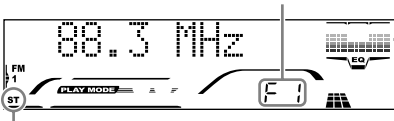
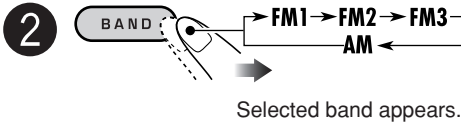
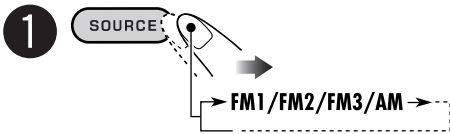
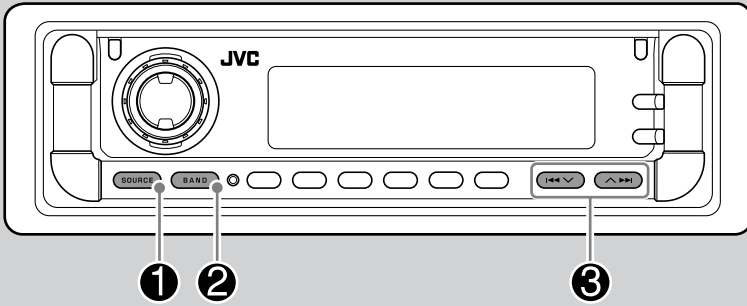

Lights up when receiving an FM stereo broadcast with sufficient signal strength.

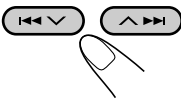

When a station is received, searching stops.

To stop searching, press the same button again.

To tune in to a station manually

In step 2 on the left...

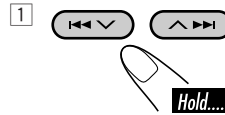

2 Select the desired station frequencies.

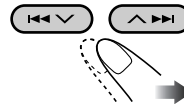

When an FM stereo broadcast is hard to receive

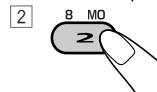
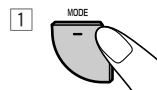

Lights up when monaural mode is activated.

Reception improves, but stereo effect will be lost.

To restore the stereo effect, repeat the same procedure so that the MO indicator goes off.

Storing stations in memory

You can preset six stations for each band.

FM station automatic presetting—SSM (Strong-station Sequential Memory)

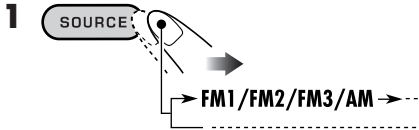

2 Select the FM band (FM1 – FM3) you want to store into.

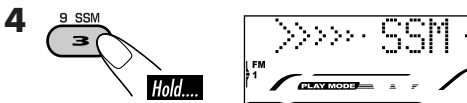
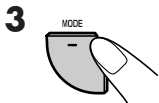
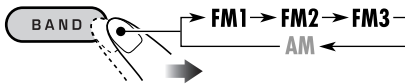

“SSM” appears, then disappears when automatic presetting is over.

Local FM stations with the strongest signals are searched and stored automatically in the FM band.

Manual presetting

Ex.: Storing FM station of 92.5 MHz into the preset number 4 of the FM1 band.

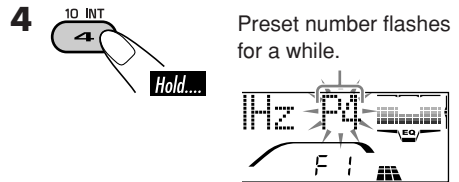
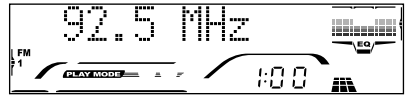
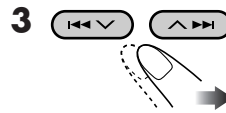
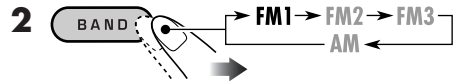
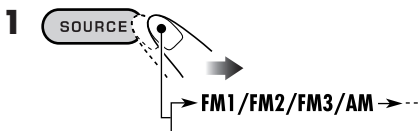

Preset number flashes for a while.

Listening to a preset station

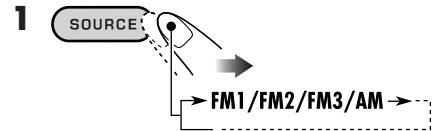

3 Select the preset station (1 – 6) you want.

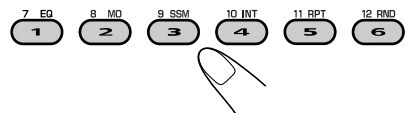

or

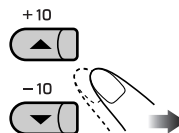

Disc operations

Playing a disc in the receiver

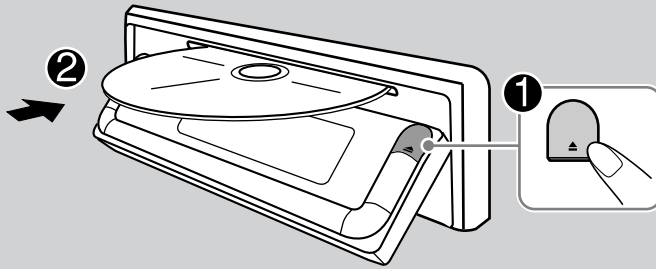

All tracks will be played repeatedly until you stop playback.

* The receiver draws the disc, then the control panel goes back to previous position (see page 24).

About MP3 and WMA discs

MP3 and WMA (Windows Media® Audio) "tracks" (words "file" and "track" are used interchangeably) are recorded in "folders."

• When inserting an MP3 or a WMA disc:

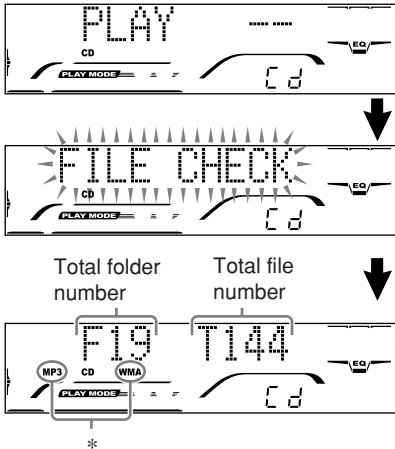

When playback starts, disc information will automatically appear (see page 15).

* Either the MP3 or WMA indicator lights up depending on the detected file.

• When inserting an audio CD or a CD Text disc:

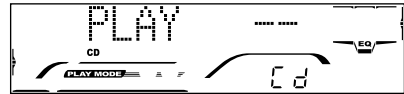

Total playing time of the inserted disc Total track number of the inserted disc



CD Text: Disc title/performer →
Track title appear automatically.

Elapsed playing time Current track number



To stop play and eject the disc

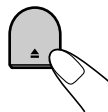

Playing discs in the CD changer

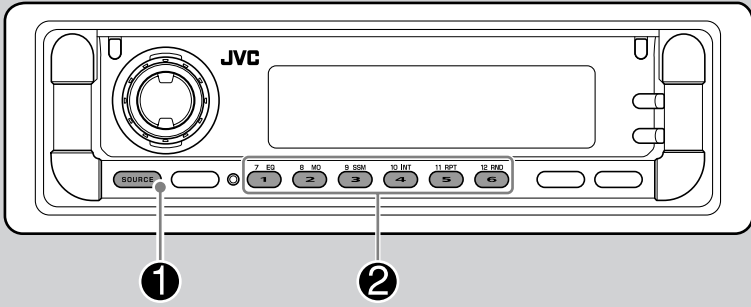

About the CD changer

It is recommended to use the JVC MP3-compatible CD changer with your receiver.

- You can also connect other CH-X series CD changers (except CH-X99 and CH-X100). However, they are not compatible with MP3 discs, so you cannot play back MP3 discs.
- You cannot use the KD-MK series CD changers with this receiver.
- Disc text information recorded in the CD Text can be displayed when a JVC CD Text compatible CD changer is connected.

Before operating your CD changer:

- Refer also to the Instructions supplied with your CD changer.
- You cannot control and play any WMA disc in the CD changer.

1

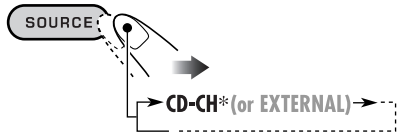

** If you have changed "EXTERNAL IN" setting to "EXTERNAL IN" (see page 22), you cannot select the CD changer.*

2

Select a disc.

For disc number from 01 – 06:

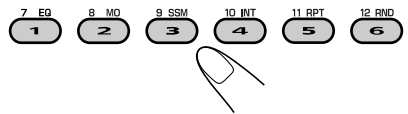

For disc number from 07 – 12:

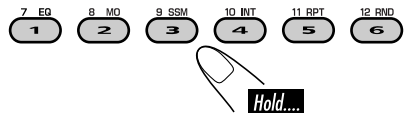

• When the current disc is an MP3 disc:

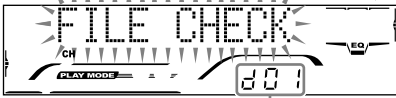
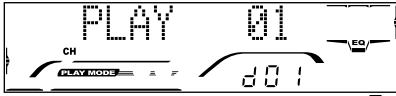
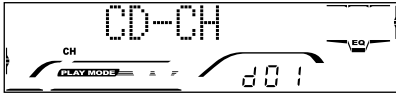

Selected disc number

Folder name*



Selected folder number

When playback starts, disc information will automatically appear (see page 15).

* "ROOT" appears if no folder is included in the disc.

• When the current disc is an audio CD or a CD Text disc:

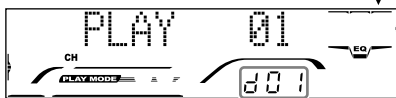
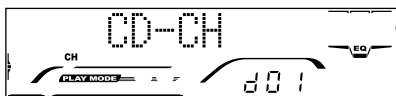

Selected disc number

CD Text: Disc title/performer →
Track title appear automatically.

Elapsed playing time Current track number



To fast-forward or reverse the track

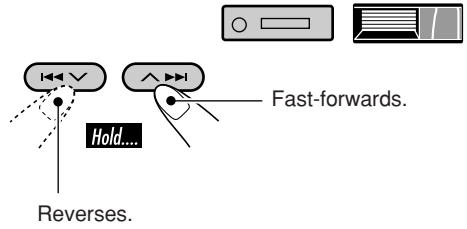

To go to the next or previous tracks

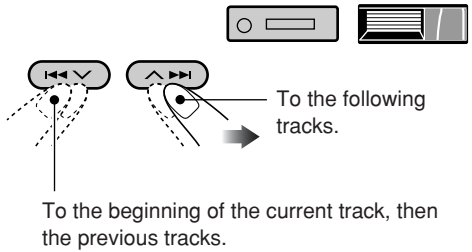

To go to the next or previous folders

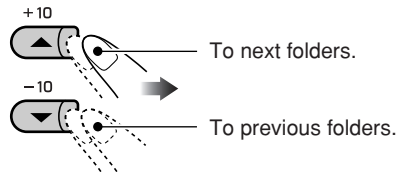
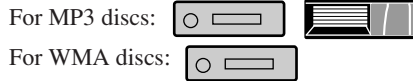

To locate a particular track (for CD) or folder (for MP3 or WMA discs) directly



To select a number from 01 – 06:

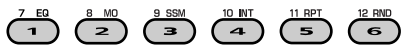

To select a number from 07 – 12:



- To use folder search on MP3/WMA discs, it is required that folders are assigned with 2 digit numbers at the beginning of their folder names—01, 02, 03, and so on.

- To select a particular track in a folder (for MP3 or WMA disc) after selecting a folder:

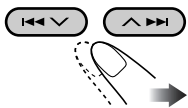

Other main functions

■ Skipping a track quickly during play



- For MP3 or WMA disc, you can skip a track within the same folder.

Ex.: To select track 32 while playing track 6

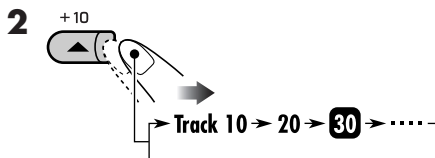
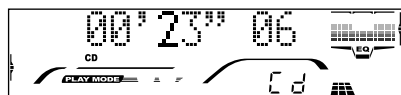
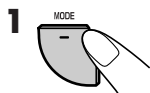

First time you press +10 or -10 button, the track skips to the nearest higher or lower track with a track number of multiple ten (ex. 10th, 20th, 30th).

Then each time you press the button, you can skip 10 tracks.

- After the last track, the first track will be selected and vice versa.

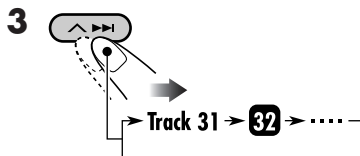

■ Prohibiting disc ejection



You can lock a disc in the loading slot.

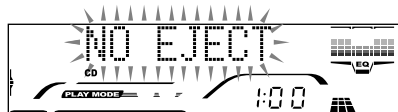

To cancel the prohibition, repeat the same procedure.

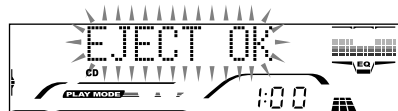

Changing the display information

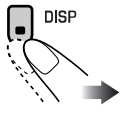

■ While playing an audio CD or a CD Text (/)

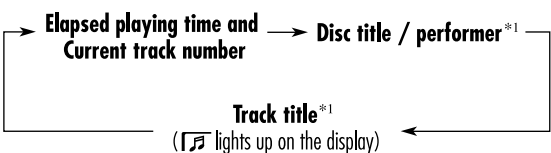

*1 If the current disc is an audio CD, "NO NAME" appears. To assign a title to an audio CD, see page 23.

■ While playing an MP3 (/) or WMA () disc

- When "TAG DISPLAY" is set to "TAG DISP ON" (see page 22)

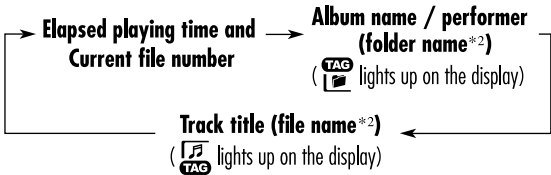

*2 If an MP3/WMA file does not have ID3 tags, folder name and file name appear. In this case, the TAG indicator will not light up.

- When "TAG DISPLAY" is set to "TAG DISP OFF"

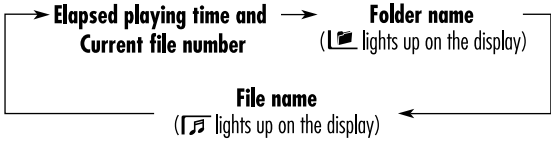

Selecting the playback modes

You can use only one of the following playback modes at a time.

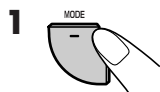

2 Select your desired playback mode.

Repeat play

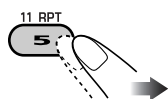

Ex.: When "TRK RPT" is selected while playing an MP3 disc in the receiver

Mode

Plays repeatedly

- TRK RPT:** The current track.
• RPT lights up.
- FLDR RPT*1:** All tracks of the current folder.
• and RPT light up.
- DISC RPT*2:** All tracks of the current disc.
• and RPT light up.
- RPT OFF:** Cancels repeat play.

Random play

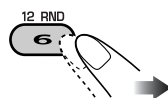

Ex.: When "DISC RND" is selected while playing an MP3 disc in the receiver

Mode

Plays at random

- FLDR RND*1:** All tracks of the current folder, then tracks of the next folder and so on.
• and RND light up.
- DISC RND:** All tracks of the current disc.
• and RND light up.
- MAG RND*2:** All tracks of the inserted discs.
• RND lights up.
- RND OFF:** Cancels random play.

Intro scan

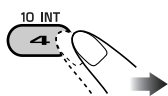

Ex.: When "TRK INT" is selected while playing an MP3 disc in the receiver

Mode

Plays at the beginnings

- TRK INT:** All tracks of the current disc.
• INT lights up.
- FLDR INT*1:** The first track of every folder of the current disc.
• and INT light up.
- DISC INT*2:** The first tracks of the inserted discs.
• and INT light up.
- INT OFF:** Cancels intro scan.

*1 Only while playing an MP3 (/) or WMA () disc.

*2 Only while playing discs in the CD changer ().

Sound adjustments

Selecting preset sound modes (iEQ: intelligent equalizer)

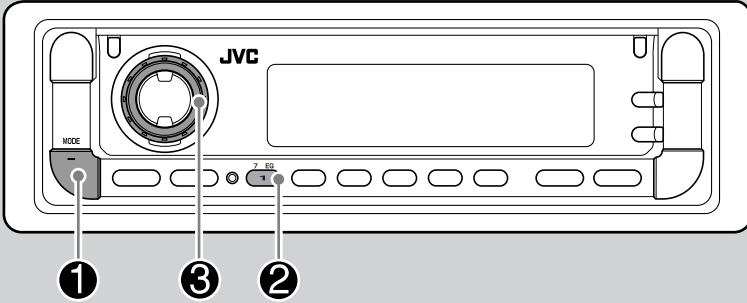

You can select a preset sound mode suitable to the music genre.

- 1
- 2
- 3

FLAT (no sound mode is applied) ⇄
HARD ROCK ⇄ **R&B** ⇄ **POP** ⇄
JAZZ ⇄ **DANCE MUSIC** ⇄
COUNTRY ⇄ **REGGAE** ⇄
CLASSIC ⇄ **USER 1** ⇄ **USER 2** ⇄
USER 3 ⇄ (back to the beginning)

Indication pattern changes for each sound mode.

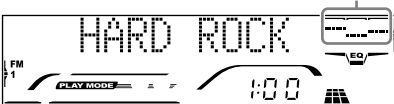

Ex.: When "HARD ROCK" is selected

To select the sound mode directly

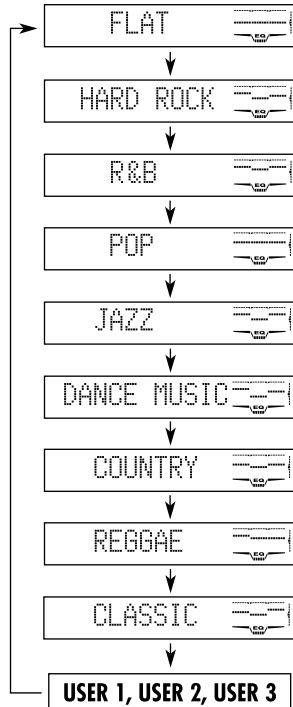
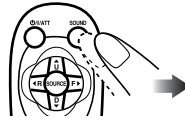

Adjusting the sound

You can adjust the sound characteristics to your preference.

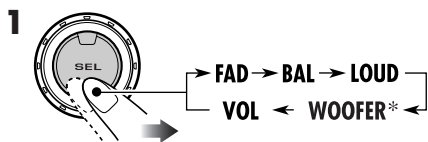

* Only for KD-AR760.

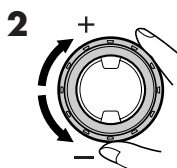

Indication pattern changes as you adjust the fader or balance.

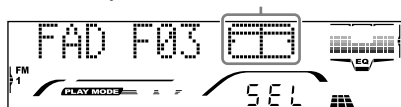

Ex.: When "FAD" is selected

Indication	To do:	Range
FAD* ¹ (fader)	Adjust the front and rear speaker balance.	R06 (Rear only) to F06 (Front only)
BAL (balance)	Adjust the left and right speaker balance.	L06 (Left only) to R06 (Right only)
LOUD (loudness)	Boost low and high frequencies to produce a well-balanced sound at low volume level.	LOUD ON ↓ LOUD OFF
WOOFER* ²	Adjust the subwoofer output level.	00 (min.) to 08 (max.)
VOL* ³ (volume)	Adjust the volume.	00 (min.) to 30 or 50 (max.)* ⁴

*¹ If you are using a two-speaker system, set the fader level to "00."

*² Only for KD-AR760: This takes effect only when a subwoofer is connected.

*³ Normally the control dial works as the volume control. So you do not have to select "VOL" to adjust the volume level.

*⁴ Depending on the amplifier gain control setting. (See page 22 for details.)

Storing your own sound adjustments

You can adjust the sound modes and store your own adjustments in memory.

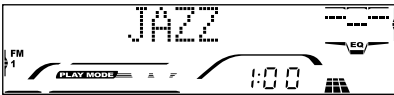
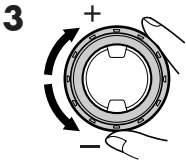
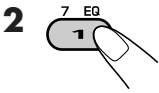
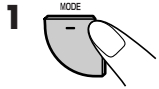

Ex.: When "JAZZ" is selected

4 Select the sound elements to adjust.



LOW LEVEL* → LOW FREQ →
 LOW WIDTH → MID LEVEL* →
 MID WIDTH → HI (high) LEVEL* →
 HI (high) FREQ → (back to the beginning)

- **LEVEL (LOW, MID, HI):**
Adjust the enhancement level.
- **FREQ (LOW, HI):**
Select the center frequency to adjust.
- **WIDTH (LOW, MID):**
Select the band width level.

* By pressing ◀◀ ▼ or ▲ ▶▶, you can directly move as follows:



5 Adjust the selected sound elements.

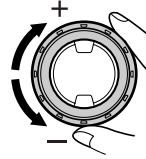

Indication	Preset values		
	LOW	MID	HI
LEVEL	-06 (min.) to +06 (max.)	-06 (min.) to +06 (max.)	-06 (min.) to +06 (max.)
FREQ.	60Hz 80Hz 100Hz 120Hz	_____	8kHz 10kHz 12kHz 15kHz
WIDTH	1 (min.) to 4 (max.)	1 (min.) to 2 (max.)	_____

6 Repeat steps 4 and 5 to set (or adjust) the other sound elements.

7 Select one of the user sound modes (USER 1, USER 2, USER 3).

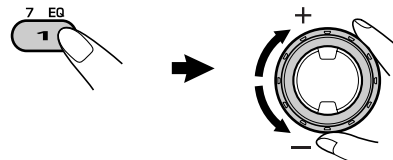

8 Store the adjustments.

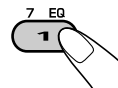

General settings — PSM

Basic procedure

You can change PSM (Preferred Setting Mode) items listed (except for SID) in the table that follows.

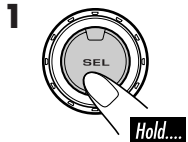

2 Select a PSM item.

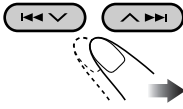

Ex.: When you select "DIMMER MODE"

3 Adjust the PSM item selected.

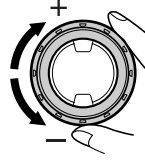

4 Repeat steps 2 and 3 to adjust the other PSM items if necessary.

5 Finish the procedure.



Indications	Selectable settings, [reference page]
DEMO MODE Display demonstration	DEMO ON: [Initial]; Display demonstration will be activated automatically if no operation is done for about 20 seconds, [8]. DEMO OFF: Cancels.
CLOCK HOUR Hour adjustment	1 – 12, [8] [Initial: 1 (1:00)]
CLOCK MINUTE Minute adjustment	00 – 59, [8] [Initial: 00 (1:00)]
CLOCK DISP Clock display	CLK DISP ON: [Initial]; Clock display is shown on the lower part of the display. CLK DISP OFF: Current source indication (ex. station band, disc number, etc.) is shown on the lower part of the display. • Pressing DISP repeatedly will show the other information for about 5 seconds.

Indications	Selectable settings, [reference page]
CLOCK ADJUST *1 Clock adjustment	AUTO: <i>[Initial]</i> ; The built-in clock will be adjusted automatically using the clock data provided via the SIRIUS® radio channel. OFF: Cancels.
T-ZONE *1, *2 Time zone	Select your residential area from one of the following time zone for clock adjustment. EASTERN <i>[Initial]</i> ⇄ ATLANTIC ⇄ NEWFOUND ⇄ ALASKA ⇄ PACIFIC ⇄ MOUNTAIN ⇄ CENTRAL ⇄ (back to the beginning)
DST *1, *2 Daylight savings time	Activates this if your residential area is subject to DST. ON: <i>[Initial]</i> ; Activates daylight savings time. OFF: Cancels.
SID *1 SIRIUS® ID	The 12-digits SIRIUS identification number scrolls on the display after 5 seconds, [26]. • Press SEL to resume the previous display.
LEVELMETER Level/audio meter	LEVEL 1 <i>[Initial]</i> / LEVEL 2: Display the audio level meter with different illumination pattern. EQ & LEVEL: Display the equalizer pattern and the audio level meter. SILENT: Display the equalizer pattern and volume level meter.
DIMMER MODE Dimmer	DIMMER AUTO: <i>[Initial]</i> ; Dims the display when you turn on the headlights. DIMMER ON: Activates dimmer. DIMMER OFF: Cancels.
TELEPHONE *3 Telephone muting	MUTING 1/MUTING 2: Select either one which mutes the sounds while using the cellular phone. • If CD or CD changer is selected as the source, playback pauses during telephone muting. MUTING OFF: <i>[Initial]</i> ; Cancels.
CONTRAST Display contrast	01 – 10: Adjust the display contrast to make the display indications clear and legible. <i>[Initial: 08]</i>

To be continued...

Indications	Selectable settings, [reference page]
SCROLL MODE * ⁴ Scroll	SCROLL ONCE: [Initial]; Scrolls the disc information once. SCROLL AUTO: Repeats scrolling (5-second interval in between). SCROLL OFF: Cancels. • Pressing DISP for more than one second can scrolls the display regardless of the setting.
WOOFER FREQ * ³ Subwoofer cutoff frequency	FREQ 55 Hz: Frequencies lower than 55 Hz are send to the subwoofer. FREQ 85 Hz: [Initial]; Frequencies lower than 85 Hz are send to the subwoofer. FREQ 115 Hz: Frequencies lower than 115 Hz are send to the subwoofer.
LINE ADJ * ³ Line input level	VOL 00 – VOL 05: Adjust the line input level properly when an external component is connected to the LINE IN plugs. [Initial: VOL 00]
EXTERNAL IN * ⁵ External input	CHANGER: [Initial]; To use a JVC CD changer, [12]. EXTERNAL IN: To use another external component (other than SIRIUS DLP), [25].
TAG DISPLAY Tag display	TAG DISP ON: [Initial]; Shows the ID3 tag while playing MP3/WMA tracks, [15]. TAG DISP OFF: Cancels.
AMP.GAIN Amplifier gain control	You can change the maximum volume level of this receiver. LOW POWER: VOL 00 – VOL 30 (Select this if the maximum power of the speaker is less than 50 W to prevent them from damaging the speaker.) HIGH POWER: [Initial]; VOL 00 – VOL 50 OFF * ³ : Deactivates the built-in amplifier.
AREA Tuner channel interval	AREA EU: Select this when using the receiver in an area other than North and South America. (FM: 50 kHz—manual tuning, 100 kHz—auto search; AM: 9 kHz) AREA US: [Initial]; Select this when using the receiver in North or South America. (FM: 200 kHz; AM: 10 kHz)

*1 Displayed only when SIRIUS radio is connected.

*2 Displayed only when "CLOCK ADJUST" is set to "AUTO."

*3 Only for KD-AR760.

*4 Some characters or symbols will not be shown (and will be blanked) or substituted on the display.

*5 Displayed only when one of the following sources is selected—FM, AM, CD, or LINE IN (only for KD-AR760).

Other main functions

Assigning titles to the sources

You can assign names to station frequencies, CDs (both in this receiver and in the CD changer), and external component (Line Input—only for KD-AR760).

Sources	Maximum number of characters
Station frequencies	Up to 9 characters (up to 30 station frequencies including both FM and AM)
CDs/CD-CH*1	Up to 32 characters (up to 30 discs)
External component (Line Input)*2	Up to 12 characters

*1 You cannot assign a name to a CD Text or an MP3/WMA disc.

*2 Only for KD-AR760.

1 Select the sources.

- For station frequencies: Select tuner.
- For a CD in this receiver: Insert a CD.
- For CDs in the CD changer: Select “CD-CH,” then select a disc number.

2 Enter the disc title assignment mode.

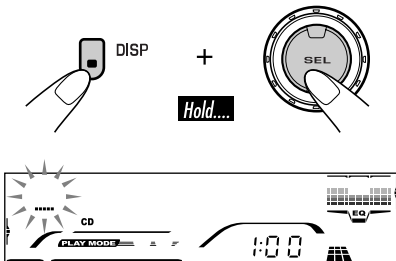

Ex.: When you select CD as the source

3 Assign a title.

1 Select a character set.

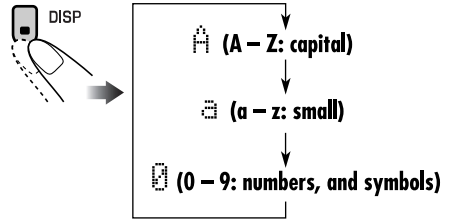

2 Select a character.

For available characters, see page 29.

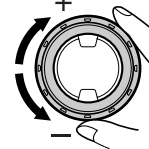

3 Move to the next (or previous) character position.

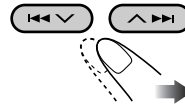

4 Repeat steps 1 to 3 until you finish entering the title.

4 Finish the procedure.



To erase the entire title



Changing the control panel angle

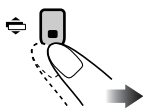

The control panel changes its angle as follows:

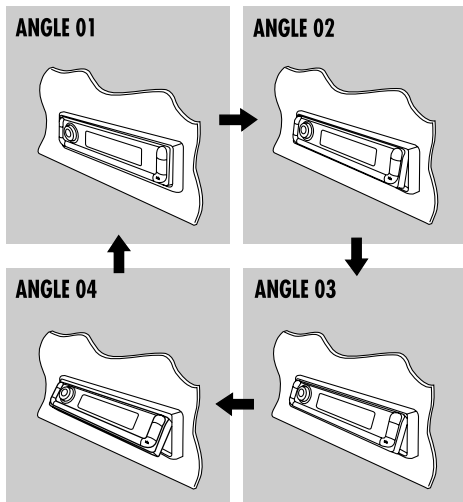

Caution:

Do not insert your finger behind the control panel.

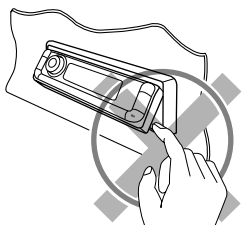

Detaching the control panel

When detaching or attaching the control panel, be careful not to damage the connectors on the back of the control panel and on the panel holder.

■ Detaching the control panel

Before detaching the control panel, be sure to turn off the power.

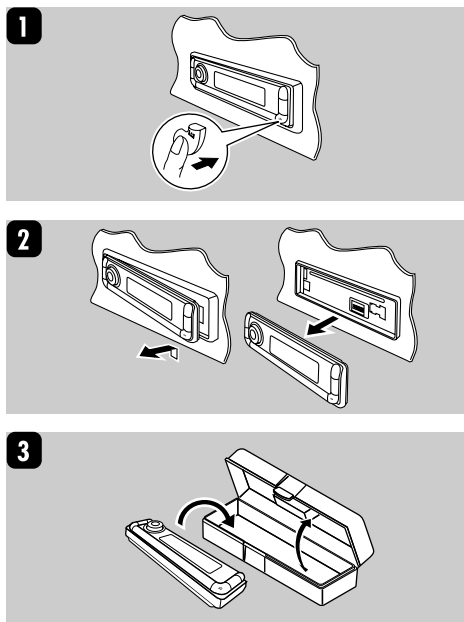

■ Attaching the control panel

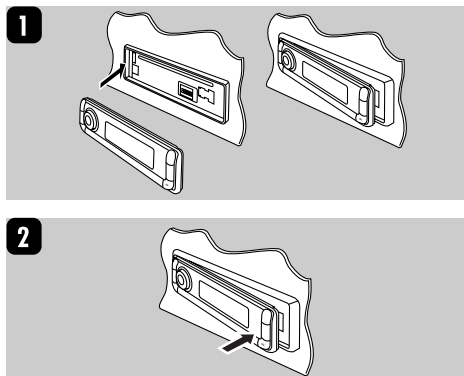

External component operations

Playing an external component

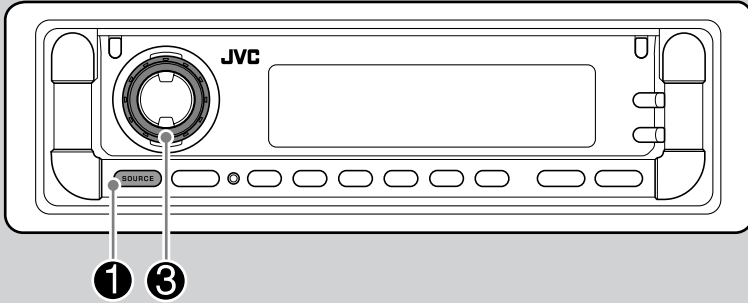

For KD-AR760:

You can connect an external component to the LINE IN plugs on the rear.

For KD-AR760/KD-G710:

You can connect an external component to the CD changer jack on the rear using the Line Input Adapter KS-U57 (not supplied).

Before operating the external component, select the external input correctly (see page 22).

- For connection, see Installation/Connection Manual (separate volume).

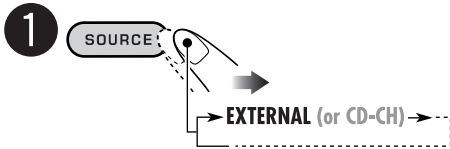

- If “EXTERNAL” does not appear, see page 22 and select the external input (“EXTERNAL IN”).

- 2** Turn on the connected component and start playing the source.

- 3** Adjust the volume.

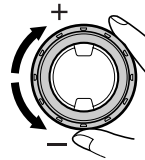

- 4** Adjust the sound as you want. (See pages 17 – 19.)

SIRIUS® radio operations

About SIRIUS radio

SIRIUS is a satellite radio that can deliver digital-quality sound.

SIRIUS has 65 music channels which are all commercial-free and 50 channels of sports, news, and entertainment programs.

You can enjoy and control the SIRIUS radio digital entertainment channels from the receiver by connecting the JVC SIRIUS radio DLP—Down Link Processor (optionally purchased) to the CD changer jack on the rear.

- You can also connect the JVC SIRIUS radio PnP (Plug and Play), KT-SR1000 or KT-SR2000, using the JVC SIRIUS radio adapter, KS-U100K (not supplied). By turning on the power of the receiver, you can turn on/off the JVC PnP. However, you cannot control it from this receiver.

GCI (Global Control Information) update:

- If channels are updated after subscription, updating starts automatically. “UPDATING” flashes and no sound can be heard.
- Update takes a few minutes to complete.
- During update, you cannot operate your SIRIUS radio.

Before operating your SIRIUS radio:

- For connection, see Installation/ Connection Manual (separate volume).
- Refer also to the Instructions supplied with your SIRIUS radio.

Before you can listen to JVC DLP, activate your SIRIUS subscription after connection:

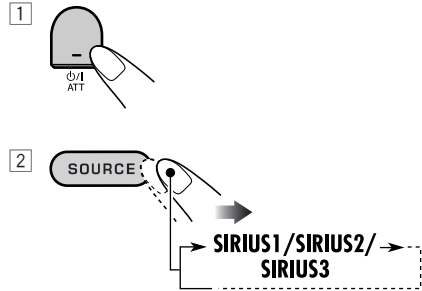

JVC DLP starts updating all the SIRIUS channels.

“UPDATING” flashes on the display for a few minutes. No sound can be heard during update.

Once completed, JVC DLP tunes in to the preset channel, CH184.

- 3 Check your SIRIUS ID, see page 21.
- 4 Contact SIRIUS on the internet at <http://activate.siriusradio.com/> to activate your subscription, or you can call SIRIUS toll-free at 1-888-539-SIRIUS (7474). “SUB UPDT PRESS ANY KEY” scrolls on the display once subscription has been completed.

Listening to the SIRIUS® radio

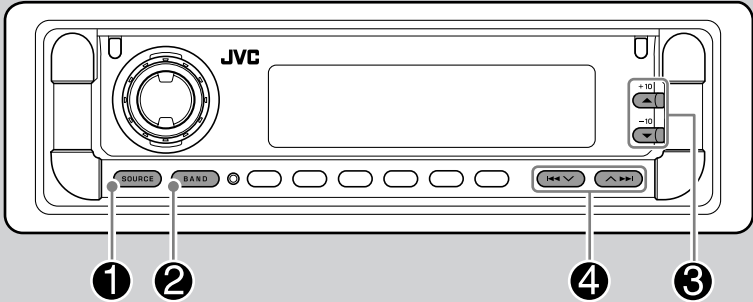

1 SOURCE

SIRIUS1/SIRIUS2/
SIRIUS3

2 BAND

SIRIUS1 → SIRIUS2
SIRIUS3 ←

3 Select a category.

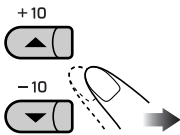

You can tune in to all the channels of every category by selecting “ALL.” Selecting a particular category (SPORTS, ENTERTAINMENT, etc.) allows you to enjoy only the channels from the selected category.

4 Select a channel for listening.

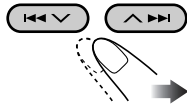

Press and hold these buttons change the channels rapidly.

- When changing the category or channel, invalid and unsubscribed channels are skipped automatically.

Storing channels in memory

You can preset six channels for each band.

Ex.: Storing a channel into preset number 4.

1 Perform steps ① to ④ on page 27, to tune in to a channel you want.

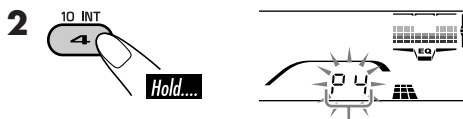

Preset number flashes for a while.

To change the display information while listening to a channel

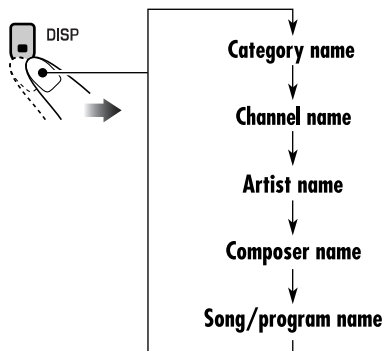

Listening to a preset channel

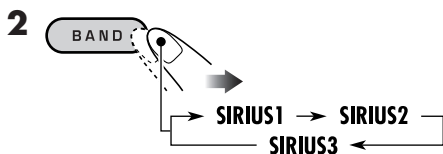
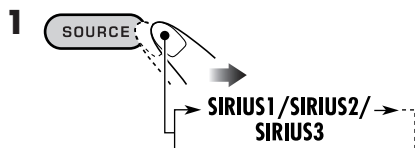

3 Select the preset channel (1 – 6) you want.

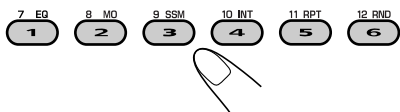

Maintenance

How to clean the connectors

Frequent detachment will deteriorate the connectors.

To minimize this possibility, periodically wipe the connectors with a cotton swab or cloth moistened with alcohol, being careful not to damage the connectors.

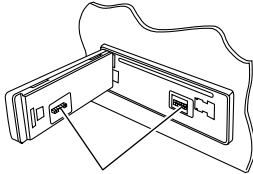

Connector

Moisture condensation

Moisture may condense on the lens inside the CD player in the following cases:

- After starting the heater in the car.
- If it becomes very humid inside the car.

Should this occur, the CD player may malfunction. In this case, eject the disc and leave the receiver turned on for a few hours until the moisture evaporates.

How to handle discs

When removing a disc from its case, press down the center holder of the case and lift the disc out, holding it by the edges.

Center holder



- Always hold the disc by the edges. Do not touch its recording surface.

When storing a disc into its case, gently insert the disc around the center holder (with the printed surface facing up).

- Make sure to store discs into the cases after use.

To keep discs clean

A dirty disc may not play correctly. If a disc does become dirty, wipe it with a soft cloth in a straight line from center to edge.



- Do not use any solvent (for example, conventional record cleaner, spray, thinner, benzene, etc.) to clean discs.

To play new discs

New discs may have some rough spots around the inner and outer edges. If such a disc is used, this receiver may reject the disc.



To remove these rough spots, rub the edges with a pencil or ball-point pen, etc.

Available character

Capital letters

A	B	C	D	E	F	G	H	I	J	K	L	M	N
O	P	Q	R	S	T	U	V	W	X	Y	Z	space	

Small letters

a	b	c	d	e	f	g	h	i	j	k	l	m	n
o	p	q	r	s	t	u	v	w	x	y	z	space	

Number and symbols

0	1	2	3	4	5	6	7	8	9	!	"	#	\$
%	&	'	()	*	+	,	-	.	/	:	;	<
=	>	?	@	_	`	space							

Do not use the following discs:

Wrap disc



Sticker



Sticker residue

Disc



Stick-on label

More about this receiver

Basic operations

Turning off the power

- If you turn off the power while listening to a disc, disc play will start from where playback has been stopped previously, next time you turn on the power.

Selecting the sources

- When no disc is loaded in the receiver, “CD” cannot be selected.
- Without connecting to the SIRIUS radio or CD changer, “SIRIUS” or “CD-CH” cannot be selected.

Tuner operations

Storing stations in memory

- During SSM search...
 - All previously stored stations are erased and stations are stored newly.
 - Received stations are preset in No. 1 (lowest frequency) to No. 6 (highest frequency).
 - When SSM is over, the station stored in No. 1 will be automatically tuned in.
- When storing a station manually, a previously preset station is erased when a new station is stored in the same preset number.

Disc operations

General

- This receiver has been designed to reproduce CDs/CD Texts, and CD-Rs (Recordable)/CD-RWs (Rewritable) in audio CD (CD-DA), MP3 and WMA format.
- When a disc has been loaded, selecting “CD” for the playback source starts disc play.

Inserting a disc

- When a disc is inserted upside down, the control panel moves down, and the disc automatically ejects from the loading slot.
- Do not insert 8 cm discs (single CD) and unusual shape discs (heart, flower, etc.) into the loading slot.

Playing a disc

- While fast-forwarding or reversing on an MP3 or WMA disc, you can only hear intermittent sounds.

Playing a CD-R or CD-RW

- Use only “finalized” CD-Rs or CD-RWs.
- This receiver can play back only the files of the same type which is first detected if a disc includes both audio CD (CD-DA) files and MP3/WMA files.
- This receiver can play back multi-session discs; however, unclosed sessions will be skipped while playing.
- Some CD-Rs or CD-RWs may not play back on this receiver because of their disc characteristics, and for the following causes:
 - Discs are dirty or scratched.
 - Moisture condensation occurs on the lens inside the receiver.
 - The pickup lens inside the receiver is dirty.
 - CD-R/CD-RW on which the files are written with “Packet Write” method.
 - There are improper recording conditions (missing data, etc.) or media conditions (stain, scratch, warp, etc.).
- CD-RWs may require a longer readout time since the reflectance of CD-RWs is lower than that of regular CDs.
- Do not use the following CD-Rs or CD-RWs:
 - Discs with stickers, labels, or protective seal stuck to the surface.
 - Discs on which labels can be directly printed by an ink jet printer.
 Using these discs under high temperatures or high humidity may cause malfunctions or damage to discs.

Playing an MP3/WMA disc

- This receiver can play back MP3/WMA files with the extension code <.mp3> or <.wma> (regardless of the letter case—upper/lower).
- This receiver can show the names of albums, artists (performer), and ID3 Tag (Version 1.0, 1.1, 2.2, 2.3, or 2.4) for MP3 files and for WMA files.

- This receiver can display only one-byte characters. No other characters can be correctly displayed.
- This receiver can play back MP3/WMA files meeting the conditions below:
 - Bit rate: 8 kbps — 320 kbps
 - Sampling frequency:
 - 48 kHz, 44.1 kHz, 32 kHz (for MPEG-1)
 - 24 kHz, 22.05 kHz, 16 kHz (for MPEG-2)
 - Disc format: ISO 9660 Level 1/ Level 2, Romeo, Joliet, Windows long file name
- The maximum number of characters for file/folder names vary among the disc format used (includes 4 extension characters—<.mp3> or <.wma>).
 - ISO 9660 Level 1: up to 12 characters
 - ISO 9660 Level 2: up to 31 characters
 - Romeo*: up to 128 (72) characters
 - Joliet*: up to 64 (36) characters
 - Windows long file name*: up to 128 (72) characters

* *The parenthetic figure is the maximum number of characters for file/folder names in case the total number of files and folders is 313 or more.*
- This receiver can recognize the total of 512 files, of 200 folders, and of 8 hierarchies.
- This receiver can play back the files recorded in VBR (variable bit rate).
The files recorded in VBR have a discrepancy in elapsed time display, and do not show the actual elapsed time. Especially, after performing the search function, this difference becomes noticeable.
- This receiver cannot play back the following files:
 - MP3 files encoded with MP3i and MP3 PRO formats.
 - MP3 files encoded in an unappropriated format.
 - MP3 files encoded with Layer 1/2.
 - WMA files encoded with lossless, professional, and voice formats.
 - WMA files which are not based upon Windows Media® Audio.

- WMA formatted files copy-protected with DRM.
- Files which have the data such as WAVE, ATRAC3, etc.
- The search function works but search speed is not constant.

Changing the source

- If you change the source, playback also stops (without ejecting the disc).
Next time you select “CD” for the playback source, disc play starts from where it has been stopped previously.

Ejecting a disc

- If the ejected disc is not removed within 15 seconds, the disc is automatically inserted again into the loading slot to prevent it from dust. (Disc will not play this time.)

General settings—PSM

- If you have change the setting from “TAG DISP OFF” to “TAG DISP ON” while playing MP3/WMA file, the tag display will be activated when the next file starts playing.
- If you change the “AMP.GAIN” setting from “HIGH POWER” to “LOW POWER” while the volume level is set higher than “VOL 30,” the receiver automatically changes the volume level to “VOL 30.”

Other main functions

- If you try to assign a title to a 31st disc or to the 31st station frequency, “NAME FULL” appears. Delete unwanted titles before assignment.
- Titles assigned to discs in the CD changer can also be shown if you playback the disc from the receiver.
- The control panel moves to its previous angle each time you turn on the power.

Troubleshooting

What appears to be trouble is not always serious. Check the following points before calling a service center.

	Symptoms	Causes	Remedies
General	<ul style="list-style-type: none"> • Sound cannot be heard from the speakers. 	<p>The volume level is set to the minimum level.</p> <p>Connections are incorrect.</p>	<p>Adjust it to the optimum level.</p> <p>Check the cords and connections.</p>
	<ul style="list-style-type: none"> • The receiver does not work at all. 	<p>The built-in microcomputer may have functioned incorrectly due to noise, etc.</p>	<p>Reset the receiver (see page 2).</p>
FM/AM	<ul style="list-style-type: none"> • SSM automatic presetting does not work. 	<p>Signals are too weak.</p>	<p>Store stations manually.</p>
	<ul style="list-style-type: none"> • Static noise while listening to the radio. 	<p>The antenna is not connected firmly.</p>	<p>Connect the antenna firmly.</p>
Disc playback	<ul style="list-style-type: none"> • Disc cannot be played back. 	<p>Disc is inserted upside down.</p>	<p>Insert the disc correctly.</p>
	<ul style="list-style-type: none"> • CD-R/CD-RW cannot be played back. • Tracks on the CD-R/CD-RW cannot be skipped. 	<p>CD-R/CD-RW is not finalized.</p>	<ul style="list-style-type: none"> • Insert a finalized CD-R/CD-RW. • Finalize the CD-R/CD-RW with the component which you used for recording.
	<ul style="list-style-type: none"> • Disc can be neither played back nor ejected. 	<p>Disc is locked.</p>	<p>Unlock the disc (see page 14).</p>
		<p>The CD player may have functioned incorrectly.</p>	<p>Eject the disc forcibly (see page 2).</p>
	<ul style="list-style-type: none"> • Disc sound is sometimes interrupted. 	<p>You are driving on rough roads.</p>	<p>Stop playback while driving on rough roads.</p>
		<p>Disc is scratched.</p>	<p>Change the disc.</p>
		<p>Connections are incorrect.</p>	<p>Check the cords and connections.</p>
	<ul style="list-style-type: none"> • “NO DISC” appears on the display. 	<p>Disc is inserted incorrectly.</p>	<p>Insert the disc correctly.</p>
<ul style="list-style-type: none"> • When “PUSH RESET” appears on the display. 	<p>There is something blocking the control panel movement.</p>	<p>Reset the receiver (see page 2).</p>	

	Symptoms	Causes	Remedies
MP3/WMA playback	<ul style="list-style-type: none"> Disc cannot be played back. 	No MP3/WMA tracks are recorded on the disc.	Change the disc.
		MP3/WMA tracks do not have the extension code <.mp3> or <.wma> in their file names.	Add the extension code <.mp3> or <.wma> to their file names.
		MP3/WMA tracks are not recorded in the format compliant with ISO 9660 Level 1, Level 2, Romeo, or Joliet.	Change the disc. (Record MP3/WMA tracks using a compliant application.)
	<ul style="list-style-type: none"> Noise is generated. 	The track played back is not an MP3/WMA file (although it has the extension code <.mp3> or <.wma>).	Skip to another track or change the disc. (Do not add the extension code <.mp3> or <.wma> to non-MP3 or WMA tracks.)
	<ul style="list-style-type: none"> A longer readout time is required ("FILE CHECK" keeps flashing on the display). 	Readout time varies due to the complexity of the folder/file configuration.	Do not use too many hierarchies and folders.
	<ul style="list-style-type: none"> Tracks cannot be played back as you have intended them to play. 	Playback order is determined when the files are recorded.	_____
	<ul style="list-style-type: none"> Elapsed playing time is not correct. 	This sometimes occurs during play. This is caused by how the tracks are recorded on the disc.	_____
	<ul style="list-style-type: none"> "NO FILES" appears on the display. 	The current disc does not contain any MP3/WMA tracks.	Insert a disc that contains MP3/WMA tracks.
<ul style="list-style-type: none"> Correct characters are not displayed (e.g. album name). 	This receiver can only display alphabets (capital: A – Z, small: a – z), numbers, and a limited number of symbols.	_____	

	Symptoms	Causes	Remedies
CD changer	• “NO DISC” appears on the display.	No disc is in the magazine. Disc is inserted upside down.	Insert disc into the magazine. Insert disc correctly.
	• “NO MAG” appears on the display.	No magazine is loaded in the CD changer.	Insert the magazine.
	• “RESET 8” appears on the display.	This receiver is not connected to the CD changer correctly.	Connect this receiver and the CD changer correctly and press the reset button of the CD changer.
	• “RESET 1” – “RESET 7” appears on the display.	_____	Press the reset button of the CD changer.
	• The CD changer does not work at all.	The built-in microcomputer may function incorrectly due to noise, etc.	Reset the receiver (see page 2).
SIRIUS	• “CALL 1-888-539-SIRIUS TO SUBSCRIBE” scrolls on the display.	Subscription has not been done.	Starts subscribing (see page 26).
	• “NO SIGNAL” scrolls on the display.	Signals are too weak.	Move to an area with stronger signals.
	• “NO ANTENNA” scrolls on the display.	The antenna is not connected firmly.	Connect the antenna firmly.
	• “NO CHANNEL” appears on the display for about 5 seconds, then returns to the previous display.	No broadcast on the selected channel.	Select another channel or continue listening to the previous channel.
	• “NO (information)*” appears or scrolls on the display.	No text information for the selected channel.	_____
	• No sound can be heard.	“UPDATING” flashes on the display.	The receiver is updating the channel information and it takes a few minutes to complete.
	• SIRIUS radio does not work at all.	The built-in microcomputer may function incorrectly due to noise, etc.	Reconnect the SIRIUS radio after a few seconds.

* NO CATEGORY, NO CHANNEL, NO ARTIST, NO COMPOSER, and NO SONG/PROGRAM

- Microsoft and Windows Media are either registered trademarks or trademarks of Microsoft Corporation in the United States and/or other countries.

Specifications

AUDIO AMPLIFIER SECTION

Power Output:

20 W RMS × 4 Channels at 4 Ω
and ≤ 1% THD+N

Signal to Noise Ratio:

80 dBA (reference: 1 W into 4 Ω)



Load Impedance: 4 Ω (4 Ω to 8 Ω allowance)

Equalizer Control Range:

Low: ±12 dB (60 Hz, 80 Hz, 100 Hz, 120 Hz)

Mid: ±12 dB

High: ±12 dB (8 kHz, 10 kHz, 12 kHz, 15 kHz)

Frequency Response: 40 Hz to 20 000 Hz

Line-In Level/Impedance:

KD-AR760: 1.5 V/20 kΩ load

Line-Out Level/Impedance:

KD-AR760: 5.0 V/20 kΩ load (full scale)

KD-G710: 4.0 V/20 kΩ load (full scale)

Output Impedance: 1 kΩ

Subwoofer-Out Level/Impedance:

KD-AR760: 2.0 V/20 kΩ load (full scale)

Other terminals:

CD changer, LINE IN (for KD-AR760),

SUBWOOFER (for KD-AR760)

TUNER SECTION

Frequency Range:

FM: 87.5 MHz to 107.9 MHz

(with channel interval set to 200 kHz)

87.5 MHz to 108.0 MHz

(with channel interval set to 50 kHz)

AM: 530 kHz to 1 710 kHz

(with channel interval set to 10 kHz)

531 kHz to 1 602 kHz

(with channel interval set to 9 kHz)

[FM Tuner]

Usable Sensitivity: 11.3 dBf (1.0 μV/75 Ω)

50 dB Quieting Sensitivity: 16.3 dBf (1.8 μV/75 Ω)

Alternate Channel Selectivity (400 kHz): 65 dB

Frequency Response: 40 Hz to 15 000 Hz

Stereo Separation: 35 dB

Capture Ratio: 1.5 dB

[AM Tuner]

Sensitivity: 20 μV

Selectivity: 35 dB

CD PLAYER SECTION

Type: Compact disc player

Signal Detection System: Non-contact optical pickup (semiconductor laser)

Number of channels: 2 channels (stereo)

Frequency Response: 5 Hz to 20 000 Hz

Dynamic Range: 96 dB

Signal-to-Noise Ratio: 98 dB

Wow and Flutter: Less than measurable limit

MP3 decoding format:

MPEG1/2 Audio Layer 3

Max. Bit Rate: 320 Kbps

WMA (Windows Media® Audio) decoding format:

Max. Bit Rate: 192 Kbps

GENERAL

Power Requirement:

Operating Voltage:

DC 14.4 V (11 V to 16 V allowance)

Grounding System: Negative ground

Allowable Operating Temperature:

0°C to +40°C (32°F to 104°F)

Dimensions (W × H × D):

Installation Size (approx.):

182 mm × 52 mm × 159 mm

(7-3/16" × 2-1/16" × 6-5/16")

Panel Size (approx.):

188 mm × 58 mm × 12 mm

(7-7/16" × 2-5/16" × 1/2")

Mass (approx.):

1.5 kg (3.4 lbs) (excluding accessories)

Design and specifications are subject to change without notice.

If a kit is necessary for your car, consult your telephone directory for the nearest car audio speciality shop.



Having TROUBLE with operation?

Please reset your unit

Refer to page of How to reset your unit

Still having trouble??

USA ONLY

Call 1-800-252-5722

<http://www.jvc.com>

We can help you!

JVC



EN, SP, FR

© 2004 Victor Company of Japan, Limited

1004DTSMdTJEIN

JVC KD-AR760/KD-G710

Installation/Connection Manual Manual de instalación/conexión Manuel d'installation/raccordement

GET0247-002A
[J]

1004DTSMDTJEIN
EN, SP, FR

ENGLISH

This receiver is designed to operate on **12 V DC, NEGATIVE ground electrical systems**. If your vehicle does not have this system, a voltage inverter is required, which can be purchased at JVC car audio dealers.

ESPAÑOL

Esta unidad está diseñada para funcionar con **12 V de CC, con sistemas eléctricos de masa NEGATIVA**. Si su vehículo no posee este sistema, será necesario un inversor de tensión, que puede ser adquirido en los concesionarios de JVC de equipos de audio para automóviles.

FRANÇAIS

Cet appareil est conçu pour fonctionner sur des sources de courant continu de **12 V à masse NEGATIVE**. Si votre véhicule n'offre pas ce type d'alimentation, il vous faut un convertisseur de tension, que vous pouvez acheter chez un revendeur d'autoradios JVC.

Parts list for installation and connection

The following parts are provided for this receiver. After checking them, please set them correctly.

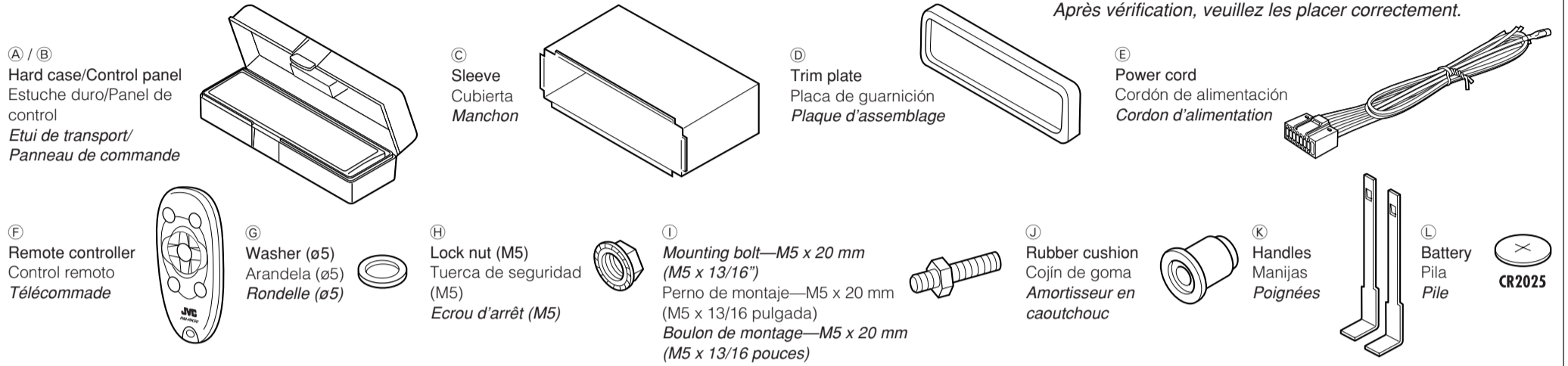

INSTALLATION (IN-DASH MOUNTING)

The following illustration shows a typical installation. If you have any questions or require information regarding installation kits, consult your JVC car audio dealer or a company supplying kits.

- If you are not sure how to install this receiver correctly, have it installed by a qualified technician.

INSTALACION (MONTAJE EN EL TABLERO DE INSTRUMENTOS)

La siguiente ilustración muestra una instalación típica. Si tiene alguna pregunta o necesita información acerca de las herramientas para instalación, consulte con su concesionario de JVC de equipos de audio para automóviles o a una compañía que suministra tales herramientas.

- Si usted no está seguro de cómo instalar correctamente la unidad, hágala instalar por un técnico cualificado.

INSTALLATION (MONTAGE DANS LE TABLEAU DE BORD)

L'illustration suivante est un exemple d'installation typique. Si vous avez des questions ou avez besoin d'information sur des kits d'installation, consultez votre revendeur d'autoradios JVC ou une compagnie d'approvisionnement.

- Si l'on n'est pas sûr de pouvoir installer correctement cet appareil, le faire installer par un technicien qualifié.

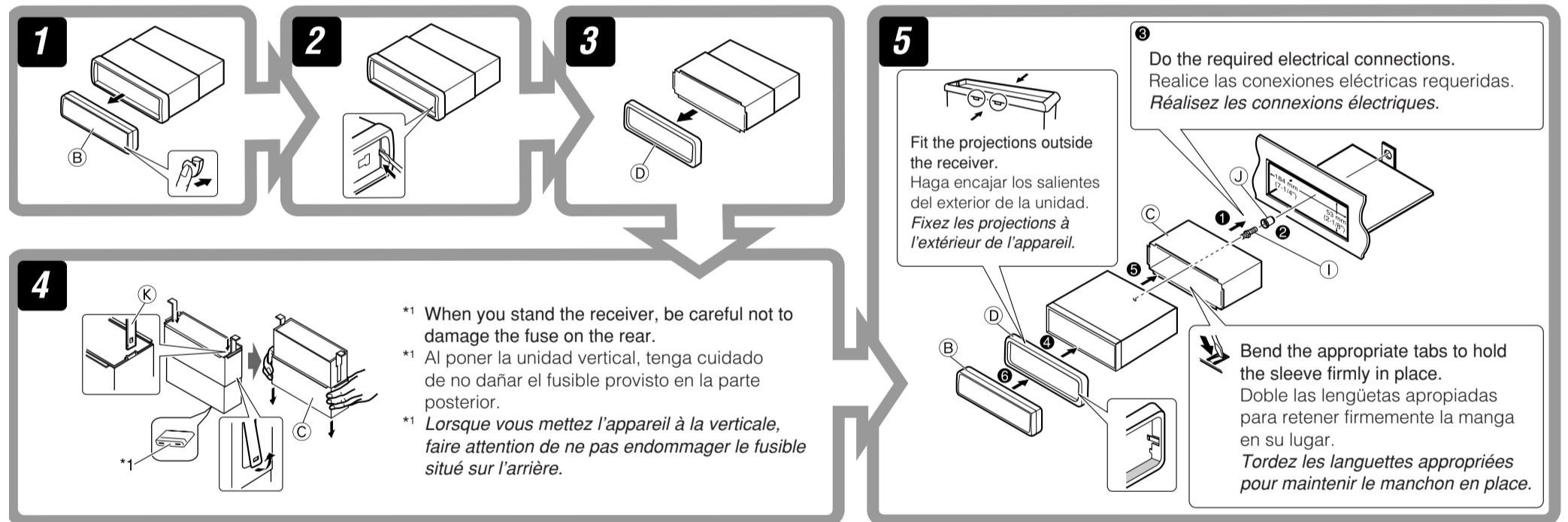

Removing the receiver / Extracción de la unidad / Retrait de l'appareil

Before removing the receiver, release the rear section.

Antes de extraer la unidad, libere la sección trasera.

Avant de retirer l'appareil, libérer la section arrière.

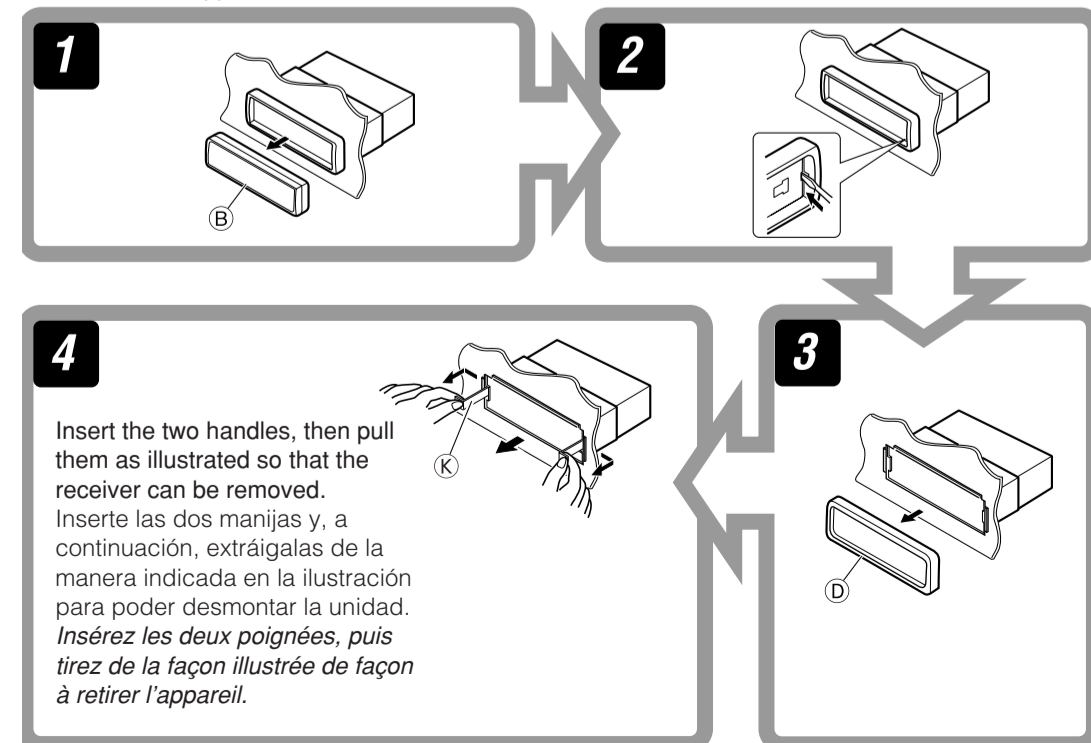

Caution when installing / Precaución en la instalación / Précautions lors de l'installation:

Fit the receiver into the mounting sleeve by using four corners of the trim plate.

- DO NOT press the panel (shaded in the illustration).
- NO presione el panel (sombreado en la ilustración).
- Fixez l'autoradio sur le manchon de montage en utilisant les quatre coins de la plaque de garniture.
- NE Poussez PAS sur le panneau (en gris sur l'illustration).

When using the optional stay / Cuando emplea un soporte opcional / Lors de l'utilisation du hauban en option

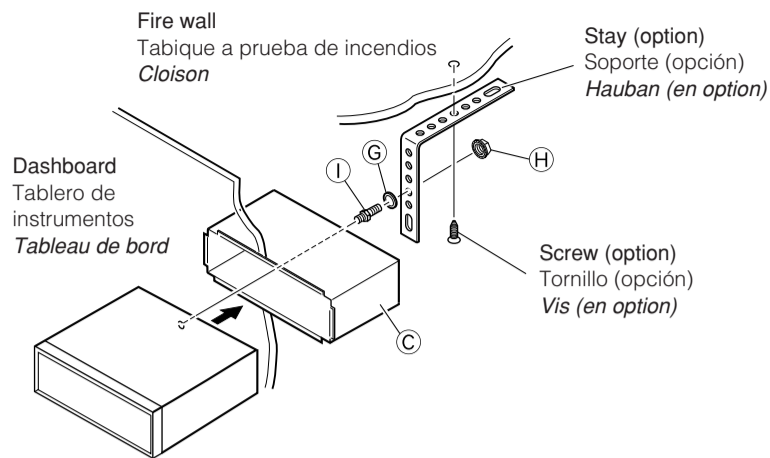

Install the receiver at an angle of less than 30°.
 Instale la unidad a un ángulo de menos de 30°.
 Installez l'appareil avec un angle de moins de 30°.

When installing the receiver without using the sleeve / Instalación de la unidad sin utilizar la cubierta / Lors de l'installation de l'appareil sans utiliser de manchon

In a Toyota for example, first remove the car radio and install the receiver in its place.
 En un Toyota por ejemplo, primero retire la radio del automóvil y luego instale la unidad en su lugar.
 Par exemple dans une Toyota, retirer d'abord l'autoradio et installer l'appareil à la place.

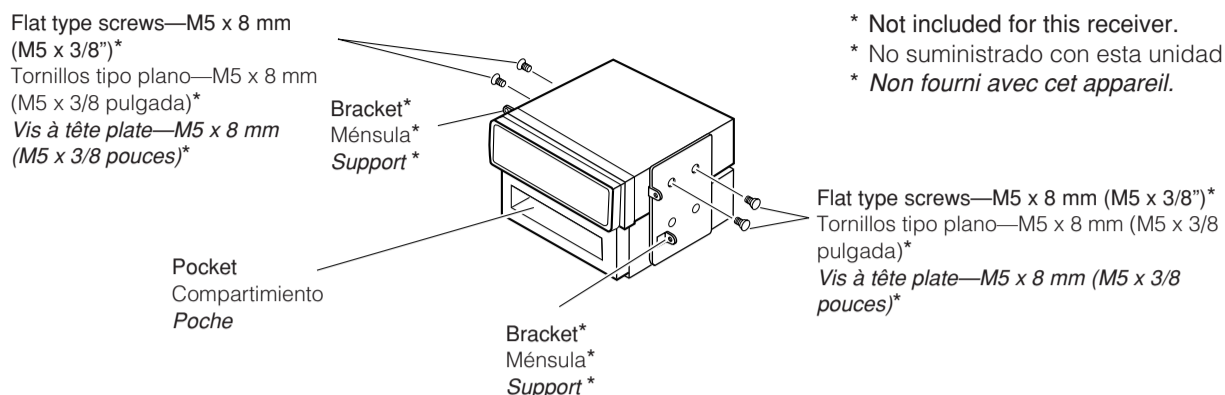

Note : When installing the receiver on the mounting bracket, make sure to use the 8 mm (3/8")-long screws. If longer screws are used, they could damage the receiver.
Nota : Cuando instala la unidad en la ménsula de montaje, asegúrese de utilizar los tornillos de 8 mm (3/8 pulgada) de longitud. Si se utilizan tornillos más largos, éstos pueden dañar la unidad.
Remarque : Lors de l'installation de l'appareil sur le support de montage, s'assurer d'utiliser des vis d'une longueur de 8 mm (3/8 pouces). Si des vis plus longues sont utilisées, elles peuvent endommager l'appareil.

ELECTRICAL CONNECTIONS

To prevent short circuits, we recommend that you disconnect the battery's negative terminal and make all electrical connections before installing the receiver.

- **Be sure to ground this receiver to the car's chassis again after installation.**

Notes:

- Replace the fuse with one of the specified rating. If the fuse blows frequently, consult your JVC car audio dealer.
- It is recommended to connect to the speakers with maximum power of more than 50 W (both at the rear and at the front, with an impedance of **4 Ω to 8 Ω**). If the maximum power is less than 50 W, change "AMP.GAIN" setting to prevent the speakers from being damaged (see page 22 of the INSTRUCTIONS).
- To prevent short-circuit, cover the terminals of the UNUSED leads with insulating tape.
- The heat sink becomes very hot after use. Be careful not to touch it when removing this receiver.

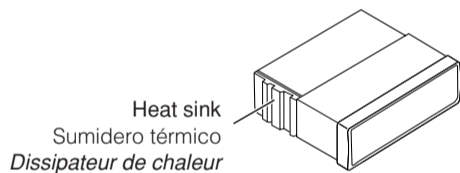

CONEXIONES ELECTRICAS

Para evitar cortocircuitos, recomendamos que desconecte el terminal negativo de la batería y que efectúe todas las conexiones eléctricas antes de instalar la unidad.

- **Asegúrese de volver a conectar a masa esta unidad al chasis del automóvil después de la instalación.**

Notas:

- Reemplace el fusible por uno con la corriente especificada. Si el fusible se quemase frecuentemente consulte con su concesionario de JVC de equipos de audio para automóviles.
- Se recomienda conectar los altavoces con una potencia máxima de más de 50 W (tanto atrás como adelante, con una impedancia de **4 Ω a 8 Ω**). Si la potencia máxima es de menos de 50 W, cambie "AMP.GAIN" para evitar daños en los altavoces (consulte la página 22 del MANUAL DE INSTRUCCIONES).
- Para evitar cortocircuitos, cubra los cables NO UTILIZADOS con cinta aislante.
- El sumidero térmico estará muy caliente después del uso. Asegúrese de no tocarlo al desmontar esta unidad.

RACCORDEMENTS ELECTRIQUES

Pour éviter tout court-circuit, nous vous recommandons de débrancher la borne négative de la batterie et d'effectuer tous les raccordements électriques avant d'installer l'appareil.

- **Assurez-vous de raccorder de nouveau la mise à la masse de cet appareil au châssis de la voiture après l'installation.**

Remarques:

- Remplacer le fusible par un de la valeur précisée. Si le fusible saute souvent, consulter votre revendeur d'autoradios JVC.
- Il est recommandé de connecter des enceintes avec une puissance de plus de 50 W (les enceintes arrière et les enceintes avant, avec une impédance comprise entre **4 Ω et 8 Ω**). Si la puissance maximum est inférieure à 50 W, changez "AMP.GAIN" pour éviter d'endommager vos enceintes (voir page 22 du MANUEL D'INSTRUCTIONS).
- Pour éviter les court-circuits, couvrir les bornes des fils qui ne sont PAS UTILISÉS avec de la bande isolante.
- Le dissipateur de chaleur devient très chaud après usage. Faire attention de ne pas le toucher en retirant cet appareil.

PRECAUTIONS on power supply and speaker connections:

- **DO NOT connect the speaker leads of the power cord to the car battery; otherwise, the receiver will be seriously damaged.**
- **BEFORE** connecting the speaker leads of the power cord to the speakers, check the speaker wiring in your car.

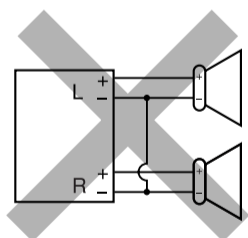

PRECAUCIONES sobre las conexiones de la fuente de alimentación y de los altavoces:

- **NO conecte los conductores de altavoz del cable de alimentación a la batería de automóvil, pues podrían producirse graves daños en la unidad.**
- **ANTES** de conectar a los altavoces los conductores de altavoz del cable de alimentación, verifique el conexionado de altavoz de su automóvil.

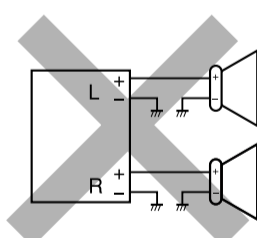

PRECAUTIONS sur l'alimentation et la connexion des enceintes:

- **NE CONNECTEZ PAS les fils d'enceintes du cordon d'alimentation à la batterie; sinon, l'appareil serait sérieusement endommagé.**
- **AVANT** de connecter les fils d'enceintes du cordon d'alimentation aux enceintes, vérifiez le câblage des enceintes de votre voiture.

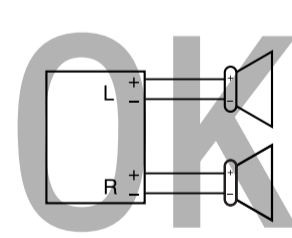

TROUBLESHOOTING

- **The fuse blows.**
* Are the red and black leads connected correctly?
- **Power cannot be turned on.**
* Is the yellow lead connected?
- **No sound from the speakers.**
* Is the speaker output lead short-circuited?
- **Sound is distorted.**
* Is the speaker output lead grounded?
* Are the "-" terminals of L and R speakers grounded in common?
- **Noise interfere with sounds.**
* Is the rear ground terminal connected to the car's chassis using shorter and thicker cords?
- **Receiver becomes hot.**
* Is the speaker output lead grounded?
* Are the "-" terminals of L and R speakers grounded in common?
- **This receiver does not work at all.**
* Have you reset your receiver?

LOCALIZACION DE AVERIAS

- **El fusible se quema.**
* ¿Están los conductores rojo y negro correctamente conectados?
- **No es posible conectar la alimentación.**
* ¿Está el cable amarillo conectado?
- **No sale sonido de los altavoces.**
* ¿Está el cable de salida del altavoz cortocircuitado?
- **El sonido presenta distorsión.**
* ¿Está el cable de salida del altavoz conectado a masa?
* ¿Están los terminales "-" de los altavoces L y R conectados a una masa común?
- **Perturbación de ruido.**
* ¿El terminal de tierra trasero está conectado al chasis del automóvil utilizando los cordones más corto y más grueso?
- **La unidad se calienta.**
* ¿Está el cable de salida del altavoz conectado a masa?
* ¿Están los terminales "-" de los altavoces L y R conectados a una masa común?
- **Este receptor no funciona en absoluto.**
* ¿Reinicializó el receptor?

EN CAS DE DIFFICULTES

- **Le fusible saute.**
* Les fils rouge et noir sont-ils raccordés correctement?
- **L'appareil ne peut pas être mise sous tension.**
* Le fil jaune est-elle raccordée?
- **Pas de son des enceintes.**
* Le fil de sortie d'enceinte est-il court-circuité?
- **Le son est déformé.**
* Le fil de sortie d'enceinte est-il à la masse?
* Les bornes "-" des enceintes gauche et droit sont-elles mises ensemble à la masse?
- **Interférence avec les sons.**
* La prise arrière de mise à la terre est-elle connectée au châssis de la voiture avec un cordon court et épais?
- **L'appareil devient chaud.**
* Le fil de sortie d'enceinte est-il à la masse?
* Les bornes "-" des enceintes gauche et droit sont-elles mises ensemble à la masse?
- **Cet appareil ne fonctionne pas du tout.**
* Avez-vous réinitialisé votre appareil?

A Typical Connections / Conexiones típicas / Raccordements typiques

Before connecting: Check the wiring in the vehicle carefully. Incorrect connection may cause serious damage to this receiver.

The leads of the power cord and those of the connector from the car body may be different in color.

- 1 Connect the colored leads of the power cord in the order specified in the illustration below.
- 2 Connect the antenna cord.
- 3 Finally connect the wiring harness to the receiver.

Antes de la conexión: Verifique atentamente el conexionado del vehículo. Una conexión incorrecta podría producir daños graves en la unidad.

Los cordones del cable de alimentación y los del conector procedentes de la carrocería del automóvil podrían ser de diferentes en color.

- 1 Conecte los conductores de color del cable de alimentación en el orden especificado en la ilustración de abajo.
- 2 Conecte el cable de antena.
- 3 Por último, conecte el cable de alimentación a la unidad.

Avant de commencer la connexion: Vérifiez attentivement le câblage du véhicule. Une connexion incorrecte peut endommager sérieusement l'appareil.

Le fil du cordon d'alimentation et ceux des connecteurs du châssis de la voiture peuvent être différents en couleur.

- 1 Connectez les fils colorés du cordon d'alimentation dans l'ordre spécifié sur l'illustration ci-dessous.
- 2 Connectez le cordon d'antenne.
- 3 Finalement, connectez le faisceau de fils à l'appareil.

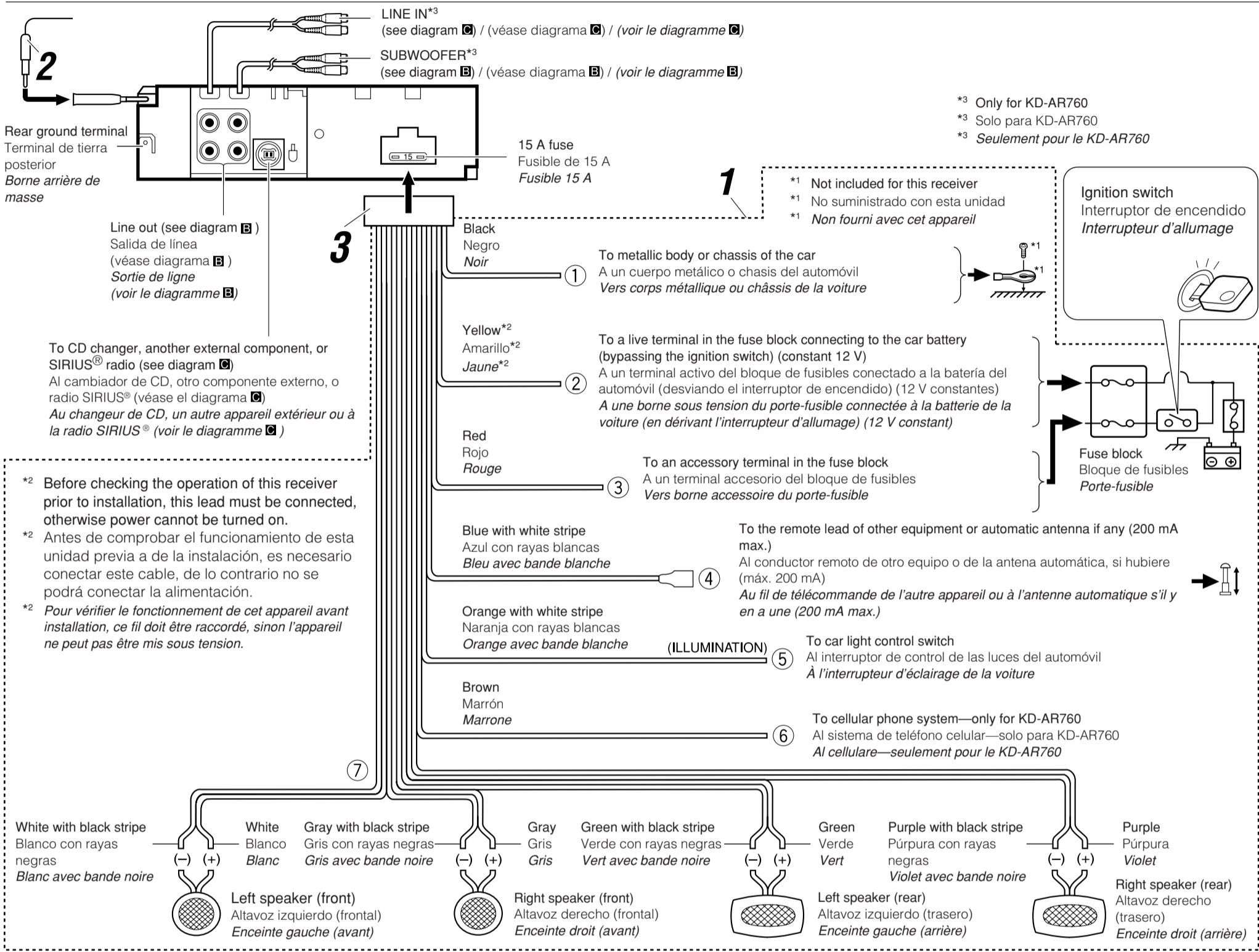

C Connecting other external components / Conexión de otros componentes externos / Connexion d'un autre appareil extérieur

JVC CD changer and DLP (Down Link Processor) / Cambiador de CD de JVC y DLP ("Down Link Processor") JVC / Changeur de CD JVC et Processeur DLP (Processeur de signaux satellite-terre)

- Set "EXTERNAL IN" to "CHANGER" (See page 22 of the INSTRUCTIONS.) / Ajuste "EXTERNAL IN" a "CHANGER" (Consulte la página 22 del MANUAL DE INSTRUCCIONES). / Réglez "EXTERNAL IN" sur "CHANGER" (Voir la page 22 du MANUEL D'INSTRUCTIONS.)

- You can connect both components in series as illustrated below.
- Podrá conectar ambos componentes en serie, tal como se observa en la ilustración de abajo.
- Vous pouvez connecter les deux appareils en série comme montré sur l'illustration.

*6 Signal cord supplied for your JVC CD changer or DLP
*6 Cable de señal suministrado con su cambiador de CD o DLP JVC
*6 Cordon de signal fourni avec votre changeur de CD ou processeur DLP JVC

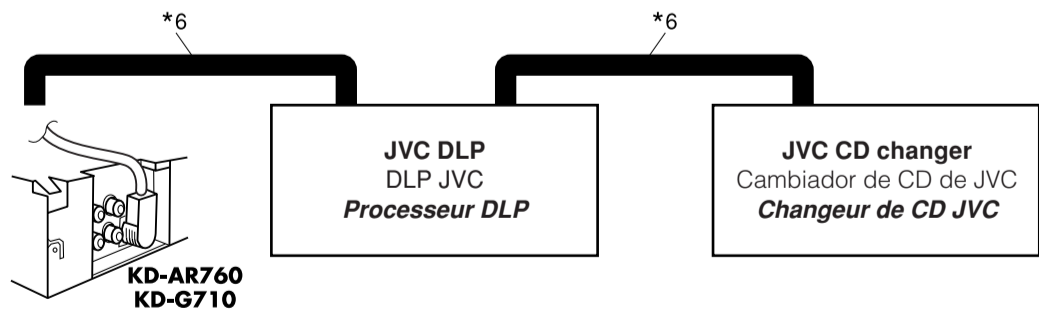

CAUTION / PRECAUCION / PRECAUTION:

- Before connecting the CD changer and/or JVC DLP, make sure that the receiver is turned off.
- Antes de conectar el cambiador de CD y/o DLP JVC, asegúrese de que el receptor esté apagado.
- Avant de connecter votre changeur de CD et/ou votre processeur DLP JVC, assurez-vous que l'autoradio est hors tension.

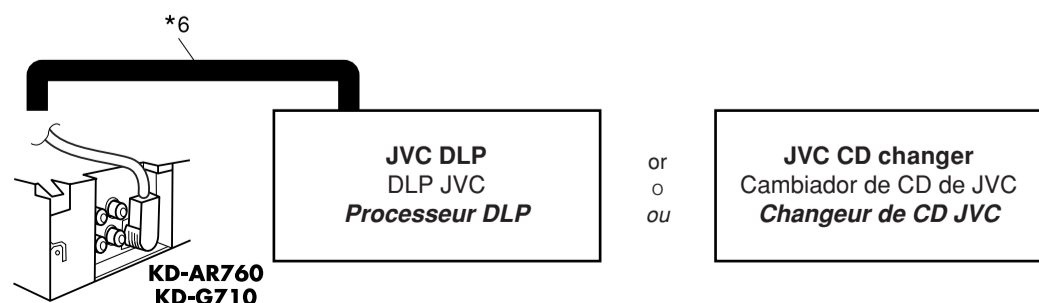

B Connecting the external amplifiers / Conexión de los amplificadores externos / Connexion d'amplificateurs extérieurs

You can connect amplifiers to upgrade your car stereo system.

- Connect the remote lead (blue with white stripe) to the remote lead of the other equipment so that it can be controlled through this receiver.
- **For amplifier only:**
Disconnect the speakers from this receiver, connect them to the amplifier. Leave the speaker leads of this receiver unused.
- Only for KD-AR760: You can switch off the built-in amplifier and send the audio signals only to the external amplifier(s) to get clear sounds and to prevent internal heat built-up inside the receiver. See page 22 of the INSTRUCTIONS (separate volume).
- The line output level of this receiver is kept high to maintain the hi-fi sounds reproduced from this receiver. When connecting an external amplifier to this receiver, turn down the gain control on the external amplifier to obtain the best performance from this receiver.

Usted podrá conectar amplificadores para mejorar el sistema estéreo de su automóvil.

- Conecte el conductor remoto (azul con rayas blancas) al conductor remoto del otro equipo para poderlo controlar a través de esta unidad.
- **Sólo para el amplificador:**
Desconecte los altavoces de esta unidad y conéctelos al amplificador. Los cables de los altavoces de esta unidad quedan sin usar.
- Solo para KD-AR760: Podrá desconectar el amplificador incorporado y enviar las señales de audio solamente al(los) amplificador(es) externo(s) para obtener sonidos nítidos y evitar que se caliente el interior de la unidad. Véase la página 22 de las MANUAL DE INSTRUCCIONES (volumen separado).
- El nivel de salida de línea de esta unidad permanece alto para que corresponda con los sonidos de alta fidelidad reproducidos por esta unidad. Cuando conecte un amplificador externo a esta unidad, disminuya el control de ganancia del amplificador externo para obtener un óptimo rendimiento de esta unidad.

Vous pouvez connecter des amplificateurs pour améliorer votre système autoradio.

- Connectez le fil de commande à distance (bleu avec bande blanche) au fil de commande à distance de l'autre appareil de façon qu'il puisse être commandé via cet appareil.
- **Pour l'amplificateur seulement:**
Déconnectez les enceintes de cet appareil et connectez-les à l'amplificateur. Laissez les fils d'enceintes de cet appareil inutilisés.
- *Seulement pour le KD-AR760: Vous pouvez désactiver l'amplificateur intégré et envoyer les signaux audio uniquement à un ou plusieurs amplificateurs extérieurs afin d'obtenir un son clair et pour éviter un échauffement interne de l'appareil. Référez-vous à la page 22 du MANUEL D'INSTRUCTIONS (volume séparé).*
- *Le niveau de sortie de ligne de cet appareil est maintenu à un niveau élevé pour maintenir une qualité Hi-Fi pour les sons reproduits par cet appareil. Lors de la connexion d'un amplificateur extérieur à cet appareil, diminuez le réglage du gain sur l'amplificateur extérieur pour obtenir les meilleures performances de cet appareil.*

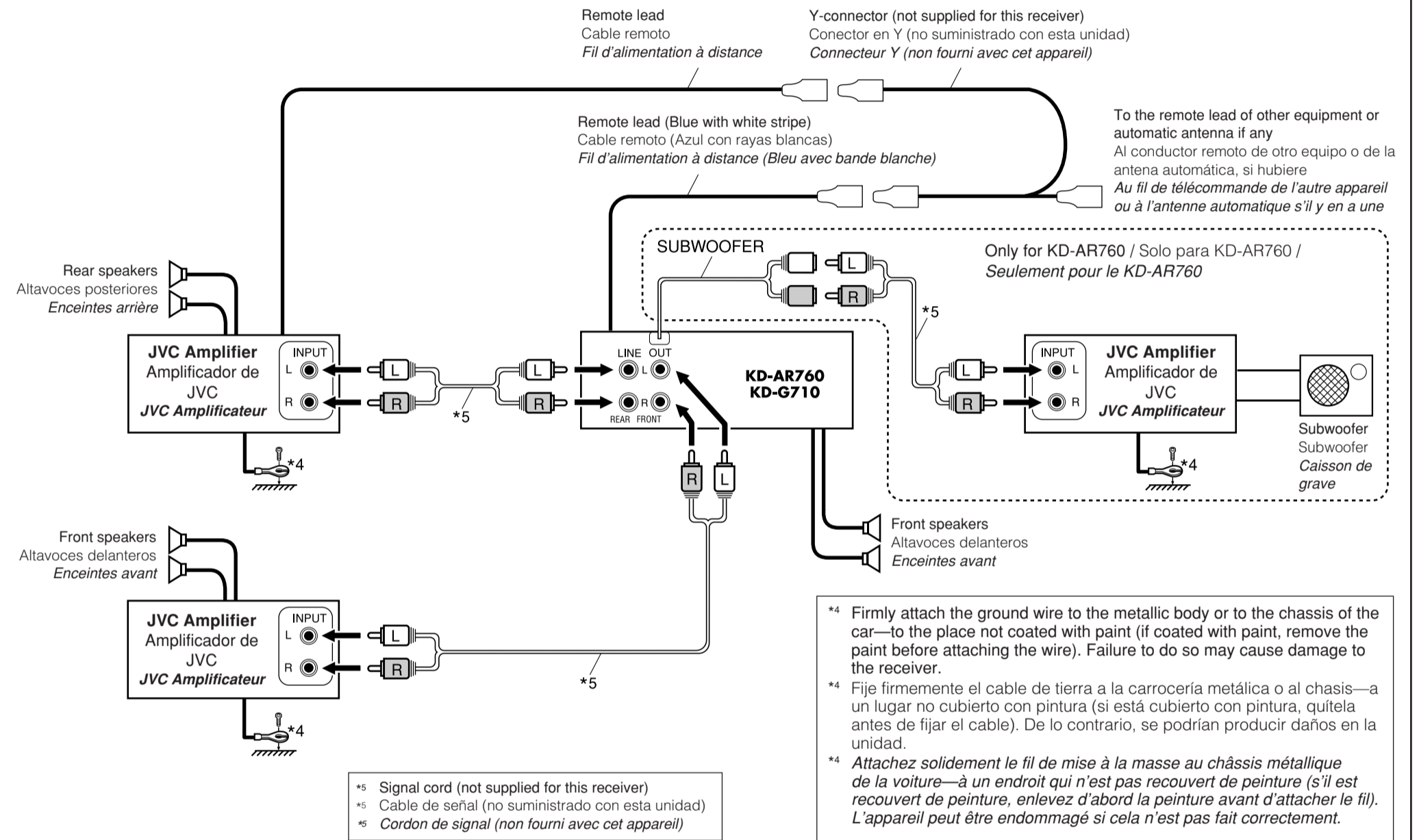

JVC PnP (Plug and Play) / PnP ("Plug and Play") JVC / PnP ("Plug and Play") JVC

- Set "EXTERNAL IN" to "EXTERNAL IN" (See page 22 of the INSTRUCTIONS.) / Ajuste "EXTERNAL IN" a "EXTERNAL IN" (Consulte la página 22 del MANUAL DE INSTRUCCIONES). / Réglez "EXTERNAL IN" sur "EXTERNAL IN" (Voir la page 22 du MANUEL D'INSTRUCTIONS.)

You can also connect JVC PnP through this receiver using JVC SIRIUS radio adapter, KS-U100K (not supplied).

- Turning on/off the receiver can also turns on/off the JVC PnP.
- También podrá conectar la PnP JVC a través de este receptor utilizando el adaptador para radio SIRIUS JVC, KS-U100K (no suministrado).
- Al encender/apagar el receptor también se enciende/apaga la PnP JVC.
- Vous pouvez aussi connecter le PnP JVC à cet autoradio en utilisant l'adaptateur de radio SIRIUS JVC KS-U100K (non fourni).*
- *Mettre sous/hors tension l'autoradio peut aussi mettre sous/hors tension le PnP JVC.*

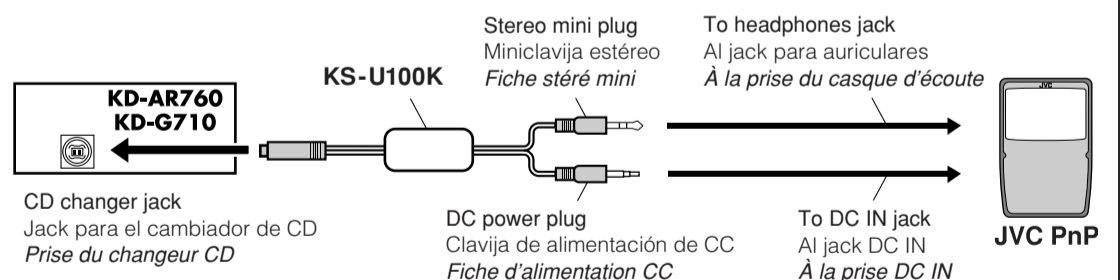

External Component / Componente exterior / Appareil extérieur

- Set "EXTERNAL IN" to "EXTERNAL IN" (See page 22 of the INSTRUCTIONS.) / Ajuste "EXTERNAL IN" a "EXTERNAL IN" (Consulte la página 22 del MANUAL DE INSTRUCCIONES). / Réglez "EXTERNAL IN" sur "EXTERNAL IN" (Voir la page 22 du MANUEL D'INSTRUCTIONS.)

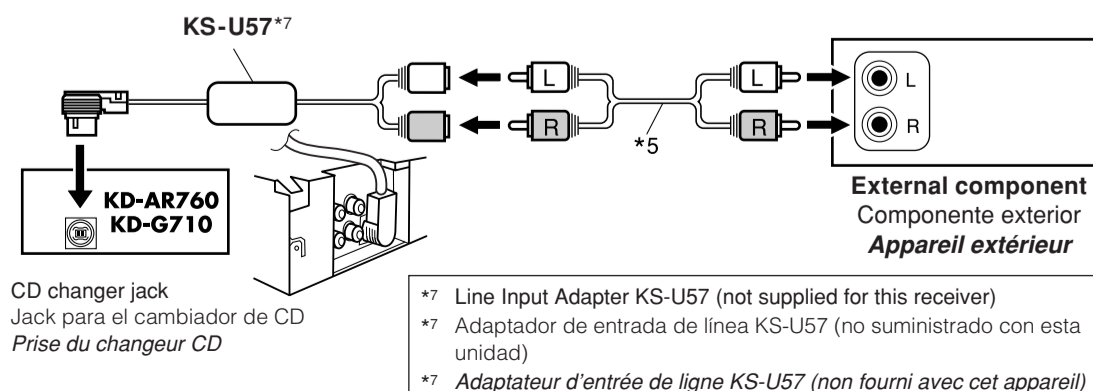

Only for KD-AR760 / Solo para KD-AR760 / Seulement pour le KD-AR760

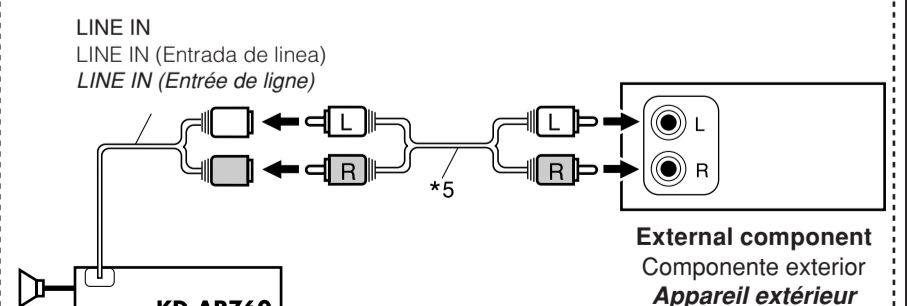

Free Manuals Download Website

<http://myh66.com>

<http://usermanuals.us>

<http://www.somanuals.com>

<http://www.4manuals.cc>

<http://www.manual-lib.com>

<http://www.404manual.com>

<http://www.luxmanual.com>

<http://aubethermostatmanual.com>

Golf course search by state

<http://golfingnear.com>

Email search by domain

<http://emailbydomain.com>

Auto manuals search

<http://auto.somanuals.com>

TV manuals search

<http://tv.somanuals.com>