

JVC



CD RECEIVER

KD-LH1150/KD-LH1100

ENGLISH

RECEPTOR CON CD

KD-LH1150/KD-LH1100

ESPAÑOL

RECEPTEUR CD

KD-LH1150/KD-LH1100

FRANÇAIS

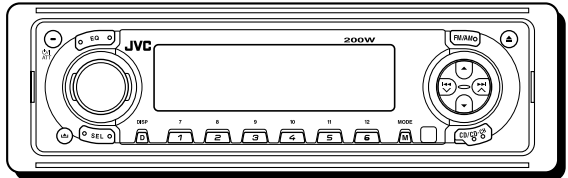
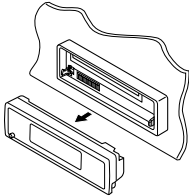

COMPACT
disc
DIGITAL AUDIO
TEXT

CD-RW
PLAYBACK

- This unit is equipped with the display demonstration. To cancel it, see page 8.
- Esta unidad está equipada con demostración en la pantalla. Para cancelarla, consulte la página 8.
- Cet appareil est équipé d'une fonction de démonstration des affichages. Pour l'annuler, référez-vous à la page 8.

For installation and connections, refer to the separate manual.
 Para la instalación y las conexiones, refiérase al manual separado.
 Pour l'installation et les raccordements, se référer au manuel séparé.

For customer Use:

Enter below the Model No. and Serial No. which are located on the top or bottom of the cabinet. Retain this information for future reference.

Model No. _____

Serial No. _____

INSTRUCTIONS

MANUAL DE INSTRUCCIONES

MANUEL D'INSTRUCTIONS

GET0148-001A

[J/C]

INFORMATION (For U.S.A.)

This equipment has been tested and found to comply with the limits for a Class B digital device, pursuant to Part 15 of the FCC Rules. These limits are designed to provide reasonable protection against harmful interference in a residential installation. This equipment generates, uses, and can radiate radio frequency energy and, if not installed and used in accordance with the instructions, may cause harmful interference to radio communications. However, there is no guarantee that interference will not occur in a particular installation. If this equipment does cause harmful interference to radio or television reception, which can be determined by turning the equipment off and on, the user is encouraged to try to correct the interference by one or more of the following measures:

- Reorient or relocate the receiving antenna.
- Increase the separation between the equipment and receiver.
- Connect the equipment into an outlet on a circuit different from that to which the receiver is connected.
- Consult the dealer or an experienced radio/TV technician for help.

IMPORTANT FOR LASER PRODUCTS**Precautions:****1. CLASS 1 LASER PRODUCT**

2. **CAUTION:** Invisible laser radiation when open and interlock failed or defeated. Avoid direct exposure to beam.
3. **CAUTION:** Do not open the top cover. There are no user-serviceable parts inside. Leave all servicing to qualified service personnel.
4. **CAUTION:** This CD player uses invisible laser radiation, however, is equipped with safety switches to prevent radiation emission when unloading CDs. It is dangerous to defeat the safety switches.
5. **CAUTION:** Use of controls, adjustments or performance of procedures other than those specified herein may result in hazardous radiation exposure.

Caution:

If the temperature inside the car is below 0°C (32°F), the movement of source animation and text scroll will be halted on the display to prevent the display from being blurred. When the temperature increases, and the operating temperature is resumed, these functions will start working again.

CAUTION on Volume Setting:

Discs produce very little noise compared with other sources. If the volume level is adjusted for the tuner, for example, the speakers may be damaged by the sudden increase in the output level. Therefore, lower the volume before playing a disc and adjust it as required during playback.

How to reset your unit

After detaching the control panel, press the reset button on the panel holder using a ball-point pen or a similar tool. This will reset the built-in microcomputer.

Note:

Your preset adjustments—such as preset channels or sound adjustments—will also be erased.

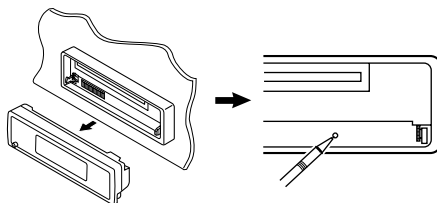

Thank you for purchasing a JVC product. Please read all instructions carefully before operation, to ensure your complete understanding and to obtain the best possible performance from the unit.

CONTENTS

How to reset your unit	2	OTHER MAIN FUNCTIONS	24
LOCATION OF THE BUTTONS	4	Changing the general settings (PSM)	24
Control panel	4	Selecting the dimmer mode	28
Illumination Navigation for easy operations	4	Changing the display color	29
Remote controller	5	Assigning names to the sources	31
Preparing the remote controller	6	Detaching the control panel	32
BASIC OPERATIONS	7	CD CHANGER OPERATIONS	33
Turning on the power	7	Playing discs	33
Canceling the display demonstration	8	Selecting a disc/folder/track using the name lists	36
Setting the clock	9	Selecting the playback modes	37
RADIO OPERATIONS	10	Changing the display information	39
Listening to the radio	10	EXTERNAL COMPONENT OPERATIONS ...	40
Storing stations in memory	11	Playing an external component	40
Tuning in to a preset station	13	ADDITIONAL INFORMATION	41
Changing the display pattern	14	TROUBLESHOOTING	42
CD OPERATIONS	15	MAINTENANCE	44
Playing a CD	15	Handling discs	44
Locating a track or a particular portion on a CD	16	SPECIFICATIONS	45
Selecting CD playback modes	17		
Prohibiting CD ejection	18		
Changing the display pattern	19		
SOUND ADJUSTMENTS	20		
Adjusting the sound	20		
Selecting preset sound modes (iEQ: intelligent equalizer)	21		
Storing your own sound adjustments	22		
Activating the level meter	23		

BEFORE USE

**For safety....*

- Do not raise the volume level too much, as this will block outside sounds, making driving dangerous.
- Stop the car before performing any complicated operations.

**Temperature inside the car....*

If you have parked the car for a long time in hot or cold weather, wait until the temperature in the car becomes normal before operating the unit.



LOCATION OF THE BUTTONS

Control panel

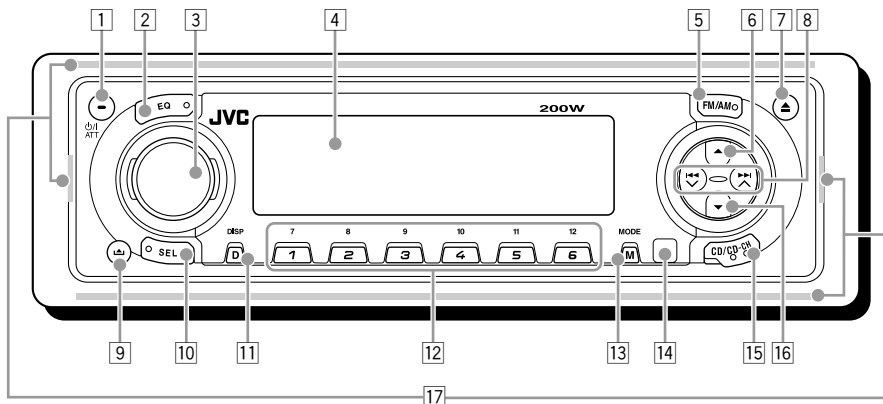

- | | | | |
|---|--|----|------------------------------|
| 1 | ⏻/I/ATT (standby/on/attenuator) button | 10 | SEL (select) button |
| 2 | EQ (equalizer) button | 11 | D (DISP: display) button |
| 3 | Control dial | 12 | Number buttons |
| 4 | Display window | 13 | M (MODE) button |
| 5 | FM/AM button | 14 | Remote sensor |
| 6 | ▲ (up) button | 15 | CD/CD-CH (CD changer) button |
| 7 | ▲ (eject) button | 16 | ▼ (down) button |
| 8 | ⏮ ⏪ ⏩ ⏭ buttons | 17 | Trim illumination |
| 9 | ⏮ (control panel release) button | | |

Illumination Navigation for easy operations:

If you press M (MODE), EQ (equalizer), and SEL (select), the display and some controls (such as the number buttons, ⏩ ▲/⏮ ⏪ ▼, ▲/▼, and control dial) enter the corresponding control mode, then the controls start flashing to lead you to the next operational steps. (Illumination Navigation)

- The display show how these buttons function during this period.

Ex.: When you press number button 1 after pressing M (MODE), to operate the FM tuner.

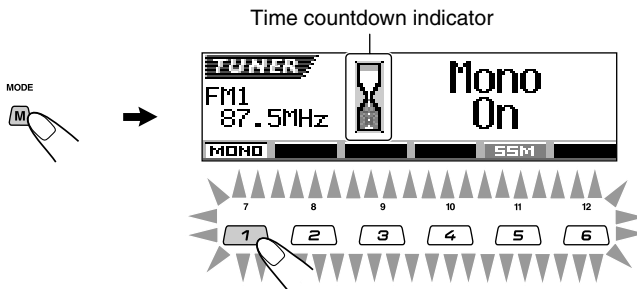

To use these buttons for original functions again, wait until the controls stop flashing without using these controls.

- Pressing M (MODE) or EQ (equalizer) again also restores original functions. However, pressing SEL (select) makes the unit into a different mode.



Remote controller

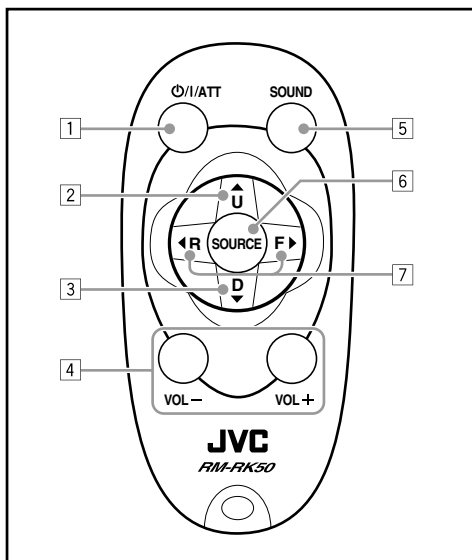

- 1 • Turns on the unit if pressed when the unit is turned off.
 - Turns off the unit if pressed and held for a few seconds.
 - Drops the volume level in a moment if pressed briefly.
Press again to resume the volume.
- 2 • Selects the band while listening to the radio. Each time you press the button, the band changes.
 - While playing an MP3 disc on an MP3-compatible CD changer;
 - Skips to the next disc if pressed briefly.
 - Skips to the next folder if pressed and held.

Note: While playing a CD on a CD changer, this always skips to the next disc.
- 3 • Selects the preset stations while listening to the radio.
Each time you press the button, the preset station number increases, and the selected station is tuned in.
 - While playing an MP3 disc on an MP3-compatible CD changer;
 - Skips to the previous disc if pressed briefly.
 - Skips to the previous folder if pressed and held.

Note: While playing a CD on a CD changer, this always skips to the previous disc.
- 4 Functions the same as the control dial on the main unit.

Note: These buttons do not function for the preferred setting mode adjustment.
- 5 Selects the sound mode (iEQ: intelligent equalizer).
Each time you press the button, the sound mode (iEQ) changes.
- 6 Selects the source.
Each time you press the button, the source changes.
- 7 • Searches for stations while listening to the radio.
 - Fast-forwards or reverses the track/file if pressed and held while listening to a disc.
 - Skips to the beginning of the next track/file or goes back to the beginning of the current (or previous) tracks/files if pressed briefly while listening to a disc.

Preparing the remote controller

Before using the remote controller:

- Aim the remote controller directly at the remote sensor on the main unit. Make sure there is no obstacle in between.

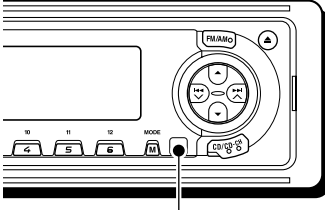

Remote sensor

- Do not expose the remote sensor to strong light (direct sunlight or artificial lighting).

Installing the battery

When the controllable range or effectiveness of the remote controller decreases, replace the battery.

1. Remove the battery holder.

- 1) Push out the battery holder in the direction indicated by the arrow using a ball-point pen or a similar tool.
- 2) Remove the battery holder.

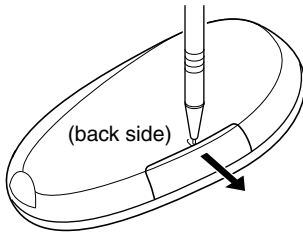

2. Place the battery.

Slide the battery into the holder with the + side facing upwards so that the battery is fixed in the holder.

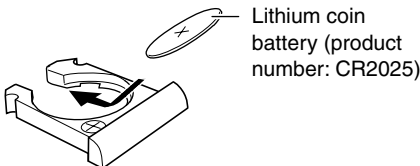

Lithium coin battery (product number: CR2025)

3. Return the battery holder.

Insert again the battery holder by pushing it until you hear a clicking sound.

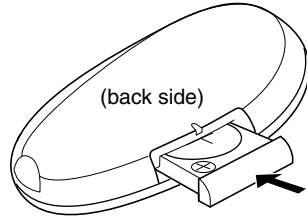

WARNING:

- Store the battery in a place where children cannot reach.
If a child accidentally swallows the battery, consult a doctor immediately.
- Do not recharge, short, disassemble, or heat the battery or dispose of it in a fire.
Doing any of these things may cause the battery to give off heat, crack, or start a fire.
- Do not leave the battery with other metallic materials.
Doing this may cause the battery to give off heat, crack, or start a fire.
- When throwing away or saving the battery, wrap it in tape and insulate; otherwise, the battery may start to give off heat, crack, or start a fire.
- Do not poke the battery with tweezers or similar tools.
Doing this may cause the battery to give off heat, crack, or start a fire.

CAUTION:

DO NOT leave the remote controller in a place (such as dashboards) exposed to direct sunlight for a long time. Otherwise, it may be damaged.

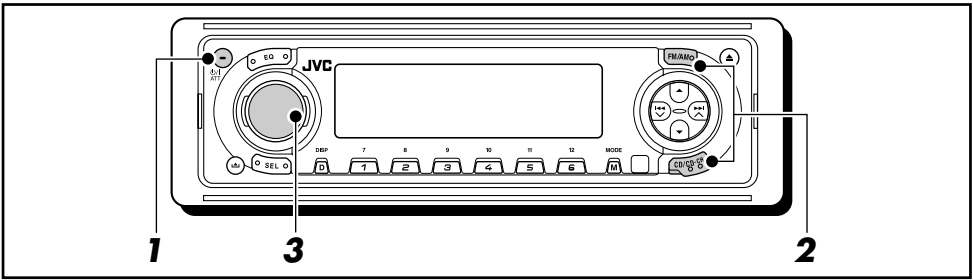

Turning on the power

1 Turn on the power.



Note on One-Touch Operation:

When you select a source in step 2 below, the power automatically comes on. You do not have to press this button to turn on the power.

2 Select the source.

FM/AM



CD/CD-CH

To operate the tuner (FM or AM), see pages 10 – 14.

To play a CD, see pages 15 – 19.

To operate the CD changer, see pages 33 – 39.

To operate the external component (LINE IN), see page 40.

3 Adjust the volume.

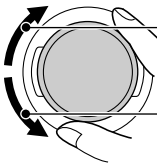

To increase the volume

To decrease the volume

Volume level appears.



Current sound mode (iEQ)
(see page 21)

4 Adjust the sound as you want. (See pages 20 – 22.)

Note:

While playing a source, you can also show the level meter on the display. For details, see “Activating the level meter” on page 23.

To drop the volume in a moment

Press **ATT** briefly while listening to any source. “ATT” starts flashing on the display, and the volume level will drop in a moment.

To resume the previous volume level, press the button briefly again.

- If you turn the control dial, you can also restore the sound.

To turn off the power

Press and hold **ATT** for more than one second.

- **If you turn off the power while listening to a disc**, disc play will start from where playback has been stopped previously, next time you turn on the power.

NOTICE:

The illustrations of the display used in this manual are mainly of the initial setting when shipped from the factory. If you have changed the display patterns or some PSM items, the actual displays you see will be different.

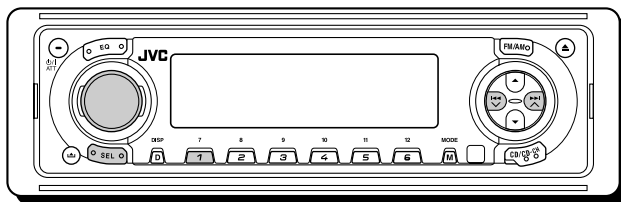

Canceling the display demonstration

When shipped from the factory, display demonstration has been activated, and starts automatically when no operations are done for about 20 seconds.

- It is recommended to cancel the demonstration before you use the unit for the first time.

To cancel the display demonstration, follow the procedure below:

- Press and hold SEL (select) for more than 2 seconds so that one of the PSM items appears on the display. (PSM: see pages 24 and 25.)



The next-step-operation buttons start flashing.

- Press number button 1 to select "MOVIE"—Movie category of the PSM settings.

The "Graphics" setting screen appears on the display.

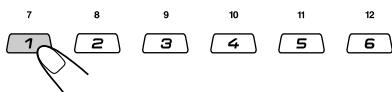

- Select "Off."

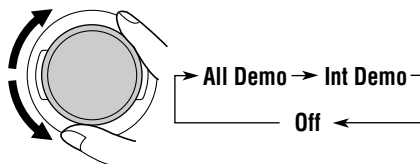

- Finish the setting.



To activate the display demonstration, repeat the same procedure and select "All Demo" or "Int Demo" in step 3.

- For more details, see "To set the movie demonstration—Graphics" on page 26.

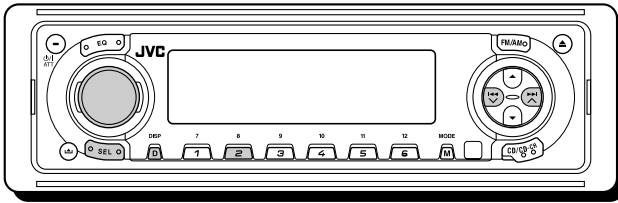

Setting the clock

You can also set the clock system to either 24 hours or 12 hours.

- 1 Press and hold SEL (select) for more than 2 seconds so that one of the PSM items appears on the display. (PSM: see pages 24 and 25.)**



The next-step-operation buttons start flashing.

- 2 Press number button 2 to select "CLOCK"—Clock category of the PSM settings.**

The "Clock Hr" (hour) setting screen appears on the display.



- 3 Adjust the hour.**

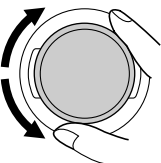

- 4 Set the minute.**

- 1 Select "Clock Min" (minute).
- 2 Adjust the minute.

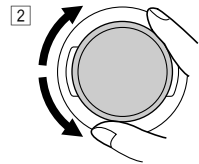
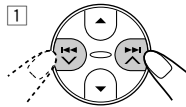

- 5 Set the clock system.**

- 1 Select "24H/12H."
- 2 Select "24Hours" or "12Hours."

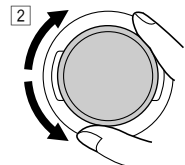
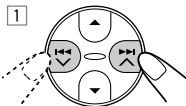

- 6 Finish the setting.**



To check the current clock time when the unit is turned off, press D (DISP).



The power turns on and the clock time is shown for 5 seconds, then the power turns off.



RADIO OPERATIONS

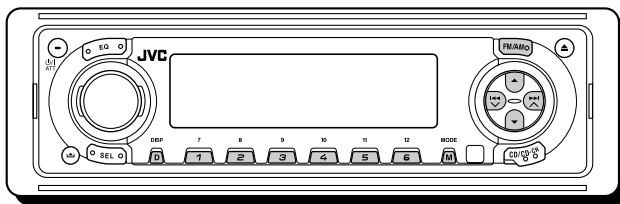

Listening to the radio

You can use either automatic searching or manual searching to tune in to a particular station.

Searching a station automatically: Auto search

1 Select the band (FM1 – 3, AM).



Each time you press the button, the band changes as follows:

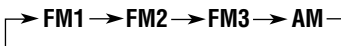

Selected band appears.



Lights up when receiving an FM stereo broadcast with sufficient signal strength.

Note:

This receiver has three FM bands (FM1, FM2, FM3). You can use any one of them to listen to an FM broadcast.

2 Start searching a station.

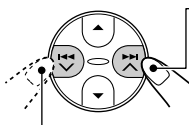

To search stations of higher frequencies

To search stations of lower frequencies

When a station is received, searching stops.

To stop searching before a station is received, press the same button you have pressed for searching.

Searching a station manually: Manual search

1 Select the band (FM1 – 3, AM).



Each time you press the button, the band changes as follows:

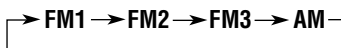

Note:

This receiver has three FM bands (FM1, FM2, FM3). You can use any one of them to listen to an FM broadcast.

2 Press and hold **▶▶** **▲** or **◀◀** **▼** until “Manual Search” starts flashing on the display.

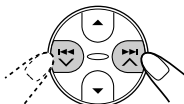

3 Tune in to a station you want while “Manual Search” is flashing.

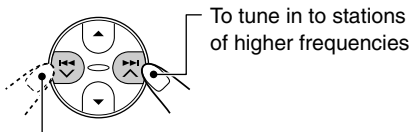

To tune in to stations of lower frequencies

- If you release your finger from the button, the manual mode will automatically turns off after 5 seconds.
- If you hold down the button, the frequency keeps changing (in 200 kHz intervals for FM and 10 kHz for AM) until you release the button.

If the sound quality decreases and the stereo effect is lost while listening to an FM station

In some areas, adjacent stations may interfere with each other. If this interference occurs, this unit can automatically reduce this interference noise (the initial setting when shipped from the factory). However, in this case, the sound quality will be degraded and the stereo effect will also be lost.

If you do not want to degrade the sound quality and to lose the stereo effect, rather than to eliminate the interference noise, see “To change the FM tuner selectivity—IF Filter” on page 27.

When an FM stereo broadcast is hard to receive:

- 1 Press M (MODE) while listening to an FM stereo broadcast.

MODE



“Mode” appears on the display.

The next-step-operation buttons start flashing.

- 2 Press number button 1 to select “Mono On” while “Mode” is still on the display. Each time you press the button, “Mono On” and “Mono Off” appears alternately.

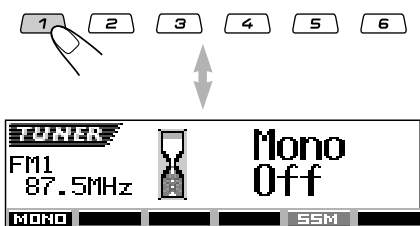

When “Mono On” is selected, the MONO indicator lights up on the display, the sound you hear becomes monaural but the reception will be improved.

Storing stations in memory

You can use one of the following two methods to store broadcasting stations in memory.

- Automatic preset of FM stations: SSM (Strong-station Sequential Memory)
- Manual preset of both FM and AM stations

FM station automatic preset: SSM

You can preset 6 local FM stations in each FM band (FM1, FM2, and FM3).

- 1 Select the FM band (FM1 – 3) you want to store FM stations into.



Each time you press the button, the band changes as follows:

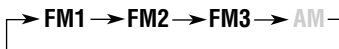



2 Start automatic preset.

- Press M (MODE).
MODE

 "Mode" appears on the display.
 The next-step-operation buttons start flashing.

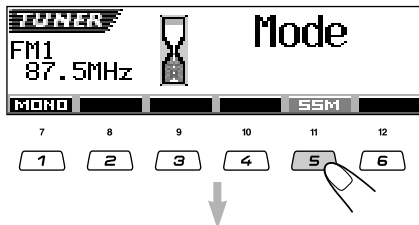
- Press and hold number button 5, while "Mode" is still on the display.



"-SSM-" appears, then disappears when automatic preset is over.

Local FM stations with the strongest signals are searched and stored automatically in the band number you have selected (FM1, FM2, or FM3). These stations are preset in the number buttons —No.1 (lowest frequency) to No.6 (highest frequency).

When automatic preset is over, the station stored in number button 1 will be automatically tuned in.

Manual preset

You can preset up to 6 stations in each band (FM1, FM2, FM3, and AM) manually.

Ex.: Storing FM station of 88.3 MHz into the preset number 1 of the FM1 band.

1 Select the band (FM1 – 3, AM) you want to store stations into (in this example, FM1).

- 
 Each time you press the button, the band changes as follows:

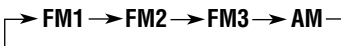

2 Tune in to a station (in this example, of 88.3 MHz).

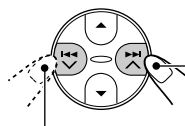

To tune in to stations of lower frequencies



3 Press and hold the number button (in this example, 1) for more than 2 seconds.



The display pattern automatically changes to the small animation display (see page 14). The preset number flashes for about 5 seconds, then the previous display pattern resumes.

4 Repeat the above procedure to store other stations into other preset numbers.

Notes:

- A previously preset station is erased when a new station is stored in the same preset number.
- Preset stations are erased when the power supply to the memory circuit is interrupted (for example, during battery replacement). If this occurs, preset the stations again.

Tuning in to a preset station

You can easily tune in to a preset station. Remember that you must store stations first. If you have not stored them yet, see “Storing stations in memory” on pages 11 and 12.

Selecting a preset station directly

1 Select the band (FM1 – 3, AM).



Each time you press the button, the band changes as follows:

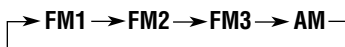

2 Select the number (1 – 6) for the preset station you want.

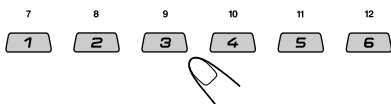

Note:

You can also use the ▲ (up) or ▼ (down) button on the unit to select the next or previous preset stations. Each time you press the ▲ (up) or ▼ (down) button, the next or previous preset station is tuned in.

Selecting a preset station using the preset station list

If you forget what stations are stored in what preset numbers, you can check the preset station list, then select your desired station.

1 Select the band (FM1 – 3, AM).



Each time you press the button, the band changes as follows:

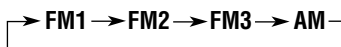

2 Press and hold ▲ (up) or ▼ (down) until the preset station list for the current band (FM1, FM2, FM3, or AM) appears on the display.

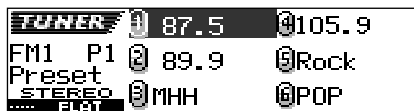
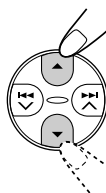

Notes:

- You can show the other FM band preset station lists (FM1, FM2, or FM3) by pressing ▲ (up) or ▼ (down).
- If a name has been assigned to a station (see page 31), it will be shown instead of the station frequency.

3 Select the number (1 – 6) for the preset station you want.

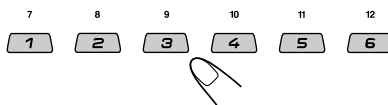



Changing the display pattern

By pressing D (DISP), you can change the information shown on the display.

Each time you press the button, the display patterns change as follows:

DISP



Large animation display



Current sound mode (iEQ) (see page 21)

Clock time display

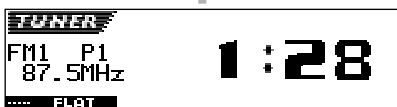

Small animation display 1



Clock time

Small animation display 2

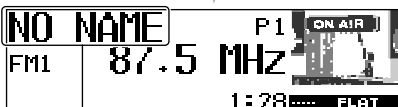

If a name has been assigned to a station it will be shown instead of "NO NAME."

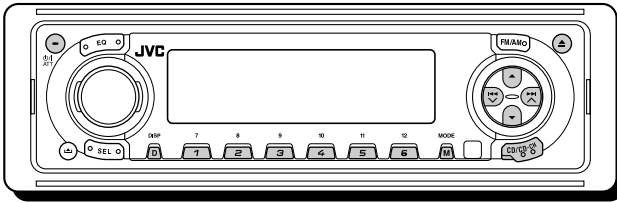

Playing a CD

1 Open the control panel.

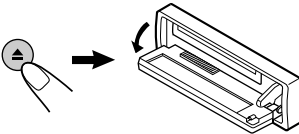

Note on One-Touch Operation:

When a CD is already in the loading slot, pressing CD/CD-CH turns on the unit and starts playback automatically.

2 Insert a CD into the loading slot.

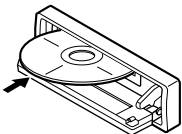

The unit turns on, draws the CD and starts playback automatically.

3 Close the control panel by hand.

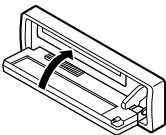

All tracks will be played repeatedly until you stop playback.

The display changes to show the following:

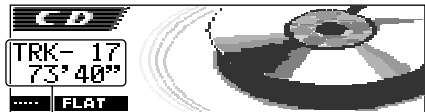

Total track number and total playing time of the inserted disc

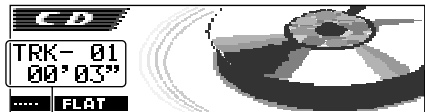

Current track and elapsed playing time

Notes:

- When a CD is inserted upside down, the CD automatically ejects (if the control panel is open). If the control panel is closed, the source changes to the previously selected source, "Please Eject" flashes on the display.
- If there is no CD in the loading slot, you cannot select CD as the source. "No Disc" flashes on the display.



To stop play and eject the CD

Press ▲.

CD play stops and the control panel flips down. The CD automatically ejects from the loading slot. The source changes to the previously selected source.

- If you change the source, CD play also stops (without ejecting the CD).

Next time you select "CD" as the source, CD play starts from where playback has been stopped previously.

Notes:

- If the ejected disc is not removed for about 15 seconds, the disc is automatically inserted again into the loading slot to protect it from dust. (Disc play will not start this time.)
- You can eject the disc even when the unit is turned off.

Locating a track or a particular portion on a CD

To fast-forward or reverse the track

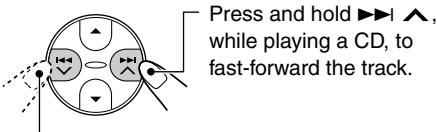

Press and hold ◀◀ ▼, while playing a CD, to reverse the track.

To go to the next or previous tracks

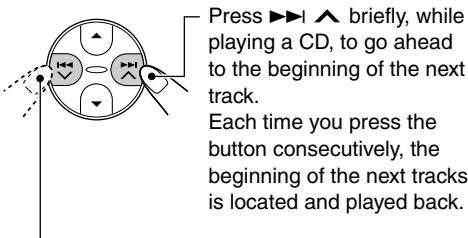

Press ◀◀ ▼ briefly, while playing a CD, to go back to the beginning of the current track. Each time you press the button consecutively, the beginning of the previous tracks is located and played back.

To go to a particular track directly

Press the number button corresponding to the track number to start its playback.

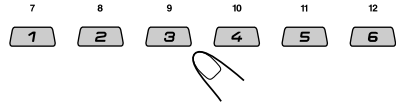

- To select a track number from 1 – 6: Press 1 (7) – 6 (12) briefly.
- To select a track number from 7 – 12: Press and hold 1 (7) – 6 (12) for more than one second.

To go to a track quickly

- 1 Press M (MODE) while playing a CD.

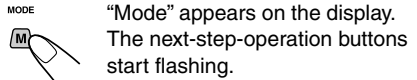

- 2 Press ▲ (up) or ▼ (down).

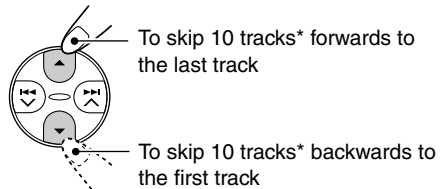

- * The first time you press ▲ (up) or ▼ (down) button, the track skips to the nearest higher or lower track with a track number of multiple ten (ex. 10th, 20th, 30th).

Then each time you press the button, you can skip 10 tracks (see "How to go to the desired track quickly" on page 17).

- After the last track, the first track will be selected, and vice versa.



How to go to the desired track quickly

• Ex. 1: To select track number 32 while playing track number 6

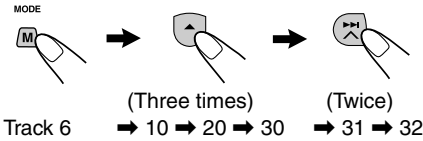

• Ex. 2: To select track number 8 while playing track number 36

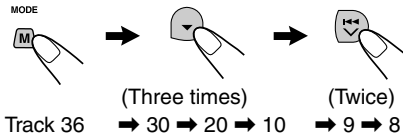

To play back tracks repeatedly (Track Repeat Play)

You can play back the current track repeatedly.

1 Press M (MODE) while playing a CD.

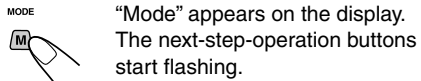

2 Press number button 2, while "Mode" is still on the display.

Each time you press the button, "Repeat Track" or "Repeat Off" appears alternately.

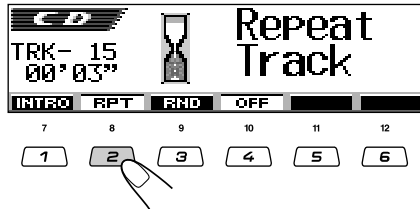

When track repeat play is turned on, the **RPT** (track repeat) indicator lights up on the display. The current track starts playing repeatedly.

To cancel track repeat play, select "Repeat Off" by pressing number button 2 repeatedly or press number button 4 in step 2.

Selecting CD playback modes

To play back tracks at random (Disc Random Play)

You can play back all tracks on the CD at random.

1 Press M (MODE) while playing a CD.

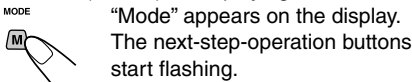

2 Press number button 3, while "Mode" is still on the display.

Each time you press the button, "Random Disc" or "Random Off" appears alternately.

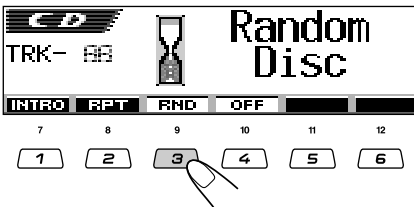

When disc random play is turned on, the **RND** (disc random) indicator lights up on the display. A track randomly selected starts playing.

To cancel disc random play, select "Random Off" by pressing number button 3 repeatedly or press number button 4 in step 2.



To play back only intros (Track Intro Scan)

You can play back the first 15 seconds of each track sequentially.

- 1 Press M (MODE) while playing a CD. "Mode" appears on the display. The next-step-operation buttons start flashing.



- 2 Press number button 1, while "Mode" is still on the display. Each time you press the button, "Intro Track" or "Intro Off" appears alternately.

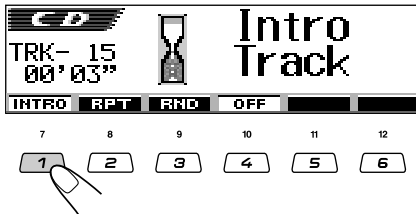

When track intro scan is turned on, the **INT** (track intro) indicator lights up on the display. The first 15 seconds of each track is played sequentially.

To cancel track intro scan, select "Intro Off" by pressing number button 1 repeatedly or press number button 4 in step 2.

Prohibiting CD ejection

You can prohibit CD ejection and can lock a CD in the loading slot.

While pressing CD/CD-CH, press and hold ϕ /I/ATT for more than 2 seconds.



"No Eject" flashes on the display for about 5 seconds, and the CD is locked and cannot be ejected.



To cancel the prohibition and unlock the CD

While pressing CD/CD-CH, press and hold ϕ /I/ATT again for more than 2 seconds. "Eject OK" flashes on the display for about 5 seconds, and the CD is unlocked.





Changing the display pattern

By pressing D (DISP), you can change the information shown on the display.

Each time you press the button, the display patterns change as follows:

DISP



Large animation display

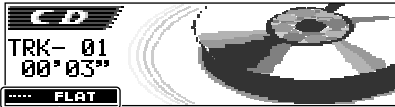

Current sound mode (iEQ) (see page 21)

Small animation display 1



Small animation display 2



Small animation display 3

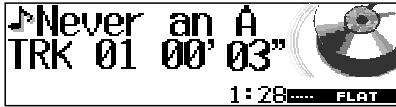

Small animation display 4

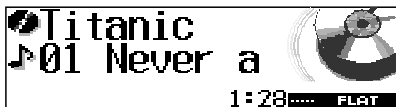

Clock time display



Notes:

- When the disc title/performer is shown, the (disc) indicator lights up. When the track title is shown, the (track) indicator lights up.
- If the information cannot be shown at a time, it will scroll on the display. Some characters or symbols will not be shown (will be blanked or substituted) on the display.
- If no name is assigned to the conventional CD, "NO NAME" will appear. To assign a name to a conventional CD, see page 31.
- If no disc title/performer or no track title is recorded for the CD Text, "NO NAME" will appear.



SOUND ADJUSTMENTS

Adjusting the sound

You can adjust the sound characteristics to your preference.

- “Vol Adj” setting is required for each source except FM. Before starting “Vol Adj,” select an appropriate source for which you want to make an adjustment.

1 Select the item you want to adjust.



The next-step-operation buttons start flashing. Each time you press SEL (select), the adjustable items change as follows:

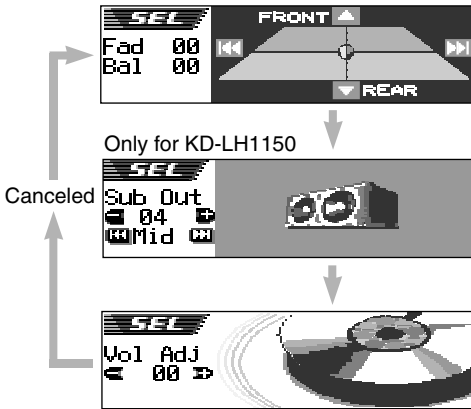
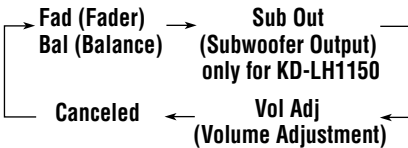

Indication	To do:	Range
Fad* ¹	Adjust the front and rear speaker balance.	R06 (Rear only) F06 (Front only)
Bal	Adjust the left and right speaker balance.	L06 (Left only) R06 (Right only)
Sub Out* ²	Adjust the subwoofer output level and cutoff frequency level.	00 (min.) 12 (max.) Low/Mid/High
Vol Adj* ³	Adjust and store the input level of each source.	-12 (min.) +12 (max.)

- *1 If you are using a two-speaker system, set the fader level to “00.”
- *2 Only for KD-LH1150:
This takes effect only when a subwoofer is connected.
- *3 By adjusting the input level to match it to the FM sound level, you will not need to adjust the volume level each time you change the source. This adjustment is memorized for each source except FM.

2 Make adjustments.

- To adjust fader and balance—Fad, Bal:

You can make these two adjustments at the same time, by referring to the indication on the display.

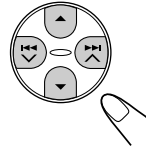

- Press ▲ (up) or ▼ (down) to adjust the fader.
- Press ►► ▲ or ◀◀ ▼ to adjust the balance.

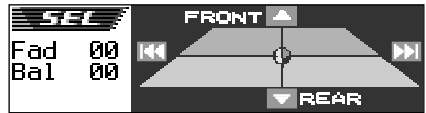

- To adjust subwoofer output—Sub Out: (only for KD-LH1150)

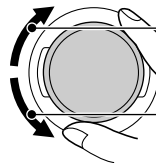

- To increase the level
- To decrease the level



You can also set an appropriate cutoff frequency level according to the subwoofer connected.

- Press ►► ▲ or ◀◀ ▼ to select “Low,” “Mid,” or “High.”
- Low: Frequencies higher than 50 Hz are cut off to the subwoofer.
- Mid: Frequencies higher than 80 Hz are cut off to the subwoofer.
- High: Frequencies higher than 115 Hz are cut off to the subwoofer.

- To adjust the input level of each source
—Vol Adj:

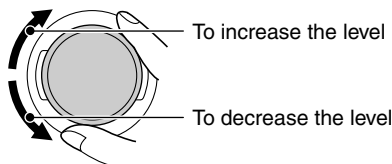

2 Press the number button to select the sound mode you want.

- This unit has two sound mode selection screens. To move to the other screen, press ▲ (up) or ▼ (down).

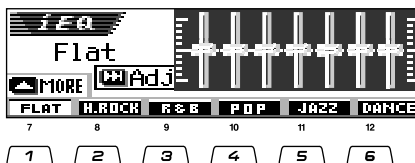

Press ▲ (up) or ▼ (down).

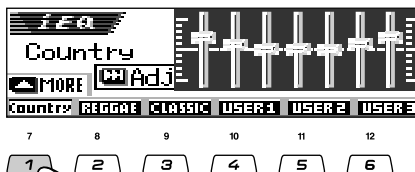

Ex.: When you press number button 1 to select “Country”

To cancel the preset sound mode, select “FLAT” in step 2.

Note:

For details about the preset settings of each sound mode, see page 41.

To exit from the preset sound mode, press EQ (equalizer) repeatedly or wait for about 5 seconds.

Selecting preset sound modes (iEQ: intelligent equalizer)

You can select a preset sound mode (iEQ: intelligent equalizer) suitable to the music genre.

- There is a time limit in doing the following procedure. If the setting is canceled before you finish, start from step 1 again.

Available sound modes:

- | | |
|--|---------------------------------------|
| • FLAT
(Flat) | • Country
(Country music) |
| • H.ROCK
(Hard Rock) | • REGGAE
(Reggae) |
| • R & B
(Rhythm and Blues) | • CLASSIC
(Classical music) |
| • POP
(Popular music) | • USER 1 |
| • JAZZ
(Jazz music) | • USER 2 |
| • DANCE
(Dance music) | • USER 3 |

1 Press EQ (equalizer).



Last selected sound mode is called up.

The next-step-operation buttons start flashing.

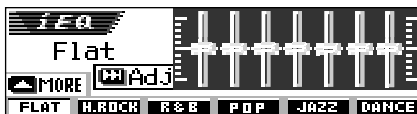

Ex.: If you have selected “Flat” previously



Storing your own sound adjustments

You can adjust the sound modes to your preference and store your own adjustments in memory (User 1, User 2, and User 3).

- There is a time limit in doing the following procedure. If the setting is canceled before you finish, start from step 1 again.

1 Press EQ (equalizer).



The next-step-operation buttons start flashing.

2 Select the sound mode you want to adjust.

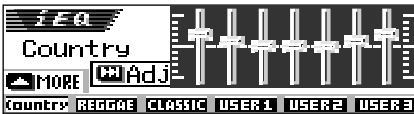

Ex.: When you select "Country" previously

3 Enter the sound adjustment mode.

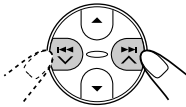

The following sound mode adjustment screen appears on the display.

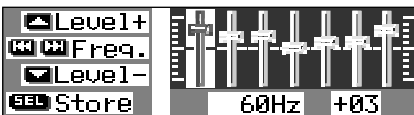

4 Make adjustments as you like.

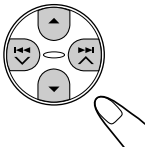

- 1) Press \blacktriangleright \blacktriangle or \blacktriangleleft \blacktriangledown to select the frequency band—60Hz, 150Hz, 400Hz, 1kHz, 2.4kHz, 6kHz, 12kHz.

- 2) Press \blacktriangle (up) or \blacktriangledown (down) to adjust the level of the selected band within the range of -05 to +05.

- 3) Repeat steps 1) and 2) to adjust the other frequency bands.

5 Store the adjustment you made.



The confirmation message appears—whether you want to store the adjustment.

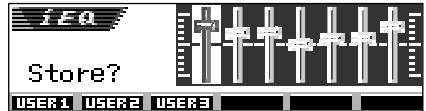

If you want to cancel the adjustments, press EQ (equalizer).

6 Select one of the user sound modes (User 1, User 2, or User 3) you want to store into.

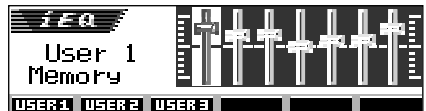
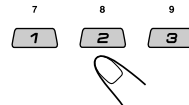

Ex.: When you select "User 1"

Activating the level meter

You can show the level meters on the display while playing any source. This unit is equipped with three level meter patterns.

- There is a time limit in doing the following procedure. If the setting is canceled before you finish, start from step **1** again.

1 Press EQ (equalizer) twice.



Last selected level meter appears on the display. The next-step-operation buttons start flashing.

2 Select the level meter pattern you want.

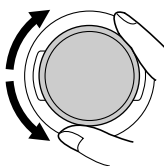

As you turn the control dial, the level meters change as follows:

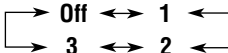

Meter 1:

The audio level meter fluctuates vertically.

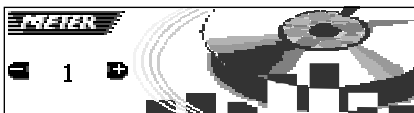

Meter 2:

The speaker on the display vibrates as input audio level changes.

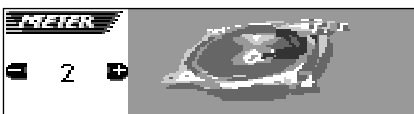

Meter 3:

The left and right audio level meters appear.

- If the small animation display is selected, only one audio level meter can be shown.





OTHER MAIN FUNCTIONS

Changing the general settings (PSM)

You can change the items listed on the table below and on page 25 by using the PSM (Preferred Setting Mode) control.

- The PSM items are grouped into six categories—MOVIE, CLOCK, DISP (display), TUNER, AUDIO, and COLOR.

Basic Procedure

- 1 Press and hold SEL (select) for more than 2 seconds so that one of the PSM items appears on the display. (See pages 24 and 25.)**



The next-step-operation buttons start flashing.

- 2 Press number button to select one of the PSM category.**

The first-listed item in the selected category appears.

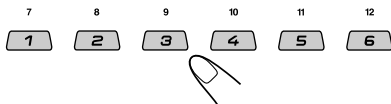

- 3 Select the PSM item you want to adjust. (See pages 24 and 25.)**

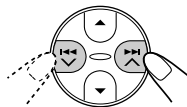

- By pressing \ggg \wedge or \lll \vee repeatedly, you can also move to other categories.

- 4 Adjust the PSM item selected.**

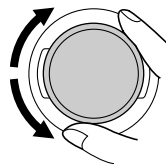

- 5 Repeat steps 2 to 4 to adjust the other PSM items if necessary.**

- 6 Finish the setting.**



Preferred Setting Mode (PSM) items

The PSM items are grouped into six categories—MOVIE, CLOCK, DISP (display), TUNER, AUDIO, and COLOR. To select a desired item, first select the category where the desired item is listed.

		Indications	Selectable values/items	Factory-preset settings	See page
MOVIE	Graphics	Movie demonstration	All Demo \leftrightarrow Int Demo \uparrow Off \downarrow	All Demo	8
	KeyIn CFM	Key in confirmation	Long \leftrightarrow Short \uparrow Off \downarrow	Long	26
CLOCK	Clock Hr	Hour adjustment	1 – 12	1 (1:00)	9
	Clock Min	Minute adjustment	00 – 59	00 (1:00)	9
	24H/12H	24 hours or 12 hours	24Hours 12Hours	12Hours	9



Indications		Selectable values/items		Factory-preset settings	See page			
DISP (display)	Scroll	Scroll mode	Once ↕ ↙	↔ Off ↗	Auto ↕	Once	26	
	Dimmer	Dimmer mode	↔	Auto ↕ ↗	↔	Off ↕ ↗	Auto	28
	From– To*¹	Dimmer time setting	Any time – Any time		6PM – 7AM		28	
	Contrast	Contrast	1 – 10		5		26	
	LCD Type	Display type	Positive ↕	↔ Auto ↗	Negative ↕	Auto	26	
	Font Type	Font type	1	2	1		26	
	Tag	Tag display	On	Off	On		27	
TUNER	IF Filter	Intermediate frequency filter	Auto	Wide	Auto		11	
AUDIO	Beep	Key-touch tone	On	Off	On		27	
	Ext Input*²	External component	Changer	Line In	Changer		27	
COLOR	All SRC	Selected source	See page 29 for details		Every		29	
	User	User color selection	Day	Night	Day		30	
	R	Red	00 – 11		Day: 07/Night: 05		30	
	G	Green	00 – 11		Day: 07/Night: 05		30	
	B	Blue	00 – 11		Day: 07/Night: 05		30	
	TrimIllum	Trim illumination	On ↕	↔ Off ↗	Audio ↕	On	27	

*¹ Displayed only when “Dimmer” is set to “Time Set.”

*² Displayed only when one of the following sources is selected—FM, AM, and CD.



To set the movie demonstration—Graphics

When shipped from the factory, the movie has been activated.

- All Demo: If no operation is done for about 20 seconds, the movie demonstration starts automatically.
- Int Demo: If no operation is done for about 20 seconds, the movie demonstration and playback source indication appears alternately on the display.
- Off: Cancels the movie demonstration.

To select the source animation on the display—KeyIn CFM

When changing the source, the display shows the source animation. You can select the source animation on the display according to your preference.

- Long: A long source animation appears.
- Short: A short source animation appears.
- Off: Cancels the source animation.

To select the scroll mode—Scroll

You can select the scroll mode for the disc information (when the entire text cannot be shown at once).

- Once: Scrolls only once.
- Auto: Repeats the scroll (in 5-second intervals).
- Off: Cancels scroll mode.

Note:

Even if the scroll mode is set to “Off,” you can scroll the display by pressing D (DISP) for more than one second.

To adjust the display contrast level—Contrast

You can adjust the display contrast level among 1 to 10.

Adjust it to make the display indications clear and legible.

To select the display illumination pattern—LCD Type

You can select the display illumination patterns according to your preference.

- Auto: Positive pattern will be selected during the day time (depending on the “Dimmer” setting); on the other hand, negative pattern will be used during the night time (depending on the “Dimmer” setting).
- Positive: Positive (normal) pattern of the display.
- Negative: Negative pattern of the display.

To select the font on the display—Font Type

You can change the font types used on the display. Select either “1” or “2” according to your preference.



To turn the tag display on or off—Tag

This function takes effect only when JVC MP3-compatible CD changer is connected.

An MP3 file can contain file information called “ID3 Tag” where its album name, performer, track title, etc. are recorded.

There are two versions—ID3v1 (ID3 Tag version 1) and ID3v2 (ID3 Tag version 2). Only ID3v1 can be shown.

- On: Turns on the ID3 tag display while playing MP3 files.
 - If an MP3 file does not have ID3 tags, folder name and file name appear.
- Note:**
If you change the setting from “Off” to “On” while playing an MP3 file, the tag display will be activated when the next file starts playing.
- Off: Turns off the ID3 tag display while playing MP3 files. (Only the folder name and file name can be shown.)

To change the FM tuner selectivity—IF Filter

In some areas, adjacent stations may interfere with each other. If this interference occurs, noise may be heard.

- Auto: When this type of interference occurs, this unit automatically increases the tuner selectivity so that interference noise will be reduced. (But the stereo effect will also be lost.)
- Wide: Subject to the interference from adjacent stations, but sound quality will not be degraded and the stereo effect will not be lost.

To turn on/off the key-touch tone—Beep

You can deactivate the key-touch tone if you do not want it to beep each time you press a button.

- On: Activates the key-touch tone.
- Off: Deactivates the key-touch tone.

To select the external component to use—Ext Input

You can connect the external component to the CD changer jack on the rear using the Line Input Adapter KS-U57 (not supplied).

To use the external component as the playback source through this unit, you need to select which component—CD changer or external component—to use.

- Changer: To use the CD changer.
- Line In: To use the external component other than CD changer.

Note:

For connecting the Line Input Adaptor KS-U57 and the external component, refer to the Installation/Connection Manual (separate volume).

To turn the trim illumination on or off—Trimillum

You can illuminate the trim plate according to your preference.

- On: Illuminate the trim plate.
- Audio: Illumination changes as audio signal level change.
- Off: Cancels the illumination.



Selecting the dimmer mode

You can dim the display at night automatically or as you set the timer. When shipped from the factory, Auto Dimmer mode is activated.

Note:

Auto Dimmer equipped with this unit may not work correctly on some vehicles, particularly on those having a control dial for dimming. In this case, select any other than "Auto."

1 Press and hold SEL (select) for more than 2 seconds so that one of the PSM items appears on the display. (See pages 24 and 25.)

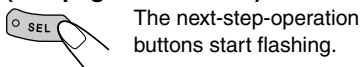

2 Press number button 3 to select "DISP"—Display category of the PSM settings.

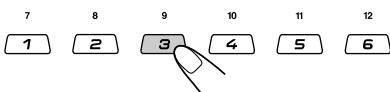

3 Press >>> ^ or <<< v to select "Dimmer" if not shown on the display.



4 Set the dimmer mode as you like.

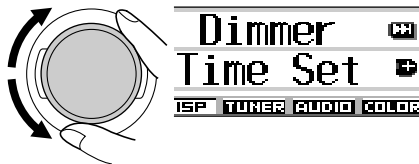

- Auto: Activates Auto Dimmer. When you turn on the car head lights, the display automatically dims.
- Off: Cancels Auto Dimmer.
- On: Always dims the display.
- Time Set: Used to set the timer for the dimmer function.

Note:

Selecting "Auto" or "Time Set" may change the display pattern to the "Negative" or "Positive" pattern if "LCD type" is set to "Auto."

- If you select "Timer Set," go to the following steps to set the timer.
- If you select any other than "Timer Set," go to step 7 to finish the setting.

5 Select "From-To" to set the timer for the dimmer mode.



6 Set the timer.

- 1 Turn the control dial to select the start time.
- 2 Press >>> ^ once.
- 3 Turn the control dial to select the end time.

7 Finish the setting.





Changing the display color

You can set the display color using the PSM control. You can select your favorite color for each source (or for all sources). You can also create your own colors, and set them as the display color. When shipped from the factory, "All SRC" (all source) is selected.

Setting the desired color for each source

Once you have set the color for each source (or for all sources), the display illuminates in the selected color when the source is selected.

1 Press and hold SEL (select) for more than 2 seconds so that one of the PSM items appears on the display. (See pages 24 and 25.)

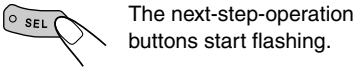

2 Press number button 6 to select "COLOR"—Color category of the PSM settings.

The "All SRC" setting screen appears on the display.



3 Select the source—All SRC, CD, Changer (Line), FM, or AM—that you want to set the display color for.

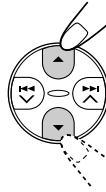

*1 When you select "All SRC," you can use the same color for all the sources.

*2 Selected only either component set in the "Ext Input" setting.

4 Select the display color.

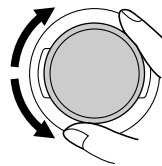

As you turn the control dial, the colors change as follows:

- Every*1 ⇄ Aqua ⇄ Sky ⇄ Sea ⇄
- Leaves ⇄ Grass ⇄ Red ⇄ Rose ⇄
- Amber ⇄ Honey ⇄ Violet ⇄ Cotton ⇄
- Snow ⇄ User*2 ⇄ (back to the beginning)

*1 When you select "Every," the color changes every 2 seconds (changing to every color listed above except "User").

*2 When you select "User," the user-edited colors—"Day" and "Night" will be applied. (See page 30.)

5 Repeat steps 3 and 4 to select the color for each source (except when selecting "All SRC" in step 3).

6 Finish the setting.





Creating your own color—User

You can create your own colors—"Day" and "Night," and select them as the display color for any desired source.

- Day: Can be used as your user color during the day time (while the headlights are turned off).
- Night: Can be used as your user color during the night time (while the headlights are turned on.)

1 Press and hold SEL (select) for more than 2 seconds so that one of the PSM items appears on the display. (See pages 24 and 25.)



The next-step-operation buttons start flashing.

2 Press number button 6 to select "COLOR"—Color category of the PSM settings.

The "All SRC" setting screen appears on the display.

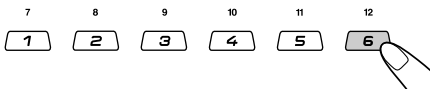

3 Select "User" as a color.

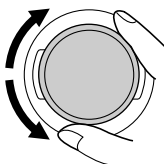

The user color will be applied to the currently selected source (the one shown on the upper portion of the display. In this example "All SRC").

To select which source to apply your user color to, select the target source first by pressing ▲ (up) or ▼ (down), before selecting "User" in this step.

4 Select the user color adjustment screen.

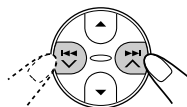

One of the user color adjustment screens appears. "User Day" or "User Night" is shown on the left side of the display.



5 Select "Day" or "Night" which you want to make an adjustment for.

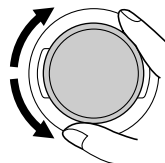

6 Adjust the selected user color.

- 1) Press ►► ▲ or ◀◀ ▼ to select one of three primary colors—"R" (red), "G" (green), and "B" (blue).



- 2) Press ▲ (up) or ▼ (down) to adjust the selected primary color. You can adjust within the range of 00 to 11.
- 3) Repeat steps 1) and 2) to adjust the other primary colors.

7 Repeat steps 3 to 5 to adjust the other user colors—"Day" or "Night."

8 Finish the setting.



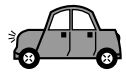

Assigning names to the sources

You can assign names to station frequencies, CDs (both in this unit and in the CD changer), and the external component. After assigning a name, it will appear on the display when you select the source.

Sources	Maximum number of characters
Station frequencies	Up to 10 characters (up to 30 station frequencies including both FM and AM)
CDs*	Up to 32 characters (up to 40 discs)
External component	Up to 8 characters

* You cannot assign a name to a CD Text (and MP3 discs in the CD changer).

1 Select a source you want to assign a name to.

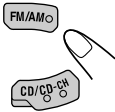

When you select a source, the power automatically comes on.

2 While pressing D (DISP), press and hold SEL (select) for more than 2 seconds.

The next-step-operation buttons start flashing.

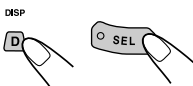

Ex.: When you select CD as the source

3 Select the character set you want while the first character position is flashing.



Each time you press the button, the character set changes as follows:

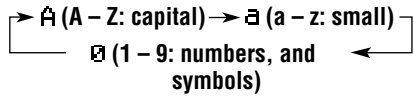

4 Select a character.

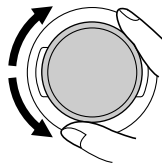

• About the available characters, see page 41.

5 Move the cursor to the next (or previous) character position.

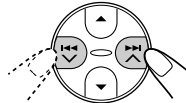

6 Repeat steps 3 to 5 until you finish entering the name.

7 Finish the procedure while the last selected character is flashing.



To erase the entered characters

Insert spaces using the same procedure described above.

Notes:

- When you try to assign a name to the 41st disc, you cannot enter the text entry mode. In this case, delete unwanted names before assignment.
- When the CD changer is connected, you can assign names to CDs in the CD changer. These names can also be shown on the display if you insert the CDs in this unit.



Detaching the control panel

You can detach the control panel when leaving the car.

When detaching or attaching the control panel, be careful not to damage the connectors on the back of the control panel and on the panel holder.

Detaching the control panel

Before detaching the control panel, be sure to turn off the power.

1 Unlock the control panel.

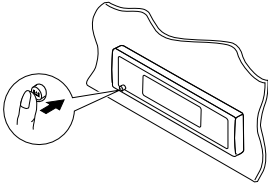

2 Pull the control panel out of the unit.

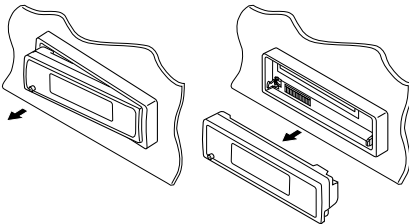

3 Put the detached control panel into the provided case.

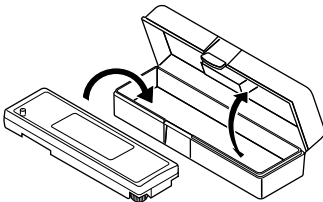

Attaching the control panel

1 Insert the right side of the control panel into the groove on the panel holder.

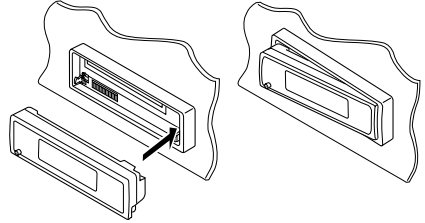

2 Press the left side of the control panel to fix it to the panel holder.

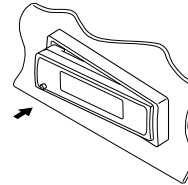

Note on cleaning the connectors:

If you frequently detach the control panel, the connectors will deteriorate.

To minimize this possibility, periodically wipe the connectors with a cotton swab or cloth moistened with alcohol, being careful not to damage the connectors.

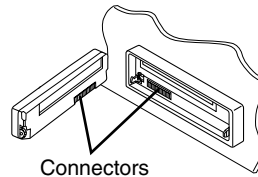

CD CHANGER OPERATIONS

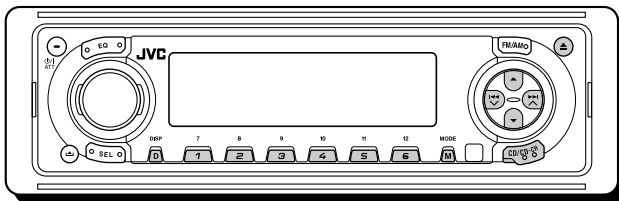
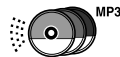

We recommend that you use the JVC MP3-compatible CD changer with your unit.

By using this CD changer, you can play back your original CD-Rs (Recordable) and CD-RWs (Rewritable) recorded either in audio CD format or in MP3 format.

- You can also connect other CH-X series CD changers (except CH-X99 and CH-X100). However, they are not compatible with MP3 discs, so you cannot play back MP3 discs.
- You cannot use the KD-MK series CD changers with this unit.

Before operating your CD changer:

- Refer also to the Instructions supplied with your CD changer.
- If no discs are in the magazine of the CD changer or the discs are inserted upside down, "No Disc" will flash on the display. If this happens, remove the magazine and set the discs correctly.
- If no magazine is loaded in the CD changer, "No Magazine" flashes on the display. If this happens, insert the magazine in the CD changer.
- If "Reset 1" – "Reset 8" flashes on the display, something is wrong with the connection between this unit and the CD changer. If this happens, check the connection and make sure the cords are connected firmly. Then, press the reset button of the CD changer.

Playing discs

Select the CD changer (CD-CH).



* If you have changed "Ext Input" setting to "Line In" (see page 27), you cannot select the CD changer.

- **When the current disc is an MP3 disc:** Playback starts from the first folder of the current disc once file check is completed.

Selected disc number

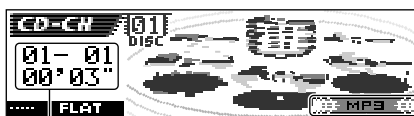

Current folder/track and elapsed playing time

MP3 indicator

- **When the current disc is a CD:**
Playback starts from the first track of the current disc.

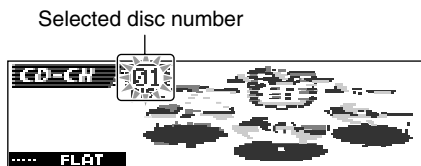

Current track and elapsed playing time

Notes:

- When you press CD/CD-CH, the power automatically comes on. You do not have to press /I/ATT to turn on the power.
- If you change the source, CD changer play also stops. Next time you select the CD changer as the source, CD changer play starts from where playback has been stopped previously.

To go to a particular disc directly

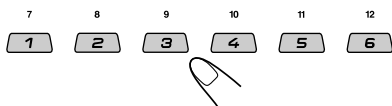

Press the number button corresponding to the disc number to start its playback (while the CD changer is playing).



- To select a disc number from 1 – 6:
Press 1 (7) – 6 (12) briefly.
- To select a disc number from 7 – 12:
Press and hold 1 (7) – 6 (12) for more than one second.

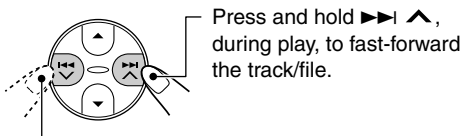

To fast-forward or reverse the track/file

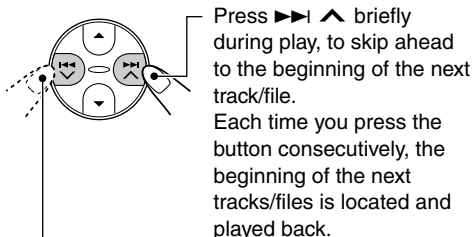

Press and hold  , during play, to reverse the track/file.

To go to the next or previous tracks/files



Press   briefly during play, to skip back to the beginning of the current track/file.
Each time you press the button consecutively, the beginning of the previous tracks/files is located and played back.

This operation is only possible when using JVC MP3-compatible CD changer (CH-X1500).

To go to a track/file quickly

- 1 Press M (MODE) while playing a disc.
MODE

 "Mode" appears on the display.
 The next-step-operation buttons start flashing.

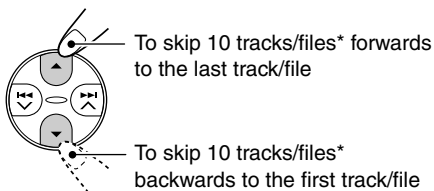

- 2 Press ▲ (up) or ▼ (down).



- * The first time you press ▲ (up) or ▼ (down) button, the track/file skips to the nearest higher or lower track/file with a track/file number of multiple ten (ex. 10th, 20th, 30th). Then each time you press the button, you can skip 10 tracks/files (see "How to go to the desired track/file quickly" on the right column).
- After the last track/file, the first track/file will be selected, and vice versa.

Note:

If the current playing disc is an MP3 disc, files are skipped within the same folder.

How to go to the desired track/file quickly

- Ex. 1: To select track/file number 32 while playing track/file number 6

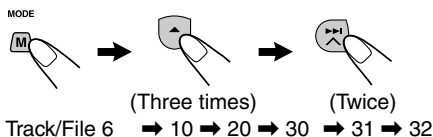

- Ex. 2: To select track/file number 8 while playing track/file number 36

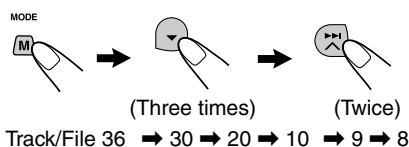

To skip to the next or previous folder (only for MP3 discs)

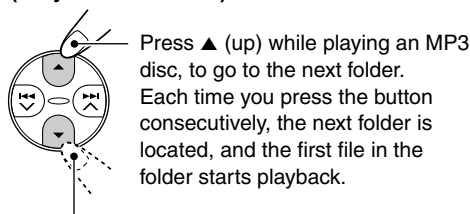

Press ▼ (down) while playing an MP3 disc, to go to the previous folder. Each time you press the button consecutively, the previous folder is located, and the first file in the folder starts playback.

Selecting a disc/folder/track using the name lists

To select a disc using the disc lists

If you forget what discs are loaded in the CD changer, you can show the disc title list and select a disc in the list shown on the display.

- The display can show only six disc names at a time.

- While playing a disc, press and hold ▲ (up) or ▼ (down) until a disc name list appears on the display.

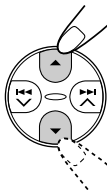

Selected disc number

Note:

If a disc has a disc title (CD Text) or an assigned disc name, it will be shown on the display. However, if the disc has not been played before, its disc number will appear.

- Press ▲ (up) or ▼ (down) to show the other disc name list, if necessary.

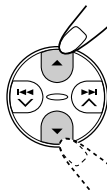

- Select the number (1 – 6) for the disc you want to play.

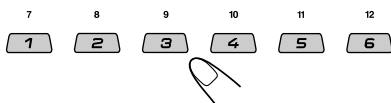

While playing an MP3 disc, you can also show the folder list(s) and file list(s) on the display, then select a folder or file.

- While playing an MP3 disc, press and hold ▲ (up) or ▼ (down) until a disc name list appears on the display.
- Press ►► ▲ or ◀◀ ▼ to show a folder list of the current disc or file list of the current folder. Each time you press the button, lists on the display changes as follows:

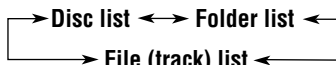

Current folder number



Ex.: When folder list is selected

Current track number

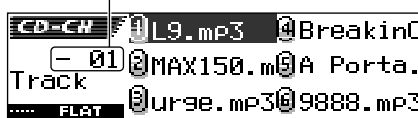

Ex.: When file list is selected

Note:

The display can show only six items at a time. You can show the other items on the next lists by pressing ▲ (up) or ▼ (down).

- Press the number button for the disc, folder, or file you want to play.

Selecting the playback modes

To play back tracks/files at random (Random Play)

- Press M (MODE) during play.
MODE

 "Mode" appears on the display.
 The next-step-operation buttons start flashing.
- Press number button 3 repeatedly while "Mode" is still on the display.
 Each time you press the button, random play mode changes as follows:

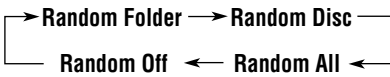
For MP3 discs:



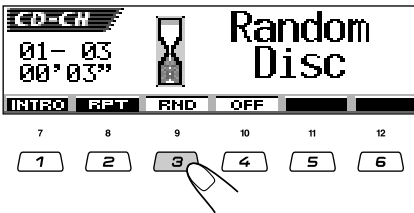

For CDs:



Ex.: When you select "Random Disc"

Note:

MP3 indicator also lights up if the current playing disc is an MP3 disc.

Mode	Active indicator	Plays at random
Random Folder*	 RND indicator lights up.	All files of the current folder, then files of the next folder and so on.
Random Disc	 RND indicator lights up.	All tracks/files of the current (or specified) disc.
Random All	ALL RND indicator lights up.	All tracks/files of all discs inserted in the magazine.

* "Random Folder" is only applicable for MP3 disc.

To cancel random play, select "Random Off" by pressing number button 3 repeatedly or press number button 4 in step 2.

To play back tracks/files repeatedly (Repeat Play)

- Press M (MODE) during play.
MODE

 "Mode" appears on the display.
 The next-step-operation buttons start flashing.
- Press number button 2 repeatedly while "Mode" is still on the display.
 Each time you press the button, repeat play mode changes as follows:

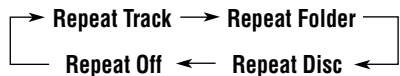
For MP3 discs:



For CDs:

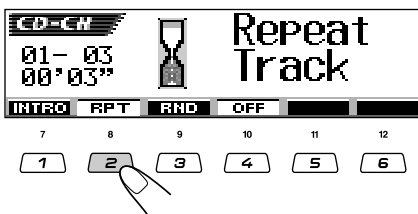





Ex.: When you select "Repeat Track"

Note:

MP3 indicator also lights up if the current playing disc is an MP3 disc.

Mode	Active indicator	Plays repeatedly
Repeat Track	 RPT indicator lights up.	The current (or specified) track/file.
Repeat Folder*	 RPT indicator lights up.	All files of the current (or specified) folder of the current disc.
Repeat Disc	 RPT indicator lights up.	All tracks/files of the current (or specified) disc.

* "Repeat Folder" is only applicable for MP3 disc.

To cancel repeat play, select "Repeat Off" by pressing number button 2 repeatedly or press number button 4 in step 2.

To play back only intros (Intro Scan)

1 Press M (MODE) during play.

MODE



"Mode" appears on the display.

The next-step-operation buttons start flashing.

2 Press number button 1 repeatedly while "Mode" is still on the display. Each time you press the button, intro scan mode changes as follows:

For MP3 discs:

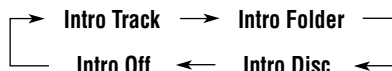

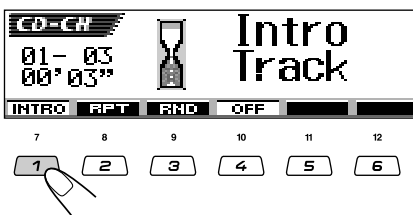

For CDs:



Ex.: When you select "Intro Track"

Note:

MP3 indicator also lights up if the current playing disc is an MP3 disc.

Mode	Active indicator	Plays the beginnings (15 seconds) of
Intro Track	 INT indicator lights up.	All tracks/files of the current disc.
Intro Folder*	 INT indicator lights up.	The first file of every folder of the current disc.
Intro Disc	 INT indicator lights up.	The first tracks/files of the inserted discs.

* "Intro Folder" is only applicable for MP3 disc.

To cancel intro scan, select "Intro Off" by pressing number button 1 repeatedly or press number button 4 in step 2.

Changing the display information

While playing back an MP3 file, you can change the MP3 disc information shown on the display.

Note:

When playing a CD or a CD Text, you can also change the disc information, see page 19 for details.

DISP



Each time you press the button, the display changes to show the following:

Large animation display

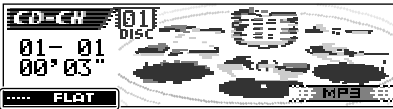

Current sound mode (iEQ) (see page 21)

Small animation display 1



Clock time

Small animation display 2

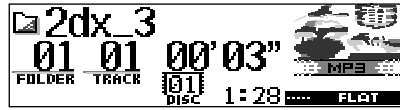

Small animation display 3



Small animation display 4

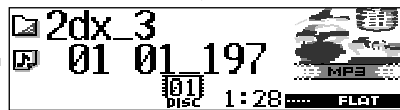

Clock time display



The above diagram shows the examples of the display when “Tag” is set to “Off.”

Notes:

- When the folder name is shown, the (folder) indicator lights up. When the file name is shown, the (file) indicator lights up.
- If the information cannot be shown at a time, it will scroll on the display.
Some characters or symbols will not be shown (will be blanked or substituted) on the display.
- If “Tag” is set to “On” (see page 27), ID3 tag information will appear on the display if the disc has an ID3 tag. The album name/performer and (disc) appears on the display instead of the folder name; while track title and (track) appears instead of the file name.



EXTERNAL COMPONENT OPERATIONS

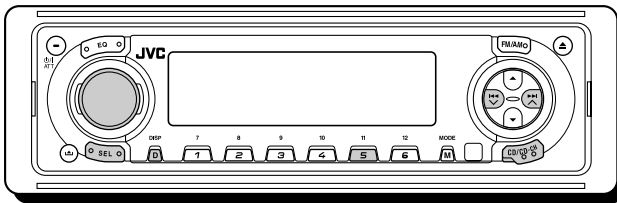

Playing an external component

You can connect the external component to the CD changer jack on the rear using the Line Input Adapter KS-U57 (not supplied).

Preparation:

For connecting the Line Input Adapter KS-U57 and the external component, refer to the Installation/Connection Manual (separate volume).

Before operating the external component, select the external input correctly, follow the procedure below.

- See also “Changing the general settings (PSM)” on pages 24 and 25.

- 1 Press and hold SEL (select) for more than 2 seconds so that one of the PSM items appears on the display.
- 2 Press number button 5 to select “AUDIO”—Audio category of the PSM setting.
- 3 Press **▶▶** **▲** or **◀◀** **▼** to select “Ext Input”^{*}.
- 4 Turn the control dial clockwise to select “Line In.”
- 5 Press SEL (select) to finish the setting.

- For details, see “To select the external component to use—Ext Input” on page 27.

^{*} Displayed only when one of the following sources is selected—FM, AM, and CD.

Select the external component correctly, follow the procedure below.

- 1 Select the external component (Line In).

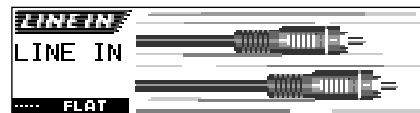

- If “Line In”^{*} does not appear on the display, see page 27 and select the external input (“Line In”) in the “Ext Input” setting.

^{*} Displayed only when one of the following sources is selected—FM, AM, and CD.

Note on One-Touch Operation:

When you press CD/CD-CH, the power automatically comes on. You do not have to press **⏻**/I/ATT to turn on the power.

- 2 Turn on the connected component and start playing the source.
- 3 Adjust the volume.

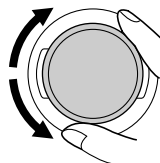

- 4 Adjust the sound characteristics you want. (See pages 20 – 22.)

Note:

You can also change the display pattern by pressing **D** (DISP) repeatedly.



Sound modes (preset frequency level settings)

The list below shows the preset frequency level settings for each sound mode.

- You can adjust the preset sound modes (except User 1/2/3) temporarily. However, your temporary adjustments will be reset when you select another sound mode.

Sound Mode	Preset equalizing values						
	60 Hz	150 Hz	400 Hz	1 kHz	2.4 kHz	6 kHz	12 kHz
Flat	00	00	00	00	00	00	00
Hard Rock	+03	+03	+01	00	00	+02	+01
R & B	+03	+02	+02	00	+01	+01	+03
Pop	00	+02	00	00	+01	+01	+02
Jazz	+03	+02	+01	+01	+01	+03	+02
Dance Music	+04	+02	00	-02	-01	+01	+01
Country	+02	+01	00	00	00	+01	+02
Reggae	+03	00	00	+01	+02	+02	+03
Classic	+02	+03	+01	00	00	+02	00
User 1	00	00	00	00	00	00	00
User 2	00	00	00	00	00	00	00
User 3	00	00	00	00	00	00	00

Available characters

You can use the following characters to assign names to stations, CDs, and external component. (See page 31.)

Capital letters

A	B	C	D	E
F	G	H	I	J
K	L	M	N	O
P	Q	R	S	T
U	V	W	X	Y
Z	space			

Small letters

a	b	c	d	e
f	g	h	i	j
k	l	m	n	o
p	q	r	s	t
u	v	w	x	y
z	space			

Numbers and symbols

0	1	2	3	4
5	6	7	8	9
!	"	#	\$	%
&	'	()	*
+	,	-	.	/
:	;	<	=	>
?	@	_	`	space



TROUBLESHOOTING

What appears to be trouble is not always serious. Check the following points before calling a service center.

	Symptoms	Causes	Remedies
General	<ul style="list-style-type: none"> • Sound cannot be heard from the speakers. 	The volume level is set to the minimum level.	Adjust it to the optimum level.
		Connections are incorrect.	Check the cords and connections.
	<ul style="list-style-type: none"> • This unit does not work at all. 	The built-in microcomputer may have functioned incorrectly due to noise, etc.	Press the reset button on the panel holder after detaching the control panel. (The clock setting and preset stations stored in memory are erased.) (See page 2.)
	<ul style="list-style-type: none"> • “Panel Connect Error” appears on the display. 	The control panel is not attach correctly and firmly.	Remove the control panel, wipe the connectors, then attach it again. (See page 32.)
FM/AM	<ul style="list-style-type: none"> • SSM (Strong-station Sequential Memory) automatic preset does not work. 	Signals are too weak.	Store stations manually.
	<ul style="list-style-type: none"> • Static noise while listening to the radio. 	The antenna is not connected firmly.	Connect the antenna firmly.
Disc Playback	<ul style="list-style-type: none"> • Disc cannot be played back. 	Disc is inserted upside down.	Insert the disc correctly.
	<ul style="list-style-type: none"> • CD-R/CD-RW cannot be played back. • Tracks on the CD-R/CD-RW cannot be skipped. 	CD-R/CD-RW is not finalized.	<ul style="list-style-type: none"> • Insert a finalized CD-R/CD-RW. • Finalize the CD-R/CD-RW with the component which you used for recording.
		Disc cannot be ejected.	Disc is locked.
	<ul style="list-style-type: none"> • Disc sound is sometimes interrupted. 	You are driving on rough roads.	Stop playback while driving on rough roads.
		Disc is scratched.	Change the disc.
		Connections are incorrect.	Check the cords and connections.
	<ul style="list-style-type: none"> • “No Disc” flashes on the display. 	No disc in the loading slot.	Insert a disc into the loading slot.
Disc is inserted incorrectly.		Insert the disc correctly.	



Symptoms	Causes	Remedies
<ul style="list-style-type: none"> • “No Disc” flashes on the display. 	No disc is in the magazine.	Insert discs into the magazine.
	Discs are inserted upside down.	Insert discs correctly.
	Discs are unplayable.	Insert playable discs.
<ul style="list-style-type: none"> • “No Magazine” flashes on the display. 	No magazine is loaded in the CD changer.	Insert the magazine.
<ul style="list-style-type: none"> • “No File” flashes on the display. 	The current disc does not contain any MP3 files.	Insert a disc that contains MP3 files.
<ul style="list-style-type: none"> • MP3 disc is skipped or cannot be played back. 	MP3 files do not have the extension code—mp3 in their file names.	Add the extension code —mp3 to their file names.
	MP3 files are not recorded in the format compliant with ISO 9660 Level 1, Level 2, or Joliet.	Change the disc. (Record MP3 files using a compliant application.)
<ul style="list-style-type: none"> • Noise is generated while playing an MP3 disc. 	The file played back is not an MP3 file (although it has the extension code—mp3).	Skip to another file or change the disc. (Do not add the extension code—mp3 to non-MP3 files.)
<ul style="list-style-type: none"> • A longer readout time is required for an MP3 disc (“File Check” keeps flashing on the display). 	Readout time varies due to the complexity of the folder/file configuration.	Do not use too many hierarchies and folders. Also, do not record any other types of audio tracks together with MP3 files.
<ul style="list-style-type: none"> • MP3 files cannot be played back as you have intended them to play. 	Playback order is determined when the files are recorded.	_____
<ul style="list-style-type: none"> • Elapsed playing time is not correct for an MP3 disc. 	This sometimes occurs during play. This is caused by how the files are recorded on the disc.	_____
<ul style="list-style-type: none"> • “Reset 8” flashes on the display. 	This unit is not connected to the CD changer correctly.	Connect this unit and the CD changer correctly and press the reset button of the CD changer.
<ul style="list-style-type: none"> • “Reset 1” – “Reset 7” flashes on the display. 	_____	Press the reset button of the CD changer.
<ul style="list-style-type: none"> • The CD changer does not work at all. 	The built-in microcomputer may function incorrectly due to noise, etc.	Press the reset button on the panel holder after detaching the control panel. (The clock setting and preset stations stored in memory are erased.) (See page 2.)

CD Changer



MAINTENANCE

Handling discs

This unit has been designed to reproduce CDs, CD-Rs (Recordable), CD-RWs (Rewritable), and CD Texts.

- **This unit is not compatible with MP3 discs,** but can operate a JVC MP3-compatible CD changer.

How to handle discs

When removing a disc from its case,

press down the center holder of the case and lift the disc out, holding it by the edges.

Center holder

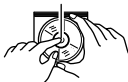

- Always hold the disc by the edges. Do not touch its recording surface.

When storing a disc into its case, gently insert the disc around the center holder (with the printed surface facing up).

- Make sure to store discs into the cases after use.

To keep discs clean

A dirty disc may not play correctly. If a disc does become dirty, wipe it with a soft cloth in a straight line from center to edge.



To play new discs

New discs may have some rough spots around the inner and outer edges. If such a disc is used, this unit may reject the disc.

To remove these rough spots, rub the edges with a pencil or ball-point pen, etc.



Moisture condensation

Moisture may condense on the lens inside the CD player in the following cases:

- After starting the heater in the car.
- If it becomes very humid inside the car.

Should this occur, the CD player may malfunction. In this case, eject the disc and leave the unit turned on for a few hours until the moisture evaporates.

When playing a CD-R or CD-RW

Before playing back CD-Rs or CD-RWs, read their instructions or cautions carefully.

- Use only “finalized” CD-Rs or CD-RWs.
- Some CD-Rs or CD-RWs may not play back on this unit because of their disc characteristics, and for the following reasons:
 - Discs are dirty or scratched.
 - Moisture condensation on the lens inside the unit.
 - The pickup lens inside the unit is dirty.
- CD-RWs may require a longer readout time since the reflectance of CD-RWs is lower than that of regular CDs.
- CD-Rs or CD-RWs are susceptible to high temperatures or high humidity, so do not leave them inside your car.
- Do not use following CD-Rs or CD-RWs:
 - Discs with stickers, labels, or protective seal stuck to the surface.
 - Discs on which labels can be directly printed by an ink jet printer.

Using these discs under high temperatures or high humidity may cause malfunctions or damage to discs. For example,

- Stickers or labels may shrink and warp a disc.
- Stickers or labels may peel off so discs cannot be ejected.
- Print on discs may get sticky.

Read instructions or cautions about labels and printable discs carefully.

CAUTIONS:

- Do not insert 8 cm (3-3/16") discs (single CDs) into the loading slot. (Such discs cannot be ejected.)
- Do not insert any disc of unusual shape—like a heart or flower; otherwise, it will cause a malfunction.
- Do not expose discs to direct sunlight or any heat source or place them in a place subject to high temperature and humidity. Do not leave them in a car.
- Do not use any solvent (for example, conventional record cleaner, spray, thinner, benzine, etc.) to clean discs.

Warped disc



Sticker



Sticker residue



Stick-on label

AUDIO AMPLIFIER SECTION

Maximum Power Output:

Front: 50 W per channel

Rear: 50 W per channel

Continuous Power Output (RMS):

Front: 19 W per channel into 4 Ω , 40 Hz to 20 000 Hz at no more than 0.8% total harmonic distortion.

Rear: 19 W per channel into 4 Ω , 40 Hz to 20 000 Hz at no more than 0.8% total harmonic distortion.

Load Impedance: 4 Ω (4 Ω to 8 Ω allowance)

Equalizer Control Range:

Frequencies: 60 Hz, 150 Hz, 400 Hz, 1 kHz, 2.4 kHz, 6 kHz, 12 kHz

Level: ± 10 dB

Frequency Response: 40 Hz to 20 000 Hz

Signal-to-Noise Ratio: 70 dB

Line-Out Level/Impedance:

KD-LH1150: 4.0 V/20 k Ω load (full scale)

KD-LH1100: 2.0 V/20 k Ω load (full scale)

Output Impedance: 1 k Ω

Only for KD-LH1150:

Subwoofer-Out Level/Impedance:
2.0 V/20 k Ω load (full scale)

TUNER SECTION

Frequency Range:

FM: 87.5 MHz to 107.9 MHz

AM: 530 kHz to 1 710 kHz

[FM Tuner]

Usable Sensitivity: 11.3 dBf (1.0 μ V/75 Ω)

50 dB Quieting Sensitivity: 16.3 dBf (1.8 μ V/75 Ω)

Alternate Channel Selectivity (400 kHz): 65 dB

Frequency Response: 40 Hz to 15 000 Hz

Stereo Separation: 35 dB

Capture Ratio: 1.5 dB

[AM Tuner]

Sensitivity: 20 μ V

Selectivity: 35 dB

CD PLAYER SECTION

Type: Compact disc player

Signal Detection System: Non-contact optical pickup (semiconductor laser)

Number of channels: 2 channels (stereo)

Frequency Response: 5 Hz to 20 000 Hz

Dynamic Range: 96 dB

Signal-to-Noise Ratio: 98 dB

Wow and Flutter: Less than measurable limit

GENERAL

Power Requirement:

Operating Voltage:

DC 14.4 V (11 V to 16 V allowance)

Grounding System: Negative ground

Allowable Operating Temperature:

0°C to +40°C (32°F to 104°F)

Dimensions (W \times H \times D):

Installation Size (approx.):

182 mm \times 52 mm \times 150 mm

(7-3/16" \times 2-1/16" \times 5-15/16")

Panel Size (approx.):

188 mm \times 58 mm \times 12 mm

(7-7/16" \times 2-5/16" \times 1/2")

Mass (approx.):

1.4 kg (3.1 lbs) (excluding accessories)

Design and specifications are subject to change without notice.

About mistracking:

Mistracking may result from driving on extremely rough roads. This does not damage the unit and the disc, but will be annoying.

We recommend that you stop disc play while driving on such rough roads.

If a kit is necessary for your car, consult your telephone folder for the nearest car audio speciality shop.



JVC
MOBILE
ENTERTAINMENT

<http://www.jvcmobile.com>

Visit us on-line for

Technical Support & Customer Satisfaction Survey.

US RESIDENTS ONLY

**Having TROUBLE with operation?
Please reset your unit**

Refer to page of How to Reset
Still having trouble??

USA ONLY

Call 1-800-252-5722

<http://www.jvc.com>

We can help you!

JVC

VICTOR COMPANY OF JAPAN, LIMITED



EN, SP, FR

© 2003 VICTOR COMPANY OF JAPAN, LIMITED



0203KKSMdTJEIN

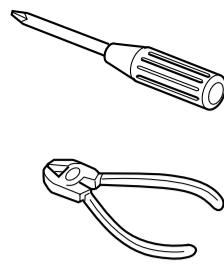

ENGLISH

- This unit is designed to operate on 12 V DC, NEGATIVE ground electrical systems.

INSTALLATION (IN-DASH MOUNTING)

- The following illustration shows a typical installation. However, you should make adjustments corresponding to your specific car. If you have any questions or require information regarding installation kits, consult your JVC car audio dealer or a company supplying kits.

- Before mounting:** Press (control panel release button) to detach the control panel if already attached.
 - When shipped from the factory, the control panel is packed in the hard case.
- Remove the trim plate.
- Remove the sleeve after disengaging the sleeve locks.
 - Stand the unit.
 - Note:** When you stand the unit, be careful not to damage the fuse on the rear.
 - Insert the 2 handles between the unit and the sleeve, as illustrated, to disengage the sleeve locks.
 - Remove the sleeve.
 - Note:** Be sure to keep the handles for future use after installing the unit.
- Install the sleeve into the dashboard.
 - After the sleeve is correctly installed into the dashboard, bend the appropriate tabs to hold the sleeve firmly in place, as illustrated.
- Fix the mounting bolt to the rear of the unit's body and place the rubber cushion over the end of the bolt.
- Do the required electrical connections.
- Slide the unit into the sleeve until it is locked.
- Attach the trim plate.
- Attach the control panel.

ESPAÑOL

- Esta unidad está diseñada para funcionar con 12 V de CC, con sistemas eléctricos de masa NEGATIVA.

INSTALACION (MONTAJE EN EL TABLERO DE INSTRUMENTOS)

- La siguiente ilustración muestra una instalación típica. Sin embargo usted deberá efectuar los ajustes correspondientes a su automóvil. Si tiene alguna pregunta o necesita información acerca de las herramientas para instalación, consulte con su concesionario de JVC de equipos de audio para automóviles o a una compañía que suministra tales herramientas.

- Antes de instalar:** Pulse (soltar panel de control) para separar el panel de control si ya está unido.
 - Cuando se envía de la fábrica, el panel de control está embalado en el estuche duro.
- Retire la placa de guarnición.
- Retire la cubierta después de desenganchar los retenes de la cubierta.
 - Ponga la unidad vertical.
 - Nota:** Al poner la unidad vertical, tenga cuidado de no dañar el fusible provisto en la parte posterior.
 - Inserte las 2 manijas entre la unidad y la cubierta tal como en la ilustración y desenganche los retenes de la cubierta.
 - Retire la cubierta.
 - Nota:** Después de instalar la unidad, asegúrese de guardar las manijas para uso futuro.
- Instale la cubierta en el tablero de instrumentos.
 - Después de que la cubierta esté correctamente instalada en el tablero de instrumentos, doble las lengüetas correspondientes para sostener la cubierta firmemente en su lugar, tal como se muestra.
- Fije el perno de montaje en la parte trasera del cuerpo de la unidad y coloque el cojín de goma sobre el extremo del perno.
- Realice las conexiones eléctricas requeridas.
- Deslice la unidad dentro de la cubierta hasta que quede trabada.
- Coloque la placa de guarnición.
- Coloque el panel de control.

FRANÇAIS

- Cet appareil est conçu pour fonctionner sur des sources de courant continu de 12 V à masse NEGATIVE.

INSTALLATION (MONTAGE DANS LE TABLEAU DE BORD)

- L'illustration suivante est un exemple d'installation typique. Cependant, vous devez faire les ajustements correspondant à votre voiture particulière. Si vous avez des questions ou avez besoin d'information sur des kits d'installation, consulter votre revendeur d'autoradios JVC ou une compagnie d'approvisionnement.

- Avant le montage:** Appuyer sur (déblocage du panneau de commande) pour éventuellement détacher le panneau de commande.
 - Lorsque ce panneau de commande sort d'usine, il est rangé dans un étui de transport.
- Retirer la plaque d'assemblage.
- Libérer les verrous du manchon et retirer le manchon.
 - Poser l'appareil à la verticale.
 - Remarque:** Lorsque vous mettez l'appareil à la verticale, faire attention de ne pas endommager le fusible situé sur l'arrière.
 - Insérer les 2 poignées entre l'appareil et le manchon comme indiqué pour désengager les verrous de manchon.
 - Retirer le manchon.
 - Remarque:** S'assurer de garder les poignées pour une utilisation ultérieure, après l'installation de l'appareil.
- Installer le manchon dans le tableau de bord.
 - Après installation correcte du manchon dans le tableau de bord, plier les bonnes pattes pour maintenir fermement le manchon en place, comme montré.
- Monter le boulon de montage sur l'arrière du corps de l'appareil puis passer l'amortisseur en caoutchouc sur l'extrémité du boulon.
- Réalisez les connexions électriques.
- Faire glisser l'appareil dans le manchon jusqu'à ce qu'il soit verrouillé.
- Attachez la plaque d'assemblage.
- Remonter le panneau de commande.

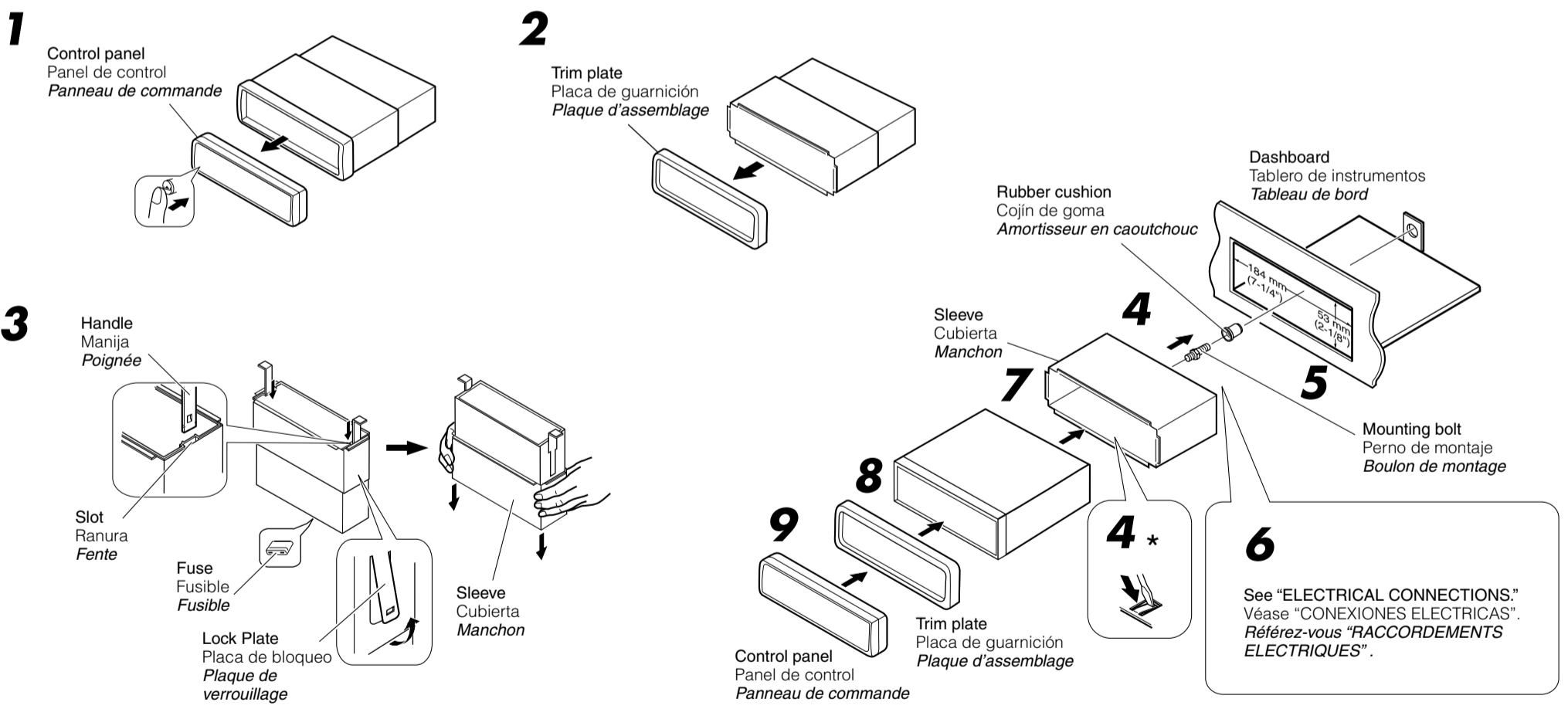

TROUBLESHOOTING

- The fuse blows.**
 - Are the red and black leads connected correctly?
- Power cannot be turned on.**
 - Is the yellow lead connected?
- No sound from the speakers.**
 - Is the speaker output lead short-circuited?
- Sound is distorted.**
 - Is the speaker output lead grounded?
 - Are the "-" terminals of L and R speakers grounded in common?
- Unit becomes hot.**
 - Is the speaker output lead grounded?
 - Are the "-" terminals of L and R speakers grounded in common?

LOCALIZACION DE AVERIAS

- El fusible se quema.**
 - ¿Están los conductores rojo y negro correctamente conectados?
- No es posible conectar la alimentación.**
 - ¿Está el cable amarillo conectado?
- No sale sonido de los altavoces.**
 - ¿Está el cable de salida del altavoz cortocircuitado?
- El sonido presenta distorsión.**
 - ¿Está el cable de salida del altavoz conectado a masa?
 - ¿Están los terminales "-" de los altavoces L y R conectados a una masa común?
- La unidad se calienta.**
 - ¿Está el cable de salida del altavoz conectado a masa?
 - ¿Están los terminales "-" de los altavoces L y R conectados a una masa común?

EN CAS DE DIFFICULTES

- Le fusible saute.**
 - Les fils rouge et noir sont-ils raccordés correctement?
- L'appareil ne peut pas être mise sous tension.**
 - Le fil jaune est-elle raccordée?
- Pas de son des enceintes.**
 - Le fil de sortie de d'enceinte est-il court-circuité?
- Le son est déformé.**
 - Le fil de sortie de d'enceinte est-il à la masse?
 - Les bornes "-" des enceintes gauche et droit sont-elles mises ensemble à la masse?
- L'appareil devient chaud.**
 - Le fil de sortie de d'enceinte est-il à la masse?
 - Les bornes "-" des enceintes gauche et droit sont-elles mises ensemble à la masse?

- When using the optional stay
- Cuando emplea un soporte opcional
- Lors de l'utilisation du hauban en option

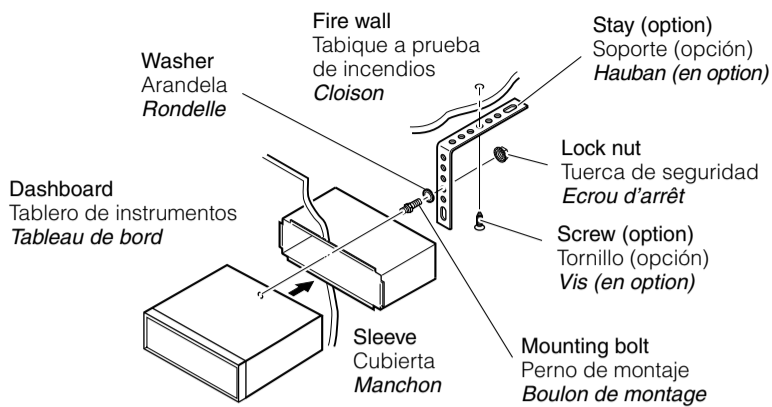

- When installing the unit without using the sleeve
- Instalación de la unidad sin utilizar la cubierta
- Lors de l'installation de l'appareil sans utiliser de manchon

In a Toyota for example, first remove the car radio and install the unit in its place.
En un Toyota por ejemplo, primero extraiga la radio del automóvil y luego instale la unidad en su lugar.
Par exemple dans une Toyota, retirer d'abord l'autoradio et installer l'appareil à la place.

Flat type screws—M5 x 6 mm (M5 x 1/4")*
Tornillos tipo plano—M5 x 6 mm (M5 x 1/4 pulgada)*
Vis à tête plate—M5 x 6 mm (M5 x 1/4 pouces)*

* Not included with this unit.
* No suministrado con esta unidad.
* Non fourni avec cet appareil.

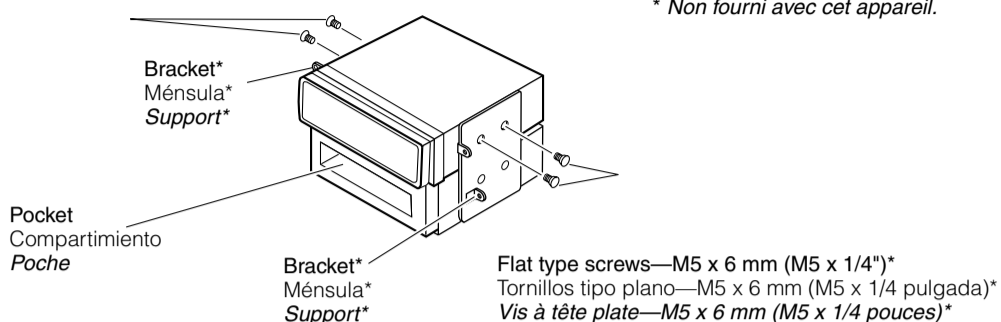

- Note** : When installing the unit on the mounting bracket, make sure to use the 6 mm (1/4")-long screws. If longer screws are used, they could damage the unit.
Nota : Cuando instala la unidad en la ménsula de montaje, asegúrese de utilizar los tornillos de 6 mm (1/4 pulgada) de longitud. Si se utilizan tornillos más largos, éstos pueden dañar la unidad.
Remarque : Lors de l'installation de l'appareil sur le support de montage, s'assurer d'utiliser des vis d'une longueur de 6 mm (1/4 pouces). Si des vis plus longues sont utilisées, elles peuvent endommager l'appareil.

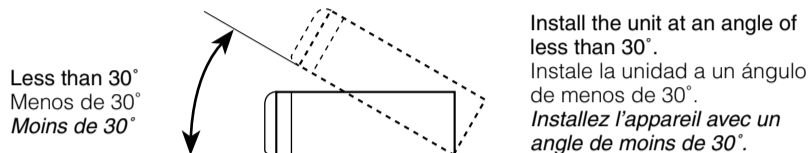

Removing the unit

- Before removing the unit, release the rear section.
- 1** Remove the control panel.
- 2** Remove the trim plate.
- 3** Insert the 2 handles into the slots, as shown. Then, while gently pulling the handles away from each other, slide out the unit. (**Be sure to keep the handles after installing it.**)

Extracción de la unidad

- Antes de extraer la unidad, libere la sección trasera.
- 1** Extraiga el panel de control.
- 2** Retire la placa de guarnición.
- 3** Inserte las 2 manijas entre las ranuras, como se muestra. Luego, separe suavemente las manijas y extraiga la unidad. (**Asegúrese de conservar las manijas después de instalarlo.**)

Retrait de l'appareil

- Avant de retirer l'appareil, libérer la section arrière.
- 1** Retirer le panneau de commande.
- 2** Retirer la plaque d'assemblage.
- 3** Introduire les deux poignées dans les fentes, comme montré. Puis, tout en tirant doucement les poignées écartées, faire glisser l'appareil pour le sortir. (**S'assurer de conserver les poignées après l'installation de l'appareil.**)

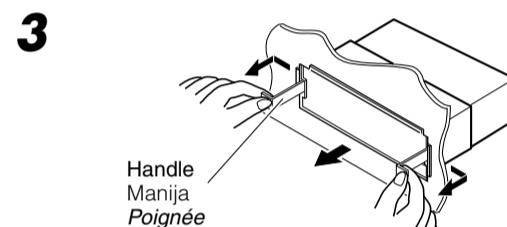
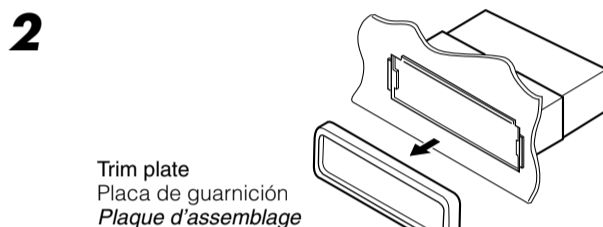
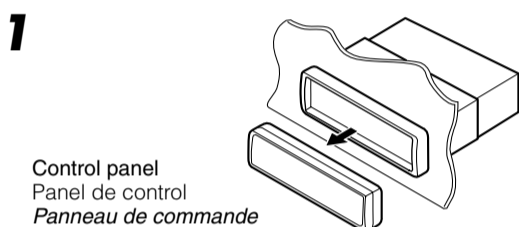

Parts list for installation and connection

The following parts are provided with this unit.
After checking them, please set them correctly.

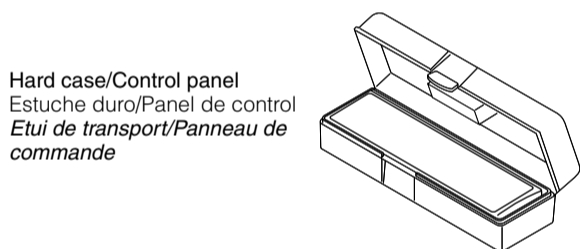

Sleeve
Cubierta
Manchon

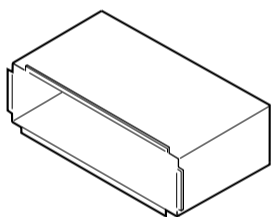

Trim plate
Placa de guarnición
Plaque d'assemblage

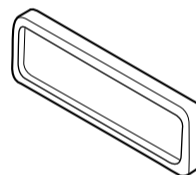

Power cord
Cordón de alimentación
Cordon d'alimentation

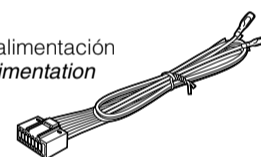

Washer—ø5
Arandela—ø5
Rondelle—ø5



Lock nut—M5
Tuerca de seguridad—M5
Ecrou d'arrêt—M5



Mounting bolt
—M5 x 20 mm (M5 x 13/16")
Perno de montaje
—M5 x 20 mm (M5 x 13/16 pulgada)
Boulon de montage
—M5 x 20 mm (M5 x 13/16 pouces)



Rubber cushion
Cojín de goma
Amortisseur en caoutchouc



Only for KD-LH3150/KD-LH3100
Solo para KD-LH3150/KD-LH3100
Seulement pour le KD-LH3150/KD-LH3100

CD-ROM (Image Converter)
CD-ROM (Image Converter)
CD-ROM (Image Converter)



Handles
Manijas
Poignées

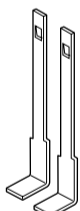

Battery
Pila
Pile



Remote controller
Control remoto
Télécommande

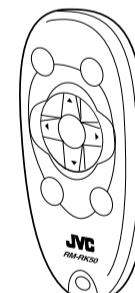

ELECTRICAL CONNECTIONS

To prevent short circuits, we recommend that you disconnect the battery's negative terminal and make all electrical connections before installing the unit. If you are not sure how to install this unit correctly, have it installed by a qualified technician.

Note:

This unit is designed to operate on **12 V DC, NEGATIVE ground electrical systems**. If your vehicle does not have this system, a voltage inverter is required, which can be purchased at JVC car audio dealer.

- Replace the fuse with one of the specified rating. If the fuse blows frequently, consult your JVC car audio dealer.
- If noise is a problem...
This unit incorporates a noise filter in the power circuit. However, with some vehicles, clicking or other unwanted noise may occur. If this happens, connect the unit's **rear ground terminal** (see connection diagram) to the car's chassis using shorter and thicker cords, such as copper braiding or gauge wire. If noise still persists, consult your JVC car audio dealer.
- Maximum input of the speakers should be more than 50 W at the rear and 50 W at the front, with an impedance of **4 Ω to 8 Ω**.
- **Be sure to ground this unit to the car's chassis.**
- The heat sink becomes very hot after use. Be careful not to touch it when removing this unit.

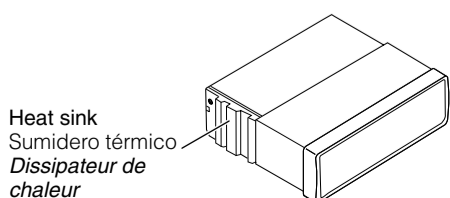

CONEXIONES ELECTRICAS

Para evitar cortocircuitos, recomendamos que desconecte el terminal negativo de la batería y que efectúe todas las conexiones eléctricas antes de instalar la unidad. Si usted no está seguro de cómo instalar correctamente la unidad, hágala instalar por un técnico cualificado.

Nota:

Esta unidad está diseñada para funcionar con **12 V de CC, con sistemas eléctricos de masa NEGATIVA**. Si su vehículo no posee este sistema, será necesario un inversor de tensión, que puede ser adquirido en los concesionarios de JVC de equipos de audio para automóviles.

- Reemplace el fusible por uno con la corriente especificada. Si el fusible se quemase frecuentemente consulte con su concesionario de JVC de equipos de audio para automóviles.
- Si el ruido fuese un problema...
Esta unidad tiene un filtro de ruido en el circuito de alimentación. Sin embargo, en algunos vehículos, pueden producirse chasquidos u otros ruidos indeseados. En tal caso conecte el **terminal de tierra posterior** (véase diagrama de conexión) del receptor al chasis del automóvil, utilizando cordones más gruesos y cortos tales como alambre de cobre trenzado o de grueso calibre. Si el ruido persiste, consulte a su concesionario de JVC de equipos de audio para automóvil.
- La entrada máxima de los altavoces debe ser de más de 50 W en la frontal y 50 W en el trasero, con una impedancia de **4 Ω a 8 Ω**.
- **Asegúrese de conectar esta unidad a tierra en el chasis del automóvil.**
- El sumidero térmico estará muy caliente después del uso. Asegúrese de no tocarlo al desmontar esta unidad.

RACCORDEMENTS ELECTRIQUES

Pour éviter tout court-circuit, nous vous recommandons de débrancher la borne négative de la batterie et d'effectuer tous les raccordements électriques avant d'installer l'appareil. Si l'on n'est pas sûr de pouvoir installer correctement cet appareil, le faire installer par un technicien qualifié.

Remarque:

- Cet appareil est conçu pour fonctionner sur des sources de courant continu de **12 V à masse NEGATIVE**. Si votre véhicule n'offre pas ce type d'alimentation, il vous faut un convertisseur de tension, que vous pouvez acheter chez un revendeur d'autoradios JVC.
- Remplacer le fusible par un de la valeur précisée. Si le fusible saute souvent, consulter votre revendeur d'autoradios JVC.
 - Si le bruit est un problème...
Cet appareil incorpore un filtre de bruit dans le circuit d'alimentation. Cependant, avec certains véhicules, quelques claquements ou autres bruits non désirés risquent de se produire. Si cela arrive, raccorder la **borne arrière de masse** de l'appareil au châssis de la voiture (voir le diagramme de raccordement) en utilisant des cordons les plus gros et les plus courts possibles telle qu'une barre de cuivre ou une tresse. Si le bruit persiste, consulter votre revendeur d'autoradios JVC.
 - La puissance admissible des enceintes devrait supérieure à 50 W à l'arrière et à 50 W l'avant, avec une impédance de **4 Ω à 8 Ω**.
 - **S'assurer de raccorder la mise à la masse de cet appareil au châssis de la voiture.**
 - Le dissipateur de chaleur devient très chaud après usage. Faire attention de ne pas le toucher en retirant cet appareil.

Typical Connections / Conexiones típicas / Raccordements typiques

Before connecting: Check the wiring in the vehicle carefully not to fail in connecting this unit. Incorrect connection may cause a serious damage to this unit.

The leads of the power cord and those of the connector from the car body may be different in color.

1 Connect the colored leads of the power cord to the car battery, speakers and automatic antenna (if any) in the following sequence.

- ① Black: ground
- ② Yellow: to car battery (constant 12 V)
- ③ Red: to an accessory terminal
- ④ Blue with white stripe: to remote lead of other equipment or automatic antenna if any (200 mA max.)
- ⑤ Orange with white stripe: to car light control switch
- ⑥ Others: to speakers

2 Connect the antenna cord.

3 Finally connect the wiring harness to the unit.

Antes de la conexión: Verifique atentamente el conexionado del vehículo para no cometer errores al conectar esta unidad. Una conexión incorrecta podría producir daños graves en la unidad.

Los cordones del cable de alimentación y los del conector procedentes de la carrocería del automóvil podrían ser de diferentes en color.

1 Conecte los conductores de color del cable de alimentación a la batería del automóvil, altavoces y antena automática (si la hubiere) en la secuencia siguiente.

- ① Negro: a tierra
- ② Amarillo: a la batería del automóvil (12 V constantes)
- ③ Rojo: a un terminal de accesorio
- ④ Azul con rayas blancas: al conductor remoto de otro equipo o de la antena automática, si hubiere (máx. 200 mA)
- ⑤ Naranja con rayas blancas: al interruptor de control de las luces del automóvil
- ⑥ Otros: a los altavoces

2 Conecte el cable de antena.

3 Por último, conecte a la unidad el cableado preformado.

Avant de commencer la connexion: vérifiez attentivement le câblage du véhicule pour ne pas connecter incorrectement cet appareil. Une connexion incorrecte peut endommager sérieusement l'appareil.

Le fil du cordon d'alimentation et ceux des connecteurs du châssis de la voiture peuvent être différents en couleur.

1 Connectez les fils de couleur du cordon d'alimentation à la batterie de la voiture, aux enceintes et à l'antenne automatique (s'il y en a une) dans l'ordre suivant.

- ① Noir: a la masse
- ② Jaune: a la batterie de la voiture (12 V constant)
- ③ Rouge: à la prise accessoire
- ④ Bleu avec bande blanche: au fil de télécommande de l'autre appareil ou à l'antenne automatique s'il y en a une (200 mA max.)
- ⑤ Orange avec bande blanche: à l'interrupteur d'éclairage de la voiture
- ⑥ Autres fils: aux enceintes

2 Connectez le cordon d'antenne.

3 Finalement, connectez le faisceau de fils à l'appareil.

- Before connecting the CD changer, make sure that the unit is turned off.
- Antes de conectar el cambiador de CD, asegúrese de que la unidad esté apagada.
- Avant de connecter le changeur CD, s'assurer que l'unité est éteinte.

SUBWOOFER OUT—only for KD-LH3150/KD-LH3100/KD-LH1150 (see diagram B)

Salida de SUBWOOFER—solo para KD-LH3150/KD-LH3100/KD-LH1150 (véase diagrama B)

Sortie de caisson de grave—seulement pour le KD-LH3150/KD-LH3100/KD-LH1150 (voir le diagramme B)

LINE IN—only for KD-LH3150 (see diagram B)

Entrada de línea—solo para KD-LH3150 (véase diagrama B)
Entrée de ligne—seulement pour le KD-LH3150 (voir le diagramme B)

JVC CD changer
Cambiador de CD JVC
Changeur de CD JVC

We recommend you to connect the JVC MP3-compatible CD changer. You can also connect other CH-X series CD changers (except CH-X99 and CH-X100).

• You cannot use the KD-MK series CD changers with this unit.

Only for KD-LH3100/KD-LH1150/KD-LH1100: You can also use an external component such as a portable MD player by connecting the Line Input Adapter KS-U57 (not supplied). (See diagram B.)

Se recomienda conectar el cambiador de CD de JVC compatible con MP3. También se pueden conectar otros cambiadores de CD de la serie CH-X (excepto CH-X99 y CH-X100).

• Con esta unidad no se podrán utilizar cambiadores de CD de la serie KD-MK.

Solo para KD-LH3100/KD-LH1150/KD-LH1100: Conectando el adaptador de entrada de línea KS-U57 (no suministrado), también podrá usar un componente exterior, tal como un reproductor de MD. (Véase diagrama B.)

Nous vous recommandons de connecter le changeur de CD compatible MP3 JVC. Vous pouvez aussi connecter d'autres changeurs de CD de la série CH-X (sauf le CH-X99 et le CH-X100).

• Vous ne pouvez pas utiliser les changeurs de CD de la série KD-MK avec cet appareil.

Seulement pour le KD-LH3100/KD-LH1150/KD-LH1100: Vous pouvez aussi utiliser un appareil extérieur tel qu'un lecteur de MD en connectant l'adaptateur d'entrée de ligne KS-U57 (non fourni). (Voir le diagramme B.)

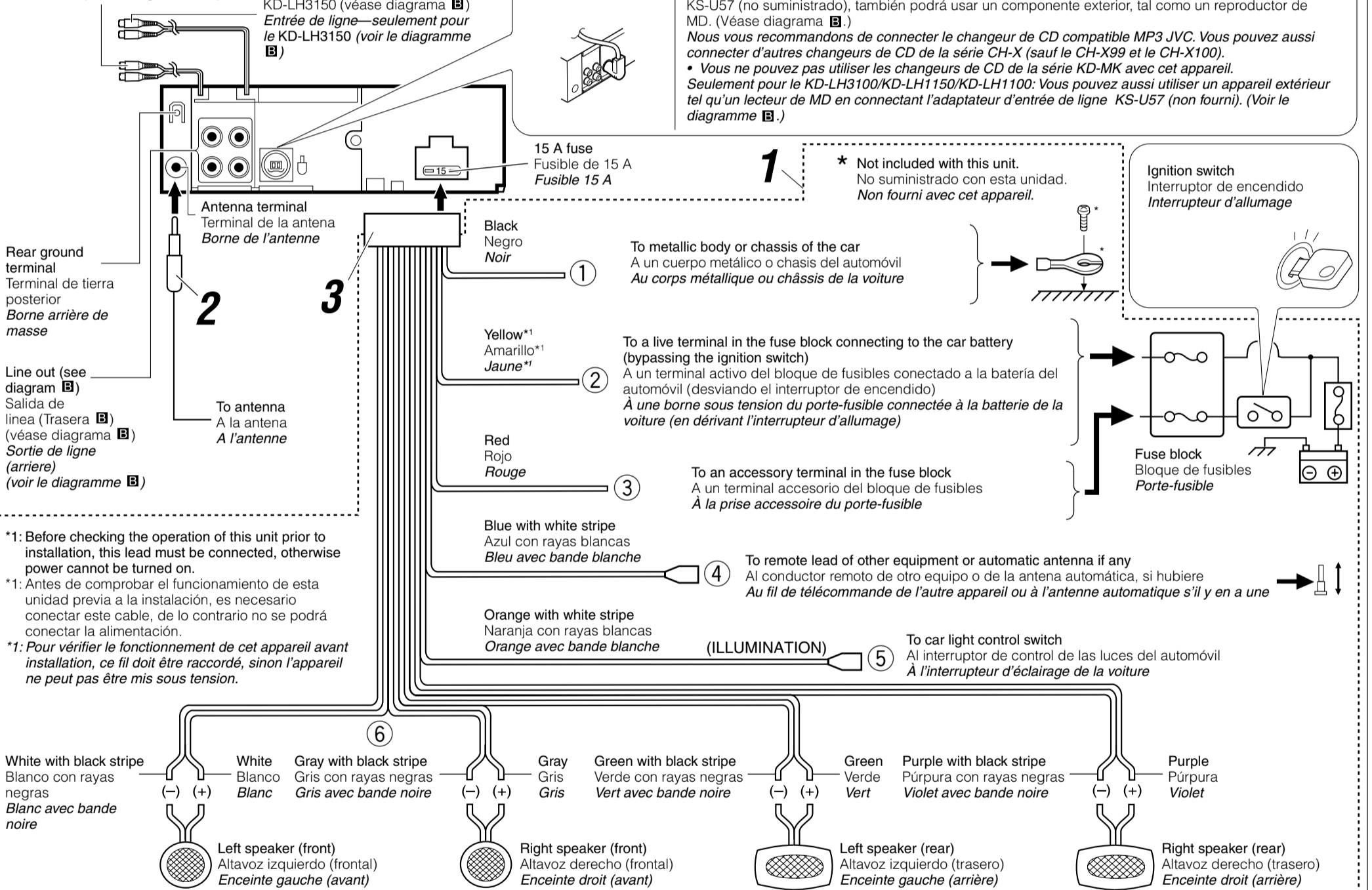

*1: Before checking the operation of this unit prior to installation, this lead must be connected, otherwise power cannot be turned on.

*1: Antes de comprobar el funcionamiento de esta unidad previa a la instalación, es necesario conectar este cable, de lo contrario no se podrá conectar la alimentación.

*1: Pour vérifier le fonctionnement de cet appareil avant installation, ce fil doit être raccordé, sinon l'appareil ne peut pas être mis sous tension.

PRECAUTIONS on power supply and speaker connections:

- **DO NOT** connect the speaker leads of the power cord to the car battery; otherwise, the unit will be seriously damaged.
- Connect the black lead (ground), yellow lead (to car battery, constant 12 V), and red lead (to an accessory terminal) correctly.
- **BEFORE** connecting the speaker leads of the power cord to the speakers, check the speaker wiring in your car.
 - If the speaker wiring in your car is as illustrated in Fig. 1 and Fig. 2 below, **DO NOT** connect the unit using that original speaker wiring. If you do, the unit will be seriously damaged. Redo the speaker wiring so that you can connect the unit to the speakers as illustrated in Fig. 3.
 - If the speaker wiring in your car is as illustrated in Fig. 3, you can connect the unit using the original speaker wiring in your car.
 - If you are not sure of the speaker wiring of your car, consult your car dealer.

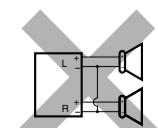

Fig. 1

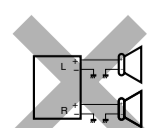

Fig. 2

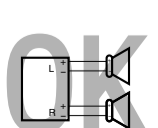

Fig. 3

PRECAUCIONES sobre las conexiones de la fuente de alimentación y de los altavoces:

- **NO** conecte los conductores de altavoz del cable de alimentación a la batería de automóvil, pues podrían producirse graves daños en la unidad.
- Conecte correctamente el conductor negro (a tierra), el conductor amarillo (a la batería del automóvil, 12 V constantes), y el conductor rojo (a un terminal de accesorio).
- **ANTES** de conectar a los altavoces los conductores de altavoz del cable de alimentación, verifique el conexionado de altavoz de su automóvil.
 - Si el conexionado de altavoz de su automóvil es como se indica en las Fig. 1 y Fig. 2 de abajo, **NO** conecte la unidad utilizando ese conexionado de altavoz original. Si lo hace, se producirán daños graves en la unidad. Vuelva a efectuar el conexionado de altavoz de manera que pueda conectar la unidad a los altavoces de la manera indicada en la Fig. 3.
 - Si el conexionado de altavoz de su automóvil es como se indica en la Fig. 3, podrá conectar la unidad utilizando el conexionado de altavoz original de su automóvil.
 - Si tiene dudas sobre el conexionado de altavoz de su automóvil, consulte con su concesionario.

PRECAUTIONS sur l'alimentation et la connexion des enceintes:

- **NE CONNECTEZ PAS** les fils d'enceintes du cordon d'alimentation à la batterie; sinon, l'appareil serait sérieusement endommagé.
- Connectez correctement le fil noir (a la masse), le fil jaune (a la batterie de la voiture, 12 V constant) et le fil rouge (à la prise accessoire).
- **AVANT** de connecter les fils d'enceintes du cordon d'alimentation aux enceintes, vérifiez le câblage des enceintes de votre voiture.
 - Si le câblage des enceintes de votre voiture est réalisé comme montré sur la Fig. 1 ou Fig. 2 ci-dessous, **NE CONNECTEZ PAS** l'appareil en utilisant ce câblage original d'enceintes. Si vous le faites, l'appareil sera sérieusement endommagé. Recommencez le câblage des enceintes de façon que vous puissiez connecter l'appareil aux enceintes comme montré sur la Fig. 3.
 - Si le câblage des enceintes de votre voiture est comme montré sur la Fig. 3, vous pouvez connecter l'appareil en utilisant ce câblage original d'enceintes pour votre voiture.
 - Si vous n'êtes pas sûrs du câblage d'enceintes de votre voiture, consultez le concessionnaire de votre voiture.

Connecting the leads / Conexión de los conductores / Raccordement des fils

Twist the core wires when connecting.
Retuerza los alambres de alma para conectarlos.
Torsader les âmes des fils en les raccordant.

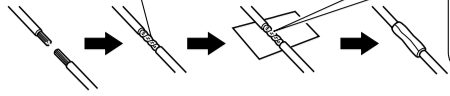

Solder the core wires to connect them securely.
Suelde los alambres de alma para conectarlos con firmeza.
Souder les âmes des fils pour les raccorder entre eux de façon sûre.



CAUTION / PRECAUCION / PRECAUTION:

- To prevent short-circuit, cover the terminals of the UNUSED leads with insulating tape.
- Para evitar cortocircuitos, cubra los cables NO UTILIZADOS con cinta aislante.
- Pour éviter les court-circuits, couvrir les bornes des fils qui ne sont PAS utilisés avec de la bande isolante.

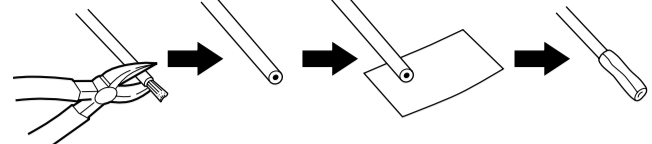

Connections Adding Other Equipment / Conexiones para añadir otros equipos / Raccordement pour ajouter d'autres appareils

You can connect an amplifier and other equipment to upgrade your car stereo system.

- Connect the remote lead (blue with white stripe) to the remote lead of the other equipment so that it can be controlled through this unit.
- For amplifier only:
 - Connect this unit's line-out terminals to the amplifier's line-in terminals.
 - Disconnect the speakers from this unit, connect them to the amplifier. Leave the speaker leads of this unit unused.**
 - For KD-LH3150/KD-LH1150: The line output level of this unit is kept high to maintain the hi-fi sounds reproduced from this unit.
 - When connecting an external amplifier to this unit, turn down the gain control on the external amplifier to obtain the best performance from this unit.**
- For playback source components: After connection is done, adjust and store the input level of each component. (See the INSTRUCTIONS—separate volume.)

Usted podrá conectar un amplificador y otros equipos para mejorar el sistema estéreo de su automóvil.

- Conecte el conductor remoto (azul con rayas blancas) al conductor remoto del otro equipo para poderlo controlar a través de esta unidad.
- Para el amplificador:
 - Conecte los terminales de salida de línea de esta unidad a los terminales de entrada de línea del amplificador.
 - Desconecte los altavoces de esta unidad y conéctelos al amplificador. Deje los conductores de los altavoces de esta unidad sin usar.**
 - Para KD-LH3150/KD-LH1150: El nivel de salida de línea de esta unidad permanece alto para que corresponda con los sonidos de alta fidelidad reproducidos por esta unidad.
 - Cuando conecte un amplificador externo a esta unidad, disminuya el control de ganancia del amplificador externo para obtener un óptimo rendimiento de esta unidad.**
- Para los componentes de la fuente de reproducción: Después de realizar la conexión, ajuste y almacene el nivel de entrada de cada componente. (Consulte las MANUAL DE INSTRUCCIONES—volumen separado.)

Vous pouvez connecter un amplificateur ou autre appareil pour améliorer votre système autoradio.

- Connectez le fil de commande à distance (bleu avec bande blanche) au fil de commande à distance de l'autre appareil de façon qu'il puisse être commandé via cet appareil.
- Pour l'amplificateur:
 - Raccorder les fiches de sortie ligne de cet appareil aux fiches d'entrée ligne de l'amplificateur.
 - Déconnectez les enceintes de cet appareil et connectez-les à l'amplificateur. Laissez les fils d'enceintes de cet appareil inutilisés.**
 - Pour le KD-LH3150/KD-LH1150: Le niveau de sortie de ligne de cet appareil est maintenu à un niveau élevé pour maintenir une qualité Hi-Fi pour les sons reproduits par cet appareil.
 - Lors de la connexion d'un amplificateur extérieur à cet appareil, diminuez le réglage du gain sur l'amplificateur extérieur pour obtenir les meilleures performances de cet appareil.**
- Pour la lecture d'appareils source: Une fois que la connexion est terminée, ajustez et mémorisez le niveau d'entrée de chaque appareil. (Référez-vous aux "MANUEL D'INSTRUCTIONS" du manuel séparé.)

Amplifier / Amplificador / Amplificateur

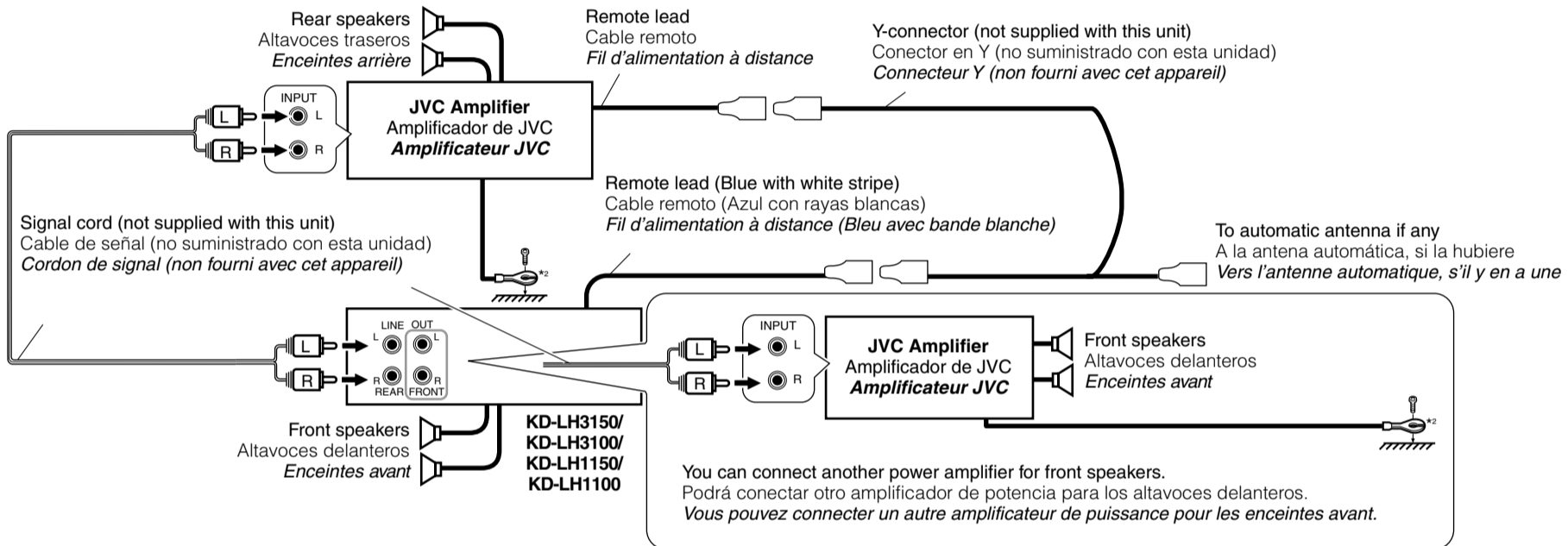

You can connect another power amplifier for front speakers.
Podrá conectar otro amplificador de potencia para los altavoces delanteros.
Vous pouvez connecter un autre amplificateur de puissance pour les enceintes avant.

- *2 Firmly attach the ground wire to the metallic body or to the chassis of the car—to the place not coated with paint (if coated with paint, remove the paint before attaching the wire). Failure to do so may cause damage to the unit.
- *2 Fije firmemente el cable de tierra a la carrocería metálica o al chasis—a un lugar no cubierto con pintura (si está cubierto con pintura, quítela antes de fijar el cable). De lo contrario, se podrían producir daños en la unidad.
- *2 Attachez solidement le fil de mise à la masse au châssis métallique de la voiture—à un endroit qui n'est pas recouvert de peinture (s'il est recouvert de peinture, enlevez d'abord la peinture avant d'attacher le fil). L'appareil peut être endommagé si cela n'est pas fait correctement.

Subwoofer (SUB WOOFER OUT) / Subwoofer (Salida de SUBWOOFER) / Caisson de grave (Sortie de caisson de grave)

Only for KD-LH3150/KD-LH3100/KD-LH1150 / Solo para KD-LH3150/KD-LH3100/KD-LH1150 / Seulement pour le KD-LH3150/KD-LH3100/KD-LH1150

You can connect a subwoofer through an amplifier to reinforce the bass.
For their connections, refer to the instructions supplied with your subwoofer.

Usted podrá conectar un subwoofer a través de un amplificador para reforzar los graves.
Con respecto a sus conexiones, refiérase a las instrucciones suministradas con sus subwoofer.

Vous pouvez connecter un caisson de grave par un amplificateur pour renforcer les graves.
Pour la connexion, référez-vous aux instructions fournies avec le caisson de grave.

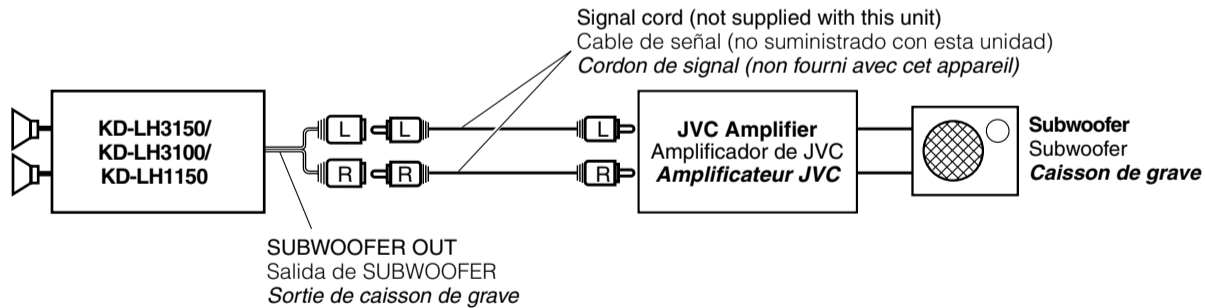

External component / Componente exterior / Appareil extérieur

Only for KD-LH3150 / Solo para KD-LH3150 / Seulement pour le KD-LH3150

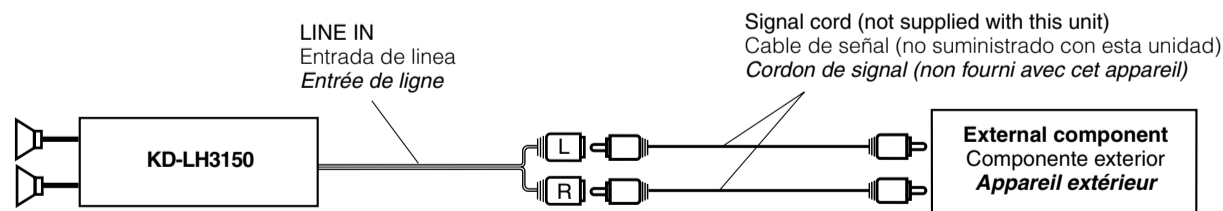

See the INSTRUCTIONS (separate volume) for how to use the external component with this unit. Consulte las MANUAL DE INSTRUCCIONES (volumen separado) para saber cómo utilizar el componente externo con esta unidad. Référez-vous aux "MANUEL D'INSTRUCTIONS" (manuel séparé) pour savoir comment utiliser l'appareil extérieur avec cet appareil.

Only for KD-LH3100/KD-LH1150/KD-LH1100 / Solo para KD-LH3100/KD-LH1150/KD-LH1100 / Seulement pour le KD-LH3100/KD-LH1150/KD-LH1100

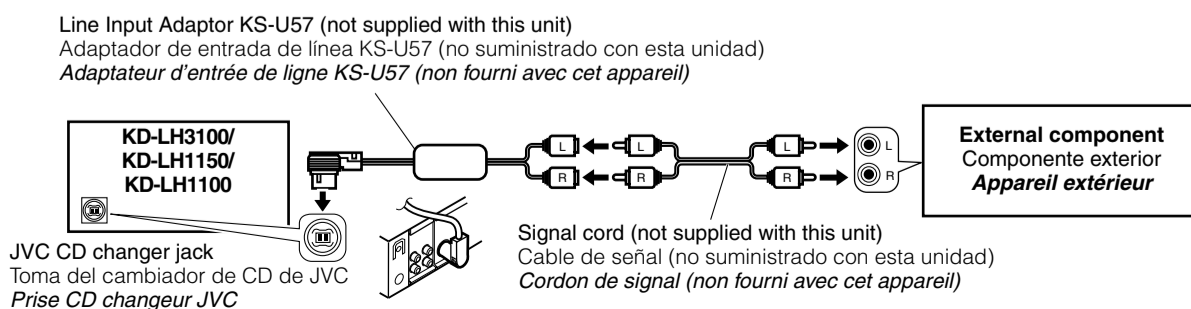

Free Manuals Download Website

<http://myh66.com>

<http://usermanuals.us>

<http://www.somanuals.com>

<http://www.4manuals.cc>

<http://www.manual-lib.com>

<http://www.404manual.com>

<http://www.luxmanual.com>

<http://aubethermostatmanual.com>

Golf course search by state

<http://golfingnear.com>

Email search by domain

<http://emailbydomain.com>

Auto manuals search

<http://auto.somanuals.com>

TV manuals search

<http://tv.somanuals.com>