

JVC

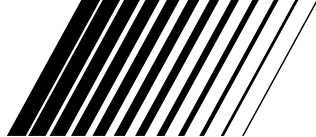

CD RECEIVER

KD-LH305

ENGLISH

CD 收音組合機

KD-LH305

中文

เครื่องเล่น CD

KD-LH305

ไทย

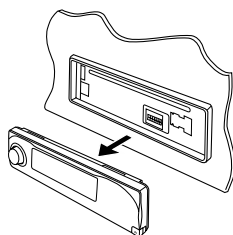
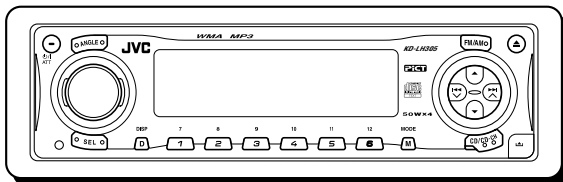

WMA MP3

PICT

COMPACT disc DIGITAL AUDIO TEXT

- This unit is equipped with the display demonstration. To cancel it, see page 8.
- 本機具有螢幕演示功能。要取消該功能，請參閱第 8 頁。
- เครื่องนี้ได้รับการติดตั้งการสาธิตภาพประกอบ หากต้องการยกเลิก โปรดดู หน้า 8

For installation and connections, refer to the separate manual.

有關安裝和連接方法，分別參閱操作手冊。

กรุณาดูคู่มือที่แยกต่างหาก ในการติดตั้งและการเชื่อมต่อ

INSTRUCTIONS

使用說明書

คำแนะนำ

GET0202-001B

[U]

IMPORTANT FOR LASER PRODUCTS

1. CLASS 1 LASER PRODUCT
2. **CAUTION:** Do not open the top cover. There are no user serviceable parts inside the unit; leave all servicing to qualified service personnel.
3. **CAUTION:** Visible and invisible laser radiation when open and interlock failed or defeated. Avoid direct exposure to beam.
4. REPRODUCTION OF LABEL: CAUTION LABEL, PLACED OUTSIDE THE UNIT.

CAUTION: Visible and invisible laser radiation when open and interlock failed or defeated. AVOID DIRECT EXPOSURE TO BEAM. (e)	ADVARSEL: Synlig og usynlig laserstråling når maskinen er åpen eller interlock feilet. Undgå direkte eksponering til stråling. (e)	WARNING: Synlig och osynlig laserstråling när den öppnas och spärran är urkopplad. Betrakta ej strålen. (d)	VARO: Avallatessa ja suojalukitus ohjeittuna tai viallisena olet alittuna näkövälle ja näkömittämälle lasersäteilylle. Vältä silmien kohdistumista suoraan itseesi. (f)
--------------------------------------------------------------------------------------------------------------------------------------	-------------------------------------------------------------------------------------------------------------------------------------------	--------------------------------------------------------------------------------------------------------------------	--------------------------------------------------------------------------------------------------------------------------------------------------------------------------------

Caution:

If the temperature inside the car is below 0 °C, the movement of animation and text scroll will be halted on the display to prevent the display from being blurred. **LOW TEMP.** (LOW TEMP.) indicator appears on the display. When the temperature increases, the operating temperature is resumed, and these functions will start working again.

CAUTION on Volume Setting:

Discs produce very little noise compared with other sources. If the volume level is adjusted for the tuner, for example, the speakers may be damaged by the sudden increase in the output level. Therefore, lower the volume before playing a disc and adjust it as required during playback.

How to reset your unit

Press the reset button on the control panel using a ball-point pen or a similar tool. This will reset the built-in microcomputer.

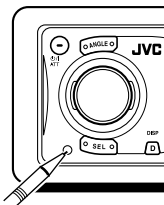

Note:

Your preset adjustments—such as preset channels or sound adjustments—will also be erased.

CAUTION:

NEVER insert your finger in between the control panel and the unit, as it may get caught or hurt. (See page 44.)

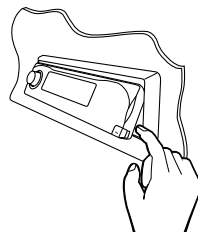

Thank you for purchasing a JVC product. Please read all instructions carefully before operation, to ensure your complete understanding and to obtain the best possible performance from the unit.

CONTENTS

How to reset your unit	2	GRAPHIC DISPLAYS	29
LOCATION OF THE BUTTONS	4	Downloading images and animations	30
Control panel	4	Deleting unwanted files	32
Remote controller	5	Activating the downloaded images and	
Preparing the remote controller	6	animations	34
BASIC OPERATIONS	7	OTHER MAIN FUNCTIONS	36
Turning on the power	7	Changing the general settings (PSM)	36
Canceling the display demonstration	8	Selecting the dimmer mode	40
Setting the clock	9	Changing the display color	41
RADIO OPERATIONS	10	Assigning names to the sources	43
Listening to the radio	10	Changing the control panel angle	44
Storing stations in memory	12	Detaching the control panel	45
Tuning in to a preset station	13	CD CHANGER OPERATIONS	46
Changing the display pattern	14	Playing discs	46
DISC OPERATIONS	15	Selecting a disc/folder/track using the	
About MP3 and WMA discs	15	name lists	49
Playing a disc	15	Selecting the playback modes	50
Locating a track or a particular portion		EXTERNAL COMPONENT OPERATIONS ...	52
on a disc	18	Playing an external component	52
Selecting a folder and a track using the		TROUBLESHOOTING	53
name lists	20	MAINTENANCE	56
Selecting the playback modes	21	Handling discs	56
Prohibiting disc ejection	22	SPECIFICATIONS	57
Changing the display pattern	23		
SOUND ADJUSTMENTS	24		
Adjusting the sound	24		
Selecting preset sound modes			
(iEQ: intelligent equalizer)	25		
Storing your own sound modes	27		
Selecting the display theme	28		

BEFORE USE

*For safety....

- Do not raise the volume level too much, as this will block outside sounds, making driving dangerous.
- Stop the car before performing any complicated operations.

*Temperature inside the car....

If you have parked the car for a long time in hot or cold weather, wait until the temperature in the car becomes normal before operating the unit.



LOCATION OF THE BUTTONS

ENGLISH

Control panel

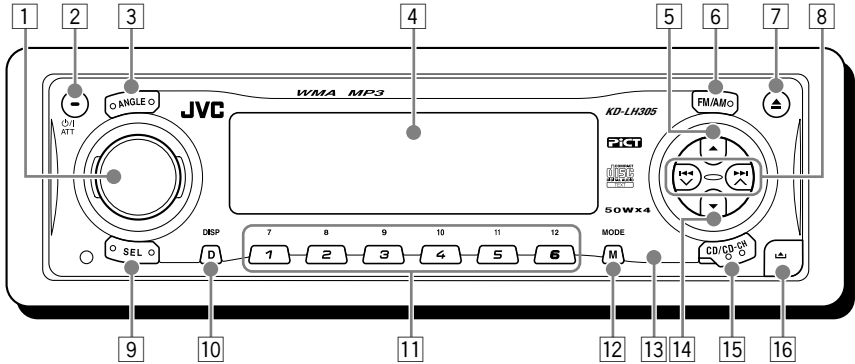

- | | |
|----------------------------------------------------|----------------------------------------------------|
| 1 Control dial | 9 SEL (select) button |
| 2 O/I ATT (standby/on attenuator) button | 10 D DISP (display) button |
| 3 ANGLE button | 11 Number buttons |
| 4 Display window | 12 M MODE button |
| 5 \blacktriangle (up) button | 13 Remote sensor |
| 6 FM/AM button | 14 \blacktriangledown (down) button |
| 7 \blacktriangle (eject) button | 15 CD/CD-CH (CD changer) button |
| 8 $\blacktriangleleft \blacktriangleright$ buttons | 16 \blacktriangle (control panel release) button |

Illumination Navigation for easy operations

If you use M MODE or SEL (select), the display and some controls (such as the number buttons, $\blacktriangleleft \blacktriangleright$, \blacktriangle , \blacktriangledown , and control dial) enter the corresponding control mode, then the controls start flashing to lead you to the next operational steps. (Illumination Navigation)

- The display shows how these buttons function during this period.

Ex.: When you press number button 1 after pressing M MODE, to operate the FM tuner.

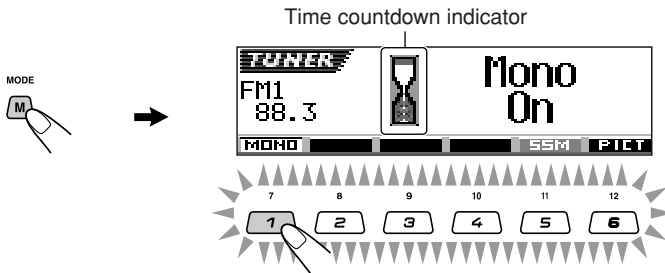

To use these controls for original functions again, wait until the controls stop flashing without using these controls.

- Pressing M MODE again also restores original functions. However, pressing SEL (select) makes the unit enter a different mode.



Remote controller

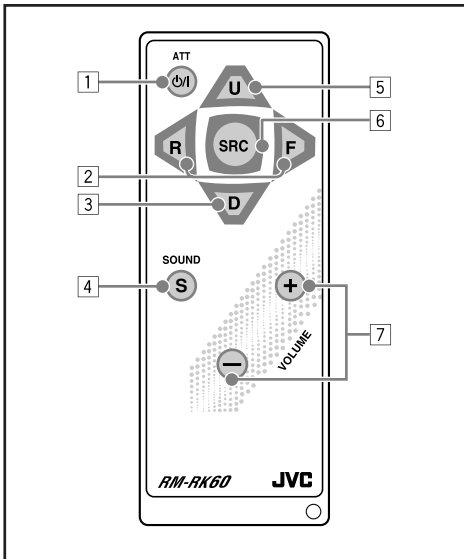

- 1 • Turns on the unit if pressed when the unit is turned off.
 - Turns off the unit if pressed and held for a few seconds.
 - Drops the volume level in a moment if pressed briefly. Press again to resume the volume.
- 2 • Searches for stations while listening to the radio.
 - Fast-forwards or reverses the track if pressed and held while listening to a disc.
 - Skips to the beginning of the next track or goes back to the beginning of the current (or previous) tracks if pressed briefly while listening to a disc.

- 3 • Selects the preset stations while listening to the radio.
 - Each time you press the button, the preset station number increases, and the selected station is tuned in.
 - Skips to the first track of the previous folder while listening to an MP3 or a WMA disc. Each time you press the button, you can move to the previous folder and start playing the first track.
 - While playing an MP3 disc on an MP3-compatible CD changer;
 - Skips to the previous disc if pressed briefly.
 - Skips to the previous folder if pressed and held.

Note: While playing a CD on a CD changer, this always skips to the previous disc.
- 4 Selects the sound mode (iEQ: intelligent equalizer).
 - Each time you press the button, the sound mode (iEQ) changes.
- 5 • Selects the band while listening to the radio.
 - Each time you press the button, the band changes.
 - Skips to the first track of the next folder while listening to an MP3 or a WMA disc. Each time you press the button, you can move to the next folder and start playing the first track.
 - While playing an MP3 disc on an MP3-compatible CD changer;
 - Skips to the next disc if pressed briefly.
 - Skips to the next folder if pressed and held.

Note: While playing a CD on a CD changer, this always skips to the next disc.
- 6 Selects the source.
 - Each time you press the button, the source changes.
- 7 Functions the same as the control dial on the main unit.

Note: These buttons do not function for the preferred setting mode (PSM) adjustment.

Preparing the remote controller

Before using the remote controller:

- Aim the remote controller directly at the remote sensor on the main unit. Make sure there is no obstacle in between.

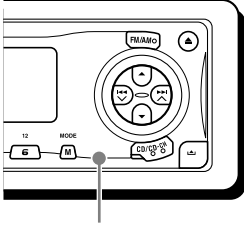

Remote sensor

- Do not expose the remote sensor to strong light (direct sunlight or artificial lighting).

Installing the battery

When the controllable range or effectiveness of the remote controller decreases, replace the battery.

1. Remove the battery holder.

- 1) Push out the battery holder in the direction indicated by the arrow using a ball-point pen or a similar tool.
- 2) Remove the battery holder.

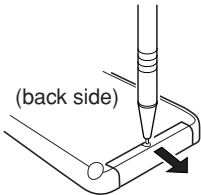

2. Place the battery.

Slide the battery into the holder with the + side facing upwards so that the battery is fixed in the holder.

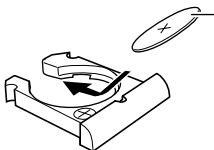

Lithium coin battery
(product number:
CR2025)

3. Return the battery holder.

Insert again the battery holder by pushing it until you hear a clicking sound.

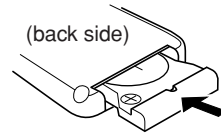

WARNING:

- Store the battery in a place where children cannot reach.
If a child accidentally swallows the battery, consult a doctor immediately.
- Do not recharge, short, disassemble, or heat the battery or dispose of it in a fire.
Doing any of these things may cause the battery to give off heat, crack, or start a fire.
- Do not leave the battery with other metallic materials.
Doing this may cause the battery to give off heat, crack, or start a fire.
- When throwing away or saving the battery, wrap it in tape and insulate; otherwise, the battery may start to give off heat, crack, or start a fire.
- Do not poke the battery with tweezers or similar tools.
Doing this may cause the battery to give off heat, crack, or start a fire.

CAUTION:

DO NOT leave the remote controller in a place (such as dashboards) exposed to direct sunlight for a long time. Otherwise, it may be damaged.

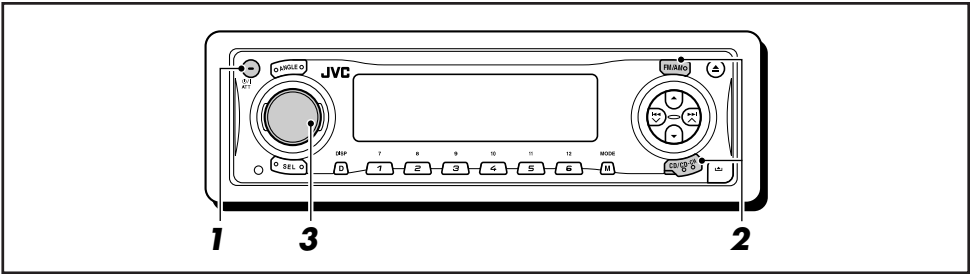

Turning on the power

1 Turn on the power.



Note on One-Touch Operation:

When you select a source in step 2 below, the power automatically comes on. You do not have to press this button to turn on the power.

2 Select the source.

- To operate the tuner, press FM/AM.

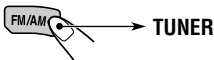

Then, press FM/AM repeatedly to select the band (FM1, FM2, FM3, or AM).

- To operate the CD player (CD), CD changer (CD-CH), or external component (LINE-IN), press CD/CD-CH repeatedly.

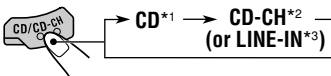

- *1 Without loading the CD, you cannot select "CD" as the source.
- *2 Without connecting the CD changer, you cannot select "CD-CH" as the source.
- *3 To select "LINE-IN" as the source, select "Line In" for the "Ext Input" setting on page 39.

3 Adjust the volume.

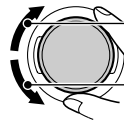

To increase the volume

To decrease the volume

Volume level appears.



Current sound mode (iEQ)
(see page 25)

4 Adjust the sound as you want. (See pages 24 – 27.)

Note:

While playing a source, you can select the display theme of your preference. For details, see "Selecting the display theme" on page 28.

NOTICE:

The illustrations of the display used in this manual are mainly of the initial setting when shipped from the factory. If you have changed the display themes or some PSM items, the actual displays you see will be different.



To drop the volume in a moment

Press **⏻/I ATT** briefly while listening to any source. “ATT” starts flashing on the display, and the volume level will drop in a moment.

To resume the previous volume level, press the button briefly again.

- If you turn the control dial, you can also restore the sound.

To turn off the power

Press and hold **⏻/I ATT** for more than one second.

- If you turn off the power while listening to a disc, disc play will start from where playback has been stopped previously, next time you turn on the power.

Canceling the display demonstration

When shipped from the factory, display demonstration has been activated, and starts automatically when no operations are done for about 20 seconds.

- It is recommended to cancel the display demonstration before you use the unit for the first time.

To cancel the display demonstration, follow the procedure below:

- 1 Press and hold SEL (select) for more than 2 seconds so that one of the PSM items appears on the display. (PSM: see pages 36 and 37.)**



The next-step-operation buttons start flashing.

- 2 Press number button 1 to select “MOVIE”—Movie category of the PSM settings.**

The “Graphics” setting screen appears on the display.

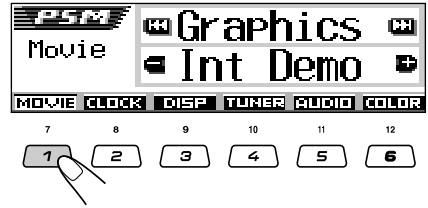

- 3 Select “Off.”**

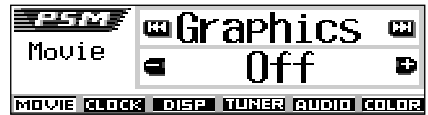
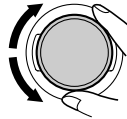

- 4 Finish the setting.**



To activate the display demonstration, repeat the same procedure and select “Int Demo” or “All Demo” in step 3.

- For more details, see “To show the graphics on the display—Graphics” on page 38.



Setting the clock

You can also set the clock system to either 24 hours or 12 hours.

1 Press and hold SEL (select) for more than 2 seconds so that one of the PSM items appears on the display. (PSM: see pages 36 and 37.)



The next-step-operation buttons start flashing.

2 Press number button 2 to select "CLOCK"—Clock category of the PSM settings.

The "Clock Hr" (hour) setting screen appears on the display.

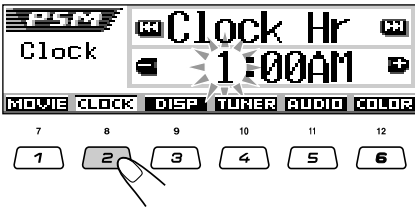

3 Adjust the hour.



4 Set the minute.

- 1 Select "Clock Min" (minute).
- 2 Adjust the minute.

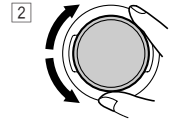
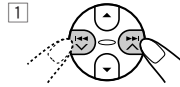

5 Set the clock system.

- 1 Select "24H/12H."
- 2 Select "24Hours" or "12Hours."

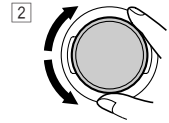
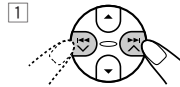

6 Finish the setting.



To check the clock time when the unit is turned off, press D DISP.



The power turns on and the clock time is shown for about 5 seconds, then the power turns off.



RADIO OPERATIONS

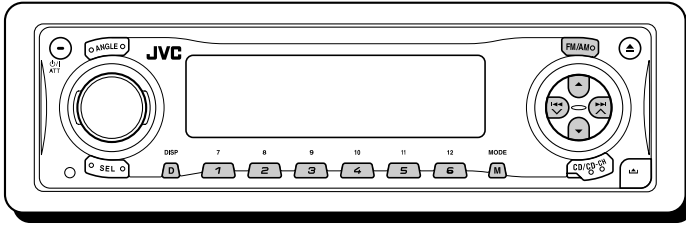

Listening to the radio

You can use either automatic searching or manual searching to tune in to a particular station.

Searching for a station automatically: Auto search

1 Select the band (FM1 – 3, AM).

 Each time you press the button, the band changes as follows:

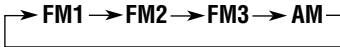

Selected band appears.



Lights up when receiving an FM stereo broadcast with sufficient signal strength.

Note:

This receiver has three FM bands (FM1, FM2, FM3). You can use any one of them to listen to an FM broadcast.

2 Start searching for a station.

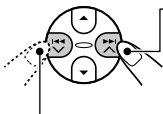

To search for stations of higher frequencies

To search for stations of lower frequencies

When a station is received, searching stops.

To stop searching before a station is received, press the same button you have pressed for searching.

Searching for a station manually: Manual search



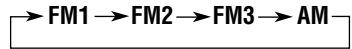

1 Select the band (FM1 – 3, AM).

 Each time you press the button, the band changes as follows:



Note:

This receiver has three FM bands (FM1, FM2, FM3). You can use any one of them to listen to an FM broadcast.

2 Press and hold   or   until "Manual Search" starts flashing on the display.

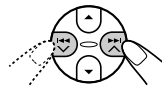

3 Tune in to a station you want while “Manual Search” is flashing.

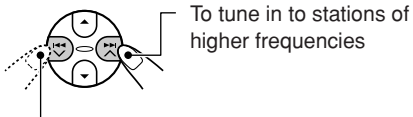

To tune in to stations of higher frequencies

To tune in to stations of lower frequencies

- If you release your finger from the button, the manual mode automatically turns off after about 5 seconds.
- If you hold down the button, the frequency keeps changing (in 50 kHz intervals for FM and 9 kHz for AM) until you release the button.

If the sound quality decreases and the stereo effect is lost while listening to an FM station

In some areas, adjacent stations may interfere with each other. If this interference occurs, this unit can automatically reduce this interference noise (the initial setting when shipped from the factory). However, in this case, the sound quality will be degraded and the stereo effect will also be lost.

If you do not want to degrade the sound quality and to lose the stereo effect, rather than to eliminate the interference noise, see “To change the FM tuner selectivity—IF Filter” on page 39.

When an FM stereo broadcast is hard to receive:

Set the FM reception mode to “Mono On.”

- 1 Press M MODE while listening to an FM stereo broadcast.



“Mode” appears on the display. The next-step-operation buttons start flashing.

- 2 Press number button 1 to select “Mono On” while “Mode” is still on the display. Each time you press the button, “Mono On” or “Mono Off” appears alternately.

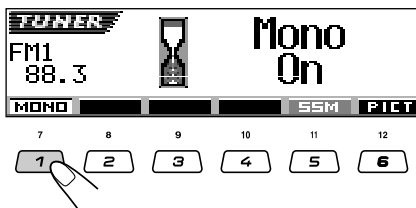

After about 5 seconds

The display returns to the source indication screen.



MONO indicator appears.

The sound you hear becomes monaural but the reception will be improved.



Storing stations in memory

You can use one of the following two methods to store broadcasting stations in memory.

- Automatic preset of FM stations: SSM (Strong-station Sequential Memory)
- Manual preset of both FM and AM stations

FM station automatic preset: SSM

You can preset 6 local FM stations in each FM band (FM1, FM2, and FM3).

1 Select the FM band (FM1 – 3) you want to store FM stations into.



Each time you press the button, the band changes as follows:

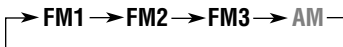

2 Start automatic preset.

- 1 Press M MODE.

MODE



“Mode” appears on the display. The next-step-operation buttons start flashing.

- 2 Press and hold number button 5 while “Mode” is still on the display.

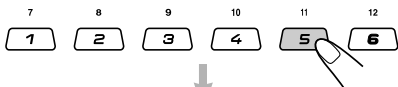

“-SSM-” appears, then disappears when automatic preset is over.

Local FM stations with the strongest signals are searched and stored automatically in the band number you have selected (FM1, FM2, or FM3). These stations are preset in the number buttons —No.1 (lowest frequency) to No.6 (highest frequency).

When automatic preset is over, the station stored in number button 1 will be automatically tuned in.

Manual preset

You can preset up to 6 stations in each band (FM1, FM2, FM3, and AM) manually.

Ex.: Storing FM station of 92.5 MHz into the preset number 1 of the FM1 band.

1 Select the band (FM1 – 3, AM) you want to store stations into (in this example, FM1).



Each time you press the button, the band changes as follows:

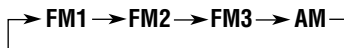

2 Tune in to a station (in this example, of 92.5 MHz).

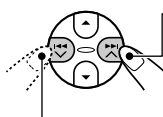

To tune in to stations of higher frequencies

To tune in to stations of lower frequencies



- 3** Press and hold the number button (in this example, 1) for more than 2 seconds.



The display pattern automatically changes to the small animation display (see page 14).

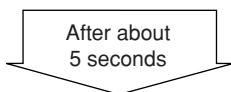

Preset number appears.



- 4** Repeat the above procedure to store other stations into other preset numbers.

Notes:

- A previously preset station is erased when a new station is stored in the same preset number.
- Preset stations are erased when the power supply to the memory circuit is interrupted (for example, during battery replacement). If this occurs, preset the stations again.

Tuning in to a preset station

You can easily tune in to a preset station. Remember that you must store stations first. If you have not stored them yet, see “Storing stations in memory” on pages 12 and 13.

Selecting a preset station directly

- 1** Select the band (FM1 – 3, AM).



Each time you press the button, the band changes as follows:

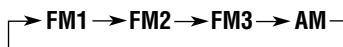

- 2** Select the number (1 – 6) for the preset station you want.

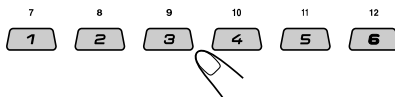

Note:

You can also use the ▲ (up) or ▼ (down) button on the unit to select the next or previous preset stations. Each time you press the ▲ (up) or ▼ (down) button, the next or previous preset station is tuned in.



Selecting a preset station using the preset station list

If you forget what stations are stored in which preset numbers, you can check the preset station list, then select your desired station.

1 Select the band (FM1 – 3, AM).



Each time you press the button, the band changes as follows:

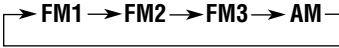

2 Press and hold ▲ (up) or ▼ (down) until the preset station list for the current band (FM1, FM2, FM3, or AM) appears on the display.

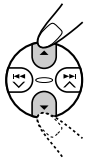

The current station will be highlighted on the display.



Notes:

- You can show the other FM band preset station lists (FM1, FM2, or FM3) by pressing ▲ (up) or ▼ (down).
- If a name has been assigned to a station (see page 43), it will be shown instead of the station frequency.

3 Select the number (1 – 6) for the preset station you want.

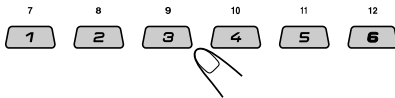

Changing the display pattern

By pressing D DISP, you can change the information shown on the display.



Each time you press the button, the display patterns change as follows:

Ex.: When selecting preset station 1 of FM1 band

Large animation display



Current sound mode (iEQ)
(see page 25)

Small animation display 1



Clock time

Small animation display 2

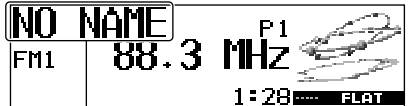

If a name has been assigned to a station it will be shown instead of "NO NAME."

Clock time display



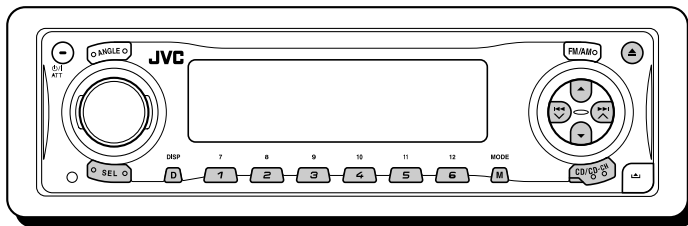

This unit has been designed to reproduce CDs, CD-Rs (Recordable), CD-RWs (Rewritable), and CD Texts.

- This unit is also compatible with MP3 and WMA discs. For details about these discs, refer to “A Guide to MP3/WMA” (separate volume).

About MP3 and WMA discs

MP3 and WMA (Windows Media® Audio) “tracks” (word “file” is not used to indicate MP3 or WMA files, “track” is used in this manual) are recorded in “folders.”

During recording, the tracks and folders can be arranged in a way similar to arranging files and folders of computer data.

“Root” is similar to the root of a tree. Every track and folder can be linked to and be accessed from the root.

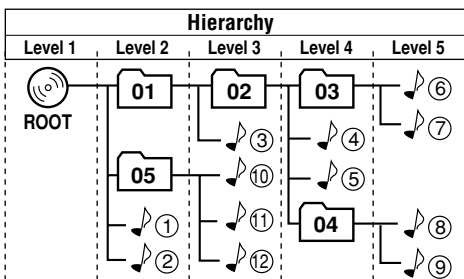

01	: Folders and their playback order
🎵 ①	: MP3/WMA tracks and their playback order

- Microsoft and Windows Media are either registered trademarks or trademarks of Microsoft Corporation in the United States and/or other countries.

Playing a disc

- 1 Open the control panel.

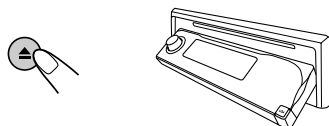

Note on One-Touch Operation:

When a disc is already in the loading slot, pressing CD/CD-CH turns on the unit and starts playback automatically.

- 2 Insert a disc into the loading slot.

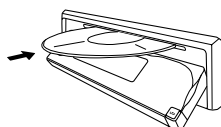

The unit draws the disc, the control panel goes back to the previous position (see page 44), and playback starts automatically.

All tracks will be played repeatedly until you stop playback.

Note:

For details on playable discs and other related information, see page 56.

About mistracking:

Mistracking may result from driving on extremely rough roads. This does not damage the unit and the disc, but will be annoying.

We recommend that you stop disc play while driving on such rough roads.



Display indications when inserting an audio CD or a CD Text:

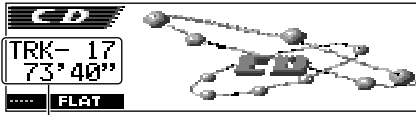

Total track number and total playing time of the inserted CD

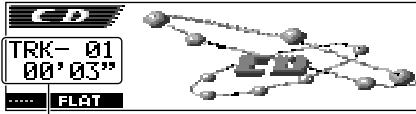

Current track and elapsed playing time

Notes:

- MP3 or WMA discs require a longer readout time. (It differs due to the complexity of the folder/track configuration.)
- The unit cannot read or play an MP3 track without the extension code <.mp3>, and a WMA track without the extension code <.wma>.

Display indications when inserting an MP3 or a WMA discs:

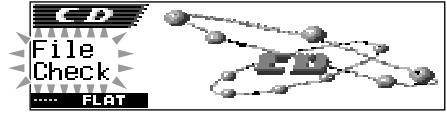

Total folder and track numbers

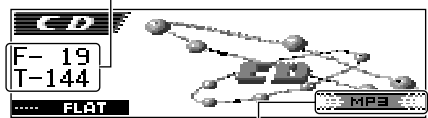

MP3 indicator*

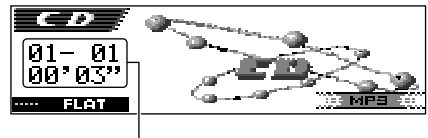

Current folder/track and elapsed playing time

- * WMA or MP3 indicator lights up depending on the first detected track.

To stop play and eject the disc

Press ▲.

Disc play stops and the control panel moves down. The disc automatically ejects from the loading slot. The source changes to the previously selected source.

- If you change the source or turn the power off, disc play also stops (without ejecting the disc). Next time you select "CD" as the source or turn the power on, disc play starts from where playback has been stopped previously.

To return the control panel to its previous position, press ▲ again.

- If you keep the loading slot fully open for about 1 minute, (beeps sound when the "Beep" setting is turned "On"—see page 39) the control panel automatically returns to its previous position.

Be careful not to get the disc or your finger caught in between the control panel and the unit.

Notes:

- If the ejected disc is not removed for about 15 seconds, the disc is automatically inserted again into the loading slot to protect it from dust. (Disc play will not start this time.)
- You can eject the disc even when the unit is turned off.



What is ImageLink?

When an MP3 or a WMA folder includes an image <jml> file edited by Image Converter (supplied in the CD-ROM), you can show the image on the display while the tracks in the folder are played back.

- While reading an image <jml> file, no sounds come out (“Image Link” is shown on the display during this period).

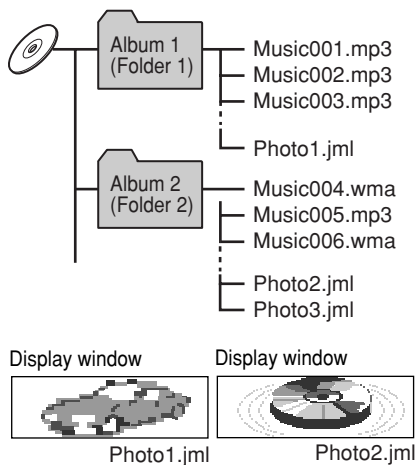

If there are more than one <jml> file in a folder, a <jml> file with younger playback order number will be shown on the display (in the above example, “Photo2.jml” will be used for Album 2).

To activate ImageLink, follow the procedure below:

- See also “Changing the general settings (PSM)” on page 36.
- 1 Press and hold SEL (select) for more than 2 seconds so that one of the PSM items appears on the display.
 - 2 Press number button 1 to select “MOVIE”—Movie category of the PSM settings. The “Graphics” setting screen appears on the display.
 - 3 Turn the control dial to select “ImageLink.”
 - 4 Press SEL (select) to finish the setting. ImageLink starts functioning when the next folder starts playing.

Note:

ImageLink will not work in the following cases:

- If no <jml> file is included in an MP3/WMA folder.
- If Intro Scan is activated.
- If the source is changed to any other than “CD,” or
- If you turn off then on the unit while “Image Link” is shown on the display.



Locating a track or a particular portion on a disc

To fast-forward or reverse the track

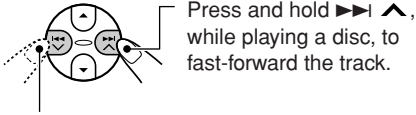

Press and hold **▶▶** **▲**, while playing a disc, to fast-forward the track.

Press and hold **◀◀** **▼**, while playing a disc, to reverse the track.

Note:

During this operation on an MP3 or WMA disc, you can only hear intermittent sounds. (The elapsed playing time also changes intermittently on the display.)

To go to the next or previous tracks

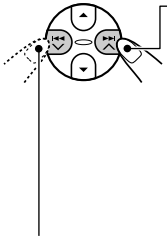

Press **▶▶** **▲** briefly, while playing a disc, to go ahead to the beginning of the next track.

Each time you press the button consecutively, the beginning of the next tracks is located and played back.

Press **◀◀** **▼** briefly, while playing a disc, to go back to the beginning of the current track. Each time you press the button consecutively, the beginning of the previous tracks is located and played back.

To go to a particular track directly (Only for CD and CD Text discs)

Press the number button corresponding to the track number to start its playback.

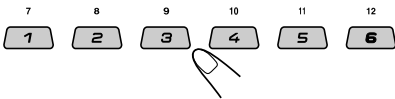

- To select a track number from 01 – 06: Press 1 (7) – 6 (12) briefly.
- To select a track number from 07 – 12: Press and hold 1 (7) – 6 (12) for more than one second.

To go to a track quickly

- 1 Press **M** MODE while playing a disc.



“Mode” appears on the display. The next-step-operation buttons start flashing.

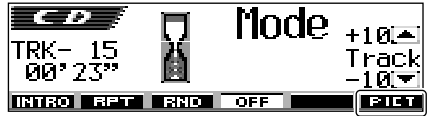

See page 30 for this function.

- 2 Press **▲** (up) or **▼** (down) while “Mode” is still on the display.

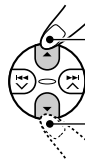

To skip 10 tracks* forwards to the last track

To skip 10 tracks* backwards to the first track

- * First time you press **▲** (up) or **▼** (down) button, the track skips to the nearest higher or lower track with a track number of multiple ten (ex. 10th, 20th, 30th). Then each time you press the button, you can skip 10 tracks (see “How to go to the desired track quickly” below).
- After the last track, the first track will be selected, and vice versa.

Note:

If the current playing disc is an MP3 or a WMA disc, tracks are skipped within the same folder.

How to go to the desired track quickly

- Ex. 1: To select track number 32 while playing track number 6



(Three times)

(Twice)

Track 6

→ 10 → 20 → 30

→ 31 → 32

- Ex. 2: To select track number 8 while playing track number 36



(Three times)

(Twice)

Track 36

→ 30 → 20 → 10

→ 9 → 8



To go to a particular folder directly (Only possible for MP3 or WMA disc)

IMPORTANT:

To directly select the folders using the number button(s), it is required that folders are assigned 2 digit numbers at the beginning of their folder names. (This can only be done during the recording of CD-Rs or CD-RWs.)

Ex.: If folder name is "01 ABC"

→ Press 1 to go to Folder 01 ABC.

If folder name is "1 ABC," pressing 1 does not work.

If folder name is "12 ABC"

→ Press and hold 6 (12) to go to Folder 12 ABC.

To skip to the next or previous folder (Only possible for MP3 or WMA disc)

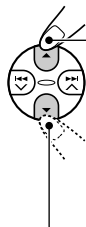

Press ▲ (up) while playing a disc to skip to the next folder.

Each time you press the button consecutively, the next folder is located and the first track in the folder starts playing.

Press ▼ (down) while playing a disc to skip back to the previous folder.

Each time you press the button consecutively, the previous folder is located and the first track in the folder starts playing.

Note:

If the folder does not contain any MP3 or WMA tracks, it is skipped.

Press the number button corresponding to the folder number to start playing the first track in the selected folder.

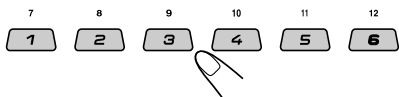

- To select a folder number from 01 – 06:
Press 1 (7) – 6 (12) briefly.
- To select a folder number from 07 – 12:
Press and hold 1 (7) – 6 (12) for more than one second.

Notes:

- If "No Music" appears on the display after you have selected a folder, it means that the folder does not contain any MP3 or WMA tracks.
- You cannot directly select a folder with a number greater than 12.

To select a particular track in a folder, press

▶▶| ▲ or |◀◀ ▼ after selecting the folder.



Selecting a folder and a track using the name lists

The following operations are only possible when playing an MP3 or a WMA disc.

You can show the folder name and track name lists on the display while playing a disc. Then, select a folder or a track you want to start playback with.

Selecting a folder and start playback

- 1 Press and hold ▲ (up) or ▼ (down) so that the folder name list of the inserted disc appears on the display.

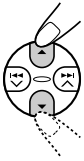

The current playing folder will be highlighted on the display.

Current folder number



Notes:

- The display can show only six names at a time. You can show the other names on the next lists by pressing ▲ (up) or ▼ (down).
- If you press ►► ▲ or ◀◀ ▼, the track name list of the current playing folder appears. Each time you press the button, the folder name list and track name list appear alternately.
- Only folders with MP3 or WMA tracks will be listed.

- 2 Select the number (1 – 6) for the folder you want to play.

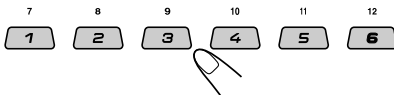

Selecting a track and start playback

- 1 Press and hold ▲ (up) or ▼ (down) so that the folder name list of the inserted disc appears on the display.

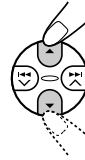

The current playing folder will be highlighted on the display.

Current folder number



- 2 Press ►► ▲ or ◀◀ ▼ to show the track name list of the current folder.

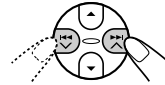

The current playing track will be highlighted on the display.

Current track number



Each time you press the button, the folder name list and track name list appear alternately.

Note:

The display can show only six names at a time. You can show the other names on the next lists by pressing ▲ (up) or ▼ (down).

- 3 Select the number (1 – 6) for the track you want to play.

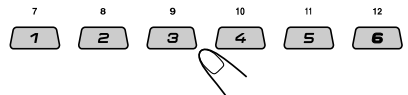



Selecting the playback modes

To play back tracks at random (Random Play)

You can play back all tracks on the disc (or a folder for MP3 and WMA discs) at random.

- 1 Press M MODE while playing a disc.



"Mode" appears on the display. The next-step-operation buttons start flashing.

- 2 Press number button 3 repeatedly while "Mode" is still on the display.

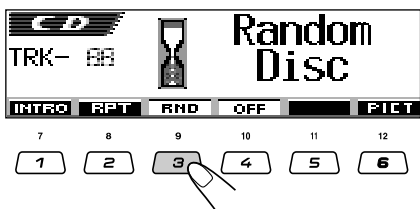

Each time you press the button, random play mode changes as follows:

For audio CD and CD Text discs:

Random Disc ↔ Random Off

For MP3 and WMA discs:



Mode	Active indicator	Plays at random
Random Folder*	RND (folder random) indicator lights up.	All tracks of the current folder, then tracks of the next folder and so on.
Random Disc	RND (disc random) indicator lights up.	All tracks on the disc.

* "Random Folder" can be used for MP3 and WMA discs only.

To cancel random play, select "Random Off" by pressing number button 3 repeatedly or press number button 4 in step 2.

To play back tracks repeatedly (Repeat Play)

You can play back the current track (or a folder for MP3 and WMA discs) repeatedly.

- 1 Press M MODE while playing a disc.



"Mode" appears on the display. The next-step-operation buttons start flashing.

- 2 Press number button 2 repeatedly while "Mode" is still on the display.

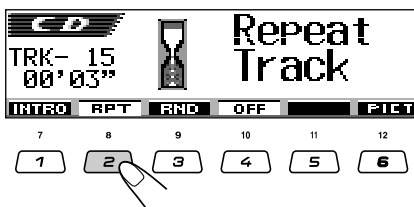

Each time you press the button, repeat play mode changes as follows:

For audio CD and CD Text discs:

Repeat Track ↔ Repeat Off

For MP3 and WMA discs:



Mode	Active indicator	Plays repeatedly
Repeat Track	RPT (track repeat) indicator lights up.	The current (or specified) track.
Repeat Folder*	RPT (folder repeat) indicator lights up.	All tracks of the current (or specified) folder of the disc.

* "Repeat Folder" can be used for MP3 and WMA discs only.

To cancel repeat play, select "Repeat Off" by pressing number button 2 repeatedly or press number button 4 in step 2.



To play back only intros (Intro Scan)

You can play back the first 15 seconds of each track sequentially.

- 1 Press M MODE while playing a disc.

MODE



“Mode” appears on the display.
The next-step-operation buttons start flashing.

- 2 Press number button 1 repeatedly while “Mode” is still on the display.

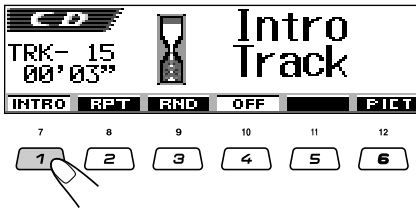

Each time you press the button, intro scan mode changes as follows:

For audio CD and CD Text discs:

Intro Track ↔ Intro Off

For MP3 and WMA discs:



Mode	Active indicator	Plays the beginnings (15 seconds) of
Intro Track	♪ INT (track intro) indicator lights up.	All tracks on the disc.
Intro Folder*	📁 INT (folder intro) indicator lights up.	The first track of every folder of the disc.

* “Intro Folder” can be used for MP3 and WMA discs only.

To cancel intro scan, select “Intro Off” by pressing number button 1 repeatedly or press number button 4 in step 2.

Prohibiting disc ejection

You can prohibit disc ejection and can lock a disc in the loading slot.

While pressing SEL (select), press and hold ▲ (eject) for more than 2 seconds.

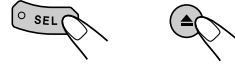

“No Eject” flashes on the display for about 5 seconds, and the disc is locked and cannot be ejected.



To cancel the prohibition and unlock the disc

While pressing SEL (select), press and hold ▲ (eject) again for more than 2 seconds.

“Eject OK” flashes on the display for about 5 seconds, and the disc is unlocked.





Changing the display pattern

By pressing D DISP, you can change the information shown on the display.



If the information cannot be shown at a time, it will scroll on the display. See also “To select the scroll mode—Scroll” on page 38.

Some characters or symbols will not be shown (will be blanked or substituted) on the display.

Each time you press the button, the display patterns change as follows:

While playing an audio CD or a CD Text disc:

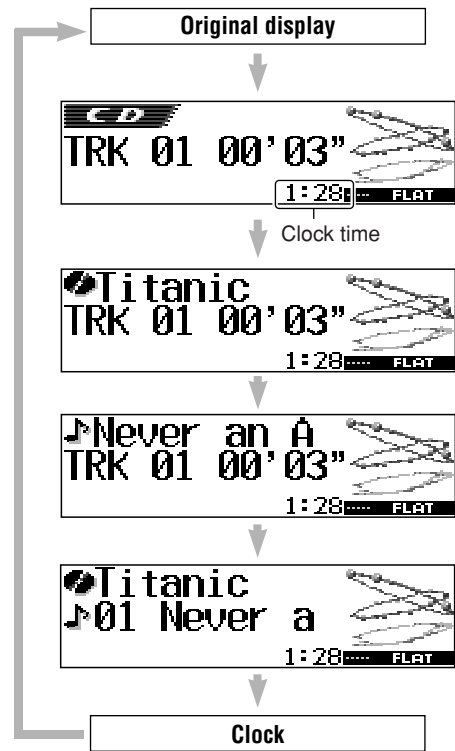

Notes:

- When the disc title/performer is shown, the (disc) indicator lights up. When the track title is shown, the (track) indicator lights up.
- If no name is assigned to the audio CD, “NO NAME” will appear. To assign a name to an audio CD, see page 43.
- If no disc title/performer or no track title is recorded for the CD Text, “NO NAME” will appear.

While playing an MP3 or a WMA disc when “Tag” is set to “Off”:

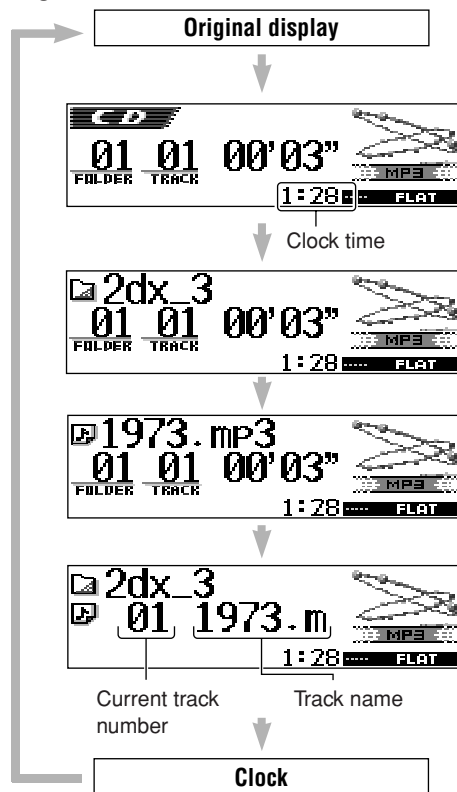

Notes:

- When the folder name is shown, the (folder) indicator lights up. When the track name is shown, the (track) indicator lights up.
- If “Tag” is set to “On” (see page 38), ID3 tag information will appear on the display if the disc has an ID3 tag.
The album name/performer with (disc) indicator appear on the display instead of the folder name; while track title with (track) indicator appear instead of the track name.



SOUND ADJUSTMENTS

Adjusting the sound

You can set the speaker output balance, subwoofer output level, and input level of each source.

- There is a time limit in doing the following procedure. If the setting is canceled before you finish, start from step 1 again.

1 Select the item you want to adjust.



The next-step-operation buttons start flashing. Each time you press the button, the adjustable items change as follows:

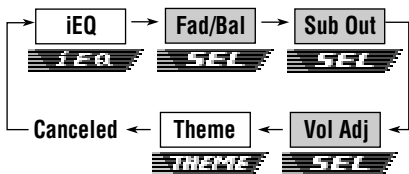

- For iEQ (sound mode) settings, see pages 25 – 27.
- For THEME (display theme) settings, see page 28.

Indication	To do:	Range
Fad	Adjust the front and rear speaker balance.	R06 (Rear only) F06 (Front only)
Bal	Adjust the left and right speaker balance.	L06 (Left only) R06 (Right only)
Sub Out	Adjust the subwoofer output level and cutoff frequency level.	00 (min.) 12 (max.) Low/Mid/High
Vol Adj	Adjust and store the input level of each source.	-12 (min.) +12 (max.)

2 Make adjustments.

- **To adjust fader and balance—Fad, Bal:** You can make these two adjustments at the same time.
 - If you are using a two-speaker system, set the fader level to “00.”

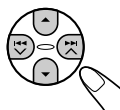

- Press ▲ (up) or ▼ (down) to adjust the fader.
- Press ►► ▲ or ◀◀ ▼ to adjust the balance.



- **To adjust subwoofer output—Sub Out:** This takes effect only when a subwoofer is connected.

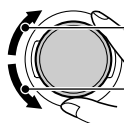

To increase the level

To decrease the level



You can also set an appropriate cutoff frequency level according to the subwoofer connected.

- Press ►► ▲ or ◀◀ ▼ to select “Low,” “Mid,” or “High.”
 - Low: Frequencies higher than 50 Hz are cut off to the subwoofer.
 - Mid: Frequencies higher than 80 Hz are cut off to the subwoofer.
 - High: Frequencies higher than 115 Hz are cut off to the subwoofer.



• **To adjust the input level of each source —Vol Adj:**

Volume adjustment level can be separately stored for each source—CD, AM, Line in, and CD changer. Before making an adjustment, select an appropriate source for which you want to make an adjustment.

Once you have adjusted it, it is memorized, and you will not need to adjust the volume level each time you change the source.

Adjust the input level to match it to the FM sound level.

- You cannot make an adjustment if the source is FM. "FIX" will appear.

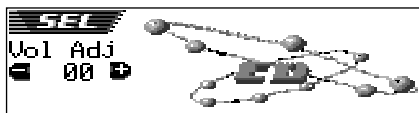
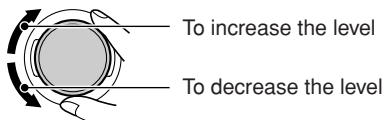

Selecting preset sound modes (iEQ: intelligent equalizer)

You can select a preset sound mode (iEQ: intelligent equalizer) suitable to the music genre.

- There is a time limit in doing the following procedure. If the setting is canceled before you finish, start from step 1 again.

Available sound modes:

- FLAT** (No sound mode is applied)
- H.ROCK** (Hard Rock)
- R & B** (Rhythm and Blues)
- POP** (Popular music)
- JAZZ** (Jazz music)
- DANCE** (Dance music)
- Country** (Country music)
- REGGAE** (Reggae)
- CLASSIC** (Classical music)
- USER 1, USER 2, USER 3**

1 Press SEL (select) once.



The last selected sound mode is called up.
The next-step-operation buttons start flashing.

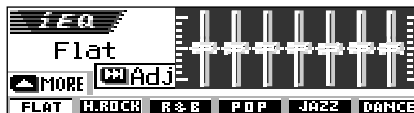

Ex.: If you have selected "Flat" previously

Each time you press the button, the adjustable items change as follows:

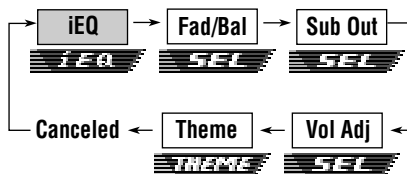

- For SEL (basic sound) settings, see pages 24 – 25.
- For THEME (display theme) settings, see page 28.

CONTINUED ON THE NEXT PAGE

2 Press the number button to select the sound mode you want.

- This unit has two sound mode selection screens. To move to the other screen, press ▲ (up) or ▼ (down).

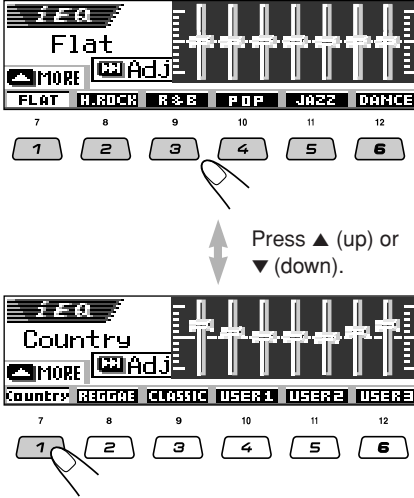

To cancel the sound mode, select “FLAT” in step 2.

Notes:

- You can adjust the preset sound modes temporarily. However, your temporary adjustments will be reset when you select another sound mode.
- For details about the preset settings of each sound mode, see table below.

To exit from the sound mode selection screen, press SEL (select) repeatedly or wait for about 5 seconds.

Sound modes (preset frequency level settings)

The list below shows the preset frequency level settings for each sound mode.

Sound Mode	Preset equalizing values						
	60 Hz	150 Hz	400 Hz	1 kHz	2.4 kHz	6 kHz	12 kHz
Flat	00	00	00	00	00	00	00
Hard Rock	+03	+03	+01	00	00	+02	+01
R & B	+03	+02	+02	00	+01	+01	+03
Pop	00	+02	00	00	+01	+01	+02
Jazz	+03	+02	+01	+01	+01	+03	+02
Dance Music	+04	+02	00	-02	-01	+01	+01
Country	+02	+01	00	00	00	+01	+02
Reggae	+03	00	00	+01	+02	+02	+03
Classic	+02	+03	+01	00	00	+02	00
User 1	00	00	00	00	00	00	00
User 2	00	00	00	00	00	00	00
User 3	00	00	00	00	00	00	00

Storing your own sound modes

You can adjust the sound modes to your preference and store your own adjustments in memory (USER 1, USER 2, and USER 3).

- There is a time limit in doing the following procedure. If the setting is canceled before you finish, start from step 1 again.

1 Press SEL (select) once.



The last selected sound mode is called up. The next-step-operation buttons start flashing.

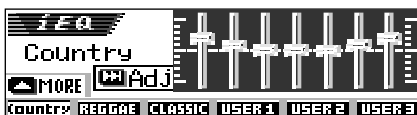

Ex.: If you have selected "Country" previously

2 Select the sound mode you want to adjust.

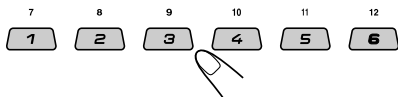

- This unit has two sound mode selection screens. To move to the other screen, press ▲ (up) or ▼ (down).

3 Enter the sound adjustment mode.

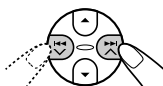

The following sound mode adjustment screen appears on the display.

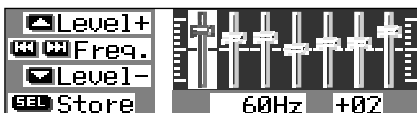

4 Make adjustments as you like.

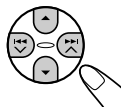

- 1) Press ►►| ▲ or |◄◄ ▼ to select the frequency band—60Hz, 150Hz, 400Hz, 1kHz, 2.4kHz, 6kHz, 12kHz.
- 2) Press ▲ (up) or ▼ (down) to adjust the level of the selected band within the range of -05 to +05.
- 3) Repeat steps 1) and 2) to adjust the other frequency bands.

5 Store the adjustment you made.



The confirmation message appears—whether you want to store the adjustment.

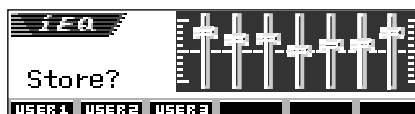

If you want to cancel the adjustments, press D DISP.

6 Select one of the user sound modes (USER 1, USER 2, or USER 3) you want to store into.

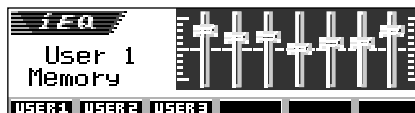
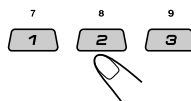

Ex.: When you select "User 1"



Selecting the display theme

You can select the theme of the display during playback.

- There is a time limit in doing the following procedure. If the setting is canceled before you finish, start from step 1 again.

1 Select "THEME."



Each time you press the button, the adjustable items change as follows:

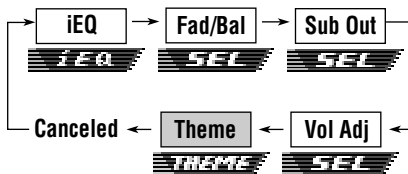

The last selected theme appears on the display.

The next-step-operation button starts flashing.

- For SEL (basic sound) settings, see pages 24 – 25.
- For iEQ (sound mode) settings, see pages 25 – 27.

2 Select the display theme you want.



As you turn the control dial, the themes change as follows:

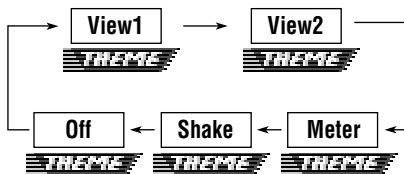

Note:

View 1 and 2 have positive pattern display and negative pattern display (see right column). Either positive or negative pattern display is automatically selected depending on the "LCD Type" setting (see page 38).

View 1:

A scenery display appears.

- Positive pattern display:



- Negative pattern display:



View 2:

A scenery display appears.

- Positive pattern display:



- Negative pattern display:

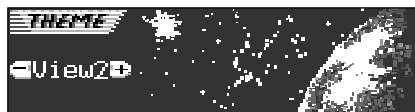

Meter:

The left and right audio level meters appear.

- If the small animation display is selected, one audio level meter can be shown.



Shake:

The speaker on the display vibrates as input audio level changes.



Off:

Cancels the display theme.

With the supplied Image Converter CD-ROM, you can edit your own favorite pictures and use them as the opening screen, ending screen, and graphic screen while playing a source.



What is Image Converter?

Image Converter is a JVC's original software to produce customize images to be shown on your JVC Car Audio.

Here is a basic procedure to make a CD-R including still images (pictures) and animations (movies) using Image Converter

In this manual, we only explain how to export the files (still images and animations) into the built-in memory of this unit—step 5 below.

- For the other processes (from steps 1 to 4 below), refer to Image Converter's Operation Guide (PDF files included in the "Manual" folder of the supplied CD-ROM).

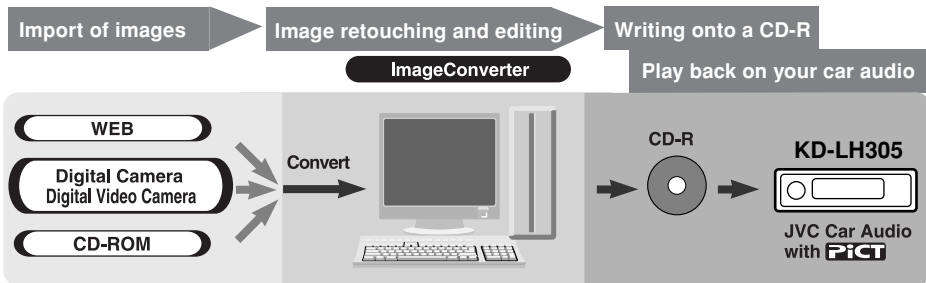

- 1 Install / Start the program**
 Install Image Converter on your PC.
- 2 Import the images**
 Import the source images from the Image Converter CD-ROM or from other equipment like a digital camera or a digital video camera.
- 3 Retouch and edit the images**
 Retouch the images like trimming or adjusting color, editing the animation effect, and adding the texts.
- 4 Write your images onto a CD-R**
 Write the animations or the still images you made with Image Converter using your CD-R writing software.
 You have to write the images you made onto a CD-R to enjoy the images on your Car Audio.
 - To write data onto a CD-R, refer also to the instruction of your CD-R writing software.
- 5 Enjoy the animations or the still images you made on your Car Audio**
 Export the images to your JVC Car Audio from the CD-R you made.

Downloading images and animations

Before starting the following procedure, prepare a CD-R including still images (pictures) and animations (movies).

- The supplied Image Converter CD-ROM includes sample images and animations, so you can use this disc as your first trial.

IMPORTANT:

- Still images (pictures) should have <jml>, and animations (movies) should have <jma> as their extension code in their file names.
- Downloading a file can be done only while selecting "CD" as the source; on the other hand, deleting a file can be done while selecting any source.
- Before you download or erase the files, observe the following:
 - Do not download a file while driving.
 - Do not turn off the ignition key of the car while downloading or erasing a file*.
 - Do not detach the control panel while downloading or erasing a file*.
- * If you do it, the file download and erasure will not be done correctly. In this case, perform the same procedure again.
- If you have already downloaded an animation for "Opening," "Ending," or "Movie," downloading a new animation deletes the previously stored animation.
- It takes a long time for the unit to download an animation.
 - About 6 to 7 seconds for a still image (one frame).
 - About 3 to 4 minutes for an animation of 30 frames.
 - About 10 minutes for an animation of 90 frames.

1 Open the control panel.

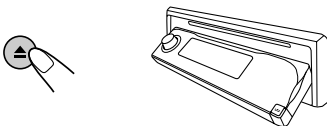

2 Insert a CD-R with the files (images and animations you made with Image Converter) into the loading slot.

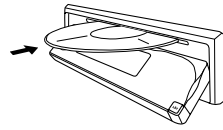

The unit draws the disc, the control panel goes back to the previous position (see page 44).

- If the disc includes playable audio files such as MP3 tracks, playback starts automatically.

3 Press M MODE after the disc is detected.



"Mode" appears on the display. The next-step-operation buttons start flashing.

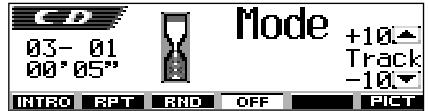

4 Press number button 6 to show the download selection screen.



5 Select (highlight) one of the listed items for which you want to download a file.

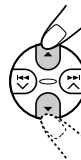

- **Opening** : Opening screen
To download an animation to be shown after the unit is turned on. (You can store only one animation consisting of a maximum of 30 frames.)
- **Ending** : Ending screen
To download an animation to be shown before the unit is turned off. (You can store only one animation consisting of a maximum of 30 frames.)
- **Picture** : Graphic screen*
To download a still image to be shown if no operation is done for about 20 seconds. (You can store 90 frames of still images—one frame each.)
- **Movie** : Graphic screen*
To download an animation to be shown if no operation is done for about 20 seconds. (You can store only one animation consisting of a maximum of 90 frames.)

* *Graphic screen will appear only if the "Graphics" setting is set to one of the following—"UserMovie," "UserSlide," or "UserPict." (see page 38).*

If you want to cancel the procedure, press number button 5, the download selection screen goes off.

6 Show the name list of the folder included in the inserted CD-R.

7 "File Check..." appears for a while, then the folder list* appears.

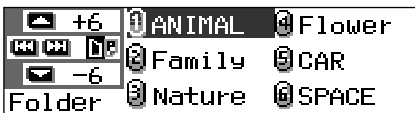

The currently selected folder will be highlighted on the display.

* You can assign your own names when editing a CD-R.

Notes:

- On this list, the folders including the target files—<jml> files for "Picture" and <jma> files for the others—are shown.
- The display can show only six names at a time. You can show the other names on the next lists by pressing ▲ (up) or ▼ (down).
- If a disc inserted does not include any <jml> and <jma> files, beeps sound and you cannot go to the next step.

If you want to cancel the procedure, press D DISP.

7 Select (highlight) a folder in which a file you want is included.

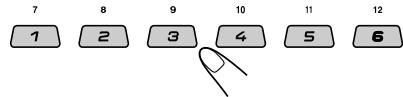

8 Show the name list of the files included in the selected folder.

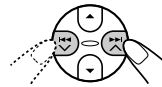

Each time you press the button, the lists on the display changes as follows:

Folder name list ↔ **File name list**

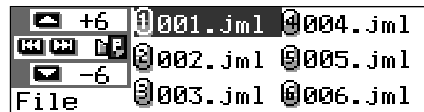

Ex.: When you have selected "Picture" in step 5

Note:

The display can show only six names at a time. You can show the other names on the next lists by pressing ▲ (up) or ▼ (down).

9 Select (highlight) a file you want to download.

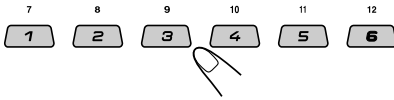

The file name appears, and the unit will ask you "Download OK?"

10 If it is OK, press number button 1 to start downloading.



Downloading starts, and "Downloading..." appears on the display. If it is over, the file name list appears again.

If it is not OK, press number button 5, the file selection screen appears again. Repeat from step 8 again.

11 Repeat steps 8 to 10 if you are downloading files for "Picture" and want to store more files.

12 Finish the download procedure.



To download a file for another item listed on the download selection screen, repeat from step 3 again.

Notes:

- If you try to store the 91st image for picture screen, "Picture Full" appears and you cannot start downloading. In this case, delete unwanted files before downloading.
- If the total frame number of the downloaded animations exceeds the following number, the exceeding frames are ignored.
 - For opening and ending screens: 30 frames
 - For movie screen: 90 frames

Deleting unwanted files

- When "BACK" is shown on the display above number button 5, you can go back to the previous screen by pressing number button 5.

To delete all the stored files at a time

1 Press M MODE while playing any source.



"Mode" appears on the display. The next-step-operation buttons start flashing.

2 Press number button 6 to show the download selection screen.



3 Press ▲ (up) or ▼ (down) to select (highlight) all the listed items.

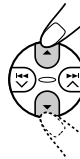

4 Press number button 4.



The unit asks you "All File Delete OK?"

5 Press number button 4 again.



"Now Deleting..." appears while erasing the files. When erasure is over, the download selection screen appears again.

6 Press number button 5 to resume the source indication screen.



To delete the files stored for “Opening,” “Ending,” “Picture (all stored images at a time),” and “Movie”

- 1 Press M MODE while playing any source.



“Mode” appears on the display. The next-step-operation buttons start flashing.

- 2 Press number button 6 to show the download selection screen.



- 3 Press ▲ (up) or ▼ (down) to select (highlight) one of the listed items.



Appears when “Picture” is selected (highlighted)

- 4 To delete the file stored in “Opening,” “Ending,” and “Movie,” press number button 3.



The file name of the previously stored animation appears, and the unit asks you “Delete OK?”

To delete all the files stored in “Picture” at a time, press number button 4.



The unit asks you “All Picture Delete OK?”

- 5 To delete the file stored in “Opening,” “Ending,” and “Movie,” press number button 3 again.



To delete all the files stored in “Picture” at a time, press number button 4 again.



“Now Deleting...” appears while erasing all the stored files. When erasure is over, the download selection screen appears again.

- 6 Press number button 5 to resume the source indication screen.



To delete the stored files for “Picture” (one by one)

- 1 Press M MODE while playing any source.



“Mode” appears on the display. The next-step-operation buttons start flashing.

- 2 Press number button 6 to show the download selection screen.



- 3 Press ▲ (up) or ▼ (down) to select (highlight) “Picture.”



- 4 Press number button 3.



The unit shows the name list of the stored files.

Note:

The display can show only six names at a time. You can show the other names by pressing ▲ (up) or ▼ (down) repeatedly.

- 5 Press the number buttons for the file you want to delete.

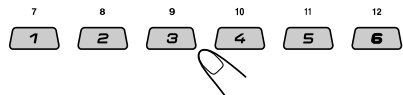

Selected file name appears, and the unit asks you “Delete OK?”

6 Press number button 3 to start erasure.



"Now Deleting..." appears while erasing the selected file. When erasure is over, the name list of the stored file appears again.

7 To delete more files, repeat from steps 5 and 6.

8 Press D DISP to resume the source indication screen.



Activating the downloaded images and animations

Activating the animations stored for opening and ending screens

After the unit turns on or before the unit turns off, you can see preset animations on the display. These are called opening screen and ending screen. You can use your own edited animations for these opening and ending screens.

- Before performing the following procedure, make sure that "KeyIn CFM" is set to "On"; otherwise, the animations may not be shown. (See page 38.)
- If no animation is stored in "Opening" and "Ending," "Opening" and "Ending" cannot be selected as a PSM item.

1 Press and hold SEL (select) for more than 2 seconds so that one of the PSM items appears on the display. (PSM: see pages 36 and 37.)



2 Press number button 1 to select "MOVIE"—Movie category of the PSM settings.

The "Graphics" setting screen appears on the display.

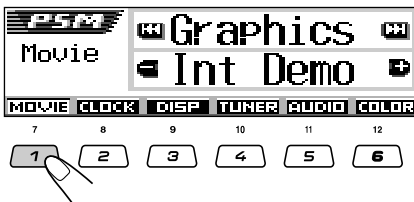

3 Select "Opening" (opening screen setting) or "Ending" (ending screen setting).

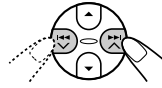

Ex.: When you select "Opening"

4 Select "User."

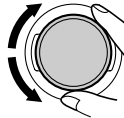

- Default: Factory-preset animation is used.
- User: Your own edited animation is used.

5 Finish the setting.



Activating the graphic screen using either picture or movie

Using this setting, you can change the graphic displays. These graphic screen appears if no operation is done for about 20 seconds.

- If no image is stored in "Picture," or no animation in "Movie," "UserPict.," "UserMovie," and "UserSlide" cannot be selected as a PSM item.

1 Press and hold SEL (select) for more than 2 seconds so that one of the PSM items appears on the display. (PSM: see pages 36 and 37.)



2 Press number button 1 to select “MOVIE”—Movie category of the PSM settings.

The “Graphics” setting screen appears on the display.

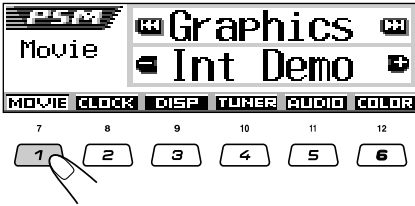

3 Select “UserMovie,” “UserSlide,” or “UserPict.”

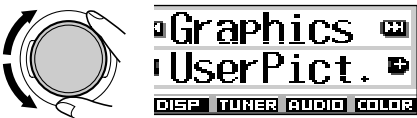

Ex.: When you select “UserPict.”

- UserMovie: Your edited animation stored in “Movie” is activated as your graphic screen.
- UserSlide: Your edited still images stored in “Picture” are activated and shown in sequence as your graphic screen.
- UserPict.: One of your edited still image stored in “Picture” is activated as your graphic screen. Select one of the stored images (see the next column).

4 Finish the setting.



To cancel all graphic displays, select “Off” in step 3.

Note:

- For the “Graphics” setting, you can also select “All Demo,” “Int Demo,” and “ImageLink.”
- See pages 8 and 38 for “All Demo” and “Int Demo.”
- See pages 17 and 38 for “ImageLink.”

Selecting a still image for graphic display—User Picture

You cannot select “UserPict.” as a PSM item in the following cases:

- If no image is stored in “Picture,” or
- “UserPict.” is not selected for the “Graphics” setting (see the left column).

1 Press and hold SEL (select) for more than 2 seconds so that one of the PSM items appears on the display. (PSM: see pages 36 and 37.)



2 Press number button 1 to select “MOVIE”—Movie category of the PSM settings.

The “Graphics” setting screen appears on the display.

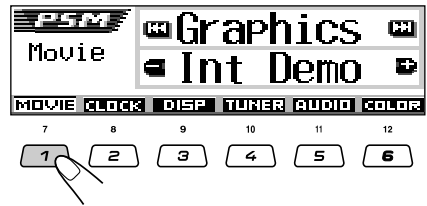

3 Select “UserPict.”

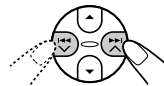

File name of the current selected image also appears.



4 Select a file you want.



5 Finish the setting.





OTHER MAIN FUNCTIONS

Changing the general settings (PSM)

You can change the items listed on the table below and on page 37 by using the PSM (Preferred Setting Mode) control.

- The PSM items are grouped into six categories—MOVIE, CLOCK, DISP (display), TUNER, AUDIO, and COLOR.

Basic Procedure

- 1 Press and hold SEL (select) for more than 2 seconds so that one of the PSM items appears on the display. (See below and page 37.)**



The next-step-operation buttons start flashing.

- 2 Press number button to select one of the PSM categories.**

The first-listed item in the selected category appears.

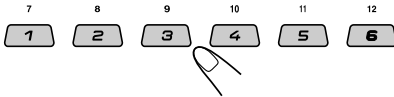

- 3 Select the PSM item you want to adjust.**

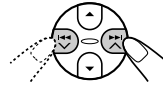

- By pressing **▶▶** **▲** or **◀◀** **▼** repeatedly, you can also move to another category.

- 4 Adjust the PSM item selected.**

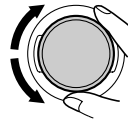

- 5 Repeat steps 2 to 4 to adjust the other PSM items if necessary.**

- 6 Finish the setting.**



Preferred Setting Mode (PSM) items

The PSM items are grouped into six categories—MOVIE, CLOCK, DISP (display), TUNER, AUDIO, and COLOR.

Indications		Selectable values/items		Factory-preset settings	See page	
MOVIE	Graphics	Movie demonstration	See page 38 for details		Int Demo	8, 17, 38
	KeyIn CFM	Key-in confirmation	On	Off	On	38
	Opening*1	Opening animation	Default	User	Default	34
	Ending*1	Ending animation	Default	User	Default	34
	UserPict.*2	User Picture	From the stored files		First stored	35

*1 Displayed only after a downloadable file is stored in memory.

*2 Displayed only after a downloadable file is stored in memory and while selecting "UserPict." for "Graphics."



		Indications	Selectable values/items		Factory-preset settings	See page
CLOCK	Clock Hr	Hour adjustment	1 – 12 (0 – 23)		1 (1:00AM)	9
	Clock Min	Minute adjustment	00 – 59		00 (1:00AM)	9
	24H/12H	24 hours or 12 hours	12Hours	24Hours	12Hours	9
DISP (display)	Scroll	Scroll mode	Once ↵	↔ Auto Off ↶	Once	38
	Dimmer	Dimmer mode	Auto ↕	↔ Off ↕ On	Auto	40
	From– To* ³	Dimmer time setting	Any time – Any time		6PM – 7AM	40
	Contrast	Contrast	1 – 10		5	38
	LCD Type	Display type	Auto ↵	↔ Positive Negative ↶	Auto	38
	Font Type	Font type	1	2	1	38
	Tag	Tag display	Off	On	On	38
TUNER	IF Filter	Intermediate frequency filter	Wide	Auto	Auto	39
AUDIO	Beep	Key-touch tone	Off	On	On	39
	Ext Input ⁴	External component	Changer	Line In	Changer	39
	Telephone	Telephone muting	Off ↵	↔ Muting1 Muting2 ↶	Off	39
	Amp.Gain	Amplifier gain control	HighPower	LowPower	HighPower	39
COLOR	All SRC	Selected source	See page 41 for details		Every	41
	User	User color selection	Day	Night	Day	42
	R	Red	00 – 11		Day: 07/Night: 05	42
	G	Green	00 – 11		Day: 07/Night: 05	42
	B	Blue	00 – 11		Day: 07/Night: 05	42
	SlotLight	Slot light	On	Off	On	39

^{*3} Displayed only when “Dimmer” is set to “Time Set.”

^{*4} Not displayed when the current source is “CD-CH” or “LINE-IN.”



To show the graphics on the display —Graphics

You can change the graphics shown on the display. These graphics appear if no operation is done for about 20 seconds (except for “ImageLink”).

- **Int Demo:** Display demonstration (animation) and playback source indication appears alternately (see page 8).
- **All Demo:** Display demonstration (animation) appears (see page 8).
- **UserMovie:** Your edited animation appears (see pages 34 and 35).
- **UserSlide:** Your edited still images appears in sequence (see pages 34 and 35).
- **UserPict.:** One of your edited still image appears (see pages 34 and 35).
- **ImageLink:** To show a still image while playing back an MP3/WMA tracks (see page 17).
- **Off:** Cancels all graphic display above.

Note:

You can select “UserMovie,” “UserSlide,” and “UserPict.” only after downloading the appropriate files in memory. (See page 30.)

To turn the source animation on the display on or off—KeyIn CFM

When changing the source, the display shows the source animation. You can turn on or off the source animation on the display.

- **On:** Turns on the source animation.
- **Off:** Cancels the source animation.

To select the scroll mode—Scroll

You can select the scroll mode for the disc information (when the entire text cannot be shown at once).

- **Once:** Scrolls only once.
- **Auto:** Repeats the scroll (in 5-second intervals).
- **Off:** Cancels scroll mode.

Note:

Even if the scroll mode is set to “Off,” you can scroll the display by pressing **D DISP** for more than one second.

To adjust the display contrast level —Contrast

Adjust the display contrast (1 – 10) to make the display indications clear and legible.

To select the display illumination pattern —LCD Type

You can select the display illumination patterns according to your preference.

- **Auto:** Positive pattern will be selected during the day time (depending on the “Dimmer” setting); on the other hand, negative pattern will be used during the night time (depending on the “Dimmer” setting).
- **Positive:** Positive (normal) pattern of the display.
- **Negative:** Negative pattern of the display.

To select the font on the display —Font Type

You can change the font types used on the display. Select either “1” or “2” according to your preference.

To turn the tag display on or off—Tag

An MP3/WMA track can contain track information called “ID3 Tag” where its album name, performer, track title, etc. are recorded. There are two versions—ID3v1 (ID3 Tag version 1) and ID3v2 (ID3 Tag version 2). If both ID3v1 and ID3v2 are recorded on a disc, ID3v2 information will be shown.

- **On:** Turns on the ID3 tag display while playing MP3/WMA tracks.
 - If an MP3/WMA track does not have ID3 tags, folder name and track name appear.
- **Off:** Turns off the ID3 tag display while playing MP3/WMA tracks. (Only the folder name and track name can be shown.)



To change the FM tuner selectivity —IF Filter

In some areas, adjacent stations may interfere with each other. If this interference occurs, noise may be heard.

- **Auto:** When this type of interference occurs, this unit automatically increases the tuner selectivity so that interference noise will be reduced. (But the stereo effect will also be lost.)
- **Wide:** Subject to the interference from adjacent stations, but sound quality will not be degraded and the stereo effect will not be lost.

To turn the key-touch tone on or off—Beep

You can deactivate the key-touch tone if you do not want it to beep each time you press a button.

- **On:** Activates the key-touch tone.
- **Off:** Deactivates the key-touch tone.

To select the external component to use —Ext Input

You can connect the external component to the CD changer jack on the rear using the Line Input Adapter KS-U57 (not supplied).

To use the external component as the playback source through this unit, you need to select which component—CD changer or external component—to use.

- **CHANGER:** To use the CD changer.
- **LINE IN:** To use the external component other than CD changer.

Note:

For connecting the Line Input Adapter KS-U57 and the external component, refer to the Installation/Connection Manual (separate volume).

To select the telephone muting—Telephone

This mode is used when a cellular phone system is connected. Depending on the phone system used, select either “Muting1” or “Muting2,” whichever mutes the sounds from this unit.

- **Muting1:** Selects this if this setting can mute the sounds.
- **Muting2:** Selects this if this setting can mute the sounds.
- **Off:** Cancels the telephone muting.

Note:

With the CD or CD changer selected as the source, playback pauses during telephone muting.

To select the amplifier gain control —Amp.Gain

You can change the maximum volume level of this unit. When the maximum power of the speakers is less than 50 W, select “LowPower” to prevent them from being damaged.

- **LowPower:** You can adjust the volume level from “Volume 00” to “Volume 30.”

Note:

If you change the setting from “HighPower” to “LowPower” while listening at a volume level more than 30, the unit automatically changes the volume level to “Volume 30.”

- **HighPower:** You can adjust the volume level from “Volume 00” to “Volume 50.”

To turn the slot light on or off—SlotLight

You can turn off the slot light if you do not want the illumination each time you insert/eject the disc or when you change the control panel angle.

- **On:** Activates the illumination.
- **Off:** Deactivates the illumination.



Selecting the dimmer mode

You can dim the display at night automatically or as you set the timer.

Note:

Auto Dimmer equipped with this unit may not work correctly on some vehicles, particularly on those having a control dial for dimming. In this case, select any other than "Auto."

1 Press and hold SEL (select) for more than 2 seconds so that one of the PSM items appears on the display. (See pages 36 and 37.)



The next-step-operation buttons start flashing.

2 Press number button 3 to select "DISP"—Display category of the PSM settings.

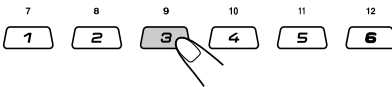

3 Press >>> ^ or <<< v to select "Dimmer."

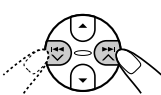

4 Set the dimmer mode as you like.

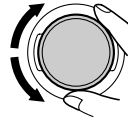

- Auto: Activates Auto Dimmer. When you turn on the car head lights, the display automatically dims.
- Off: Cancels Auto Dimmer.
- On: Always dims the display.
- Time Set: Used to set the timer for the dimmer mode.

Note:

Selecting "Auto" or "Time Set" may change the display pattern to the "Negative" or "Positive" pattern if "LCD Type" is set to "Auto."

- If you select "Time Set," go to the following steps to set the timer.
- If you select any other than "Time Set," go to step 7 to finish the setting.

5 Select "From-To" to set the timer for the dimmer mode.

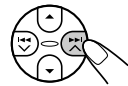

6 Set the timer.

- 1 Turn the control dial to select the start time.
- 2 Press >>> ^ once.
- 3 Turn the control dial to select the end time.

7 Finish the setting.





Changing the display color

You can set the display color using the PSM control. You can select your favorite color for each source (or for all sources).

You can also create your own colors, and set them as the display color.

Setting the desired color for each source

Once you have set the color for each source (or for all sources), the display illuminates in the selected color when the source is selected.

- 1 Press and hold SEL (select) for more than 2 seconds so that one of the PSM items appears on the display.** (See pages 36 and 37.)



The next-step-operation buttons start flashing.

- 2 Press number button 6 to select "COLOR"—Color category of the PSM settings.**

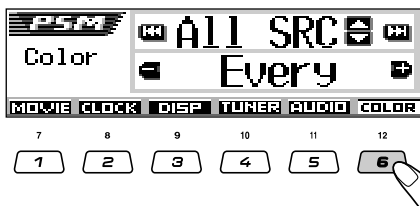

- 3 Select the source that you want to set the display color for.**

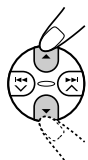

Each time you press these buttons, the source change as follows:



* When you select "All SRC," you can use the same color for all the sources.

- 4 Select the display color.**



As you turn the control dial, the colors change as follows:

Every*1 ↔ Aqua ↔ Sky ↔ Sea ↔
 Leaves ↔ Grass ↔ Apple ↔ Rose ↔
 Amber ↔ Honey ↔ Violet ↔ Grape ↔
 Pale ↔ User*2 ↔ (back to the beginning)

*1 When you select "Every," the color changes every 2 seconds (changing to every color listed above except "User").

*2 When you select "User," the user-edited colors—"Day" and "Night" will be applied. (See page 42.)

- 5 Repeat steps 3 and 4 to select the color for each source (except when selecting "All SRC" in step 3).**

- 6 Finish the setting.**





Creating your own color—User

You can create your own colors—“Day” and “Night,” and select them as the display color for any desired source.

- Day: Can be used as your user color during the day time*.
- Night: Can be used as your user color during the night time*.

* Depends on the “Dimmer” setting.

- 1 Press and hold SEL (select) for more than 2 seconds so that one of the PSM items appears on the display. (See pages 36 and 37.)



The next-step-operation buttons start flashing.

- 2 Press number button 6 to select “COLOR”—Color category of the PSM settings.

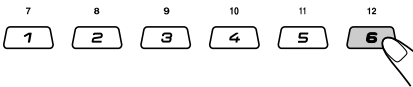

- 3 Select “User” as a color.



The user color will be applied to the currently selected source (the one shown on the upper portion of the display. In this example “All SRC”).

To select which source to apply your user color to, select the target source first by pressing ▲ (up) or ▼ (down), before selecting “User” in this step.

- 4 Select the user color adjustment screen.

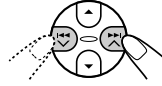

One of the user color adjustment screens appears. “User Day” or “User Night” is shown on the left side of the display.

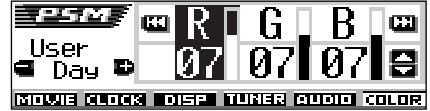

- 5 Select “Day” or “Night” which you want to make an adjustment for.

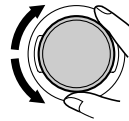

- 6 Adjust the selected user color.

- 1) Press ►►| ▲ or ◀◀| ▼ to select one of three primary colors—“R” (red), “G” (green), and “B” (blue).

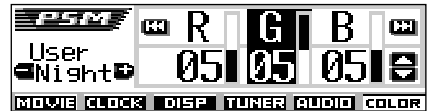

- 2) Press ▲ (up) or ▼ (down) to adjust the selected primary color.

You can adjust within the range of 00 to 11.

- 3) Repeat steps 1) and 2) to adjust the other primary colors.

- 7 Repeat steps 5 and 6 to adjust the other user colors—“Day” or “Night.”

- 8 Finish the setting.





Assigning names to the sources

You can assign names to station frequencies, CDs (both in this unit and in the CD changer), and the external component.

After assigning a name, it will appear on the display when you select the source.

Sources	Maximum number of characters
Station frequencies	Up to 10 characters (up to 30 station frequencies including both FM and AM)
CDs*	Up to 32 characters (up to 40 discs)
External component	Up to 8 characters

* You cannot assign a name to a CD Text or an MP3/WMA disc.

1 Select a source you want to assign a name to.



When you select a source, the power automatically comes on.

2 While pressing D DISP, press and hold SEL (select) for more than 2 seconds.

The next-step-operation buttons start flashing.

DISP



Ex.: When you select CD as the source

3 Select the character set you want while the first character position is flashing.

DISP



Each time you press the button, the character set changes as follows:

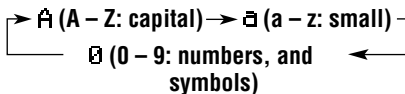

4 Select a character.



• About the available characters, see page 55.

5 Move the cursor to the next (or previous) character position.

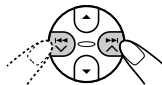

6 Repeat steps 3 to 5 until you finish entering the name.

7 Finish the procedure while the last selected character is flashing.



To erase the input characters

To erase all the characters at a time, press and hold D DISP for more than 1 second as described in the procedure above.

Notes:

- When you try to assign a name to a 41st disc or to a 31st station frequency, "Name Full" appears and you cannot enter the text entry mode. In this case, delete unwanted names before assignment.
- When the CD changer is connected, you can assign names to CDs in the CD changer. These names can also be shown on the display if you insert the CDs in this unit.



Changing the control panel angle

You can change the angle of the control panel to four positions.

Press **ANGLE** repeatedly to adjust the angle of the control panel to the position you want.



CAUTION:

NEVER insert your finger in between the control panel and the unit, as it may get caught or hurt.

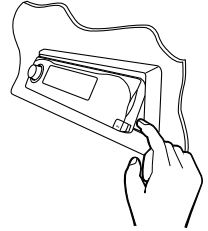

The control panel angles changes as follows:

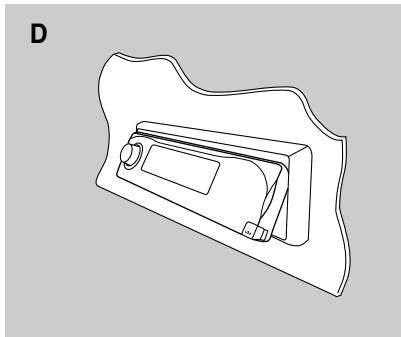
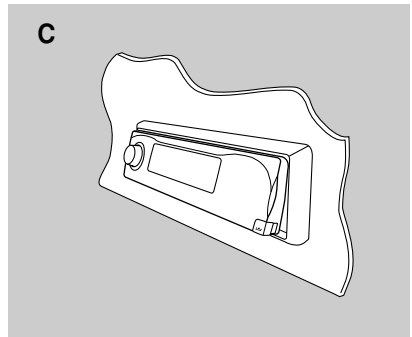
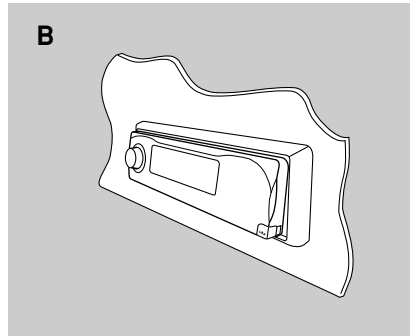
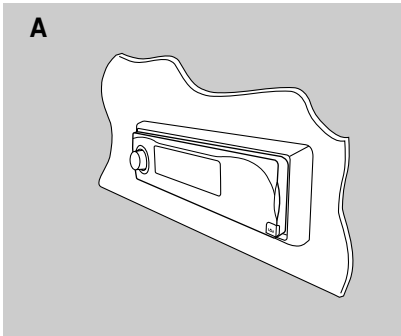

Note:

If you turn the power off, the control panel automatically returns to the closed position. Next time you turn on the power, the control panel moves to its previous position.



Detaching the control panel

You can detach the control panel when leaving the car.

When detaching or attaching the control panel, be careful not to damage the connectors on the back of the control panel and on the panel holder.

Detaching the control panel

Before detaching the control panel, be sure to turn off the power.

1 Unlock the control panel.

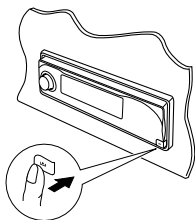

2 Lift and pull the control panel out of the unit.

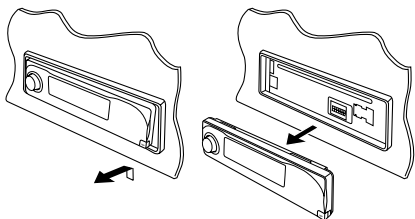

3 Put the detached control panel into the provided case.

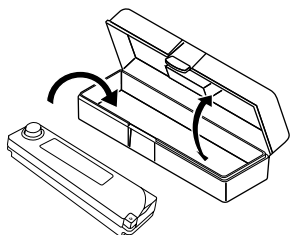

Attaching the control panel

1 Insert the left side of the control panel into the groove on the panel holder.

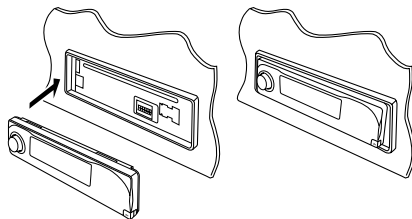

2 Press the right side of the control panel to fix it to the panel holder.

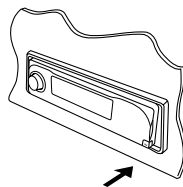

Note on cleaning the connectors:

If you frequently detach the control panel, the connectors will deteriorate.

To minimize this possibility, periodically wipe the connectors with a cotton swab or cloth moistened with alcohol, being careful not to damage the connectors.

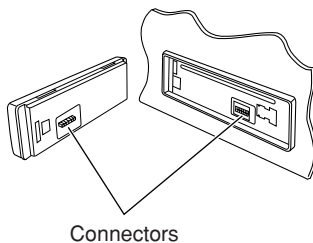



CD CHANGER OPERATIONS

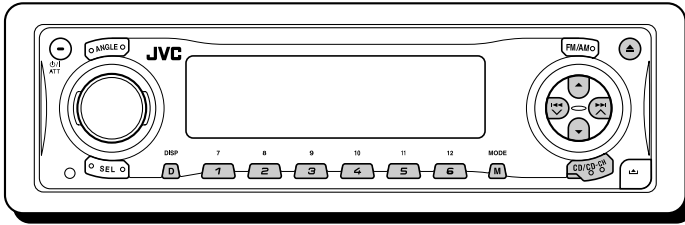

We recommend that you use the JVC MP3-compatible CD changer with your unit.

By using this CD changer, you can play back your original CD-Rs (Recordable) and CD-RWs (Rewritable) recorded either in audio CD format or in MP3 format.

- You can also connect other CH-X series CD changers (except CH-X99 and CH-X100). However, they are not compatible with MP3 discs, so you cannot play back MP3 discs.
- You cannot use the KD-MK series CD changers with this unit.

Before operating your CD changer:

- Refer also to the Instructions supplied with your CD changer.
- If no discs are in the magazine of the CD changer or the discs are inserted upside down, "No Disc" will flash on the display. If this happens, remove the magazine and set the discs correctly.
- If no magazine is loaded in the CD changer, "No Magazine" flashes on the display. If this happens, insert the magazine in the CD changer.
- If "Reset 01" – "Reset 08" flashes on the display, something is wrong with the connection between this unit and the CD changer. If this happens, check the connection and make sure the cords are connected firmly. Then, press the reset button of the CD changer.

Playing discs

Select the CD changer (CD-CH).



Each time you press the button, the source changes as described on page 7.

- **When the current disc is an MP3 disc:** Playback starts from the first folder of the current disc once file check is completed.

Selected disc number

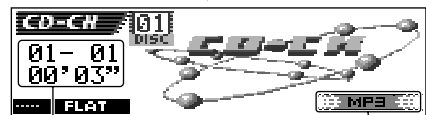

Current folder/track and
elapsed playing time

MP3 indicator

• When the current disc is a CD:

Playback starts from the first track of the current disc.

Selected disc number

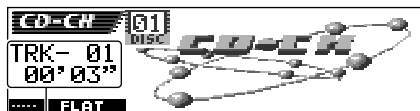
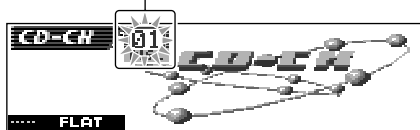

Current track and elapsed playing time

Notes:

- When you press CD/CD-CH, the power automatically comes on. You do not have to press ATT to turn on the power.
- If you change the source, CD changer play also stops. Next time you select "CD-CH" as the source, disc play starts from where playback has been stopped previously.

To change the display pattern

By pressing D DISP, you can change the information shown on the display.



Each time you press the button, the display patterns change.

- For details, see page 23.

To go to a particular disc directly

Press the number button corresponding to the disc number to start its playback (while the CD changer is playing).

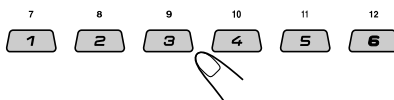

- To select a disc number from 01 – 06: Press 1 (7) – 6 (12) briefly.
- To select a disc number from 07 – 12: Press and hold 1 (7) – 6 (12) for more than one second.

To fast-forward or reverse the track

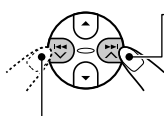

Press and hold , during play, to fast-forward the track.

Press and hold , during play, to reverse the track.

Note:

During this operation on an MP3 disc, you can only hear intermittent sounds. (The elapsed playing time also changes intermittently on the display.)

To go to the next or previous tracks

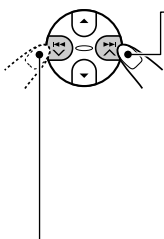

Press briefly during play, to skip ahead to the beginning of the next track. Each time you press the button consecutively, the beginning of the next tracks is located and played back.

Press briefly during play, to skip back to the beginning of the current track.

Each time you press the button consecutively, the beginning of the previous tracks is located and played back.

This operation is only possible when using JVC MP3-compatible CD changer (CH-X1500).

To go to a track quickly

1 Press M MODE while playing a disc.



"Mode" appears on the display. The next-step-operation buttons start flashing.

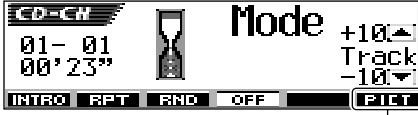

See page 30 for this function.

Ex.: When the current disc is an MP3 disc

2 Press ▲ (up) or ▼ (down) while "Mode" is still on the display.



To skip 10 tracks* forwards to the last track

To skip 10 tracks* backwards to the first track

* First time you press ▲ (up) or ▼ (down) button, the track skips to the nearest higher or lower track with a track number of multiple ten (ex. 10th, 20th, 30th).

Then each time you press the button, you can skip 10 tracks (see "How to go to the desired track quickly" on the right column).

- After the last track, the first track will be selected, and vice versa.

Note:

If the current playing disc is an MP3 disc, tracks are skipped within the same folder.

How to go to the desired track quickly

- Ex. 1: To select track number 32 while playing track number 6

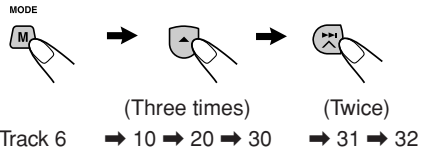

- Ex. 2: To select track number 8 while playing track number 36

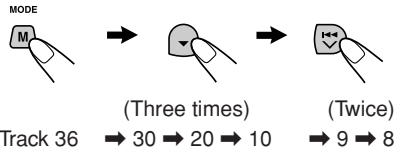

To skip to the next or previous folder (Only for MP3 discs)



Press ▲ (up) while playing an MP3 disc, to go to the next folder. Each time you press the button consecutively, the next folder is located, and the first track in the folder starts playback.

Press ▼ (down) while playing an MP3 disc, to go to the previous folder.

Each time you press the button consecutively, the previous folder is located, and the first track in the folder starts playback.

Selecting a disc/folder/track using the name lists

If you forget what discs are loaded in the CD changer, you can show the disc name list and select a disc in the list shown on the display.

- The display can show only six names at a time.

- 1 While playing a disc, press and hold ▲ (up) or ▼ (down) until a disc name list appears on the display.

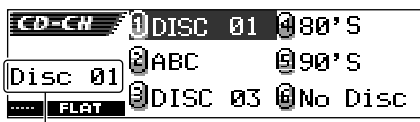
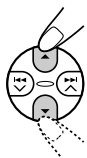

Selected disc number

Note:

If a disc has a disc title (CD Text) or an assigned disc name, it will be shown on the display.

However, if the disc has not been played before, its disc number will appear.

- 2 Press ▲ (up) or ▼ (down) to show the other disc name list, if necessary.

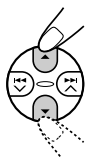

- 3 Select the number (1 – 6) for the disc you want to play.

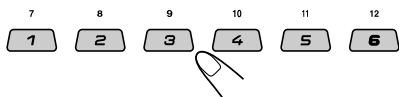

While playing an MP3 disc, you can also show the folder name list(s) and track name list(s) on the display, then select a folder or track.

- 1 While playing an MP3 disc, press and hold ▲ (up) or ▼ (down) until a disc name list appears on the display.
- 2 Press ►► ▲ or ◀◀ ▼ to show a folder name list of the current disc or track name list of the current folder.
Each time you press the button, the lists on the display change as follows:



Current folder number



Ex.: When folder name list is selected

Current track number

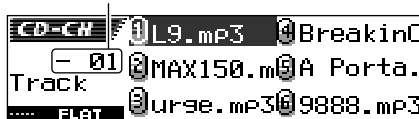

Ex.: When track name list is selected

Note:

The display can show only six items at a time. You can show the other names on the next lists by pressing ▲ (up) or ▼ (down).

- 3 Press the number button for the disc, folder, or track you want to play.

Selecting the playback modes

To play back tracks at random (Random Play)

1 Press M MODE during play.



“Mode” appears on the display. The next-step-operation buttons start flashing.

2 Press number button 3 repeatedly while “Mode” is still on the display.

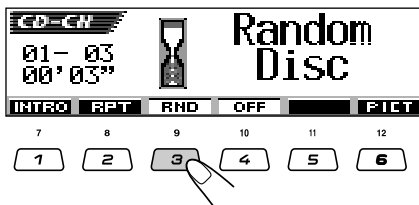

Ex.: When you select “Random Disc” while playing an MP3 disc

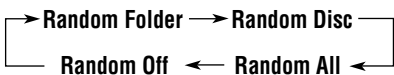

Each time you press the button, random play mode changes as follows:

For MP3 discs:



For CDs:



Mode	Active indicator	Plays at random
Random Folder*	 RND (folder random) indicator lights up.	All tracks of the current folder, then tracks of the next folder and so on.
Random Disc	 RND (disc random) indicator lights up.	All tracks of the current (or specified) disc.
Random All	ALL RND (all random) indicator lights up.	All tracks of all discs inserted in the magazine.

* “Random Folder” is only applicable for MP3 disc.

Note:

MP3 indicator also lights up if the current playing disc is an MP3 disc.

To cancel random play, select “Random Off” by pressing number button 3 repeatedly or press number button 4 in step 2.

To play back tracks repeatedly (Repeat Play)

1 Press M MODE during play.



“Mode” appears on the display. The next-step-operation buttons start flashing.

2 Press number button 2 repeatedly while “Mode” is still on the display.

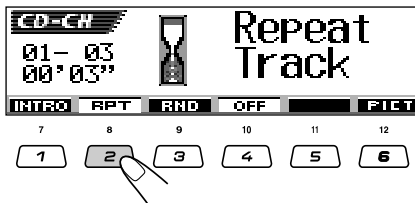

Ex.: When you select “Repeat Track” while playing an MP3 disc

Each time you press the button, repeat play mode changes as follows:

For MP3 discs:

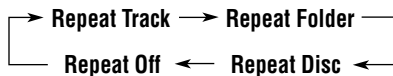

For CDs:



Mode	Active indicator	Plays repeatedly
Repeat Track	RPT (track repeat) indicator lights up.	The current (or specified) track.
Repeat Folder*	RFT (folder repeat) indicator lights up.	All tracks of the current (or specified) folder of the current disc.
Repeat Disc	RFT (disc repeat) indicator lights up.	All tracks of the current (or specified) disc.

* "Repeat Folder" is only applicable for MP3 disc.

Note:

MP3 indicator also lights up if the current playing disc is an MP3 disc.

To cancel repeat play, select "Repeat Off" by pressing number button 2 repeatedly or press number button 4 in step 2.

To play back only intros (Intro Scan)

1 Press M MODE during play.



"Mode" appears on the display. The next-step-operation buttons start flashing.

2 Press number button 1 repeatedly while "Mode" is still on the display.

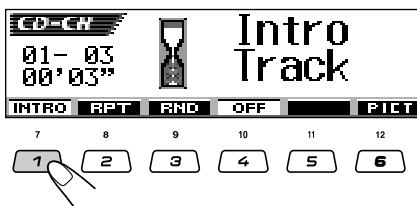

Ex.: When you select "Intro Track" while playing an MP3 disc

Each time you press the button, intro scan mode changes as follows:

For MP3 discs:

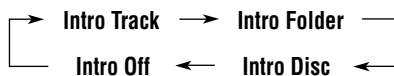

For CDs:



Mode	Active indicator	Plays the beginnings (15 seconds) of
Intro Track	INT (track intro) indicator lights up.	All tracks of the current disc.
Intro Folder*	INT (folder intro) indicator lights up.	The first track of every folder of the current disc.
Intro Disc	INT (disc intro) indicator lights up.	The first tracks of the inserted discs.

* "Intro Folder" is only applicable for MP3 disc.

Note:

MP3 indicator also lights up if the current playing disc is an MP3 disc.

To cancel intro scan, select "Intro Off" by pressing number button 1 repeatedly or press number button 4 in step 2.



EXTERNAL COMPONENT OPERATIONS

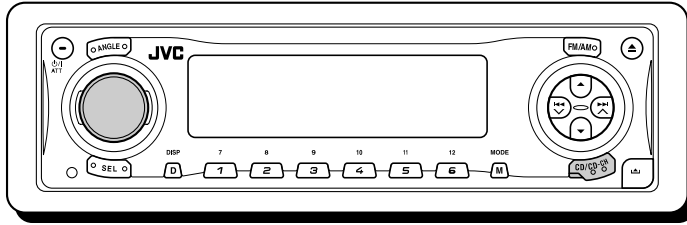

Playing an external component

You can connect the external component to the CD changer jack on the rear using the Line Input Adapter KS-U57 (not supplied).

Preparations:

- For connecting the Line Input Adapter KS-U57 and the external component, refer to the Installation/ Connection Manual (separate volume).
- Before operating the external component using the following procedure, select the external input correctly. See “To select the external component to use—Ext Input” on page 39.

2 Turn on the connected component and start playing the source.

3 Adjust the volume.

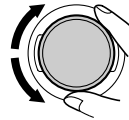

4 Adjust the sound as you want. (See pages 24 – 27.)

1 Select the external component (LINE IN).

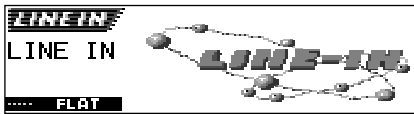

- If “LINE IN”* does not appear on the display, see page 39 and select the external input (“Line In”).

* Displayed only when one of the following sources is selected—FM, AM, and CD.

Note on One-Touch Operation:

When you press CD/CD-CH, the power automatically comes on. You do not have to press /I ATT to turn on the power.

TROUBLESHOOTING



What appears to be trouble is not always serious. Check the following points before calling a service center.

	Symptoms	Causes	Remedies
General	<ul style="list-style-type: none"> Sound cannot be heard from the speakers. 	The volume level is set to the minimum level.	Adjust it to the optimum level.
		Connections are incorrect.	Check the cords and connections.
	<ul style="list-style-type: none"> This unit does not work at all. 	The built-in microcomputer may have functioned incorrectly due to noise, etc.	Press the reset button on the control panel. (Your preset adjustments will also be erased.) (See page 2.)
	<ul style="list-style-type: none"> "Panel Connect Error" appears on the display. 	The control panel is not attach correctly and firmly.	Remove the control panel, wipe the connectors, then attach it again. (See page 45.)
	<ul style="list-style-type: none"> When "Reset P00" to "Reset P44" appears on the display. 	There is something blocking the control panel movement.	Press the reset button on the control panel. (See page 2.) If the reset button does not work, check the installation. (Ex. you have used a screw which is longer than specified.)
FM/AM	<ul style="list-style-type: none"> SSM (Strong-station Sequential Memory) automatic preset does not work. 	Signals are too weak.	Store stations manually.
	<ul style="list-style-type: none"> Static noise while listening to the radio. 	The antenna is not connected firmly.	Connect the antenna firmly.
Disc Playback	<ul style="list-style-type: none"> Disc cannot be played back. 	Disc is inserted upside down.	Insert the disc correctly.
	<ul style="list-style-type: none"> CD-R/CD-RW cannot be played back. Tracks on the CD-R/CD-RW cannot be skipped. 	CD-R/CD-RW is not finalized.	<ul style="list-style-type: none"> Insert a finalized CD-R/CD-RW. Finalize the CD-R/CD-RW with the component which you used for recording.
	<ul style="list-style-type: none"> Disc cannot be ejected. 	Disc is locked.	Unlock the disc. (See page 22.)
	<ul style="list-style-type: none"> Disc cannot be recognized ("No Disc," "Loading Error," or "Eject Error" flashes on the display.) 	The CD player may function incorrectly.	While pressing ⏻ /I ATT (standby/on attenuator), press and hold ⏏ (eject) for more than 2 seconds to eject the disc.
	<ul style="list-style-type: none"> Disc sound is sometimes interrupted. 	You are driving on rough roads.	Stop playback while driving on rough roads.
		Disc is scratched.	Change the disc.
		Connections are incorrect.	Check the cords and connections.
<ul style="list-style-type: none"> "No Disc" flashes on the display. 	No disc in the loading slot.	Insert a disc into the loading slot.	
	Disc is inserted incorrectly.	Insert the disc correctly.	



	Symptoms	Causes	Remedies
MP3/WMA Playback	<ul style="list-style-type: none"> Disc cannot be played back. 	No MP3/WMA tracks are recorded on the disc.	Change the disc.
		MP3/WMA tracks do not have the extension code <.mp3> or <.wma> in their track names.	Add the extension code <.mp3> or <.wma> to their track names.
		MP3/WMA tracks are not recorded in the format compliant with ISO 9660 Level 1, Level 2, Romeo, or Joliet.	Change the disc. (Record MP3/WMA tracks using a compliant application.)
	<ul style="list-style-type: none"> “Not Support” appears and tracks skip. 	Tracks are not encoded in an appropriate format.	Insert a disc that contains tracks encoded in an appropriate format.
		WMA tracks are copy-protected.	This is normal. Copy-protected tracks cannot be played back.
	<ul style="list-style-type: none"> Noise is generated. 	The track played back is not an MP3/WMA track (although it has the extension code <.mp3> or <.wma>).	Skip to another track or change the disc. (Do not add the extension code <.mp3> or <.wma> to non-MP3/WMA tracks.)
	<ul style="list-style-type: none"> A longer readout time is required (“File Check” keeps flashing on the display). 	Readout time varies due to the complexity of the folder/track configuration.	Do not use too many hierarchies and folders.
	<ul style="list-style-type: none"> Tracks cannot be played back as you have intended them to play. 	Playback order is determined when the tracks are recorded.	_____
	<ul style="list-style-type: none"> Elapsed playing time is not correct. 	This sometimes occurs during play. This is caused by how the tracks are recorded on the disc.	_____
	<ul style="list-style-type: none"> “No Files” flashes on the display. 	The current disc does not contain any MP3/WMA track.	Insert a disc that contains MP3/WMA tracks.
<ul style="list-style-type: none"> “No Music” appears on the display. 	The current folder does not contain any MP3/WMA track.	Select another folder that contains MP3/WMA tracks.	
	Only <.jml> and/or <.jma> files are recorded on the disc.	Insert a disc that contains MP3/WMA tracks.	
<ul style="list-style-type: none"> Correct characters are not displayed (e.g. album name). 	This unit can only display alphabets (capital: A–Z, small: a – z), numbers, and a limited number of symbols.	_____	



Symptoms	Causes	Remedies	
<ul style="list-style-type: none"> Download does not seem to finish. 	You are trying to download an animation of many frames.	This is normal (see page 30).	Graphics
<ul style="list-style-type: none"> Animation does not move. “Movie” category settings in the PSM do not take effect. 	Temperature in the car compartment is very low— (LOW TEMP.) indicator appears.	Wait until the operating temperature resumes—until (LOW TEMP.) indicator goes off.	
<ul style="list-style-type: none"> “No Disc” flashes on the display. 	No disc is in the magazine.	Insert discs into the magazine.	CD Changer
	Discs are inserted upside down.	Insert discs correctly.	
<ul style="list-style-type: none"> “No Magazine” flashes on the display. 	No magazine is loaded in the CD changer.	Insert the magazine.	
<ul style="list-style-type: none"> “Reset 08” flashes on the display. 	This unit is not connected to the CD changer correctly.	Connect this unit and the CD changer correctly and press the reset button of the CD changer.	
<ul style="list-style-type: none"> “Reset 01” – “Reset 07” flashes on the display. 	_____	Press the reset button of the CD changer.	
<ul style="list-style-type: none"> The CD changer does not work at all. 	The built-in microcomputer may function incorrectly due to noise, etc.	Press the reset button on the control panel. (Your preset adjustments will also be erased.) (See page 2.)	

Available characters

You can use the following characters to assign names to stations, CDs, and external component. (See page 43.)

- These characters can be also used to show other information such as disc title/performer on the display.

Capital letters

A	B	C	D	E
F	G	H	I	J
K	L	M	N	O
P	Q	R	S	T
U	V	W	X	Y
Z	space			

Small letters

a	b	c	d	e
f	g	h	i	j
k	l	m	n	o
p	q	r	s	t
u	v	w	x	y
z	space			

Numbers and symbols

0	1	2	3	4
5	6	7	8	9
!	”	#	\$	%
&	'	()	*
+	,	-	.	/
:	;	<	=	>
?	@	_	`	space



Handling discs

This unit has been designed to reproduce CDs, CD-Rs (Recordable), CD-RWs (Rewritable), and CD Texts.

- This unit is also compatible with MP3 and WMA discs.

How to handle discs

When removing a disc from its case,

press down the center holder of the case and lift the disc out, holding it by the edges.

- Always hold the disc by the edges. Do not touch its recording surface.

Center holder



When storing a disc into its case, gently insert the disc around the center holder (with the printed surface facing up).

- Make sure to store discs into the cases after use.

To keep discs clean

A dirty disc may not be played correctly. If a disc does become dirty, wipe it with a soft cloth in a straight line from center to edge.



To play new discs

New discs may have some rough spots around the inner and outer edges. If such a disc is used, this unit may reject the disc.

To remove these rough spots, rub the edges with a pencil or ball-point pen, etc.



Moisture condensation

Moisture may condense on the lens inside the CD player in the following cases:

- After starting the heater in the car.
- If it becomes very humid inside the car.

Should this occur, the CD player may malfunction. In this case, eject the disc and leave the unit turned on for a few hours until the moisture evaporates.

When playing a CD-R or CD-RW

Before playing back CD-Rs or CD-RWs, read their instructions or cautions carefully.

- Use only "finalized" CD-Rs or CD-RWs.
- Some CD-Rs or CD-RWs may not be played back on this unit because of their disc characteristics, and for the following reasons:
 - Discs are dirty or scratched.
 - Moisture condensation on the lens inside the unit.
 - The pickup lens inside the unit is dirty.
- CD-RWs may require a longer readout time since the reflectance of CD-RWs is lower than that of regular CDs.
- CD-Rs or CD-RWs are susceptible to high temperatures or high humidity, so do not leave them inside your car.
- Do not use following CD-Rs or CD-RWs:
 - Discs with stickers, labels, or protective seal stuck to the surface.
 - Discs on which labels can be directly printed by an ink jet printer.

Using these discs under high temperatures or high humidity may cause malfunctions or damage to discs. For example,

- Stickers or labels may shrink and warp a disc.
- Stickers or labels may be peeled off so discs cannot be ejected.
- Print on discs may get sticky.

Read instructions or cautions about labels and printable discs carefully.

CAUTIONS:

- Do not insert 8 cm discs (single CDs) into the loading slot. (Such discs cannot be ejected.)
- Do not insert any disc of unusual shape—like a heart or flower; otherwise, it will cause a malfunction.
- Do not expose discs to direct sunlight or any heat source or place them in a place subject to high temperature and humidity. Do not leave them in a car.
- Do not use any solvent (for example, conventional record cleaner, spray, thinner, benzene, etc.) to clean discs.

Warped disc



Sticker



Sticker residue

Disc



Stick-on label

AUDIO AMPLIFIER SECTION

Maximum Power Output:

Front: 50 W per channel

Rear: 50 W per channel

Continuous Power Output (RMS):

Front: 19 W per channel into 4 Ω , 40 Hz to 20 000 Hz at no more than 0.8% total harmonic distortion.

Rear: 19 W per channel into 4 Ω , 40 Hz to 20 000 Hz at no more than 0.8% total harmonic distortion.

Load Impedance: 4 Ω (4 Ω to 8 Ω allowance)

Equalizer Control Range:

Frequencies: 60 Hz, 150 Hz, 400 Hz, 1 kHz, 2.4 kHz, 6 kHz, 12 kHz

Level: ± 10 dB

Frequency Response: 40 Hz to 20 000 Hz

Signal-to-Noise Ratio: 70 dB

Line-Out Level/Impedance:

5.0 V/20 k Ω load (full scale)

Output Impedance: 1 k Ω

Subwoofer-Out Level/Impedance:

2.0 V/20 k Ω load (full scale)

TUNER SECTION

Frequency Range:

FM: 87.5 MHz to 108.0 MHz

AM: 531 kHz to 1 602 kHz

[FM Tuner]

Usable Sensitivity: 11.3 dBf (1.0 μ V/75 Ω)

50 dB Quieting Sensitivity: 16.3 dBf (1.8 μ V/75 Ω)

Alternate Channel Selectivity (400 kHz): 65 dB

Frequency Response: 40 Hz to 15 000 Hz

Stereo Separation: 35 dB

Capture Ratio: 1.5 dB

[AM Tuner]

Sensitivity: 20 μ V

Selectivity: 35 dB

CD PLAYER SECTION

Type: Compact disc player

Signal Detection System: Non-contact optical pickup (semiconductor laser)

Number of channels: 2 channels (stereo)

Frequency Response: 5 Hz to 20 000 Hz

Dynamic Range: 96 dB

Signal-to-Noise Ratio: 98 dB

Wow and Flutter: Less than measurable limit

MP3 decoding format:

MPEG 1/2 Audio Layer 3

Max. Bit Rate: 320 Kbps

WMA (Windows Media[®] Audio) decoding format:

Max. Bit Rate: 192 Kbps

GENERAL

Power Requirement:

Operating Voltage:

DC 14.4 V (11 V to 16 V allowance)

Grounding System: Negative ground

Allowable Operating Temperature: 0°C to +40°C

Dimensions (W \times H \times D):

Installation Size (approx.):

182 mm \times 52 mm \times 159 mm

Panel Size (approx.):

188 mm \times 58 mm \times 12 mm

Mass (approx.):

1.6 kg (excluding accessories)

Design and specifications are subject to change without notice.

**Having TROUBLE with operation?
Please reset your unit
Refer to page of How to reset your unit**

JVC

KD-LH305

راديو مع مشغل CD

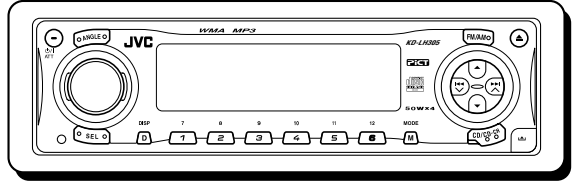
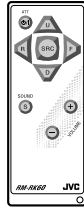
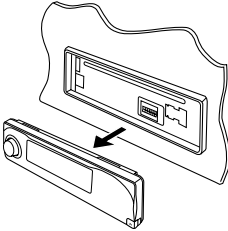

WMA MP3

PICT

**COMPACT
disc
DIGITAL AUDIO
TEXT**

هذا الجهاز مزوّد بوظيفة استعراض لشاشة العرض. لالغاء وظيفة الاستعراض، انظر صفحة ٨.

لعمليات التركيب والتوصيلات، يرجى مراجعة كتيب التعليمات المنفصل.

دليل التعليمات

EN, CT, TH, AR

© 2003 VICTOR COMPANY OF JAPAN, LIMITED

1203KKSMdTJEIN

Download from Www.Somanuals.com. All Manuals Search And Download.

JVC KD-LH305

Installation/Connection Manual

安裝/連接手冊

การติดตั้ง/คู่มือการติดตั้ง

كتيب تعليمات التركيب/التوصيل

GET0202-003A
[U]

1203KKSMDTJEIN
EN, CT, TH, AR

ENGLISH

中文

ไทย

عربي

This unit is designed to operate on **12 V DC, NEGATIVE ground electrical systems**. If your vehicle does not have this system, a voltage inverter is required, which can be purchased at JVC car audio dealers.

本機僅可使用直流 **12V**、負極接地的電源系統。如果您的車輛沒有這一電源系統，則需要一個電壓變換器，可以在 JVC 汽車音響分銷商處買到。

ชุดประกอบนี้ได้รับการออกแบบมาเพื่อใช้งานกับระบบกระแสไฟฟ้าสายดินขั้วลบกระแสตรง **12 โวลท์** หากรถยนต์ของคุณไม่ได้ใช้ระบบนี้ ต้องใช้เครื่องแปลงกระแสไฟด้วย ซึ่งสามารถหาซื้อได้จากร้านขายเครื่องเสียงรถยนต์ JVC

لقد صمم هذا الجهاز ليعمل فقط بواسطة تيار كهربائي مباشر DC، ١٢ فولت، انظمة كهربائية تأريض سالب. في حالة عدم وجود مثل هذا النظام في سيارتك، يجب استخدام محول فولتاج، ويمكن شراء هذا المحول من وكلاء الاجهزة الصوتية للسيارات ماركة JVC.

Parts list for installation and connection

The following parts are provided for this unit. After checking them, please set them correctly.

(A) / (B)
Hard case/Control panel
硬盒 / 控制面板
ถังบรรจุ/หน้าปัด
صندوق صلب/اوحة التحكم

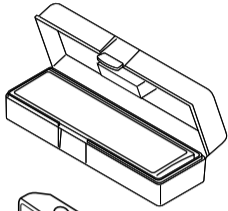

(F)
Remote controller
遙控器
รีโมทคอนโทรล
وحدة التحكم عن بعد

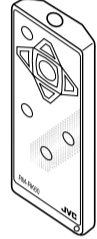

(J)
Mounting bolt (M5 x 20 mm)
緊固螺栓 (M5 x 20 mm)
สลักติด (M5 x 20 มิลลิเมตร)
مسام التركيب (٢٠ x M5 ملم)



(C)
Sleeve
外套機殼
ปลอกหุ้ม
الهيكال الواقى

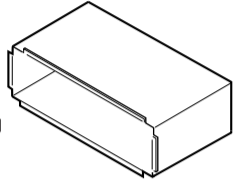

(G)
Battery
電池
แบตเตอรี่
البطاريات



(K)
Rubber cushion
橡膠防震墊
ยางกันกระแทก
الحشوة المطاطية



(D)
Trim plate
裝飾框
แผ่นโลหะขอบแต่ง
لوحة الزينة

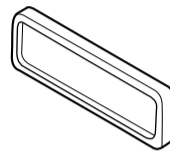

(H)
Washer (ø5)
墊圈 (ø5)
ประเก็นวงแหวน (ø5)
حلقة احكام التوصيل (قطر ٥)



(L)
Handles
板條型把手
คันบังคับ
المسكات

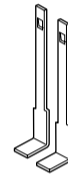

(M)
CD-ROM (Image Converter)
CD-ROM—圖像轉換器
ซีดีรอม ด้แปลงภาพ
CD-ROM - محول صورة



قائمة اجزاء التركيب والتوصيل

الاجزاء التالية مزودة مع الجهاز. بعد فحص هذه الاجزاء، يرجى تركيبهم بشكل صحيح.

(E)
Power cord
電路連接用的配線束
สายเคเบิลกำลัง
سلك الطاقة
الكهربائية

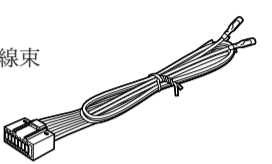

(I)
Lock nut (M5)
鎖定螺母 (M5)
نوت لوك (M5)
صمولة التثبيت (M5)



INSTALLATION (IN-DASH MOUNTING)

安裝 (裝設、固定在儀表板內)

การติดตั้ง (การประกอบแผงหน้าปัดเข็ม)

تركيب الجهاز (داخل - تابلو السيارة)

The following illustration shows a typical installation. If you have any questions or require information regarding installation kits, consult your JVC car audio dealer or a company supplying kits.

下面的圖解表示了典型的安裝程序。如果您有問題，或需要有關配套元件的資料，請向 JVC 汽車音響分銷商或配套元件供應公司詢問。

ภาพตัวอย่างต่อไปนี้แสดงถึงการติดตั้งแบบทั่วไป หากคุณมีปัญหาคือหรือต้องการข้อมูลเพิ่มเติมเกี่ยวกับชุดติดตั้ง กรุณาปรึกษากับผู้ขายเครื่องเสียงรถยนต์ JVC ของท่านหรือบริษัทผู้ขายเครื่องเสียงรถยนต์ JVC ของท่านหรือบริษัทผู้ขายเครื่องเสียงรถยนต์ JVC ของท่านหรือบริษัทผู้ขายเครื่องเสียงรถยนต์ JVC ของท่าน

يبين الرسم التوضيحي التالي طريقة التركيب المثالية. اذا كان هناك استفسارات او حاجة لمعلومات بخصوص ادوات التركيب، يرجى استشارة موزع الاجهزة الصوتية للسيارات ماركة JVC او الشركة الموزعة لهذه الادوات. في حالة عدم معرفتك بكيفية تركيب الجهاز بشكل صحيح، يرجى ترك عملية تركيب الجهاز لشخص مختص ومؤهل لتركيب مثل هذه الاجهزة.

- If you are not sure how to install this unit correctly, have it installed by a qualified technician.

1

2

3

4

*1 When you stand the unit, be careful not to damage the fuse on the rear.
*1 您豎起本機時，小心不要損壞底部的保險絲。
*1 เมื่อคุณตั้งชุดประกอบขึ้น ระวังอย่าทำให้ฟิวส์บริเวณส่วนท้ายเสียหาย
*1 عند توقيف الجهاز، انتبه من اجل عدم تضرر الفيوز الموجود على الجهة الخلفية.

5

Fit the projections outside of the unit.
安裝且固定本裝置的外部投影。
การเดินสายไฟลำโพง
وازن النتوءات خارج الجهاز.

Do the required electrical connections.
進行所需的電路連接。
ต่อสายไฟตามที่กำหนดไว้ทั้งหมด
اعمل التوصيلات الكهربائية المطلوبة.

Bend the appropriate tabs to hold the sleeve firmly in place.
弄彎機殼的突舌，把外套機殼牢固在儀表板內。
งอแผ่นเพื่อยึดปลอกให้ตอกันแน่นเข้าที่
انثي الالسنة بشكل مناسب لتثبيت الهيكال الواقى بشكل محكم في المكان الصحيح.

Removing the unit

Before removing the unit, release the rear section.

拆卸本機

在拆卸本機前，應將本機後部的固定和連接部分鬆開。

การถอดชุดประกอบ

ก่อนจะถอดชุดประกอบ ให้ปลดหน้าตัดส่วนท้ายก่อน

نزع الجهاز من تابلو السيارة

قبل نزع الجهاز، حرر الجزء الخلفي.

1

2

3

4

Insert the two handles, then pull them as illustrated so that the unit can be removed.
按圖所示，將兩片板條型把手插入卡槽，然後輕穩地從兩側向外拉兩片把手，本機隨之拉出。
ใส่คันบังคับกับ 2 อันลงในร่องสำหรับไขพันลวด ดังภาพ จากนั้นให้เลื่อนชุดประกอบออก ในขณะที่ค่อย ๆ ดึงคันบังคับทั้งสองอันออกจากกัน
ادخل المسكاتين، وبعد ذلك اسحبهم كما هو مبين بحيث يمكن نزع الجهاز.

When using the optional stay / 若選用支撐架 / เมื่อใช้ตัวยึดแบบเลือกได้ (สามารถเลือกเปิดค้างไว้ได้) / عند استخدام الدعامة الاضافية

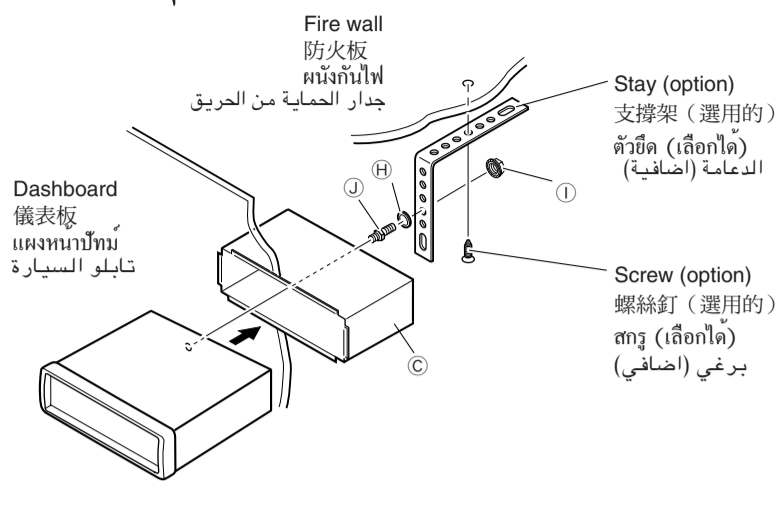

Install the unit at an angle of less than 30°. 將本機安裝在少於 30° 的角度。ติดตั้งชุดประกอบที่มุมต่ำกว่า 30 องศา. قم بتركيب الجهاز בזواوية اقل من 30 درجة

When installing the unit without using the sleeve / 若不使用外套機殼安裝本機 / เมื่อติดตั้งชุดประกอบโดยไม่ใช้ปลอกหุ้ม / عندما تركيب الجهاز بدون استخدام الهيكل الواقي

In a Toyota for example, first remove the car radio and install the unit in its place.

以豐田牌 (TOYOTA) 汽車為例：首先取出汽車收音機，然後將本機裝入其空出的位置。ตัวอย่างเช่น ในรถยนต์โตโยตา ให้ถอดวิทยุติดรถยนต์ออกก่อนและติดตั้งชุดประกอบนี้เข้าไปแทน. على سبيل المثال، في سيارات نوع تويوتا، انزع راديو السيارة اولا بعد ذلك ركب الجهاز في مكانه.

Flat type screws (M5 x 8 mm)* 平頭螺絲釘 (M5 x 8 mm)* สกรูหัวเรียบ (M5 x 8 มิลลิเมตร)* *براغي مستوية القاعدة (M5 x 8 ملم)*

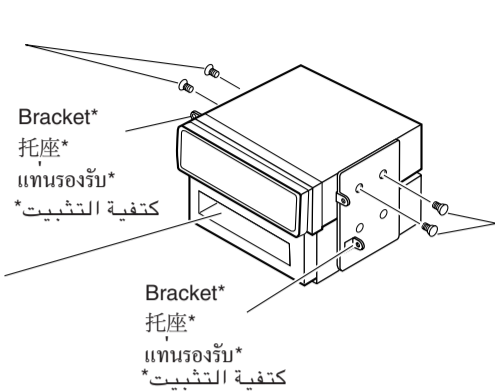

* Not included with this unit. * 不包括在本機中 * ไม่รวมกับชุดประกอบนี้ * غير مزود مع هذا الجهاز.

Flat type screws (M5 x 8 mm)* 平頭螺絲釘 (M5 x 8 mm)* สกรูหัวเรียบ (M5 x 8 มิลลิเมตร)* *براغي مستوية القاعدة (M5 x 8 ملم)*

Note : When installing the unit on the mounting bracket, make sure to use the 8 mm-long screws. If longer screws are used, they could damage the unit. **注意** : 把本機安裝在托座上時，務必使用 8 mm 長的螺絲釘。如使用過長的螺絲釘，會損壞本機。 **หมายเหตุ** : เมื่อติดตั้งชุดประกอบลงในแท่นรองรับไว้ให้ใช้สกรูยาวขนาด 8 มิลลิเมตร ถ้าใช้สกรูยาวกว่านี้อาจทำให้ชุดประกอบเสียหายได้ **ملاحظة** : عند تركيب الجهاز على كتفيات التثبيت، تأكد من استعمال براغي طول 8 ملم. في حالة استخدام براغي اطول من 8 ملم، يمكن ان يسبب ذلك تلف او ضرر للجهاز.

ELECTRICAL CONNECTIONS

To prevent short circuits, we recommend that you disconnect the battery's negative terminal and make all electrical connections before installing the unit.

• **Be sure to ground this unit to the car's chassis again after installation.**

Notes:

- Replace the fuse with one of the specified rating. If the fuse blows frequently, consult your JVC car audio dealer.
- It is recommended to connect to the speakers with maximum power of more than 50 W (both at the rear and at the front, with an impedance of 4 Ω to 8 Ω). If the maximum power is less than 50 W, change "AMP.GAIN" setting to prevent the speakers from being damaged (see page 39 of the INSTRUCTIONS).
- To prevent short-circuit, cover the terminals of the UNUSED leads with insulating tape.
- The heat sink becomes very hot after use. Be careful not to touch it when removing this unit.



電路連接

為防止短路，建議在安裝本機之前，斷開電池的負極，並把所有電路都連接好。

• 安裝完畢後務必將本機的地線重新接至車身。

注意：

- 把保險絲更換為額定負荷值的保險絲。如果保險絲經常燒壞，請向 JVC 汽車音響分銷商詢問。
- 後置和前置揚聲器的最大輸入功率應大於 50 W，其阻抗為 4 Ω - 8 Ω。如果最大功率小於 50 W，請調校 "AMP.GAIN" 設定值，以防止揚聲器損壞。（參閱使用說明書的第 39 頁）。
- 為防止電源短路，請用絕緣帶包住未使用電線的端子。
- 本機使用後，散熱片會很熱。因此，在移出本機時，小心不要觸摸散熱片。

การเชื่อมโดยใช้ไฟฟ้า

เพื่อป้องกันการเกิดไฟฟ้าลัดวงจรขอแนะนำให้ปลดขั้วแบตเตอรี่ลบออก แล้วจึงต่อสายไฟก่อนติดตั้งเครื่อง

• ตรวจสอบให้แน่ใจว่าได้เดินสายดินต่อระหว่างเครื่องกับตัวถังรถยนต์ใหม่แล้วหลังจากติดตั้ง

หมายเหตุ :

- ใช้ฟิวส์ที่เฉพาะแทนฟิวส์ หากฟิวส์ขาดบ่อย ให้ปรึกษาช่างเทคนิคเครื่องเสียงรถยนต์ JVC
- ขอแนะนำให้ต่อลำโพง ที่มีกำลังขับสูงสุดเกินกว่า 50 W (ทั้งด้านหน้าและด้านหลัง มีค่าความต้านทาน 4 Ω ถึง 8 Ω) ถ้ากำลังขับต่ำกว่า 50 W ให้เปลี่ยนค่า "AMP.GAIN" เพื่อป้องกันไม่ให้ลำโพงชำรุด (ดูหน้า 39 ในคู่มือใช้งาน)
- การป้องกันการลัดวงจร จะต้องพันขั้วสายตะกั่วที่มิใช่แล้วด้วยเทป พันพันสายไฟ
- แผ่นระบายความร้อนจะร้อนมากหลังจากใช้ ระวังอย่าไปสัมผัสเมื่อถอดชุดประกอบนี้

التوصيلات الكهربائية

لمنع حدوث تقصير في الدوائر الكهربائية، نوصي بفصل طرف توصيل البطارية السالبة وعمل كل التوصيلات الكهربائية قبل تركيب الجهاز.

• **تأكد من تأريض الجهاز مع هيكل السيارة مرة ثانية بعد التركيب.**

ملاحظات:

- ستبدل الفيوز بفيوز آخر يحمل نفس القياسات الموصوفة. اذا تكرر احتراق الفيوز، استشر وكيل JVC لاجهزة السيارة الصوتية.
- ينصح التوصيل مع سماعات ذات طاقة قصوى اكثر من 50 واط (على كلا من الخلف والامام، مع ممانعة 4 اوم الي 8 اوم). اذا كانت الطاقة القصوى اقل من 50 واط، غير وضع تهيئة "AMP.GAIN" لمنع السماعات من الضرر.
- (انظر صفحة 39 من كتيب التعليمات).
- من اجل منع تقصير الدائرة - الكهربائية، ضع شريط لاصق على اطراف الاسلاك غير المستعملة.
- تصبح صفيحة خفض الحرارة ساخنة جدا بعد الاستخدام. تأكد من عدم ملامستها عند نزع الجهاز.

PRECAUTIONS on power supply and speaker connections:

- **DO NOT connect the speaker leads of the power cord to the car battery; otherwise, the unit will be seriously damaged.**
- BEFORE connecting the speaker leads of the power cord to the speakers, check the speaker wiring in your car.

電源和揚聲器接線注意事項：

- 切勿把揚聲器導線接頭接至電池，否則本機將會嚴重損壞。
- 在把揚聲器導線接頭接至揚聲器之前，檢查您汽車上的揚聲器線路。

ข้อควรระวังสำหรับการต่อแหล่งจ่ายกำลังและลำโพง:

- อย่าต่อสายตะกั่วเดิมกำลังของลำโพงเข้ากับแบตเตอรี่รถยนต์ มิฉะนั้นชุดประกอบจะได้รับความเสียหายมาก
- ก่อนที่จะต่อสายตะกั่วเดิมกำลังของลำโพงเข้ากับลำโพงให้ตรวจสอบการเดินสายไฟลำโพงในรถของคุณให้เรียบร้อยเสียก่อน

تنبيهات حول تزويد الطاقة الكهربائية وتوصيل السماعات:

- لا توصل اسلاك تزويد طاقة السماعات مع بطارية السيارة، لان ذلك يؤدي الى حصول ضرر للسماعات.
- قبل توصيل اسلاك تزويد طاقة السماعات مع السماعات، افحص شبكة اسلاك السماعات داخل سيارتك.

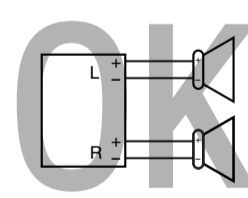
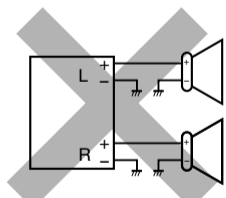
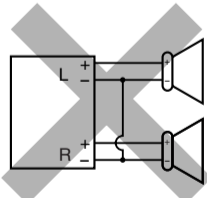

TROUBLESHOOTING

- **The fuse blows.**
 - * Are the red and black leads connected correctly?
- **Power cannot be turned on.**
 - * Is the yellow lead connected?
- **No sound from the speakers.**
 - * Is the speaker output lead short-circuited?
- **Sound is distorted.**
 - * Is the speaker output lead grounded?
 - * Are the "-" terminals of L and R speakers grounded in common?
- **Noise interfere with sounds.**
 - * Is the rear ground terminal connected to the car's chassis using shorter and thicker cords?
- **Unit becomes hot.**
 - * Is the speaker output lead grounded?
 - * Are the "-" terminals of L and R speakers grounded in common?

故障排除

- 保險絲燒斷。
 - * 檢查紅色導線接頭和黑色導線接頭是否接觸正確？
- 電源不能接通。
 - * 檢查黃色導線接頭是否接上？
- 揚聲器沒有聲音。
 - * 檢查揚聲器輸出導線接頭是否短路？
- 聲音失真。
 - * 檢查揚聲器輸出端子是否接地？
 - * 檢查揚聲器的左 (L)、右 (R) 端子的負極 (-) 是否共同接地？
- 噪音干擾音響。
 - * 後接地端子與車身是否使用較短和較厚的電線連接？
- 本機發熱。
 - * 檢查揚聲器輸出端子是否接地？
 - * 檢查揚聲器的左 (L)、右 (R) 端子的負極 (-) 是否共同接地？

การตรวจสอบปัญหาขั้วของ

- **ฟิวส์ขาด**
 - * มีการเชื่อมสายตะกั่วสีดำและสีแดงอย่างถูกต้องหรือไม่
- **ไม่สามารถเปิดเครื่องได้**
 - * มีการเชื่อมสายตะกั่วสีเหลืองหรือไม่
- **ไม่มีเสียงออกจากลำโพง**
 - * สายตะกั่วส่วนที่ออกทางลำโพงเกิดไฟฟ้าลัดวงจรหรือไม่
- **เสียงเพี้ยน**
 - * สายตะกั่วส่วนที่ออกทางลำโพงต่อลงดินหรือไม่
 - * สายขั้วลบ ของลำโพงด้านซ้ายและขวาต่อลงดินตามปกติหรือไม่
- **เสียงรบกวน**
 - * มีการใช้สายสั้นๆ หรือหนาๆ ต่อจากเครื่องส่วนที่ติดตั้งไว้บนพื้นด้านหลังกับตัวถังรถยนต์หรือไม่
- **ชุดประกอบร้อนขึ้น**
 - * สายตะกั่วส่วนที่ออกทางลำโพงต่อลงดินหรือไม่
 - * สายขั้วลบ ของลำโพงด้านซ้ายและขวาต่อลงดินตามปกติหรือไม่

البحث عن الاعطال والاصلاح

- **يحترق الفيوز.**
 - * هل السلك الاحمر والاسود موصولة بشكل صحيح؟
- **لا يمكن توصيل الطاقة الكهربائية.**
 - * هل السلك الاصفر موصولا؟
- **لا يصدر صوت من السماعات.**
 - * هل هنالك تقصير في دائرة سلك خرج السماعة؟
- **الصوت مشوه.**
 - * هل سلك خرج السماعة موصولا بالارض؟
 - * هل الاطراف السالبة "-" للسماعة اليسرى L واليمنى R موصولة بالارض مع بعض؟
- **تداخل ضجيج مع الاصوات.**
 - * هل طرف الارضي الخلفي موصول مع هيكل السيارة باستعمال اسلاك اقصر واسمك؟
- **يسخن الجهاز.**
 - * هل سلك خرج السماعة موصولا بالارض؟
 - * هل الاطراف السالبة "-" للسماعة اليسرى L واليمنى R موصولة بالارض مع بعض؟

A Typical Connections / 典型的接線方法 / การเชื่อมต่อแบบปกติ / التوصيلات النموذجية

Before connecting: Check the wiring in the vehicle carefully. Incorrect connection may cause serious damage to this unit. The leads of the power cord and those of the connector from the car body may be different in color.

接線前：仔細檢查汽車內的線路。不正確的接線會導致本機嚴重損壞。電力線的引線和車身的連接器引線在顏色上可能有所不同。

ก่อนทำการเชื่อมต่อ : ตรวจสอบการเดินสายไฟในรถอย่างละเอียดและถูกต้อง เพื่อให้แน่ใจว่าสายไฟที่เชื่อมต่อกับชุดอุปกรณ์ที่ถูกต้องจะสอดคล้องกันและจะช่วยให้เกิดความเสียหายแก่ชุดอุปกรณ์ที่ติดตั้งไว้ที่รถอย่างปลอดภัย

قبل البدء بالتوصيل: تأكد من شبكة الاسلاك في السيارة بدقة حتى لا يحدث خطأ في عملية توصيل الجهاز. يمكن ان يسبب التوصيل الخاطيء الى حصول عطل حقيقي للجهاز. يمكن ان يختلف لون سلك الطاقة الكهربائية وسلك الموصل عن لون هيكل السيارة.

- 1 Connect the colored leads of the power cord in the order specified in the illustration below.
- 2 Connect the antenna cord.
- 3 Finally connect the wiring harness to the unit.

- 1 依照下圖所示之次序連接電源線的顏色導線。
- 2 將天線的電線連接起來。
- 3 最後，把配線束的插頭插在本機上。

- 1 ต่อสายไฟสีตามลำดับที่ระบุในรูปด้านล่าง
- 2 เชื่อมต่อกับสายอากาศ
- 3 สุดท้าย ต่อส่วนควบคุมการเดินสายไฟเข้ากับชุดประกอบชุดนี้

- 1 اوصل الاسلاك الملونة لسلك الطاقة الكهربائية بالترتيب الموصوف في الرسم الموجود في الأسفل.
- 2 اوصل سلك الهوائي.
- 3 اخيرا، اوصل حامل الاسلاك مع الجهاز.

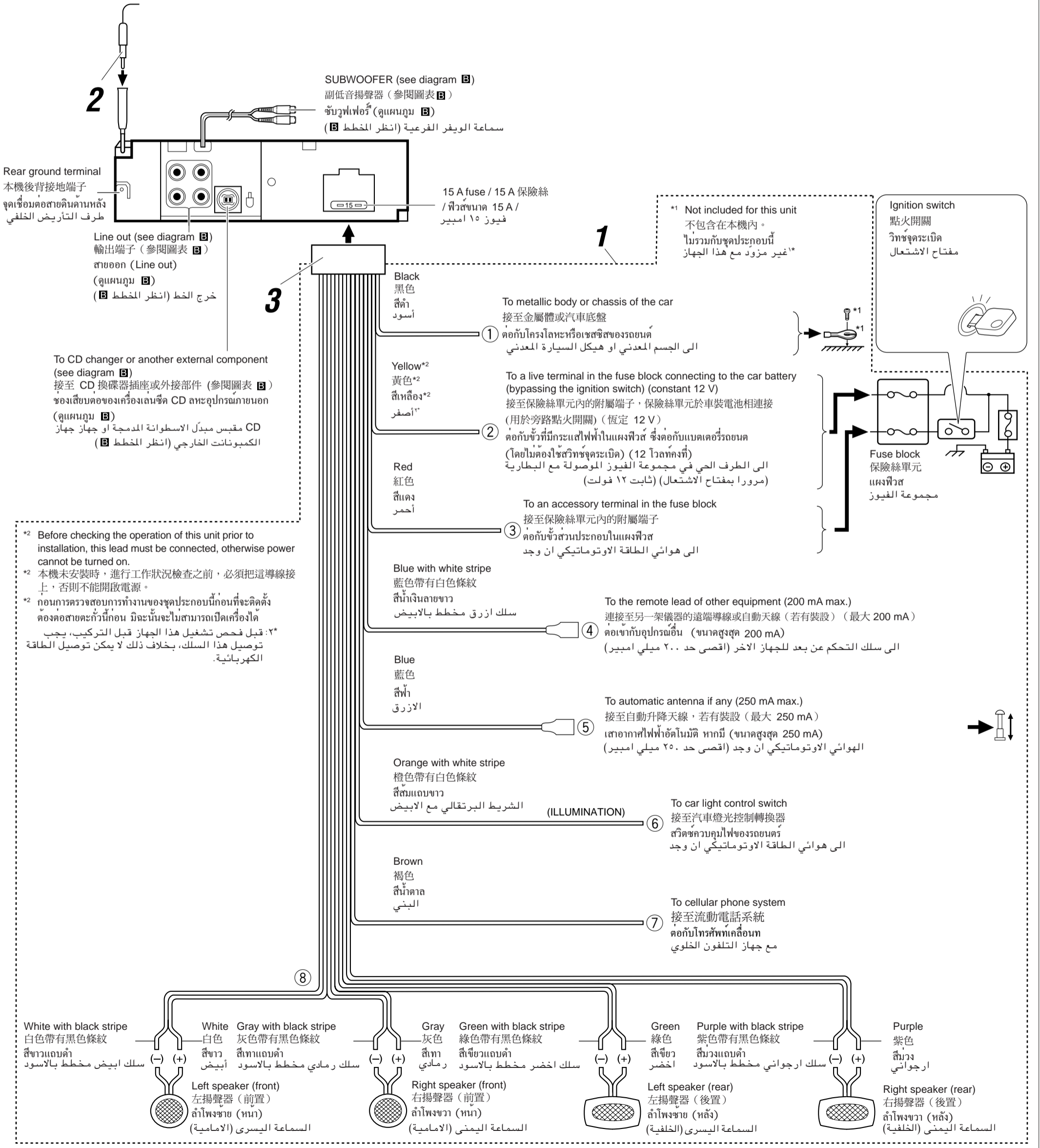

*2 Before checking the operation of this unit prior to installation, this lead must be connected, otherwise power cannot be turned on.
*2 本機未安裝時，進行工作狀況檢查之前，必須把這導線接上，否則不能開啟電源。
*2 ก่อนการตรวจสอบการทำงานของชุดประกอบนี้ก่อนที่จะติดตั้ง ต้องต่อสายตะกั่วนี้ก่อน มิฉะนั้นจะไม่สามารถเปิดเครื่องได้
*2 قبل فحص تشغيل هذا الجهاز قبل التركيب، يجب توصيل هذا السلك، بخلاف ذلك لا يمكن توصيل الطاقة الكهربائية.

Free Manuals Download Website

<http://myh66.com>

<http://usermanuals.us>

<http://www.somanuals.com>

<http://www.4manuals.cc>

<http://www.manual-lib.com>

<http://www.404manual.com>

<http://www.luxmanual.com>

<http://aubethermostatmanual.com>

Golf course search by state

<http://golfingnear.com>

Email search by domain

<http://emailbydomain.com>

Auto manuals search

<http://auto.somanuals.com>

TV manuals search

<http://tv.somanuals.com>