

JVC



CD RECEIVER

KD-LH3105

ENGLISH

CD 收音組合機

KD-LH3105

中文

เครื่องเล่น CD

KD-LH3105

ไทย

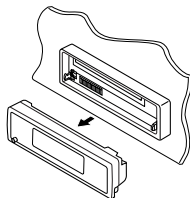
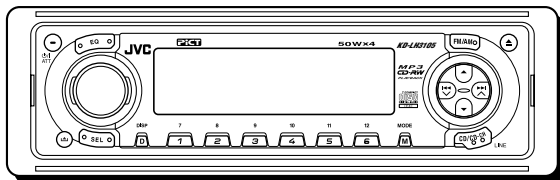

PICT

**COMPACT
disc
DIGITAL AUDIO
TEXT**

**MP3
CD-RW
PLAYBACK**

This unit is equipped with the display demonstration. To cancel it, see page 8.

對本機具有顯示演示功能。要取消該功能，請參閱第 8 頁。

เครื่องนี้ได้รับการติดตั้งการสาธิตภาพประกอบ หากต้องการยกเลิก โปรดดู หน้า 8

For installation and connections, refer to the separate manual.

有關安裝和連接方法，分別參閱操作手冊。

กรุณาดูคู่มือที่แยกต่างหาก ในการติดตั้งและการเชื่อมต่อ

INSTRUCTIONS

使用說明書

คำแนะนำ

GET0149-001A

[U]

IMPORTANT FOR LASER PRODUCTS

Precautions:

1. CLASS 1 LASER PRODUCT
2. **CAUTION:** Invisible laser radiation when open and interlock failed or defeated. Avoid direct exposure to beam.
3. **CAUTION:** Do not open the top cover. There are no user-serviceable parts inside. Leave all servicing to qualified service personnel.
4. **CAUTION:** This CD player uses invisible laser radiation, however, is equipped with safety switches to prevent radiation emission when unloading CDs. It is dangerous to defeat the safety switches.
5. **CAUTION:** Use of controls, adjustments or performance of procedures other than those specified herein may result in hazardous radiation exposure.

Caution:

If the temperature inside the car is below 0° C, the movement of animation and text scroll will be halted on the display to prevent the display from being blurred.  (LOW TEMP.) indicator appears on the display. When the temperature increases, the operating temperature is resumed, and these functions will start working again.

CAUTION on Volume Setting:

Discs produce very little noise compared with other sources. If the volume level is adjusted for the tuner, for example, the speakers may be damaged by the sudden increase in the output level. Therefore, lower the volume before playing a disc and adjust it as required during playback.

How to reset your unit

After detaching the control panel, press the reset button on the panel holder using a ball-point pen or a similar tool.

This will reset the built-in microcomputer.

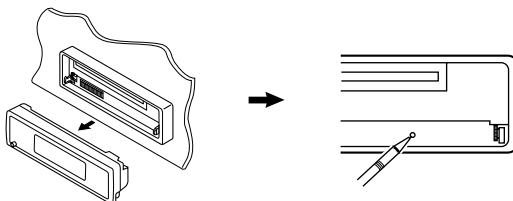

Note:

Your preset adjustments—such as preset channels or sound adjustments—will also be erased.

Thank you for purchasing a JVC product. Please read all instructions carefully before operation, to ensure your complete understanding and to obtain the best possible performance from the unit.

CONTENTS

How to reset your unit	2	SOUND ADJUSTMENTS	28
LOCATION OF THE BUTTONS	4	Adjusting the sound	28
Control panel	4	Selecting preset sound modes (iEQ: intelligent equalizer)	29
Illumination Navigation for easy operations	4	Storing your own sound modes	30
Remote controller	5	Activating the level meter	31
Preparing the remote controller	6	GRAPHIC DISPLAYS	32
BASIC OPERATIONS	7	Downloading images and animations	33
Turning on the power	7	Deleting unwanted files	35
Canceling the display demonstration	8	Activating the downloaded images and animations	37
Setting the clock	9	OTHER MAIN FUNCTIONS	39
RADIO OPERATIONS	10	Changing the general settings (PSM)	39
Listening to the radio	10	Selecting the dimmer mode	43
Storing stations in memory	12	Changing the display color	44
Tuning in to a preset station	13	Assigning names to the sources	46
Changing the display pattern	14	Detaching the control panel	47
CD OPERATIONS	15	CD CHANGER OPERATIONS	48
Playing a CD	15	Playing discs	48
Locating a track or a particular portion on a CD	16	Selecting a disc/folder/track using the name lists	51
Selecting CD playback modes	17	Selecting the playback modes	52
Prohibiting disc ejection	19	EXTERNAL COMPONENT OPERATIONS ...	55
Changing the display pattern	19	Playing an external component	55
MP3 INTRODUCTION	20	ADDITIONAL INFORMATION	56
What is MP3?	20	TROUBLESHOOTING	57
How are MP3 files recorded and played back?	20	MAINTENANCE	60
MP3 OPERATIONS	22	Handling discs	60
Playing an MP3 disc	22	SPECIFICATIONS	61
Locating a file or a particular portion on an MP3 disc	23		
Selecting a folder and a file using the name lists	25		
Selecting MP3 playback modes	26		
Changing the display pattern	27		

BEFORE USE

***For safety....**

- Do not raise the volume level too much, as this will block outside sounds, making driving dangerous.
- Stop the car before performing any complicated operations.

***Temperature inside the car....**

If you have parked the car for a long time in hot or cold weather, wait until the temperature in the car becomes normal before operating the unit.



LOCATION OF THE BUTTONS

ENGLISH

Control panel

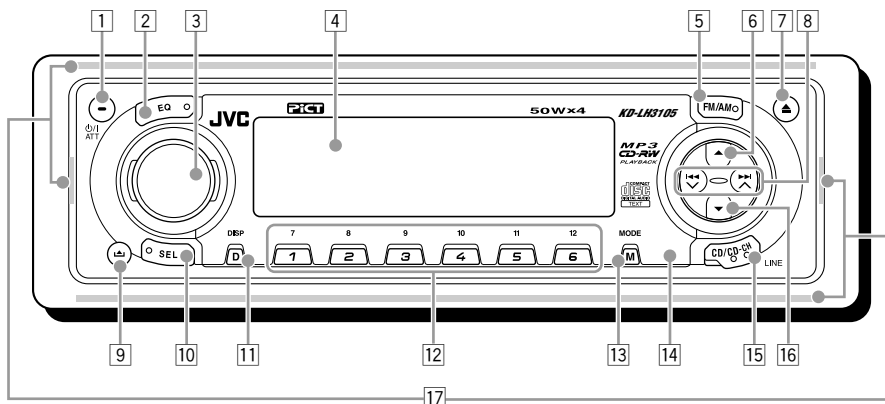

- | | | | |
|---|--------------------------------------|----|-------------------------------------|
| 1 | ⏻/ATT (standby/on/attenuator) button | 10 | SEL (select) button |
| 2 | EQ (equalizer) button | 11 | D (DISP: display) button |
| 3 | Control dial | 12 | Number buttons |
| 4 | Display window | 13 | M (MODE) button |
| 5 | FM/AM button | 14 | Remote sensor |
| 6 | ▲ (up) button | 15 | CD/CD-CH (CD changer) (LINE) button |
| 7 | ▲ (eject) button | 16 | ▼ (down) button |
| 8 | ◀◀ ◻ ▶▶ ▲ buttons | 17 | Trim illumination |
| 9 | ⏻ (control panel release) button | | |

Illumination Navigation for easy operations

If you use M (MODE), EQ (equalizer), or SEL (select), the display and some controls (such as the number buttons, ◀◻▶▶ ▲, ▲/▼, and control dial) enter the corresponding control mode, then the controls start flashing to lead you to the next operational steps. (Illumination Navigation)

- The display shows how these buttons function during this period.

Ex.: When you press number button 1 after pressing M (MODE), to operate the FM tuner.

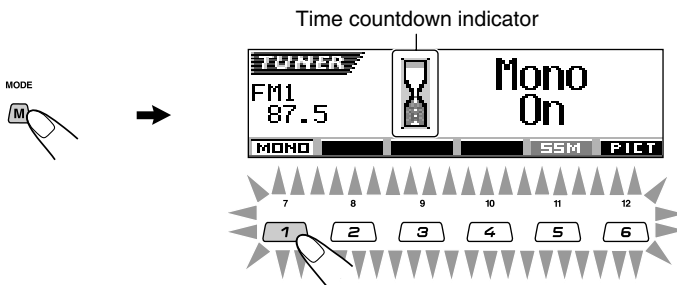

To use these controls for original functions again, wait until the controls stop flashing without using these controls.

- Pressing M (MODE) again also restores original functions. However, pressing SEL (select) or EQ (equalizer) makes the unit into a different mode.



Remote controller

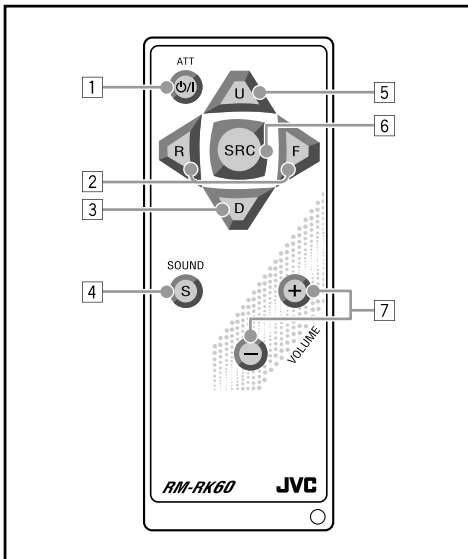

- 1 • Turns on the unit if pressed when the unit is turned off.
 - Turns off the unit if pressed and held for a few seconds.
 - Drops the volume level in a moment if pressed briefly.
Press again to resume the volume.
- 2 • Searches for stations while listening to the radio.
 - Fast-forwards or reverses the track/file if pressed and held while listening to a disc.
 - Skips to the beginning of the next track/file or goes back to the beginning of the current (or previous) tracks/files if pressed briefly while listening to a disc.

- 3 • Selects the preset stations while listening to the radio.
 - Each time you press the button, the preset station number increases, and the selected station is tuned in.
 - Skips to the first file of the previous folder while listening to an MP3 disc.
Each time you press the button, you can move to the previous folder and start playing the first file.
 - While playing an MP3 disc on an MP3-compatible CD changer;
 - Skips to the previous disc if pressed briefly.
 - Skips to the previous folder if pressed and held.

Note: While playing a CD on a CD changer, this always skips to the previous disc.
- 4 Selects the sound mode (iEQ: intelligent equalizer).
 - Each time you press the button, the sound mode (iEQ) changes.
- 5 • Selects the band while listening to the radio.
 - Each time you press the button, the band changes.
 - Skips to the first file of the next folder while listening to an MP3 disc.
Each time you press the button, you can move to the next folder and start playing the first file.
 - While playing an MP3 disc on an MP3-compatible CD changer;
 - Skips to the next disc if pressed briefly.
 - Skips to the next folder if pressed and held.

Note: While playing a CD on a CD changer, this always skips to the next disc.
- 6 Selects the source.
 - Each time you press the button, the source changes.
- 7 Functions the same as the control dial on the main unit.

Note: These buttons do not function for the preferred setting mode adjustment.

Preparing the remote controller

Before using the remote controller:

- Aim the remote controller directly at the remote sensor on the main unit. Make sure there is no obstacle in between.

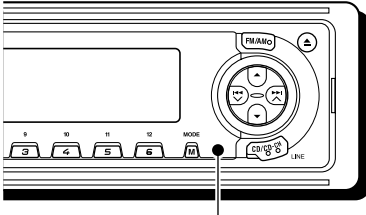

Remote sensor

- Do not expose the remote sensor to strong light (direct sunlight or artificial lighting).

Installing the battery

When the controllable range or effectiveness of the remote controller decreases, replace the battery.

1. Remove the battery holder.

- 1) Push out the battery holder in the direction indicated by the arrow using a ball-point pen or a similar tool.
- 2) Remove the battery holder.

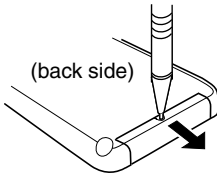

2. Place the battery.

Slide the battery into the holder with the + side facing upwards so that the battery is fixed in the holder.

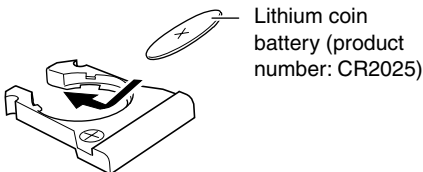

Lithium coin battery (product number: CR2025)

3. Return the battery holder.

Insert again the battery holder by pushing it until you hear a clicking sound.

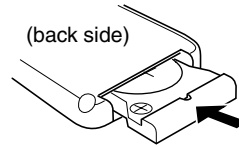

WARNING:

- Store the battery in a place where children cannot reach.
If a child accidentally swallows the battery, consult a doctor immediately.
- Do not recharge, short, disassemble, or heat the battery or dispose of it in a fire.
Doing any of these things may cause the battery to give off heat, crack, or start a fire.
- Do not leave the battery with other metallic materials.
Doing this may cause the battery to give off heat, crack, or start a fire.
- When throwing away or saving the battery, wrap it in tape and insulate; otherwise, the battery may start to give off heat, crack, or start a fire.
- Do not poke the battery with tweezers or similar tools.
Doing this may cause the battery to give off heat, crack, or start a fire.

CAUTION:

DO NOT leave the remote controller in a place (such as dashboards) exposed to direct sunlight for a long time. Otherwise, it may be damaged.

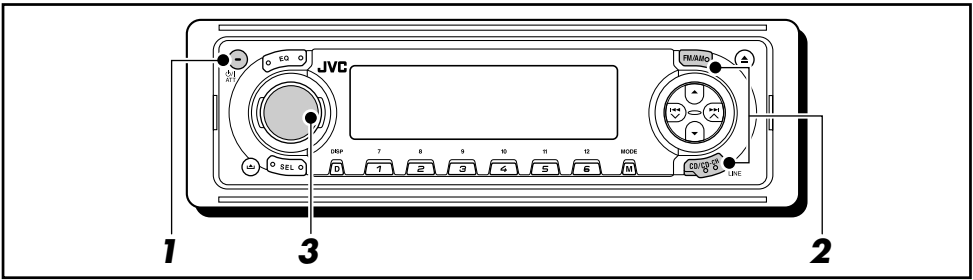

Turning on the power

1 Turn on the power.



Note on One-Touch Operation:

When you select a source in step **2** below, the power automatically comes on. You do not have to press this button to turn on the power.

2 Select the source.

- To operate the tuner, press FM/AM.

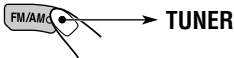

Then, press FM/AM repeatedly to select the band (FM1, FM2, FM3, or AM).

- To operate the CD player (CD), CD changer (CD-CH), or external component (LINE-IN), press CD/CD-CH (LINE) repeatedly.



*1 If there is no disc in the loading slot, you cannot select "CD" as the source, "No Disc" flashes on the display.

*2 Without connecting the CD changer, you cannot select "CD-CH" as the source to play.

3 Adjust the volume.

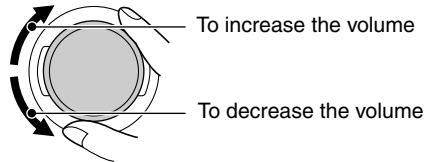

Volume level appears.



Current sound mode (iEQ)
(see page 29)

4 Adjust the sound as you want. (See pages 28 – 31.)

Note:

While playing a source, you can also show the level meter on the display. For details, see "Activating the level meter" on page 31.

NOTICE:

The illustrations of the display used in this manual are mainly of the initial setting when shipped from the factory. If you have changed the display patterns or some PSM items, the actual displays you see will be different.



To drop the volume in a moment

Press **⏻/ATT** briefly while listening to any source. “ATT” starts flashing on the display, and the volume level will drop in a moment.

To resume the previous volume level, press the button briefly again.

- If you turn the control dial, you can also restore the sound.

To turn off the power

Press and hold **⏻/ATT** for more than one second.

- If you turn off the power while listening to a disc, disc play will start from where playback has been stopped previously, next time you turn on the power.

Canceling the display demonstration

When shipped from the factory, display demonstration has been activated, and starts automatically when no operations are done for about 20 seconds.

- It is recommended to cancel the demonstration before you use the unit for the first time.

To cancel the display demonstration, follow the procedure below:

- 1 Press and hold SEL (select) for more than 2 seconds so that one of the PSM items appears on the display. (PSM: see pages 39 and 40.)**



The next-step-operation buttons start flashing.

- 2 Press number button 1 to select “MOVIE”—Movie category of the PSM settings.**

The “Graphics” setting screen appears on the display.

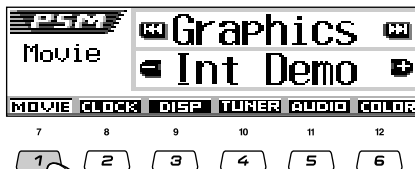

- 3 Select “Off.”**

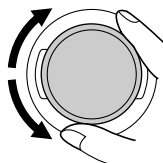

- 4 Finish the setting.**



To activate the display demonstration, repeat the same procedure and select “Int Demo” or “All Demo” in step **3**.

- For more details, see “To show the graphics on the display—Graphics” on page 41.



Setting the clock

You can also set the clock system to either 24 hours or 12 hours.

1 Press and hold SEL (select) for more than 2 seconds so that one of the PSM items appears on the display. (PSM: see pages 39 and 40.)



The next-step-operation buttons start flashing.

2 Press number button 2 to select "CLOCK"—Clock category of the PSM settings.

The "Clock Hr" (hour) setting screen appears on the display.

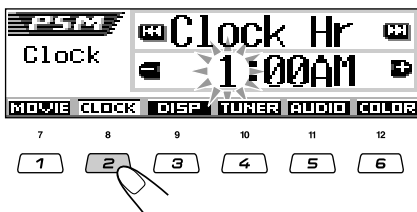

3 Adjust the hour.

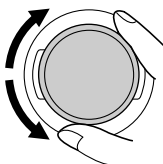

4 Set the minute.

- 1 Select "Clock Min" (minute).
- 2 Adjust the minute.

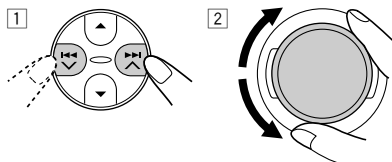

5 Set the clock system.

- 1 Select "24H/12H."
- 2 Select "24Hours" or "12Hours."

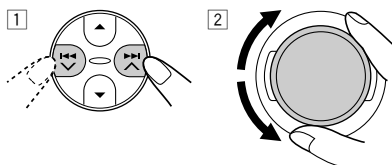

6 Finish the setting.



To check the clock time when the unit is turned off, press D (DISP).



The power turns on and the clock time is shown for about 5 seconds, then the power turns off.



RADIO OPERATIONS

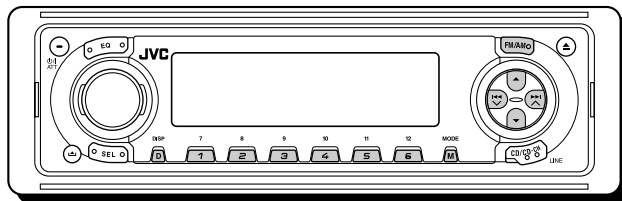

Listening to the radio

You can use either automatic searching or manual searching to tune in to a particular station.

Searching a station automatically: Auto search

1 Select the band (FM1 – 3, AM).



Each time you press the button, the band changes as follows:

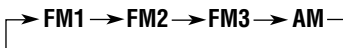

Selected band appears.



Lights up when receiving an FM stereo broadcast with sufficient signal strength.

Note:

This receiver has three FM bands (FM1, FM2, FM3). You can use any one of them to listen to an FM broadcast.

2 Start searching a station.

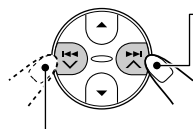

To search stations of higher frequencies

To search stations of lower frequencies

When a station is received, searching stops.

To stop searching before a station is received, press the same button you have pressed for searching.

Searching a station manually: Manual search

1 Select the band (FM1 – 3, AM).



Each time you press the button, the band changes as follows:

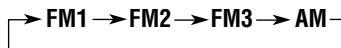

Note:

This receiver has three FM bands (FM1, FM2, FM3). You can use any one of them to listen to an FM broadcast.

2 Press and hold ►► ▲ or ◀◀ ▼ until “Manual Search” starts flashing on the display.

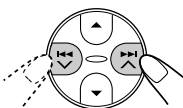

3 Tune in to a station you want while “Manual Search” is flashing.

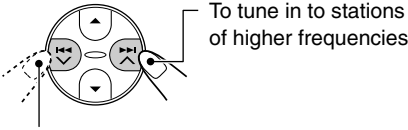

To tune in to stations of lower frequencies

- If you release your finger from the button, the manual mode automatically turns off after about 5 seconds.
- If you hold down the button, the frequency keeps changing (in 50 kHz intervals for FM and 9 kHz for AM) until you release the button.

If the sound quality decreases and the stereo effect is lost while listening to an FM station

In some areas, adjacent stations may interfere with each other. If this interference occurs, this unit can automatically reduce this interference noise (the initial setting when shipped from the factory). However, in this case, the sound quality will be degraded and the stereo effect will also be lost.

If you do not want to degrade the sound quality and to lose the stereo effect, rather than to eliminate the interference noise, see “To change the FM tuner selectivity—IF Filter” on page 42.

When an FM stereo broadcast is hard to receive:

Set the FM reception mode to “Mono On.”

- 1 Press M (MODE) while listening to an FM stereo broadcast.

MODE



“Mode” appears on the display. The next-step-operation buttons start flashing.

- 2 Press number button 1 to select “Mono On” while “Mode” is still on the display. Each time you press the button, “Mono On” or “Mono Off” appears alternately.

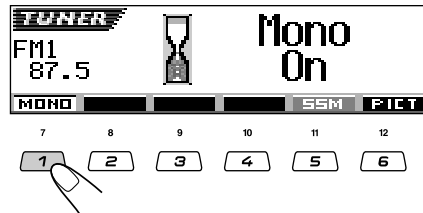

After about 5 seconds

The display returns to the source indication screen.



MONO indicator appears.

The sound you hear becomes monaural but the reception will be improved.



Storing stations in memory

You can use one of the following two methods to store broadcasting stations in memory.

- Automatic preset of FM stations: SSM (Strong-station Sequential Memory)
- Manual preset of both FM and AM stations

FM station automatic preset: SSM

You can preset 6 local FM stations in each FM band (FM1, FM2, and FM3).

1 Select the FM band (FM1 – 3) you want to store FM stations into.



Each time you press the button, the band changes as follows:

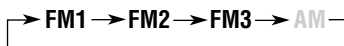

2 Start automatic preset.

- 1 Press M (MODE).

MODE



“Mode” appears on the display. The next-step-operation buttons start flashing.

- 2 Press and hold number button 5 while “Mode” is still on the display.

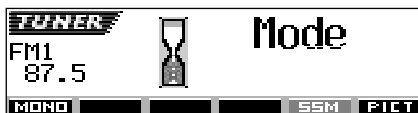

“-SSM-” appears, then disappears when automatic preset is over.

Local FM stations with the strongest signals are searched and stored automatically in the band number you have selected (FM1, FM2, or FM3). These stations are preset in the number buttons—No.1 (lowest frequency) to No.6 (highest frequency).

When automatic preset is over, the station stored in number button 1 will be automatically tuned in.

Manual preset

You can preset up to 6 stations in each band (FM1, FM2, FM3, and AM) manually.

Ex.: Storing FM station of 88.3 MHz into the preset number 1 of the FM1 band.

1 Select the band (FM1 – 3, AM) you want to store stations into (in this example, FM1).



Each time you press the button, the band changes as follows:

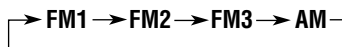

2 Tune in to a station (in this example, of 88.3 MHz).

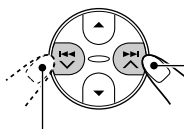

To tune in to stations of higher frequencies

To tune in to stations of lower frequencies



3 Press and hold the number button (in this example, 1) for more than 2 seconds.



The display pattern automatically changes to the small animation display (see page 14). The preset number flashes for about 5 seconds, then the previous display pattern resumes.

4 Repeat the above procedure to store other stations into other preset numbers.

Notes:

- A previously preset station is erased when a new station is stored in the same preset number.
- Preset stations are erased when the power supply to the memory circuit is interrupted (for example, during battery replacement). If this occurs, preset the stations again.

Tuning in to a preset station

You can easily tune in to a preset station. Remember that you must store stations first. If you have not stored them yet, see “Storing stations in memory” on pages 12 and 13.

Selecting a preset station directly

1 Select the band (FM1 – 3, AM).



Each time you press the button, the band changes as follows:

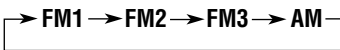

2 Select the number (1 – 6) for the preset station you want.

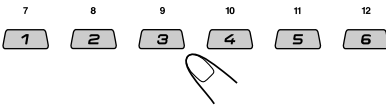

Note:

You can also use the ▲ (up) or ▼ (down) button on the unit to select the next or previous preset stations. Each time you press the ▲ (up) or ▼ (down) button, the next or previous preset station is tuned in.

Selecting a preset station using the preset station list

If you forget what stations are stored in which preset numbers, you can check the preset station list, then select your desired station.

1 Select the band (FM1 – 3, AM).



Each time you press the button, the band changes as follows:

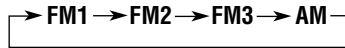

2 Press and hold ▲ (up) or ▼ (down) until the preset station list for the current band (FM1, FM2, FM3, or AM) appears on the display.

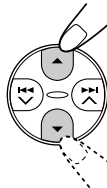

The current station will be highlighted on the display.

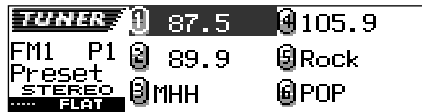

Notes:

- You can show the other FM band preset station lists (FM1, FM2, or FM3) by pressing ▲ (up) or ▼ (down).
- If a name has been assigned to a station (see page 46), it will be shown instead of the station frequency.

3 Select the number (1 – 6) for the preset station you want.

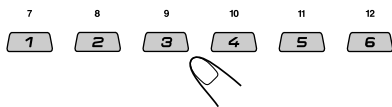



Changing the display pattern

By pressing D (DISP), you can change the information shown on the display.

Each time you press the button, the display patterns change as follows:

DISP



Ex.: When selecting preset station 1 of FM1 band

Large animation display



Current sound mode (iEQ)
(see page 29)

Small animation display 1



Clock time

Clock time display



Small animation display 2

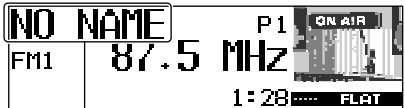

If a name has been assigned to a station it will be shown instead of "NO NAME."

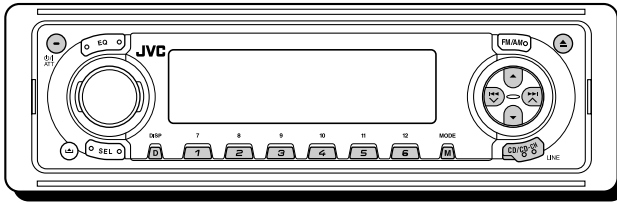

Refer to "MP3 OPERATIONS" on pages 22 to 27 for operating MP3 discs.

Playing a CD

1 Open the control panel.

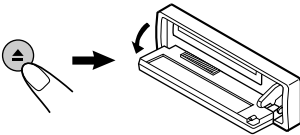

Note on One-Touch Operation:

When a CD is already in the loading slot, pressing CD/CD-CH (LINE) turns on the unit and starts playback automatically.

2 Insert a CD into the loading slot.

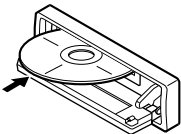

The unit turns on, draws the CD and starts playback automatically.

3 Close the control panel by hand.

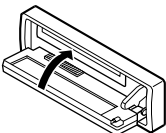

All tracks will be played repeatedly until you stop playback.

The display changes to show the following:

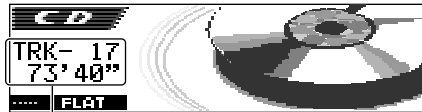

Total track number and total playing time of the inserted CD

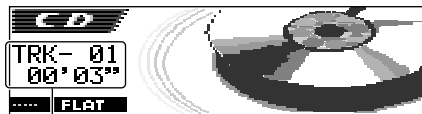

Current track and elapsed playing time

Notes:

- When a CD is inserted upside down, the CD automatically ejects (if the control panel is open). If the control panel is closed, the source changes to the previously selected source, "Please Eject" flashes on the display.
- If there is no CD in the loading slot, you cannot select CD as the source. "No Disc" flashes on the display.



To stop play and eject the CD

Press ▲.

CD play stops and the control panel flips down. The CD automatically ejects from the loading slot. The source changes to the previously selected source.

- If you change the source or turn the power off, CD play also stops (without ejecting the CD). Next time you select "CD" as the source or turn the power on, CD play starts from where playback has been stopped previously.

Notes:

- *If the ejected disc is not removed for about 15 seconds, the disc is automatically inserted again into the loading slot to protect it from dust. (Disc play will not start this time.)*
- *You can eject the disc even when the unit is turned off.*

Locating a track or a particular portion on a CD

To fast-forward or reverse the track

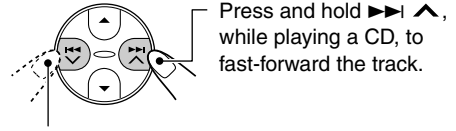

Press and hold ◀◀ ▼, while playing a CD, to reverse the track.

To go to the next or previous tracks

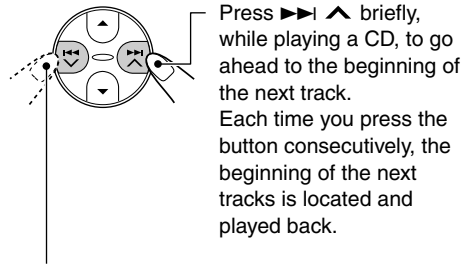

Press ◀◀ ▼ briefly, while playing a CD, to go back to the beginning of the current track. Each time you press the button consecutively, the beginning of the previous tracks is located and played back.

To go to a particular track directly

Press the number button corresponding to the track number to start its playback.

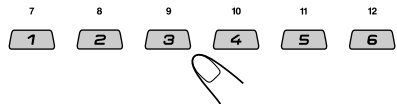

- To select a track number from 01 – 06: Press 1 (7) – 6 (12) briefly.
- To select a track number from 07 – 12: Press and hold 1 (7) – 6 (12) for more than one second.



To go to a track quickly

- 1 Press M (MODE) while playing a CD.

MODE
 "Mode" appears on the display.
 The next-step-operation buttons start flashing.

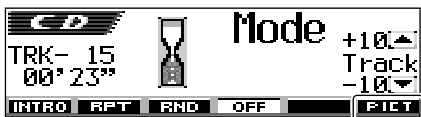

See page 33 for this function.

- 2 Press ▲ (up) or ▼ (down) while "Mode" is still on the display.

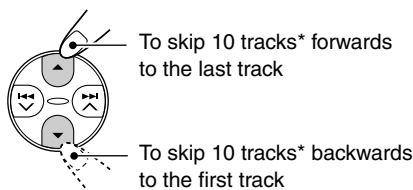

* The first time you press ▲ (up) or ▼ (down) button, the track skips to the nearest higher or lower track with a track number of multiple ten (ex. 10th, 20th, 30th).

Then, each time you press the button, you can skip 10 tracks (see "How to go to the desired track quickly" below).

- After the last track, the first track will be selected, and vice versa.

How to go to the desired track quickly

- Ex. 1: To select track number 32 while playing track number 6

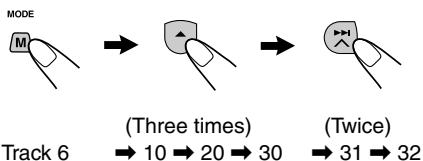

- Ex. 2 : To select track number 8 while playing track number 36

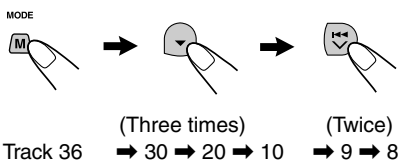

Selecting CD playback modes

To play back tracks at random (Disc Random Play)

You can play back all tracks on the CD at random.

- 1 Press M (MODE) while playing a CD.

MODE
 "Mode" appears on the display.
 The next-step-operation buttons start flashing.

- 2 Press number button 3 to select "Random Disc" while "Mode" is still on the display. Each time you press the button, "Random Disc" or "Random Off" appears alternately.

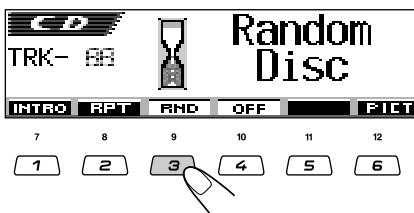

When disc random play is turned on, the  RND (disc random) indicator lights up on the display. A track randomly selected starts playing.

To cancel disc random play, select "Random Off" by pressing number button 3 or press number button 4 in step 2.



To play back tracks repeatedly (Track Repeat Play)

You can play back the current track repeatedly.

- 1 Press M (MODE) while playing a CD.



"Mode" appears on the display. The next-step-operation buttons start flashing.

- 2 Press number button 2 to select "Repeat Track" while "Mode" is still on the display. Each time you press the button, "Repeat Track" or "Repeat Off" appears alternately.

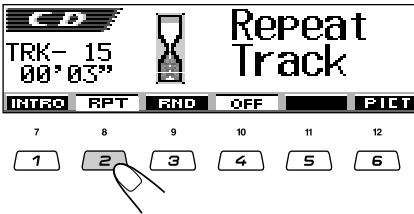

When track repeat play is turned on, the **RPT** (track repeat) indicator lights up on the display. The current track starts playing repeatedly.

To cancel track repeat play, select "Repeat Off" by pressing number button 2 or press number button 4 in step 2.

To play back only intros (Track Intro Scan)

You can play back the first 15 seconds of each track sequentially.

- 1 Press M (MODE) while playing a CD.



"Mode" appears on the display. The next-step-operation buttons start flashing.

- 2 Press number button 1 to select "Intro Track" while "Mode" is still on the display. Each time you press the button, "Intro Track" or "Intro Off" appears alternately.

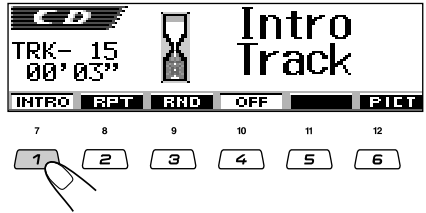

When track intro scan is turned on, the **INT** (track intro) indicator lights up on the display. The first 15 seconds of each track is played sequentially.

To cancel track intro scan, select "Intro Off" by pressing number button 1 or press number button 4 in step 2.



Prohibiting disc ejection

You can prohibit disc ejection and can lock a disc in the loading slot.

While pressing CD/CD-CH (LINE), press and hold Φ /I/ATT for more than 2 seconds.

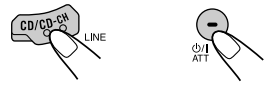

“No Eject” flashes on the display for about 5 seconds, and the disc is locked and cannot be ejected.



To cancel the prohibition and unlock the disc

While pressing CD/CD-CH (LINE), press and hold Φ /I/ATT again for more than 2 seconds.

“Eject OK” flashes on the display for about 5 seconds, and the disc is unlocked.



Changing the display pattern

By pressing D (DISP), you can change the information shown on the display.

- If the information cannot be shown at a time, it will scroll on the display.
- Some characters or symbols will not be shown (will be blanked or substituted) on the display.



Each time you press the button, the display patterns change as follows:

Ex.: While playing a CD Text:



Notes:

- When the disc title/performer is shown, the (disc) indicator lights up. When the track title is shown, the (track) indicator lights up.
- If no name is assigned to the audio CD, “NO NAME” will appear. To assign a name to an audio CD, see page 46.
- If no disc title/performer or no track title is recorded for the CD Text, “NO NAME” will appear.



MP3 INTRODUCTION

What is MP3?

MP3 is an abbreviation of Motion Picture Experts Group (or MPEG) Audio Layer 3. MP3 is simply a file format with a data compression ratio of 1:10 (128 Kbps*). That means, by using MP3 format, one CD-R or CD-RW can contain 10 times as much data volume as a regular CD can.

- For details information about the MP3 discs, refer to “A Guide to MP3/WMA” (separate volume).

* Bit rate is the average number of bits that one second of audio data will consume. The unit used is Kbps (1024 bits/second). To get a better audio quality, choose a higher bit rate. The most popular bit rate for encoding is 128 Kbps.

This unit is incorporated with an MP3 decoder. You can play back MP3 files (tracks) recorded on CD-Rs, CD-RWs, and CD-ROMs.

Compatible with ID3 Tag

Extra information data such as album title, performer name, song title, recording year, music genre and a brief comment can be stored within an MP3 file.

This unit can show both ID3v1 (Version 1) and ID3v2 (Version 2) tags on the display. (See page 27.)

- Some characters cannot be shown correctly.
- If both ID3v1 and ID3v2 are recorded on a disc, ID3v2 information will be shown.

Precautions when recording MP3 files on a CD-R or CD-RW

This unit can only read MP3 files that are recorded in the format that is compliant with ISO 9660 Level 1, Level 2, Romeo, or Joliet.

How are MP3 files recorded and played back?

MP3 “files (tracks)” can be recorded in “folders” —in PC terminology.

During recording, the files and folders can be arranged in a way similar to arranging files and folders of computer data.

“Root” is similar to the root of a tree. Every file and folder can be linked to and be accessed from the root.

Playback order, file search order, and folder search order of the MP3 files recorded on a disc are determined by the writing (or encoding) application; therefore, playback order may be different from the one you have intended while recording the folders and the files.

The illustration on the next page shows an example of how MP3 files are recorded on a CD-R or CD-RW, how they are played back, and how they are searched for on this unit.

Notes:

- *The unit can read a CD-ROM containing MP3 files. However, if non-MP3 files are recorded together with MP3 files, this unit will take a longer time to scan the disc. It may also cause the unit to malfunction.*
- *The unit cannot read or play an MP3 file without the extension code—mp3.*
- *This player is not compatible with the data encoded with Layer 1 and Layer 2 formats.*
- *The unit is not compatible with Playlist**.*

**A playlist is a simple text file, used on a PC, which enables users to make their own playback order without physically rearranging the files.



MP3 folder/file configuration

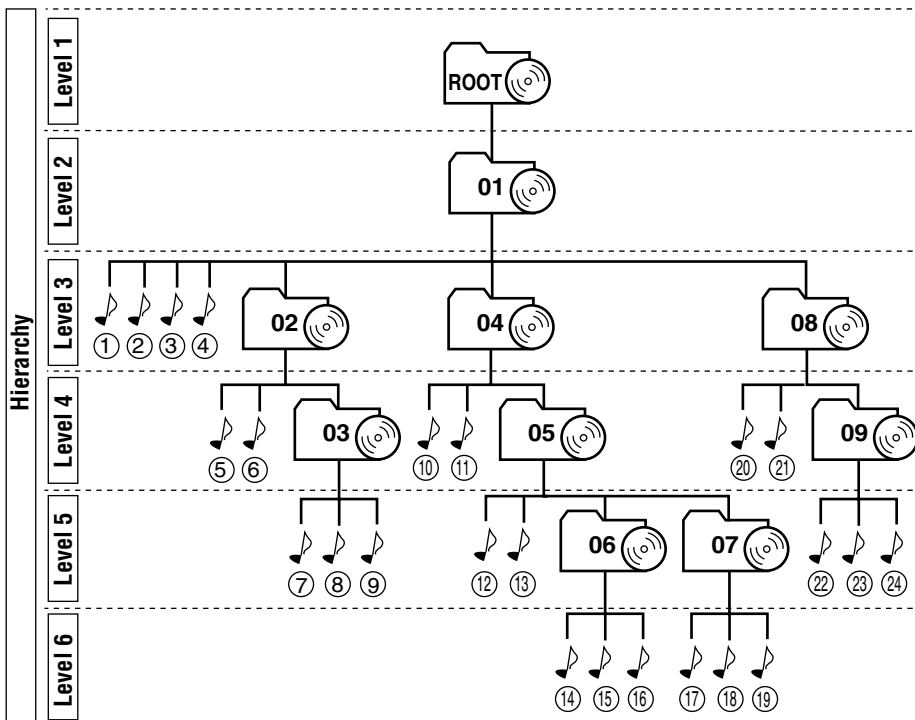

	: Root
	: Folders
	: MP3 files

Note:

There is no limit on the number of the hierarchy levels (nested folders). However, up to 8 hierarchy levels is recommended for stable operations.

MP3 playback/search order

- The numbers in circles below the MP3 files () indicate the playback order and search order of the MP3 files. Normally, this unit plays back MP3 files in the recorded order.
- The numbers inside the folders indicate the playback order and search order of the folders on an MP3 disc. Normally, this unit plays back MP3 files in the folders in the recorded order.

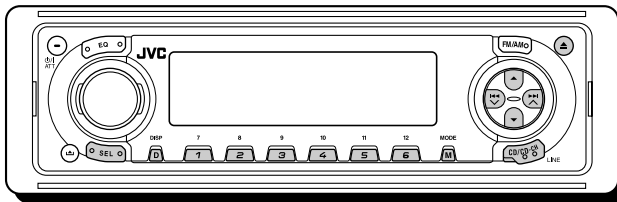

Refer also to "CD OPERATIONS" on pages 15 to 19.

Playing an MP3 disc

1 Open the control panel.

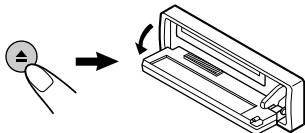

Note on One-Touch Operation:

When a disc is already in the loading slot, pressing CD/CD-CH (LINE) turns on the unit and starts playback automatically.

2 Insert an MP3 disc into the loading slot.

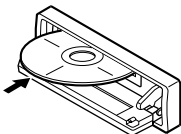

The unit turns on, draws the disc and starts playback automatically.

3 Close the control panel by hand.

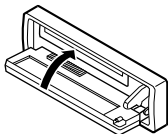

All files will be played repeatedly until you stop playback.

The display changes to show the following:

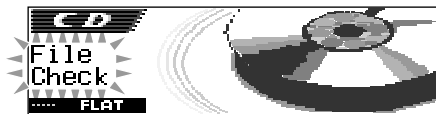

Total folder and file number

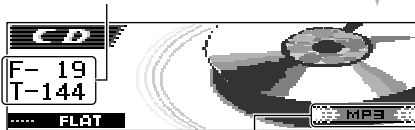

MP3 indicator

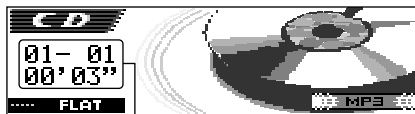

Current folder/file and elapsed playing time

Ex.: When the disc contains 19 folders and 144 MP3 files

Notes:

- MP3 discs require a longer readout time. (It differs due to the complexity of the folder/file configuration.)
- If you change the source or turn the power off, disc playback stops (without ejecting the disc). Next time you select the CD player as the source or turn the power on, disc play starts from where playback has been stopped previously.

To stop play and eject the disc

Press ▲.

Playback stops and the control panel flips down. The disc automatically ejects from the loading slot.

What is ImageLink?

When an MP3 folder includes an image <jml> file edited by Image Converter (supplied in the CD-ROM), you can show the image on the display while the files in the folder are played back.

- While reading an image <jml> file, no sounds come out (the preset image of a coffee cup is shown on the display during this period).

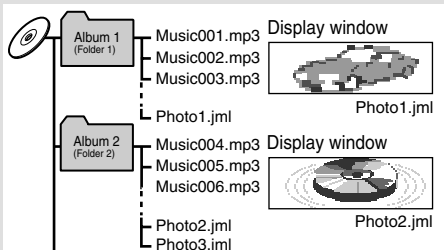

If there are more than one <jml> file in a folder, a <jml> file with younger playback order number will be shown on the display (in the above example, "Photo2.jml" will be used for Album 2).

To activate ImageLink, follow the procedure below:

- See also "Changing the general settings (PSM)" on page 39.
- 1 Press and hold SEL (select) for more than 2 seconds so that one of the PSM items appears on the display.
 - 2 Press number button 1 to select "MOVIE"—Movie category of the PSM settings. The "Graphics" setting screen appears on the display.
 - 3 Turn the control dial to select "ImageLink."
 - 4 Press SEL (select) to finish the setting. ImageLink starts functioning when the next folder starts playing.

Note:

- ImageLink will not work in the following cases:
- If no <jml> file is included in an MP3 folder.
 - If Intro Scan is activated,
 - If the source is changed to any other than "CD," or
 - If you turn off then on the unit while the preset image of a coffee cup is shown on the display.

Locating a file or a particular portion on an MP3 disc

For "MP3 playback/search order" see page 21.

To fast-forward or reverse the file

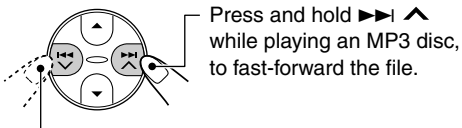

Press and hold **▶▶▶** **^** while playing an MP3 disc, to fast-forward the file.

Press and hold **◀◀◀** **v** while playing an MP3 disc, to reverse the file.

Note:

During this operation, you can only hear intermittent sounds. (The elapsed playing time also changes intermittently on the display.)

To skip to the next or previous files

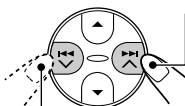

Press **▶▶▶** **^** briefly while playing, to skip ahead to the beginning of the next file. Each time you press the button consecutively, the beginning of the next files is located and played back.

Press **◀◀◀** **v** briefly while playing, to skip back to the beginning of the current file. Each time you press the button consecutively, the beginning of the previous files is located and played back.

To go to a particular file quickly within the current folder

- 1 Press M (MODE) while playing an MP3 disc.



"Mode" appears on the display. The next-step operation buttons start flashing.

2 Press ▲ (up) or ▼ (down) while “Mode” is still on the display.

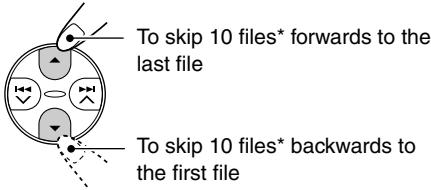

* The first time you press ▲ (up) or ▼ (down) button, the file skips to the nearest higher or lower file with a file number of multiple ten (ex. 10th, 20th, 30th).

Then, each time you press the button, you can skip 10 files (see “How to go to the desired file quickly” below).

- After the last file, the first file will be selected, and vice versa.

How to go to the desired file quickly

- Ex. 1: To select file number 32 while playing file number 6

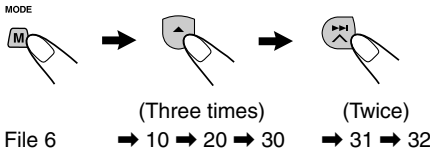

- Ex. 2: To select file number 8 while playing file number 36

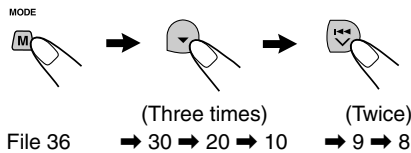

To go to a particular folder directly

IMPORTANT:

To directly select the folders using the number button(s), it is required that folders are assigned 2 digit numbers at the beginning of their folder names. (This can only be done during the recording of CD-Rs or CD-RWs.)

Ex.: If folder name is “01 ABC”

→ Press 1 to go to Folder 01 ABC.

If folder name is “1 ABC,” pressing 1 does not work.

If folder name is “12 ABC”

→ Press and hold 6 (12) to go to Folder 12 ABC.

Press the number button corresponding to the folder number to start playing the first file in the selected folder.

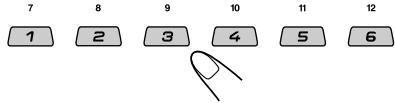

- To select a folder number from 01 – 06: Press 1 (7) – 6 (12) briefly.
- To select a folder number from 07 – 12: Press and hold 1 (7) – 6 (12) for more than one second.

Notes:

- If “No Music” appears on the display after you have selected a folder, it means that the folder does not contain any MP3 files.
- You cannot directly select a folder with a number greater than 12.

To select a particular file in a folder, press

▶▶▲ or ◀◀▼ after selecting the folder.

To skip to the next or previous folder

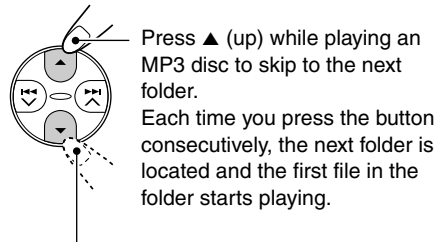

Press ▼ (down) while playing an MP3 disc to skip back to the previous folder.

Each time you press the button consecutively, the previous folder is located and the first file in the folder starts playing.

Note:

If the folder does not contain any MP3 files, it is skipped.

Selecting a folder and a file using the name lists

You can show the folder name and file name lists on the display while playing an MP3 disc. Then, select a folder or a file you want to start playback with.

Selecting a folder and start playback

- 1 Press and hold ▲ (up) or ▼ (down) so that the folder list of the inserted disc appears on the display.

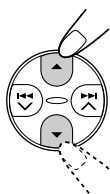

The current playing folder will be highlighted on the display.

Current folder number



Notes:

- The display can show only six names at a time. You can show the other names on the next lists by pressing ▲ (up) or ▼ (down).
- If you press ►► ▲ or ◀◀ ▼, the file name list of the current playing folder appears. Each time you press the button, the folder name list and file name list appear alternately.
- Only folders with MP3 files will be listed.

- 2 Select the number (1 – 6) for the folder you want to play.

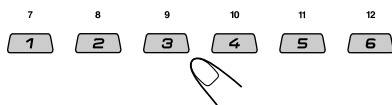

Selecting a file and start playback

- 1 Press and hold ▲ (up) or ▼ (down) so that the folder list of the inserted disc appears on the display.

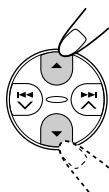

The current playing folder will be highlighted on the display.

Current folder number



- 2 Press ►► ▲ or ◀◀ ▼ to show the file list of the current folder.

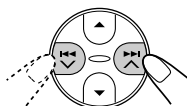

The current playing track will be highlighted on the display.

Current file number

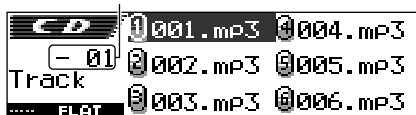

Each time you press the button, the folder name list and file name list appear alternately.

Note:

The display can show only six names at a time. You can show the other names on the next lists by pressing ▲ (up) or ▼ (down).

- 3 Select the number (1 – 6) for the file you want to play.

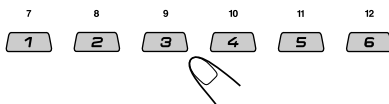

Selecting MP3 playback modes

To play back files at random (Random Play)

You can play back all files of the current folder or all files on the MP3 disc at random.

- 1 Press M (MODE) while playing an MP3 disc.



“Mode” appears on the display.
The next-step-operation buttons start flashing.

- 2 Press number button 3 repeatedly while “Mode” is still on the display.

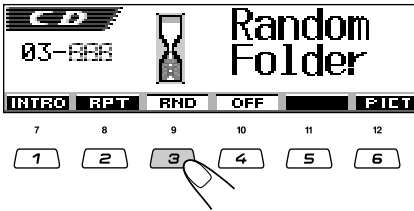

Ex.: When you select “Random Folder”

Each time you press the button, the random play mode changes as follows:



Mode	Active indicator	Plays at random
Random Folder	RND (folder random) indicator lights up.	All files of the current folder, then files of the next folder and so on.
Random Disc	RND (disc random) indicator lights up.	All files on the disc.

To cancel Random Play, select “Random Off” by pressing number button 3 repeatedly or press number button 4 in step 2.

To play back files repeatedly (Repeat Play)

You can play back the current file or all the files in the current folder repeatedly.

- 1 Press M (MODE) while playing an MP3 disc.



“Mode” appears on the display.
The next-step-operation buttons start flashing.

- 2 Press number button 2 repeatedly while “Mode” is still on the display.

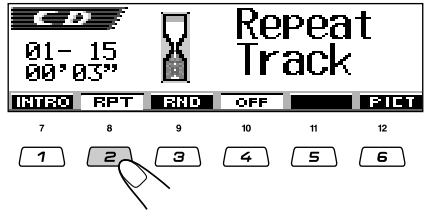

Ex.: When you select “Repeat Track”

Each time you press the button, the repeat play mode changes as follows:



Mode	Active indicator	Plays repeatedly
Repeat Track	RPT (file repeat) indicator lights up.	The current (or specified) file.
Repeat Folder	RPT (folder repeat) indicator lights up.	All files of the current (or specified) folder of the disc.

To cancel repeat play, select “Repeat Off” by pressing number button 2 repeatedly or press number button 4 in step 2.

To play back only intros (Intro Scan)

You can play back the first 15 seconds of each file sequentially.

- 1 Press M (MODE) while playing an MP3 disc.



“Mode” appears on the display.
The next-step-operation buttons start flashing.

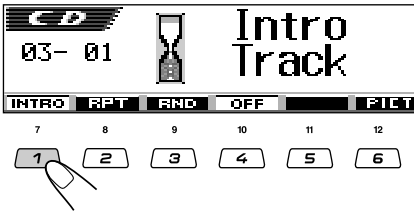

2 Press number button 1 repeatedly while "Mode" is still on the display.



Ex.: When you select "Intro Track"

Each time you press the button, the intro scan mode changes as follows:



Mode	Active indicator	Plays the beginnings (15 seconds) of
Intro Track	 INT (file intro) indicator lights up.	All files on the disc.
Intro Folder	 INT (folder intro) indicator lights up.	The first file of every folder of the disc.

To cancel intro scan, select "Intro Off" by pressing number button 1 repeatedly or press number button 4 in step 2.

Changing the display pattern

By pressing D (DISP), you can change the information shown on the display.

- If the information cannot be shown at a time, it will scroll on the display.

Some characters or symbols will not be shown (will be blanked or substituted) on the display.





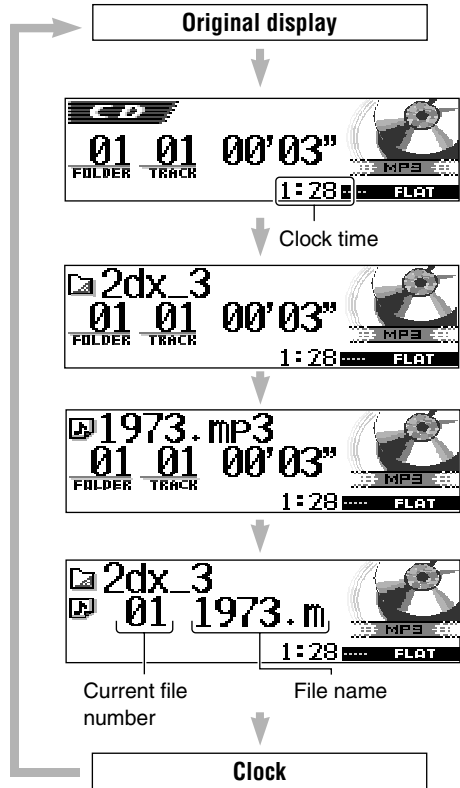

Each time you press the button, the display patterns change as follows:

Ex.: While playing an MP3 disc:



The above diagram shows the examples of the display when "Tag" is set to "Off."

Notes:

- When the folder name is shown, the  (folder) indicator lights up. When the file name is shown, the  (file) indicator lights up.
- If "Tag" is set to "On" (see page 42), ID3 tag information will appear on the display if the disc has an ID3 tag.
The album name/performer with  (disc) indicator appear on the display instead of the folder name; while track title with  (track) indicator appear instead of the file name.



SOUND ADJUSTMENTS

Adjusting the sound

You can set the speaker output balance, subwoofer output level, and input level of each source.

- There is a time limit in doing the following procedure. If the setting is canceled before you finish, start from step 1 again.

1 Select the item you want to adjust.



The next-step-operation buttons start flashing. Each time you press the button, the adjustable items change as follows:

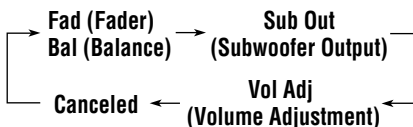

Indication	To do:	Range
Fad	Adjust the front and rear speaker balance.	R06 (Rear only) F06 (Front only)
Bal	Adjust the left and right speaker balance.	L06 (Left only) R06 (Right only)
Sub Out	Adjust the subwoofer output level and cutoff frequency level.	00 (min.) 08 (max.) Low/Mid/High
Vol Adj	Adjust and store the input level of each source.	-12 (min.) +12 (max.)

2 Make adjustments.

- **To adjust fader and balance—Fad, Bal:**
You can make these two adjustments at the same time.
- If you are using a two-speaker system, set the fader level to "00."

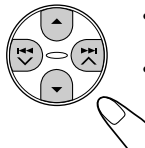

- Press ▲ (up) or ▼ (down) to adjust the fader.
- Press ►► ▲ or ◀◀ ▼ to adjust the balance.



- **To adjust subwoofer output—Sub Out:**
This takes effect only when a subwoofer is connected.

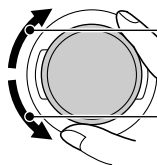

To increase the level

To decrease the level



You can also set an appropriate cutoff frequency level according to the subwoofer connected.

- Press ►► ▲ or ◀◀ ▼ to select "Low," "Mid," or "High."
- Low: Frequencies higher than 50 Hz are cut off to the subwoofer.
- Mid: Frequencies higher than 80 Hz are cut off to the subwoofer.
- High: Frequencies higher than 115 Hz are cut off to the subwoofer.

- **To adjust the input level of each source —Vol Adj:**

This setting is required for each source except FM. Before making an adjustment select an appropriate source for which you want to make an adjustment.

Once you have adjusted it, it is memorized, and you will not need to adjust the volume level each time you change the source.

Adjust the input level to match the FM sound level.

- You cannot make an adjustment if the source is FM. "FIX" will appear.

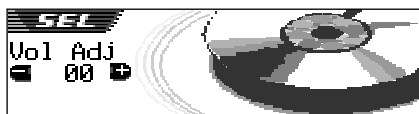
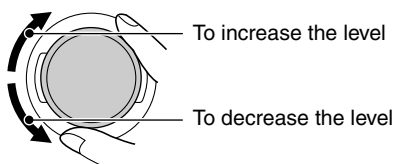

Selecting preset sound modes (iEQ: intelligent equalizer)

You can select a preset sound mode (iEQ: intelligent equalizer) suitable to the music genre.

- There is a time limit in doing the following procedure. If the setting is canceled before you finish, start from step 1 again.

Available sound modes:

FLAT (No sound mode is applied)
H.ROCK (Hard Rock)
R & B (Rhythm and Blues)
POP (Popular music)
JAZZ (Jazz music)
DANCE (Dance music)
Country (Country music)
REGGAE (Reggae)
CLASSIC (Classical music)
USER 1, USER 2, USER 3

1 Press EQ (equalizer).



The last selected sound mode is called up.

The next-step-operation buttons start flashing.



Ex.: If you have selected "Flat" previously



2 Press the number button to select the sound mode you want.

- This unit has two sound mode selection screens. To move to the other screen, press ▲ (up) or ▼ (down).

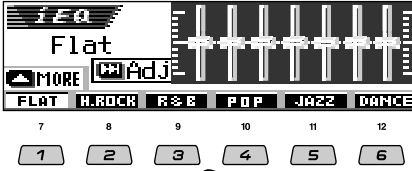

Press ▲ (up) or ▼ (down).

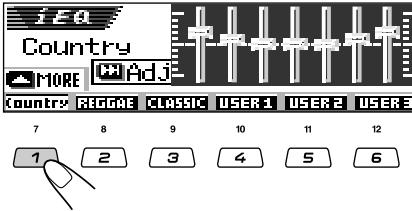

Ex.: When you press number button 1 to select "Country"

To cancel the sound mode, select "FLAT" in step 2.

Note:

For details about the preset settings of each sound mode, see page 56.

To exit from the sound mode selection screen, press EQ (equalizer) repeatedly or wait for about 5 seconds.

Storing your own sound modes

You can adjust the sound modes to your preference and store your own adjustments in memory (USER 1, USER 2, and USER 3).

- There is a time limit in doing the following procedure. If the setting is canceled before you finish, start from step 1 again.

1 Press EQ (equalizer).



The last selected sound mode is called up. The next-step-operation buttons start flashing.

2 Select the sound mode you want to adjust.

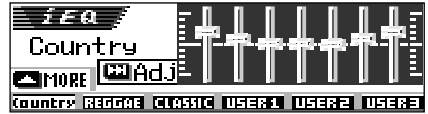

Ex.: When you select "Country"

3 Enter the sound adjustment mode.

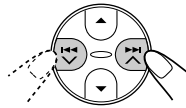

The following sound mode adjustment screen appears on the display.

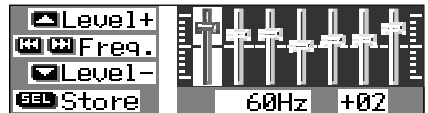

4 Make adjustments as you like.

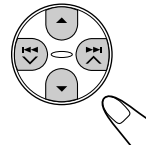

- Press ►► ▲ or ◀◀ ▼ to select the frequency band—60Hz, 150Hz, 400Hz, 1kHz, 2.4kHz, 6kHz, 12kHz.

2) Press ▲ (up) or ▼ (down) to adjust the level of the selected band within the range of -05 to +05.

3) Repeat steps 1) and 2) to adjust the other frequency bands.

5 Store the adjustment you made.



The confirmation message appears—whether you want to store the adjustment.

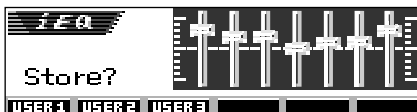

If you want to cancel the adjustments, press EQ (equalizer).

- Adjustment you made remains effective until you select another sound mode.

6 Select one of the user sound modes (USER 1, USER 2, or USER 3) you want to store into.

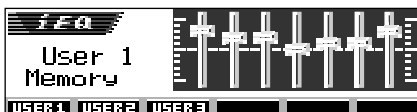
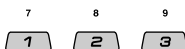

Ex.: When you select "User 1"

1 Press EQ (equalizer) twice.



The last selected level meter appears on the display. The next-step-operation button starts flashing.

2 Select the level meter pattern you want.

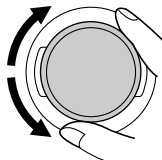

As you turn the control dial, the level meters change as follows:

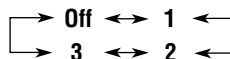

Standard:

No level meter appears on the display. (Initially selected when shipped from the factory.)

Meter 1:

The audio level meter fluctuates vertically.

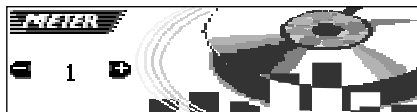

Meter 2:

The speaker on the display vibrates as input audio level changes.

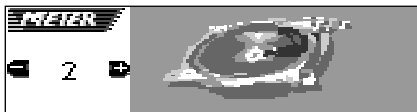

Meter 3:

The left and right audio level meters appear.

- If the small animation display is selected, only one audio level meter can be shown.



Activating the level meter

You can show the level meters on the display while playing any source. This unit is equipped with three level meter patterns.

- There is a time limit in doing the following procedure. If the setting is canceled before you finish, start from step 1 again.

With the supplied Image Converter CD-ROM, you can edit your own favorite pictures and use them as the opening screen, ending screen, and graphic screen while playing a source.



What is Image Converter?

Image Converter is a JVC's original software to produce customize images to be shown on your JVC Car Audio.

Here is a basic procedure to make a CD-R including still images (pictures) and animations (movies) using Image Converter

In this manual, we only explain how to export the files (still images and animations) into the built-in memory of this unit—step 5 below.

- For the other processes (from steps 1 to 4 below), refer to Image Converter manual (PDF files included in the "Manual" folder of the supplied CD-ROM).

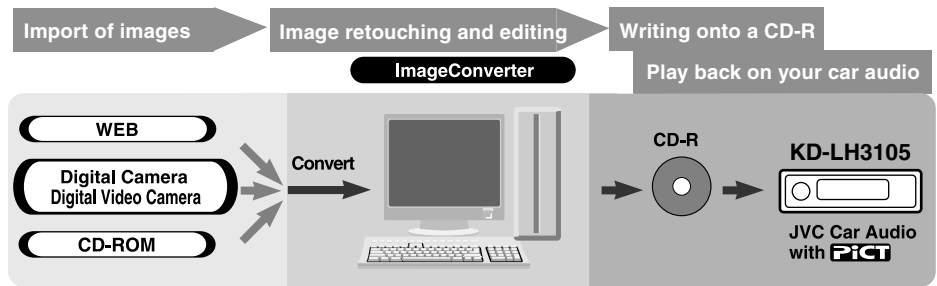

1 Install / Start the program

Install Image Converter on your PC.

2 Import the images

Import the source images from the Image Converter CD-ROM or from other equipment like a digital camera or a digital video camera.

3 Retouch and edit the images

Retouch the images like trimming or adjusting color, editing the animation effect, and adding the texts.

4 Write your images onto a CD-R

Write the animations or the still images you made with Image Converter using your CD-R writing software.

You have to write the images you made onto a CD-R to enjoy the images on your Car Audio.

- To write data onto a CD-R, refer also to the instruction of your CD-R writing software.

5 Enjoy the animations or the still images you made on your Car Audio

Export the images to your JVC Car Audio from the CD-R you made.

Downloading images and animations

Before starting the following procedure, prepare a CD-ROM including still images (pictures) and animations (movies).

- The supplied Image Converter CD-ROM includes sample images and animations, so you can use this disc as your first trial.

IMPORTANT:

- Still images (pictures) should have <jml>, and animations (movies) should have <jma> as their extension code in their file names.
- Downloading a file can be done only while selecting "CD" as the source; on the other hand, deleting a file can be done while selecting any source.
- Before you download or erase the files, observe the following:
 - Do not download a file while driving.
 - Do not turn off the ignition key of the car while downloading or erasing a file*.
 - Do not detach the control panel while downloading or erasing a file*.
- * If you do it, the file download and erasure will not be done correctly. In this case, perform the same procedure again.
- If you have already downloaded an animation for "PowerOn," "PowerOff," or "Movie," downloading a new animation deletes the previously stored animation.
- It takes a long time for the unit to download an animation.
 - About 6 to 7 seconds for a still image (one frame).
 - About 3 to 4 minutes for an animation of 30 frames.
 - About 10 minutes for an animation of 90 frames.

1 Open the control panel.

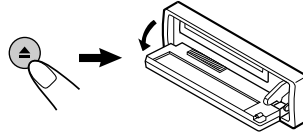

2 Insert a CD-ROM with the files (images and animations) into the loading slot.

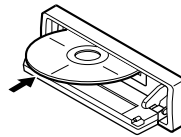

The unit turns on and draws the disc.

- If the disc includes playable audio files such as MP3 files, playback starts automatically.

3 Press M (MODE) after the disc is detected.



"Mode" appears on the display. The next-step-operation buttons start flashing.



4 Press number button 6 to show the download selection screen.



CONTINUED ON THE NEXT PAGE

5 Select (highlight) one of the listed items for which you want to download a file.

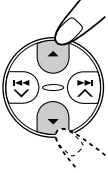

- **PowerOn** : Opening screen
To download an animation to be shown after the unit is turned on. (You can store only one animation consisting of a maximum of 30 frames.)
- **PowerOff** : Ending screen
To download an animation to be shown before the unit is turned off. (You can store only one animation consisting of a maximum of 30 frames.)
- **Picture** : Graphic screen*
To download a still image to be shown while playing a source. (You can store 90 frames of still images—one frame each.)
- **Movie** : Graphic screen*
To download an animation to be shown while playing a source. (You can store only one animation consisting of a maximum of 90 frames.)

* Graphic screen will appear only if no operation is done for about 20 seconds.

If you want to cancel the procedure, press number button 5, the download selection screen goes off.

6 Show the name list of the folder included in the inserted CD-R.

7 "File Check..." appears for a while, then the folder list appears.

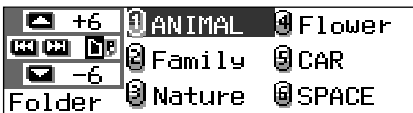

The currently selected folder will be highlighted on the display.

Notes:

- On this list, the folders including the target files—<jml> files for "Picture" and <jma> files for the others—are shown.
- The display can show only six names at a time. You can show the other names on the next lists by pressing ▲ (up) or ▼ (down).
- If a disc inserted does not include any <jml> and <jma> files, beeps sound and you cannot go to the next step.

7 Select (highlight) a folder in which a file you want is included.

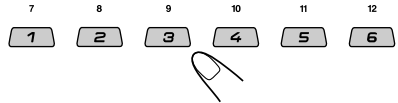

8 Show the name list of the files included in the selected folder.

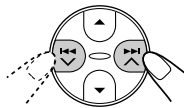

Each time you press the button, the lists on the display changes as follows:

Folder name list ↔ **File name list**

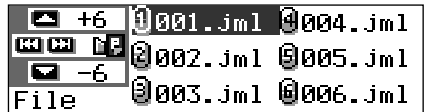

Ex.: When you have selected "Picture" in step 5

Note:

The display can show only six names at a time. You can show the other names on the next lists by pressing ▲ (up) or ▼ (down).

9 Select (highlight) a file you want to download.

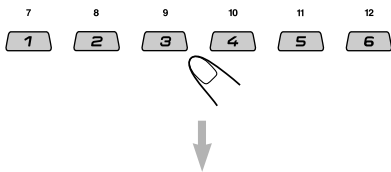

The file name appears, and the unit will ask you "Download OK?"

10 If it is OK, press number button 1 to start downloading.

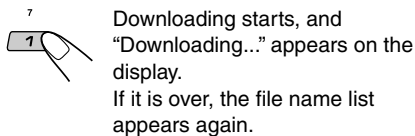

If it is not OK, press number button 5, the file selection screen appears again. Repeat from step 8 again.

11 Repeat steps 8 to 10 if you are downloading files for "Picture" and want to store more files.

12 Finish the download procedure.



To download a file for another item listed on the download selection screen, repeat from step 3 again.

Notes:

- If you try to store the 91st image for picture screen, "Picture Full" appears and you cannot start downloading. In this case, delete unwanted files before downloading.
- If the total frame number of the downloaded animations exceeds the following number, the exceeding frames are ignored.
 - For opening and ending screens: 30 frames
 - For movie screen: 90 frames

Deleting unwanted files

- When "BACK" is shown on the display above number button 5, you can go back to the previous screen by pressing number button 5.

To delete all the stored files at a time

- 1 Press M (MODE) while playing any source.

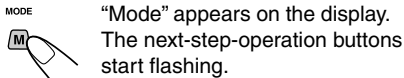

- 2 Press number button 6 to show the download selection screen.



- 3 Press ▲ (up) or ▼ (down) to select (highlight) all the listed items.



- 4 Press number button 4.

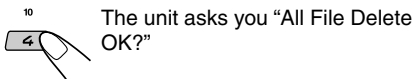

- 5 Press number button 4 again.

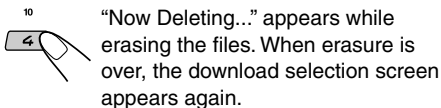

- 6 Press number button 5 to resume the source indication screen.



To delete the files stored for “PowerOn,” “PowerOff,” “Picture (all stored images at a time),” and “Movie”

- 1 Press M (MODE) while playing any source.

MODE



“Mode” appears on the display. The next-step-operation buttons start flashing.

- 2 Press number button 6 to show the download selection screen.

12



- 3 Press ▲ (up) or ▼ (down) to select (highlight) one of the listed items.

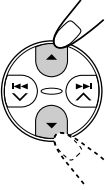

Appears when “Picture” is selected (highlighted)

- 4 To delete the file stored in “PowerOn,” “PowerOff,” and “Movie,” press number button 3.

9



The file name of the previously stored animation appears, and the unit asks you “Delete OK?”

To delete all the files stored in “Picture” at a time, press number button 4.

10



The unit asks you “All Picture Delete OK?”

- 5 To delete the file stored in “PowerOn,” “PowerOff,” and “Movie,” press number button 3 again.

9



To delete all the files stored in “Picture” at a time, press number button 4 again.

10



“Now Deleting...” appears while erasing all the stored files. When erasure is over, the download selection screen appears again.

- 6 Press number button 5 to resume the source indication screen.

11



To delete the stored files for “Picture” (one by one)

- 1 Press M (MODE) while playing any source.

MODE



“Mode” appears on the display. The next-step-operation buttons start flashing.

- 2 Press number button 6 to show the download selection screen.

12



- 3 Press ▲ (up) or ▼ (down) to select (highlight) “Picture.”

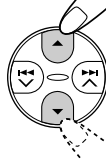

- 4 Press number button 3.

9



The unit shows the name list of the stored files.

Note:

The display can show only six names at a time. You can show the other names by pressing ▲ (up) or ▼ (down) repeatedly.

- 5 Press the number buttons for the file you want to delete.

7



8



9



10



11



12



Selected file name appears, and the unit asks you “Delete OK?”

- 6 Press number button 3 to start erasure.

9



“Now Deleting...” appears while erasing the selected file. When erasure is over, the name list of the stored file appears again.

7 To delete more files, repeat from steps 5 and 6.

8 Press D (DISP) to resume the source indication screen.



Activating the downloaded images and animations

Activating the animations stored for opening and ending screens

After the unit turns on or before the unit turns off, you can see preset animations on the display. These are called opening screen and ending screen. You can use your own edited animations for these opening and ending screens.

- Opening and ending screens will not be shown if the “KeyIn CFM” setting is set to “Short” or “Off.” (See page 41.)
- If no animation is stored in “PowerOn” and “PowerOff,” “Opening” and “Ending” cannot be selected as a PSM item.

1 Press and hold SEL (select) for more than 2 seconds so that one of the PSM items appears on the display. (PSM: see pages 39 and 40.)



2 Press number button 1 to select “MOVIE”—Movie category of the PSM settings.

The “Graphics” setting screen appears on the display.

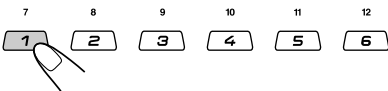

3 Select “Opening” (opening screen setting) or “Ending” (ending screen setting).

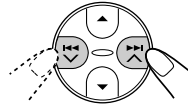

Ex.: When you select “Opening”

4 Select “User.”

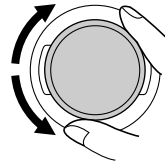

- Default: Factory-preset animation is used.
- User: Your own edited animation is used.

5 Finish the setting.



Activating the graphic screen using either picture or movie

Using this setting, you can change the graphic displays. These graphic screen appears if no operation is done for about 20 seconds.

- If no image is stored in “Picture,” or no animation in “Movie,” “UserPict.” cannot be selected as a PSM item.

1 Press and hold SEL (select) for more than 2 seconds so that one of the PSM items appears on the display. (PSM: see pages 39 and 40.)



CONTINUED ON THE NEXT PAGE

2 Press number button 1 to select “MOVIE”—Movie category of the PSM settings.

The “Graphics” setting screen appears on the display.

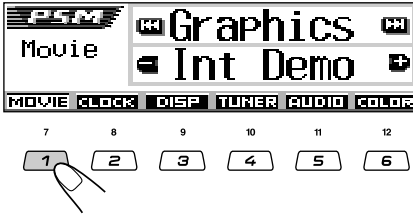

3 Select “UserMovie,” “UserSlide,” or “UserPict.”

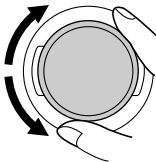

Ex.: When you select “UserPict.”

- UserMovie: Your edited animation stored in “Movie” is activated as your graphic screen.
- UserSlide: Your edited still images stored in “Picture” are activated and shown in sequence as your graphic screen.
- UserPict.: One of your edited still image stored in “Picture” is activated as your graphic screen. Select one of the stored images (see the next column).

4 Finish the setting.



To cancel all graphic displays, select “Off” in step 3.

Note:

For the “Graphics” setting, you can also select “All Demo,” “Int Demo,” and “ImageLink.”

– See pages 8 and 41 for “All Demo” and “Int Demo.”

– See pages 23 and 41 for “ImageLink.”

Selecting a still image for graphic display—User Picture

You cannot select “UserPict.” as a PSM item in the following cases:

- If no image is stored in “Picture,” or
- “UserPict.” is not selected for the “Graphics” setting (see the left column),

1 Press and hold SEL (select) for more than 2 seconds so that one of the PSM items appears on the display. (PSM: see pages 39 and 40.)



2 Press number button 1 to select “MOVIE”—Movie category of the PSM settings.

The “Graphics” setting screen appears on the display.

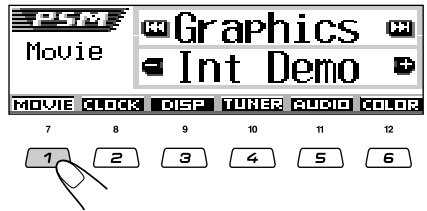

3 Select “UserPict.”

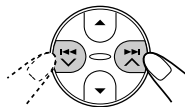

File name of the current selected image also appears.



4 Select a file you want.

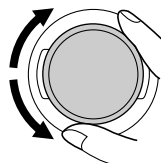

5 Finish the setting.





Changing the general settings (PSM)

You can change the items listed on the table below and on page 40 by using the PSM (Preferred Setting Mode) control.

- The PSM items are grouped into six categories—MOVIE, CLOCK, DISP (display), TUNER, AUDIO, and COLOR.

- Select the PSM item you want to adjust. (See below and page 40.)

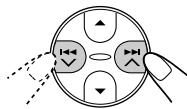

- By pressing $\blacktriangleright\blacktriangleright$ \blacktriangle or $\blacktriangleleft\blacktriangleleft$ \blacktriangledown repeatedly, you can also move to another category.

Basic Procedure

- Press and hold SEL (select) for more than 2 seconds so that one of the PSM items appears on the display. (See below and page 40.)



The next-step-operation buttons start flashing.

- Adjust the PSM item selected.

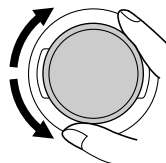

- Repeat steps 2 to 4 to adjust the other PSM items if necessary.

- Press number button to select one of the PSM categories.

The first-listed item in the selected category appears.

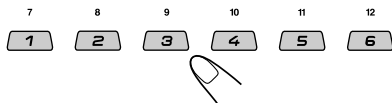

- Finish the setting.



Preferred Setting Mode (PSM) items

The PSM items are grouped into six categories—MOVIE, CLOCK, DISP (display), TUNER, AUDIO, and COLOR.

Indications		Selectable values/items	Factory-preset settings	See page		
MOVIE	Graphics	Movie demonstration	See page 41 for details	Int Demo	8, 23, 41	
	KeyIn CFM	Key-in confirmation	Long \leftrightarrow Short \uparrow Off \downarrow	Long	41	
	Opening *1	Opening animation	Default	User	Default	37, 38
	Ending *1	Ending animation	Default	User	Default	37, 38
	UserPict. *2	User Picture	From the stored files		First stored	38

*1 Displayed only after a downloadable file is stored in memory.

*2 Displayed only after a downloadable file is stored in memory and while selecting "UserPict." for "Graphics."



		Indications	Selectable values/items		Factory-preset settings	See page
CLOCK	Clock Hr	Hour adjustment	1 – 12		1 (1:00AM)	9
	Clock Min	Minute adjustment	00 – 59		00 (1:00AM)	9
	24H/12H	24 hours or 12 hours	12Hours	24Hours	12Hours	9
DISP (display)	Scroll	Scroll mode	Once ↩	↔ Auto Off ↶	Once	41
	Dimmer	Dimmer mode	Auto ↕ Time Set	↔ Off ↕ On	Auto	43
	From– To*	Dimmer time setting	Any time – Any time		6PM – 7AM	43
	Contrast	Contrast	1 – 10		5	41
	LCD Type	Display type	Auto ↩	↔ Positive Negative ↶	Auto	41
	Font Type	Font type	1	2	1	42
	Tag	Tag display	Off	On	On	42
TUNER	IF Filter	Intermediate frequency filter	Wide	Auto	Auto	42
AUDIO	Beep	Key-touch tone	Off	On	On	42
	Telephone	Telephone Muting	Muting1 ↩	↔ Off Muting2 ↶	Off	42
COLOR	All SRC	Selected source	See page 44 for details		Every	44
	User	User color selection	Day	Night	Day	45
	R	Red	00 – 11		Day: 07/Night: 05	45
	G	Green	00 – 11		Day: 07/Night: 05	45
	B	Blue	00 – 11		Day: 07/Night: 05	45
	TrimIllum	Trim illumination	On ↩	↔ Off Audio ↶	On	42

*3 Displayed only when “Dimmer” is set to “Time Set.”



To show the graphics on the display— Graphics

You can change the graphics shown on the display. These graphics appear if no operation is done for about 20 seconds (except for “ImageLink”).

- **Int Demo:** Display demonstration (animation) and playback source indication appears alternately (see page 8).
- **All Demo:** Display demonstration (animation) appears (see page 8).
- **UserMovie:** Your edited animation appears (see pages 37 and 38).
- **UserSlide:** Your edited still images appears in sequence (see pages 37 and 38).
- **UserPict.:** One of your edited still image appears (see pages 37 and 38).
- **ImageLink:** To show a still image while playing back an MP3 files (see page 23).
- **Off:** Cancels all graphic display above.

Note:

You can select “UserMovie,” “UserSlide,” and “UserPict.” only after downloading the appropriate files in memory. (See page 33.)

To select the source animation on the display—KeyIn CFM

When changing the source, the display shows the source animation. You can select the source animation on the display according to your preference.

- **Long:** A long source animation appears.
- **Short:** A short source animation appears.
- **Off:** Cancels the source animation.

To select the scroll mode—Scroll

You can select the scroll mode for the disc information (when the entire text cannot be shown at once).

- **Once:** Scrolls only once.
- **Auto:** Repeats the scroll (in 5-second intervals).
- **Off:** Cancels scroll mode.

Note:

Even if the scroll mode is set to “Off,” you can scroll the display by pressing D (DISP) for more than one second.

To adjust the display contrast level —Contrast

You can adjust the display contrast level among 1 to 10.

Adjust it to make the display indications clear and legible.

To select the display illumination pattern —LCD Type

You can select the display illumination patterns according to your preference.

- **Auto:** Positive pattern will be selected during the day time (depending on the “Dimmer” setting); on the other hand, negative pattern will be used during the night time (depending on the “Dimmer” setting).
- **Positive:** Positive (normal) pattern of the display.
- **Negative:** Negative pattern of the display.



To select the font on the display —Font Type

You can change the font types used on the display. Select either “1” or “2” according to your preference.

To turn the tag display on or off—Tag

An MP3 file can contain file information called “ID3 Tag” where its album name, performer, track title, etc. are recorded.

There are two versions—ID3v1 (ID3 Tag version 1) and ID3v2 (ID3 Tag version 2). If both ID3v1 and ID3v2 are recorded on a disc, ID3v2 information will be shown.

- On: Turns on the ID3 tag display while playing MP3 files.
 - If an MP3 file does not have ID3 tags, folder name and file name appear.

Note:

If you change the setting from “Off” to “On” while playing an MP3 file, the tag display will be activated when the next file starts playing.

- Off: Turns off the ID3 tag display while playing MP3 files. (Only the folder name and file name can be shown.)

To change the FM tuner selectivity —IF Filter

In some areas, adjacent stations may interfere with each other. If this interference occurs, noise may be heard.

- Auto: When this type of interference occurs, this unit automatically increases the tuner selectivity so that interference noise will be reduced. (But the stereo effect will also be lost.)
- Wide: Subject to the interference from adjacent stations, but sound quality will not be degraded and the stereo effect will not be lost.

To turn on/off the key-touch tone—Beep

You can deactivate the key-touch tone if you do not want it to beep each time you press a button.

- On: Activates the key-touch tone.
- Off: Deactivates the key-touch tone.

To select the telephone muting —Telephone

This mode is used when a cellular phone system is connected. Depending on the phone system used, select either “Muting1” or “Muting2,” whichever mutes the sounds from this unit.

- Muting1: Selects this if this setting can mute the sounds while using the cellular phone.
- Muting2: Selects this if this setting can mute the sounds while using the cellular phone.
- Off: Cancels the telephone muting.

To turn the trim illumination on or off —Trimillum

You can illuminate the trim plate according to your preference.

- On: Illuminate the trim plate.
- Audio: Illumination changes as audio signal level changes.
- Off: Cancels the illumination.



Selecting the dimmer mode

You can dim the display at night automatically or as you set the timer.

Note:

Auto Dimmer equipped with this unit may not work correctly on some vehicles, particularly on those having a control dial for dimming. In this case, select any other than "Auto."

1 Press and hold SEL (select) for more than 2 seconds so that one of the PSM items appears on the display. (See pages 39 and 40.)



The next-step-operation buttons start flashing.

2 Press number button 3 to select "DISP"—Display category of the PSM settings.

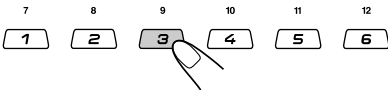

3 Press >>> ^ or <<< v to select "Dimmer."

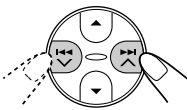

4 Set the dimmer mode as you like.

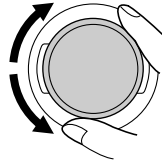

- Auto: Activates Auto Dimmer. When you turn on the car head lights, the display automatically dims.
- Off: Cancels Auto Dimmer.
- On: Always dims the display.
- Time Set: Used to set the timer for the dimmer mode.

Note:

Selecting "Auto" or "Time Set" may change the display pattern to the "Negative" or "Positive" pattern if "LCD Type" is set to "Auto."

- If you select "Time Set," go to the following steps to set the timer.
- If you select any other than "Time Set," go to step 7 to finish the setting.

5 Select "From-To" to set the timer for the dimmer mode.

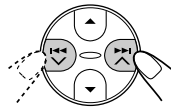

6 Set the timer.

- 1 Turn the control dial to select the start time.
- 2 Press >>> ^ once.
- 3 Turn the control dial to select the end time.

7 Finish the setting.





Changing the display color

You can set the display color using the PSM control. You can select your favorite color for each source (or for all sources).

You can also create your own colors, and set them as the display color.

Setting the desired color for each source

Once you have set the color for each source (or for all sources), the display illuminates in the selected color when the source is selected.

- 1 Press and hold SEL (select) for more than 2 seconds so that one of the PSM items appears on the display. (See pages 39 and 40.)**



The next-step-operation buttons start flashing.

- 2 Press number button 6 to select "COLOR"—Color category of the PSM settings.**

The "All SRC" setting screen appears on the display.



- 3 Select the source—All SRC, CD, Changer, Line In, FM, or AM—that you want to set the display color for.**

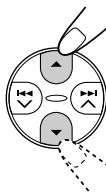

* When you select "All SRC," you can use the same color for all the sources.

- 4 Select the display color.**

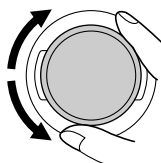

As you turn the control dial, the colors change as follows:

Every*1 ↗ Aqua ↗ Sky ↗ Sea ↗
Leaves ↗ Grass ↗ Red ↗ Rose ↗
Amber ↗ Honey ↗ Violet ↗ Cotton
↗ Snow ↗ User*2 ↗ (back to the beginning)

*1 When you select "Every," the color changes every 2 seconds (changing to every color listed above except "User").

*2 When you select "User," the user-edited colors—"Day" and "Night" will be applied. (See page 45.)

- 5 Repeat steps 3 and 4 to select the color for each source (except when selecting "All SRC" in step 3).**

- 6 Finish the setting.**





Creating your own color—User

You can create your own colors—“Day” and “Night,” and select them as the display color for any desired source.

- Day: Can be used as your user color during the day time (while the headlights are turned off).
- Night: Can be used as your user color during the night time (while the headlights are turned on.)

1 Press and hold SEL (select) for more than 2 seconds so that one of the PSM items appears on the display. (See pages 39 and 40.)



The next-step-operation buttons start flashing.

2 Press number button 6 to select “COLOR”—Color category of the PSM settings.

The “All SRC” setting screen appears on the display.

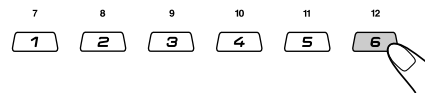

3 Select “User” as a color.

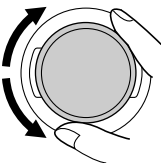

The user color will be applied to the currently selected source (the one shown on the upper portion of the display. In this example “All SRC”).

To select which source to apply your user color to, select the target source first by pressing ▲ (up) or ▼ (down), before selecting “User” in this step.

4 Select the user color adjustment screen.

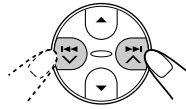

One of the user color adjustment screens appears. “User Day” or “User Night” is shown on the left side of the display.

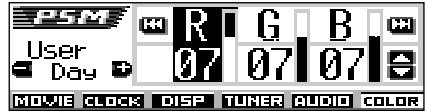

5 Select “Day” or “Night” which you want to make an adjustment for.

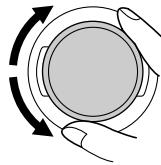

6 Adjust the selected user color.

1) Press ►► ▲ or ◀◀ ▼ to select one of three primary colors—“R” (red), “G” (green), and “B” (blue).



2) Press ▲ (up) or ▼ (down) to adjust the selected primary color.

You can adjust within the range of 00 to 11.

3) Repeat steps 1) and 2) to adjust the other primary colors.

7 Repeat steps 5 and 6 to adjust the other user colors—“Day” or “Night.”

8 Finish the setting.





Assigning names to the sources

You can assign names to station frequencies, CDs (both in this unit and in the CD changer), and the external component. After assigning a name, it will appear on the display when you select the source.

Sources	Maximum number of characters
Station frequencies	Up to 10 characters (up to 30 station frequencies including both FM and AM)
CDs*	Up to 32 characters (up to 40 discs)
External component	Up to 8 characters

* You cannot assign a name to a CD Text or an MP3 disc.

1 Select a source you want to assign a name to.

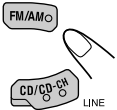

When you select a source, the power automatically comes on.

2 While pressing D (DISP), press and hold SEL (select) for more than 2 seconds.

The next-step-operation buttons start flashing.



Ex.: When you select CD as the source

3 Select the character set you want while the first character position is flashing.



Each time you press the button, the character set changes as follows:

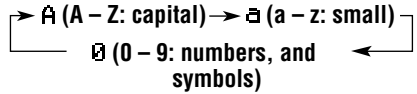

4 Select a character.

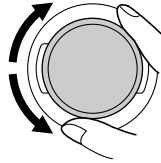

• About the available characters, see page 56.

5 Move the cursor to the next (or previous) character position.

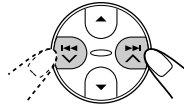

6 Repeat steps 3 to 5 until you finish entering the name.

7 Finish the procedure while the last selected character is flashing.



To erase the entered characters

Insert spaces using the same procedure described above.

Notes:

- When you try to assign a name to the 41st disc or to the 31st station frequency, "Name Full" appears and you cannot enter the text entry mode. In this case, delete unwanted names before assignment.
- When the CD changer is connected, you can assign names to CDs in the CD changer. These names can also be shown on the display if you insert the CDs in this unit.



Detaching the control panel

You can detach the control panel when leaving the car.

When detaching or attaching the control panel, be careful not to damage the connectors on the back of the control panel and on the panel holder.

Detaching the control panel

Before detaching the control panel, be sure to turn off the power.

- 1** Unlock the control panel.

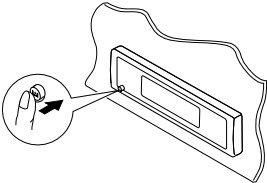

- 2** Pull the control panel out of the unit.

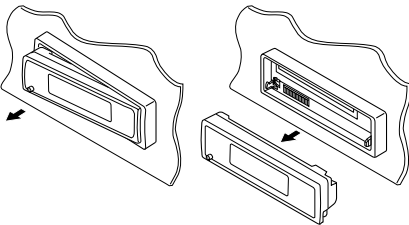

- 3** Put the detached control panel into the provided case.

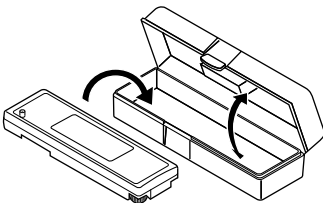

Attaching the control panel

- 1** Insert the right side of the control panel into the groove on the panel holder.

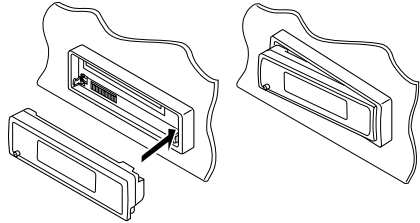

- 2** Press the left side of the control panel to fix it to the panel holder.

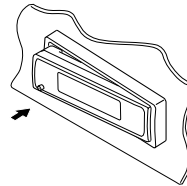

Note on cleaning the connectors:

If you frequently detach the control panel, the connectors will deteriorate.

To minimize this possibility, periodically wipe the connectors with a cotton swab or cloth moistened with alcohol, being careful not to damage the connectors.

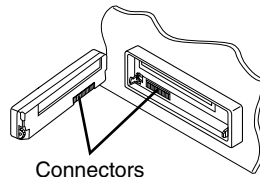

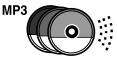

CD CHANGER OPERATIONS

ENGLISH

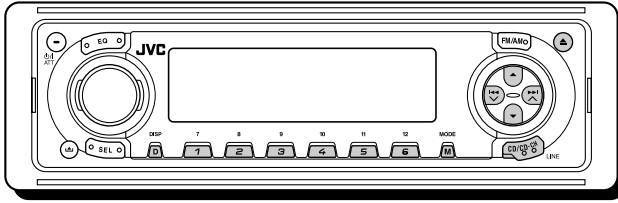

We recommend that you use the JVC MP3-compatible CD changer with your unit.

By using this CD changer, you can play back your original CD-Rs (Recordable) and CD-RWs (Rewritable) recorded either in audio CD format or in MP3 format.

- You can also connect other CH-X series CD changers (except CH-X99 and CH-X100). However, they are not compatible with MP3 discs, so you cannot play back MP3 discs.
- You cannot use the KD-MK series CD changers with this unit.

Before operating your CD changer:

- Refer also to the Instructions supplied with your CD changer.
- If no discs are in the magazine of the CD changer or the discs are inserted upside down, "No Disc" will flash on the display. If this happens, remove the magazine and set the discs correctly.
- If no magazine is loaded in the CD changer, "No Magazine" flashes on the display. If this happens, insert the magazine in the CD changer.
- If "Reset 01" – "Reset 08" flashes on the display, something is wrong with the connection between this unit and the CD changer. If this happens, check the connection and make sure the cords are connected firmly. Then, press the reset button of the CD changer.

Playing discs

Select the CD changer (CD-CH).



* Without connecting the CD changer, you cannot select "CD-CH" as the source to play.

- **When the current disc is an MP3 disc:** Playback starts from the first folder of the current disc once file check is completed.

Selected disc number

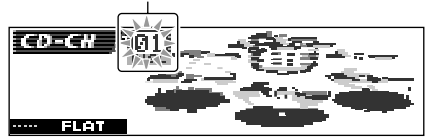

Current folder/file and elapsed playing time

MP3 indicator

• When the current disc is a CD:

Playback starts from the first track of the current disc.

Selected disc number



Current track and elapsed playing time

Notes:

- When you press CD/CD-CH (LINE), the power automatically comes on. You do not have to press $\text{O}/\text{I}/\text{ATT}$ to turn on the power.
- If you change the source, CD changer play also stops. Next time you select "CD-CH" as the source, disc play starts from where playback has been stopped previously.

To change the display pattern

By pressing D (DISP), you can change the information shown on the display.



Each time you press the button, the display patterns change.

- For details, see pages 19 and 27.

To go to a particular disc directly

Press the number button corresponding to the disc number to start its playback (while the CD changer is playing).

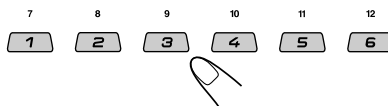

- To select a disc number from 01 – 06: Press 1 (7) – 6 (12) briefly.
- To select a disc number from 07 – 12: Press and hold 1 (7) – 6 (12) for more than one second.

To fast-forward or reverse the track/file

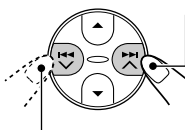

Press and hold ▶▶ ▲ , during play, to fast-forward the track/file.

Press and hold ◀◀ ▼ , during play, to reverse the track/file.

Note:

During this operation on an MP3 disc, you can only hear intermittent sounds. (The elapsed playing time also changes intermittently on the display.)

To go to the next or previous tracks/files

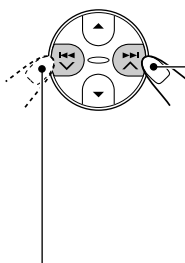

Press ▶▶ ▲ briefly during play, to skip ahead to the beginning of the next track/file. Each time you press the button consecutively, the beginning of the next tracks/files is located and played back.

Press ◀◀ ▼ briefly during play, to skip back to the beginning of the current track/file. Each time you press the button consecutively, the beginning of the previous tracks/files is located and played back.

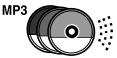

This operation is only possible when using JVC MP3-compatible CD changer (CH-X1500).

To go to a track/file quickly

1 Press M (MODE) while playing a disc.



"Mode" appears on the display. The next-step-operation buttons start flashing.

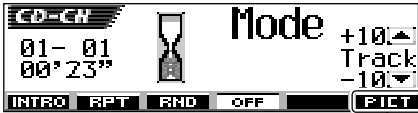

See page 33 for this function.

Ex.: When the current disc is an MP3 disc

2 Press ▲ (up) or ▼ (down) while "Mode" is still on the display.

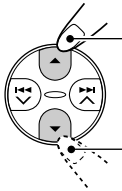

To skip 10 tracks/files* forwards to the last track/file

To skip 10 tracks/files* backwards to the first track/file

* The first time you press ▲ (up) or ▼ (down) button, the track/file skips to the nearest higher or lower track/file with a track/file number of multiple ten (ex. 10th, 20th, 30th).

Then each time you press the button, you can skip 10 tracks/files (see "How to go to the desired track/file quickly" on the right column).

- After the last track/file, the first track/file will be selected, and vice versa.

Note:

If the current playing disc is an MP3 disc, files are skipped within the same folder.

How to go to the desired track/file quickly

- Ex. 1: To select track/file number 32 while playing track/file number 6

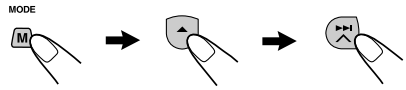

(Three times)

(Twice)

Track/File 6 → 10 → 20 → 30 → 31 → 32

- Ex. 2: To select track/file number 8 while playing track/file number 36



(Three times)

(Twice)

Track/File 36 → 30 → 20 → 10 → 9 → 8

To skip to the next or previous folder (only for MP3 discs)

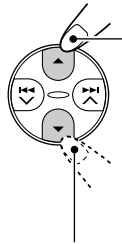

Press ▲ (up) while playing an MP3 disc, to go to the next folder. Each time you press the button consecutively, the next folder is located, and the first file in the folder starts playback.

Press ▼ (down) while playing an MP3 disc, to go to the previous folder.

Each time you press the button consecutively, the previous folder is located, and the first file in the folder starts playback.

Selecting a disc/folder/track using the name lists

If you forget what discs are loaded in the CD changer, you can show the disc name list and select a disc in the list shown on the display.

- The display can show only six names at a time.

1 While playing a disc, press and hold ▲ (up) or ▼ (down) until a disc name list appears on the display.

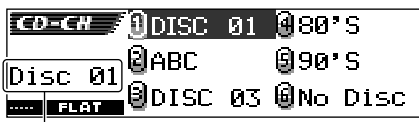
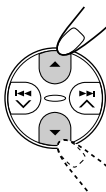

Selected disc number

Note:

If a disc has a disc title (CD Text) or an assigned disc name, it will be shown on the display.

However, if the disc has not been played before, its disc number will appear.

2 Press ▲ (up) or ▼ (down) to show the other disc name list, if necessary.

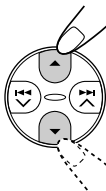

3 Select the number (1 – 6) for the disc you want to play.

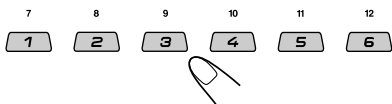

While playing an MP3 disc, you can also show the folder list(s) and file list(s) on the display, then select a folder or file.

- 1 While playing an MP3 disc, press and hold ▲ (up) or ▼ (down) until a disc name list appears on the display.
- 2 Press ►► ▲ or ◀◀ ▼ to show a folder list of the current disc or file list of the current folder.
Each time you press the button, the lists on the display change as follows:

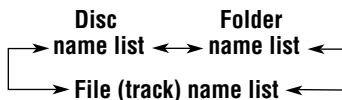

Current folder number



Ex.: When folder name list is selected

Current file number

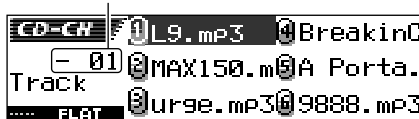

Ex.: When file name list is selected

Note:

The display can show only six items at a time. You can show the other names on the next lists by pressing ▲ (up) or ▼ (down).

- 3 Press the number button for the disc, folder, or file you want to play.

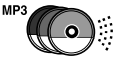

Selecting the playback modes

To play back tracks/files at random (Random Play)

1 Press M (MODE) during play.

MODE



“Mode” appears on the display. The next-step-operation buttons start flashing.

2 Press number button 3 repeatedly while “Mode” is still on the display.

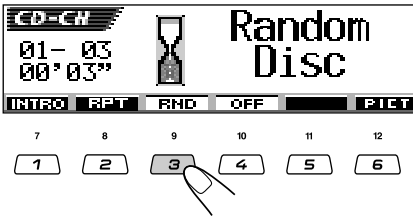

Ex.: When you select “Random Disc” while playing an MP3 disc

Each time you press the button, random play mode changes as follows:

For MP3 discs:

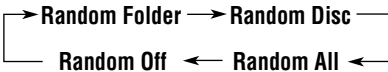

For CDs:



Mode	Active indicator	Plays at random
Random Folder*	RND (folder random) indicator lights up.	All files of the current folder, then files of the next folder and so on.
Random Disc	RND (disc random) indicator lights up.	All tracks/files of the current (or specified) disc.
Random All	ALL RND (all random) indicator lights up.	All tracks/files of all discs inserted in the magazine.

* “Random Folder” is only applicable for MP3 disc.

Note:

MP3 indicator also lights up if the current playing disc is an MP3 disc.

To cancel Random Play, select “Random Off” by pressing number button 3 repeatedly or press number button 4 in step 2.

To play back tracks/files repeatedly (Repeat Play)

1 Press M (MODE) during play.



“Mode” appears on the display.
The next-step-operation buttons start flashing.

2 Press number button 2 repeatedly while “Mode” is still on the display.

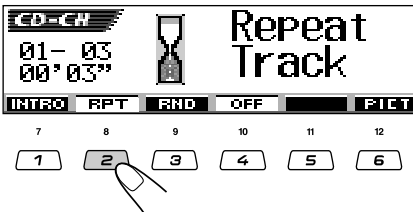

Ex.: When you select “Repeat Track” while playing an MP3 disc

Each time you press the button, repeat play mode changes as follows:

For MP3 discs:

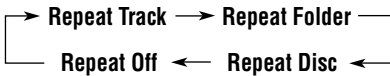

For CDs:



Mode	Active indicator	Plays repeatedly
Repeat Track	RPT (track/file repeat) indicator lights up.	The current (or specified) track/file.
Repeat Folder*	RPT (folder repeat) indicator lights up.	All files of the current (or specified) folder of the current disc.
Repeat Disc	RPT (disc repeat) indicator lights up.	All tracks/files of the current (or specified) disc.

* “Repeat Folder” is only applicable for MP3 disc.

Note:

MP3 indicator also lights up if the current playing disc is an MP3 disc.

To cancel Repeat Play, select “Repeat Off” by pressing number button 2 repeatedly or press number button 4 in step 2.

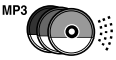

To play back only intros (Intro Scan)

1 Press M (MODE) during play.

MODE



“Mode” appears on the display.
The next-step-operation buttons start flashing.

2 Press number button 1 repeatedly while “Mode” is still on the display.

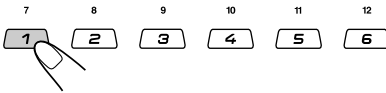

Ex.: When you select “Intro Track” while playing an MP3 disc

Each time you press the button, intro scan mode changes as follows:

For MP3 discs:

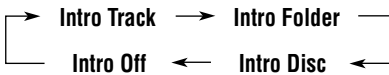

For CDs:



Mode	Active indicator	Plays the beginnings (15 seconds) of
Intro Track	INT (track/file intro) indicator lights up.	All tracks/files of the current disc.
Intro Folder*	INT (folder intro) indicator lights up.	The first file of every folder of the current disc.
Intro Disc	INT (disc intro) indicator lights up.	The first tracks/files of the inserted discs.

* “Intro Folder” is only applicable for MP3 disc.

Note:

MP3 indicator also lights up if the current playing disc is an MP3 disc.

To cancel Intro Scan, select “Intro Off” by pressing number button 1 repeatedly or press number button 4 in step 2.

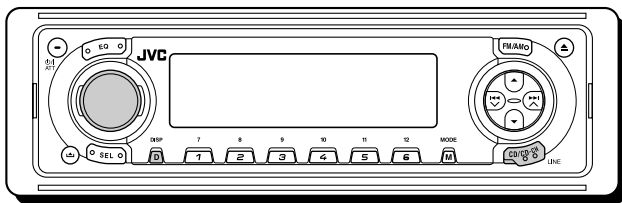

Playing an external component

You can connect an external component to the LINE IN plugs on the rear.

- Select the external component (LINE-IN).**

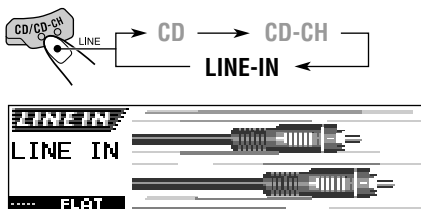

Note on One-Touch Operation:

When you press CD/CD-CH (LINE), the power automatically comes on. You do not have to press $\text{P}/\text{I}/\text{ATT}$ to turn on the power.

- Turn on the connected component and start playing the source.**

- Adjust the volume.**

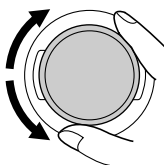

- Adjust the sound characteristics you want. (See pages 28 – 31.)**

To change the display pattern

By pressing D (DISP), you can change the display information shown on the display.



Each time you press the button, the display changes as follow:

Large animation display

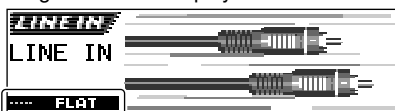

Current sound mode (iEQ)
(see page 29)

Small animation display

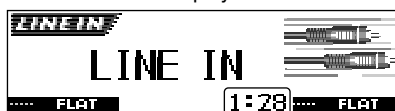

Clock time

Clock time display

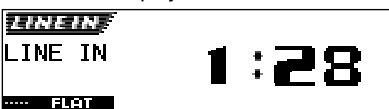



ADDITIONAL INFORMATION

Sound modes (preset frequency level settings)

The list below shows the preset frequency level settings for each sound mode.

- You can adjust the preset sound modes temporarily. However, your temporary adjustments will be reset when you select another sound mode.

Sound Mode	Preset equalizing values						
	60 Hz	150 Hz	400 Hz	1 kHz	2.4 kHz	6 kHz	12 kHz
Flat	00	00	00	00	00	00	00
Hard Rock	+03	+03	+01	00	00	+02	+01
R & B	+03	+02	+02	00	+01	+01	+03
Pop	00	+02	00	00	+01	+01	+02
Jazz	+03	+02	+01	+01	+01	+03	+02
Dance Music	+04	+02	00	-02	-01	+01	+01
Country	+02	+01	00	00	00	+01	+02
Reggae	+03	00	00	+01	+02	+02	+03
Classic	+02	+03	+01	00	00	+02	00
User 1	00	00	00	00	00	00	00
User 2	00	00	00	00	00	00	00
User 3	00	00	00	00	00	00	00

Available characters

You can use the following characters to assign names to stations, CDs, and external component. (See page 46.)

Capital letters

A	B	C	D	E
F	G	H	I	J
K	L	M	N	O
P	Q	R	S	T
U	V	W	X	Y
Z	space			

Small letters

a	b	c	d	e
f	g	h	i	j
k	l	m	n	o
p	q	r	s	t
u	v	w	x	y
z	space			

Numbers and symbols

0	1	2	3	4
5	6	7	8	9
!	"	#	\$	%
&	'	()	*
+	,	-	.	/
:	;	<	=	>
?	@	_	`	space

TROUBLESHOOTING





What appears to be trouble is not always serious. Check the following points before calling a service center.

	Symptoms	Causes	Remedies
General	<ul style="list-style-type: none"> Sound cannot be heard from the speakers. 	The volume level is set to the minimum level.	Adjust it to the optimum level.
		Connections are incorrect.	Check the cords and connections.
	<ul style="list-style-type: none"> This unit does not work at all. 	The built-in microcomputer may have functioned incorrectly due to noise, etc.	Press the reset button on the panel holder after detaching the control panel. (The clock setting and preset stations stored in memory are erased.) (See page 2.)
	<ul style="list-style-type: none"> "Panel Connect Error" appears on the display. 	The control panel is not attach correctly and firmly.	Remove the control panel, wipe the connectors, then attach it again. (See page 47.)
FM/AM	<ul style="list-style-type: none"> SSM (Strong-station Sequential Memory) automatic preset does not work. 	Signals are too weak.	Store stations manually.
	<ul style="list-style-type: none"> Static noise while listening to the radio. 	The antenna is not connected firmly.	Connect the antenna firmly.
Disc Playback	<ul style="list-style-type: none"> Disc cannot be played back. 	Disc is inserted upside down.	Insert the disc correctly.
	<ul style="list-style-type: none"> CD-R/CD-RW cannot be played back. Tracks on the CD-R/CD-RW cannot be skipped. 	CD-R/CD-RW is not finalized.	<ul style="list-style-type: none"> Insert a finalized CD-R/CD-RW. Finalize the CD-R/CD-RW with the component which you used for recording.
		<ul style="list-style-type: none"> Disc cannot be ejected. 	Disc is locked.
	<ul style="list-style-type: none"> Disc cannot be recognised ("No Disc," "Loading Error," or "Eject Error" flashes on the display.) 	The CD player may function incorrectly.	While holding CD/CD-CH (LINE), press SEL for more than 2 seconds to eject the disc.
	<ul style="list-style-type: none"> Disc sound is sometimes interrupted. 	You are driving on rough roads.	Stop playback while driving on rough roads.
		Disc is scratched.	Change the disc.
		Connections are incorrect.	Check the cords and connections.
<ul style="list-style-type: none"> "No Disc" flashes on the display. 	No disc in the loading slot.	Insert a disc into the loading slot.	
	Disc is inserted incorrectly.	Insert the disc correctly.	



	Symptoms	Causes	Remedies
MP3 Playback	<ul style="list-style-type: none"> Disc cannot be played back. 	No MP3 files are recorded on the disc.	Change the disc.
		MP3 files do not have the extension code—mp3 in their file names.	Add the extension code —mp3 to their file names.
		MP3 files are not recorded in the format compliant with ISO 9660 Level 1, Level 2, Romeo, or Joliet.	Change the disc. (Record MP3 files using a compliant application.)
	<ul style="list-style-type: none"> “Unplayable File” appears and files skip. 	Files are not encoded in an appropriate format.	Insert a disc that contains files encoded in an appropriate format.
	<ul style="list-style-type: none"> Noise is generated. 	The file played back is not an MP3 file (although it has the extension code—mp3).	Skip to another file or change the disc. (Do not add the extension code—mp3 to non-MP3 files.)
	<ul style="list-style-type: none"> A longer readout time is required (“File Check” keeps flashing on the display). 	Readout time varies due to the complexity of the folder/ file configuration.	Do not use too many hierarchies and folders. Also, do not record any other types of audio tracks together with MP3 files.
	<ul style="list-style-type: none"> Files cannot be played back as you have intended them to play. 	Playback order is determined when the files are recorded.	Insert a disc that contains tracks encoded in an appropriate format.
	<ul style="list-style-type: none"> Elapsed playing time is not correct. 	This sometimes occurs during play. This is caused by how the files are recorded on the disc.	_____
	<ul style="list-style-type: none"> “MP3” flashes on the display. 	The current folder does not contain any MP3 file.	Select another folder.
	<ul style="list-style-type: none"> “No Files” flashes on the display. 	The current disc does not contain any MP3 file.	Insert a disc that contains MP3 files.
<ul style="list-style-type: none"> “No Music” appears on the display. 	The current folder does not contain any MP3 file.	Select another folder that contains MP3 files.	
	Only <jml> and/or <jma> files are recorded on the disc.	Insert a disc that contains MP3 files.	
<ul style="list-style-type: none"> Correct characters are not displayed (e.g. album name). 	This unit can only display alphabets (capital: A–Z, small: a – z), numbers, and a limited number of symbols.	_____	



Symptoms	Causes	Remedies	
<ul style="list-style-type: none"> Download does not seem to finish. 	You are trying to download an animation of many frames.	This is normal (see page 33).	Graphics
<ul style="list-style-type: none"> Animation does not move. “Movie” category settings in the PSM do not take effect. 	Temperature in the car compartment is very low—  (LOW TEMP.) indicator appears.	Wait until the operating temperature resumes—until  (LOW TEMP.) indicator goes off.	
<ul style="list-style-type: none"> “No Disc” flashes on the display. 	No disc is in the magazine.	Insert discs into the magazine.	CD Changer
	Discs are inserted upside down.	Insert discs correctly.	
<ul style="list-style-type: none"> “No Magazine” flashes on the display. 	No magazine is loaded in the CD changer.	Insert the magazine.	
<ul style="list-style-type: none"> “Reset 08” flashes on the display. 	This unit is not connected to the CD changer correctly.	Connect this unit and the CD changer correctly and press the reset button of the CD changer.	
<ul style="list-style-type: none"> “Reset 01” – “Reset 07” flashes on the display. 	_____	Press the reset button of the CD changer.	
<ul style="list-style-type: none"> The CD changer does not work at all. 	The built-in microcomputer may function incorrectly due to noise, etc.	Press the reset button on the panel holder after detaching the control panel. (The clock setting and preset stations stored in memory are erased.) (See page 2.)	

About mistracking:

Mistracking may result from driving on extremely rough roads. This does not damage the unit and the disc, but will be annoying.

We recommend that you stop disc play while driving on such rough roads.



MAINTENANCE

Handling discs

This unit has been designed to reproduce CDs, CD-Rs (Recordable), CD-RWs (Rewritable), and CD Texts.

• This unit is also compatible with MP3 discs.

How to handle discs

When removing a disc from its case, press down the center holder of the case and lift the disc out, holding it by the edges.

Center holder



• Always hold the disc by the edges. Do not touch its recording surface.

When storing a disc into its case, gently insert the disc around the center holder (with the printed surface facing up).

• Make sure to store discs into the cases after use.

To keep discs clean

A dirty disc may not play correctly. If a disc does become dirty, wipe it with a soft cloth in a straight line from center to edge.



To play new discs

New discs may have some rough spots around the inner and outer edges. If such a disc is used, this unit may reject the disc.



To remove these rough spots, rub the edges with a pencil or ball-point pen, etc.

Moisture condensation

Moisture may condense on the lens inside the CD player in the following cases:

- After starting the heater in the car.
- If it becomes very humid inside the car.

Should this occur, the CD player may malfunction. In this case, eject the disc and leave the unit turned on for a few hours until the moisture evaporates.

When playing a CD-R or CD-RW

Before playing back CD-Rs or CD-RWs, read their instructions or cautions carefully.

- Use only “finalized” CD-Rs or CD-RWs.
- Some CD-Rs or CD-RWs may not play back on this unit because of their disc characteristics, and for the following reasons:
 - Discs are dirty or scratched.
 - Moisture condensation on the lens inside the unit.
 - The pickup lens inside the unit is dirty.
- CD-RWs may require a longer readout time since the reflectance of CD-RWs is lower than that of regular CDs.
- CD-Rs or CD-RWs are susceptible to high temperatures or high humidity, so do not leave them inside your car.
- Do not use following CD-Rs or CD-RWs:
 - Discs with stickers, labels, or protective seal stuck to the surface.
 - Discs on which labels can be directly printed by an ink jet printer.

Using these discs under high temperatures or high humidity may cause malfunctions or damage to discs. For example,

- Stickers or labels may shrink and warp a disc.
- Stickers or labels may peel off so discs cannot be ejected.
- Print on discs may get sticky.

Read instructions or cautions about labels and printable discs carefully.

CAUTIONS:

- Do not insert 8 cm discs (single CDs) into the loading slot. (Such discs cannot be ejected.)
- Do not insert any disc of unusual shape—like a heart or flower; otherwise, it will cause a malfunction.
- Do not expose discs to direct sunlight or any heat source or place them in a place subject to high temperature and humidity. Do not leave them in a car.
- Do not use any solvent (for example, conventional record cleaner, spray, thinner, benzine, etc.) to clean discs.

Warped disc



Sticker



Sticker residue

Disc



Stick-on label

AUDIO AMPLIFIER SECTION

Maximum Power Output:

Front: 50 W per channel

Rear: 50 W per channel

Continuous Power Output (RMS):

Front: 19 W per channel into 4 Ω , 40 Hz to 20 000 Hz at no more than 0.8% total harmonic distortion.

Rear: 19 W per channel into 4 Ω , 40 Hz to 20 000 Hz at no more than 0.8% total harmonic distortion.

Load Impedance: 4 Ω (4 Ω to 8 Ω allowance)

Equalizer Control Range:

Frequencies: 60 Hz, 150 Hz, 400 Hz, 1 kHz, 2.4 kHz, 6 kHz, 12 kHz

Level: ± 10 dB

Frequency Response: 40 Hz to 20 000 Hz

Signal-to-Noise Ratio: 70 dB

Line-In Level/Impedance: 1.5 V/20 k Ω load

Line-Out Level/Impedance:

4.0 V/20 k Ω load (full scale)

Output Impedance: 1 k Ω

Subwoofer-Out Level/Impedance:

2.0 V/20 k Ω load (full scale)

TUNER SECTION

Frequency Range:

FM: 87.5 MHz to 108.0 MHz

AM: 531 kHz to 1 602 kHz

[FM Tuner]

Usable Sensitivity: 11.3 dBf (1.0 μ V/75 Ω)

50 dB Quieting Sensitivity: 16.3 dBf (1.8 μ V/75 Ω)

Alternate Channel Selectivity (400 kHz): 65 dB

Frequency Response: 40 Hz to 15 000 Hz

Stereo Separation: 35 dB

Capture Ratio: 1.5 dB

[AM Tuner]

Sensitivity: 20 μ V

Selectivity: 35 dB

CD PLAYER SECTION

Type: Compact disc player

Signal Detection System: Non-contact optical pickup (semiconductor laser)

Number of channels: 2 channels (stereo)

Frequency Response: 5 Hz to 20 000 Hz

Dynamic Range: 96 dB

Signal-to-Noise Ratio: 98 dB

Wow and Flutter: Less than measurable limit

MP3 decoding format:

MPEG1/2 Audio Layer 3

Max. Bit Rate: 320 Kbps

GENERAL

Power Requirement:

Operating Voltage:

DC 14.4 V (11 V to 16 V allowance)

Grounding System: Negative ground

Allowable Operating Temperature: 0°C to +40°C

Dimensions (W \times H \times D):

Installation Size (approx.):

182 mm \times 52 mm \times 150 mm

Panel Size (approx.):

188 mm \times 58 mm \times 12 mm

Mass (approx.):

1.4 kg (excluding accessories)

Design and specifications are subject to change without notice.

**Having TROUBLE with operation?
Please reset your unit
Refer to page of How to reset your unit**

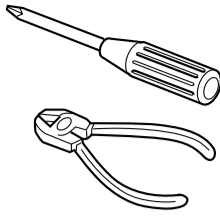

ENGLISH

- This unit is designed to operate only on 12 V DC, NEGATIVE ground electrical systems.

INSTALLATION (IN-DASH MOUNTING)

- The following illustration shows a typical installation. However, you should make adjustments corresponding to your specific car. If you have any questions or require information regarding installation kits, consult your JVC car audio dealer or a company supplying kits.

中文

- 本機僅可使用直流 12V、負極接地的電源系統。

安裝 (裝設、固定在儀表板內)

- 下面的圖解表示了典型的安裝程序。然而，您應當做些適當的調整，以便適應您自己的汽車。如果您有問題，或需要有關配套元件的資料，請向 JVC 汽車音響分銷商或配套元件供應公司詢問。

ไทย

- ชุดประกอบนี้ได้รับการออกแบบมาเพื่อใช้ร่วมกับระบบ กระแสไฟฟ้าสายดินขั้วลบกระแสตรง 12 โวลท์ หากรถยนต์ของคุณไม่ได้ใช้ระบบนี้ ต้องใช้เครื่องแปลงกระแสไฟฟ้าย

การติดตั้ง (การประกอบแผงหน้าปัทม์เข้า)

- ภาพตัวอย่างต่อไปนี้แสดงถึงการติดตั้งแบบทั่วไป อย่างไรก็ตาม คุณควรปรับแต่งให้เหมาะสมกับรถของคุณเอง หากคุณมีปัญหาคือหรือต้องการข้อมูลเพิ่มเติมเกี่ยวกับชุดติดตั้ง กรุณาปรึกษากับผู้ขายเครื่องเสียงรถยนต์ JVC ของท่านหรือบริษัทที่จำหน่ายชุดติดตั้งนี้

عربي

- لقدصمم هذا الجهاز ليعمل فقط بواسطة تيار كهربائي مباشر DC، ١٢ فولت، انظمة كهربائية تأريض سالب.

تركيب الجهاز (داخل - تابلو السيارة)

- يبيّن الرسم التوضيحي التالي طريقة التركيب المثالية. مع ذلك، يجب عليك عمل تعديلات تطابق نوع السيارة التي تمتلكها. اذا كان هناك استفسارات او حاجة لمعلومات بخصوص ادوات التركيب، يرجى استشارة موزع الاجهزة الصوتية للسيارات ماركة JVC او الشركة الموزعة لهذه الادوات.

- Before mounting:** Press (control panel release button) to detach the control panel if already attached.
 - When shipped from the factory, the control panel is packed in the hard case.
- Remove the trim plate.
- Remove the sleeve after disengaging the sleeve locks.
 - Stand the unit.
 - Note:** When you stand the unit, be careful not to damage the fuse on the rear.
 - Insert the 2 handles between the unit and the sleeve, as illustrated, to disengage the sleeve locks.
 - Remove the sleeve.
 - Note:** Be sure to keep the handles for future use after installing the unit.
- Install the sleeve into the dashboard.
 - After the sleeve is correctly installed into the dashboard, bend the appropriate tabs to hold the sleeve firmly in place, as illustrated.
- Fix the mounting bolt to the rear of the unit's body and place the rubber cushion over the end of the bolt.
- Do the required electrical connections.
- Slide the unit into the sleeve until it is locked.
- Attach the trim plate.
- Attach the control panel.

- 裝設之前：如果控制面板已經裝上，按下 (控制面板解脫按鈕)，拆脫控制面板。
 - 當控制面板從工廠裝運時，它是包裝在硬盒中的。
- 取下裝飾框。
- 解開扣板，取下本機的外套機殼。
 - 將本機豎起。
 - 注意：**您豎起本機時，小心不要損壞底部的保險絲。
 - 按圖所示，在本機和外套機殼之間插入兩片板條型的把手，解開外套機殼扣板。
 - 取下外套機殼。
 - 注意：**安裝本機後，務必保存好兩片把手，以備將來使用。
- 將外套機殼裝入儀表板內。
 - 在外套機殼準確地裝入儀表板之後，按圖所示，彎曲機殼的突舌，把外套機殼牢固在儀表板內。
- 將緊固螺栓旋緊在本機機體上，並將橡膠防震墊套在緊固螺栓的尾部。
- 進行所需的電路連接。
- 將本機滑入外套機殼，直到扣板鎖住為止。
- 裝上裝飾框。
- 裝上控制面板。

- ก่อนประกอบ กดปุ่ม (ใช้ถอดแผงควบคุมออก) เพื่อออกจากแผงควบคุม
 - เมื่อผลิตกันที่ถูกส่งออกมาจากโรงงานแผงหน้าปัดจะบรรจุไว้ในกล่องแข็ง
- ถอดแผ่นโลหะขอบแดงออก
- ถอดปลอกหุ้มออกหลังจากปลดที่ล็อกปลอกหุ้มออกแล้ว
 - จับชุดประกอบตั้งขึ้น
 - หมายเหตุ :** เมื่อคุณตั้งชุดประกอบขึ้น ระวังอย่าทำให้ฟิวส์บริเวณส่วนท้ายเสียหาย
 - ใส่คั่นบังคับ 2 อันระหว่างชุดประกอบกับปลอกหุ้ม (ดังภาพ) เพื่อปลดที่ล็อกปลอกหุ้มออกจากกัน
 - ปลดปลอกหุ้มออก
 - หมายเหตุ :** ระวังระวังให้คั่นบังคับสามารถใช้งานได้อีกต่อไปหลังจากติดตั้งชุดประกอบแล้ว
- ติดตั้งปลอกหุ้มลงในแผงหน้าปัทม์
 - หลังจากติดตั้งปลอกหุ้มลงในแผงหน้าปัทม์อย่างถูกต้องแล้ว คัดกรองให้โค้งพอดีที่ปลอกหุ้มจะถูกยึดไว้อย่างแน่นหนา (ดังภาพ)
- ติดสลักประกอบบริเวณด้านหลังโครงของชุดประกอบและวางยางกันกระแทกไว้บนส่วนปลายของสลัก
- ต่อสายไฟตามที่กำหนดไว้ทั้งหมด
- เลื่อนชุดประกอบลงในปลอกหุ้มจนเข้ากันพอดี
- ต่อแผ่นโลหะขอบแดง
- ต่อเข้ากับแผงควบคุม

- قبل بدء التركيب: اضغط الرمز (زر تحرير لوحة التحكم) من أجل فصل لوحة التحكم.
 - عند الشحن من المصنع، تم وضع لوحة التحكم داخل الصندوق.
- انزع لوحة الزينة.
- انزع الهيكل الواقي بعد فصل مثبتات الهيكل الواقي.
 - أوقف الجهاز بشكل عمودي.
 - ملاحظة:** عند توقيف الجهاز، تأكد من عدم تضرر أو اتلاف الفيوز الموجود في الجهة الخلفية من الجهاز.
 - ادخل المساكين بين الجهاز والهيكل الواقي، كما هو مبين في الشكل، لفصل مثبتات الهيكل الواقي.
 - انزع الهيكل الواقي.
- ركب الهيكل الواقي داخل تابلو السيارة.
 - بعد تركيب الهيكل الواقي كلياً داخل تابلو السيارة بشكل صحيح، اثني الألسنة بشكل مناسب لتثبيت الهيكل الواقي بشكل محكم في المكان الصحيح، كما هو مبين في الشكل.
- ثبّت مسمار التركيب بالجهة الخلفية من هيكل الجهاز وبعد ذلك ضع الحشوة المطاطية فوق نهاية المسمار.
- أعمل التوصيلات الكهربائية المطلوبة كما هو مشروح خلف هذه التعليمات.
- ادخل الجهاز داخل الهيكل الواقي حتى يثبت بشكل صحيح.
- ركب لوحة الزينة.
- ركب لوحة التحكم.

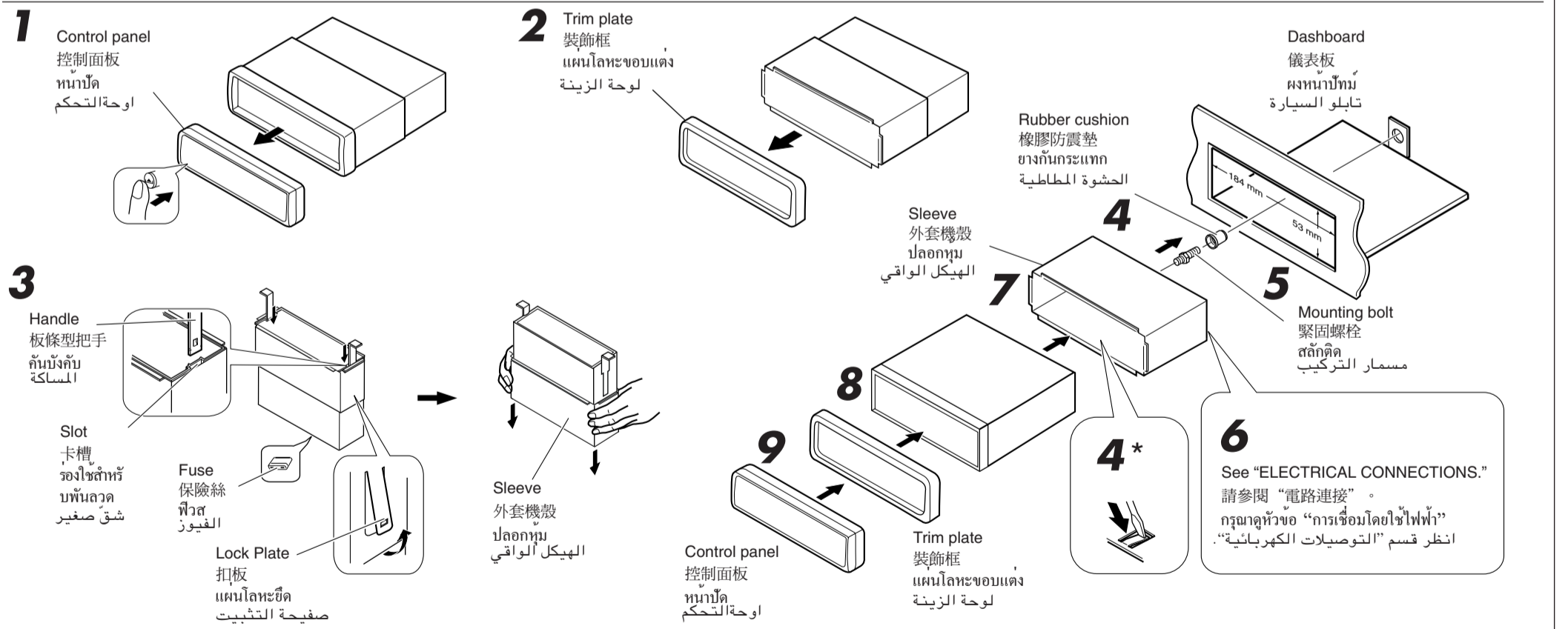

TROUBLESHOOTING

故障排除

การตรวจสอบปัญหาขัดข้อง

البحث عن الاعطال والاصلاح

- The fuse blows.**
 - Are the red and black leads connected correctly?
- Power cannot be turned on.**
 - Is the yellow lead connected?
- No sound from the speakers.**
 - Is the speaker output lead short-circuited?
- Sound is distorted.**
 - Is the speaker output lead grounded?
 - Are the "-" terminals of L and R speakers grounded in common?
- Unit becomes hot.**
 - Is the speaker output lead grounded?
 - Are the "-" terminals of L and R speakers grounded in common?

- 保險絲燒斷。
 - 檢查紅色導線接頭和黑色導線接頭是否連接正確？
- 電源不能接通。
 - 檢查黃色導線接頭是否接上？
- 揚聲器沒有聲音。
 - 檢查揚聲器輸出導線接頭是否短路？
- 聲音失真。
 - 檢查揚聲器輸出端子是否接地？
 - 檢查揚聲器的左 (L)、右 (R) 端子的負極 (-) 是否共同接地？
- 本機發熱。
 - 檢查揚聲器輸出端子是否接地？
 - 檢查揚聲器的左 (L)、右 (R) 端子的負極 (-) 是否共同接地？

- ฟิวส์ขาด**
 - มีการเชื่อมสายตะกั่วสีแดงและสีดำอย่างถูกต้องหรือไม่
- ไม่สามารถเปิดเครื่องได้**
 - มีการเชื่อมสายตะกั่วสีเหลืองหรือไม่
- ไม่มีเสียงจากลำโพง**
 - สายตะกั่วส่วนที่ออกทางลำโพงเกิดไฟฟ้ลัดวงจรหรือไม่
- เสียงเพี้ยน**
 - สายตะกั่วส่วนที่ออกทางลำโพงต่อลงดินหรือไม่
 - สายขั้วลบ ของลำโพงด้านซ้ายและขวาต่อลงดินตามปกติหรือไม่
- ชุดประกอบร้อนขึ้น**
 - สายตะกั่วที่ออกทางลำโพงต่อลงดินหรือไม่
 - สายขั้วลบ ของลำโพงด้านซ้ายและขวาต่อลงดินตามปกติหรือไม่

- يحترق الفيوز.**
 - هل السلك الاحمر والاسود موصولة بشكل صحيح؟
- لا يمكن توصيل الطاقة الكهربائية.**
 - هل السلك الأصفر موصول؟
- لا يصدر صوت من السماعات.**
 - هل هناك تقصير في دائرة سلك خرج السماعة؟
- الصوت مشوه.**
 - هل سلك خرج السماعة موصولاً بالأرض؟
 - هل الاطراف السالبة "-" للسماعة اليسرى L واليمنى R موصولة بالأرض مع بعض؟
- يسخن الجهاز.**
 - هل سلك خرج السماعة موصولاً بالأرض؟
 - هل الاطراف السالبة "-" للسماعة اليسرى L واليمنى R موصولة بالأرض مع بعض؟

- **When using the optional stay**
- 若選用支撐架
- **เมื่อใช้ตัวยึดแบบเลือกได้ (สามารถเลือกเปิดค้างไว้ได้)**
• عند استخدام مسند اضافي للتثبيت

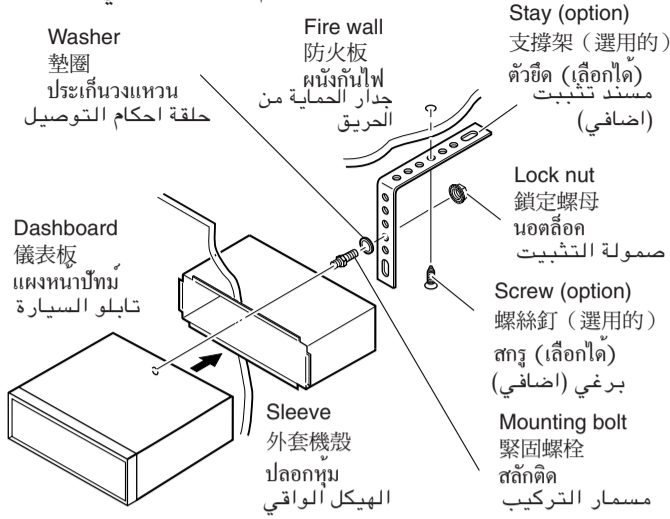

Less than 30°
少於 30°
น้อยกว่า 30 องศา
اقل من ٣٠ درجة

Install the unit at an angle of less than 30°
將本機安裝在少於 30° 的角度。
ติดตั้งชุดประกอบที่มุมต่ำกว่า 30 องศา
قم بتركيب الجهاز בזواوية اقل من ٣٠ درجة

- **When installing the unit without using the sleeve**
- 若不使用外套機殼安裝本機
- **เมื่อติดตั้งชุดประกอบโดยไม่ใช้ปลูกหม**
• عندما تركيب الجهاز بدون استخدام الهيكل الواقي

In a Toyota for example, first remove the car radio and install the unit in its place.
以豐田牌 (TOYOTA) 汽車為例：首先取出汽車收音機，然後將本機裝入其空出的位置。
ตัวอย่างเช่น ในรถยนต์โตโยตา ให้ถอดวิทยุติดรถยนต์ออกก่อนและติดตั้งชุดประกอบนี้เข้าไปแทน
على سبيل المثال، في سيارات نوع تويوتا، اترغ راديو السيارة اولا بعد ذلك ركب الجهاز في مكانه.

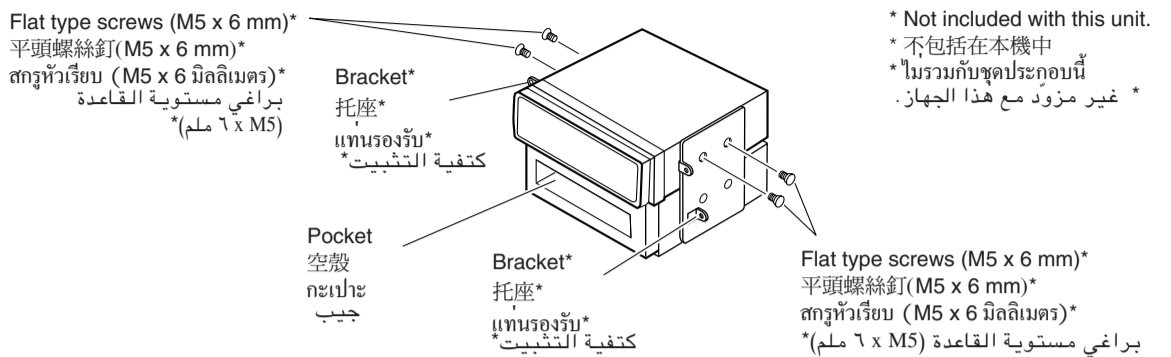

Note: When installing the unit on the mounting brackets, make sure to use the 6 mm-long screws. If longer screws are used, they could damage the unit.
注意：把本機安裝在托座上時，務必使用 6mm 長的螺絲釘。如使用過長的螺絲釘，會損壞本機。

หมายเหตุ: เมื่อติดตั้งชุดประกอบลงในแท่นรองรับไว้ให้ใช้สกรูยาวขนาด 6 มิลลิเมตร ถ้าใช้สกรูยาวกว่านี้อาจทำให้ชุดประกอบเสียหายได้
ملاحظة: عند تركيب الجهاز على كتفية التثبيت، تأكد من استخدام براغي طول ٦ ملم. في حالة استخدام براغي اطول من ٦ ملم، فان ذلك يمكن ان يسبب تلف او ضرر للجهاز.

Removing the unit

- Before removing the unit, release the rear section.
- 1 Remove the control panel.
- 2 Remove the trim plate.
- 3 Insert the 2 handles into the slots, as shown. Then, while gently pulling the handles away from each other, slide out the unit. **(Be sure to keep the handles after installing it.)**

拆卸本機

- 在拆卸本機前，應將本機後部的固定和連接部分鬆開。
- 1 拆下控制面板。
- 2 取下裝飾框。
- 3 按圖所示，將兩片板條型把手插入卡槽，然後輕輕地從兩側向外拉兩片把手，本機隨之拉出。（安裝本機後，務必保存好兩片把手。）

การถอดชุดประกอบ

- ก่อนจะถอดชุดประกอบ ให้ปลดหน้าตัดส่วนท้ายก่อน
- 1 ถอดแผงควบคุม
- 2 ถอดแผ่นโลหะขอบแต่ง
- 3 ใส่คันทันกับ 2 อันลงในร่องสำหรับโชฟพื้นลวด ดังภาพ จากนั้นให้เลื่อนชุดประกอบออก ในขณะที่ค่อย ๆ ดึงคันทันกับทั้งสองอันออกจากกัน (ดูให้ตัวคันทันกับทั้งสองอันอยู่ในตำแหน่งที่เหมาะสมหลังจากติดตั้งแล้ว)

نزع الجهاز من تابلو السيارة

- قبل نزع الجهاز، حرر الجزء الخلفي.
- 1 انزع لوحة التحكم.
- 2 انزع لوحة الزينة.
- 3 ادخل المساكين داخل الشقوق، كما هو مبين في الشكل. بعد ذلك، اثناء سحب المساكين بلطفة بعيدا الواحدة عن الاخرى، اسحب الجهاز الى الخارج. (تأكد من احتفاظك بالمساكين بعد تركيب الجهاز.)

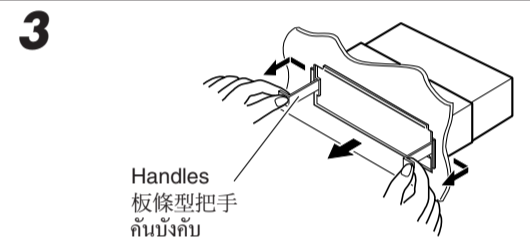
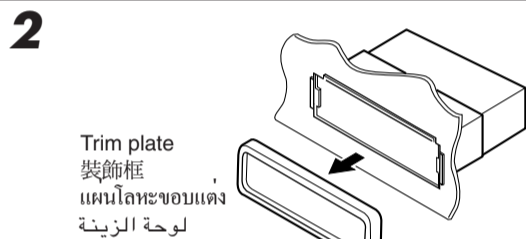
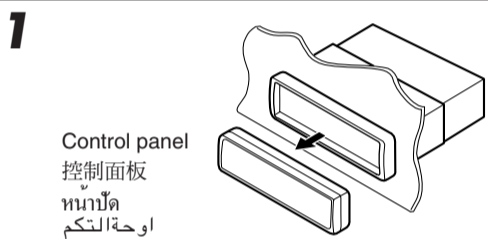

Parts list for installation and connection

The following parts are provided with this unit. After checking them, please set them correctly.

用於安裝和連接的零件裏

下列零件是隨本機提供的。清點以後，正確的將其裝配。

รายการส่วนประกอบสำหรับติดตั้งและเชื่อมต่อกัน

ส่วนประกอบต่อไปนี้ใหม่กับชุดประกอบนี้ หลังจากตรวจสอบแล้ว ปรับตั้งเครื่องให้ถูกต้อง

قائمة اجزاء التركيب والتوصيل

الاجزاء التالية مزودة مع الجهاز. بعد فحص هذه الاجزاء، يرجى تركيبهم بشكل صحيح.

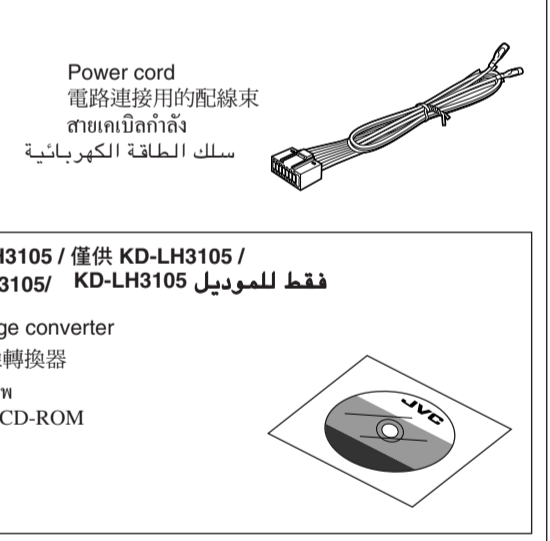
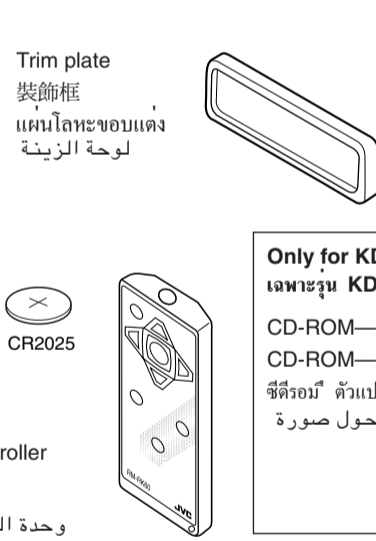
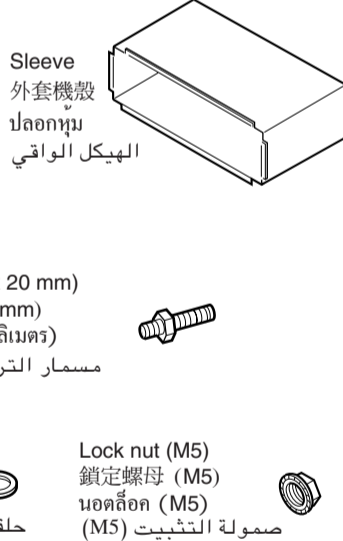
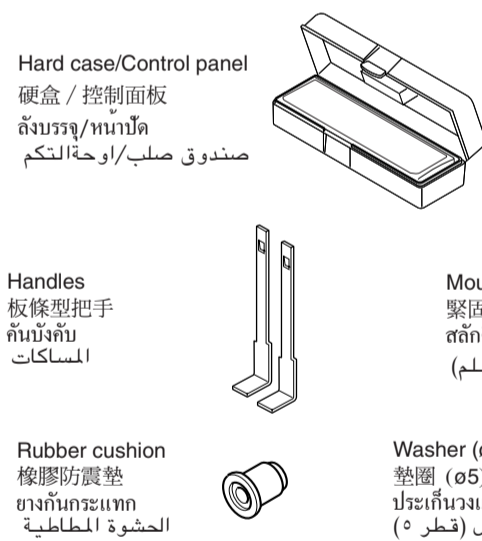

ELECTRICAL CONNECTIONS

電路連接

การเชื่อมโดยไฟฟ้า

التوصيلات الكهربائية

To prevent short circuits, we recommend that you disconnect the battery's negative terminal and make all electrical connections before installing the unit. If you are not sure how to install this unit correctly, have it installed by a qualified technician.

為防止短路，建議在安裝本機之前，斷開電池的負極，並把所有電路都連接好。如果您不能確定如何正確地安裝本機，應請合格的技術人員來安裝。

เพื่อป้องกันไฟฟ้าลัดวงจรเราขอแนะนำให้คุณเอาขั้วลบแบตเตอรี่ออกก่อนและทำการเชื่อมโดยไฟฟ้าทุกจุดก่อนที่จะติดตั้งชุดประกอบจากนั้นให้ตรวจสอบและปรับตั้งเครื่องให้ถูกต้อง

لمنع حدوث تقصير في الدوائر الكهربائية، نوصي بفصل طرف البطارية السالب ثم عمل التوصيلات الكهربائية قبل تركيب الجهاز. في حالة عدم معرفتك بكيفية تركيب الجهاز بشكل صحيح، يرجى ترك عملية تركيب الجهاز لشخص مختص ومؤهل لتركيب مثل هذه الاجهزة.

Note: This unit is designed to operate only on 12 V DC, **NEGATIVE ground electrical systems.** If your vehicle does not have this system, a voltage inverter is required, which can be purchased at JVC car audio dealers.

注意: 本機僅可使用直流 12V、負極接地的電源系統。如果您的車輛沒有這一電源系統，則需要一個電壓變換器，可以在 JVC 汽車音響分銷商處買到。

หมายเหตุ: ชุดประกอบชุดนี้ได้รับการออกแบบมาเพื่อใช้งานกับระบบกระแสไฟฟ้าสายดินขั้วลบกระแสตรง 12 โวลท์ หากรถยนต์ของคุณไม่ได้ใช้ระบบนี้ ต้องใช้เครื่องแปลงกระแสไฟฟ้า

ملاحظة: لقد صمم هذا الجهاز ليعمل فقط بواسطة تيار كهربائي مباشر DC، ١٢ فولت، أنظمة كهربائية تاريز سالب. في حالة عدم وجود مثل هذا النظام في سيارتك، يجب استخدام محول فولتاج، ويمكن شراء هذا المحول من وكلاء الاجهزة الصوتية للسيارات ماركة JVC.

- Replace the fuse with one of the specified rating. If the fuse blows frequently, consult your JVC car audio dealer.
- If noise is a problem... This unit incorporates a noise filter in the power circuit. However, with some vehicles, clicking or other unwanted noise may occur. If this happens, connect the unit's rear ground terminal (see connection diagram) to the car's chassis using shorter and thicker cords, such as copper braiding or gauge wire. If noise still persists, consult your JVC car audio dealer.
- Maximum input of the speakers should be more than 50 W at the rear and 50 W at the front, with an impedance of 4 Ω to 8 Ω.
- **Be sure to ground this unit to the car's chassis.**
- The heat sink becomes very hot after use. Be careful not to touch it when removing this unit.

- 把保險絲更換為額定負荷值的保險絲。如果保險絲經常燒壞，請向 JVC 汽車音響分銷商詢問。
- 若出現噪音問題... 本機在電源回路帶有一個噪音濾波器。但是，在某些車輛上，會出現咯咯聲或其它噪音。如果發生這類情況，將本機後面的接地端子用短而粗的導線，如編織銅線或標準電纜，連接到汽車底盤上（參閱電路接線圖）。如果噪音仍然持續存在，請向 JVC 汽車音響分銷商詢問。
- 後置和前置揚聲器的最大輸入功率應大於 50 W 其阻抗為 4 Ω - 8 Ω。
- 務必將本機的地線接到汽車底盤上。
- 本機使用後，散熱片會很熱。因此，在移出本機時，小心不要觸摸散熱片。

- ชุดประกอบชุดนี้มีเครื่องกรองเสียงในวงจรกำลัง อย่างไรก็ตาม บางคันก็อาจเกิดเสียงที่ไม่พึงปรารถนาขึ้นได้ หากปัญหานี้เกิดขึ้น ให้ต่อขั้วสายดินด้านหลังของชุดประกอบ (ดูแผนภูมิการต่อเชื่อมด้าน) เข้ากับเชตซีลของรถยนต์โดยสายเคเบิลที่สั้นและหนากว่า เช่น สายไฟหรือสายประสาทองแดง เป็นต้น หากยังมีเสียงอยู่อีก ให้ปรึกษาร้านขายเครื่องเสียงรถยนต์ JVC
- ระดับอินพุตที่ติดตั้งของลำโพงควรตั้งเกินกว่า 50 วัตต์ และ 50 วัตต์ ทั้งลำโพงหลังและลำโพงหน้า โดยมีอิมพีแดนซ์ในระดับ 4 Ω - 8 Ω
- ตรวจสอบให้แน่ใจว่าได้ต่อชุดประกอบชุดนี้ลงในแชสซีรถยนต์แล้ว
- แผนระบายความร้อนจะร้อนมากหลังจากใช้ ระดับระวังอย่าไปสัมผัสเมื่อถอดชุดประกอบนี้

- استبدال الفيوز بآخر يحمل نفس القياسات الموصوفة. اذا تكرر احتراق الفيوز، يرجى استشارة وكلاء الاجهزة الصوتية للسيارات ماركة JVC.
- اذا كان الضجيج هو المشكلة... يستخدم هذا الجهاز فلتر ضجيج داخل دائرة الطاقة الكهربائية. مع ذلك، في بعض السيارات، يمكن ان يحدث نوع من الطقطقة او الضجيج غير المرغوب. في حالة حدوث مثل ذلك، اوصل طرف التاريز الموجود في خلفية الجهاز (انظر رسم التوصيل في الاسفل) مع هيكل السيارة بواسطة استخدام اسلاك اقصر واسمك، مثل سلك النحاس الجدول او سلك مقاييسي. في حالة عدم توقف الطقطقة او الضجيج، يرجى استشارة وكلاء الاجهزة الصوتية للسيارات ماركة JVC.
- يجب ان يكون دخل صوت السماعات الاقصى اكثر من ٥٠ واط و ٥٠ واط لكلا من الخلف والامام، مع ممانعة ٤ اوم الى ٨ اوم.
- **تأكد من تاريز الجهاز مع هيكل السيارة.**
- تصبح صفيحة خفض الحرارة ساخنة جدا بعد الاستخدام. تأكد من عدم ملامستها عند نزع الجهاز.



Typical Connections / 典型的接線方法 / การเชื่อมต่อแบบปกติ / التوصيلات النموذجية

Before connecting: Check the wiring in the vehicle carefully. Incorrect connection may cause serious damage to this unit.

The leads of the power cord and those of the connector from the car body may be different in color.

- 1 Connect the colored leads of the power cord to the car battery, speakers and automatic power antenna (if any) in the following sequence. 1 Black: ground 2 Yellow: to car battery (constant 12 V) 3 Red: to an accessory terminal 4 Blue with white stripe: to remote lead of other equipment (200 mA max.) 5 Blue: to automatic antenna if any (250 mA max.) 6 Orange with white stripe: to car light control switch 7 Brown: to cellular phone system (For details, refer to the instructions of the cellular phone) 8 Others: to speakers

接線前：仔細檢查汽車內的線路。不正確的接線會導致本機嚴重損壞。電力線的引線和車身的連接器引線在顏色上可能有所不同。

- 1 按下順序將配線束各個不同色標的導線接頭分別接至電池、揚聲器和自動電源升降天線（如有裝設）： 1 黑色：接地 2 黃色：接至車裝電池（恆定 12V） 3 紅色：接至保險絲單元內的附屬端子 4 藍色帶有白色條紋：接至其他音響設備（最大 200 mA） 5 藍色：接至自動升降天線（最大 250 mA） 6 橙色帶有白色條紋：接至汽車燈光控制轉換器 7 褐色：接至流動電話系統（詳情請參閱流動電話手冊） 8 其他：接至揚聲器

ก่อนทำการเชื่อมต่อ: ตรวจสอบ อากาศภายในรถยนต์ อย่างระมัดระวัง การเชื่อมต่อที่ไม่ถูกต้อง อาจก่อให้เกิดความเสียหายร้ายแรงต่อชุดลำโพงและกล่องวิทยุของคุณ

- 1 ต่อสายต่อสีของสายไฟเข้ากับแบตเตอรี่รถยนต์ ลำโพง และเสาอากาศพาวเวอร์อัตโนมัติ (ถ้ามี) ตามลำดับต่อไปนี้ 1 สีดำ : สายดิน 2 สีเหลือง : ต่อกับแบตเตอรี่รถยนต์ (12 โวลท์คงที่) 3 สีแดง : ต่อกับขั้วส่วนประกอบ 4 สายสีฟ้าที่มีแถบขาว : ต่อเข้ากับอุปกรณ์อื่น (ขนาดสูงสุด 200 mA) 5 สีฟ้า : ต่อเข้ากับเสาอากาศอัตโนมัติ (ขนาดสูงสุด 250 mA) 6 สีส้มแถบขาว : ต่อกับสวิทช์ควบคุมไฟของรถยนต์ 7 สีน้ำตาล : ต่อกับโทรศัพท์เคลื่อนที่ (สำหรับรายละเอียด ดูคู่มือโทรศัพท์เคลื่อนที่) 8 สีอื่น ๆ : ต่อกับลำโพง

قبل البدء بالتوصيل: تأكد من شبكة الاسلاك في السيارة بدقة حتى لا يحدث خطأ في عملية توصيل الجهاز. يمكن ان يسبب التوصيل الخاطيء الى حصول عطل حقيقي للجهاز. يمكن ان يختلف لون سلك الطاقة الكهربائية وسلك الموصل عن لون هيكل السيارة.

- 1 اوصل الاسلاك الملونة لسلك تزويد الطاقة الكهربائية مع بطارية السيارة، السماعات والهوائي الأوتوماتيكي (إن وجد) حسب التسلسل التالي. 1 السلك الاسود: مع الارض 2 السلك الاصفر: مع بطارية السيارة (ثابت ١٢ فولت) 3 السلك الاحمر: مع الطرف الاضافي 4 السلك الازرق المخطط بالابيض: مع الاجهزة الأخرى (الحد الأقصى ٢٠٠ ميلي أمبير) 5 السلك الازرق المخطط بالابيض: مع الهوائي الأوتوماتيكي (الحد الأقصى ٢٥٠ ميلي أمبير) 6 الشريط البرتقالي مع الابيض: الى مفتاح التحكم بضوء السيارة 7 البني: الى جهاز الهاتف الخليوي (من اجل التفاصيل، ارجع الى تعليمات تشغيل الهاتف الخليوي) 8 الاسلاك الأخرى: مع السماعات

- Before connecting the CD changer, make sure that the unit is turned off. • 連接 CD 轉換器之前，應先將本機關閉。 • ก่อนเชื่อมต่อเครื่องเล่นซีดี กรุณาตรวจสอบให้แน่ใจว่าเครื่องเล่นซีดีนั้นปิดอยู่ • قبل توصيل مبدل الاسطوانة المدمجة CD، تأكد من إيقاف تشغيل الجهاز.

JVC CD changer jack JVC CD轉換器插座 หัวเสียบของเครื่องเล่นซีดี ชื่อ JVC مقبس الاسطوانة المدمجة JVC ماركه CD

We recommend you to connect the JVC MP3-compatible CD changer. You can also connect other CH-X series CD changers (except CH-X99 and CH-X100). You cannot use the KD-MK series CD changers with this unit. Only for KD-LH1105: You can also use an external component such as a portable MD player by connecting the Line Input Adapter KS-U57 (not supplied). (See diagram B.)

我們建議您連接 JVC MP3 兼容的 CD 換碟器。您也可連接其它 CH-X 系列的 CD 換碟器 (CH-X99 和 CH-X100 除外)。本機無法讓您與 KD-MK 系列的 CD 換碟器共同使用。僅供 KD-LH1105: 您可以通過連接線輸入適配器 KS-U57 (未提供) 來使用外接部件，如手提式 MD 播放機等。(參閱圖表 B) หมายเหตุ: ขอแนะนำให้อัดซีดีเล่นเจอรูที่ สามารถทำงานร่วมกับ JVC MP3 กับ เครื่องเล่นของคุณ คุณสามารถต่อซีดีเจอรูอื่น ๆ ได้ (ยกเว้นรุ่น CH-X99 และ CH-X100) • คุณไม่สามารถใช้ซีดีเล่นเจอรู KD-MK กับ เครื่องเล่นนี้ • เฉพาะรุ่น KD-LH1105: คุณสามารถใช้อุปกรณ์ภายนอกเช่น เครื่องเล่นเอ็มดีแบบพกพาได้ โดยนำมาเชื่อมต่อกับแอดแapter สายสัญญาณ KS-U57 (ไม่ได้นำมาด้วย) (ดูแผนภูมิ B)

LINE IN—only for KD-LH3105 (see diagram B) 線路輸入—僅供 KD-LH3105 (參閱圖表 B) लाइन इन केवल केवल KD-LH3105 (ดูแผนภูมิ B) (انظر المخطط B) Dowl الخط - فقط للموديل KD-LH3105 (انظر المخطط B)

SUBWOOFER—only for KD-LH3105 (see diagram B) 副低音揚聲器—僅供 KD-LH3105 (參閱圖表 B) سابووفر فقط KD-LH3105 (انظر المخطط B)

Antenna terminal 天線端子 ขาสายอากาศ طرف الهوائي

Rear ground terminal 本機後背接地端子 จุดเชื่อมต่อกับสายดินด้านหลัง طرف التاريض الخلفي

Line out (see diagram B) 輸出端子 (參閱圖表 B) สายออก (Line out) (ดูแผนภูมิ B) خرج الخط (انظر المخطط B)

- *1: Before checking the operation of this unit prior to installation, this lead must be connected, otherwise power cannot be turned on. *1: 本機未安裝時，進行工作狀況檢查之前，必須把這導線接上，否則不能開啟電源。 *1: ก่อนการตรวจสอบการทำงานของชุดประกอบนี้ก่อนที่จะติดตั้ง ต้องต่อสายตัวนี้ก่อน มิฉะนั้นจะไม่สามารถเปิดเครื่องได้ *1: قبل فحص تشغيل هذا الجهاز قبل التركيب، يجب توصيل هذا السلك، حيث لا يمكن تشغيل الجهاز بدون توصيل السلك.

15 A fuse / 15 A 保險絲 / 15 A / 15 ampere

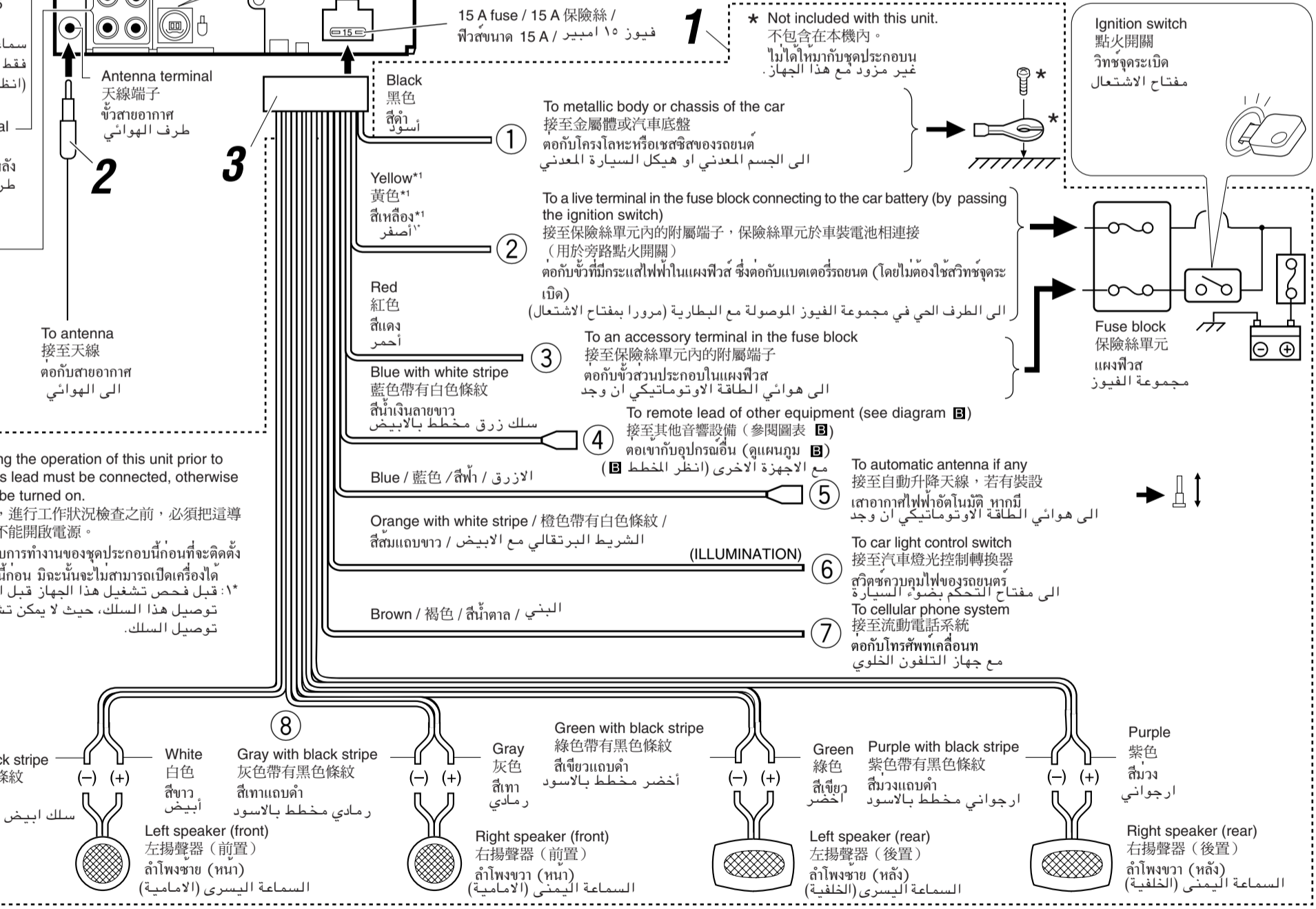

Connecting the leads / 導線接頭的連接 / ต่อสายตะกั่ว / توصيل الاسلاك

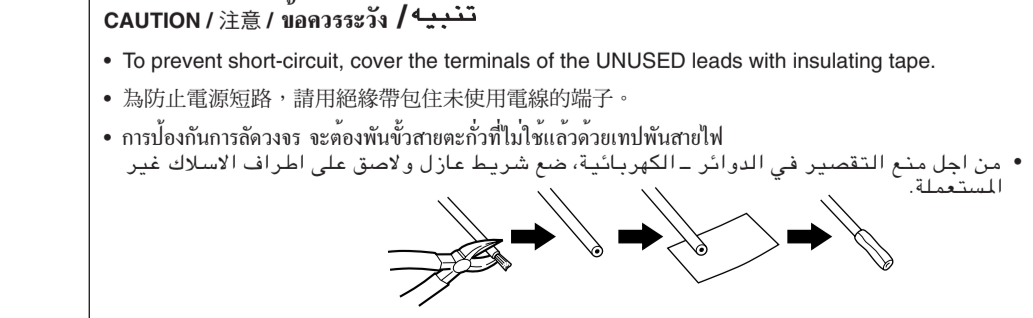
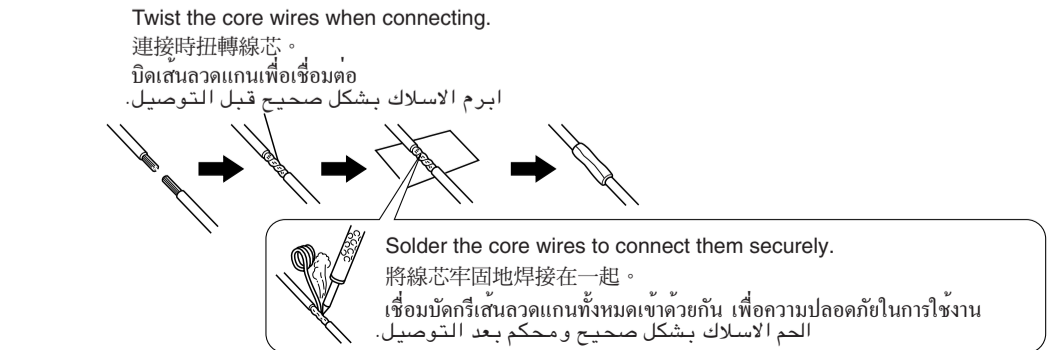

PRECAUTIONS on power supply and speaker connections:

- DO NOT connect the speaker leads of the power cord to the car battery; otherwise, the unit will be seriously damaged.
- Connect the black lead (ground), yellow lead (to car battery, constant 12 V), and red lead (to an accessory terminal) correctly.
- BEFORE connecting the speaker leads of the power cord to the speakers, check the speaker wiring in your car.
 - If the speaker wiring in your car is as illustrated in Fig. 1 and Fig. 2 below, DO NOT connect the unit using that original speaker wiring. If you do, the unit will be seriously damaged. Redo the speaker wiring so that you can connect the unit to the speakers as illustrated in Fig. 3.
 - If the speaker wiring in your car is as illustrated in Fig. 3, you can connect the unit using the original speaker wiring in your car.
 - If you are not sure of the speaker wiring of your car, consult your car dealer.

電源和揚聲器接線注意事項：

- 切勿把揚聲器導線接頭接至電池，否則本機將會嚴重損壞。
- 正確地連接黑色導線接頭（接地）、黃色導線接頭（接車裝電池，恆定 12V）和紅色導線接頭（接至保險絲單元的附屬端子）。
- 在把揚聲器導線接頭接至揚聲器之前，檢查您汽車上的揚聲器線路：
 - 如果您汽車上揚聲器線路像圖 1 和圖 2 所示，不要使用原裝的揚聲器線路。如果使用，本機將嚴重損壞。要重新連接揚聲器線路，可按圖 3 所示，把本機與揚聲器相連接。
 - 如果您汽車上揚聲器線路像圖 3 所示，可使用原裝的揚聲器線路與本機相連接。
 - 如果您不能確定您汽車上揚聲器線路，請向您的汽車分銷商詢問。

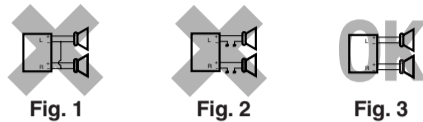

Fig. 1 Fig. 2 Fig. 3

ข้อควรระวังสำหรับการต่อแหล่งจ่ายกำลังและลำโพง:

- อย่าต่อสายตะกั่วแบตเตอรี่ของลำโพงเข้ากับแบตเตอรี่รถยนต์ มิฉะนั้นชุดประกอบจะได้รับความเสียหายมาก
- ต่อสายตะกั่วแต่ละสีให้ถูกต้อง: สีดำ (สายดิน), สีเหลือง (เข้ากับแบตเตอรี่รถยนต์ที่ 12 โวลต์) และสีแดง (เข้ากับขั้วสายประกอบ)
- ก่อนที่จะต่อสายตะกั่วแบตเตอรี่ของลำโพงเข้ากับลำโพงให้ตรวจสอบการเดินสายไฟลำโพงในรถยนต์ของคุณให้เรียบร้อยเสียก่อน
 - หากการเดินสายไฟลำโพงในรถยนต์ของคุณเป็นเหมือนในรูปภาพที่ 1 และรูปภาพที่ 2 ดังข้างล่างนี้: อย่าต่อชุดประกอบที่ใช้การเดินสายไฟลำโพงแบบดั้งเดิมนั้น มิฉะนั้นชุดประกอบจะได้รับความเสียหายมาก ให้จัดการเดินสายไฟลำโพงใหม่ เพื่อที่คุณจะสามารถต่อ ชุดประกอบเข้ากับลำโพงตามรูปภาพที่ 3 ได้
 - หากการเดินสายไฟลำโพงในรถยนต์ของคุณเป็นเหมือนในรูปภาพที่ 3 คุณสามารถต่อชุดประกอบที่ใช้การเดินสายไฟลำโพงแบบดั้งเดิมในรถยนต์ของคุณได้เลย
 - หากคุณไม่แน่ใจว่าการเดินสายไฟลำโพงในรถยนต์ของคุณเป็นแบบใด ให้ปรึกษานักขายรถยนต์ของคุณ

تنبيهات حول تزويد الطاقة الكهربائية وتوصيل السماعات:

- لا توصل اسلاك تزويد طاقة السماعات مع بطارية السيارة، لأن ذلك يؤدي الى حصول ضرر للسماعات.
- اوصل السلك الاسود (الأرضي)، والسلك الاصفر (مع بطارية السيارة، ثابت ١٢ فولت)، والسلك الاحمر (مع الطرف الاضافي) بشكل صحيح.
- قبل توصيل اسلاك تزويد طاقة السماعات مع السماعات، افحص شبكة اسلاك السماعات داخل سيارتك.
 - اذا كانت شبكة اسلاك السماعات داخل سيارتك كما هي مبينة في الشكل ١ والشكل ٢ الموجود في الاسفل، لا توصل الجهاز بواسطة استخدام شبكة اسلاك السماعات الاصلية. اذا تم توصيل الجهاز بهذه الطريقة، سيؤدي ذلك الى حصول ضرر. اعد عمل شبكة اسلاك السماعات بحيث يمكنك توصيل الجهاز مع السماعات كما هو مبين في الشكل ٣.
 - اذا كانت شبكة اسلاك السماعات داخل سيارتك كما هي مبينة في الشكل ٣، يمكنك توصيل الجهاز بواسطة استخدام شبكة اسلاك السماعات الاصلية داخل سيارتك.
 - في حالة عدم معرفتك بشبكة اسلاك السماعات داخل سيارتك، استشر الوكيل او ذوي الخبرة بهذا الخصوص.

Connections Adding Other Equipment / 連接附加的其他音響設備 / การต่อเพิ่มเติมเข้ากับอุปกรณ์อื่น ๆ

- You can connect an amplifier and other equipment to upgrade your car stereo system.
- Connect the remote lead (blue with white stripe) to the remote lead of the other equipment so that it can be controlled through this unit.
 - For amplifier only:
 - Connect this unit's line-out terminals to the amplifier's line-in terminals.
 - Disconnect the speakers from this unit, connect them to the amplifier. Leave the speaker leads of this unit unused. (Cover the terminals of these unused leads with insulating tape, as illustrated.)
 - For KD-LH3105: The line output level of this unit is kept high to maintain the hi-fi sounds reproduced from this unit.
 - When connecting an external amplifier to this unit, turn down the gain control on the external amplifier to obtain the best performance from this unit.
 - For playback source components: After connection is done, adjust and store the input level of each component. (See the INSTRUCTIONS—separate volume.)

- 你可以連接放大器和和其他裝置以加強你的汽車音響系統功能。
- 將遙控線（藍色帶有白色條紋）和其他裝置上的遙控線連接起來，以便可以通過本機進行遙控。
 - 僅適用於放大器：
 - 將本機的輸出終端和放大器輸入終端連接起來。
 - 將揚聲器和本機斷開，再接上放大器。將本機的揚聲器接線放置不用。（按照所示的方式，用絕緣膠把不用的線端包起來。）
 - 供 KD-LH3105: 本機的線路輸出水平保持在高水平以維持自本機重現的高保真度音響。當連接一個外部擴音器至本機時，調低外部擴音器上的增益控制以使本機發揮最佳效能。
 - 供播放源組件：完成連接後，調整並儲存各個組件的輸入水平。（參閱說明書—各別版本。）

توصيل الاجهزة الاخرى الاضافية / การต่อเพิ่มเติมเข้ากับอุปกรณ์อื่น ๆ

- คุณสามารถต่อเครื่องขยายและอุปกรณ์อื่น ๆ เพื่ออัพเกรดระบบเครื่องเสียงในรถยนต์ของคุณได้
- ต่อสายตะกั่วระยะไกล (สีน้ำเงินลายขาว) เข้ากับสายตะกั่วระยะไกลของอุปกรณ์อื่น ๆ เพื่อจะสามารถควบคุมโดยชุดประกอบนี้ได้
 - สำหรับเครื่องขยายเท่านั้น:
 - ต่อขั้วสายออก ของชุดประกอบนี้เข้ากับขั้วสายเข้าของเครื่องขยาย
 - ถอดลำโพงออกจากชุดประกอบนี้ แล้วต่อเข้ากับเครื่องขยายที่สายตะกั่วลำโพงของชุดประกอบนี้ไว้ (พันขั้วของสายตะกั่วที่ไม่ได้ใช้เหล่านี้ให้เรียบร้อยเพื่อป้องกันอันตราย)
 - สำหรับรุ่น KD-LH3105: ตั้งระดับเอาต์พุตของเครื่องไว้สูงเพื่อให้ระบบเสียง ใสไปออกจากเครื่อง เมื่อต่อเครื่อง ขยายเสียงกับเครื่องเล่นไฟล์และระบบควบคุมของ เครื่องขยายเสียงภายนอก เพื่อให้ได้ประสิทธิภาพการทำงาน ที่ดีที่สุดจากเครื่อง
 - สำหรับส่วนประกอบของซอร์สที่ใช้ในการเล่น: หลังจากเชื่อมต่อเสร็จแล้ว ให้ปรับและบันทึกการระดับอินพุตของส่วนประกอบแต่ละชิ้น (โปรดดูที่คำแนะนำ การแยกแยะเสียง)

يمكنك توصيل مضخم صوت وجهاز اخر لتحسين اداء جهاز ستيريو السيارة.

- اوصل سلك التحكم عن بعد (الازرق المخطط بالابيض) مع سلك التحكم عن بعد للجهاز الاخر بحيث يتم التحكم بالجهاز من خلال هذا الجهاز. فقط لمضخم الصوت.
- اوصل اطراف خرج - الخط لهذا الجهاز مع اطراف دخل - الخط لمضخم الصوت.
 - افضل السماعات من هذا الجهاز، اوصلهم مع مضخم الصوت. اترك اسلاك سماعات هذا الجهاز بدون استعمال. (غطي اطراف هذه الاسلاك غير المستعملة بشريط عازل، كما هو موضح في.)
 - للموديل KD-LH3105: مستوى خرج الخط لهذا الجهاز محفوظ بصورة عالية للحفاظ على اصوات الهابي. فاي المتكونة من هذا الجهاز. عند توصيل مضخم صوت خارجي مع هذا الجهاز، اخفض ضابط الكسب الموجود على مضخم صوت الخارجي للحصول على افضل تادية من هذا الجهاز.
 - لتشغيل مصادر اجهزة كميونات: بعد عمل التوصيلات، اضبط واخزن مستوى الدخل لكل جهاز كميونات. (انظر كتيب تعليمات التشغيل - كتاب منفصل.)

Amplifier / 功率放大器 / เครื่องขยาย / مضخم الصوت

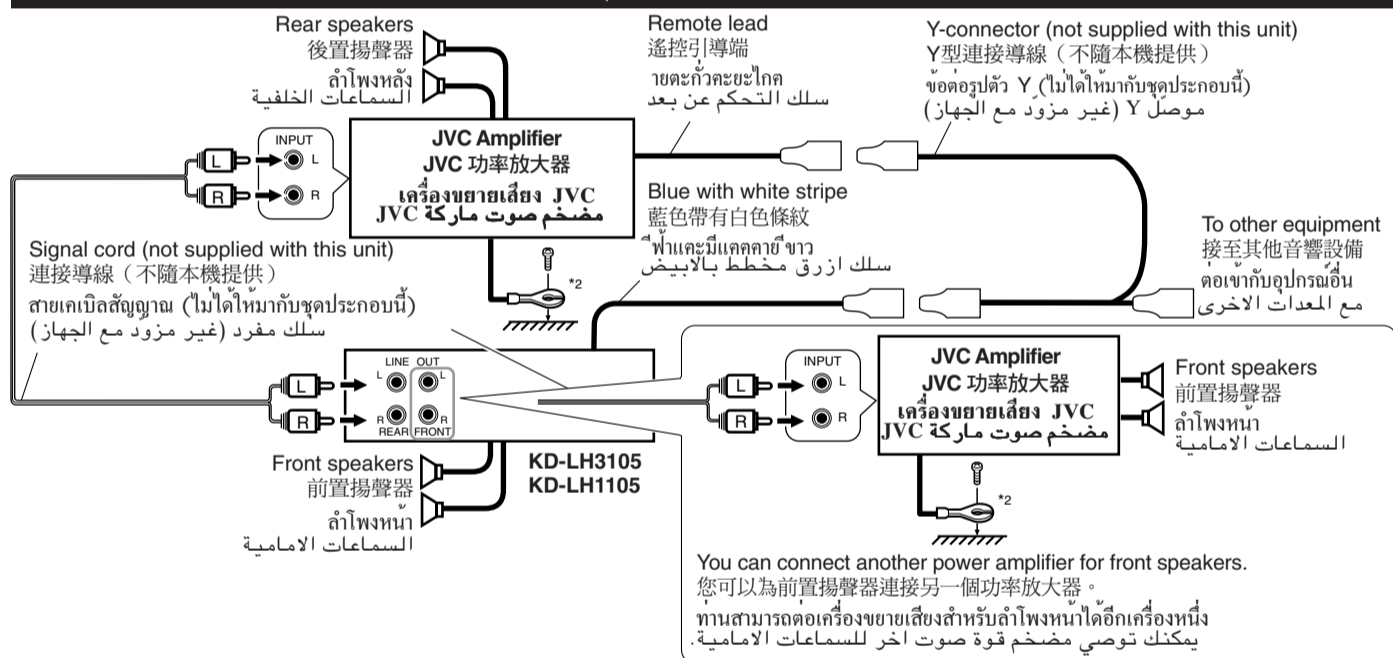

*2: Firmly attach the ground wire to the metallic body or to the chassis of the car—to the place not coated with paint (if coated with paint, remove the paint before attaching the wire). Failure to do so may cause damage to this unit.

*2: 將地線與金屬車體或者汽車底盤緊密連接，連接處應該沒有被油漆覆蓋（如果已塗上油漆，在連接電線前，將油漆刮去）。如果不這樣做，可能會損壞本機。

*2: ต่อลวดสายดินให้แน่นเข้ากับตัวถังเหล็ก หรือตัวถังรถ — ตรงส่วนที่ไม่มีสีเคลือบ (หากมีสีเคลือบอยู่ ให้ขูดสีออกก่อน ก่อนต่อลวดสายดิน) หากไม่ปฏิบัติตามคำแนะนำนี้ เครื่องอาจชำรุดหรือเสียหายได้

*2: 2: اوصل السلك الارضي بشكل محكم مع هيكل او جسم السيارة المعدني - مع الموضع غير المطلي بالدهان (اذا كان الموضع مطلي بالدهان، ازل الدهان قبل توصيل السلك). في حالة توصيل السلك مع الهيكل دون ازالة الدهان يمكن ان يسبب ذلك ضرر لهذا الجهاز.

Subwoofer / 副低音揚聲器 / ขั้ววูฟเฟอร์ / سماعة الزيقر القرعية

- For KD-LH3105 / 供 KD-LH3105 / สำหรับรุ่น KD-LH3105 / KD-LH3105 للموديل**
- You can connect an subwoofer through an amplifier to reinforce the bass.
- For their connections, refer to the instructions supplied with your subwoofer.

- 你可以連接放大器和和其他裝置以加強你的汽車音響系統功能。
- 請按照副低音揚聲器的操作手冊進行連接。

- คุณสามารถต่อเครื่องขยายและอุปกรณ์อื่น ๆ เพื่ออัพเกรดระบบเครื่องเสียงในรถยนต์ของคุณได้
- รายละเอียดเกี่ยวกับการต่อ โปรดดูคำแนะนำที่ใหม่กับขั้ววูฟเฟอร์

- يمكنك تركيب مضخم صوت لتحديث صوت لتحديث جهاز ستيريو سيارتك.
- من اجل التوصيلات، ارجع الى كتيب التعليمات المرفق مع سماعة الويفر القرعية.

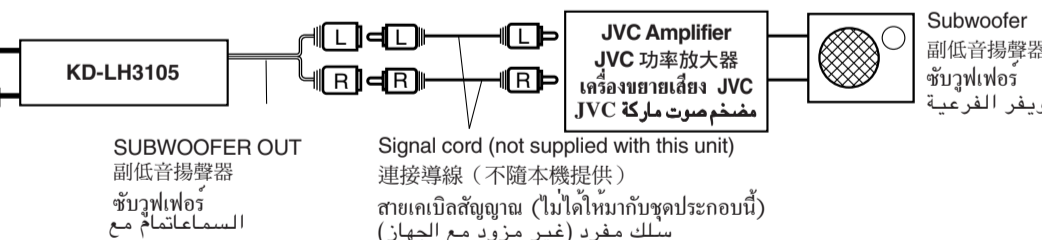

External component / 外接部件 / อุปกรณ์ภายนอก / جهاز الكميونات الخارجي

- For KD-LH3105 / 供 KD-LH3105 / สำหรับรุ่น KD-LH3105 / KD-LH3105 للموديل**

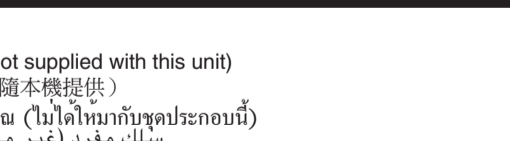

See the INSTRUCTIONS (separate volume) for how to use the external component with this unit. 參閱說明書（各別版本）有關如何與本機一起使用外部組件。

โปรดอ่านคำแนะนำ (การแยกแยะเสียง) สำหรับวิธีการใช้ส่วนประกอบภายนอกกับเครื่องเล่นนี้

انظر كتيب تعليمات التشغيل (كتاب منفصل) لكيفية استعمال جهاز الكميونات الخارجي مع هذا الجهاز.

- For KD-LH1105 / 供 KD-LH1105 / สำหรับรุ่น KD-LH1105 / KD-LH1105 للموديل**

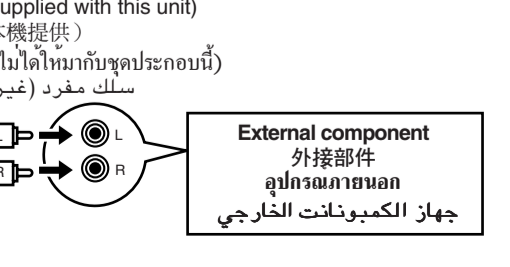
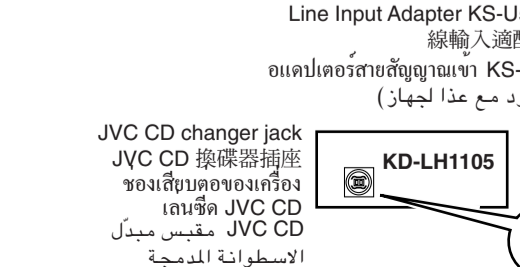

Free Manuals Download Website

<http://myh66.com>

<http://usermanuals.us>

<http://www.somanuals.com>

<http://www.4manuals.cc>

<http://www.manual-lib.com>

<http://www.404manual.com>

<http://www.luxmanual.com>

<http://aubethermostatmanual.com>

Golf course search by state

<http://golfingnear.com>

Email search by domain

<http://emailbydomain.com>

Auto manuals search

<http://auto.somanuals.com>

TV manuals search

<http://tv.somanuals.com>