

JVC



ENGLISH

DEUTSCH

FRANÇAIS

NEDERLANDS

CASSETTE RECEIVER
CASSETTEN-RECEIVER
RADIOCASSETTE
RADIO/CASSETTESPELER

KS-FX772R/KS-FX732R

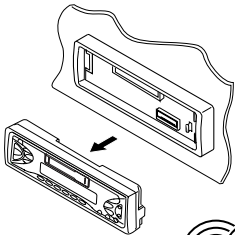

KS-FX772R

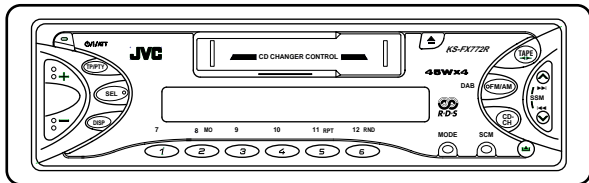

KS-FX732R

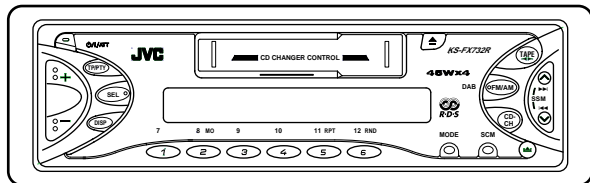

For installation and connections, refer to the separate manual.
Für den Einbau und die Anschlüsse siehe das eigenständige Handbuch.
Pour l'installation et les raccordements, se référer au manuel séparé.
Bijzonderheden over de installatie en aansluiting van het apparaat vindt u in de desbetreffende handleiding.



INSTRUCTIONS
BEDIENUNGSANLEITUNG
MANUEL D'INSTRUCTIONS
GEbruiksaanwijzing

GET0062-001A
[E/EX]

How to reset your unit

Press and hold both the SEL (select) and O/I/ATT (standby/on/attenuator) buttons at the same time for several seconds.

This will reset the built-in microcomputer.

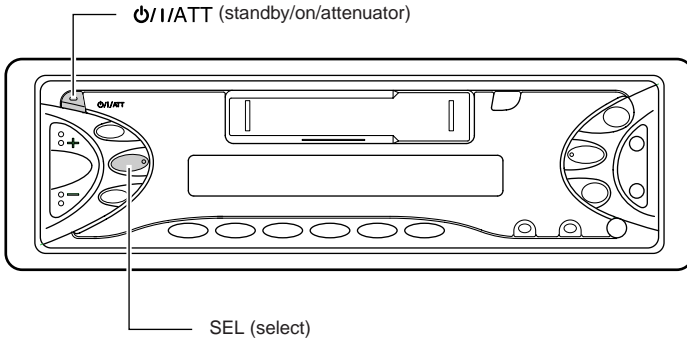

Note:

Your preset adjustments – such as preset channels or sound adjustments – will also be erased.

How to use the number buttons:

If you press MODE, the unit goes into functions mode and the number buttons work as different function buttons.

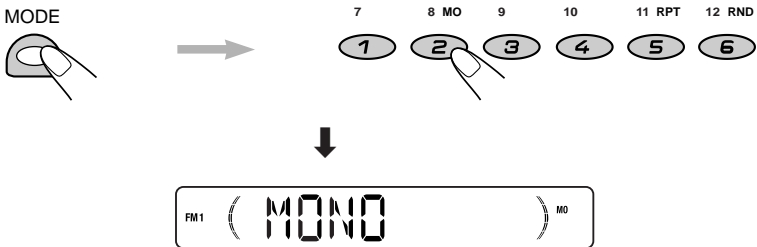

To use these buttons as number buttons again after pressing MODE, wait for 5 seconds without pressing any number button until the functions mode is cleared.

- Pressing MODE again also clears the functions mode.

Thank you for purchasing a JVC product. Please read all instructions carefully before operation, to ensure your complete understanding and to obtain the best possible performance from the unit.

CONTENTS

How to reset your unit	2	OTHER MAIN FUNCTIONS	23
How to use the number buttons	2	Setting the clock	23
LOCATION OF THE BUTTONS	4	Selecting the color of the display window ..	24
Control panel	4	Changing the general settings (PSM)	24
BASIC OPERATIONS	5	Detaching the control panel	27
Turning on the power	5	CD CHANGER OPERATIONS	28
RADIO BASIC OPERATIONS	6	Playing CDs	28
Listening to the radio	6	Selecting CD playback modes	29
Storing stations in memory	8	EXTERNAL COMPONENT OPERATIONS ..	30
Tuning in to a preset station	9	Playing an external component	30
RDS OPERATIONS	10	DAB TUNER OPERATIONS	31
What you can do with RDS	10	Tuning in to an ensemble and one of the	
Other convenient RDS functions and		services	31
adjustments	14	Storing DAB services in memory	32
TAPE OPERATIONS	17	Tuning in to a preset DAB service	33
Listening to a cassette	17	TROUBLESHOOTING	34
Finding the beginning of a tune	18	MAINTENANCE	36
Other convenient tape functions	18	SPECIFICATIONS	37
SOUND ADJUSTMENTS	20		
Adjusting the sound	20		
Using the sound control memory (SCM) ...	21		
Storing your own sound adjustments	22		

Note:

For security reasons, a numbered ID card is provided with this unit, and the same ID number is imprinted on the unit's chassis. Keep the card in a safe place, as it will help the authorities to identify your unit if stolen.

BEFORE USE

***For safety....**

- Do not raise the volume level too much, as this will block outside sounds, making driving dangerous.
- Stop the car before performing any complicated operations.

***Temperature inside the car...**

If you have parked the car for a long time in hot or cold weather, wait until the temperature in the car becomes normal before operating the unit.



LOCATION OF THE BUTTONS

Control panel

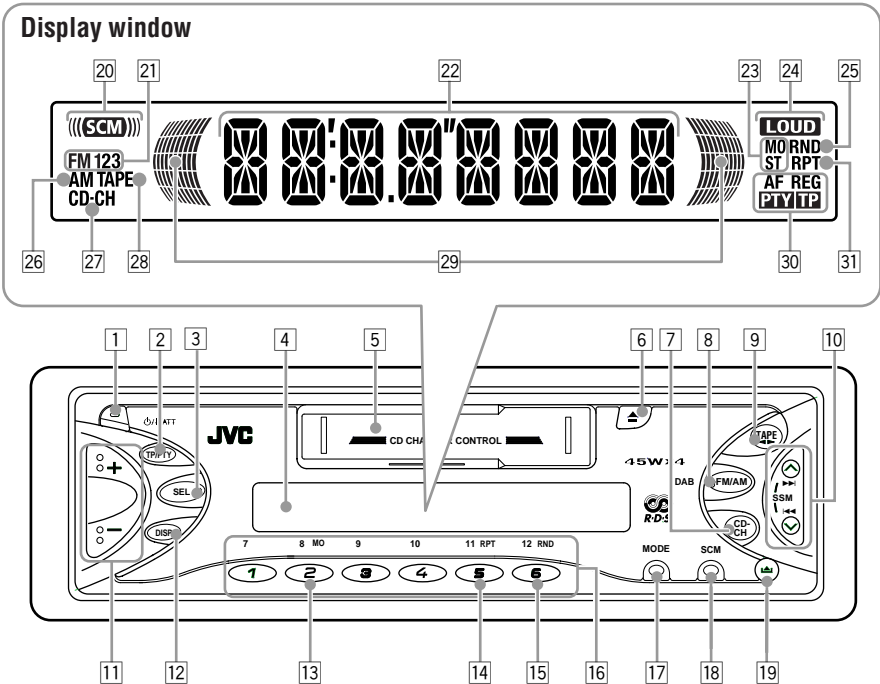

- 1 Φ /I/ATT (standby/on/attenuator) button
- 2 TP (traffic programme)/
PTY (programme type) button
- 3 SEL (select) button
- 4 Display window
- 5 Cassette compartment
- 6 \blacktriangle (eject) button
- 7 CD-CH (CD changer) button
- 8 FM/AM button
 - Also functions as DAB button.
- 9 TAPE $\blacktriangle\blacktriangle$ button
- 10 \blacktriangle \blacktriangleright / \blacktriangleleft \blacktriangledown buttons
 - Also function as SSM buttons when pressed together.
- 11 +/- buttons
- 12 DISP (display) button
- 13 MO (monaural) button
- 14 RPT (repeat) button
- 15 RND (random) button
- 16 Number buttons

- 17 MODE button
- 18 SCM (sound control memory) button
- 19 \blacktriangle (control panel release) button

Display window

- 20 SCM (sound control memory) indicator
- 21 FM band indicator (FM1, FM2, FM3)
- 22 Main display
- 23 Tuner reception indicators
MO (monaural), ST (stereo)
- 24 LOUD (loudness) indicator
- 25 RND (random) indicator
- 26 AM band indicator
- 27 CD-CH (CD changer) indicator
- 28 TAPE indicator
- 29 Volume (or audio) level indicator
- 30 RDS indicators
AF, REG, PTY, TP
- 31 RPT (repeat) indicator

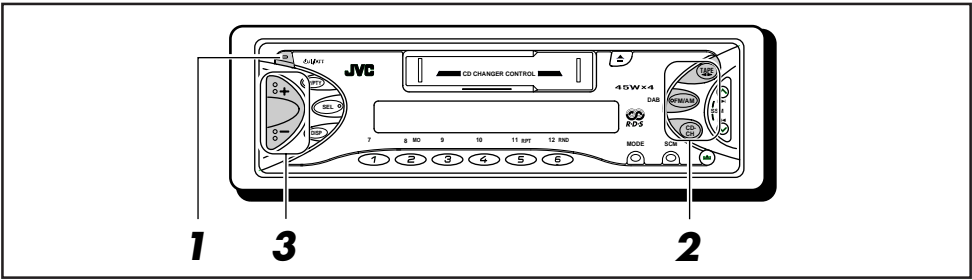

Turning on the power

1 Turn on the power.



Note on One-Touch Operation:

When you select a source in step 2 below, the power automatically comes on. You do not have to press this button to turn on the power.

2 Select the source.

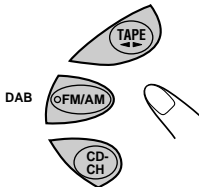

To operate the tuner (FM or AM), see pages 6 – 16.

To operate the tape, see pages 17 – 19.

To operate the CD changer, see pages 28 – 29.

To operate the external component, see page 30.

To operate the DAB tuner, see pages 31 – 33.

3 Adjust the volume.

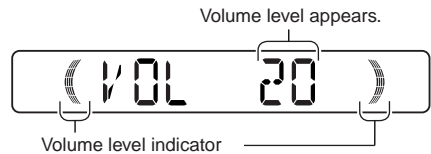
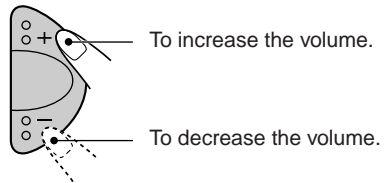

4 Adjust the sound as you want. (See pages 20 – 22.)

To drop the volume in a moment

Press ⏻ /ATT briefly while listening to any source. "ATT" starts flashing on the display, and the volume level will drop in a moment.

To resume the previous volume level, press the button briefly again.

To turn off the power

Press and hold ⏻ /ATT for more than one second.

Note:

When you use this unit for the first time, set the built-in clock correctly, see page 23.

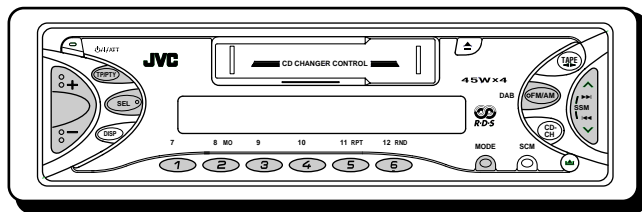

Listening to the radio

You can use either automatic searching or manual searching to tune in to a particular station.

Searching a station automatically: Auto search

1 Select the band (FM1 – 3, AM).

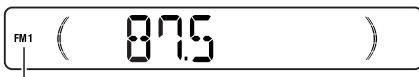
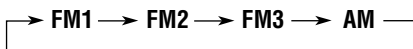

Selected band appears.

Note:

This receiver has three FM bands (FM1, FM2, FM3). You can use any one of them to listen to an FM broadcast.

2 Start searching a station.

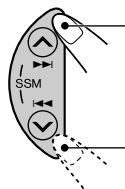

To search stations of higher frequencies.

To search stations of lower frequencies.

When a station is received, searching stops.

To stop searching before a station is received, press the same button you have pressed for searching.

Searching a station manually: Manual search

1 Select the band (FM1 – 3, AM).

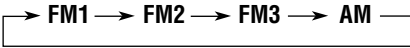

Note:

This receiver has three FM bands (FM1, FM2, FM3). You can use any one of them to listen to an FM broadcast.

2 Press and hold \blacktriangle \blacktriangleright or \blacktriangleleft \blacktriangledown until “M (manual)” starts flashing on the display.

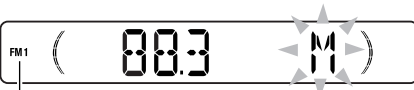
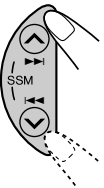

Selected band appears.

3 Tune in to a station you want while “M” is flashing.

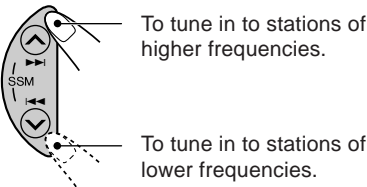

- If you release your finger from the button, the manual mode will automatically turn off after 5 seconds.
- If you hold down the button, the frequency keeps changing (in 50 kHz intervals for FM and 9 kHz intervals for AM – MW/LW) until you release the button.

When an FM stereo broadcast is hard to receive:

- 1 Press MODE to enter the functions mode while listening to an FM stereo broadcast.
- 2 Press MO (monaural), while still in the functions mode, so that the MO indicator lights up on the display.

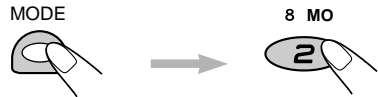

When the MO indicator is lit on the display, the sound you hear becomes monaural but the reception will be improved (the ST indicator goes off).

To restore the stereo effect, repeat steps 1 and 2 so that the MO (monaural) indicator goes off.

Storing stations in memory

You can use one of the following two methods to store broadcasting stations in memory.

- Automatic preset of FM stations: SSM (Strong-station Sequential Memory)
- Manual preset of both FM and AM stations

FM station automatic preset: SSM

You can preset 6 local FM stations in each FM band (FM1, FM2 and FM3).

- 1 Select the FM band (FM1 – 3) you want to store FM stations into.**

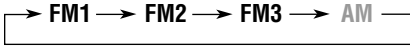

- 2 Press and hold both buttons for more than 2 seconds.**

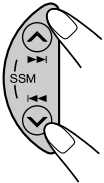

“SSM” appears, then disappears when automatic preset is over.

Local FM stations with the strongest signals are searched and stored automatically in the band number you have selected (FM1, FM2 or FM3). These stations are preset in the number buttons — No.1 (lowest frequency) to No.6 (highest frequency). When automatic preset is over, the station stored in number button 1 will be automatically tuned in.

Manual preset

You can preset up to 6 stations in each band (FM1, FM2, FM3 and AM) manually.

Ex.: Storing an FM station of 88.3 MHz into the preset number 1 of the FM1 band

- 1 Select the band (FM1 – 3, AM) you want to store stations into (in this example, FM1).**

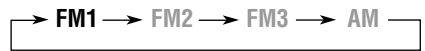
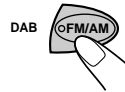

- 2 Tune in to a station (in this example, of 88.3 MHz).**

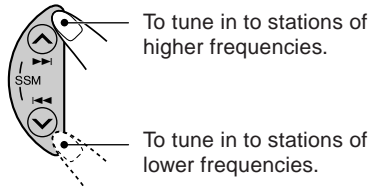

To tune in to stations of lower frequencies.



3 Press and hold the number button (in this example, 1) for more than 2 seconds.



"P1" flashes for a few seconds.

4 Repeat the above procedure to store other stations into other preset numbers.

Notes:

- A previously preset station is erased when a new station is stored in the same preset number.
- Preset stations are erased when the power supply to the memory circuit is interrupted (for example, during battery replacement). If this occurs, preset the stations again.

Tuning in to a preset station

You can easily tune in to a preset station. Remember that you must store stations first. If you have not stored them yet, see "Storing stations in memory" on pages 8 and 9.

1 Select the band (FM1 – 3, AM).

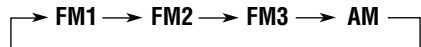

2 Select the number (1 – 6) for the preset station you want.

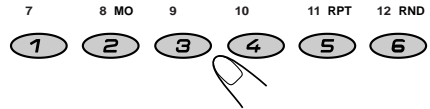



What you can do with RDS

RDS (Radio Data System) allows FM stations to send an additional signal along with their regular programme signals. For example, the stations send their station names, as well as information about what type of programme they broadcast, such as sports or music, etc.

Another advantage of RDS function is called "Enhanced Other Networks." By using the Enhanced Other Networks data sent from a station, you can tune in to a different station of a different network broadcasting your favourite programme or traffic announcement while listening to another programme or to another source such as tape.

By receiving the RDS data, this unit can do the following:

- Tracing the same programme automatically (Network-Tracking Reception)
- Standby Reception of TA (Traffic Announcement) or your favourite programme
- PTY (Programme Type) search
- Programme search
- And some other functions

Tracing the same programme automatically (Network-Tracking Reception)

When driving in an area where FM reception is not good, the tuner built in this unit automatically tunes in to another RDS station, broadcasting the same programme with stronger signals. So, you can continue to listen to the same programme in its finest reception, no matter where you drive. (See illustration on page 11.)

Two types of the RDS data are used to make Network-Tracking Reception work correctly — PI (Programme Identification) and AF (Alternative Frequency).

Without receiving these data correctly from the RDS station you are listening to, Network-Tracking Reception will not operate.

To use Network-Tracking Reception

You can select the different modes of network-tracking reception to continue listening to the same programme in its finest reception. When shipped from the factory, "AF" is selected.

- **AF:** Network-Tracking Reception is activated with Regionalization set to "off." With this setting, the unit switches to another station within the same network when the receiving signals from the current station become weak. (In this mode, the programme may differ from the one currently received.) The AF indicator lights up but the REG indicator does not.
- **AF REG:** Network-Tracking Reception is activated with Regionalization set to "on." With this setting, the unit switches to another station, within the same network, broadcasting the same programme when the receiving signals from the current station become weak. Both the AF indicator and the REG indicator light up.
- **OFF:** Network-Tracking Reception is deactivated. Neither the AF indicator nor the REG indicator lights up.





- 1** Press and hold SEL (select) for more than 2 seconds so that one of the PSM items appears on the display. (PSM: see page 25.)



- 2** Select “AF REG (alternative frequency/Regionalization reception)” if not shown on the display.

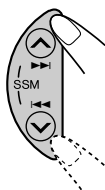

- 3** Select the desired mode – “AF,” “AF REG” or “OFF.”

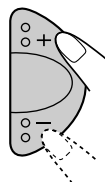

- 4** Finish the setting.



The same programme can be received on different frequencies.

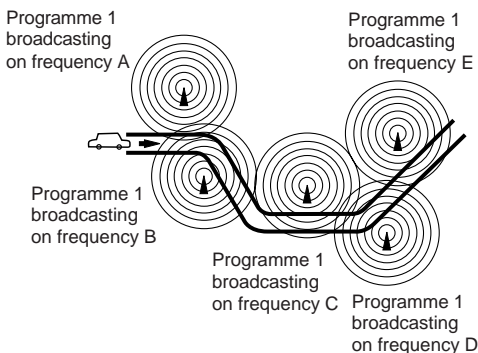

Using TA Standby Reception

TA Standby Reception allows the unit to switch temporarily to Traffic Announcement (TA) from the current source (another FM station, tape or other connected components).

- *TA Standby Reception will not work if you are listening to an AM station.*



Press TP/PTY to activate TA Standby Reception.

- **When the current source is FM**, the TP indicator either lights up or flashes.

- If the TP indicator lights up, TA Standby Reception is activated.

If a station starts broadcasting a traffic announcement, “TRAFFIC” appears on the display, and this unit automatically tunes in to the station. The volume changes to the preset TA volume level (see page 15) and the traffic announcement can be heard.

- If the TP indicator flashes, TA Standby Reception is not yet activated since the station being received does not provide the signals used for TA Standby Reception. To activate TA Standby Reception, you need to tune in to another station providing these signals.

Press \blacktriangle \blacktriangleright or \blacktriangleleft \blacktriangledown to search for such a station.

When a station providing these signals is tuned in, the TP indicator stops flashing and remains lit. Now TA Standby Reception is activated.

- **When the current source is other than FM**, the TP indicator lights up.

If a station starts broadcasting a traffic announcement, “TRAFFIC” appears on the display, and this unit automatically changes the source and tunes in to the station.

To deactivate the TA Standby Reception, press TP/PTY again.



Using PTY Standby Reception

PTY Standby Reception allows the unit to switch temporarily to your favourite programme (PTY: Programme Type) from the current source (another FM station, tape or other connected components).

- *PTY Standby Reception will not work if you are listening to an AM station.*

You can select your favourite programme type for PTY Standby Reception.

When shipped from the factory, PTY Standby Reception is turned off. ("OFF" is selected for PTY Standby Reception.)

- 1 Press and hold SEL (select) for more than 2 seconds so that one of the PSM items appears on the display. (PSM: see page 25.)**



- 2 Select "PTY STBY (standby)" if not shown on the display.**

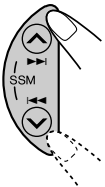

- 3 Select one of the twenty-nine PTY codes. (See page 16.)**

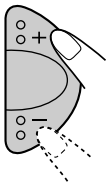

Selected code name appears on the display and is stored into memory.

- To cancel the PTY Standby Reception, select "OFF."

- 4 Finish the setting.**



- **When the current source is FM, the PTY indicator either lights up or flashes.**
 - If the PTY indicator lights up, PTY Standby Reception is activated. If a station starts broadcasting the selected PTY programme, this unit automatically tunes in to the station.
 - If the PTY indicator flashes, PTY Standby Reception is not yet activated since the station being received does not provide the signals used for PTY Standby Reception. To activate PTY Standby Reception, you need to tune in to another station providing these signals. Press ▲▶▶| or |◀◀▼ to search for such a station. When a station providing these signals is tuned in, the PTY indicator stops flashing and remains lit. Now PTY Standby Reception is activated.
- **When the current source is other than FM, the PTY indicator lights up.** If a station starts broadcasting the selected PTY programme, this unit automatically changes the source and tunes in to the station.

To deactivate the PTY Standby Reception, select "OFF" in step 3 on the left column. The PTY indicator disappears.

Searching your favorite programme

You can search any one of the PTY codes. In addition, you can store your 6 favorite programme types in the number buttons.

When shipped from the factory, the following 6 programme types have been stored in the number buttons (1 to 6).

To store your favorite programme types, see below.

To search your favorite programme type, see page 14.

1	2	3
POP M	ROCK M	EASY M
4	5	6
CLASSICS	AFFAIRS	VARIED

To store your favorite programme types

- 1 Press and hold TP/PTY for more than 2 seconds.

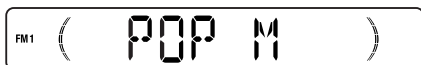

The last selected PTY code appears.

- 2 Select one of the twenty-nine PTY codes. (See page 16.)

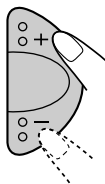

Selected code name appears on the display.

- 3 Press and hold the number button for more than 2 seconds to store the PTY code selected into the preset number you want.

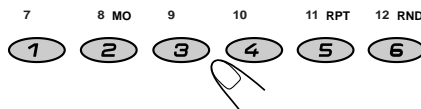

"MEMORY " and the selected code name alternates on the display.

- 4 Press and hold TP/PTY for more than 2 seconds.





To search your favorite programme type

- 1 Press and hold TP/PTY for more than 2 seconds while listening to an FM station.



The last selected PTY code appears.

- 2 Select one of the PTY codes.

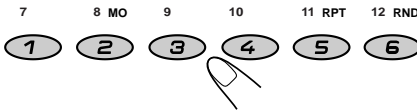

OR

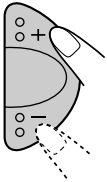

Ex.: When "ROCK M" is selected

- 3 Press \wedge \blacktriangleright or \blacktriangleleft \vee to start PTY search for your favourite programme.

- If there is a station broadcasting a programme of the same PTY code as you selected, that station is tuned in.
- If there is no station broadcasting a programme of the same PTY code as you selected, the station will not change.

Note:

In some areas, the PTY search will not work correctly.

Other convenient RDS functions and adjustments

Automatic selection of the station when using the number buttons

Usually when you press the number button, the preset station is tuned in.

However, when the preset station is an RDS station, something different will happen. If the signals from that preset station are not sufficient for good reception, this unit, using the AF data, tunes in to another frequency broadcasting the same programme as the original preset station is broadcasting. (Programme search)

- The unit takes some time to tune in to another station using Programme search.

To activate programme search, follow the procedure below.

- See also "Changing the general settings (PSM)" on page 24.

- 1 Press and hold SEL (select) for more than 2 seconds so that one of the PSM items appears on the display.
- 2 Press \wedge \blacktriangleright or \blacktriangleleft \vee to select "P(Programme)-SEARCH."
- 3 Press + to select "ON."
Now programme search is activated.
- 4 Press SEL (select) to finish the setting.

To cancel programme search, repeat the same procedure and select "OFF" in step 3 by pressing -.



Changing the display mode while listening to an FM station

You can change the initial indication on the display to station name (PS NAME), station frequency (FREQ) or clock time (CLOCK) while listening to an FM RDS station.

- See also “Changing the general settings (PSM)” on page 24.
- 1 Press and hold SEL (select) for more than 2 seconds so that one of the PSM items appears on the display.
 - 2 Press \blacktriangle \blacktriangleright or \blacktriangleleft \blacktriangledown to select “DISPMODE (display mode).”
 - 3 Press + or – to set to the desired indication (“PS NAME,” “FREQ” or “CLOCK”).
 - 4 Press SEL (select) to finish the setting.

Note:

By pressing DISP (display), you can change the display while listening to an FM RDS station.

Each time you press the button, the following information appears on the display:

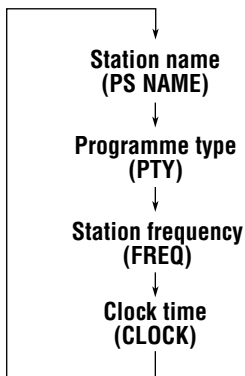

- Then, the display goes back to the original indication in several seconds.

Setting the TA volume level

You can preset the volume level for TA Standby Reception. When a traffic programme is received, the volume level automatically changes to the preset level.

- See also “Changing the general settings (PSM)” on page 24.
- 1 Press and hold SEL (select) for more than 2 seconds so that one of the PSM items appears on the display.
 - 2 Press \blacktriangle \blacktriangleright or \blacktriangleleft \blacktriangledown to select “TA VOL (volume).”
 - 3 Press + or – to set to the desired volume. You can set it from “VOL 00” to “VOL 50.”
 - 4 Press SEL (select) to finish the setting.

Automatic clock adjustment

When shipped from the factory, the clock built in this unit is set to be readjusted automatically using the CT (Clock Time) data in the RDS signal.

If you do not want to use automatic clock adjustment, follow the procedure below.

- See also “Changing the general settings (PSM)” on page 24.
- 1 Press and hold SEL (select) for more than 2 seconds so that one of the PSM items appears on the display.
 - 2 Press \blacktriangle \blacktriangleright or \blacktriangleleft \blacktriangledown to select “AUTO ADJ (adjustment).”
 - 3 Press – to select “OFF.”
Now automatic clock adjustment is canceled.
 - 4 Press SEL (select) to finish the setting.

To reactivate clock adjustment, repeat the same procedure and select “ON” in step 3 by pressing +.

Note:

You must stay tuned to the same station for more than 2 minutes after setting “AUTO ADJ” to “ON.” Otherwise, the clock time will not be adjusted. (This is because the unit takes up to 2 minutes to capture the CT data in the RDS signal.)



PTY codes

NEWS:	News	CHILDREN:	Entertainment programmes for children
AFFAIRS:	Topical programmes expanding on current news or affairs	SOCIAL:	Programmes on social activities
INFO:	Programmes which impart advice on a wide variety of topics	RELIGION:	Programmes dealing with any aspect of belief or faith, or the nature of existence or ethics
SPORT:	Sport events	PHONE IN:	Programmes where people can express their views either by phone or in a public forum
EDUCATE:	Educational programmes	TRAVEL:	Programmes about travel destinations, package tours, and travel ideas and opportunities
DRAMA:	Radio plays	LEISURE:	Programmes concerned with recreational activities such as gardening, cooking, fishing, etc.
CULTURE:	Programmes on national or regional culture	JAZZ:	Jazz music
SCIENCE:	Programmes on natural science and technology	COUNTRY:	Country music
VARIED:	Other programmes like comedies or ceremonies	NATION M:	Current popular music from another nation or region, in that country's language
POP M:	Pop music	OLDIES:	Classic pop music
ROCK M:	Rock music	FOLK M:	Folk music
EASY M:	Easy-listening music	DOCUMENT:	Programmes dealing with factual matters, presented in an investigative style
LIGHT M:	Light music		
CLASSICS:	Classical music		
OTHER M:	Other music		
WEATHER:	Weather information		
FINANCE:	Reports on commerce, trading, the Stock Market, etc.		

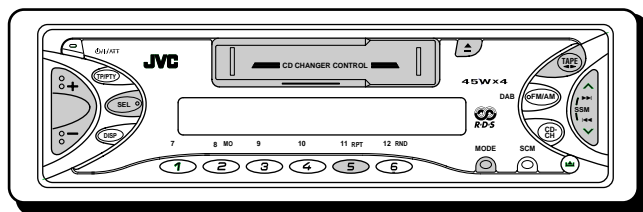

Listening to a cassette

You can play back type 1 (normal) tapes.

1 Insert a cassette into the cassette compartment.

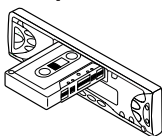

The unit turns on and tape play starts automatically. When one side of the tape reaches its end during play, the other side of the tape automatically starts playing. (Auto Reverse)

Note on One-Touch Operation:

When a cassette is already in the cassette compartment, select tape as the source by pressing TAPE ◀▶ to start tape play.

2 Select the tape direction.



Each time you press TAPE ◀▶, the tape direction changes to forward (▶▶▶) and reverse (◀◀◀) alternately.

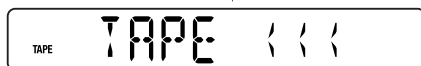

To stop play and eject the cassette

Press ▲.

Tape play stops and the cassette automatically ejects from the cassette compartment. The source changes to the previously selected one. If you change the source, tape play also stops (without ejecting the cassette this time).

- You can eject the cassette while the unit is turned off by pressing ▲.

To fast-forward or rewind a tape

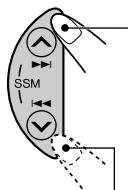

Press ▲▶▶ for more than 1 second to fast-forward the tape. When the tape reaches its end, the tape is reversed and playback starts from the beginning of the other side.

Press ◀◀▼ for more than 1 second to rewind the tape. When the tape reaches its end, playback of the same side starts.

To stop fast forward or rewind at any position on the tape, press TAPE ◀▶.

Tape play starts from that position on the tape.

Notes:

- When one side of the tape reaches its end during play, the other side of the tape automatically starts playing. (Auto Reverse)
- When the tape reaches its end while fast-forwarding, the tape direction will be changed automatically.



Finding the beginning of a tune

Multi Music Scan allows you to automatically start playback from the beginning of a specified tune. You can specify up to 9 tunes ahead of or before the current tune.

During playback

Specify how many tunes ahead of or before the current tune the one you want is located.

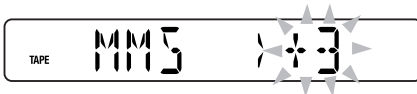
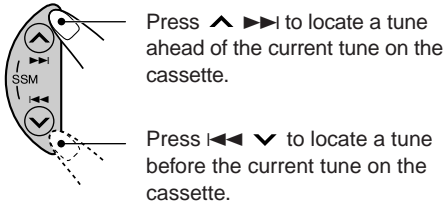

Each time you press the buttons, the number changes up to ± 9 .

When the beginning of the specified tune is located, playback starts automatically.

Notes:

- While locating a specified tune:
 - If the tape is rewound to its beginning, playback starts from the beginning of that side.
 - If the tape is fast-forwarded to the end, it is reversed and played from the beginning of the other side.
- In the following cases, the Multi Music Scan function may not operate correctly:
 - Tapes with tunes having long pianissimo passages (very quiet parts) or non-recorded portions between tunes.
 - Tapes with short non-recorded sections.
 - Tapes with high level of noise or humming between tunes.
 - Tapes with tunes recorded at low recording levels.

Other convenient tape functions

Skipping the blank portions on the tape

You can skip blank portions between the tunes (Blank Skip).

When this function is on, the unit skips blank portions of 15 seconds or more, fast-forwards to the next tune, then starts playing it.

- See also “Changing the general settings (PSM)” on page 24.

- 1** Press and hold SEL (select) for more than 2 seconds so that one of the PSM items appears on the display. (PSM: see page 25.)



- 2** Press ^ >>> or <<< v to select “B. SKIP (blank skip).”

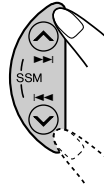

- 3** Press + to select “ON.”

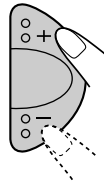

Now Blank Skip is activated.

- 4** Finish the setting.



To cancel Blank Skip, repeat the same procedure and select “OFF” in step 3 by pressing –.



Playing the current tune repeatedly

You can play the current tune repeatedly (Repeat Play).

- 1 Press MODE to enter the functions mode while playing a tune you want to hear over again on a cassette. This unit enters the functions mode.
- 2 Press RPT (repeat), while still in the functions mode, so that the RPT indicator lights up on the display.

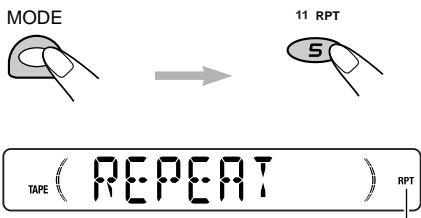

Lights up when Repeat Play is turned on.

When the tune has been played, the tape is automatically rewound to the beginning of that tune and the same tune will be played again.

To cancel Repeat Play, repeat steps 1 and 2 again so that the RPT indicator goes off.

Note:

In the following cases, Blank Skip and Repeat Play may not operate correctly:

- Tapes with tunes having long pianissimo passages (very quiet parts) or non-recorded portions during tunes.
- Tapes with short non-recorded sections.
- Tapes with high level noise or humming between tunes.
- Tapes with tunes recorded at low recording levels.

Prohibiting cassette ejection

You can prohibit cassette ejection and “lock” a cassette in the cassette compartment. Press and hold TAPE ◀▶ and ▲ (eject) for more than 2 seconds.

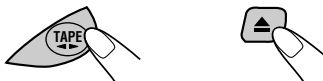

“NO EJECT” flashes on the display for about 5 seconds, and the cassette is “locked.”

To cancel the prohibition and “unlock” the cassette, press and hold TAPE ◀▶ and ▲ (eject) for more than 2 seconds again.



“EJECT OK” flashes for about 5 seconds, and this time the cassette is “unlocked.”

Note:

If you press ▲ while cassette ejection is prohibited, the cassette will not be ejected.



SOUND ADJUSTMENTS

Adjusting the sound

You can adjust the sound characteristics to your preference.

1 Select the item you want to adjust.



Each time you press the button, the adjustable items change as follows:

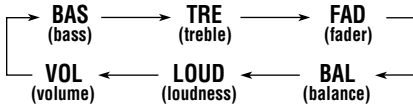

2 Adjust the level.

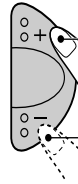

To increase the level.

To decrease the level.



Note:

Normally, the +/- buttons work as the volume control. So you do not have to select "VOL" to adjust the volume level.

Indication	To do:	Range
BAS	Adjust the bass.	-06 (min.) +06 (max.)
TRE	Adjust the treble.	-06 (min.) +06 (max.)
FAD*	Adjust the front and rear speaker balance.	R06 (Rear only) F06 (Front only)
BAL	Adjust the left and right speaker balance.	L06 (Left only) R06 (Right only)
LOUD	Boost low and high frequencies to produce a well-balanced sound at low volume level.	LOUD ON LOUD OFF
VOL	Adjust the volume.	00 (min.) 50 (max.)

* If you are using a two-speaker system, set the fader level to "00."

Using the sound control memory (SCM)

You can select and store a preset sound adjustment suitable for each playback source (**Advanced SCM**).

Selecting and storing the sound modes

Once you select a sound mode, it is stored in memory. It will be recalled every time you select the same source and will be shown on the display. A sound mode can be stored for each of the following sources — FM1, FM2, FM3, AM, tape and external components.

- If you do not want to store the sound mode separately for each playback source, but want to use the same sound mode for all the sources, see “To cancel Advanced SCM – SCM LINK” on page 26.

Select the sound mode you want.

SCM



Ex.: When you select “BEAT”

Each time you press the button, the sound mode changes as follows:



- When “SCM LINK” is set to “LINK ON,” the selected sound mode can be stored in memory for the current source and the effect applies only to the current source.
- When “SCM LINK” is set to “LINK OFF,” the selected sound mode effect applies to any source.

Indication	For:	Preset values		
		BAS	TRE	LOUD
SCM OFF	(Flat sound)	00	00	ON
BEAT	Rock or disco music	+02	00	ON
SOFT	Quiet background music	+01	-03	OFF
POP	Light music	+04	+01	OFF

Recalling the sound modes

When “SCM LINK” is set to “LINK ON,” select the source.

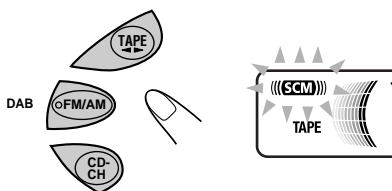

Each time you change the playback source, the SCM indicator flashes on the display.

The sound mode stored in memory for the selected source (in this case, tape) is recalled.

Notes:

- You can adjust each sound mode to your preference, and store it in memory.
If you want to adjust and store your original sound mode, see “Storing your own sound adjustments” on page 22.
- To adjust the bass and treble reinforcement levels or to turn on/off the loudness function temporarily, see page 20. (Your adjustments will be canceled if another source is selected.)



Storing your own sound adjustments

You can adjust the sound modes (BEAT, SOFT, POP) to your preference and store your own adjustments in memory.

- There is a time limit in doing the following procedure. If the setting is canceled before you finish, start from step 1 again.

1 Call up the sound mode you want to adjust.

SCM

- See page 21 for details.



Ex.: When you select "SOFT"

2 Select "BAS (bass)," "TRE (treble)" or "LOUD (loudness)."



3 Adjust the bass or treble level or turn the loudness function ON/OFF.

- See page 20 for details.

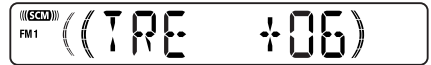
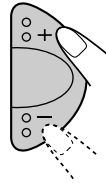

4 Repeat steps 2 and 3 to adjust the other items.

5 Press and hold SCM until the sound mode you have selected in step 1 flashes on the display.

SCM



Your adjustment made for the selected sound mode is stored in memory.

6 Repeat the same procedure to store other sound modes.

To reset to the factory settings

Repeat the same procedure and reassign the preset values listed in the table on page 21.

Setting the clock

You can also set the clock system to either 24 hours or 12 hours.

- 1** Press and hold SEL (select) for more than 2 seconds so that one of the PSM items appears on the display. (See page 25.)



- 2** Set the hour.

- 1 Select "CLOCK H (hour)" if not shown on the display.
- 2 Adjust the hour.

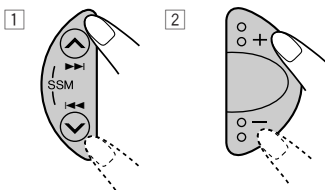

- 3** Set the minute.

- 1 Select "CLOCK M (minute)."
- 2 Adjust the minute.

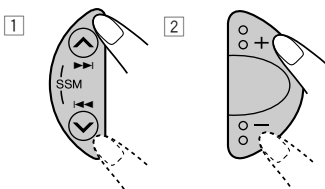

- 4** Set the clock system.

- 1 Select "24H/12H."
- 2 Select "24H" or "12H."

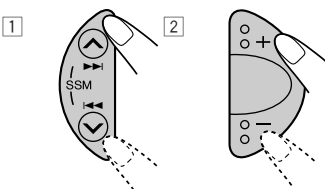

- 5** Finish the setting.



To check the current clock time or change the display mode

Press DISP (display) repeatedly. Each time you press the button, the display mode changes as follows:

- During tuner operation:

Clock ↔ Frequency

Notes:

- For the indication change during RDS operation, see page 15.
- For the indication change during DAB operation, see page 32.

- During tape operation:

Clock ↔ Play mode (tape direction)

- During external component operation:

Clock ↔ LINE IN

- During CD changer operation:

Clock → Elapsed playing time → Disc number

- During power off:

The power turns on and the clock time is shown for 5 seconds, then the power turns off.

Selecting the color of the display window

This section is only for KS-FX772R.

You can select the color of the display window according to your preference. When shipped from the factory, "ALL DEMO" is selected.

- ALL DEMO: The color changes every 30 seconds.
- SOURCE: The color changes according to the source you choose (FM/AM, TAPE, CD Changer or the external component).
- BLUE 1: Blue color 1.
- BLUE 2: Blue color 2.
- PURPLE 1: Purple color 1.
- PURPLE 2: Purple color 2.
- RED 1: Red color 1.
- RED 2: Red color 2.

1 Press and hold DISP (display) for more than 2 seconds so that one of the colors listed above appears on the display.

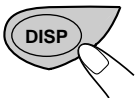

2 Select the color you want.

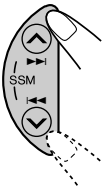

3 Finish the setting.

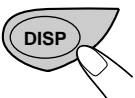

Changing the general settings (PSM)

You can change the items listed on the next page by using the PSM (Preferred Setting Mode) control.

Basic Procedure

1 Press and hold SEL (select) for more than 2 seconds so that one of the PSM items appears on the display. (See page 25.)



2 Select the PSM item you want to adjust. (See page 25.)

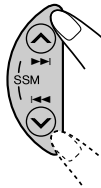

3 Adjust the PSM item selected.

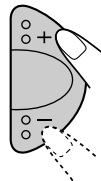

4 Repeat steps 2 and 3 to adjust the other PSM items if necessary.

5 Finish the setting.

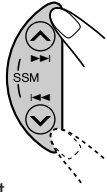
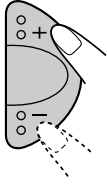

Preferred Setting Mode (PSM) items

1  Hold.	2  Select.	3  Set.		Factory-preset settings	See page
		-	+		
CLOCK H	Hour adjustment	Back	Advance	0:00	23
CLOCK M	Minute adjustment	Back	Advance		
SCM LINK	Sound control memory linkage	LINK OFF	LINK ON	LINK ON	21, 26
24H/12H	24/12-hour time display	12H	24H	24H	23
AUTO ADJ	Automatic clock setting	OFF	ON	ON	15
DISPMODE	Display mode	PS NAME ↔ FREQ ↕ CLOCK ↕		PS NAME	15
CH DISP	Changer display	TIME	DISC	DISC	26
AF REG	Alternative frequency/ Regionalization reception	AF ↔ AF REG ↕ OFF ↕		AF	10, 11
PTY STBY	PTY standby	OFF → 29 programme types ↕ (see page 16)		OFF	11, 12
TA VOL	Traffic announcement volume	VOL 00 – VOL 50		VOL 20	15
P-SEARCH	Programme search	OFF	ON	OFF	14
LEVEL	Level display	AUDIO 1 ↔ AUDIO 2 ↕ OFF ↕		AUDIO 2	26
TEL	Telephone muting	OFF ↔ MUTING 1 ↕ MUTING 2 ↕		OFF	26
B. SKIP	Blank skip	OFF	ON	OFF	18
EXT IN*	External component	CHANGER	LINE IN	CHANGER	26, 30

• Press SEL (select) to finish the setting.

* Displayed only when one of the following sources is selected – FM, AM and Tape.

To cancel Advanced SCM – SCM LINK

You can cancel the Advanced SCM (Sound Control Memory), and unlink the sound modes and the playback sources.

When shipped from the factory, a different sound mode can be stored in memory for each source so that you can change the sound modes simply by changing the sources.

- **LINK ON:** Advanced SCM (different sound modes for different sources).
- **LINK OFF:** Conventional SCM (one sound mode for all sources).

To select the changer display – CH DISP

You can change the initial indication on the display either to disc number or to elapsed playing time, while using the CD changer.

When shipped from the factory, "DISC" is selected.

- **DISC:** Shows the disc number and track number.
- **TIME:** Shows the elapsed playing time.

To select the level meter – LEVEL

You can select the level display according to your preference.

When shipped from the factory, "AUDIO 2" is selected.

- **AUDIO 1:** Level meter illuminates.
- **AUDIO 2:** Alternates level meter and illumination display.
- **OFF:** Erases the audio level indicator.

To select the telephone muting – TEL

This mode is used when a cellular phone system is connected. Depending on the phone system used, select either "MUTING 1" or "MUTING 2," whichever mutes the sounds from this unit.

When shipped from the factory, this mode is deactivated.

- **MUTING 1:** Select this if this setting can mute the sounds.
- **MUTING 2:** Select this if this setting can mute the sounds.
- **OFF:** Cancels the telephone muting.

To select the external component to use – EXT IN

You can connect the external component to the CD changer jack on the rear using the Line Input Adaptor KS-U57 (not supplied).

To use the external component as the playback source through this unit, you need to select which component – CD changer or external component – to use.

When shipped from the factory, CD changer is selected as the external component.

- **LINE IN:** To use the external component other than CD changer.
- **CHANGER:** To use the CD changer.

Note:

For connecting the Line Input Adaptor KS-U57 and the external component, refer to the Installation/Connection Manual (separate volume).

Detaching the control panel

You can detach the control panel when leaving the car.

When detaching or attaching the control panel, be careful not to damage the connectors on the back of the control panel and on the panel holder.

Detaching the control panel

Before detaching the control panel, be sure to turn off the power.

1 Unlock the control panel.

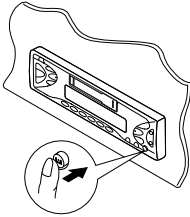

2 Lift and pull the control panel out of the unit.

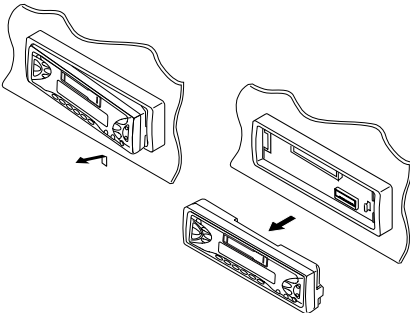

3 Put the detached control panel into the provided case.

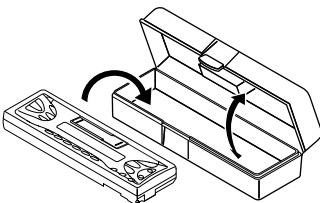

Attaching the control panel

1 Insert the left side of the control panel into the groove on the panel holder.

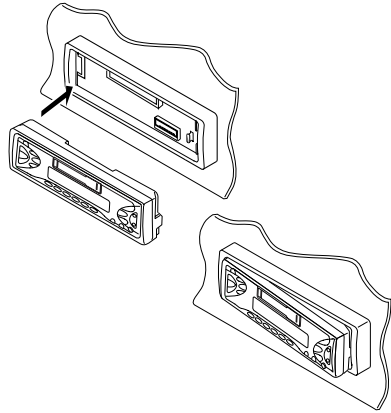

2 Press the right side of the control panel to fix it to the panel holder.

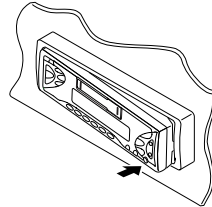

Note on cleaning the connectors:

If you frequently detach the control panel, the connectors will deteriorate.

To minimize this possibility, periodically wipe the connectors with a cotton swab or cloth moistened with alcohol, being careful not to damage the connectors.

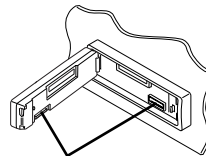

Connectors



CD CHANGER OPERATIONS

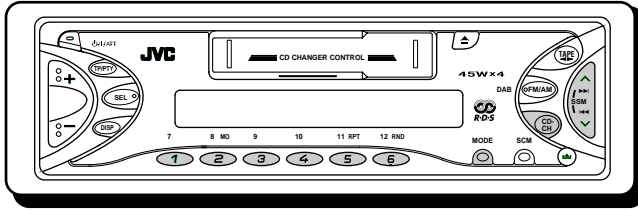

We recommend that you use one of the CH-X series with your unit.

If you have another CD automatic changer, consult your JVC IN-CAR ENTERTAINMENT dealer for connections.

- For example, if your CD automatic changer is one of the KD-MK series, you need a cord (KS-U15K) for connecting it to this unit.

Before operating your CD automatic changer:

- Refer also to the Instructions supplied with your CD changer.
- If no discs are in the magazine of the CD changer or the discs are inserted upside down, "NO DISC" will appear on the display. If this happens, remove the magazine and set the discs correctly.
- If "RESET 1" - "RESET 8" appears on the display, something is wrong with the connection between this unit and the CD changer. If this happens, check the connection and make sure the cords are connected firmly. Then, press the reset button of the CD changer.

Playing CDs

Select the CD automatic changer (CD-CH).



Playback starts from the first track of the first disc.

All tracks of all discs are played back.

- The display shows the following information, depending on the "CH DISP (CD changer display)" setting (see page 25.)

• When "DISC" is selected

Disc number

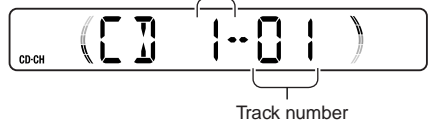

Track number

• When "TIME" is selected

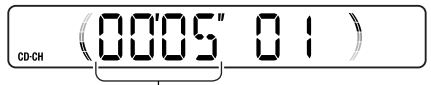

Elapsed playing time

Note on One-Touch Operation:

When you press CD-CH, the power automatically turns on. You do not have to press /I/ATT to turn on the power.

To fast-forward or reverse the track

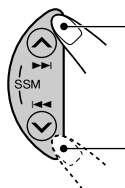

Press and hold , while playing a CD, to fast-forward the track.

Press and hold , while playing a CD, to reverse the track.



To go to the next track or the previous tracks

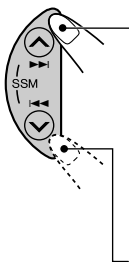

Press **▶▶** briefly, while playing a CD, to go ahead to the beginning of the next track. Each time you press the button consecutively, the beginning of the next tracks is located and played back.

Press **◀◀** briefly, while playing a CD, to go back to the beginning of the current track. Each time you press the button consecutively, the beginning of the previous tracks is located and played back.

To go to a particular disc directly

Press the number button corresponding to the disc number to start its playback (while the CD changer is playing).

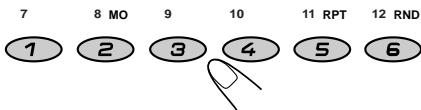

- To select a disc number from 1 – 6: Press 1 (7) – 6 (12) briefly.
- To select a disc number from 7 – 12: Press and hold 1 (7) – 6 (12) for more than 1 second.

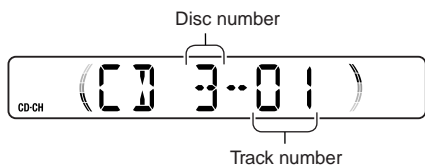

Ex. When disc number 3 is selected

Selecting CD playback modes

To play back tracks at random (Random Play)

- 1 Press **MODE** to enter the functions mode while playing a CD. This unit enters the functions mode.
- 2 Press **RND** (random), while still in the functions mode, so that the **RND** indicator lights up on the display.



Then, each time you repeat steps 1 and 2, CD random play mode changes as follows:



Mode	RND Indicator	Plays at random
RND1 (random1)	Lights	All tracks of the current disc, then the tracks of the next disc, and so on.
RND2 (random2)	Flashes	All tracks of all discs inserted in the magazine.

To play back tracks repeatedly (Repeat Play)

- 1 Press **MODE** to enter the functions mode while playing a CD. This unit enters the functions mode.
- 2 Press **RPT** (repeat), while still in the functions mode, so that the **RPT** indicator lights up on the display.



Then, each time you repeat steps 1 and 2, CD repeat play mode changes as follows:



Mode	RPT Indicator	Plays repeatedly
RPT1 (repeat1)	Lights	The current track (or specified track).
RPT2 (repeat2)	Flashes	All tracks of the current disc (or specified disc).



EXTERNAL COMPONENT OPERATIONS

ENGLISH

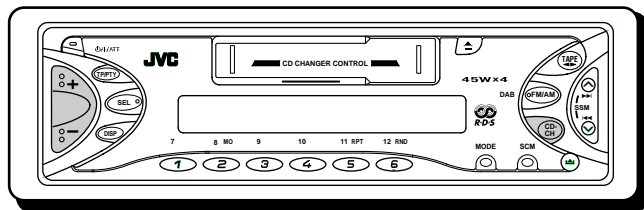

Playing an external component

You can connect the external component to the CD changer jack on the rear using the Line Input Adaptor KS-U57 (not supplied).

Preparations:

- For connecting the Line Input Adaptor KS-U57 and the external component, refer to the Installation/Connection Manual (separate volume).
- Before operating the external component using the following procedure, select the external input correctly. (See "To select the external component to use – EXT IN" on page 26.)

- 1 Select the external component (CD-CH).**



- If "LINE IN"* does not appear on the display, see page 26 and select the external input ("LINE IN").

* Displayed only when one of the following sources is selected — FM, AM and Tape.

Note on One-Touch Operation:

When you press CD-CH, the power automatically comes on. You do not have to press /I/ATT to turn on the power.

- 2 Turn on the connected component and start playing the source.**

- 3 Adjust the volume.**

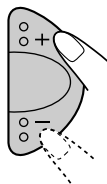

- 4 Adjust the sound characteristics you want. (See pages 20 – 22.)**

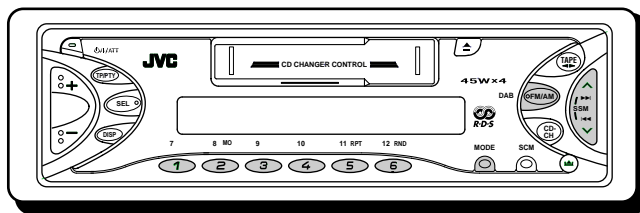

We recommend that you use DAB (Digital Audio Broadcasting) tuner KT-DB1500 with your unit. If you have another DAB tuner, consult your JVC IN-CAR ENTERTAINMENT dealer.

- Refer also to the Instructions supplied with your DAB tuner.

What is DAB system?

DAB is one of the digital radio broadcasting systems available today. It can deliver CD quality sound without any annoying interference and signal distortion. Furthermore, it can carry text, pictures and data.

In contrast to FM broadcast, where each programme is transmitted on its own frequency, DAB combines several programmes (called "services") to form one "ensemble."

With the DAB tuner connected with this unit, you can enjoy these DAB services.

Tuning in to an ensemble and one of the services

A typical ensemble has 6 or more programmes (services) broadcast at the same time. After tuning in to an ensemble, you can select a service you want to listen to.

Before you start....

Press DAB (FM/AM) briefly if tape, CD changer or external component is the current source.

1 Select the DAB tuner.

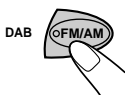

Each time you press and hold the button, the DAB tuner and the FM/AM tuner are alternately selected.

DAB ↔ FM/AM

2 Select the DAB band (DAB1, DAB2, or DAB3).

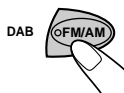

Each time you press the button, the DAB band changes as follows:





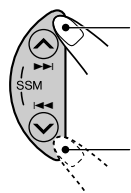

Note:

This receiver has three DAB bands (DAB1, DAB2, DAB3). You can use any of them to tune in to an ensemble.

3 Start searching an ensemble.



Press   to search ensembles of higher frequencies.

Press   to search ensembles of lower frequencies.

When an ensemble is received, searching stops.

To stop searching before an ensemble is received, press the same button you have pressed for searching.

4 Select a service you want to listen to.

MODE



- 1 Press MODE to enter the functions mode while listening to the DAB tuner. This unit enters the functions mode.

CONTINUED ON THE NEXT PAGE

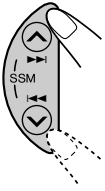

- 2 Press **▲▶▶** or **◀◀▼**, while still in the functions mode to select a service.

To change the display information while tuning in to an ensemble

Normally service name is shown on the display. If you want to change the display information, press DISP (display).

Each time you press the button, the following information appears on the display for a while.

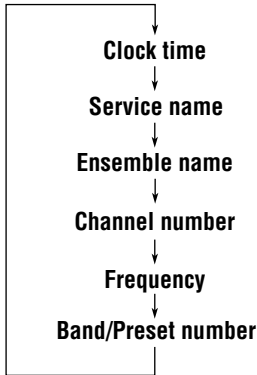

To tune in to a particular ensemble without searching:

- 1 Press and hold DAB (FM/AM) to select DAB tuner as the source.
- 2 Press DAB (FM/AM) repeatedly to select the DAB band (DAB1, DAB2 or DAB3).
- 3 Press and hold **▲▶▶** or **◀◀▼** for more than 1 second.
- 4 Press **▲▶▶** or **◀◀▼** repeatedly until the ensemble you want is reached.
 - If you hold down the button, the frequency keeps changing until you release the button.

To restore the FM/AM tuner

Press and hold DAB (FM/AM) again.

Storing DAB services in memory

You can preset up to 6 DAB services in each DAB band (DAB1, DAB2 and DAB3) manually.

1 Select the DAB tuner.



Each time you press and hold the button, the DAB tuner and the FM/AM tuner are alternately selected.

DAB ↔ FM/AM

2 Select the DAB band (DAB1, DAB2 or DAB3) you want.



Each time you press the button, the DAB band changes as follows:

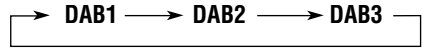

3 Tune in to an ensemble you want.

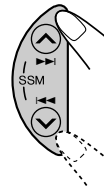

4 Select a service you want to listen to.

MODE



- 1 Press MODE to enter the functions mode while listening to the DAB tuner. This unit enters the functions mode.

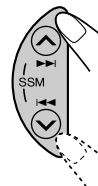

- 2 Press **▲▶▶** or **◀◀▼**, while still in the functions mode to select a service.

- 5** Press and hold the number button (in this example, 1) you want to store the selected service into for more than 2 seconds.



Band/preset number and service name flash alternately for a while.



- 6** Repeat the above procedure to store other DAB services into other preset numbers.

Notes:

- A previously preset DAB service is erased when a new DAB service is stored in the same preset number.
- Preset DAB services are erased when the power supply to the memory circuit is interrupted (for example, during battery replacement). If this occurs, preset the DAB services again.

Tuning in to a preset DAB service

You can easily tune in to a preset DAB service. Remember that you must store services first. If you have not stored them yet, see pages 32 and 33.

- 1** Select the DAB tuner.



Each time you press and hold the button, the DAB tuner and the FM/AM tuner are alternately selected.

DAB ↔ FM/AM

- 2** Select the DAB band (DAB1, DAB2 or DAB3) you want.

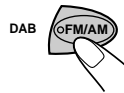

Each time you press the button, the DAB band changes as follows:



- 3** Select the number (1 – 6) for the preset DAB service you want.

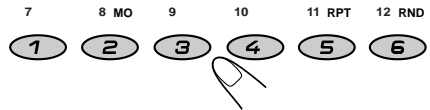



TROUBLESHOOTING

ENGLISH

What appears to be trouble is not always serious. Check the following points before calling a service center.

Symptoms	Causes	Remedies
• A cassette tape cannot be inserted.	You have tried to insert a cassette in the wrong way.	Insert the cassette with the exposed tape facing to the right.
• A cassette tape cannot be ejected.	Cassette ejection is prohibited.	Press and hold TAPE ◀▶ and ▲ for more than two seconds.
• Cassette tapes become hot.	This is not a malfunction.	_____
• Tape sound is at very low level and sound quality is degraded.	The tape head is dirty.	Clean it with a head cleaning tape.
• Sound is sometimes interrupted.	Connections are not good.	Check the cords and connections.
• Sound cannot be heard from the speakers.	The volume is turned to the minimum level.	Adjust it to the optimum level.
	Connections are incorrect.	Check the cords and connections.
• SSM (Strong-station Sequential Memory) automatic preset does not work.	Signals are too weak.	Store stations manually.
• Static noise while listening to the radio.	The antenna is not connected firmly.	Connect the antenna firmly.



Symptoms	Causes	Remedies
• “NO DISC” appears on the display.	No CD is in the magazine.	Insert CDs into the magazine.
	CDs are inserted incorrectly.	Insert them correctly.
• “NO MAG” appears on the display.	No magazine is loaded in the CD changer.	Insert the magazine.
• “RESET 8” appears on the display.	This unit is not connected to a CD changer correctly.	Connect this unit and the CD changer correctly and press the reset button of the CD changer.
• “RESET 1” - “RESET 7” appears on the display.	_____	Press the reset button of the CD changer.
• This unit does not work at all. • The CD changer does not work at all.	The built-in microcomputer may function incorrectly due to noise, etc.	Press and hold both the SEL (select) and  /I/ATT buttons at the same time for several seconds. (The clock setting and preset stations stored in memory are erased.) (See page 2.)



MAINTENANCE

This unit requires very little attention, but you will be able to extend the life of the unit if you follow the instructions below.

To clean the heads

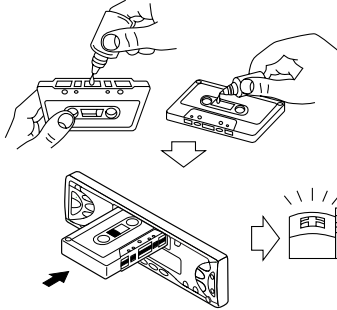

- Clean the heads after every 10 hours of use using a wet-type head cleaning tape (available at an audio store).
When the head becomes dirty, you may realize the following symptoms:
 - Sound quality is reduced.
 - Sound level decreases.
 - Sound drops out.
- Do not play dirty or dusty tapes.
- Do not touch the highly-polished head with any metallic or magnetic tools.

To keep the tape clean

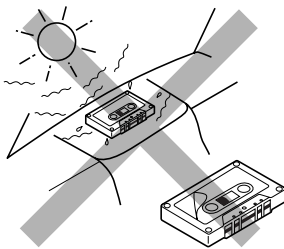

- Always store the cassettes to their storage cases after use.
- Do not store cassettes in the following places:
 - Subject to direct sunlight
 - With high humidity
 - At extremely hot temperatures

CAUTION:

- Do not play the cassettes with peeling labels; otherwise, they can damage the unit.
- Tighten tapes to remove slack since loose tape may become entangled with the mechanism.
- Do not leave a cassette in the cassette compartment after use, as the tape may become slack.

The function below is also provided to ensure the longer life of this unit.

Ignition key-off release/Ignition key-on play

- Turning off the ignition key with a cassette in the compartment automatically releases the tape from the unit's tapehead.
- Turning on the ignition key with a cassette in the compartment starts playback automatically if you turned off the ignition during tape play.

AUDIO AMPLIFIER SECTION

Maximum Power Output:

Front: 45 W per channel

Rear: 45 W per channel

Continuous Power Output (RMS):

Front: 17 W per channel into 4 Ω , 40 Hz to 20 000 Hz at no more than 0.8% total harmonic distortion.

Rear: 17 W per channel into 4 Ω , 40 Hz to 20 000 Hz at no more than 0.8% total harmonic distortion.

Load Impedance: 4 Ω (4 Ω to 8 Ω allowance)

Tone Control Range:

Bass: ± 10 dB at 100 Hz

Treble: ± 10 dB at 10 kHz

Frequency Response: 40 Hz to 20 000 Hz

Signal-to-Noise Ratio: 70 dB

Line-Out Level/Impedance:

2.0 V/20 k Ω load (250 nWb/m)

TUNER SECTION

Frequency Range:

FM: 87.5 MHz to 108.0 MHz

AM: (MW) 522 kHz to 1 620 kHz

(LW) 144 kHz to 279 kHz

[FM Tuner]

Usable Sensitivity: 11.3 dBf (1.0 μ V/75 Ω)

50 dB Quieting Sensitivity:

16.3 dBf (1.8 μ V/75 Ω)

Alternate Channel Selectivity (400 kHz):

65 dB

Frequency Response: 40 Hz to 15 000 Hz

Stereo Separation: 30 dB

Capture Ratio: 1.5 dB

[MW Tuner]

Sensitivity: 20 μ V

Selectivity: 35 dB

[LW Tuner]

Sensitivity: 50 μ V

CASSETTE DECK SECTION

Wow & Flutter: 0.11% (WRMS)

Fast-Wind Time: 100 sec. (C-60)

Frequency Response: 30 Hz to 16 000 Hz
(Normal tape)

Signal-to-Noise Ratio: 56 dB

Stereo Separation: 40 dB

GENERAL

Power Requirement:

Operating Voltage: DC 14.4 V

(11 V to 16 V allowance)

Grounding System: Negative ground

Allowable Operating Temperature: 0°C to +40°C

Dimensions (W \times H \times D):

Installation Size: 182 mm \times 52 mm \times 150 mm

Panel Size: 188 mm \times 58 mm \times 14 mm

Mass: 1.4 kg (excluding accessories)

Design and specifications subject to change without notice.

Having TROUBLE with operation?

Please reset your unit

Refer to page of How to reset your unit

Haben Sie PROBLEME mit dem Betrieb?

Bitte setzen Sie Ihr Gerät zurück

Siehe Seite Zurücksetzen des Geräts

Vous avez des PROBLÈMES de fonctionnement?

Réinitialisez votre appareil

Référez-vous à la page intitulée Comment réinitialiser votre appareil

Hebt u PROBLEMEN met de bediening?

Stel het apparaat terug

Zie de pagina met de paragraaf Het apparaat terugstellen

JVC

VICTOR COMPANY OF JAPAN, LIMITED



EN, GE, FR, NL



1201KKSMDTJEIN

Download from www.Somanuals.com. All Manuals Search And Download.

Free Manuals Download Website

<http://myh66.com>

<http://usermanuals.us>

<http://www.somanuals.com>

<http://www.4manuals.cc>

<http://www.manual-lib.com>

<http://www.404manual.com>

<http://www.luxmanual.com>

<http://aubethermostatmanual.com>

Golf course search by state

<http://golfingnear.com>

Email search by domain

<http://emailbydomain.com>

Auto manuals search

<http://auto.somanuals.com>

TV manuals search

<http://tv.somanuals.com>