

JVC

CD RECEIVER
CD-RECEIVER
RECEPTEUR CD
CD-RECEIVER

KD-LX333R KD-LX111R

COMPACT
disc
DIGITAL AUDIO
TEXT



BBE^{II}



KD-LX333R

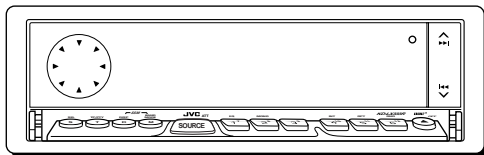

KD-LX111R

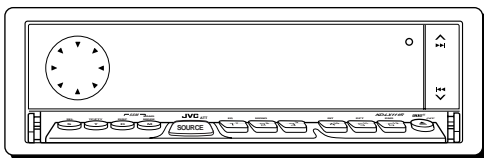

This unit is equipped with the display demonstration. To cancel it, see page 8.
Dieses Gerät ist mit einer Demonstrationsfunktion für das Display ausgestattet. Auf Seite 8 wird beschrieben, wie Sie diese Demonstrationsfunktion deaktivieren können.
Cet appareil est équipé d'une démonstration des affichages. Pour l'annuler, référez-vous à la page 8.
Dit toestel heeft een display-demonstratiefunctie. Zie bladzijde 8 voor het annuleren van deze functie.

For installation and connections, refer to the separate manual.
Angaben zu Einbau und Verkabelung entnehmen Sie bitte der gesonderten Anleitung.
Pour l'installation et les raccordements, se référer au manuel séparé.
Zie de afzonderlijke handleiding voor details aangaande het installeren en verbinden van het toestel.

INSTRUCTIONS

BEDIENUNGSANLEITUNG
MANUEL D'INSTRUCTIONS
GEBRUIKSAANWIJZING

For Customer Use:

Enter below the password you have entered for your security lock.
Retain this password for future reference.

PASSWORD:

PIM171200

[E/EX]

Position And Reproduction Of Labels

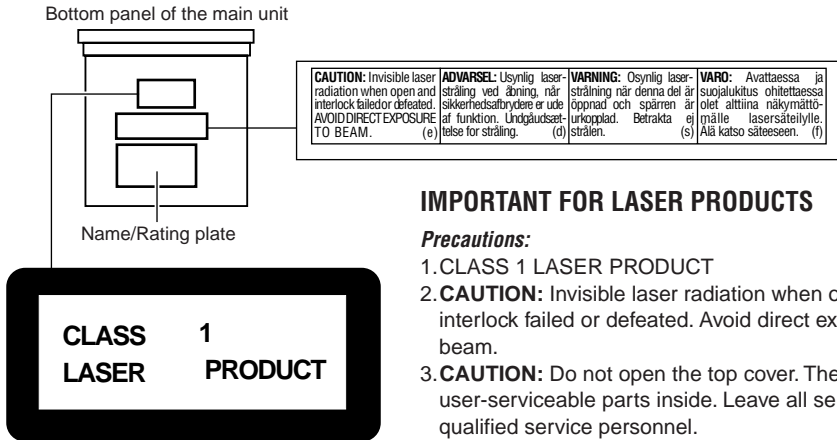

Caution:

This product contains a laser component of higher laser class than Class 1.

IMPORTANT FOR LASER PRODUCTS

Precautions:

1. CLASS 1 LASER PRODUCT
2. **CAUTION:** Invisible laser radiation when open and interlock failed or defeated. Avoid direct exposure to beam.
3. **CAUTION:** Do not open the top cover. There are no user-serviceable parts inside. Leave all servicing to qualified service personnel.
4. **CAUTION:** This CD player uses invisible laser radiation and is equipped with safety switches to prevent radiation emission when unloading CDs. It is dangerous to defeat the safety switches.
5. **CAUTION:** Use of controls, adjustments or performance of procedures other than those specified herein may result in hazardous radiation exposure.

How to reset your unit

Press the reset button on the front panel using a ball-point pen or a similar tool.

This will reset the built-in microcomputer.

Note:

Your preset adjustments — such as preset channels or sound adjustments — will also be erased.

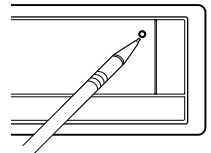

Note:

For security reasons, a numbered ID card is provided with this unit, and the same ID number is imprinted on the unit's chassis. Keep the card in a safe place, as it will help the authorities to identify your unit if stolen.

CAUTION on Volume Setting

CDs produce very little noise compared with other sources. If the volume level is adjusted for the tuner, for example, the speakers may be damaged by the sudden increase in the output level. Therefore, lower the volume before playing a disc and adjust it as required during playback.

Thank you for purchasing a JVC product. Please read all instructions carefully before operation, to ensure your complete understanding and to obtain the best possible performance from the unit.

CONTENTS

How to reset your unit	2	OTHER MAIN FUNCTIONS	25
LOCATION OF THE BUTTONS	4	Changing the general settings (PSM)	25
Control panel	4	Controlling the volume automatically (Audio Cruise) (only for KD-LX333R)	29
How to use the number buttons	4	Assigning names to the sources	30
Preparing the remote controller	5	Using the security lock	32
Remote controller	6	CD CHANGER OPERATIONS	34
BASIC OPERATIONS	7	Playing CDs	34
Turning on the power	7	Selecting CD playback modes	35
Canceling the demonstration	8	EXTERNAL COMPONENT OPERATIONS ...	37
Setting the clock	8	Playing an external component	37
RADIO BASIC OPERATIONS	9	Using a subwoofer (only for KD-LX333R)	37
Listening to the radio	9	DAB TUNER OPERATIONS	38
Storing stations in memory	10	Tuning in to an ensemble and one of the services	38
Tuning in to a preset station	11	Storing DAB services in memory	39
RDS OPERATIONS	12	Tuning in to a preset DAB service	40
What you can do with RDS	12	What you can do more with DAB	41
Other convenient RDS functions and adjustments	16	TROUBLESHOOTING	42
CD OPERATIONS	19	MAINTENANCE	44
Playing a CD	19	Handling CDs	44
Locating a track or a particular portion on a CD	20	SPECIFICATIONS	45
Selecting CD playback modes	20		
Prohibiting CD ejection	21		
Playing a CD Text	21		
SOUND ADJUSTMENTS	22		
Adjusting the sound	22		
What is BBE [®] ?	22		
Selecting preset sound modes (CEQ: custom equalizer)	23		
Storing your own sound adjustments	24		

BEFORE USE

*For safety...

- Do not raise the volume level too much, as this will block outside sounds, making driving dangerous.
- Stop the car before performing any complicated operations.

*Temperature inside the car...

If you have parked the car for a long time in hot or cold weather; wait until the temperature in the car becomes normal before operating the unit.



LOCATION OF THE BUTTONS

Control panel

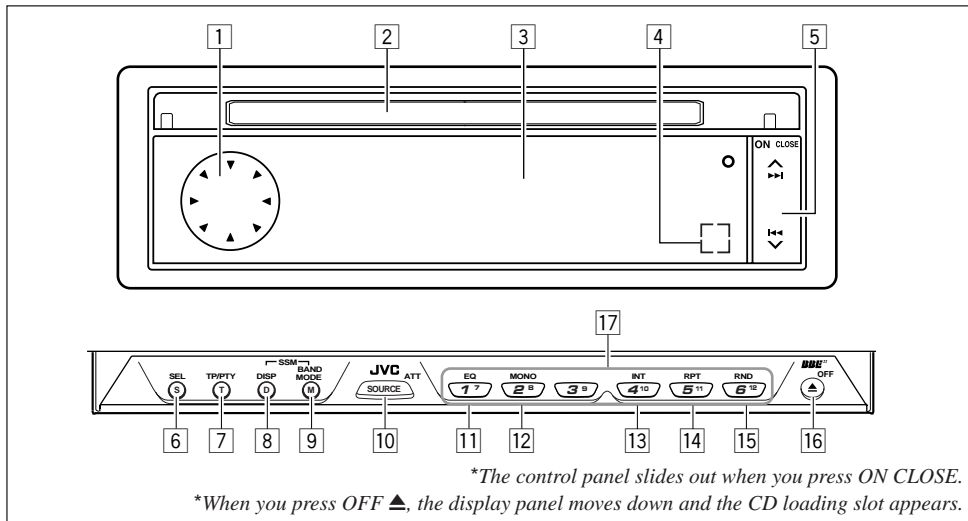

*The control panel slides out when you press ON CLOSE.
 *When you press OFF ▲, the display panel moves down and the CD loading slot appears.

- 1 Control dial
- 2 CD loading slot
- 3 Display panel
- 4 Remote sensor
- 5 ▲▶▶/◀◀▼ buttons
 - ▲▶▶/◀◀▼ also functions as ON or CLOSE button.
- 6 SEL (S) (select) button
- 7 TP/PTY (T) (Traffic Programme/Programme Type) button
- 8 DISP (D) (display) button
 - Also functions as SSM buttons when pressed together with the BAND MODE (M) button.
- 9 BAND MODE (M) button
 - Also functions as SSM buttons when pressed together with the DISP (D) button.
- 10 SOURCE ATT (attenuator) button
- 11 EQ (equalization) button
- 12 MONO (monaural) button
- 13 INT (intro scan) button
- 14 RPT (repeat) button
- 15 RND (random) button
- 16 OFF ▲ (eject) button
- 17 Number buttons

How to use the number buttons:

After pressing BAND MODE (M), the number buttons work as different function buttons (while "MODE" remains on the display).

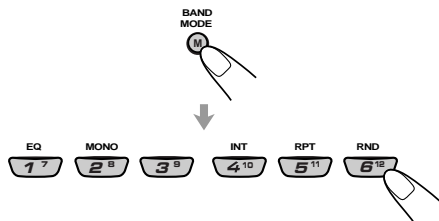

Time countdown indicator

Ex.: When you press button 6 to enter the Random function mode.

To use these buttons as number buttons after pressing BAND MODE (M), wait for 5 seconds without pressing any number button so that "MODE" disappears from the display.

- Pressing BAND MODE (M) again also erases "MODE" from the display.



Preparing the remote controller

This section is only for KD-LX333R.

KD-LX111R can be remotely controlled with an optionally purchased remote controller. We recommend that you use remote controller RM-RK31 or RM-RK50 with your unit.
(Ex.: When you are using RM-RK31.)

Before using the remote controller:

- Aim the remote controller directly at the remote sensor on the main unit. Make sure there is no obstacle in between.

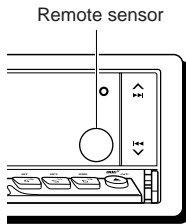

- Do not expose the remote sensor to strong light (direct sunlight or artificial lighting).

Installing the battery

When the controllable range or effectiveness of the remote controller decreases, replace the battery.

1. Remove the battery holder.

- 1) Push out the battery holder in the direction indicated by the arrow using a ball-point pen or a similar tool.
- 2) Remove the battery holder.

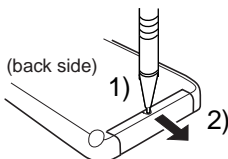

2. Place the battery.

Slide the battery into the holder with the + side facing upwards so that the battery is fixed in the holder.

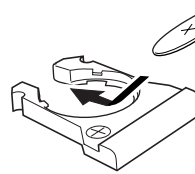

Lithium coin battery
(product number:
CR2025)

3. Return the battery holder.

Insert again the battery holder pushing it until you hear a clicking sound.

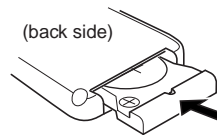

WARNING:

- Store the battery in a place where children cannot reach.
If a child accidentally swallows the battery, consult a doctor immediately.
- Do not recharge, short, disassemble or heat the battery or dispose of in a fire.
Doing any of these things may cause the battery to give off heat, crack or start a fire.
- Do not leave the battery with other metallic materials.
Doing this may cause the battery to give off heat, crack or start a fire.
- When throwing away or saving battery, wrap it in tape and insulate; otherwise, it may cause the battery to give off heat, crack or start a fire.
- Do not poke the battery with tweezers or similar tools.
Doing this may cause the battery to give off heat, crack or start a fire.

CAUTION:

Do not leave the remote controller in a place (such as dashboards) exposed to direct sunlight for a long time. Otherwise, it may be damaged.



Remote controller

RM-RK31

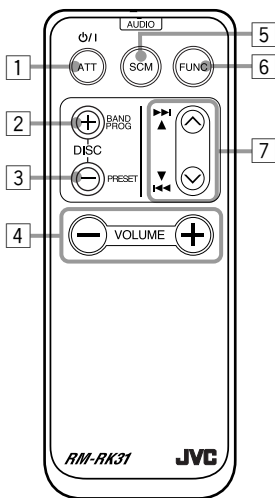

- 1 • Turns on the unit if pressed when the unit is turned off.
 - Turns off the unit if pressed and held until “SEE YOU” appears on the display.
 - Drops the volume level if pressed briefly, and “ATT” rotates on the display. Press again to resume the volume.
- 2 • Functions as the BAND button while listening to an FM broadcast (or the DAB tuner). Each time you press the button, the band changes.
 - Functions as the DISC + button while listening to the CD changer. Each time you press the button, the disc number increases, and the selected disc starts playing.
 - Does not function as the PROG button.
- 3 • Functions as the PRESET button while listening to the radio (or the DAB tuner). Each time you press the button, the preset station number increases, and the selected station is tuned in.
 - Functions as the DISC – button while listening to the CD changer. Each time you press the button, the disc number decreases, and the selected disc starts playing.
- 4 Functions the same as the control dial on the main unit.

NOTE: This button does not function for the preferred setting mode adjustment.
- 5 Selects the sound mode. Each time you press SCM (Sound Control Memory), the CEQ (custom equalizer) mode changes.
- 6 Selects the source. Each time you press FUNC (function), the source changes.
- 7 • Searches stations while listening to the radio.
 - Selects services while listening to the DAB tuner if pressed briefly.
 - Searches ensembles while listening to the DAB tuner if pressed for more than 1 second.
 - Fast-forwards or reverses the track if pressed and held while listening to a CD.
 - Skips to the beginning of the next track or goes back to the beginning of the current (or previous) track if pressed briefly while listening to a CD.

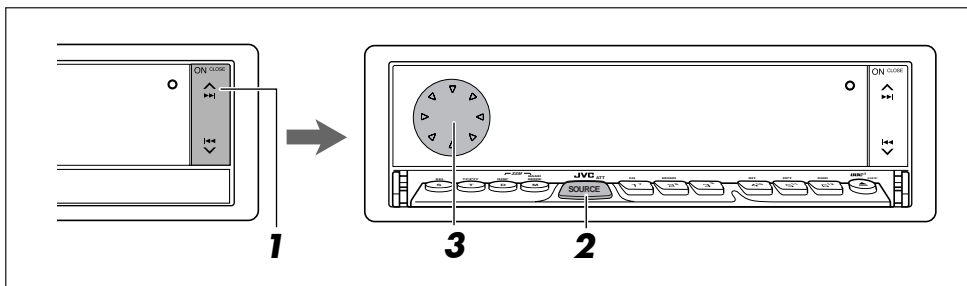

Turning on the power

1 Turn on the power.

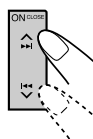

The display illuminates and the control panel and control dial come out.

2 Select the source.

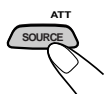

Each time you press the button, the source changes as follows:

For KD-LX333R:

- FM → DAB tuner** → CD*
- CD changer** → External component
- AM → (back to the beginning)

For KD-LX111R:

- FM → DAB tuner** → CD*
- CD changer** (or external component***) → AM
- (back to the beginning)

* If a CD is not in the loading slot, you cannot select CD as the source to play.

** Without connecting the CD changer and/or the DAB tuner, you cannot select it as the source to play.

*** To select the external component, set the "EXT INPUT" setting to "LINE INPUT." (See page 28.)

To operate the tuner (FM or AM), see pages 9 – 11.

To operate the CD player, see pages 19 – 21.

To operate the CD changer, see pages 34 – 36.

To operate the external component, see page 37.

To operate the DAB tuner, see pages 38 – 41.

3 Adjust the volume.

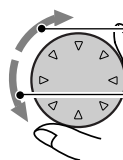

To increase the volume.

To decrease the volume.

Volume level appears.



4 Adjust the sound as you want (see pages 22 – 24).

To drop the volume in a moment

Press SOURCE ATT for more than 1 second while listening to any source. "ATT" rotates on the display, and the volume level will drop in a moment.

To resume the previous volume level, press the button for more than 1 second again.

To turn off the power

Press and hold OFF ▲ until "SEE YOU" appears on the display.

- If you turn off the power while listening to a CD, you can start CD playback from where you have stopped next time you turn on the power.

Note:

When you use this unit for the first time, set the built-in clock correctly, see page 8.

Note on display illustrations:

Illustrations will differ from what appears if "CLOCK DISP" is set to "CLOCK OFF." See page 27.

Canceling the demonstration

When shipped from the factory, demonstration has been activated, and starts automatically when no operations are done for about 20 seconds.

- It is recommended to cancel the demonstration before you use the unit for the first time.

To cancel the demonstration, follow the procedure below.

- 1 Press and hold SEL (S) for more than 2 seconds so that one of the PSM items appears on the display.** (See pages 25 and 26.)



- 2 Select "DEMO MODE" if not shown on the display.**

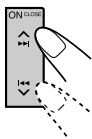

- 3 Select "DEMO OFF."**

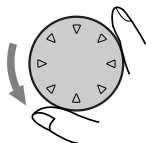

- 4 Finish the setting.**



To activate the demonstration again, repeat the same procedure and select "DEMO ON" in step 3.

Setting the clock

- 1 Press and hold SEL (S) for more than 2 seconds so that one of the PSM items appears on the display.** (See pages 25 and 26.)



- 2 Set the hour.**

- 1 Select "CLOCK HOUR" if not shown on the display.
- 2 Adjust the hour.

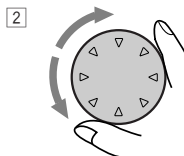
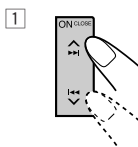

- 3 Set the minute.**

- 1 Select "CLOCK MIN (minute)."
- 2 Adjust the minute.

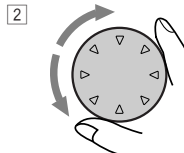
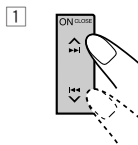

- 4 Set the clock system.**

- 1 Select "24H/12H."
- 2 Adjust "24HOUR" or "12HOUR."

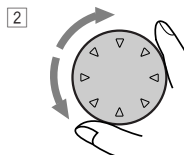
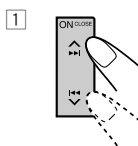

- 5 Finish the setting.**



To check the current clock time with "CLOCK DISP" set to "CLOCK OFF," press DISP (D). The clock time is shown for 5 seconds.

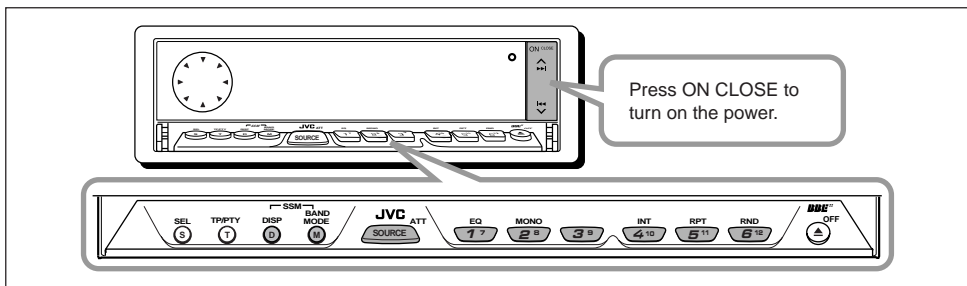

Listening to the radio

You can use either automatic searching or manual searching to tune in to a particular station.

Searching a station automatically: Auto search

1 Select the band.



- 1 Press SOURCE ATT to select FM or AM as the source.



- 2 If necessary, press and hold BAND MODE (M) to select the FM band number (FM1, FM2 or FM3).

Each time you press and hold the button, the FM band changes as follows:



Selected band appears.

Note:

This receiver has three FM bands (FM1, FM2, FM3). You can use any one of them to listen to an FM broadcast.

2 Start searching a station.

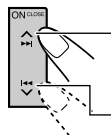

Press $\blacktriangle \blacktriangleright \blacktriangleright$ to search stations of higher frequencies.

Press $\blacktriangleleft \blacktriangleleft \blacktriangledown$ to search stations of lower frequencies.

When a station is received, searching stops.

To stop searching before a station is received, press the same button you have pressed for searching.

Searching a station manually: Manual search

1 Select the band.



- 1 Press SOURCE ATT to select FM or AM as the source.



- 2 If necessary, press and hold BAND MODE (M) to select the FM band number (FM1, FM2 or FM3).

Each time you press and hold the button, the FM band changes as follows:



Note:

This receiver has three FM bands (FM1, FM2, FM3). You can use any one of them to listen to an FM broadcast.



- 2** Press and hold $\wedge \blacktriangleright \blacktriangleright$ or $\blacktriangleleft \blacktriangleleft \vee$ until “M (manual)” starts flashing on the display.



- 3** Tune in to a station you want while “M” is flashing.

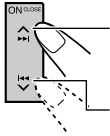

Press $\wedge \blacktriangleright \blacktriangleright$ to tune in to stations of higher frequencies.

Press $\blacktriangleleft \blacktriangleleft \vee$ to tune in to stations of lower frequencies.

- If you release your finger from the button, the manual mode will automatically turn off after 5 seconds.
- If you hold down the button, the frequency keeps changing (50 kHz intervals for FM and 9 kHz intervals for AM – MW/LW) until you release the button.

When an FM stereo broadcast is hard to receive:

1 Press BAND MODE (M) while listening to an FM stereo broadcast (the ST indicator lights up while receiving an FM stereo broadcast). “MODE” appears on the display, and the number buttons can work as different function buttons.

2 Press MONO, while “MODE” is still on the display, so that the MO indicator lights up on the display.

The sound you hear becomes monaural but the reception will be improved (the ST indicator goes off).

Each time you press the button, the MO indicator lights up and goes off alternately.

Storing stations in memory

You can use one of the following two methods to store broadcasting stations in memory.

- Automatic preset of FM stations: SSM (Strong-station Sequential Memory)
- Manual preset of both FM and AM stations

FM station automatic preset: SSM

You can preset 6 local FM stations in each FM band (FM1, FM2 and FM3).

- 1** Select the FM band (FM1 – 3) you want to store FM stations into.

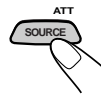

- 1** Press SOURCE ATT to select FM as the source.



- 2** If necessary, press and hold BAND MODE (M) to select the FM band number (FM1, FM2 or FM3).

Each time you press and hold the button, the FM band changes as follows:



- 2** Press and hold both buttons for more than 2 seconds.

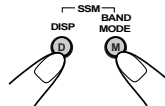

“SSM” appears, then disappears when automatic preset is over.

Local FM stations with the strongest signals are searched and stored automatically in the band number you have selected (FM1, FM2 or FM3). These stations are preset in the number buttons — No.1 (lowest frequency) to No.6 (highest frequency).

When automatic preset is over, the station stored in number button 1 will be automatically tuned in.

Manual preset

You can preset up to 6 stations in each band (FM1, FM2, FM3 and AM) manually.

Ex.: Storing an FM station of 88.3 MHz into the preset number 1 of the FM1 band

1 Select the band (in this example, FM1).

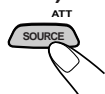

1 Press SOURCE ATT to select FM or AM as the source.



2 Press and hold BAND MODE (M) repeatedly to select the FM1 band.

2 Tune in to a station (in this example, of 88.3 MHz).

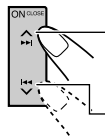

Press \blacktriangle \blacktriangleright to tune in to stations of higher frequencies.

Press \blacktriangleleft \blacktriangleright to tune in to stations of lower frequencies.



3 Press and hold the number button (in this example, 1) for more than 2 seconds.



"PI" flashes for a few seconds.

4 Repeat the above procedure to store other stations into other preset numbers.

Notes:

- A previously preset station is erased when a new station is stored in the same preset number.
- Preset stations are erased when the power supply to the memory circuit is interrupted (for example, during battery replacement). If this occurs, preset the stations again.

Tuning in to a preset station

You can easily tune in to a preset station. Remember that you must store stations first. If you have not stored them yet, see "Storing stations in memory" on pages 10 and 11.

1 Select the band.

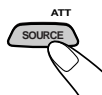

1 Press SOURCE ATT to select FM or AM as the source.

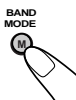

2 If necessary, press and hold BAND MODE (M) to select the FM band number (FM1, FM2 or FM3).

Each time you press and hold the button, the FM band changes as follows:



2 Select the number (1 – 6) for the preset station you want.

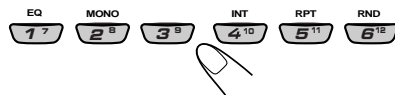

If the sound quality decreases and the stereo effect is lost while listening to an FM station

In some areas, adjacent stations may interfere with each other. If this interference occurs, this unit can automatically reduce this interference noise (the initial setting when shipped from the factory). However, in this case, the sound quality will be degraded and the stereo effect will be also lost.

If you do not want to degrade the sound quality and to lose the stereo effect, rather than to eliminate the interference noise, see "To change the FM tuner selectivity — IF FILTER" on page 28.



What you can do with RDS

RDS (Radio Data System) allows FM stations to send an additional signal along with their regular programme signals. For example, the stations send their station names, as well as information about what type of programme they broadcast, such as sports or music, etc.

Another advantage of RDS function is called "Enhanced Other Networks." By using the Enhanced Other Networks data sent from a station, you can tune in to a different station of a different network broadcasting your favourite programme or traffic announcement while listening to another programme or to another source such as CD.

By receiving the RDS data, this unit can do the following:

- Tracing the same programme automatically (Network-Tracking Reception)
- Standby Reception of TA (Traffic Announcement) or your favourite programme
- PTY (Programme Type) search
- Programme search
- And some other functions

Tracing the same programme automatically (Network-Tracking Reception)

When driving in an area where FM reception is not good, the tuner built in this unit automatically tunes in to another RDS station, broadcasting the same programme with stronger signals. So, you can continue to listen to the same programme in its finest reception, no matter where you drive. (See the illustration on the next page.)

Two types of the RDS data are used to make Network-Tracking Reception work correctly — PI (Programme Identification) and AF (Alternative Frequency).

Without receiving these data correctly from the RDS station you are listening to, Network-Tracking Reception will not operate.

To use Network-Tracking Reception

You can select the different modes of network-tracking reception to continue listening to the same programme in its finest reception. When shipped from the factory, "AF" is selected.

- **AF:** Network-Tracking Reception is activated with Regionalization set to "off." With this setting, the unit switches to another station within the same network when the receiving signals from the current station become weak. (In this mode, the programme may differ from the one currently received.) The AF indicator lights up but the REG indicator does not.
- **AF REG:** Network-Tracking Reception is activated with Regionalization set to "on." With this setting, the unit switches to another station, within the same network, broadcasting the same programme when the receiving signals from the current station become weak. Both the AF indicator and the REG indicator light up.
- **OFF:** Network-Tracking Reception is deactivated. Neither the AF indicator nor the REG indicator lights up.



AF indicator REG indicator



- 1** Press and hold SEL (S) for more than 2 seconds so that one of the PSM items appears on the display. (See pages 25 and 26.)



- 2** Select “AF-REG (Alternative frequency/Regionalization reception)” if not shown on the display.

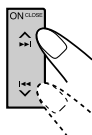

- 3** Select the desired mode – “AF,” “AF REG” or “OFF.”

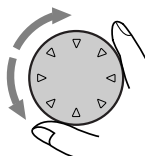

- 4** Finish the setting.



Note:

If a DAB tuner is connected and Alternative Reception (for DAB services) is activated, Network-Tracking Reception is also activated automatically. On the other hand, Network-Tracking Reception cannot be deactivated without deactivating Alternative Reception. (See page 41.)

The same programme can be received on different frequencies.

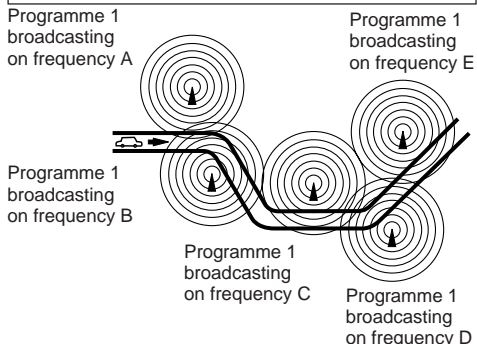

Using TA Standby Reception

TA Standby Reception allows the unit to switch temporarily to Traffic Announcement (TA) from the current source (another FM station or CD and other connected components.)

- TA Standby Reception will not work if you are listening to an AM station.



Press TP/PTY (T) to activate TA Standby Reception.

- When the current source is FM, the TP indicator either lights up or flashes.

- If the TP indicator lights up, TA Standby Reception is activated.

If a station starts broadcasting a traffic announcement, “TRAFFIC” appears on the display, and this unit automatically tunes in to the station. The volume changes to the preset TA volume level (see page 17) and the traffic announcement can be heard.

- If the TP indicator flashes, TA Standby Reception is not yet activated since the station being received does not provide the signals used for TA Standby Reception. To activate TA Standby Reception, you need to tune in to another station providing these signals. Press \blacktriangle \blacktriangleright \blacktriangleleft \blacktriangledown to search for such a station.

When a station providing these signals is tuned in, the TP indicator stops flashing and remains lit. Now TA Standby Reception is activated.

- When the current source is other than FM, the TP indicator lights up.

If a station starts broadcasting a traffic announcement, “TRAFFIC” appears on the display, and this unit automatically changes the source and tunes in to the station.

To deactivate the TA Standby Reception, press TP/PTY (T) again.



Using PTY Standby Reception

PTY Standby Reception allows the unit to switch temporarily to your favourite programme (PTY: Programme Type) from the current source (another FM station or CD).

- *PTY Standby Reception will not work if you are listening to an AM station.*

You can select your favourite programme type for PTY Standby Reception.

When shipped from the factory, PTY Standby Reception is turned off. ("OFF" is selected for PTY Standby Reception.)

- 1 Press and hold SEL (S) for more than 2 seconds so that one of the PSM items appears on the display. (See pages 25 and 26.)**



- 2 Select "PTY STBY (standby)" if not shown on the display.**

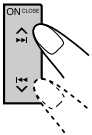

- 3 Select one of the twenty-nine PTY codes. (See page 18.)**

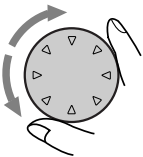

Selected code name appears on the display and is stored into memory.

- To cancel the PTY Standby Reception, select "OFF."

- 4 Finish the setting.**



- **When the current source is FM**, the PTY indicator either lights up or flashes.

- If the PTY indicator lights up, PTY Standby Reception is activated. If a station starts broadcasting the selected PTY programme, this unit automatically tunes in to the station.
- If the PTY indicator flashes, PTY Standby Reception is not yet activated since the station being received does not provide the signals used for PTY Standby Reception.

To activate PTY Standby Reception, you need to tune in to another station providing these signals. Press **▲ ►►** or **◀◀ ▼** to search for such a station.

When a station providing these signals is tuned in, the PTY indicator stops flashing and remains lit. Now PTY Standby Reception is activated.

- **When the current source is other than FM**, the PTY indicator lights up.

If a station starts broadcasting the selected PTY programme, this unit automatically changes the source and tunes in to the station.

To deactivate the PTY standby mode, select "OFF" in step 3 of the procedure on the left column. The PTY indicator disappears.



Searching your favorite programme

You can search any one of the PTY codes. In addition, you can store your 6 favorite programme types in the number buttons. When shipped from the factory, the following 6 programme types have been stored in the number buttons (1 to 6).

To store your favorite programme types, see below.

To search your favorite programme type, see page 16.

1	2	3
POP M	ROCK M	EASY M
4	5	6
CLASSICS	AFFAIRS	VARIED

To store your favorite programme types

- 1 Press and hold TP/PTY (T) for more than 2 seconds.

TP/PTY



The last selected PTY code appears.

- 2 Select one of the twenty-nine PTY codes. (See page 18.)

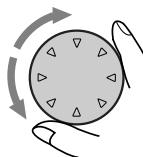

Selected code name appears on the display.

- 3 Press and hold the number button for more than 2 seconds to store the PTY code selected into the preset number you want.

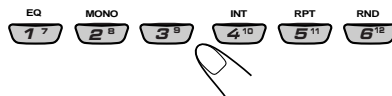

Preset number flashes for a few seconds.

- 4 Press and hold TP/PTY (T) for more than 2 seconds.

TP/PTY





To search your favorite programme type

- 1 Press and hold TP/PTY (T) for more than 2 seconds while listening to an FM station.



The last selected PTY code appears.

- 2 Select one of the PTY codes.



OR

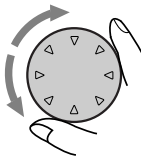

Ex.: When "ROCK M" is selected.

- 3 Press \blacktriangle \blacktriangleright or \blacktriangleleft \blacktriangledown to start PTY search for your favorite programme.

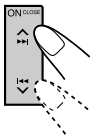

- If there is a station broadcasting a programme of the same PTY code as you selected, that station is tuned in.
- If there is no station broadcasting a programme of the same PTY code as you selected, the station will not change.

Note:

In some areas, the PTY search will not work correctly.

Other convenient RDS functions and adjustments

Automatic selection of the station when using the number buttons

Usually when you press the number button, the preset station is tuned in.

However, when the preset station is an RDS station, something different will happen. If the signals from that preset station are not sufficient for good reception, this unit, using the AF data, tunes in to another frequency broadcasting the same programme as the original preset station is broadcasting. (Programme search)

- The unit takes some time to tune in to another station using Programme search.

To activate programme search, follow the procedure below.

- See also "Changing the general settings (PSM)" on page 25.

- 1 Press and hold SEL (S) for more than 2 seconds so that one of the PSM items appears on the display.
- 2 Press \blacktriangle \blacktriangleright or \blacktriangleleft \blacktriangledown to select "P(Programme)-SEARCH."
- 3 Turn the control dial to select "SEARCH ON." Now programme search is activated.
- 4 Press SEL (S) to finish the setting.

To cancel programme search, repeat the same procedure and select "SEARCH OFF" in step 3.



Changing the display mode while listening to an FM station

You can change the initial indication on the display to either station name (PS NAME) or to station frequency (FREQUENCY), while listening to an FM RDS station.

- See also “Changing the general settings (PSM)” on page 25.
- 1 Press and hold SEL (S) for more than 2 seconds so that one of the PSM items appears on the display.
 - 2 Press ▲▶▶ or ◀◀▼ to select “TUNER DISP (display).”
 - 3 Turn the control dial to set to the desired indication (“PS NAME” or “FREQUENCY”).
 - 4 Press SEL (S) to finish the setting.

Note:

By pressing DISP (D), you can change the display while listening to an FM RDS station. Each time you press the button, the following information appears on the display:

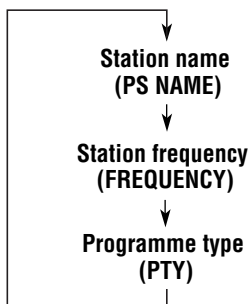

- Then, the display goes back to the original indication in several seconds.

Setting the TA volume level

You can preset the volume level for TA Standby Reception. When a traffic programme is received, the volume level automatically changes to the preset level.

- See also “Changing the general settings (PSM)” on page 25.
- 1 Press and hold SEL (S) for more than 2 seconds so that one of the PSM items appears on the display.
 - 2 Press ▲▶▶ or ◀◀▼ to select “TA VOL (volume).”
 - 3 Turn the control dial to set to the desired volume. You can set it from “TA VOL 00” to “TA VOL 50.”
 - 4 Press SEL (S) to finish the setting.

Automatic clock adjustment

When shipped from the factory, the clock built in this unit is set to be readjusted automatically using the CT (Clock Time) data in the RDS signal.

If you do not want to use automatic clock adjustment, follow the procedure below.

- See also “Changing the general settings (PSM)” on page 25.
- 1 Press and hold SEL (S) for more than 2 seconds so that one of the PSM items appears on the display.
 - 2 Press ▲▶▶ or ◀◀▼ to select “AUTO ADJ (adjustment).”
 - 3 Turn the control dial to select “ADJUST OFF.” Now automatic clock adjustment is canceled.
 - 4 Press SEL (S) to finish the setting.

To reactivate clock adjustment, repeat the same procedure and select “ADJUST ON” in step 3.

Note:

You must stay tuned to the same station for more than 2 minutes after setting “AUTO ADJ” to “ADJUST ON.” Otherwise, the clock time will not be adjusted. (This is because the unit takes up to 2 minutes to capture the CT data in the RDS signal.)

**PTY codes**

NEWS:	News	CHILDREN:	Entertainment programmes for children
AFFAIRS:	Topical programmes expanding on current news or affairs	SOCIAL:	Programmes on social activities
INFO:	Programmes which impart advice on a wide variety of topics	RELIGION:	Programmes dealing with any aspect of belief or faith, or the nature of existence or ethics
SPORT:	Sport events	PHONE IN:	Programmes where people can express their views either by phone or in a public forum
EDUCATE:	Educational programmes	TRAVEL:	Programmes about travel destinations, package tours, and travel ideas and opportunities
DRAMA:	Radio plays	LEISURE:	Programmes concerned with recreational activities such as gardening, cooking, fishing, etc.
CULTURE:	Programmes on national or regional culture	JAZZ:	Jazz music
SCIENCE:	Programmes on natural science and technology	COUNTRY:	Country music
VARIED:	Other programmes like comedies or ceremonies	NATION M:	Current popular music from another nation or region, in that country's language
POP M:	Pop music	OLDIES:	Classic pop music
ROCK M:	Rock music	FOLK M:	Folk music
EASY M:	Easy-listening music	DOCUMENT:	Programmes dealing with factual matters, presented in an investigative style
LIGHT M:	Light music		
CLASSICS:	Classical music		
OTHER M:	Other music		
WEATHER:	Weather information		
FINANCE:	Reports on commerce, trading, the Stock Market, etc.		

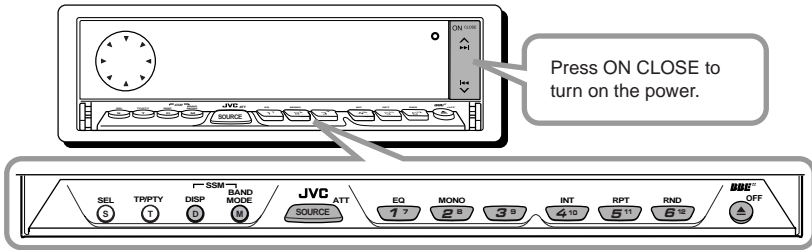

Playing a CD

1 Open the loading slot.

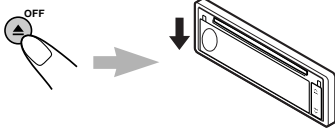

The display panel moves down, and the loading slot appears.

2 Insert a disc into the loading slot.

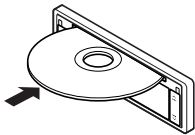

The unit draws in a CD, the display panel moves up, and CD play starts automatically.



The CD-in indicator lights up.

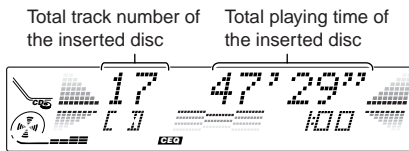

Total track number of the inserted disc

Total playing time of the inserted disc

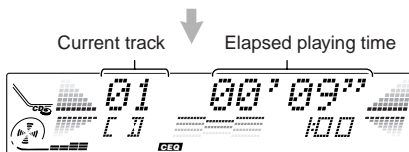

Current track

Elapsed playing time

Notes:

- When a CD is in the loading slot, selecting "CD" as the source by pressing SOURCE ATT starts CD play.
- When a CD is inserted upside down, the CD automatically ejects.
- When you play a CD Text, the disc title and performer appear on the display. Then the current track title appears on the display, followed by the track number and elapsed playing time. See also "Playing a CD Text" (page 21) and "To select the scroll mode — SCROLL" (page 27). If a CD Text includes much text information, some may not appear on the display.
- If you change the source, CD play also stops (without ejecting the CD). Next time you select "CD" as the source, CD play will start from where you have stopped.

To stop play and eject the CD

Press OFF ▲ briefly.

CD play stops, the display panel moves down, then the CD automatically ejects from the loading slot.

To move up the display panel, press ▲▶▶ or ◀◀▼. If no button is pressed, the display panel will move up in about 5 minutes.

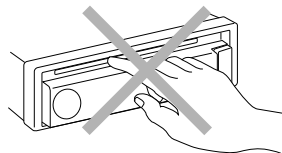

CAUTION: NEVER insert your finger between the display panel and the unit, as it may get caught in the unit.

Note:

If the ejected disc is not removed for about 15 seconds, the disc is automatically inserted again into the loading slot to protect it from dust. (CD play will not start this time.)



Locating a track or a particular portion on a CD

To fast-forward or reverse the track

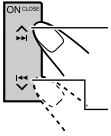

Press and hold **⏭**, while playing a CD, to fast-forward the track.

Press and hold **⏮**, while playing a CD, to reverse the track.

To go to the next tracks or the previous tracks

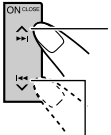

Press **⏭** briefly, while playing a CD, to go ahead to the beginning of the next track. Each time you press the button consecutively, the beginning of the next tracks is located and played back.

Press **⏮** briefly, while playing a CD, to go back to the beginning of the current track. Each time you press the button consecutively, the beginning of the previous tracks is located and played back.

To go to a particular track directly

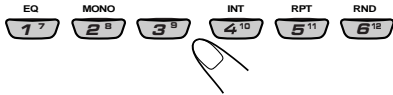

Press the number button corresponding to the track number to start its playback.

- To select a track number from 1 – 6: Press 1 (7) – 6 (12) briefly.
- To select a track number from 7 – 12: Press and hold 1 (7) – 6 (12) for more than 1 second.

Selecting CD playback modes

To play back tracks at random (Random Play)

You can play back all tracks on the CD at random.

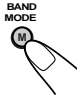

1 Press BAND MODE (M) while playing a CD. "MODE" appears on the display, and the number buttons can work as different function buttons.



2 Press RND (random), while "MODE" is still on the display, so that the RND indicator lights up on the display. Each time you press the button, CD random play mode turns on and off alternately.

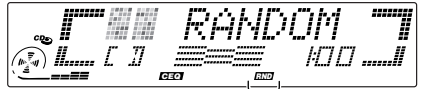

RND indicator

When the random mode is turned on, the RND indicator lights up on the display and a track randomly selected starts playing.

To play back tracks repeatedly (Repeat Play)

You can play back the current track repeatedly.

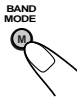

1 Press BAND MODE (M) while playing a CD. "MODE" appears on the display, and the number buttons can work as different function buttons.



2 Press RPT (repeat), while "MODE" is still on the display, so that the RPT indicator lights up on the display. Each time you press the button, CD repeat play mode turns on and off alternately.

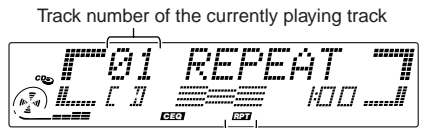

RPT indicator

When the repeat mode is turned on, the RPT indicator lights up on the display.



To play back only intros (Intro Scan)

You can play back the first 15 seconds of each track sequentially.

BAND MODE



1 Press BAND MODE (M) while playing a CD. "MODE" appears on the display, and the number buttons can work as different function buttons.

INT



2 Press INT (intro scan), while "MODE" is still on the display. Each time you press the button, CD intro scan mode turns on and off alternately.

Track number of the currently playing track



When the intro scan mode is turned on, "INTRO" appears on the display for 5 seconds and the track number flashes.

Prohibiting CD ejection

You can prohibit CD ejection and can lock a CD in the loading slot.

While pressing SOURCE ATT, press and hold OFF ▲ for more than 2 seconds. "NO EJECT" flashes on the display for about 5 seconds, and the CD is locked and cannot be ejected.



Note:

If you press OFF ▲ while CD ejection is prohibited, the control panel moves down, but the CD cannot be ejected. ("NO EJECT" appears on the display.)

To move up the display panel, press ▲▶▶ or ◀◀▼.

To cancel the prohibition and unlock the CD, press and hold OFF ▲ for more than 2 seconds again, while pressing SOURCE ATT. "EJECT OK" flashes on the display for about 5 seconds, and the CD is unlocked.

Playing a CD Text

In a CD Text, some information about the disc (its disc title, performer and track title) is recorded. You can show these disc information on the display.

Select text display mode while playing a CD Text.

DISP



Each time you press the button, the display changes as follows:

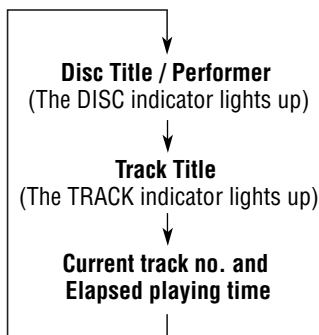

Notes:

- The display shows up to 10 characters at one time and scrolls if there are more than 10 characters. See also "To select the scroll mode — SCROLL" on page 27.
- When you press DISP (D) while playing a conventional CD, "NO NAME" appears for the disc title/performer and the track title.



SOUND ADJUSTMENTS

Adjusting the sound

You can adjust the sound characteristics to your preference.

1 Select the item you want to adjust.



Each time you press the button, the adjustable items change as follows:

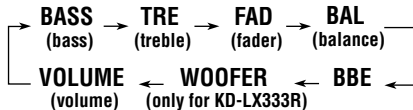

Indication	To do:	Range
BASS	Adjust the bass.	-06 (min.) +06 (max.)
TRE	Adjust the treble.	-06 (min.) +06 (max.)
FAD*	Adjust the front and rear speaker balance.	R06 (Rear only) F06 (Front only)
BAL	Adjust the left and right speaker balance.	L06 (Left only) R06 (Right only)
BBE	See "What is BBE?" on the right column.	BBE 1, BBE 2, BBE 3, BBE OFF
WOOFER (only for KD-LX333R)	Adjust the subwoofer output level.	00 (min.) 08 (max.)
VOLUME	Adjust the volume.	00 (min.) 50 (max.)

* If you are using a two-speaker system, set the fader level to "00."

2 Adjust the level.

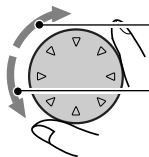

To increase the level.

To decrease the level.

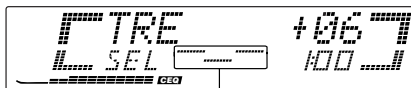

Equalization pattern changes as you adjust the bass or treble.

Note:

Normally the control dial works for volume adjustment. So you do not have to select "VOLUME" to adjust the volume level.

What is BBE^{II}?

The BBE^{II}* function restores the brilliance and clarity of the original live sound in recording, broadcasts, etc.

When a speaker reproduces sound, it introduces frequency-dependent phase shifting, causing high-frequency sounds to take longer to reach the ear than low frequency sounds. The BBE^{II} function adjusts the phase relationship between the low, mid and high frequencies by adding a progressively longer delay time to the low and mid frequencies, so that all frequencies reach the listener's ears at the proper time.

In addition, the BBE^{II} function boosts low and high frequencies, which loudspeakers tend to be less efficient in reproducing, through dynamic, program-driven augmentation. When combined with the phase compensation feature, the resulting sound has a clearer, more finely detailed "live" presence.

As you turn the control dial, the BBE^{II} function changes as follows:

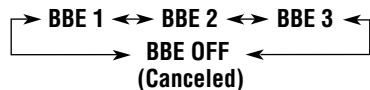

As the number gets higher, the BBE^{II} function becomes stronger.

When shipped from the factory, the BBE^{II} function is set to "BBE OFF."

* Under license from BBE Sound, Inc.

BBE^{II} is a trademark of BBE Sound, Inc.

Selecting preset sound modes (CEQ: custom equalizer)

You can select a preset sound mode (CEQ: custom equalizer) suitable to the music genre.

- 1 Press **BAND MODE (M)** to make the number buttons work as different function buttons.



- 2 Activate custom equalizer (CEQ).



The last selected sound mode is recalled and applied to the current sound.



Ex.: If you have selected "USER" previously.

- 3 Select the sound mode you want.



Each time you press the button, the sound modes changes as follows:

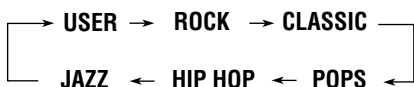

Ex.: If you select "ROCK."

Indication	For:	Preset values		
		BASS	TRE	BBE ^{II}
USER	(Flat sound)	00	00	BBE OFF
ROCK	Rock or disco music	+03	+01	BBE 2
CLASSIC	Classical music	+01	-02	BBE OFF
POPS	Light music	+04	+01	BBE OFF
HIP HOP	Funk or Rap music	+02	00	BBE 2
JAZZ	Jazz music	+02	+03	BBE OFF

Notes:

- You can adjust each sound mode to your preference, and store it in memory.
If you want to adjust and store your original sound mode, see "Storing your own sound adjustments" on page 24.
- To adjust the bass and treble reinforcement levels or to turn on/off the BBE^{II} function temporarily, see page 22.

To store a sound mode separately for each playback source (CEQ Link)

You can select a sound mode and store it in memory. It will be recalled every time you select the same source and will be shown on the display.

A sound mode can be stored for each of the following sources — FM1, FM2, FM3, AM, CD and external components.

- See also "Changing the general settings (PSM)" on page 25.
- 1 Press and hold **SEL (S)** for more than 2 seconds so that one of the PSM items appears on the display.
 - 2 Press **▲ ►►** or **◀◀ ▼** to select "CEQ LINK" (Custom Equalization Link).
 - 3 Turn the control dial to select "LINK ON."
 - 4 Press **SEL (S)** to finish the setting.

To cancel CEQ Link, repeat the same procedure and select "LINK OFF" in step 3.

Note:

When you change the "CEQ LINK" setting, sound mode (CEQ) is automatically reset to "USER."



- When “CEQ LINK” is set to “LINK ON”
The selected sound mode can be stored in memory for the current source. Each time you change to the same source, the same sound mode is also recalled and shown on the display. The CEQ indicator also flashes.
- When “CEQ LINK” is set to “LINK OFF”
The selected sound mode effect applies to any source.

Storing your own sound adjustments

You can adjust the sound modes to your preference and store your own adjustments in memory.

- There is a time limit in doing the following procedure. If the setting is canceled before you finish, start from step 1 again.

1 Press BAND MODE (M) to make the number buttons work as different function buttons.



2 Activate custom equalizer (CEQ).



The last selected sound mode is recalled and applied to the current sound.



Ex.: If you have selected “POPS” previously.

3 Select the sound mode you want.



Each time you press the button, the sound modes changes as follows:

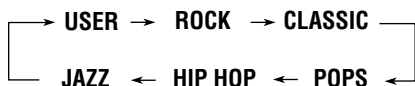

4 Select the items you want to adjust.



- See page 22 for details.

5 Adjust the level.

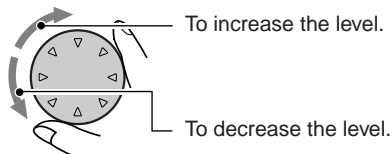

Equalization pattern changes as you adjust the bass or treble.

Ex.: When you adjust “TRE (treble).”

6 Repeat steps 4 and 5 to adjust the other items.

- To adjust the BBE^{II} level, see page 22.

7 Repeat the same procedure to store other sound modes.

To reset to the factory settings, repeat the same procedure and reassign the preset values listed in the table on page 23.

Changing the general settings (PSM)

You can change the items listed on the next page by using the PSM (Preferred Setting Mode) control.

Basic Procedure

- 1 Press and hold SEL (S) for more than 2 seconds so that one of the PSM items appears on the display. (See below.)



- 2 Select the PSM item you want to adjust. (See below.)

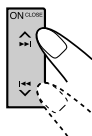

- 3 Adjust the PSM item selected above.

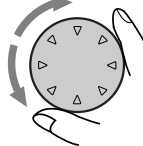

- 4 Repeat steps 2 and 3 to adjust the other PSM items if necessary.

- 5 Finish the setting.



Preferred Setting Mode (PSM) items

		3			
1	2	Set...		Factory-preset settings	See page
Hold.	Select...	Counter-clockwise	Clockwise		
DEMO MODE	Demo mode	DEMO OFF	DEMO ON	DEMO ON	8
CLOCK HOUR	Hour adjustment	Back	Advance	0:00	8
CLOCK MIN	Minute adjustment	Back	Advance		
CEQ LINK	Custom equalizer memory linkage	LINK OFF	LINK ON	LINK OFF	27
24H/12H	24/12-hour time display	12HOUR	24HOUR	24HOUR	8
AUTO ADJ	Automatic clock setting	ADJUST OFF	ADJUST ON	ADJUST ON	17
CLOCK DISP	Clock display	CLOCK OFF	CLOCK ON	CLOCK ON	27
TUNER DISP	Tuner display	FREQUENCY	PS NAME	PS NAME	17
PTY STBY	PTY standby	29 programme types OFF → (See page 18.)		OFF	14
AF-REG	Alternative frequency/ Regionalization reception	AF	AF REG	AF	13

CONTINUED ON THE NEXT PAGE

Preferred Setting Mode (PSM) items

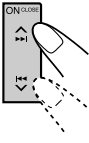
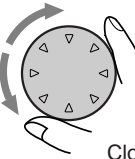
1  Hold.		2  Select...		3  Set... Counter-clockwise Clockwise		Factory-preset settings	See page
TA VOL	Traffic announcement volume	TA VOL 00 – TA VOL 50		TA VOL 20	17		
P-SEARCH	Programme search	SEARCH OFF	SEARCH ON	SEARCH OFF	16		
DAB AF*	Alternative frequency search	AF OFF	AF ON	AF ON	41		
DAB VOL*	DAB volume adjustment	DAB VOL –12 to 12		DAB VOL 00	41		
LEVEL	Level display	5 types (See page 27.)		NORMAL	27		
DIMMER	Dimmer mode	AUTO	↔ OFF	AUTO	27		
CRUISE (only for KD-LX333R)	Audio cruise	CRUISE 1 ↔ CRUISE 2		CRUISE OFF	29		
+OR– SET** (only for KD-LX333R)	Idling speed	—		800 rpm	30		
BOOST** (only for KD-LX333R)	Boost	BOOST 01 – 15		BOOST 05	29		
TELEPHONE	Telephone muting	MUTING 1 ↔ MUTING 2		MUTING OFF	27		
BEEP SW	Key-touch tone	BEEP OFF	BEEP ON	BEEP ON	27		
CONTRAST	Display contrast	CONTRAST 1 – 10		CONTRAST 5	27		
SCROLL	Scroll mode	ONCE	↔ AUTO	ONCE	27		
WooferFreq (only for KD-LX333R)	Subwoofer cutoff frequency	FREQ LOW ↔ FREQ MID		FREQ MID	28		
LINE ADJ (only for KD-LX333R)	Line input level adjustment	LINE ADJ 00 – 05		LINE ADJ 00	28		
EXT INPUT (only for KD-LX111R)	External component	CD CHANGER	LINE INPUT	CD CHANGER	28		
FLAT PANEL	Flat panel	FLAT OFF	FLAT ON	FLAT OFF	28		
IF FILTER	Intermediate frequency filter	WIDE	AUTO	AUTO	28		

4 Press SEL (S) to finish the setting.

* Displayed only when the DAB tuner is connected.

26 ** When you select “CRUISE 1” or “CRUISE 2” for Audio Cruise Mode, you can adjust these items.

To set Custom Equalizer Link — CEQ LINK

A different sound mode (CEQ) can be stored in memory for each source so that you can change the sound modes simply by changing the sources. When shipped from the factory, this mode is deactivated.

- **LINK ON:** Different sound modes for different sources.
- **LINK OFF:** One sound mode for all sources.

To set the clock display — CLOCK DISP

You can set the clock to be shown on the display when the unit is turned on. When shipped from the factory, the clock is set to be shown on the display.

- **CLOCK ON:** Clock display is turned on.
- **CLOCK OFF:** Clock display is turned off.

To select the level meter — LEVEL

You can select the level meter display according to your preference. When shipped from the factory, "NORMAL" is selected.

- **NORMAL:** Normal audio level meter will be shown on both sides of the display.
- **SIDE:** Display illumination moves from inside to outside.
- **FULL:** Level meter is fully shown on the main display and display illumination starts.
- **OFF:** Level meter disappears but the center display illuminates.
- **ALL OFF:** Level meter and center display turns off.

To select the dimmer mode — DIMMER

When you turn on the car head lights, the display automatically dims (Auto Dimmer). When shipped from the factory, Auto Dimmer mode is activated.

- **AUTO:** Activates Auto Dimmer.
- **OFF:** Cancels Auto Dimmer.
- **ON:** Always dims the display.

Note on Auto Dimmer:

Auto Dimmer equipped with this unit may not work correctly on some vehicles, particularly on those having a control dial for dimming.

In this case, set the dimmer mode to "ON" or "OFF."

To select the telephone muting — TELEPHONE

This mode is used when a cellular phone system is connected. Depending on the phone system used, select either "MUTING 1" or "MUTING 2," whichever mutes the sounds from this unit. When shipped from the factory, this mode is deactivated.

- **MUTING 1:** Select this if this setting can mute the sounds.
- **MUTING 2:** Select this if this setting can mute the sounds.
- **MUTING OFF:** Cancels the telephone muting.

To turn on/off the key-touch tone — BEEP SW

You can deactivate the key-touch tone if you do not want it to beep each time you press a button. When shipped from the factory, the key-touch tone is activated.

- **BEEP ON:** Activates the key-touch tone.
- **BEEP OFF:** Deactivates the key-touch tone.

To adjust the display contrast level — CONTRAST

You can adjust the display contrast level among "1" (dark) to "10" (bright). When shipped from the factory, the display contrast level is set at level "5."

To select the scroll mode — SCROLL

You can select the scroll mode for the disc information if it consists of more than 10 characters. When shipped from the factory, Auto Scroll mode is set to "ONCE."

- **ONCE:** Scrolls only once.
- **AUTO:** Repeats the scroll (in 5-second intervals).
- **OFF:** Cancels Auto Scroll.

Note:

Even if the scroll mode is set to "OFF," you can scroll the display by pressing DISP (D) for more than 1 second.



To select the subwoofer cutoff frequency — WooferFreq (only for KD-LX333R)

When a subwoofer is connected to this unit, select an appropriate cutoff frequency level for your subwoofer. When shipped from the factory, the subwoofer cutoff frequency is set to "FREQ MID."

- **FREQ LOW:** Frequencies higher than 50 Hz are cut off to the subwoofer.
- **FREQ MID:** Frequencies higher than 80 Hz are cut off to the subwoofer.
- **FREQ HIGH:** Frequencies higher than 120 Hz are cut off to the subwoofer.

To adjust the line input level — LINE ADJ (only for KD-LX333R)

Adjust the line input level properly when an external component is connected to the LINE INPUT plugs. When shipped from the factory, the line input level is set at level "00."

If the input level of the connected component is not high enough, increase the input level properly. Without adjusting the line input level, you may be surprised at a loud sound when you change from the external component to another source.

To select the external component to use — EXT INPUT (only for KD-LX111R)

You can connect the external component to the CD changer jack on the rear using the Line Input Adaptor KS-U57 (not supplied).

To use the external component as the playback source through this unit, you need to select which component – CD changer or external component – to use. When shipped from the factory, CD changer is selected as the external component.

- **LINE INPUT:** To use the external component other than CD changer.
- **CD CHANGER:** To use the CD changer.

Note:

For connecting the Line Input Adaptor KS-U57 and the external component, refer to the Installation/Connection Manual (separate volume).

To make the front panel look flat (hiding the control panel) — FLAT PANEL

When operating the receiver using the remote control, you can hide the control panel to make the front panel look flat. When shipped from the factory, "FLAT OFF" is selected.

- **FLAT ON:** The control panel will not come out when you turn on the unit. To use the control panel, press **◀◀ ▼** so that the control panel comes out. If no operation is done for about 10 seconds, it automatically goes back into the receiver.
- **FLAT OFF:** You can use the control panel normally.

Note:

*When "FLAT ON" is selected, you can eject a CD by holding **▶▶ ▼**.*

To change the FM tuner selectivity — IF FILTER

In some areas, adjacent stations may interfere with each other. If this interference occurs, noise may be heard. This unit has been preset to automatically reduce this interference noise ("AUTO") when shipped from the factory.

- **AUTO:** When this type of interference occurs, this unit automatically increases the tuner selectivity so that interference noise will be reduced. (But the stereo effect will also be lost.)
- **WIDE:** Subject to the interference from adjacent stations, but sound quality will not be degraded and the stereo effect will not be lost.

Controlling the volume automatically (Audio Cruise)

This section is only for KD-LX333R.

You can select the proper cruise mode for your car. This unit changes the volume level automatically (at 3 possible levels) based on the driving speed of your car by detecting the alternator's generating frequency (Audio Cruise). If you want to use this mode, follow the procedure below. When shipped from the factory, this mode is set to "CRUISE OFF."

- CRUISE 1: Select this if your car is relatively quiet.
- CRUISE 2: Select this if your car is relatively loud. The volume increase rate is twice as much as that of the CRUISE 1 setting.
- CRUISE OFF: Cancels Audio Cruise.

1 Press and hold SEL (S) for more than 2 seconds so that one of the PSM items appears on the display. (See pages 25 and 26.)



2 Select "CRUISE" if not shown on the display.

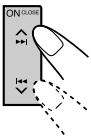

3 Select the desired setting.

As you turn the control dial, the Audio Cruise mode changes as follows:

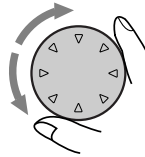

4 Finish the setting.



To adjust the volume increase rate

If you find Audio Cruise increases (or decreases) the volume either too much or too little as the driving speed changes, you can adjust the increase rate by changing the boost level. To change it, follow the procedure below.

- See also "Changing the general settings (PSM)" on page 25.

- 1 Press and hold SEL (S) for more than 2 seconds so that one of the PSM items appears on the display.
- 2 Press ▲▶▶ or ◀◀▼ repeatedly until "CRUISE" appears on the display.
- 3 Turn the control dial to select either "CRUISE 1" or "CRUISE 2."
- 4 Press ▲▶▶ (or ◀◀▼) to select "BOOST." The current boost level also appears on the display.
- 5 Turn the control dial to select the desired boost level (among 01 to 15).
- 6 Press SEL (S) to finish the setting.

If Audio Cruise does not function correctly

You may need to store the idling speed into memory to make Audio Cruise function correctly.

NOTICE that a number of factors, such as electric power steering, wipers, power windows, air conditioner, etc. do generate noises and, as a result, may cause Audio Cruise not to function correctly. If this is the main cause of malfunction, connect the memory backup lead (yellow lead) directly to the car battery to prevent these noises from affecting Audio Cruise.

- 1 Start the engine and let it warm up.
- 2 Press and hold SEL (S) for more than 2 seconds so that one of the PSM items appears on the display.
- 3 Press ▲▶▶| or |◀◀▼ repeatedly until "CRUISE" appears on the display.
- 4 Turn the control dial to select either "CRUISE 1" or "CRUISE 2."
- 5 Press ▲▶▶| (or |◀◀▼) to select "+OR- SET."
- 6 Turn the control dial to select the desired idling speed.
- 7 Press SEL (S) to finish the setting.

When the setting is complete, the unit automatically checks to see if Audio Cruise functions correctly with this new idling setting. If it does not function correctly, Audio Cruise is canceled automatically and the idling setting becomes invalid.

- *If this happens, see the NOTICE above.*

Assigning names to the sources

You can assign names to CDs and the external component. After assigning a name, it will appear on the display when you select the source.

Sources	Maximum number of the characters
CDs* and CD changer*	Up to 32 characters (up to 40 discs)
External component	Up to 10 characters

* You cannot assign a name to a CD Text.

1 Select a source you want to assign a name to.

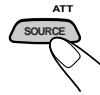

2 Press and hold SEL (S) for more than 2 seconds while pressing DISP (D).

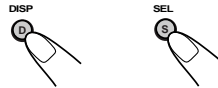

Ex.: When you select the CD as the source.



Ex.: When you select the external component as the source.

3 Select the character set you want while “

Each time you press the button, the character set changes as follows:

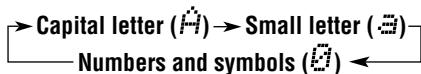

4 Select a character.

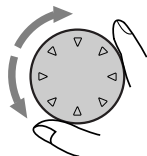

See right column for available characters.

Available characters

Capital letters

A	B	C	D	E	F	G	H	I	J
K	L	M	N	O	P	Q	R	S	T
U	V	W	X	Y	Z	space			

Small letters

a	b	c	d	e	f	g	h	i	j
k	l	m	n	o	p	q	r	s	t
u	v	w	x	y	z	space			

Numbers and symbols

0	1	2	3	4	5	6	7	8	9
!	”	#	\$	%	&	'	()	*	
+	,	-	.	/	:	;	<	=	>
?	@	_	`	space					

5 Move the cursor to the next (or previous) character position.

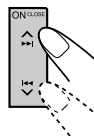

6 Repeat steps 3 to 5 until you finish inputting the name.

7 Press the button while the last selected character is flashing.



The input name is stored in memory.

Notes:

- When you try to assign a name to the 41st disc, “NAME FULL” appears on the display. (In this case, delete unwanted names before assignment.)
- When the CD changer is connected, you can assign names to CDs in the CD changer. These names can also be shown on the display if you insert the CDs in this unit.

To erase the input characters

Insert spaces using the same procedure described above.

Using the security lock

You can prohibit the unauthorized use of this unit by the others.

To use the security lock, you need to set the password first. Once you set the password, the unit will ask you to enter the password when you turn on the unit for the first time after re-installation (or after recovering the car battery exhaustion).

CAUTION: Be careful not to forget the password you have entered; otherwise, you cannot use this unit. Keep the password in your mind and more importantly on paper or some other materials. You can write down your password in the spaces provided on the cover page.

Registering the password

You have to use 4 characters for your password. You can use the following characters: Capital letters (A – Z), small letters (a – z) and numbers (0 – 9).

- 1 Press and hold both buttons for more than 2 seconds.**

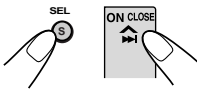

The unit enters password entry mode.



- 2 Select the character set you want to use.**



Each time you press the button, the character set changes as follows:

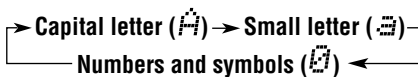

- 3 Select a letter.**

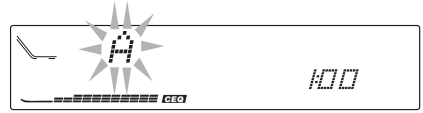
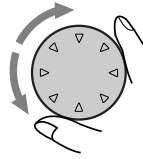

- 4 Move the character entry position to the next.**

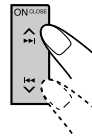

- 5 Repeat steps 2 to 4 until you enter all 4 characters.**

- 6 Finish the setting.**



The unit returns to the normal operation mode.

How to Use the Provided CODE Sticker

Attach the provided CODE sticker in a conspicuous position on your car to notify would-be unauthorized users that the security lock function is provided for this unit and, therefore, will foil their efforts.



CD CHANGER OPERATIONS

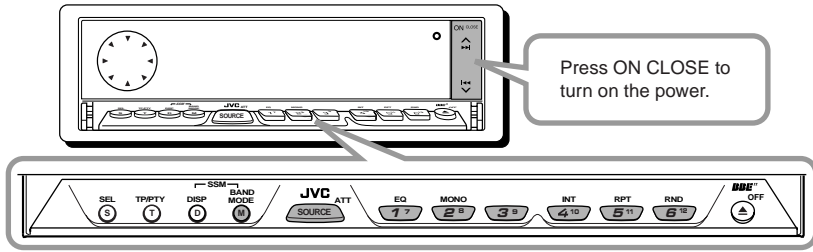

We recommend that you use one of the CH-X series with your unit.

If you have another CD automatic changer, consult your JVC IN-CAR ENTERTAINMENT dealer for connections.

- For example, if your CD automatic changer is one of the KD-MK series, you need a cord (KS-U15K) for connecting it to this unit.

Before operating your CD automatic changer:

- Refer also to the Instructions supplied with your CD changer.
- If no discs are in the magazine of the CD changer or the discs are inserted upside down, "NO DISC" will appear on the display. If this happens, remove the magazine and set the discs correctly.
- If no magazine is loaded in the CD changer, "NO MAG" appears on the display. If this happens, insert the magazine in the CD changer.
- If "RESET 1" – "RESET 8" appears on the display, something is wrong with the connection between this unit and the CD changer. If this happens, check the connection, connect the connecting cord(s) firmly if necessary, then press the reset button of the CD changer.

Playing CDs

Select the CD automatic changer (CD-CH).

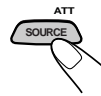

Each time you press the button, the source changes as described on page 7.

Playback starts from the first track of the first disc.

All tracks of all discs are played back.

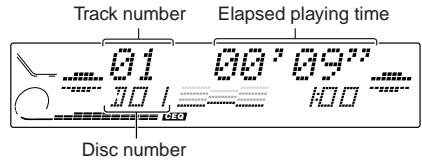

To fast-forward or reverse the track

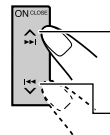

Press and hold while playing a CD, to fast-forward the track.

Press and hold while playing a CD, to reverse the track.

To go to the next tracks or the previous tracks

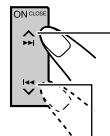

Press briefly, while playing a CD, to go ahead to the beginning of the next track. Each time you press the button consecutively, the beginning of the next tracks is located and played back.

Press briefly, while playing a CD, to go back to the beginning of the current track. Each time you press the button consecutively, the beginning of the previous tracks is located and played back.

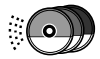

To go to a particular disc directly

Press the number button corresponding to the disc number to start its playback (while the CD changer is playing).

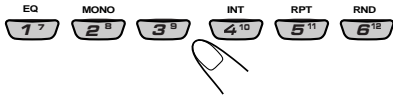

- To select a disc number from 1 – 6: Press 1 (7) – 6 (12) briefly.
- To select a disc number from 7 – 12: Press and hold 1 (7) – 6 (12) for more than 1 second.

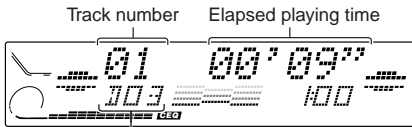

Disc number

Ex.: When disc number 3 is selected.

To show the CD Text information

This is possible only when connecting a JVC CD automatic changer equipped with CD Text reading capability.

See “Playing a CD Text” on page 21.

Selecting CD playback modes

- There is a time limit in doing the following procedure. If the setting is cancelled before you finish, start from step 1 again.

To play back tracks at random (Random Play)



1 Press BAND MODE (M) while playing a CD. “MODE” appears on the display.



2 Press RND (random), while “MODE” is still on the display, so that the RND indicator lights up on the display. Each time you press the button, CD random play mode changes as follows:



RND indicator



Mode	RND Indicator	Plays at random
RANDOM1	Lights.	All tracks of the current disc, then the tracks of the next disc, and so on.
RANDOM2	Flashes.	All tracks of all discs inserted in the magazine.



To play back tracks repeatedly (Repeat Play)

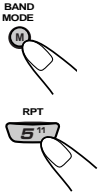

- 1 Press BAND MODE (M) while playing a CD. "MODE" appears on the display.
- 2 Press RPT (repeat), while "MODE" is still on the display, so that the RPT indicator lights up on the display. Each time you press the button, CD repeat play mode changes as follows:

Track number of the currently playing track

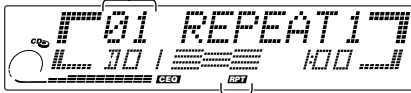

RPT indicator



Mode	RPT Indicator	Plays repeatedly
REPEAT1	Lights.	The current track (or specified track).
REPEAT2	Flashes.	All tracks of the current disc (or specified disc).

To play back only intros (Intro Scan)

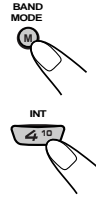

- 1 Press BAND MODE (M) while playing a CD. "MODE" appears on the display.
- 2 Press INT (intro scan), while "MODE" is still on the display. Each time you press the button, CD intro scan mode changes as follows:

Track number of the currently playing track



Mode	Indication	Plays the beginnings (15 seconds)
INTRO1	Track number flashes.	Of all tracks on all inserted discs.
INTRO2	Disc number flashes.	Of the first track on inserted disc.

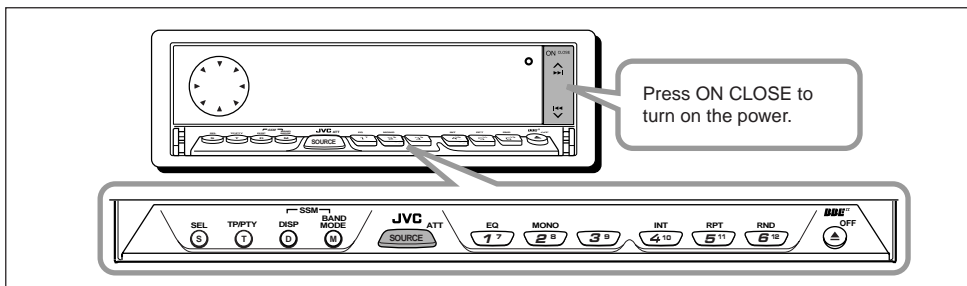

Playing an external component

When connecting an external component, you can select the component as the sound source.

Notes for KD-LX333R:

- For the external component connection, see the *Installation/Connection Manual* (separate volume).
- If the input level of the external component connected to the **LINE INPUT** plug is not high enough, increase the input level properly. Without adjusting the input level, you may be surprised at a loud sound when you change the source from the external component to another. (See “To adjust the line input level — **LINE ADJ**” on page 28.)

Notes for KD-LX111R:

- For connecting the external component, you need to use the *Line Input Adaptor KS-U57* (not supplied). See the *Installation/Connection Manual* (separate volume).
- Before operating the external component using the following procedure, select the external input correctly. (See “To select the external component to use — **EXT INPUT**” on page 28.)

Using a subwoofer

This section is only for KD-LX333R.

By connecting a subwoofer to the **SUBWOOFER OUT** plugs on the rear, you can enjoy enhanced bass sounds and a more realistic theater atmosphere in your car.

- Refer also to the instructions supplied with your subwoofer.

When a subwoofer is connected to this unit, do the following as required.

To set the subwoofer cutoff frequency, see “To select the subwoofer cutoff frequency — **WoofeFreq**” on page 28.

To adjust the subwoofer output volume, see “Adjusting the sound” on page 22.

1 Select the external component.

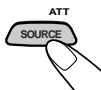

Each time you press the button, the source changes as described on page 7.

2 Operate the external component.

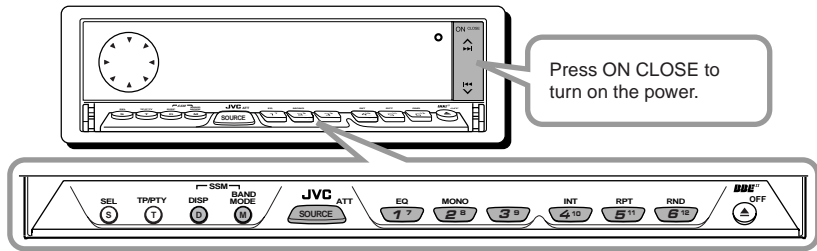

We recommend that you use DAB (Digital Audio Broadcasting) tuner KT-DB1500 with your unit. If you have another DAB tuner, consult your JVC IN-CAR ENTERTAINMENT dealer.

- Refer also to the Instructions supplied with your DAB tuner.

What is DAB system?

DAB is one of the digital radio broadcasting systems available today. It can deliver CD quality sound without any annoying interference and signal distortion. Furthermore, it can carry text, pictures and data.

In contrast to FM broadcast, where each programme is transmitted on its own frequency, DAB combines several programmes (called “services”) to form one “ensemble.” With the DAB tuner connected with this unit, you can enjoy these DAB services.

Tuning in to an ensemble and one of the services

A typical ensemble has 6 or more programmes (services) broadcast at the same time. After tuning in to an ensemble, you can select a service you want to listen to.

1 Select the DAB tuner (DAB1 – 3).

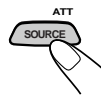

Each time you press the button, the source changes as described on page 7.

2 Select the DAB band (DAB1, DAB2 or DAB3).



Each time you press and hold the button, the DAB band changes as follows:

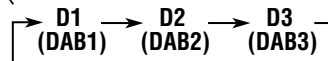

Note:

This receiver has three DAB bands (DAB1, DAB2, DAB3). You can use any of them to tune into an ensemble.

3 Start searching an ensemble.

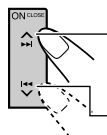

Press **▲▶▶** to search ensembles of higher frequencies.

Press **◀◀▼** to search ensembles of lower frequencies.

When an ensemble is received, searching stops.

To stop searching before an ensemble is received, press the same button you have pressed for searching.

4 Select a service you want to listen to.

BAND MODE



- 1 Press BAND MODE (M).
"MODE" appears on the display.

ON/OFF

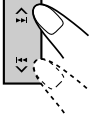

- 2 Press or to select a service you want, while "MODE" is still on the display.

To change the display information while tuning into an ensemble

Normally service name is shown on the display. If you want to check the ensemble name or its frequency, press DISP (D).

Each time you press the button, the following information appears for a while on the display.

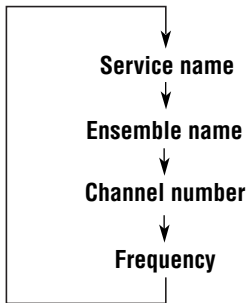

To tune in a particular ensemble without searching:

- 1 Press SOURCE ATT to select DAB tuner as the source.
- 2 Press BAND MODE (M) repeatedly to select the DAB band (DAB1, DAB2 or DAB3).
- 3 Press and hold or for more than 1 second.
- 4 Press or repeatedly until the ensemble you want is reached.
 - If you hold down the button, the ensemble keeps changing until you release the button.

Storing DAB services in memory

You can preset up to 6 DAB services in each DAB band (DAB1, DAB2 and DAB3) manually.

1 Select the DAB tuner (DAB1 – 3).

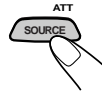

- 1 Press SOURCE ATT to select DAB tuner as the source.

BAND MODE



- 2 If necessary, press and hold BAND MODE (M) repeatedly to select the DAB band number (DAB1, DAB2 or DAB3).

Each time you press and hold the button, the DAB band changes as follows:

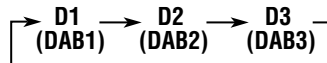

2 Tune in to an ensemble you want.

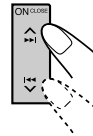

3 Select a service of the ensemble you want.

BAND MODE



- 1 Press BAND MODE (M).
"MODE" appears on the display.

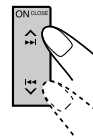

- 2 Press or to select a service you want, while "MODE" is still on the display.

CONTINUED ON THE NEXT PAGE

- 4** Press and hold the number button (in this example, 1) you want to store the selected service into for more than 2 seconds.



"PI" flashes for a few seconds.

- 5** Repeat the above procedure to store other DAB services into other preset numbers.

Notes:

- A previously preset DAB service is erased when a new DAB service is stored in the same preset number.
- Preset DAB services are erased when the power supply to the memory circuit is interrupted (for example, during battery replacement). If this occurs, preset the DAB services again.

Tuning in to a preset DAB service

You can easily tune in to a preset DAB service. Remember that you must store services first. If you have not stored them yet, see page 39.

- 1** Select the DAB tuner (DAB1 – 3).



- 1 Press SOURCE ATT to select DAB tuner as the source.



- 2 If necessary, press and hold BAND MODE (M) repeatedly to select the DAB band number (DAB1, DAB2 or DAB3).

Each time you press and hold the button, the DAB band changes as follows:

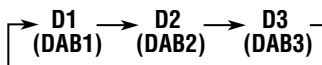

- 2** Select the number (1 – 6) for the preset DAB service you want.

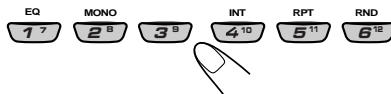

What you can do more with DAB

Tracing the same program automatically (Alternative Reception)

You can keep listening to the same program.

- **While receiving a DAB service:**

When driving in an area where a service cannot be received, this unit automatically tunes in another ensemble or FM RDS station, broadcasting the same program.

- **While receiving an FM RDS station:**

When driving in an area where a DAB service is broadcasting the same program as the FM RDS station is broadcasting, this unit automatically tunes in to the DAB service.

Note:

When reception switches between DAB and FM, the listening volume level may increase or decrease inconveniently. This change in the volume level results from unequal audio injection levels at broadcaster site, but not from the malfunction of this unit.

To prevent this inconvenience, you can adjust the DAB volume level (see below).

To adjust the DAB volume level

You can adjust the input level of DAB tuner and store it in memory. By adjusting the input level properly to match it to the FM sound level, you will not need to adjust the volume level each time you change the source.

When shipped from the factory, DAB volume level is set at "00."

- See also "Changing the general settings (PSM)" on page 25.

- 1 Press and hold SEL (S) for more than 2 seconds so that one of the PSM items appears on the display.
- 2 Press **▲▶▶** or **◀◀▼** to select "DAB VOL (volume)".
- 3 Turn the control dial to set to the desired volume.
You can set it from "-12" to "12."
- 4 Press SEL (S) to finish the setting.

To use Alternative Reception

When shipped from the factory, Alternative Reception is activated.

- See also "Changing the general settings (PSM)" on page 25.

- 1 Press and hold SEL (S) for more than 2 seconds so that one of the PSM items appears on the display.
- 2 Press **▲▶▶** or **◀◀▼** to select "DAB AF (alternative frequency)".
- 3 Turn the control dial to select the desired mode.
 - AF ON: Traces the program among DAB services and FM RDS stations — Alternative Reception. The AF indicator lights up on the display (see page 12).
 - AF OFF: Deactivates Alternative Reception

Note:

When Alternative Reception (for DAB services) is activated, Network-Tracking Reception (for RDS stations: see page 12) is also activated automatically. On the other hand, Network-Tracking Reception cannot be deactivated without deactivating Alternative Reception.

- 4 Press SEL (S) to finish the setting.



TROUBLESHOOTING

What appears to be trouble is not always serious. Check the following points before calling a service centre.

Symptoms	Causes	Remedies
<ul style="list-style-type: none"> CD cannot be played back. 	CD is inserted upside down.	Insert the CD correctly.
<ul style="list-style-type: none"> CD sound is sometimes interrupted. 	You are driving on rough roads.	Stop CD play while driving on rough roads.
	CD is scratched.	Change the CD.
	Connections are incorrect.	Check the cords and connections.
<ul style="list-style-type: none"> CD-R/CD-RW cannot be played back. Tracks on the CD-R/CD-RW cannot be skipped. 	CD-R/CD-RW is not finalized.	<ul style="list-style-type: none"> Insert a finalized CD-R/CD-RW. Finalize the CD-R/CD-RW with the component which you used for recording.
<ul style="list-style-type: none"> "EJECT ERR" appears on the display and CD cannot be ejected. 	The CD player may function incorrectly.	Press and hold ⏪ ⏩ for more than 5 seconds.
<ul style="list-style-type: none"> No message appears on the display but CD cannot be ejected. 		While holding ⏪ ⏩ , press the reset button. Release the reset button, then release ⏪ ⏩ . (Be careful not to drop the CD when ejecting.)
<ul style="list-style-type: none"> Sound cannot be heard from the speakers. 	The volume level is set to the minimum level.	Adjust it to the optimum level.
	Connections are incorrect.	Check the cords and connections.
<ul style="list-style-type: none"> SSM (Strong-station Sequential Memory) automatic preset does not work. 	Signals are too weak.	Store stations manually.
<ul style="list-style-type: none"> Static noise while listening to the radio. 	The antenna is not connected firmly.	Connect the antenna firmly.



Symptoms	Causes	Remedies
<ul style="list-style-type: none">• “NO MAG” appears on the display.	No magazine is loaded in the CD changer.	Insert the magazine.
<ul style="list-style-type: none">• “NO DISC” appears on the display.	No CD is in the magazine.	Insert CD.
<ul style="list-style-type: none">• “RESET 8” appears on the display.	This unit is not connected to a CD changer correctly.	Connect this unit and the CD changer correctly and press the reset button of the CD changer.
<ul style="list-style-type: none">• “RESET 1” – “RESET 7” appears on the display.	_____	Press the reset button of the CD changer.
<ul style="list-style-type: none">• When “ERR 20” to “ERR 40” appears on the display.	There is something blocking the control cover movement.	Press the reset button on the front panel. (See page 2.) If the reset button does not work, check the Installation/ Connection Manual (separate volume). (Ex.: You have used a longer screws than specified.)
<ul style="list-style-type: none">• “” appears on the display.	Security lock is in use.	Enter the password. (See page 33.)
<ul style="list-style-type: none">• This unit does not work at all.• The CD changer does not work at all.	The built-in microcomputer may function incorrectly due to noise, etc.	Press the reset button on the front panel. (See page 2.)



Handling CDs

This unit has been designed to reproduce the CDs bearing the following marks.



You can play back your original CD-Rs (Recordable) and CD-RWs (Rewritable) on this receiver.

This unit is not compatible with MP3.

How to handle CDs

When removing a CD from its case, press down the center holder of the case and lift the CD out, holding it by the edges.

Center holder

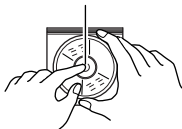

- Always hold the CD by the edges. Do not touch its recording surface.

When storing a CD into its case, gently insert the CD around the center holder (with the printed surface facing up).

- Make sure to store CDs into the cases after use.

To keep CDs clean

A dirty CD may not play correctly. If a CD does become dirty, wipe it with a soft cloth in a straight line from center to edge.

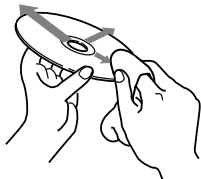

To play new CDs

New CDs may have some rough spots around the inner and outer edges. If such a CD is used, this unit may reject the CD. To remove these rough spots, rub the edges with a pencil or ball-point pen, etc.

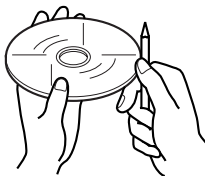

Moisture condensation

Moisture may condense on the lens inside the CD player in the following cases:

- After starting the heater in the car.
- If it becomes very humid inside the car.

Should this occur, the CD player may malfunction. In this case, eject the CD and leave the unit turned on for a few hours until the moisture evaporates.

When playing a CD-R or CD-RW

User-edited CD-Rs (Recordable) and CD-RWs (Rewritable) can be played back only if they are already "finalized."

- You can play back your original CD-Rs or CD-RWs recorded in music CD format. (However, they may not be played back depending on their characteristics or recording conditions.)
- Before playing back CD-Rs or CD-RWs, read their instructions or cautions carefully.
- Some CD-Rs or CD-RWs may not be played back on this unit because of their disc characteristics, damage or stain on them, or if the player's lens is dirty.
- CD-Rs or CD-RWs are susceptible to high temperatures or high humidity; so do not leave them inside your car.
- CD-RWs may require a longer readout time. (This is caused by the fact that the reflectance of CD-RWs is lower than for regular CDs.)

CAUTIONS:

- Do not insert 8 cm CDs (single CDs) into the loading slot. (Such CDs cannot be ejected.)
- Do not insert any CD of unusual shape – like a heart or flower; otherwise, it will cause a malfunction.
- Do not expose CDs to direct sunlight or any heat source or place them in a place subject to high temperature and humidity. Do not leave them in a car.
- Do not use any solvent (for example, conventional record cleaner, spray, thinner, benzene, etc.) to clean CDs.

About mistracking:

Mistracking may result from driving on extremely rough roads. This does not damage the unit and the CD, but will be annoying.

We recommend that you stop CD play while driving on such rough roads.

AUDIO AMPLIFIER SECTION

Maximum Power Output:

Front: 50 W per channel

Rear: 50 W per channel

Continuous Power Output (RMS):

Front: 19 W per channel into 4 Ω , 40 Hz to 20 000 Hz at no more than 0.8% total harmonic distortion.

Rear: 19 W per channel into 4 Ω , 40 Hz to 20 000 Hz at no more than 0.8% total harmonic distortion.

Load Impedance: 4 Ω (4 Ω to 8 Ω allowance)

Tone Control Range:

Bass: ± 10 dB at 100 Hz

Treble: ± 10 dB at 10 kHz

Frequency Response: 40 Hz to 20 000 Hz

Signal-to-Noise Ratio: 70 dB

Line-In Level/Impedance (only for KD-LX333R):

1.5 V/20 k Ω load

Line-Out Level/Impedance:

KD-LX333R: 4.0 V/20 k Ω load (full scale)

KD-LX111R: 2.0 V/20 k Ω load (full scale)

Output Impedance: 1 k Ω

TUNER SECTION

Frequency Range:

FM: 87.5 MHz to 108.0 MHz

AM: (MW) 522 kHz to 1 620 kHz

(LW) 144 kHz to 279 kHz

[FM Tuner]

Usable Sensitivity: 11.3 dBf (1.0 μ V/75 Ω)

50 dB Quieting Sensitivity:

16.3 dBf (1.8 μ V/75 Ω)

Alternate Channel Selectivity (400 kHz):

65 dB

Frequency Response: 40 Hz to 15 000 Hz

Stereo Separation: 30 dB

Capture Ratio: 1.5 dB

[MW Tuner]

Sensitivity: 20 μ V

Selectivity: 35 dB

[LW Tuner]

Sensitivity: 50 μ V

CD PLAYER SECTION

Type: Compact disc player

Signal Detection System: Non-contact optical pickup (semiconductor laser)

Number of channels: 2 channels (stereo)

Frequency Response: 5 Hz to 20 000 Hz

Dynamic Range: 96 dB

Signal-to-Noise Ratio: 98 dB

Wow and Flutter: Less than measurable limit

GENERAL

Power Requirement:

Operating Voltage: DC 14.4 V

(11 V to 16 V allowance)

Grounding System: Negative ground

Allowable Operating Temperature:

0°C to +40°C

Dimensions (W \times H \times D):

Installation Size:

182 mm \times 52 mm \times 160 mm

Panel Size:

188 mm \times 58 mm \times 8 mm

Mass: 1.8 kg (excluding accessories)

Design and specifications subject to change without notice.

Having TROUBLE with operation?

Please reset your unit

Refer to page of How to reset your unit

Haben Sie PROBLEME mit dem Betrieb?

Bitte setzen Sie Ihr Gerät zurück

Siehe Seite Zurücksetzen des Geräts

Vous avez des PROBLÈMES de fonctionnement?

Réinitialisez votre appareil

Référez-vous à la page intitulée Comment réinitialiser votre appareil

Hebt u PROBLEMEN met de bediening?

Stel het apparaat terug

Zie de pagina met de paragraaf Het apparaat terugstellen

JVC

VICTOR COMPANY OF JAPAN, LIMITED



EN, GE, FR, NL



0102MNMMDTTKR

Download from [Www.Somanuals.com](http://www.Somanuals.com). All Manuals Search And Download.

Canceling the demonstration / Deaktivieren der Demonstration / Annulation de la démonstration / De demonstratie annuleren

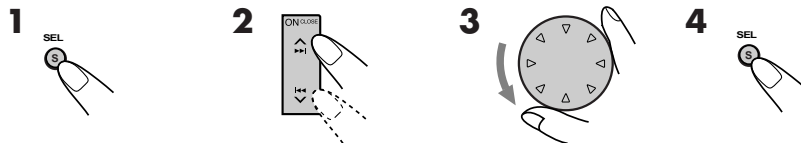

ENGLISH

When shipped from the factory, demonstration has been activated, and starts automatically when no operations are done for about 20 seconds.

- It is recommended to cancel the demonstration before you use the unit for the first time.

To cancel the demonstration, follow the procedure below.

- 1** Press and hold SEL (S) for more than 2 seconds so that one of the PSM items appears on the display.
- 2** Select "DEMO MODE" if not shown on the display.
- 3** Select "DEMO OFF."
- 4** Finish the setting.

To activate the demonstration again, repeat the same procedure and select "DEMO ON" in step 3.

DEUTSCH

Die Demonstration ist werkseitig aktiviert und wird automatisch gestartet, wenn das Gerät 20 Sekunden lang nicht genutzt wird.

- Wir empfehlen, die Demonstration zu deaktivieren, bevor Sie das Gerät zum ersten Mal verwenden.

So deaktivieren Sie die Demonstration:

- 1** Drücken Sie die Taste SEL (S), und halten Sie sie länger als 2 Sekunden gedrückt, bis eine der PSM-Elemente im Display angezeigt wird.
- 2** Wählen Sie „DEMO MODE“ (Demomodus) sofern nicht bereits im Display angezeigt wird.
- 3** Wählen Sie „DEMO OFF“ (Demo aus).
- 4** Bestätigen Sie die Einstellung.

Wenn Sie die Demonstration wieder aktivieren wollen, wiederholen Sie die obigen Schritte und wählen „DEMO ON“ (Demo ein) in Schritt 3.

FRANÇAIS

À l'expédition de l'usine, la démonstration est en service et celle-ci démarre automatiquement quand aucune opération n'est effectuée pendant environ 20 secondes.

- Il est recommandé d'annuler la démonstration avant d'utiliser l'appareil pour la première fois.

Pour annuler la démonstration, suivez la procédure ci-dessous.

- 1** Maintenez pressée SEL (S) pendant plus de 2 secondes de façon que l'un des éléments PSM apparaisse sur l'affichage.
- 2** Choisissez "DEMO MODE" s'il n'apparaît pas sur l'affichage.
- 3** Choisissez "DEMO OFF".
- 4** Terminez le réglage.

Pour mettre de nouveau la démonstration en service, répétez la même procédure et choisissez "DEMO ON" à l'étape 3.

NEDERLANDS

Wanneer dit product de fabriek verlaat, is demonstratie geactiveerd. De demonstratie zal automatisch starten wanneer er 20 seconden lang geen handelingen worden uitgevoerd.

- Het is raadzaam de demonstratie te annuleren voordat u het apparaat voor het eerst gebruikt.

Zo annuleert u de demonstratie, moet u de onderstaande procedure volgen:

- 1** Druk op SEL (S) in en houd deze ten minste 2 seconden ingedrukt, zodat een van de PSM-vermeldingen op de display wordt weergegeven.
- 2** Selecteer de vermelding "DEMO MODE" als deze al niet meteen op de display wordt weergegeven.
- 3** Selecteer de vermelding "DEMO OFF".
- 4** Voltooi de instelling.

U activeert de demonstratie opnieuw door dezelfde procedure te herhalen en in stap 3 "DEMO ON" te selecteren.

PTC004400

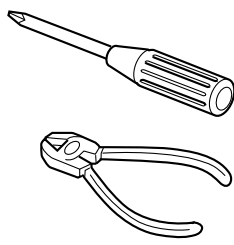

ENGLISH

- This unit is designed to operate on 12 V DC, NEGATIVE ground electrical systems.

INSTALLATION (IN-DASH MOUNTING)

- The following illustration shows a typical installation. However, you should make adjustments corresponding to your specific car. If you have any questions or require information regarding installation kits, consult your JVC IN-CAR ENTERTAINMENT dealer or a company supplying kits.

- Remove the trim plate.
- Remove the sleeve after disengaging the sleeve locks.
 - Stand the unit.

Note: When you stand the unit, be careful not to damage the fuse on the rear.
 - Insert the 2 handles between the unit and the sleeve, as illustrated, to disengage the sleeve locks.
 - Remove the sleeve.

Note: Be sure to keep the handles for future use after installing the unit.
- Attach the trim plate.
- Install the sleeve into the dashboard.

* After the sleeve is correctly installed into the dashboard, bend the appropriate tabs to hold the sleeve firmly in place, as illustrated.
- Fix the mounting bolt to the rear of the unit's body and place the rubber cushion over the end of the bolt.
- Do the required electrical connections.
- Slide the unit into the sleeve until it is locked by pressing the four corners of the trim plate.

Note: Do not press the panel (shaded in the illustration); otherwise, the panel may become unable to open or close.

DEUTSCH

- Dieses Gerät ist für einen Betrieb in elektrischen Anlagen mit 12 V Gleichstrom und (-) Erdung ausgelegt.

EINBAU (IM ARMATURENBRETT)

- Die folgende Abbildung zeigt einen typischen Einbau. Dennoch müssen Sie entsprechend Ihrem jeweiligen Auto Anpassungen vornehmen. Bei irgendwelchen Fragen oder wenn Sie Informationen hinsichtlich des Einbausatzes brauchen, wenden Sie sich an ihren JVC Autoradiohändler oder ein Unternehmen das diese Einbausätze vertreibt.

- Den Frontrahmen herausnehmen.
- Die Halterung nach dem Entriegeln der Halterungssperren herausnehmen.
 - Das Gerät aufstellen.

Hinweis: Beim Aufstellen des Geräts darauf achten, daß die Sicherung auf der Rückseite nicht beschädigt wird.
 - Die 2 Griffe zwischen dem Gerät und der Halterung wie abgebildet einstecken und die Halterungssperren entriegeln.
 - Die Halterung herausnehmen.

Hinweis: Sicherstellen, daß die Griffe für künftigen Gebrauch nach dem Einbau des Geräts aufbewahrt werden.
- Befestigen Sie die Frontrahmen.
- Die Halterung im Armaturenbrett einbauen.

* Nach dem korrekten Einbau der Halterung im Armaturenbrett, die entsprechenden Riegel umknicken, um die Halterung an ihrem Platz zu sichern, siehe Abbildung.
- Die Befestigungsschraube an der Rückseite des Gerätekörpers befestigen und das Ende der Schraube mit einem Gummipuffer abdecken.
- Nehmen Sie die erforderlichen elektrischen Anschlüsse vor.
- Schieben Sie das Gerät in die Halterung. Das Gerät wird verriegelt, indem Sie auf die vier Ecken des Frontrahmen drücken.

Hinweis: Drücken Sie nicht auf die Blende (die in der Abbildung dunkelgetönt dargestellt ist); anderenfalls läßt sich die Blende weder öffnen noch schließen.

FRANÇAIS

- Cet appareil est conçu pour fonctionner sur des sources de courant continu de 12 V à masse NEGATIVE.

INSTALLATION (MONTAGE DANS LE TABLEAU DE BORD)

- L'illustration suivante est un exemple d'installation typique. Cependant, vous devez faire les ajustements correspondant à votre voiture particulière. Si vous avez des questions ou avez besoin d'information sur des kits d'installation, consulter votre revendeur d'autoradios JVC ou une compagnie d'approvisionnement.

- Retirer la plaque d'assemblage.
- Libérer les verrous du manchon et retirer le manchon.
 - Poser l'appareil à la verticale.

Remarque: Lorsque vous mettez l'appareil à la verticale, faire attention de ne pas endommager le fusible situé sur l'arrière.
 - Insérer les 2 poignées entre l'appareil et le manchon comme indiqué pour désengager les verrous de manchon.
 - Retirer le manchon.

Remarque: S'assurer de garder les poignées pour une utilisation ultérieure, après l'installation de l'appareil.
- Attachez la plaque d'assemblage.
- Installer le manchon dans le tableau de bord.

* Après installation correcte du manchon dans le tableau de bord, plier les bonnes pattes pour maintenir fermement le manchon en place, comme montré.
- Monter le boulon de montage sur l'arrière du corps de l'appareil puis passer l'amortisseur en caoutchouc sur l'extrémité du boulon.
- Réalisez les connexions électriques.
- Faire glisser l'appareil dans le manchon jusqu'à ce qu'il soit verrouillé en appuyant sur les quatre coins de la plaque d'assemblage.

Remarque: N'appuyez pas sur le panneau (ombré sur l'illustration); sinon le panneau risquerait de ne pas pouvoir s'ouvrir ou se fermer.

NEDERLANDS

- Dit apparaat mag worden gebruikt bij elektrische systemen die werken op 12 V gelijkstroom met negatieve aarding.

INSTALLATIE (INBOUW IN HET DASHBOARD)

- Op de volgende afbeelding kunt u zien hoe de installatie, normaal gesproken, in zijn werk gaat. U moet echter bij de installatie rekening houden met de bijzonderheden van uw eigen auto. Neem bij vragen of voor meer bijzonderheden over inbouwpakketten contact op met uw JVC car audio dealer of een dealer of een bedrijf dat inbouwpakketten levert.

- Verwijder de sierplaat.
- Verwijder het huis nadat u de klemmen hebt losgemaakt.
 - Zet het apparaat rechtop.

Opmerking: Wanneer u het apparaat rechtop zet, moet u erop letten dat u de zekering aan de achterkant niet beschadigt.
 - Plaats de 2 hendels, zoals afgebeeld, tussen het apparaat en het huis, om de klemmen los te maken.
 - Verwijder het huis.

Opmerking: Bewaar de hendels nadat u het apparaat hebt geïnstalleerd, zodat u ze ook in de toekomst kunt gebruiken.
- Bevestig de sierplaat.
- Installeer het huis in het dashboard.

* Nadat het huis op de juiste wijze in het dashboard is geplaatst, moet u de palletjes, zoals afgebeeld, stevig op hun plaats duwen.
- Maak de bevestigingsbout aan de achterkant van het apparaat vast en plaats de rubberdop over het uiteinde van de bout.
- Breng de vereiste elektrische verbindingen tot stand.
- Schuif het apparaat in het huis totdat het vergrendeld is, kunt u deze vastzetten door op de vier hoeken van de sierplaat te drukken.

Opmerking: Druk niet op het paneel zelf (gearceerd weergegeven in de illustratie); anders kunt u het paneel zodanig beschadigen dat dit niet meer kan worden geopend en gesloten.

1

Trim plate
Frontrahmen
Plaque d'assemblage
Sierplaat

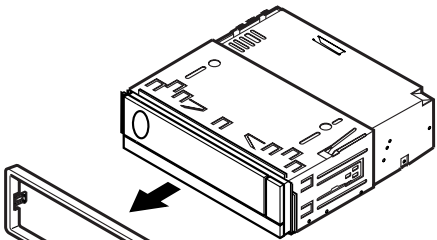

Trim plate
Frontrahmen
Plaque d'assemblage
Sierplaat

2

Handle
Griff
Poignée
Hendel

Slot
Schlitz
Fente
Stauf

Fuse
Sicherung
Fusible
Zekering

Lock Plate
Arretierplättchen
Plaque de verrouillage
Vergrendelingsplaat

Sleeve
Halterung
Manchon
Huis

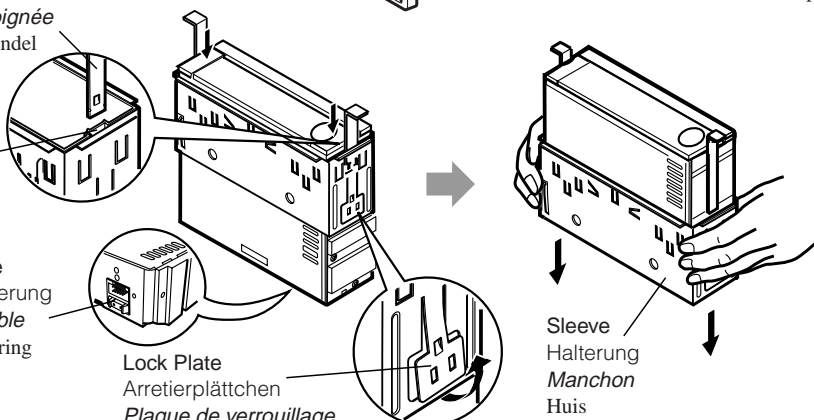

3

Dashboard
Armaturenbrett
Tableau de bord
Dashboard

Rubber cushion
Gummipuffer
Amortisseur en caoutchouc
Rubberdop

Sleeve
Halterung
Manchon
Huis

Mounting bolt
Befestigungsschraube
Boulon de montage
Bevestigingsbout

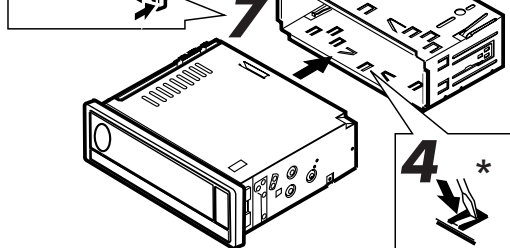

6 See "ELECTRICAL CONNECTIONS."
Siehe „ELEKTRISCHE ANSCHLÜSSE“.
Réferez-vous "RACCORDEMENTS
ELECTRIQUES".
Zie "ELEKTRISCHE VERBINDINGEN".

TROUBLESHOOTING

- The fuse blows.**
 - * Are the red and black leads connected correctly?
- Power cannot be turned on.**
 - * Is the yellow lead connected?
- No sound from the speakers.**
 - * Is the speaker output lead short-circuited?
- Sound is distorted.**
 - * Is the speaker output lead grounded?
 - * Are the "-" terminals of L and R speakers grounded in common?
- Unit becomes hot.**
 - * Is the speaker output lead grounded?
 - * Are the "-" terminals of L and R speakers grounded in common?

FEHLERSUCHE

- Die Sicherung brennt durch.**
 - * Sind die roten und schwarzen Leitungen richtig angeschlossen?
- Stromversorgung kann nicht eingeschaltet werden.**
 - * Ist die gelbe Leitung angeschlossen?
- Kein Ton aus den Lautsprechern.**
 - * Ist die Lautsprecherausgangsleitung kurzgeschlossen?
- Ton verzerrt.**
 - * Ist die Lautsprecherausgangsleitung geerdet?
 - * Sind die (-) Anschlußklemmen der linken und rechten Lautsprecher zusammen geerdet?
- Gerät wird heiß.**
 - * Ist die Lautsprecherausgangsleitung geerdet?
 - * Sind die (-) Anschlußklemmen der linken und rechten Lautsprecher zusammen geerdet?

EN CAS DE DIFFICULTES

- Le fusible saute.**
 - * Les fils rouge et noir sont-ils raccordés correctement?
- L'appareil ne peut pas être mise sous tension.**
 - * Le fil jaune est-elle raccordée?
- Pas de son des enceintes.**
 - * Le fil de sortie d'enceinte est-il court-circuité?
- Le son est déformé.**
 - * Le fil de sortie d'enceinte est-il à la masse?
 - * Les bornes "-" des enceintes gauche et droit sont-elles mises ensemble à la masse?
- L'appareil devient chaud.**
 - * Le fil de sortie d'enceinte est-il à la masse?
 - * Les bornes "-" des enceintes gauche et droit sont-elles mises ensemble à la masse?

PROBLEMEN OPLOSSEN

- De zekering slaat door.**
 - * Zijn de rode en de zwarte draden op de juiste manier aangesloten?
- De stroom kan niet worden ingeschakeld.**
 - * Is de gele draad aangesloten?
- Er komt geen geluid uit de speakers.**
 - * Is de uitgaande speakerdraad kortgesloten?
- Het geluid wordt vervormd.**
 - * Is de uitgaande speakerdraad geaard?
 - * Zijn de minpolen van de linker- en de rechtsspeakers gemeenschappelijk geaard?
- Het apparaat raakt verhit.**
 - * Is de uitgaande speakerdraad geaard?
 - * Zijn de minpolen van de linker- en de rechtsspeakers gemeenschappelijk geaard?

- When using the optional stay
- Beim Verwenden der Anker-Option
- Lors de l'utilisation du hauban (en option)
- Wanneer u de steun gebruikt (facultatief)

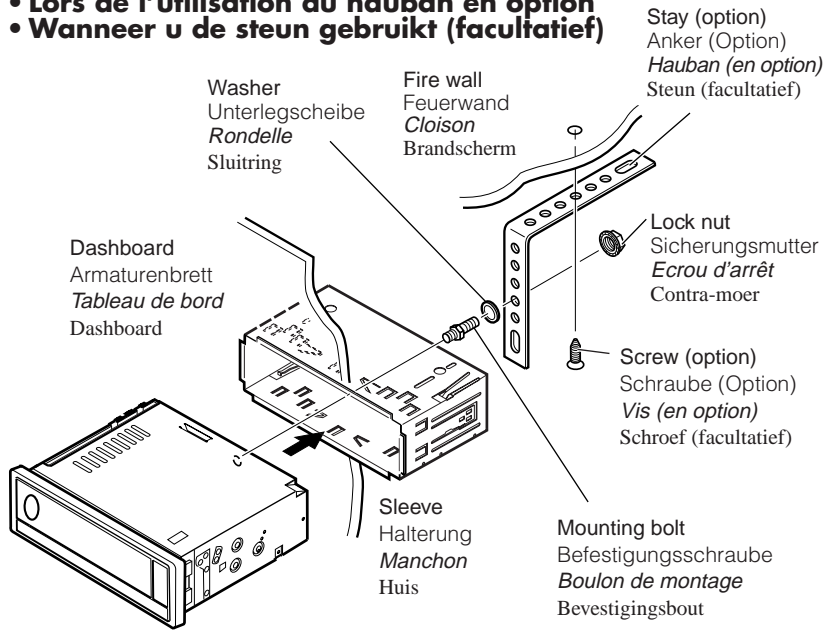

- When installing the unit without using the sleeve
- Beim Einbau des Geräts ohne Halterung
- Lors de l'installation de l'appareil sans utiliser de manchon
- Wanneer u het apparaat zonder hoes installeert

In a Toyota for example, first remove the car radio and install the unit in its place.
Zum Beispiel in einem Toyota zuerst das Autoradio ausbauen und dann das Gerät an seinem Platz einbauen.
Par exemple dans une Toyota, retirer d'abord l'autoradio et installer l'appareil à la place.
Voorbeeld: Bij een Toyota moet u eerst de autoradio verwijderen en daarna het apparaat installeren.

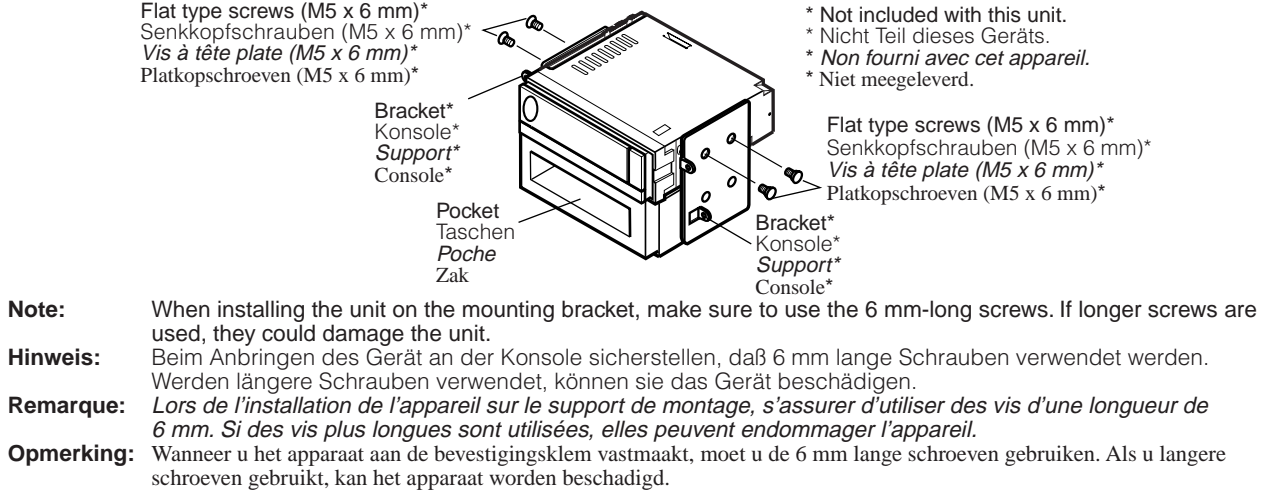

Note: When installing the unit on the mounting bracket, make sure to use the 6 mm-long screws. If longer screws are used, they could damage the unit.
Hinweis: Beim Anbringen des Geräts an der Konsole sicherstellen, daß 6 mm lange Schrauben verwendet werden. Werden längere Schrauben verwendet, können sie das Gerät beschädigen.
Remarque: Lors de l'installation de l'appareil sur le support de montage, s'assurer d'utiliser des vis d'une longueur de 6 mm. Si des vis plus longues sont utilisées, elles peuvent endommager l'appareil.
Opmerking: Wanneer u het apparaat aan de bevestigingsklem vastmaakt, moet u de 6 mm lange schroeven gebruiken. Als u langere schroeven gebruikt, kan het apparaat worden beschadigd.

Removing the unit

- Before removing the unit, release the rear section.
- 1 Remove the trim plate.
- 2 Insert the 2 handles into the slots, as shown. Then, while gently pulling the handles away from each other, slide out the unit. (Be sure to keep the handles after installing it.)

Ausbau des Geräts

- Vor dem Ausbau des Geräts den hinteren Teil freigeben.
- 1 Den Frontrahmen herausnehmen.
- 2 Die 2 Griffe in die Schlitze wie gezeigt stecken. Dann die Griffe behutsam auseinander ziehen und das Gerät herausziehen. (Die Griffe nach dem Einbau auf jeden Fall aufbewahren.)

Retrait de l'appareil

- Avant de retirer l'appareil, libérer la section arrière.
- 1 Retirer la plaque d'assemblage.
- 2 Introduire les 2 poignées dans les fentes, comme montré. Puis, tout en tirant doucement les poignées écartées, faire glisser l'appareil pour le sortir. (S'assurer de conserver les poignées après l'installation de l'appareil.)

Verwijderen van het apparaat

- Voordat u het apparaat verwijdert, moet u het achtergedeelte losmaken.
- 1 Verwijder de sierplaat.
- 2 Plaats de 2 hendels, zoals afgebeeld, in de sleuven. Daarna duwt u de hendels zachtjes uit elkaar en kunt u het apparaat naar buiten schuiven. (Bewaar de hendels nadat u het apparaat hebt geïnstalleerd!)

1

Trim plate
Frontrahmen
Plaque d'assemblage
Sierplaat

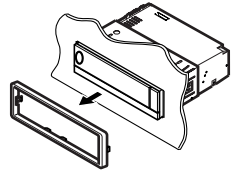

2

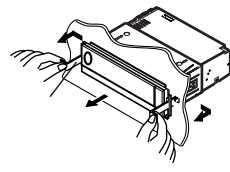

Handle
Griff
Poignée
Hendel

Parts list for installation and connection

The following parts are provided with this unit. After checking them, please set them correctly.

Teilleiste für den Einbau und Anschluß

Die folgenden Teile werden zusammen mit diesem Gerät geliefert. Nach ihrer Überprüfung, die Teile richtig einsetzen.

Liste des pièces pour l'installation et raccordement

Les pièces suivantes sont fournies avec cet appareil. Après vérification, veuillez les placer correctement.

Lijst van onderdelen die u bij installatie en aansluiting nodig hebt

De volgende onderdelen worden bij het apparaat geleverd. Installeer ze op de juiste wijze, nadat u ze hebt gecontroleerd.

Sleeve
Halterung
Manchon
Huis

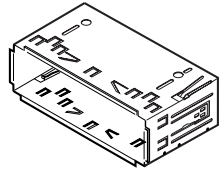

Trim plate
Frontrahmen
Plaque d'assemblage
Sierplaat

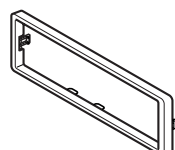

Handles
Griffe
Poignées
Hendels



Power cord
Stromkabel
Cordon d'alimentation
Stroomkabel

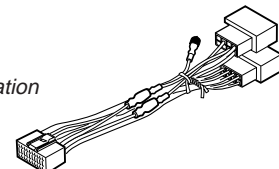

Washer (ø5)
Unterlegscheibe (ø5)
Rondelle (ø5)
Sluistring (ø5)



Lock nut (M5)
Sicherungsmutter (M5)
Ecrou d'arrêt (M5)
Contra-moer (M5)



Mounting bolt (M5 x 20 mm)
Befestigungsschraube (M5 x 20 mm)
Boulon de montage (M5 x 20 mm)
Bevestigingsbout (M5 x 20 mm)



Rubber cushion
Gummipuffer
Amortisseur en caoutchouc
Rubberdop



Remote controller
Fernbedienung
Télécommande
Afstandsbediening

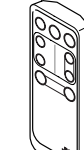

Battery
Batterie
Pile
Batterij



Only for KD-LX333R
Ausschliesslich Modell KD-LX333R
Seulement pour le KD-LX333R
Uitsluitend voor de KD-LX333R

ELECTRICAL CONNECTIONS

ELEKTRISCHE ANSCHLÜSSE

RACCORDEMENTS ELECTRIQUES

ELEKTRISCHE VERBINDINGEN

To prevent short circuits, we recommend that you disconnect the battery's negative terminal and make all electrical connections before installing the unit. If you are not sure how to install this unit correctly, have it installed by a qualified technician.

Zur Vermeidung von Kurzschlüssen empfehlen wir, daß Sie den negativen Batterieanschluß abtrennen und alle elektrischen Anschlüsse herstellen, bevor das Gerät eingebaut wird. Sind Sie sich über den richtigen Einbau des Geräts nicht sicher, lassen Sie es von einem qualifizierten Techniker einbauen.

Pour éviter tout court-circuit, nous vous recommandons de débrancher la borne négative de la batterie et d'effectuer tous les raccordements électriques avant d'installer l'appareil. Si l'on n'est pas sûr de pouvoir installer correctement cet appareil, le faire installer par un technicien qualifié.

Om kortsluiting te voorkomen adviseren wij u om de minpool van de accu los te maken en alle elektrische verbindingen tot stand te brengen voordat u het apparaat in de auto installeert. Als u niet zeker weet hoe u dit apparaat moet installeren, kunt u dit beter door een daartoe gekwalificeerde technicus laten doen.

Note: This unit is designed to operate on 12 V DC, NEGATIVE ground electrical systems. If your vehicle does not have this system, a voltage inverter is required, which can be purchased at JVC IN-CAR ENTERTAINMENT dealers.

Hinweis: Dieses Gerät ist für einen Betrieb in elektrischen Anlagen mit 12 V Gleichstrom und (-) Erdung ausgelegt. Verfügt Ihr Fahrzeug nicht über diese Anlage, ist ein Spannungsinverter erforderlich, der bei JVC Autoradiohändler erworben werden kann.

Remarque: Cet appareil est conçu pour fonctionner sur des sources de courant continu de 12 V à masse NEGATIVE. Si votre véhicule n'offre pas ce type d'alimentation, il vous faut un convertisseur de tension, que vous pouvez acheter chez un revendeur d'autoradios JVC.

Opmerking: Dit apparaat mag worden gebruikt bij elektrische systemen die werken op 12 V gelijkstroom met negatieve aarding. Als uw auto niet is uitgerust met een dergelijk systeem, is een spanningsomzetter vereist. Dit instrument kan worden aangeschaft bij JVC car audio dealers.

- Replace the fuse with one of the specified rating. If the fuse blows frequently, consult your JVC IN-CAR ENTERTAINMENT dealer.
- If noise is a problem... This unit incorporates a noise filter in the power circuit. However, with some vehicles, clicking or other unwanted noise may occur. If this happens, connect the unit's rear ground terminal (see connection diagram) to the car's chassis using shorter and thicker cords, such as copper braiding or gauge wire. If noise still persists, consult your JVC IN-CAR ENTERTAINMENT dealer.
- Maximum input of the speakers should be no more than 50 W at the rear and 50 W at the front, with an impedance of 4 Ω to 8 Ω.
- Be sure to ground this unit to the car's chassis.
- The heat sink becomes very hot after use. Be careful not to touch it when removing this unit.

- Die Sicherung mit einer der entsprechenden Nennleistung ersetzen. Brennt die Sicherung häufig durch, wenden Sie sich an ihren JVC Autoradiohändler.
- Sind Störgeräusche ein Problem... Dieses Gerät enthält ein Störfilter im Stromkreis. Bei manchen Fahrzeugen kann jedoch ein Klicken oder andere unerwünschte Störgeräusche auftreten. Sollte das der Fall sein, die hintere Erdungscanschlussklemme (siehe Schaltplan) des Geräts am Fahrwerk des Fahrzeugs anschließen, dabei kürzere und dickere Kabel wie beispielsweise Kupfergeflecht oder Stahldraht verwenden. Bleibt Störgeräusch bestehen, wenden Sie sich an Ihren JVC Autoradiohändler.
- Maximale Eingangsleistung der Lautsprecher sollte nicht mehr als 50 W hinten und 50 W vorne sein, mit einer Impedanz von 4 Ω bis 8 Ω.
- Sicherstellen, daß das Gerät am Fahrwerk geerdet wird.
- Das Abstrahlblech wird nach dem Gebrauch sehr heiß. Beim Ausbau des Geräts darauf achten, das Abstrahlblech nicht zu berühren.

- Remplacer le fusible par un de la valeur précisée. Si le fusible saute souvent, consulter votre revendeur d'autoradios JVC.
- Si le bruit est un problème... Cet appareil incorpore un filtre de bruit dans le circuit d'alimentation. Cependant, avec certains véhicules, quelques claquements ou autres bruits non désirés risquent de se produire. Si cela arrive, raccorder la borne arrière de masse de l'appareil au châssis de la voiture (voir le diagramme de raccordement) en utilisant des cordons les plus gros et les plus courts possibles telle qu'une barre de cuivre ou une tresse. Si le bruit persiste, consulter votre revendeur d'autoradios JVC.
- La puissance admissible des enceintes devrait n'être pas plus qu'à 50 W à l'arrière et à 50 W l'avant, avec une impédance de 4 Ω à 8 Ω.
- S'assurer de raccorder la mise à la masse de cet appareil au châssis de la voiture.
- Le dissipateur de chaleur devient très chaud après usage. Faire attention de ne pas le toucher en retirant cet appareil.

- Vervang de zekering door een exemplaar met het aangegeven vermogen. Als de zekering vaak doorslaat, moet u uw JVC car audio dealer raadplegen.
- Als u geluidsproblemen hebt... De krachtschakeling van dit apparaat heeft een ingebouwd geluidsfilter. In sommige voertuigen zijn tikgeluiden of andere ongewenste geluiden te horen. Als dit gebeurt, moet u de massaklem aan de achterkant (zie aansluitingsschema) aan het chassis van de auto vastmaken met behulp van een kortere en dickere kabel, zoals kopermanteldraad of tellerkabel. Als het geluid niet verdwijnt, moet u contact opnemen met uw JVC car audio dealer.
- Het maximum ingangsvermogen van de speakers moet achterin niet meer dan 50 W zijn en voorin 50 W, met een impedantie van 4 Ω tot 8 Ω.
- Zorg ervoor dat dit apparaat door middel van een aardkabel is verbonden met het chassis van de auto.
- De warmte-opnemer kan na gebruik erg heet worden. Raak de warmte-opnemer niet aan wanneer u dit apparaat van zijn plaats haalt.

Heat sink
Abstrahlblech
Dissipateur de chaleur
Warmte-opnemer

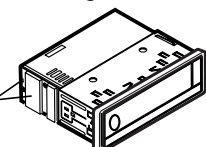

Connecting the leads / Anschließen der Leitungen / Raccordement des fils / Aansluiting van de gekleurde draden

Twist the core wires when connecting. Die Kerndrähte beim Anschließen verdrehen. Torsader les âmes des fils en les raccordant. Draai de kerndraden om elkaar heen wanneer u ze wilt aansluiten.

Solder the core wires to connect them securely. Die Kerndrähte anlöten, um sie fest anzuschließen. Souder les âmes des fils pour les raccorder entre eux de façon sûre. Soldeer de kerndraden zodat ze stevig vast zitten.

CAUTION / VORSICHT / PRECAUTION / LET OP!:

- To prevent short-circuit, cover the terminals of the UNUSED leads with insulating tape.
- Zur Vermeidung eines Kurzschlusses die Anschlußklemmen der NICHT VERWENDETEN Leitungen mit Isolierklebeband umwickeln.
- Pour éviter les court-circuits, couvrir les bornes des fils qui ne sont PAS utilisés avec de la bande isolante.
- Om kortsluiting te voorkomen, moet u de aansluitklemmen van ONGEBRUIKTE gekleurde draden met isolatieband bedekken.

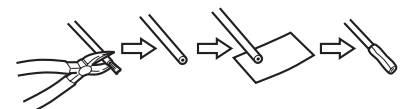

**A If your car is equipped with the ISO connector
Wenn Ihr Auto mit ISO-Steckern ausgestattet ist
Si votre voiture est équipée d'un connecteur ISO
Indien uw auto is uitgerust met de ISO-connector**

- Connect the ISO connectors as illustrated.
- Die ISO-Stecker wie abgebildet anschließen.
- Connectez les connecteurs ISO comme montré sur l'illustration.
- Sluit de ISO-connectoren aan zoals op het voorbeeld is aangegeven.

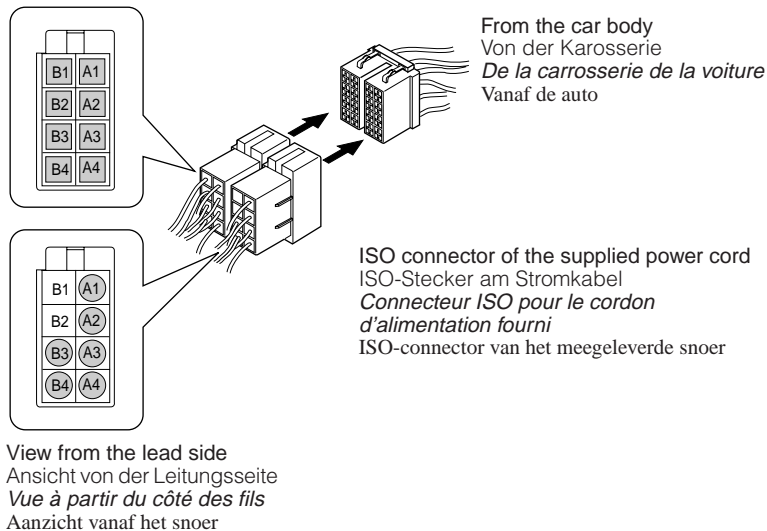

**For some VW/Audi or Opel (Vauxhall) automobile
Für manche VW/Audi oder Opel (Vauxhall) Fahrzeuge
Pour certaine voiture VW/Audi ou Opel (Vauxhall)
Voor bepaalde modellen VW/Audi of Opel (Vauxhall) geldt**

- You may need to modify the wiring of the supplied power cord as illustrated.
- Contact your authorized car dealer before installing this unit.
 - Sie müssen evtl. die Verdrahtung des mitgelieferten Stromkabels wie abgebildet ändern.
 - Wenden Sie sich an Ihre Vertragswerkstatt, bevor Sie das Gerät einbauen.
 - Vous aurez peut-être besoin de modifier le câblage du cordon d'alimentation fourni comme montré sur l'illustration.
 - Contactez votre revendeur automobile autorisé avant d'installer l'appareil.
 - Wellicht moet u de bedrading van het meegeleverde snoer als in het voorbeeld aanpassen.
 - Neem contact op met uw officiële autodealer alvorens dit apparaat te installeren.

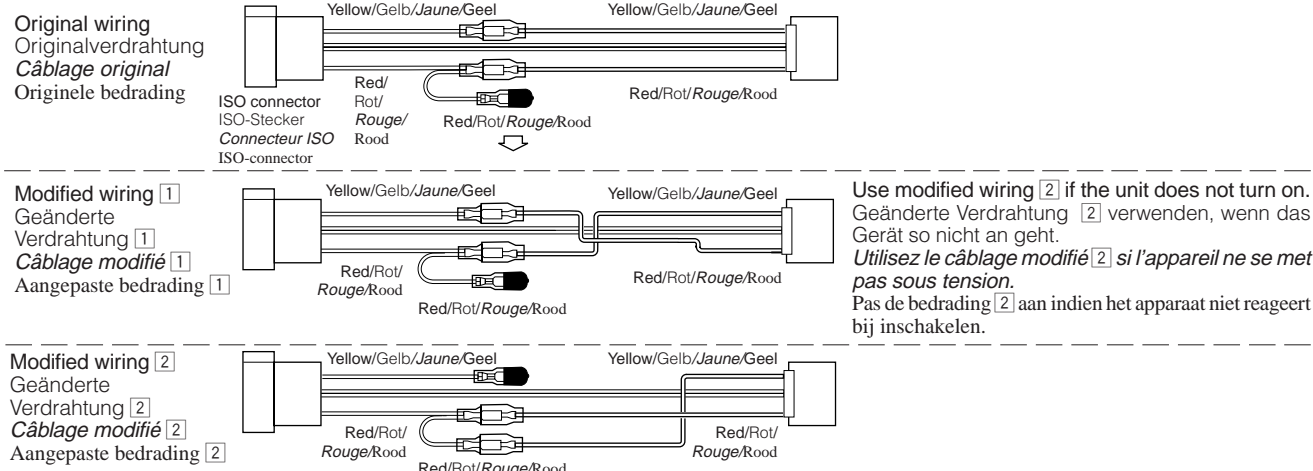

B Connections without using the ISO connectors / Anschlüsse ohne ISO-Stecker / Connexions sans l'utilisation des connecteurs ISO / Verbindingen zonder ISO-connectoren

Before connecting: Check the wiring in the vehicle carefully. Incorrect connection may cause serious damage to this unit.
The leads of the power cord and those of the connector from the car body may be different in colour.

- 1 Cut the ISO connector.
- 2 Connect the colored leads of the power cord to the car battery, speakers and power aerial (if any) in the following sequence:
 - 1 Black: ground
 - 2 Yellow: to car battery (constant 12 V)
 - 3 Red: to an accessory terminal
 - 4 Blue with white stripe: to power aerial (200 mA max.)
 - 5 Orange with white stripe: to car light control switch
 - 6 Brown: to cellular phone system (for details, refer to the instructions of the cellular phone.)
 - 7 Others: to speakers
- 3 Connect the aerial cord.
- 4 Finally connect the wiring harness to the unit.

Vor dem Anschließen: Die Verdrahtung im Fahrzeug sorgfältig überprüfen. Falsche Anschlüsse können ernsthafte Schäden am Gerät hervorrufen.
Die Leiter des Stromkabels und die Leiter des Anschlusses im Fahrzeug können sich farblich unterscheiden.

- 1 Den ISO-Stecker abschneiden.
- 2 Die farbigen Leitungen des Spannungsversorgungskabels an der Autobatterie, den Lautsprechern und dem Motorantenne (sofern vorhanden) in folgender Reihenfolge anschließen.
 - 1 Schwarz: Erdung
 - 2 Gelb: an Autobatterie (konstant 12 V)
 - 3 Rot: zur einer Zubehörananschlußklemme
 - 4 Blau mit weißem Streifen: zur Motorantenne (max. 200 mA)
 - 5 Orange mit weißem Streifen: zur Autolichtschalter
 - 6 Braun: zur Mobiltelefon (weitere Informationen entnehmen Sie bitte der Bedienungsanleitung des Mobiltelefons.)
 - 7 Andere: zur Lautsprecher
- 3 Das Antennenkabel anschließen.
- 4 Die Kabelbäume am Gerät anschließen.

Avant de commencer la connexion: Vérifiez attentivement le câblage du véhicule. Une connexion incorrecte peut endommager sérieusement l'appareil.
Le fil du cordon d'alimentation et ceux des connecteurs du châssis de la voiture peuvent être différents en couleur.

- 1 Coupez le connecteur ISO.
- 2 Connectez les fils de couleur du cordon d'alimentation à la batterie de la voiture, aux enceintes et à l'antenne automatique (s'il y en a une) dans l'ordre suivant.
 - 1 Noir: à la masse
 - 2 Jaune: à la batterie de la voiture (12 V constant)
 - 3 Rouge: à une borne accessoire
 - 4 Bleu avec bande blanche: à l'antenne automatique (200 mA max.)
 - 5 Orange avec bande blanche: à l'interrupteur d'éclairage de la voiture
 - 6 Marron: à un système de téléphone cellulaire (pour les détails, se référer aux instructions du téléphone cellulaire.)
 - 7 Autres: aux enceintes
- 3 Connectez le cordon d'antenne.
- 4 Finalement, connectez le faisceau de fils à l'appareil.

Alvorens de verbindingen tot stand te brengen: Moet u de bedrading in de auto zorgvuldig. Het apparaat kan door verkeerde verbindingen ernstige schade oplopen.
De draden van het stroomkabel verschillen mogelijk van kleur met de aansluitingen op het chassis van de auto.

- 1 Knip de ISO-connector los.
- 2 Sluit de gekleurde snoerdraden van de stroomkabel in de hierna genoemde volgorde aan op de accu van de auto, de luidsprekers en de antenne (indien aanwezig).
 - 1 Zwart: aarde
 - 2 Geel: naar de accu van de auto (constant 12 V)
 - 3 Rood: naar de aansluitklem van de accessoire
 - 4 Blauw met witte streep: naar de antenne (Max. 200 mA)
 - 5 Oranje met witte streep: naar de schakelaar voor de autoverlichting
 - 6 Bruin: naar het mobiele-telefoonsysteem (lees voor meer informatie de instructies die bij de mobiele telefoon worden geleverd.)
 - 7 Andere: naar de speakers
- 3 Sluit de antenne aan.
- 4 Verbind de draadbundel daarna met het apparaat.

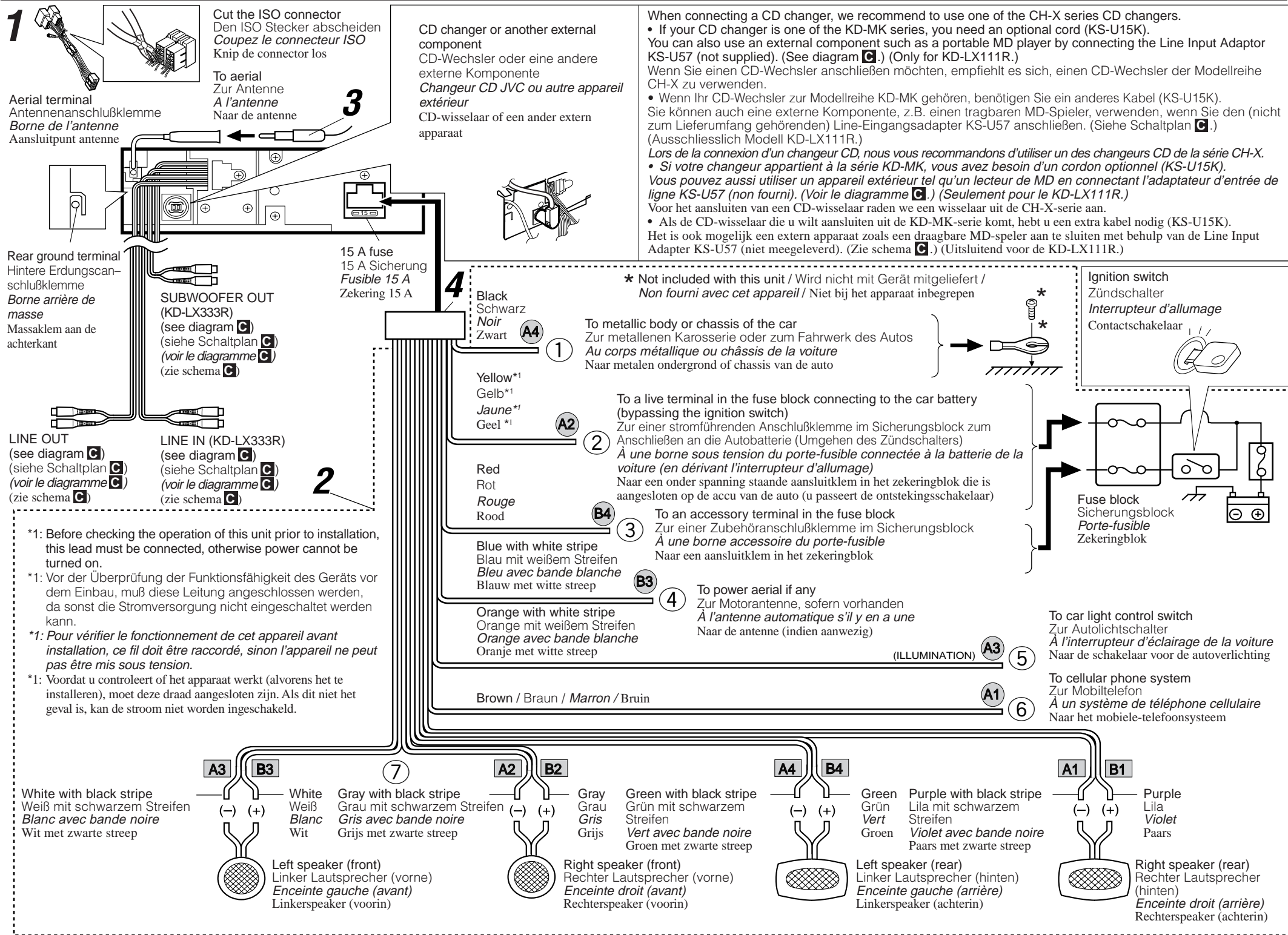

PRECAUTIONS on power supply and speaker connections:

- DO NOT connect the speaker leads of the power cord to the car battery; otherwise, the unit will be seriously damaged.
- Connect the black lead (ground), yellow lead (to car battery, constant 12 V), and red lead (to an accessory terminal) correctly.
- BEFORE connecting the speaker leads of the power cord to the speakers, check the speaker wiring in your car.
 - If the speaker wiring in your car is as illustrated in Fig. 1 and Fig. 2 below, DO NOT connect the unit using that original speaker wiring. If you do, the unit will be seriously damaged. Redo the speaker wiring so that you can connect the unit to the speakers as illustrated in Fig. 3.
 - If the speaker wiring in your car is as illustrated in Fig. 3, you can connect the unit using the original speaker wiring in your car.
 - If you are not sure of the speaker wiring of your car, consult your JVC IN-CAR ENTERTAINMENT dealer.

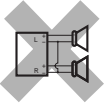

Fig. 1

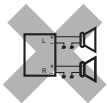

Fig. 2

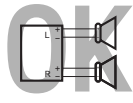

Fig. 3

VORSICHTSMASSREGELN beim Anschließen der Stromversorgung und Lautsprecher:

- Die Lautsprecherleitungen des Netzkabels NICHT an der Autobatterie anschließen, da sonst das Gerät schwer beschädigt wird.
- Die schwarze Leitung (Erdung), die gelbe Leitung (zur Autobatterie, konstant 12 V) und die rote Leitung (zur Zubehörschlußklemme) richtig anschließen.
- VOR dem Anschließen der Lautsprecherleitungen des Spannungsversorgungskabels an die Lautsprecher, die Lautsprecherverdrahtung in Ihrem Auto überprüfen.
 - Ist die Lautsprecherverdrahtung wie unten in "Fig. 1" und "Fig. 2" abgebildet, das Gerät NICHT mit der Originalverdrahtung der Lautsprecher anschließen, da sonst das Gerät schwer beschädigt wird. Die Lautsprecherverdrahtung erneuern, so daß Sie das Gerät an den Lautsprechern wie in "Fig. 3" abgebildet anschließen können.
 - Ist die Lautsprecherverdrahtung in Ihrem Auto wie in "Fig. 3" abgebildet, können Sie das Gerät mit der Originalverdrahtung der Lautsprecher in Ihrem Auto anschließen.
 - Sind Sie sich über die Lautsprecherverdrahtung in Ihrem Auto nicht sicher, wenden Sie sich an Ihren Autohändler.

PRECAUTIONS sur l'alimentation et la connexion des enceintes:

- NE CONNECTEZ PAS les fils d'enceintes du cordon d'alimentation à la batterie; sinon, l'appareil serait sérieusement endommagé.
- Connectez correctement le fil noir (à la masse), le fil jaune (à la batterie de la voiture, 12 V constant) et le fil rouge (à la prise accessoire).
- AVANT de connecter les fils d'enceintes du cordon d'alimentation aux enceintes, vérifiez le câblage des enceintes de votre voiture.
 - Si le câblage des enceintes de votre voiture est comme montré sur la Fig. 1 ou Fig. 2 ci-dessous, NE CONNECTEZ PAS l'appareil en utilisant ce câblage original des enceintes. Si vous le faites, l'appareil sera sérieusement endommagé. Recommencez le câblage des enceintes de façon que vous puissiez connecter l'appareil aux enceintes comme montré sur la Fig. 3.
 - Si le câblage des enceintes de votre voiture est comme montré sur la Fig. 3, vous pouvez connecter l'appareil en utilisant ce câblage original d'enceintes pour votre voiture.
 - Si vous n'êtes pas sûrs du câblage d'enceintes de votre voiture, consulter le concessionnaire de votre voiture.

VOORZORGSMAATREGELEN bij het verbinden van de stroomkabel met de speakers:

- Verbind de speakerdraden van de stroomkabel NIET met de accu van de auto; als u dit wel doet, zal het apparaat ernstige schade oplopen.
- Sluit de zwarte draad (aarde), de gele draad (naar de accu van de auto, constant 12 V) en de rode draad (naar de aansluitklem van de accessoire) op de juiste wijze aan.
- VOORDAT u de speakerdraden van de stroomkabel met de speakers verbindt, moet u de bedrading van de speakers in uw auto controleren.
 - Als de bedrading van de speakers eruitziet zoals hieronder staat afgebeeld in Fig. 1 en Fig. 2, mag het apparaat NIET worden aangesloten met behulp van deze oorspronkelijke speakerbedrading. Als u dat wel doet, zal het apparaat ernstige schade oplopen. Pas de bedrading van de speakers aan, zodat u het apparaat met de speakers kunt verbinden, zoals staat afgebeeld in Fig. 3.
 - Als de bedrading van de speakers eruitziet zoals staat afgebeeld in Fig. 3, kunt u het apparaat aansluiten met behulp van de oorspronkelijke speakerbedrading in uw auto.
 - Als u twijfels hebt over de speakerbedrading in uw auto, moet u contact opnemen met uw autodealer.

Connections Adding Other Equipment / Anschlüsse zum Hinzufügen von anderer Ausrüstung / Raccordement pour ajouter d'autres appareils / Aansluitingen voor het toevoegen van andere apparatuur

Amplifier / Verstärker / Amplificateur / Versterker

You can connect an amplifier and other equipment to upgrade your car stereo system.

- Connect the remote lead (blue with white stripe) to the remote lead of the other equipment so that it can be controlled through this unit.
 - For amplifier only:
 - Connect this unit's line-out terminals to the amplifier's line-in terminals.
 - Disconnect the speakers from this unit, connect them to the amplifier. Leave the speaker leads of this unit unused.
 - Only for KD-LX333R: The line output level of this unit is kept high to maintain the hi-fi sounds reproduced from this unit.
- When connecting an external amplifier to this unit, turn down the gain control on the external amplifier to obtain the best performance from this unit.

Sie können einen Verstärker oder ein anderes Gerät anschließen, um Ihre Autostereoanlage zu erweitern.

- Schließen Sie das Fernbedienungskabel (blau mit weißem Streifen) an das Fernbedienungskabel des anderen Geräts an, so daß es über dieses Gerät gesteuert werden kann.
 - Nur für den Verstärker:
 - Die Anschlußklemmen am Ausgang dieses Gerät an den Anschlußklemmen des Eingangs des Verstärkers anschließen.
 - Die Lautsprecher von diesem Gerät abtrennen und am Verstärker anschließen. Die Lautsprecherleitungen dieses Geräts unbenutzt lassen.
- Ausschließlich Modell KD-LX333R: Der Ausgangspegel dieses Geräts wird auf einem hohen Wert gehalten, um den Hi-Fi-Klang zu unterstützen, den dieses Gerät reproduziert. Wenn Sie einen externen Verstärker an dieses Gerät anschließen, stellen Sie den Verstärkungsregler des externen Verstärkers herunter, um die bestmögliche Leistung dieses Geräts zu erzielen.

Vous pouvez connecter un amplificateur ou autre appareil pour améliorer votre système autoradio.

- Connectez le fil de commande à distance (bleu avec bande blanche) au fil de commande à distance de l'autre appareil de façon qu'il puisse être commandé via cet appareil.
 - Pour l'amplificateur seulement:
 - Raccorder les bornes de sortie ligne de cet appareil aux bornes d'entrée ligne de l'amplificateur.
 - Déconnectez les enceintes de cet appareil et connectez-les à cet amplificateur. Laissez les fils d'enceintes de cet appareil inutilisés.
 - Seulement pour le KD-LX333R: Le niveau de sortie de ligne de cet appareil est maintenu à un niveau élevé pour maintenir une qualité Hi-Fi pour les sons reproduits par cet appareil.
- Lors de la connexion d'un amplificateur extérieur à cet appareil, diminuez le réglage du gain sur l'amplificateur extérieur pour obtenir les meilleures performances de cet appareil.

Het is mogelijk om uw autostereosysteem uit te breiden met een versterker of andere apparatuur.

- Verbind de externe kabel (blauw met witte streep) met de externe kabel van het andere apparaat zodat deze op afstand vanaf deze apparaat kan worden bediend.
 - Alleen voor een versterker:
 - Verbind de uitgang van het apparaat met de ingang van de versterker.
 - Koppel de speakers van dit apparaat los en verbind ze aan de versterker.
 - Uitsluitend voor de KD-LX333R: Het uitgangsniveau van het geluid is hoog om het hi-fi-geluid van deze eenheid te behouden.
- Wanneer u een extern apparaat op deze eenheid aansluit, moet u erop letten dat u de versterkingsfactor van de externe versterker laag houdt, zodat deze eenheid de beste prestaties levert.

Signal cord (not supplied with this unit)
Einzelleitung (nicht mit diesem Gerät mitgeliefert)
Cordon de signal (non fourni avec cet appareil)
Signaalkabel (wordt niet bij dit apparaat geleverd)

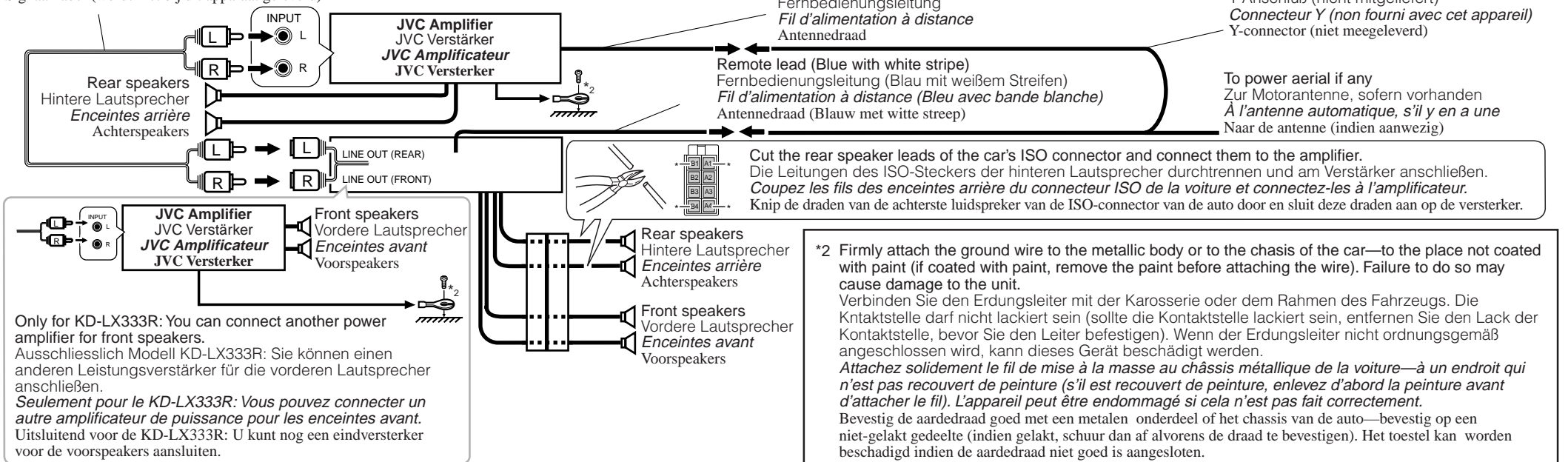

CD changer and DAB tuner / CD-Wechsler und DAB-Tuner / Changeur CD et tuner DAB / CD-wisselaar en DAB-tuner

You can connect a JVC CD changer and/or a JVC DAB (Digital Audio Broadcasting) tuner.

- For their connections, refer to the instructions supplied with them.
- Connecting cord supplied with your DAB tuner
Verbindungskabel, das zum Lieferumfang des DAB-Tuners gehört
Cordon de connexion fourni avec votre tuner DAB
Verbindungskabel die met de DAB-tuner wordt meegeleverd

Sie können einen CD-Wechsler und/oder einen DAB-Tuner (Tuner für digitalen Rundfunk) von JVC anschließen.

- Weitere Informationen über den Anschluß können Sie der Bedienungsanleitung entnehmen, die dem jeweiligen Gerät beiliegt.
- Connecting cord supplied with your CD changer
Verbindungskabel, das zum Lieferumfang des CD-Wechslers gehört
Cordon de connexion fourni avec votre changeur CD
Verbindungskabel die met de CD-wisselaar wordt meegeleverd

Vous pouvez connecter un changeur CD JVC et/ou un tuner DAB (Digital Audio Broadcast) JVC.

- Pour leurs connexions, référez-vous aux modes d'emploi qui les accompagnent.
- Connecting cord supplied with your DAB tuner or CD changer
Verbindungskabel, das zum Lieferumfang des DAB-Tuners oder CD-Wechslers gehört
Cordon de connexion fourni avec votre tuner DAB ou changeur CD
Verbindungskabel die met de DAB-tuner of CD-wisselaar wordt meegeleverd

Het is mogelijk een JVC CD-wisselaar en/of JVC DAB-tuner (Digital Audio Broadcasting) aan te sluiten.

- Zie de instructies van deze apparaten voor meer informatie over het tot stand brengen van deze aansluiting.

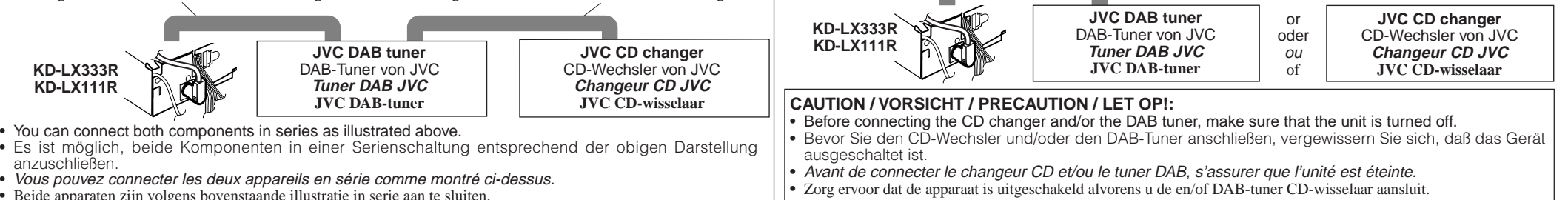

External component / Externe Komponente / Appareil extérieur / Extern apparaat

FOR KD-LX333R / FÜR DEN KD-LX333R / POUR LE KD-LX333R / VOOR KD-LX333R

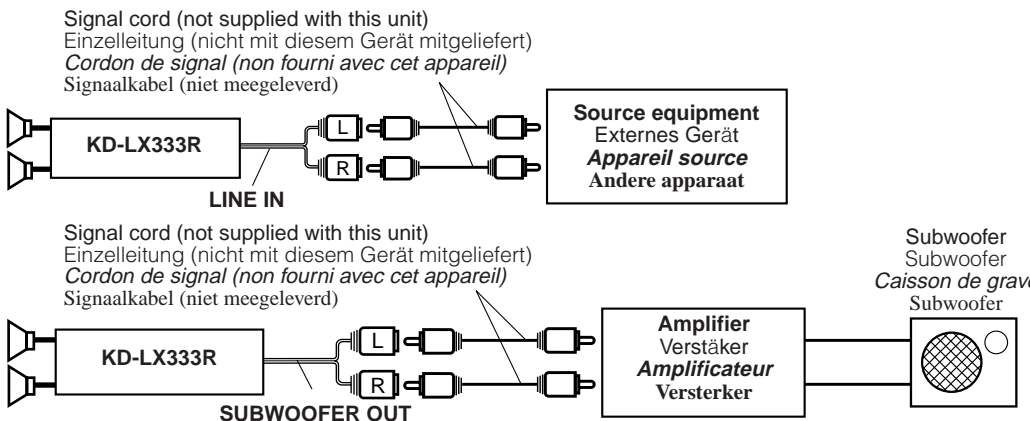

FOR KD-LX111R / FÜR DEN KD-LX111R / POUR LE KD-LX111R / VOOR KD-LX111R

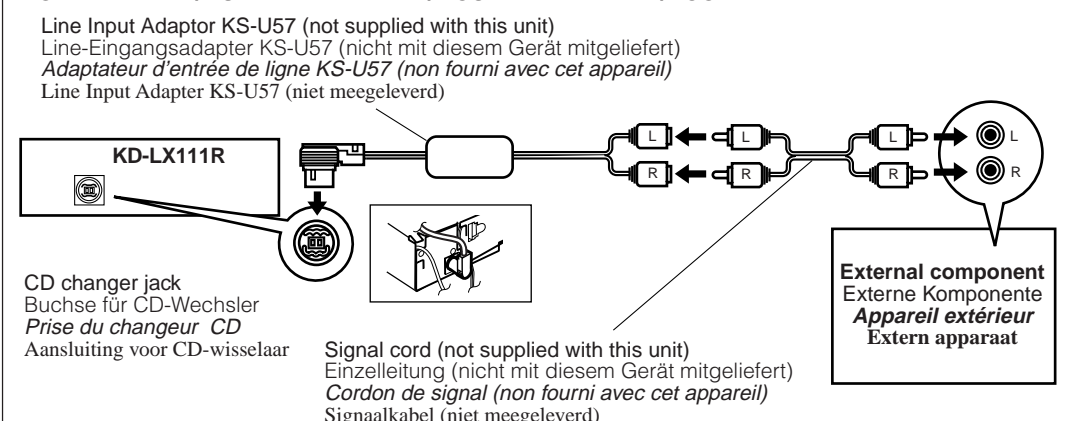

Free Manuals Download Website

<http://myh66.com>

<http://usermanuals.us>

<http://www.somanuals.com>

<http://www.4manuals.cc>

<http://www.manual-lib.com>

<http://www.404manual.com>

<http://www.luxmanual.com>

<http://aubethermostatmanual.com>

Golf course search by state

<http://golfingnear.com>

Email search by domain

<http://emailbydomain.com>

Auto manuals search

<http://auto.somanuals.com>

TV manuals search

<http://tv.somanuals.com>