



COLOUR TELEVISION

AV-1414EE **AV-2134EE**
AV-1434EE **AV-1434TEE**
AV-2104EE **AV-2104TEE**
AV-2114EE **AV-2134TEE**
AV-2124EE

INSTRUCTIONS

Thank you for purchasing this JVC colour television. To ensure your complete understanding, please read this manual thoroughly before operation.

WARNING:

TO PREVENT FIRE OR SHOCK HAZARD, DO NOT EXPOSE THIS APPLIANCE TO RAIN OR MOISTURE.

CAUTION:

- TO ENSURE PERSONAL SAFETY, OBSERVE THE FOLLOWING RULES REGARDING THE USE OF THIS TV.
- Operate only from the power source specified on the TV.
- Avoid damaging the power plug and power cord.
- Avoid improper installation and never position this TV where good ventilation is unattainable. When installing this TV distance recommendations must be maintained between the floor and wall, as well as installment in a tightly enclosed area or piece of furniture. Adhere to the minimum distance guidelines shown for safe operation.
- Do not allow objects or liquid into the cabinet openings.
- In the event of a fault, unplug this TV and call a service technician. Do not attempt to repair it by yourself or remove the rear cover.
- When you don't use this TV for a long period of time, be sure to disconnect the power plug from the AC outlet.

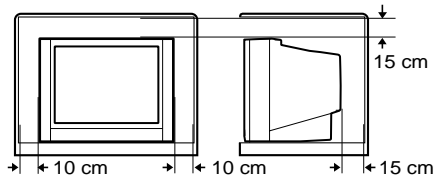

Contents

| | |
|--|----|
| Locations | 2 |
| Preparation | 4 |
| Basic operation | 10 |
| Remote control buttons and functions | 11 |
| Using the TV's menus | 14 |
| Using the button on the TV | 17 |
| Viewing a teletext programme | 19 |
| Troubleshooting | 21 |
| Specifications | 22 |

Locations

RM-C90

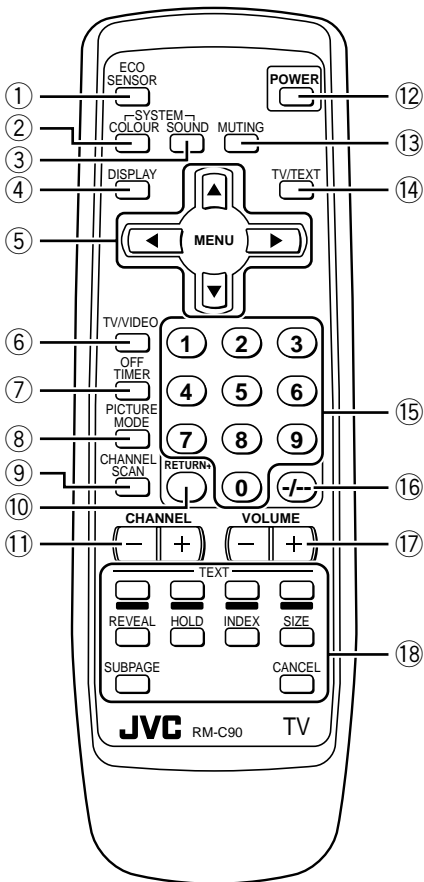

| | | |
|-----|----------------------|---------|
| ① | ECO SENSOR button | p.11 |
| ② | COLOUR SYSTEM button | p.11 |
| ③ | SOUND SYSTEM button | p.11 |
| ④ | DISPLAY button | p.12 |
| ⑤ | MENU buttons | |
| | • MENU ▲/▼ buttons | |
| | • MENU ◀/▶ buttons | |
| ⑥ | TV/VIDEO button | p.10 |
| ⑦ | OFF TIMER button | p.12 |
| ⑧ | PICTURE MODE button | p.12 |
| ⑨ | CHANNEL SCAN button | p.13 |
| ⑩ | RETURN + button | p.13 |
| ⑪ | CHANNEL +/- buttons | p.10 |
| ⑫ | POWER button | p.6,10 |
| ⑬ | MUTING button | p.11 |
| ⑭ ⑱ | Teletext buttons | p.19,20 |
| ⑮ | Number buttons | p.10 |
| ⑯ | -/-- button | p.10 |
| ⑰ | VOLUME +/- buttons | p.10 |

RM-C364GY

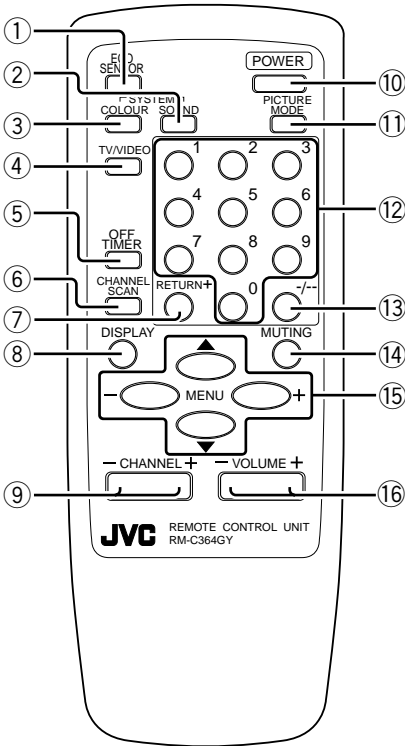

RM-C360GY

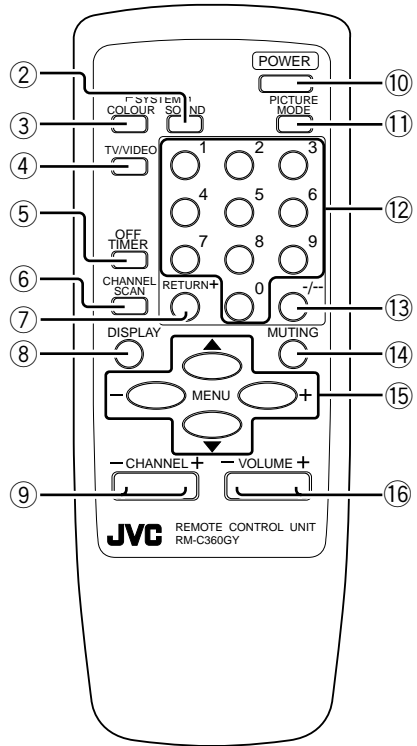

| | | |
|---|----------------------|------|
| ① | ECO SENSOR button | p.11 |
| ② | SOUND SYSTEM button | p.11 |
| ③ | COLOUR SYSTEM button | p.11 |
| ④ | TV/VIDEO button | p.10 |
| ⑤ | OFF TIMER button | p.12 |
| ⑥ | CHANNEL SCAN button | p.13 |
| ⑦ | RETURN + button | p.13 |
| ⑧ | DISPLAY button | p.12 |
| ⑨ | CHANNEL +/- buttons | p.10 |

| | | |
|---|---------------------|--------|
| ⑩ | POWER button | p.6,10 |
| ⑪ | PICTURE MODE button | p.12 |
| ⑫ | Number buttons | p.10 |
| ⑬ | -/-- button | p.10 |
| ⑭ | MUTING button | p.11 |
| ⑮ | MENU buttons | |
| | • MENU ▲/▼ buttons | |
| | • MENU +/- buttons | |
| ⑯ | VOLUME +/- buttons | p.10 |

Preparation

1. Connecting the aerial and external devices

Notes:

- For further details, refer to the manuals provided with the devices you are connecting.
- Connecting cables are not supplied.
- The front and rear AUDIO/VIDEO input jacks are directly connected so that input to either jack is output through both. You cannot provide input to both the front and rear jacks at the same time. Disconnect one input, or use one of the jacks as an output jack only (for monitoring or recording).
- The rod aerial is supplied with the AV-1434TEE/AV-1414EE/AV-1434EE.

■ Connecting the aerial and VCR

Connecting the aerial

To install rod aerial:

Install into the top-rear aerial holder. Once installed, it cannot be removed.

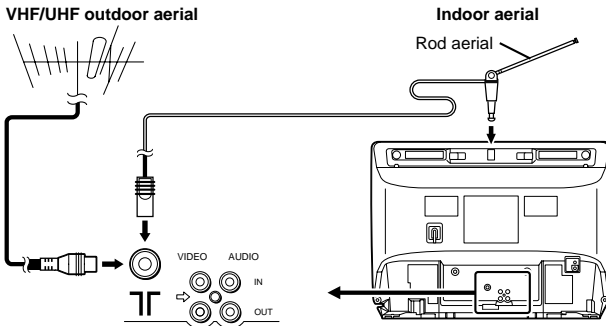

• Illustration of AV-1434EE.

Connecting the aerial and VCR

VHF/UHF outdoor aerial

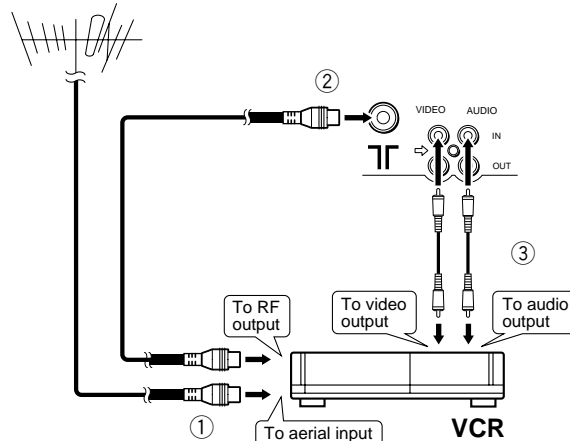

• Illustration of AV-1434EE.

■ Connecting other external devices

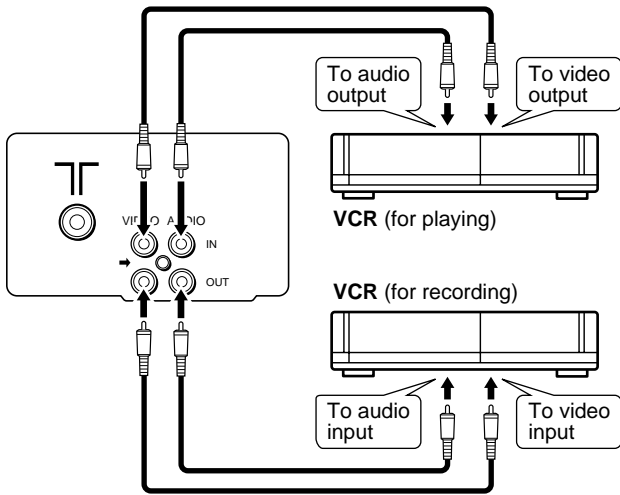

• Illustration of AV-2104EE.

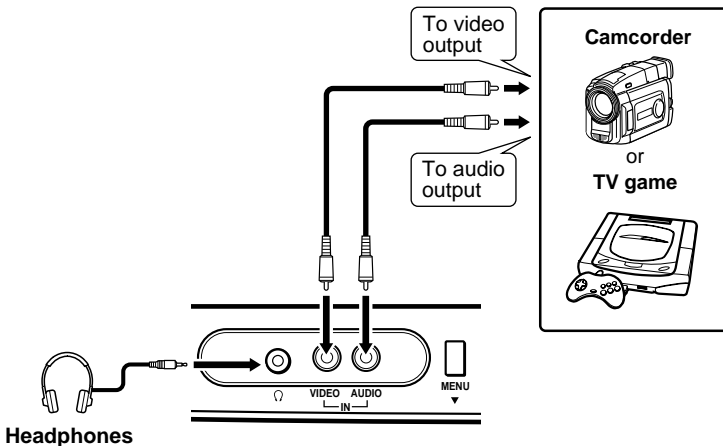

• Illustration of AV-2104EE.

Note:

- Use the headphones with a stereo mini jack (3.5 mm in diameter). When you connect the headphones, the TV speakers go off.

.....

Preparation

2. Connecting the power cord

Insert the Power plug into an AC outlet.

3. Inserting batteries into the remote control

Correctly insert two batteries, observing the ⊕ and ⊖ polarities and inserting the ⊖ end first.

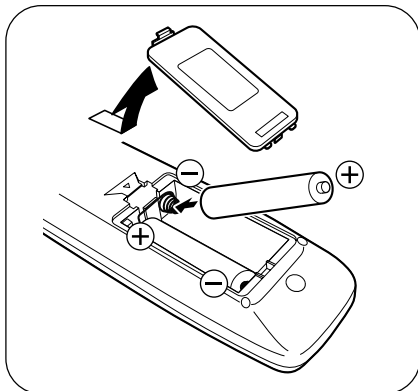

CAUTION:

- Follow the cautions printed on the batteries.

Notes:

- Use AA/R6/UM-3 dry cell batteries.
- If the remote control does not work properly, fit new batteries.
The supplied batteries are for testing, not regular use.

4. Turning your TV on

1. Press the Main power button on the TV to turn the TV's main power on.

The POWER lamp or POWER/ON TIMER lamp lights.

If image does not appear:

Your TV is in the standby mode. Press the POWER button on the remote control to turn your TV on.

- You can also turn on your TV by pressing the CHANNEL -/+ button on your TV.

To turn your TV off:

Press the POWER button on the remote control. Your TV enters the standby mode.

To turn the TV's main power off:

Press the Main power button on the TV.

5. Selecting the on-screen language

You can select the language for the on-screen display.

1. Press **MENU ▲/▼** to display the **MENU 3** menu, then select **LANGUAGE**.

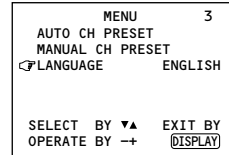

2. Press **MENU ◀/▶** or **-/+** to select language.

The on-screen displays indications are in the selected language.

6. Presetting TV stations

To view a TV programme, you must first preset TV channels to channels on the TV. This TV has 100 channels (channel 1 to 99 and channel AV).

■ Auto Channel Preset

You can automatically preset all TV channels that can be received by your TV to channels.

- The Auto Channel Preset function does not preset a TV channel to the AV channel (channel number 0).
- If the TV cannot preset the TV channel you want to view, preset it manually. For details see "Manual Channel Preset" on page 8.

1. Press **MENU ▲/▼** to display the **MENU 3** menu, then select **AUTO CH PRESET**.

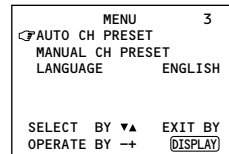

2. Press **MENU ◀/▶** or **-/+** to start the **Auto Channel Preset** function.

>>> **ON SEARCH** is displayed on the screen.

When you have finished presetting all TV channels that can be received on your TV, the display will go out and the Auto Channel Preset function will end.

- To stop the Auto Channel Preset, press the **MENU ◀/▶** or **-/+** button.

Preparation

Manual Channel Preset

You can manually preset the desired TV channels to the desired channels.

1. Press **MENU** ▲/▼ to display the **MENU 3** menu, then select **MANUAL CH PRESET**.

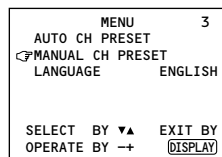

2. Press **MENU** ◀/▶ or **-/+**.

The sub-menu is displayed.

- The channel No. is displayed as a PR No.

3. Press **MENU** ◀/▶ or **-/+** to select the channel number.

Channel No.

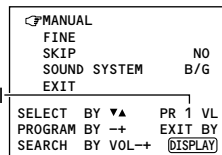

4. Press **VOLUME** **-/+** to start searching for the TV channel.

>>> or <<< is displayed on the screen.

When a TV channel is received, the >>> or <<< display goes out, and the TV station is preset to the currently selected channel No.

- If the TV channel you want to preset is not displayed, repeat step 4 until the TV finds the TV channel you want to preset.
- To stop the Manual Channel Preset function, press any button other than the **VOLUME** **-/+** button.

If the picture is not clear:

Use the Fine function to fine-tune the TV station.

1. Press **MENU** ▲/▼ to select **FINE**.
2. Hold **VOLUME** **-/+** down to fine-tune the TV station so that the best image is displayed on screen.
> or < indicates that the TV station is being fine-tuned.

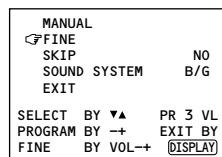

5. Press **MENU** ▲/▼ to select **SOUND SYSTEM**.

6. Press **VOLUME** **-/+** to select the appropriate sound system.

- For the sound systems in each country or region, refer to the table "Broadcasting systems" on page 22.

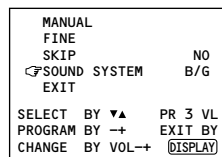

7. Press **MENU** ▲/▼ to select **MANUAL**.

8. Repeat steps 3 to 7 if you want to preset another TV station to a channel.

- 8 9. Press **DISPLAY** to turn the display off.

■ Skip

You can set undesired channels to be skipped.

Channels set to be skipped cannot be selected by the CHANNEL $-/+$ buttons nor the CHANNEL SCAN button.

- Channels to which a station has not been preset are automatically set to be skipped.

1. Press MENU $\blacktriangle/\blacktriangledown$ to select **MANUAL CH PRESET.**

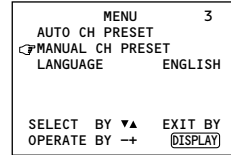

2. Press MENU $\blacktriangle/\blacktriangledown$ or $-/+$.

The sub-menu is displayed.

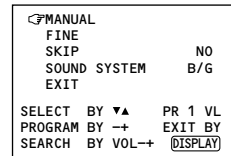

3. Press MENU $\blacktriangle/\blacktriangledown$ to select **SKIP.**

- The channel No. is displayed as a PR No.

Channel
No.

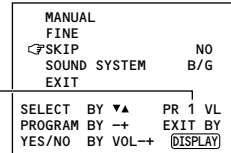

4. Press MENU $\blacktriangle/\blacktriangledown$ or $-/+$ to select the channel you want to skip.

5. Press VOLUME $-/+$ to select **YES.**

The channel you selected is set to be skipped.

To cancel the Skip:

select **NO.**

6. Repeat steps 4 and 5 if you want to set another channel to skip.

7. Press DISPLAY to turn the display off.

Basic operation

- The illustration below is for the remote control RM-C90 supplied with TEE series models.

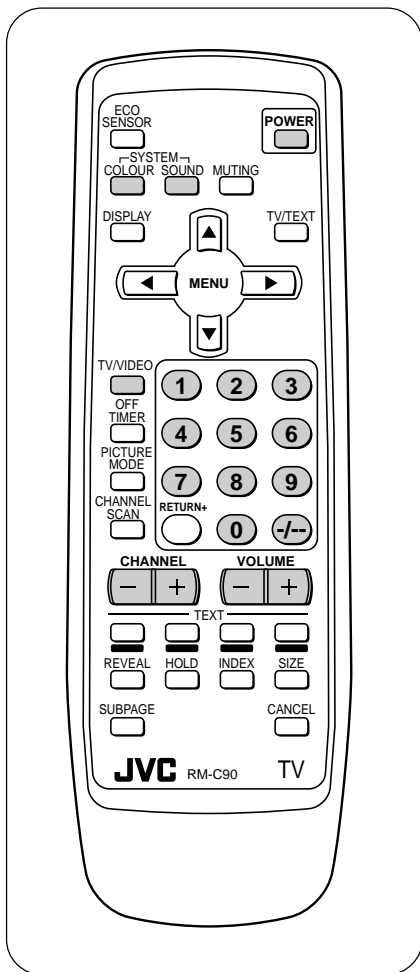

1. Press the POWER button to turn your TV on.

- If your TV does not turn on, press the Main power button on the TV then press the POWER button again.
- You can also turn on your TV by pressing any of the following buttons;
 - the CHANNEL $-/+$ button
 - the Number buttons
 - the TV/VIDEO button

2. Select a channel.

■ Press the CHANNEL $-/+$ button.

- Up/down selection cannot be selected for channels to which the Skip has been set to **YES**. (See page 9.)

■ Press the Number buttons to enter the channel number.

- If you want to enter a two-digit number, press the $-/--$ button to select the two digit mode " $--$ ", then enter the channel number.

If the colour is abnormal:

Repeatedly press the COLOUR SYSTEM button to select the appropriate colour system. For details, see "Colour System" on page 11.

3. Press VOLUME $-/+$ to adjust the sound.

If the sound is abnormal:

Repeatedly press the SOUND SYSTEM button to select the appropriate sound system. For details, see "Sound System" on page 11.

4. To turn your TV off, press POWER.

- We recommend that you press the Main power button on the TV to turn the main power off if you do not plan to use your TV for a long time or if you wish to save energy.

Viewing Images from an External Device:

Press the TV/VIDEO button to select the VIDEO mode.

- You can also use the Input function to select the VIDEO mode. For details, refer to page 14.

Remote control buttons and functions

Eco Sensor

<AV-1414EE does not have this function.>

You can adjust this TV so that the screen automatically adjusts to the optimum contrast according to the brightness of your room. This function reduces eye strain and the power consumption of this TV.

Repeatedly press the ECO SENSOR button to select the desired mode.

- AV-2104TEE/AV-2104EE does not display "DIGITAL".

DIGITAL ECO SENSOR DISPLAY:

The Eco Sensor function will work. In this mode, the mark indicating the brightness of your room is displayed for several seconds each time the brightness changes. The number of marks displayed on screen increases as your room becomes darker.

DIGITAL ECO SENSOR:

The Eco Sensor function will work. However, in this mode, the mark will not be displayed even if the brightness of your room changes.

DIGITAL ECO SENSOR OFF:

The Eco Sensor function will not work.

Sound System

If the sound is abnormal, select the appropriate sound system. Each press of the SOUND SYSTEM button changes the sound system as follows.

→ B/G → I → D/K →

- For the sound systems in each country or region, see the table "Broadcasting Systems" on page 22.
- You cannot select any sound system when in VIDEO mode.

Colour System

If the colour is abnormal, select the appropriate colour system. Each press of the COLOUR SYSTEM button changes the colour system as follows.

In TV mode (channel 1 to 99 and AV):

→ AUTO → PAL → SECAM →

In VIDEO mode:

→ AUTO → PAL → SECAM →
← NTSC4.43 ← NTSC3.58 ←

AUTO:

Automatic colour system selection.

- For the colour systems in each country or region, see the table "Broadcasting Systems" on page 22.
- If the colour is abnormal even though you selected **AUTO**, change the appropriate colour system manually.

Muting

You can turn the volume off instantly. This is convenient when answering the phone or when you have visitors. Press the MUTING button. To return the sound, press the MUTING button again.

Display

You can continuously display the current channel number or VIDEO mode on the screen.

Press the DISPLAY button.

To turn the display off, press the DISPLAY button again.

- When selecting a channel or VIDEO mode with no input signal, indication of selected channel or VIDEO mode becomes fixed on the screen.

Off Timer

You can set this TV to turn off automatically within a specified period of time.

Repeatedly press the OFF TIMER button to select the period of time.

- You can set the period of time a maximum of 120 minutes in 10 minute increments.
- 1 minute before the Off Timer turns off the TV, **GOOD NIGHT!** displays.

To display the remaining time:

Press the OFF TIMER button once.

To cancel the Off Timer:

Press the OFF TIMER button to return the period of time to 0.

- The Off Timer will not turn off the TV's main power.

Picture Mode

You can select one of three picture adjustment modes.

Repeatedly press the PICTURE MODE button to select the desired mode.

BRIGHT:

Heightens contrast and sharpness.

STANDARD:

Standardizes picture adjustments.

SOFT:

Softens contrast and sharpness.

- Pressing the PICTURE MODE button returns all the picture settings in the **MENU 4** menu to their default settings.

Channel Scan

You can search for the channel you want to view while scanning all of the channels that can be viewed on this TV.

1. Press CHANNEL SCAN.

Channels will be scanned in channel No. order.

2. When the channel that you want to view appears, press CHANNEL SCAN again before scanning for the next channel begins.

- Channel Scan selection cannot be selected for channels to which the Skip has been set to **YES**. (See page 9.)

Return +

You can set a channel you frequently view to the Return Channel and you can view that channel at any time with one-touch.

To set the channel to the Return Channel:

- 1. Select the channel you want to set to the Return Channel.**
- 2. Press RETURN + and hold until the message RETURN PLUS PROGRAMMED! appears.**

- When you turn off the TV, the Return Channel setting is cancelled.

To view the Return Channel:

Press the RETURN + button.

- You can view two channels (current channel and Return Channel) alternately by pressing this button.

To cancel the Return Channel setting:

Press the RETURN + button and hold until the message RETURN PLUS CANCELLED! appears.

If no channel is set to the Return Channel:

You can view the channel selected right before the current channel by pressing this button.

Using the TV's menus

On Timer

Your TV will automatically turn on and tune into the channel you set after the period of time you set.

1. Press **MENU ▲/▼** to display the **MENU 1** menu, then select **ON TIMER**.

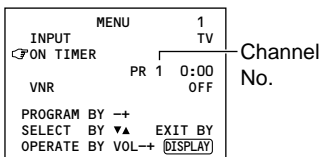

2. Press **MENU ◀/▶** or **-/+** to select a channel you want to view when the TV turns on.
3. Press **VOLUME -/+** to select the period of time after which you want to turn on the TV.

The On Timer function starts.

- Each time you press the button, the period of time changes in 15 minute intervals (up to 12 hours).

To cancel the On Timer function, press the **VOLUME -/+** button to set the period of time to **0:00**.

4. Press **DISPLAY** to turn the display off.

- If you turn off the TV's main power by pressing the Main power button, the On Timer function is canceled.
- If you do not turn off the TV after starting the On Timer function, the channel will automatically switch to the channel set for the On Timer function.

When the time set for the On Timer function is reached:

The TV automatically turns on and the channel set for the On Timer function is displayed.

- For safety reasons the TV will automatically turn off if no operations are made within approximately two hours after the TV is turned on with the On Timer function.
- The Off Timer function and Auto Shutoff function have priority over the On Timer function.

Input

You can view images from VCRs or other devices connected to your TV.

1. Press **MENU ▲/▼** to display the **MENU 1** menu, then select **INPUT**.

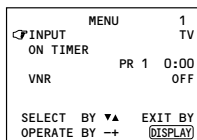

2. Press **MENU ◀/▶** or **-/+** to select the **VIDEO** mode. TV mode changes to VIDEO mode.

VNR (Video Noise Reduction)

You can reduce the picture noise.

1. Press **MENU** ▲/▼ to display the **MENU 1** menu, then select **VNR**.

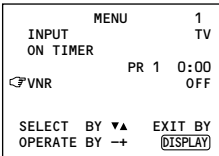

2. Press **MENU** ◀/▶ or **-/+** to select **ON**.
To cancel the VNR function, select **OFF**.
3. Press **DISPLAY** to turn the display off.

Child Lock

You can disable the front control buttons of the TV.

When this function is set to **ON**, the TV can be operated using only the remote control.

Use this function to prevent children from operating the TV at their own discretion (without parental consent).

1. Press **MENU** ▲/▼ to display the **MENU 2** menu, then select **CHILD LOCK**.

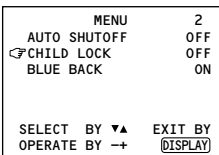

2. Press **MENU** ◀/▶ or **-/+** to select **ON**.
To cancel the Child Lock function, select **OFF**.
3. Press **DISPLAY** to turn the display off.
 - The Child Lock function is canceled when you turn the TV's main power off.

Auto Shutoff

You can set your TV to turn off if no signals are received for about 15 minutes or longer after the end of a broadcast.

1. Press **MENU** ▲/▼ to display the **MENU 2** menu, then select **AUTO SHUTOFF**.

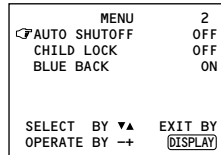

2. Press **MENU** ◀/▶ or **-/+** to select **ON**.
To cancel the Auto Shutoff function, select **OFF**.
3. Press **DISPLAY** to turn the display off.
 - The Auto Shutoff function does not turn off the TV's main power.
 - The Auto Shutoff function will not work for a VIDEO mode.

Blue Back

You can mute the sound and change the picture into a blue screen while no signals are received by the TV, or when the signals are unstable.

1. Press **MENU ▲/▼** to display the **MENU 2** menu, then select **BLUE BACK**.

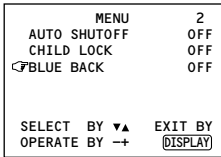

2. Press **MENU ◀/▶** or **-/+** to select **ON**.

To cancel the Blue Back function, select **OFF**.

- To view a broadcast even when the reception signal is poor, set the Blue Back function to **OFF**.
- Even when the Blue Back function is set to **OFF**, the sound may not be audible.

3. Press **DISPLAY** to turn the display off.

Picture Adjustment

You can adjust the picture as you like.

1. Press **MENU ▲/▼** repeatedly to display the **MENU 4**.

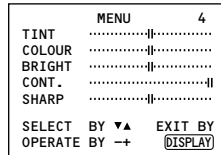

2. Press **MENU ▲/▼** to select an item and press **MENU ◀/▶** or **-/+** to adjust it.

| ◀ | Item | ▶ |
|---------|--------|----------|
| Reddish | TINT | Greenish |
| Lighter | COLOUR | Deeper |
| Darker | BRIGHT | Brighter |
| Lower | CONT. | Higher |
| Softer | SHARP | Sharper |

- **TINT** (tint) is displayed only when viewing images from NTSC3.58 or NTSC4.43 colour systems.

3. Press **DISPLAY** to turn the display off.

Using the button on the TV

<AV-2104TEE/AV-2134TEE/AV-2104EEE/AV-2134EE>

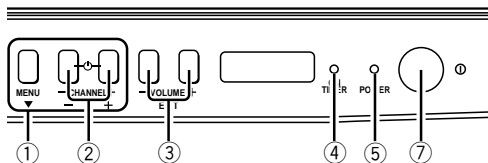

- ① MENU buttons
 - MENU ▼ button
 - MENU -/+ buttons
- ② CHANNEL -/+ buttons
- ③ VOLUME -/+ buttons
- ④ ON TIMER lamp

<AV-2114EE>

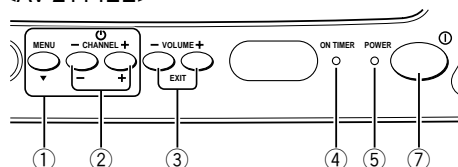

- ④ ON TIMER lamp
The light is switched on while On Timer function is operating.
- ⑤ POWER lamp
When the Main power is on, the light is red.

<AV-2124EE>

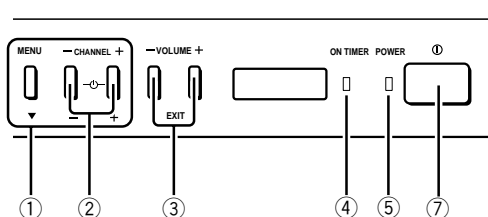

- ⑥ POWER/ON TIMER lamp
When the Main power is on, the light is green.
When On Timer function is on, it is red.
- ⑦ Main power button

<AV-1434TEE/AV-1434EE>

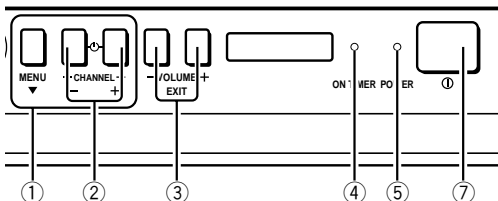

<AV-1414EE>

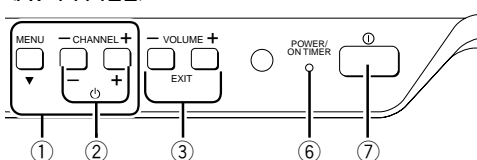

Basic operation

- Check to make sure the Child Lock function is set to **OFF**. When the Child Lock function is set to **ON**, the TV cannot be operated using the front control buttons. For details, see "Child Lock" on page 15.

1. Press **CHANNEL -/+** to turn the TV on from standby mode.
2. Press **CHANNEL -/+** to select a channel.
3. Press **VOLUME -/+** to adjust the volume.
4. To turn your TV off, press the **Main power** button to turn off the TV's main power.

Operating menus

You can operate functions in menus using the front control buttons on the TV.

1. Press **MENU ▼** repeatedly to display the menu you want to use.
2. Press **MENU ▼** to select the desired function or item.
3. Press **MENU -/+** or **VOLUME -/+** to carry out the desired operation.
 - For details, see the description for each function.
4. Press **VOLUME -/+** to turn the menu display off.

To turn the sub-menu display off:

1. Press **MENU ▼** to select **EXIT**.

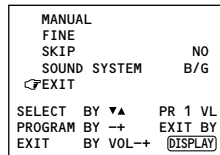

2. Press **VOLUME -/+** to turn the display off.

Viewing a teletext programme

<AV-1434TEE/AV-2104TEE/AV-2134TEE only.>

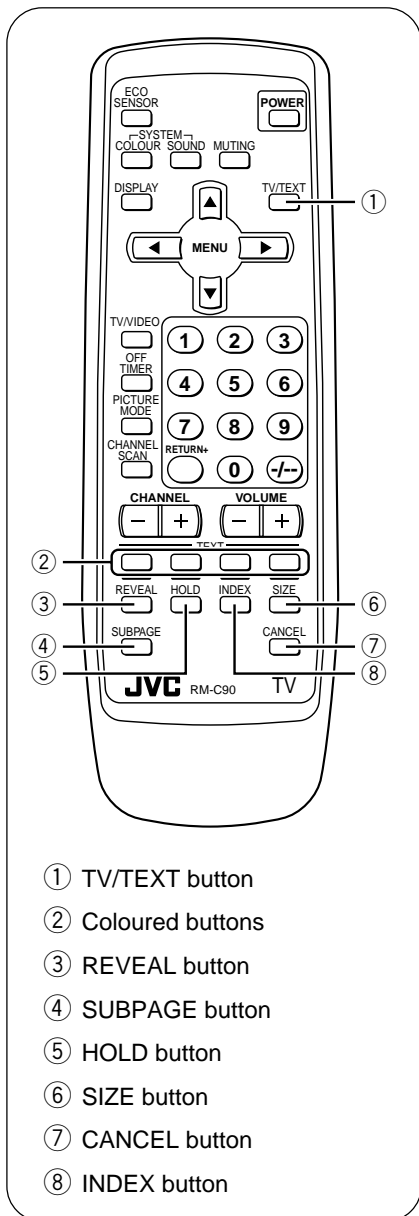

Basic operation

1. Select a TV channel with a teletext programme.
2. Press TV/TEXT to change the TV mode to the teletext mode.

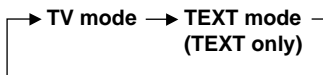

3. Select a teletext page by pressing the CHANNEL -/+ button, number button or coloured buttons.

To return to the TV mode, press the TV/VIDEO button or the TV/TEXT button.

- If you have trouble receiving teletext broadcasts, consult your local dealer or the teletext station.

Viewing a teletext programme

Display cancel

You can view a normal TV programme while scanning for a teletext page you wish to view.

- 1. Select the page you want to view.**
Scanning starts.
- 2. Press CANCEL.**
The TV programme appears.
- 3. Press TV/TEXT when the page number you wish to view appears in the upper left of the screen.**

Page hold

You can hold a page temporarily even as the teletext transmission continues. To do this, press the HOLD button. Pressing the HOLD or INDEX button, or selecting another teletext page will release the hold mode.

Hidden information reveal

Some teletext pages contain hidden information such as answers to questions. You can reveal the hidden information with this function. To alternate reveal and hide, press the REVEAL button.

Index return

You can easily return to the index page by pressing INDEX.

- Fasttext/WST:** Returns to teletext page 100 or a page which has been specified.
- LIST mode:** Returns to the page number displayed in red in the lower left area of the screen.

Sub page display

Some teletext pages have sub-pages, which scroll automatically. You can store those pages in memory and view them again later on.

- 1. Select a teletext page with sub-pages.**
- 2. Press SUBPAGE.**
The input position appears at the bottom left of the screen.
- 3. Enter the sub-page number using the number buttons.**

Example:

To select the third page, press 0, 0, 0, 3.

- You can also select a sub-page number by pressing the red or green colour button.

Display size

You can double the height of the teletext display. To do this, press the SIZE button repeatedly. The teletext display changes cyclically.

Troubleshooting

Important: Review all the instructions in this manual.

| Problem | Check/Action |
|--|--|
| Cannot turn TV on | Press the Main power button (see p.6). Insert the power plug in an AC outlet. |
| No picture nor sound | Press the TV/VIDEO button to select the correct mode (see p.10). Check the aerial connections. |
| Remote control inoperable | Replace the batteries (see p.6). Insert the batteries correctly. |
| Buttons on front of TV do not work | Is the Child Lock function ON ? (see p.15). |
| The TV turns on suddenly | The TV will automatically turn on when the On Timer is operated (see p.14). |
| The TV turns off suddenly | The TV will automatically turn off in the following cases. <ul style="list-style-type: none">• When the Off Timer or Auto Shutoff is operated (see p.12 and p.15).• When no operations are made within approximately two hours after the TV was turned on with the On Timer (see p.14). |
| Abnormal sound | Select the appropriate sound system (see p.11). |
| Abnormal colour | Adjust the colour and brightness (see p.16). Select the appropriate colour system (see p.11). Set the Picture mode to STANDARD (see p.12). |
| Lines or streaks in picture (interference) | Move the components apart until the interference disappears. Reposition the aerial. |
| Spotted picture (crosstalk) | Move the aerial away from the source of interference. Replace the aerial cable with a coaxial cable, which is less prone to interference. |
| Double picture (ghost) | Reposition the aerial. Replace with an aerial with good directionality. |
| Snowy picture (image noise) | Check the aerial connection and aim it correctly. Replace or repair the aerial. |
| The TV channel changes suddenly | The channel will automatically be changed when the On Timer operates (see p.14). |
| The screen turns blue | Is the Blue Back set to ON ? (see p.16). |
| No receivable teletext programme | Select a channel with teletext information. You cannot watch teletext recorded on a video tape. |

The following are normal occurrences and are not the result of TV malfunctions:

- When a still bright image (of a white dress, for example) appears on the screen, the image may be coloured. This problem occurs in all CRTs, and when the bright image disappears, the colouration also disappears.
- This TV is equipped with a microcomputer that may operate abnormally due to interference from external devices. If this happens, press the Main power button to turn the main power off and disconnect the power plug from the AC outlet. Then, reconnect the power plug to the AC outlet and press the Main power button again.

Specifications

| | |
|--------------------------------|--|
| TV RF systems | B, G, I, D, K, K1 |
| Colour systems | PAL, SECAM, NTSC 3.58 / 4.43 MHz (in VIDEO mode only) |
| Channel and frequencies | VHF low channel (VL) = 46.25 to 168.25 MHz VHF high channel (VH) = 175.25 to 463.25 MHz UHF channel (U) = 471.25 to 863.25 MHz ■ Receives cable channels in mid band (X to Z, S1 to S10), super band (S11 to S20) and hyper band (S21 to S41) . |
| Teletext system | Fastext (United Kingdom system), WST (Standard system) |
| Language displayed by teletext | English, Estonian, Lithuanian, Russian, Czechoslovakian, Ukrainian, Latvian, Romanian, Hungarian |
| External input / output | VIDEO input (RCA) AUDIO input (RCA) |
| | VIDEO output (RCA) AUDIO output (RCA) |
| | Headphone jack: mini jack (dia. 3.5 mm) |

Design and specifications subject to change without notice.

Broadcasting Systems

| Area | Country or Region | System | |
|-------------------------|--|--------|-------|
| | | Colour | Sound |
| Asia, Middle East | Bahrain, Kuwait, Oman, Qatar, United Arab Emirates, Yemen, etc. Indonesia, Malaysia, Singapore, Thailand, India, etc. | PAL | B/G |
| | China, Vietnam, etc. | PAL | D/K |
| | Hong Kong, etc. | PAL | I |
| | Islamic Republic of Iran, Lebanon, Saudi Arabia, etc. | SECAM | B/G |
| | Russia, etc. | SECAM | D/K |
| Europe | Czech Republic, Poland, etc. | PAL | D/K |
| | Germany, Holland, Belgium, etc. | PAL | B/G |
| | UK, etc. | PAL | I |
| | Australia, New Zealand, etc. | PAL | B/G |
| Africa | Republic of South Africa, etc. | PAL | I |
| | Nigeria, etc. | PAL | B/G |
| | Egypt, Morocco, etc. | SECAM | B/G |

Free Manuals Download Website

<http://myh66.com>

<http://usermanuals.us>

<http://www.somanuals.com>

<http://www.4manuals.cc>

<http://www.manual-lib.com>

<http://www.404manual.com>

<http://www.luxmanual.com>

<http://aubethermostatmanual.com>

Golf course search by state

<http://golfingnear.com>

Email search by domain

<http://emailbydomain.com>

Auto manuals search

<http://auto.somanuals.com>

TV manuals search

<http://tv.somanuals.com>