

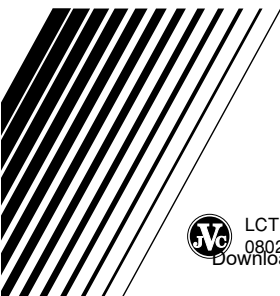

COLOUR TELEVISION
INSTRUCTIONS

Thank you for buying this JVC colour television.
To make sure you understand how to use your new TV, please read this manual thoroughly before you begin.

AV-14F43
AV-20N43
AV-21D43



| Contents | |
|--|-----------|
| Safety precautions | 2 |
| Preparation | 3 |
| 1 Confirm which remote control you have | 3 |
| 2 Inserting the batteries | 3 |
| 3 Connecting the aerial and external devices ... | 4 |
| 4 Connecting the power cord | 6 |
| 5 SETUP TOUR | 6 |
| Basic operation | 7 |
| Remote control buttons and functions | 8 |
| ECO SENSOR button | 8 |
| PICTURE MODE button | 8 |
| COLOUR SYSTEM button | 8 |
| SOUND SYSTEM button | 8 |
| DISPLAY button | 9 |
| RETURN + button | 9 |
| CHANNEL SCAN button | 9 |
| MUTING button | 9 |
| OFF TIMER button | 9 |
| I/II button | 10 |
| PICTURE BOOSTER button | 10 |
| Using the TV's menus | 11 |
| Basic operation | 11 |
| ON TIMER | 12 |
| INPUT | 12 |
| AUTO SHUTOFF | 13 |
| CHILD LOCK | 13 |
| BLUE BACK | 13 |
| AI ECO DISPLAY | 13 |
| SETUP TOUR | 14 |
| LANGUAGE | 14 |
| AUTO CH PRESET | 14 |
| MANUAL CH PRESET | 15 |
| SKIP | 16 |
| Picture Adjustments | 16 |
| Using the buttons on the TV | 17 |
| Troubleshooting | 19 |
| Specifications | 20 |



Safety precautions

WARNING

- To prevent fire or shock hazard, do not expose the TV to rain or moisture.

CAUTION

- Operate only from the power source indicated on the rear of the TV.
- Avoid damaging the power cord and mains plug. When you unplug the TV, pull it out by the mains plug. Do not pull on the power cord.
- Never block or cover the cabinet openings for ventilation. Never install the TV where good ventilation is unattainable. When installing this TV, leave spaces for ventilation around the TV more than the minimum distances shown in the diagram.
- Do not allow objects or liquid into the cabinet openings.
- In the event of a fault, unplug the TV and call a service technician. Do not attempt to repair it by yourself or remove the rear cover.
- The surface of the TV screen is easily damaged. Be very careful with it when handling the TV. Should the TV screen become soiled, wipe it with a soft dry cloth. Never rub it forcefully. Never use any cleaner or detergent on it.
- When you don't use this TV for a long period of time, be sure to unplug it.

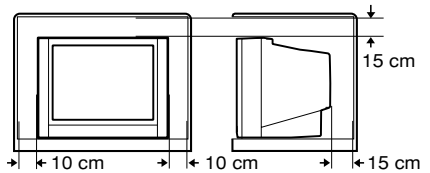

Preparation

1 Confirm which remote control you have

Your TV comes with one of the three remote controls shown below. Functions you can operate differ depending on the type of remote control.

RM-C368GY

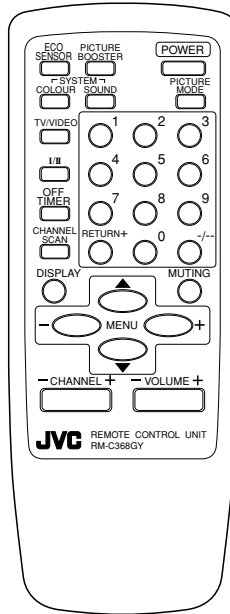

2 Inserting the batteries

Correctly insert two batteries, observing the ⊕ and ⊖ polarities and inserting the ⊖ end first.

CAUTION:

Follow the cautions printed on the batteries.

Notes:

- Use AA/R6/UM-3 dry cell batteries.
- If the remote control does not work properly, fit new batteries.
The supplied batteries are for testing, not regular use.

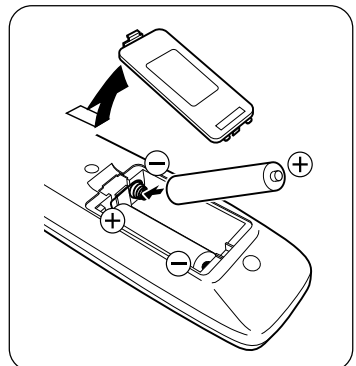

Preparation

3 Connecting the aerial and external devices

- For further details, refer to the manuals provided with the devices you are connecting.
- Connecting cables are not supplied.
- The front and rear AUDIO/VIDEO input jacks are directly connected so that input to either jack is output through both. You cannot provide input to both the front and rear jacks at the same time. Disconnect one input, or use one of the jacks as an output jack only (for monitoring or recording).
- The rod aerial is supplied with the AV-14F43.

■ Connecting the aerial and VCR

Connecting the aerial

To install rod aerial:

Install into the top-rear aerial holder. Once installed, it cannot be removed.

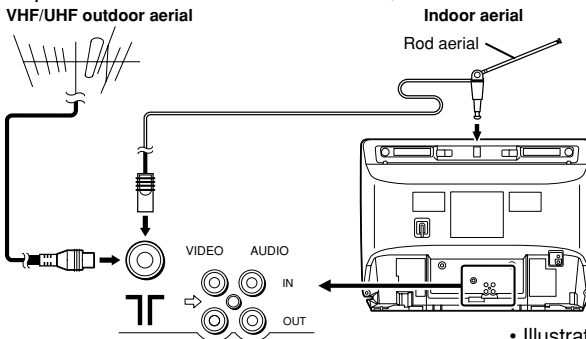

• Illustration of AV-14F43.

Connecting the aerial and VCR

VHF/UHF outdoor aerial

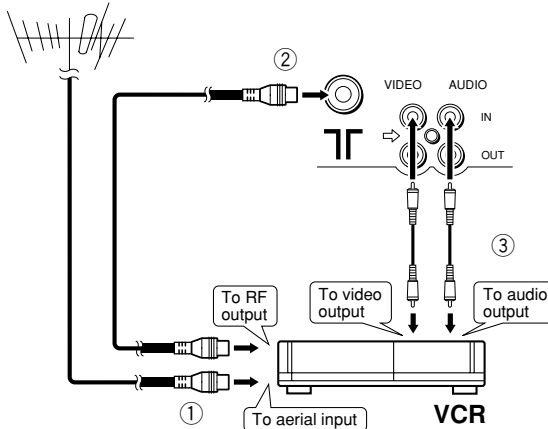

• Illustration of AV-14F43.

Preparation

■ Connecting other external devices

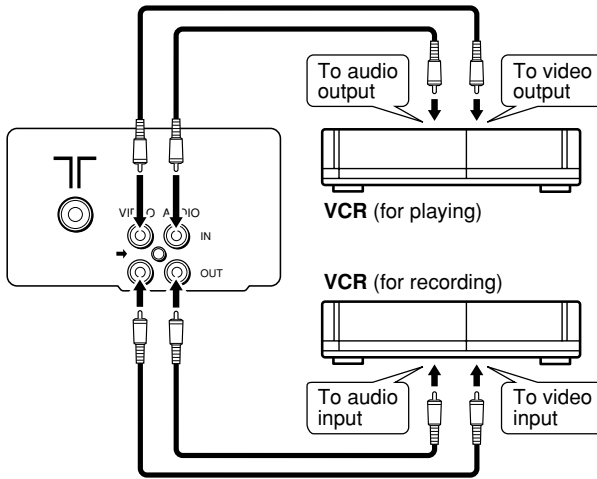

- Illustration of AV-21D43.

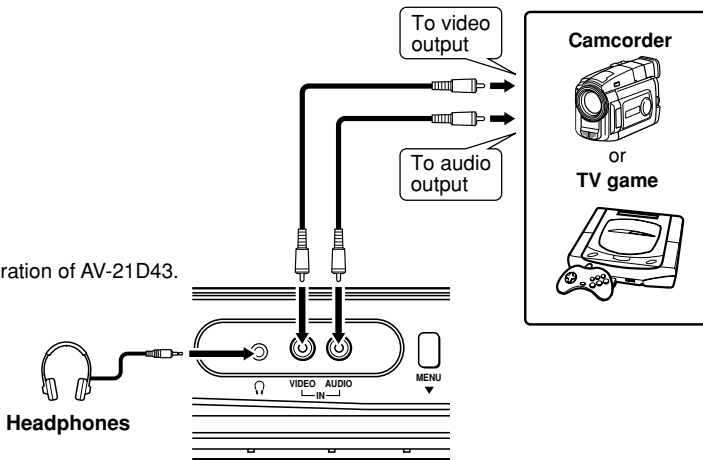

- Illustration of AV-21D43.

- Use the headphones with a stereo mini jack (3.5 mm in diameter). When you connect the headphones, the TV speakers go off.

Preparation

4 Connecting the power cord

Connect the power cord to the AC outlet.

Operate only from the power source indicated on the rear of the TV.

5 SETUP TOUR

When the TV is first turned on it enters the SETUP TOUR mode, and the JVC logo is displayed. Follow the instructions on the on-screen display to perform the SETUP TOUR.

- In case of resetting that the reason for such as removal, you can set the SETUP TOUR function on the "MENU 3" menu. For details, see page 14.

1 Press the Main power button on the TV.

The POWER lamp or POWER/ON TIMER lamp lights. After the JVC logo has been displayed, the TV automatically switches to the language setting mode.

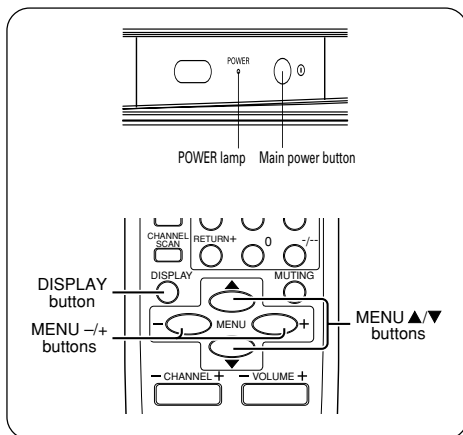
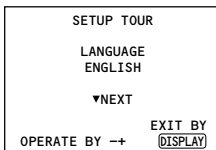

2 Press the MENU -/+ buttons to select the on-screen language.

3 Press the MENU ▼ button.

The AUTO PROGRAMMING function will start and the indicator blinks.



- To stop the AUTO PROGRAMMING function, press the MENU -/+ buttons.

When all the TV channels that can be received on your TV have been preset, the display goes out and the AUTO PROGRAMMING function operation is completed.

- If a TV channel you want to view is not set to the channel, set it with the MANUAL CH PRESET function. For details, see page 15.

Basic operation

- The illustration below is for the remote control RM-C368GY. Your remote control may not look exactly like the illustrations.

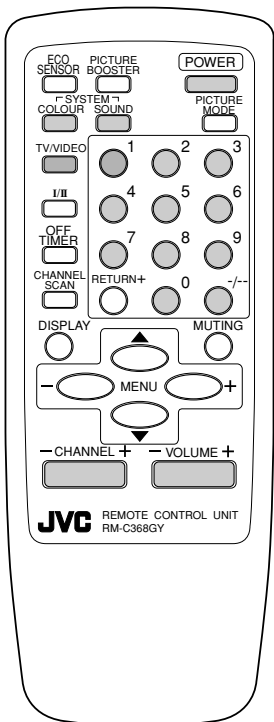

1 Press the POWER button to turn your TV on.

- If your TV does not turn on, press the Main power button on the TV then press the POWER button again.
- You can also turn on your TV by pressing any of the following buttons;
 - the CHANNEL +/- button
 - the Number buttons
 - the TV/VIDEO button

2 Select a channel.

- Press the CHANNEL +/- button.
 - Up/down selection cannot be selected for channels to which the SKIP has been set to "YES". See page 16.
- Press the Number buttons to enter the channel number.
 - If you want to enter a two-digit number, press the -/-- button to select the two digit mode "--", then enter the channel number.

3 Press the VOLUME +/- button to adjust the sound.

4 To turn your TV off, press the POWER button.

- We recommend that you press the Main power button on the TV to turn the main power off if you do not plan to use your TV for a long time or if you wish to save energy.

If the picture is not clear:

Press the COLOUR SYSTEM button to select another colour system, see page 8.

If the sound is not clear:

Press the SOUND SYSTEM button to select another sound system, see page 8.

Viewing Images from an External Device:

Press the TV/VIDEO button to select the VIDEO mode.

- You can also use the INPUT function to select the VIDEO mode. For details, refer to page 12.

Remote control buttons and functions

ECO SENSOR button

You can adjust this TV so that the screen automatically adjusts to the optimum contrast according to the brightness of your room. This function reduces eye strain and the power consumption of this TV.

Press this button to select the desired mode.

AI ECO SENSOR 1:

The AI ECO SENSOR function switches on.

Usually, it is recommended to watch the TV in this mode.

AI ECO SENSOR 2:

The AI ECO SENSOR function switches on.

If you feel the screen in the “AI ECO SENSOR 1” mode is too dark, select this mode.

AI ECO SENSOR OFF:

The AI ECO SENSOR function switches off.

- You can display on the screen the effect of the AI ECO SENSOR function.
For details, see “AI ECO DISPLAY” on page 13.

PICTURE MODE button

You can select one of three picture adjustment settings as you like.

Press this button to select a mode.

BRIGHT:

Heightens contrast and sharpness.

STANDARD:

Standardizes picture adjustments.

SOFT:

Softens contrast and sharpness.

- Pressing this button returns all the picture settings in the “MENU 4” to their default settings.

COLOUR SYSTEM button

If the picture is not clear or no colour appears, change the current colour system to another colour system.

Press this button to select the colour system.

In TV mode (channel 1 to 99 and AV):



In VIDEO mode:

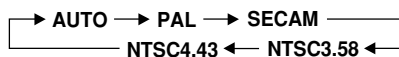

AUTO:

Automatic colour system selection.

- For the colour systems in each country or region, see the table “Broadcasting systems” on page 20.
- If the picture is not normal in the AUTO mode, change the AUTO mode to another colour system.

SOUND SYSTEM button

If the sound is not clear even when the picture appears normal, change the current sound system to another sound system.

Press this button to select the sound system.

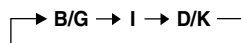

- For the sound systems in each country or region, see the table “Broadcasting systems” on page 20.
- You cannot select any sound system when in a VIDEO mode.

Remote control buttons and functions

DISPLAY button

You can continuously display the current channel number or VIDEO mode on the screen.

Press this button.

To turn the display off, press this button again.

- When selecting a channel or VIDEO mode with no input signal, indication of selected channel or VIDEO mode becomes fixed on the screen.

RETURN + button

You can set a channel you frequently view to the Return Channel and you can view that channel at any time with one-touch.

To set the channel to the Return Channel:

- 1 Select the channel you want to set to the Return Channel.**
- 2 Press this button and hold until the message "RETURN PLUS PROGRAMMED!" appears.**

- When you turn off the TV, the Return Channel setting is cancelled.

To view the Return Channel:

Press this button.

- You can view two channels (current channel and Return Channel) alternately by pressing this button.

To cancel the Return Channel setting:

Press this button and hold until the message "RETURN PLUS CANCELLED!" appears.

If no channel is set to the Return Channel:

You can view the channel selected right before the current channel by pressing this button.

CHANNEL SCAN button

You can quickly view all TV channels programmes that you can view on your TV, and search for the programme you want to view.

- 1 Press this button to start scanning TV channels.**

The TV channel programmes are each displayed for several seconds.

- The programmes of TV channels for which the SKIP function is set to "YES" are not displayed. (See page 16.)

- 2 When you find the programme you want to view, press this button again to stop scanning.**

MUTING button

You can turn the sound off instantly.

Press this button.

To turn the sound on, press this button again.

OFF TIMER button

You can set the TV to automatically turn off after a set time.

Press this button to select the period of time.

- You can set the period of time to a maximum of 120 minutes in 10 minute increments.
- 1 minute before the OFF TIMER function turns off the TV, "GOOD NIGHT!" appears.

To display the remaining time, press this button once.

To cancel the OFF TIMER function, press this button to set the period of time to 0.

- The OFF TIMER function will not turn off the TV's main power.

Remote control buttons and functions

I/II button

You can select one of the two bilingual sounds in an A2 stereo programme's bilingual programme. Press the A2 Bilingual button to select a bilingual sound.

I: Bilingual I
II: Bilingual II

- The A2 Bilingual function has no effect on stereo programmes of the A2 stereo broadcast programme type, although an A2 Bilingual function indicator will appear on the screen.
- The A2 Bilingual function has no effect on programmes other than A2 stereo broadcast programme types, although an A2 Bilingual function indicator will appear on the screen.
- The A2 Bilingual function has no effect in Video mode, although an A2 Bilingual function indicator will appear on the screen.

PICTURE BOOSTER button

When the picture is unclear because the reception level of the TV signal is low, activating the Picture Booster improves the picture clarity in some situations. Repeatedly press the PICTURE BOOSTER button to select the desired mode.

HIGH:

The Picture Booster is functioning at maximum.

LOW:

The Picture Booster is functioning at minimum.

OFF:

The Picture Booster is off.

- If the picture becomes abnormal when you set the Picture Booster to **HIGH**, then set it to **LOW** or **OFF**.

Using the TV's menus

This TV has a number of functions you can operate using the menus. To use all your TV's functions fully, you need to understand how to use the menus.

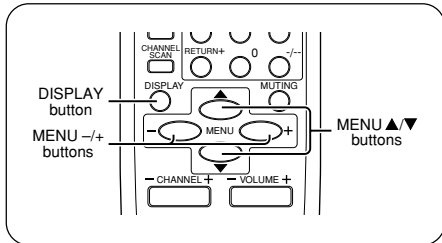

Basic operation

1 Press the MENU ▲/▼ buttons.

One of the 4 menus is displayed.

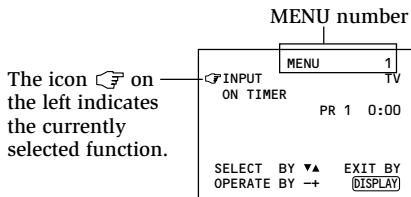

The icon  on the left indicates the currently selected function.

2 Repeatedly press the MENU ▲/▼ buttons to display a desired menu.

- If you hold down the ▼ button, the next menu is displayed.
- If the selected function is on the first line, pressing the ▲ button displays the preceding menu.

3 Repeatedly press the MENU ▲/▼ buttons to select a desired function.

4 Press the MENU -/+ buttons to change function settings.

Example:

Changes the AUTO SHUTOFF setting.

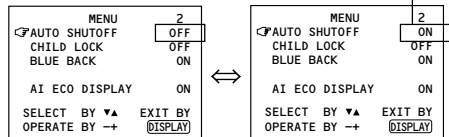

- With some functions, the operation method may differ.

5 Press the DISPLAY button to turn the display off.

- To operate a menu using the buttons on the front panel of the TV, refer to “Operating menus” on page 18.

Using the TV's menus

ON TIMER

Your TV will automatically turn on and tune into the channel you set after the period of time you set.

- 1 Press **MENU ▲/▼** to display the "MENU 1" menu, then select "ON TIMER".

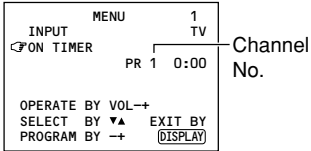

- 2 Press **MENU -/+** to select a channel you want to view when the TV turns on.
- 3 Press **VOLUME -/+** to select the period of time after which you want to turn on the TV.

The ON TIMER function starts.

- Each time you press the button, the period of time changes in 15 minute intervals (up to 12 hours).

To cancel the ON TIMER function, press the **VOLUME -/+** button to set the period of time to "0:00".

- 4 Press **DISPLAY** to turn the display off.

- If you turn off the TV's main power by pressing the Main power button, the ON TIMER function is canceled.
- If you do not turn off the TV after starting the ON TIMER function, the channel will automatically switch to the channel set for the ON TIMER function.

When the time set for the ON TIMER function is reached:

The TV automatically turns on and the channel set for the ON TIMER function is displayed.

- For safety reasons the TV will automatically turn off if no operations are made within approximately two hours after the TV is turned on with the ON TIMER function.
- The OFF TIMER function and AUTO SHUTOFF function have priority over the ON TIMER function.

INPUT

You can view images from VCRs or other devices connected to your TV.

- 1 Press **MENU ▲/▼** to display the "MENU 1" menu, then select "INPUT".

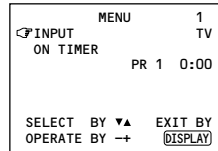

- 2 Press **MENU -/+** to select the VIDEO mode.

TV mode changes to VIDEO mode.

Using the TV's menus

AUTO SHUTOFF

You can set your TV to turn off if no signals are received for about 15 minutes or longer after the end of a broadcast.

- 1 Press **MENU ▲/▼** to display the "MENU 2" menu, then select "AUTO SHUTOFF".

| | |
|----------------|------------|
| MENU | 2 |
| ☐ AUTO SHUTOFF | ON |
| CHILD LOCK | ON |
| BLUE BACK | ON |
| AI ECO DISPLAY | ON |
| SELECT BY ▼▲ | EXIT BY |
| OPERATE BY → | Ⓜ[DISPLAY] |

- 2 Press **MENU -/+** to select "ON".

To cancel the AUTO SHUTOFF function, select "OFF".

- The AUTO SHUTOFF function does not turn off the TV's main power.
- The AUTO SHUTOFF will not work for a VIDEO mode.

CHILD LOCK

You can disable the front control buttons of the TV.

When this function is set to "ON", the TV can be operated using only the remote control.

Use this function to prevent children from operating the TV without parental consent.

- 1 Press **MENU ▲/▼** to display the "MENU 2" menu, then select "CHILD LOCK".

| | |
|----------------|------------|
| MENU | 2 |
| AUTO SHUTOFF | ON |
| ☐ CHILD LOCK | ON |
| BLUE BACK | ON |
| AI ECO DISPLAY | ON |
| SELECT BY ▼▲ | EXIT BY |
| OPERATE BY → | Ⓜ[DISPLAY] |

- 2 Press **MENU -/+** to select "ON".

To cancel the CHILD LOCK function, select "OFF".

- The CHILD LOCK function is canceled when you turn the power off.

BLUE BACK

You can mute the sound and change the picture into a blue screen while no signals are received by the TV, or when the signals are unstable.

- 1 Press **MENU ▲/▼** to display the "MENU 2" menu, then select "BLUE BACK".

| | |
|----------------|------------|
| MENU | 2 |
| AUTO SHUTOFF | ON |
| CHILD LOCK | ON |
| ☐ BLUE BACK | ON |
| AI ECO DISPLAY | ON |
| SELECT BY ▼▲ | EXIT BY |
| OPERATE BY → | Ⓜ[DISPLAY] |

- 2 Press **MENU -/+** to select "ON".

To cancel the BLUE BACK function, select "OFF".

- To view a broadcast even when the reception signal is poor, set the BLUE BACK function to "OFF".
- Even when the BLUE BACK function is set to "OFF", the sound may not be audible.

AI ECO DISPLAY

You can display on the screen the effect of the AI ECO SENSOR function.

- 1 Press **MENU ▲/▼** to display the "MENU 2" menu, then select "AI ECO DISPLAY".

| | |
|------------------|------------|
| MENU | 2 |
| AUTO SHUTOFF | OFF |
| CHILD LOCK | OFF |
| BLUE BACK | OFF |
| ☐ AI ECO DISPLAY | ON |
| SELECT BY ▼▲ | EXIT BY |
| OPERATE BY → | Ⓜ[DISPLAY] |

- 2 Press **MENU -/+** to select "ON".

The clover mark indicating the brightness of your room is displayed for several seconds each time the brightness changes. The number of clover marks displayed on screen increases as your room becomes darker. To cancel the AI ECO DISPLAY function, select "OFF".

- To switch the AI ECO SENSOR's mode, see the "ECO SENSOR button" on page 8.

Using the TV's menus

SETUP TOUR

You can start the SETUP TOUR function.

- 1 Press **MENU ▲/▼** to display the "MENU 3" menu, then select "SETUP TOUR".

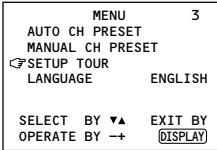

- 2 Press **MENU -/+**.

JVC logo is appear and the SETUP TOUR function will start.
For details, see page 6.

LANGUAGE

You can select the language for the on-screen display.

- 1 Press **MENU ▲/▼** to display the "MENU 3" menu, then select "LANGUAGE".

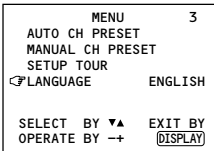

- 2 Press **MENU -/+** to select language.

The on-screen display indications are in the selected language.

AUTO CH PRESET

You can automatically preset all TV channels that can be received by your TV to channels.

- 1 Press **MENU ▲/▼** to display the "MENU 3" menu, then select "AUTO CH PRESET".

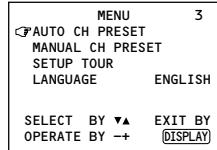

- 2 Press **MENU -/+** to start the AUTO CH PRESET function.

">>> ON SEARCH" is displayed on the screen.

When all the TV channels that can be received on your TV have been preset, the display goes out and the AUTO CH PRESET function operation is completed.

To stop the AUTO CH PRESET:
Press the MENU -/+ buttons.

- The AUTO CH PRESET function does not preset a TV channel to the AV channel (channel number 0).
- If the TV cannot preset the TV channel you want to view, preset it manually. For details, see "MANUAL CH PRESET" on page 15.

Using the TV's menus

MANUAL CH PRESET

You can manually preset desired TV channels to desired channels.

- 1 Press MENU ▲/▼ to display the "MENU 3" menu, then select "MANUAL CH PRESET".

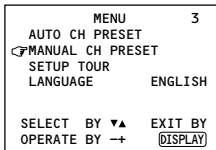

- 2 Press MENU -/+.

The sub-menu is displayed.

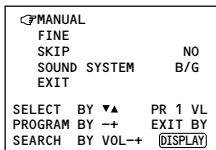

- The channel number is displayed as a PR number. For example, channel 1 will be displayed as PR 1. However, the AV channel will be displayed as AV.

- 3 Press MENU -/+ to select the channel number.

- 4 Press VOLUME -/+ to start searching for the TV channel.

">>>" or "<<<" is displayed on the screen.

When the TV finds a TV channel, the ">>>" or "<<<" display goes out, and the TV channel is preset to the currently selected channel number.

- If the TV channel you want to preset is not displayed, repeat step 4 until the TV finds the TV channel you want to preset.
- To stop the MANUAL CH PRESET function, press any button other than the VOLUME -/+ button.

If the picture is not clear:
Fine-tune the TV channel.

- 1 Press MENU ▲/▼ to select "FINE".

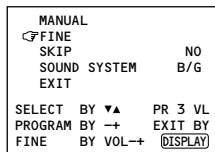

- 2 Hold VOLUME -/+ down to fine-tune the TV channel so that the best image is displayed on screen.

">" or "<" indicates that the TV is fine-tuning the TV channel.

If the sound is not clear:

- 1 Press MENU ▲/▼ to select "SOUND SYSTEM".

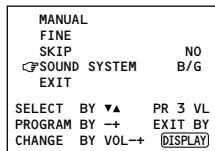

- 2 Press VOLUME -/+ to select the appropriate sound system.

- For the sound systems in each country or region, refer to the table "Broadcasting systems" on page 20.

- 5 Press MENU ▲/▼ to select "MANUAL".

- 6 Repeat steps 3 to 5 if you want to preset another TV channel to a channel.

Using the TV's menus

SKIP

You can set undesired channels to be skipped. Channels set to be skipped cannot be selected by the CHANNEL +/- buttons nor the CHANNEL SCAN button.

- Channels to which TV channels have not been preset are automatically set to be skipped.

1 Press MENU ▲/▼ to display the "MENU 3" menu, then select "MANUAL CH PRESET".

2 Press MENU +/-.

The sub-menu is displayed.

3 Press MENU ▲/▼ to select "SKIP".

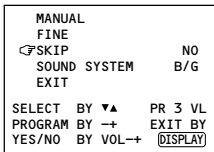

4 Press MENU +/- to select the channel you want to skip.

5 Press VOLUME +/- to select "YES".

The channel is set to be skipped.
To cancel the SKIP function, select "NO".

6 Repeat steps 4 and 5 if you want to set another channel to skip.

Picture Adjustments

You can adjust the picture as you like.

1 Press MENU ▲/▼ to display the "MENU 4" menu.

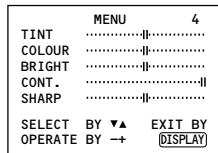

2 Press MENU ▲/▼ to select an item and press MENU +/- to adjust it.

| | | |
|---------------|-------------|--------------|
| TINT* | - : Reddish | + : Greenish |
| COLOUR | - : Lighter | + : Deeper |
| BRIGHT | - : Darker | + : Brighter |
| CONT. | - : Lower | + : Higher |
| SHARP | - : Softer | + : Sharper |

* TINT (tint) is displayed only when viewing images from NTSC3.58 or NTSC4.43 colour systems.

Using the buttons on the TV

<AV-21D43>

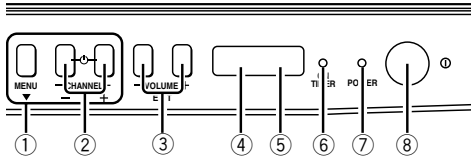

- ① MENU buttons
 - MENU ▼ button
 - MENU -/+ buttons
- ② CHANNEL -/+ buttons
- ③ VOLUME -/+ buttons
- ④ AI ECO sensor
- ⑤ Remote control sensor
- ⑥ ON TIMER lamp

<AV-14F43/AV-20N43>

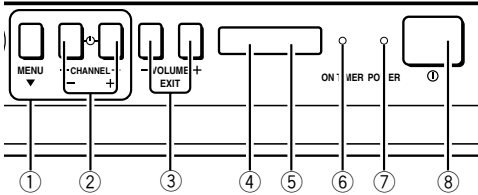

- ⑦ POWER lamp
The light is switched on while ON TIMER function is operating.
- ⑧ Main power button

Using the buttons on the TV

Basic operation

- Check to make sure the CHILD LOCK function is set to “OFF”. When the CHILD LOCK function is set to “ON”, the TV cannot be operated using the front control buttons. For details, see “CHILD LOCK” on page 13.
- 1 Press CHANNEL $-/+$ to turn the TV on from standby mode.
 - 2 Press CHANNEL $-/+$ to select a channel.
 - 3 Press VOLUME $-/+$ to adjust the volume.
 - 4 To turn your TV off, press the Main power button to turn off the TV's main power.

To change the TV mode to the VIDEO mode:

- Select the VIDEO mode with the INPUT function in “MENU 1”.

Operating menus

You can operate functions in menus using the front control buttons on the TV.

- 1 Press MENU \blacktriangledown to display a menu.
- 2 Press MENU \blacktriangledown repeatedly to display the menu you want to use.
- 3 Press MENU \blacktriangledown to select the desired function or item.
- 4 Press MENU $-/+$ or VOLUME $-/+$ to carry out the desired operation.
For details, see the description for each function.
- 5 Press VOLUME $-/+$ to turn the menu display off.

To turn the sub-menu display off:

- 1 Press MENU \blacktriangledown to select “EXIT”.

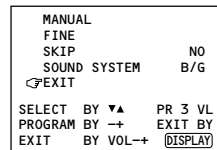

- 2 Press VOLUME $-/+$ to turn the display off.

Troubleshooting

If there is no picture or the TV does not operate normally, make sure the problem isn't due to the reasons indicated below.

If the problem persists even after taking the measures indicated, please contact a service technician.

Cannot turn the TV on

- Press the Main power button on the TV.
- Connect the power cord to the AC outlet.

The screen turns blue

- Is the BLUE BACK function on? (see page 13.)

Remote control inoperable

- Replace the batteries. (see page 3.)

Buttons on front of the TV do not work

- Switch the CHILD LOCK function off. (see page 13.)

TV does not respond immediately

- Press the main power button on the TV to turn off the main power. Press the main power button again to turn on the TV. If the TV returns to a normal state, operation is normal.

The TV turns off suddenly

- Is the OFF TIMER function set to operate? (see page 9.)
- Is the AUTO SHUTOFF function on? (see page 13.)
- Have you not performed an operation for about two hours after the TV was switched on by the ON TIMER function? (see page 12.) If you don't perform an operation within about two hours, the TV is automatically switched off for safety.

Poor sound

- Press the SOUND SYSTEM button to select another sound system. (see page 8.)

Poor picture

- Press the COLOUR SYSTEM button to select another colour system. (see page 8.)
- Adjust the picture settings. (see page 16.)
- Set the Picture mode to STANDARD. (see page 8.)
- If noise (snow) totally blocks out the picture, check the following.
 - Have the TV and aerial been connected properly?
 - Has the aerial cable been damaged?
 - Is the aerial pointing in the right direction?
 - Is the aerial itself faulty?
- If the TV or aerial suffer interference from other equipment, stripes or noise may appear in the picture. Move any equipment which can cause interference away from the TV.
- If the TV or aerial suffer interference from signals reflecting from mountains or buildings, double-pictures (ghosting) will occur. Change the aerial's direction or replace it with an aerial with better directionality.
- When a white and bright still image (such as a white dress) is displayed on the screen, the white part may look as if it is coloured. When the image disappears from the screen, the unnatural colours will also disappear.

The TV turns on suddenly

- Is the ON TIMER function set to operate? (see page 12.)

The TV channel changes suddenly

- Is the ON TIMER function set to operate? (see page 12.)

Specifications

TV RF systems

B, G, I, D, K, K1

Colour systems

PAL, SECAM, NTSC 3.58 MHz/NTSC 4.43 MHz (in VIDEO mode only)

Receiving channels

VHF low channel (VL), VHF high channel (VH), UHF channel (U)

Receives cable channels in mid band, super band and hyper band.

External input / output

INPUT: VIDEO input (RCA), AUDIO input (RCA)

OUTPUT: VIDEO output (RCA), AUDIO output (RCA)

Headphone jack: stereo mini jack (3.5 mm diameter)

Accessories

- Remote control unit: RM-C368GY
- AA / R6 / UM-3 dry cell battery × 2
- Rod aerial × 1 (AV-14F43 only)

Design and specifications subject to change without notice.

Broadcasting systems

| Area | Country or Region | System | |
|-------------------------|--|--------|-------|
| | | Colour | Sound |
| Asia, Middle East | Bahrain, Kuwait, Oman, Qatar, United Arab Emirates, Yemen, etc. Indonesia, Malaysia, Singapore, Thailand, India, etc. | PAL | B/G |
| | China, Vietnam, etc. | PAL | D/K |
| | Hong Kong, etc. | PAL | I |
| | Islamic Republic of Iran, Lebanon, Saudi Arabia, etc. | SECAM | B/G |
| Europe | Russia, etc. | SECAM | D/K |
| | Czech Republic, Poland, etc. | PAL | D/K |
| | Germany, Holland, Belgium, etc. | PAL | B/G |
| | UK, etc. | PAL | I |
| Oceania | Australia, New Zealand, etc. | PAL | B/G |
| Africa | Republic of South Africa, etc. | PAL | I |
| | Nigeria, etc. | PAL | B/G |
| | Egypt, Morocco, etc. | SECAM | B/G |

Free Manuals Download Website

<http://myh66.com>

<http://usermanuals.us>

<http://www.somanuals.com>

<http://www.4manuals.cc>

<http://www.manual-lib.com>

<http://www.404manual.com>

<http://www.luxmanual.com>

<http://aubethermostatmanual.com>

Golf course search by state

<http://golfingnear.com>

Email search by domain

<http://emailbydomain.com>

Auto manuals search

<http://auto.somanuals.com>

TV manuals search

<http://tv.somanuals.com>