

JVC



Colour Television

AV28WT5EK AV24WT5EK

Natural Vision

T-V LINK

Contents

Safety precautions	2
Setting up your TV	4
T-V LINK functions	7
Using your TV—the basics	8
Remote control buttons and functions	11
Using the TV's menus	16
Picture setting	17
Picture features	18
Sound setting	19
EXT SETTING	20
FEATURES	22
INSTALL	24
DEMO	28
Other menus	29
Further preparation	30
TV buttons and parts	32
Troubleshooting	33
Specifications	34

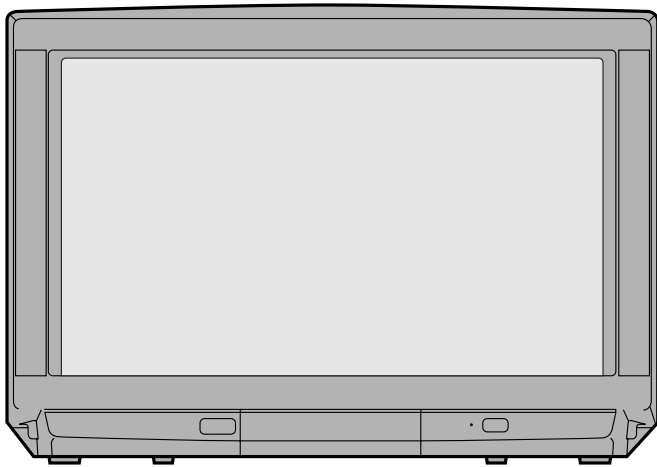

INSTRUCTIONS

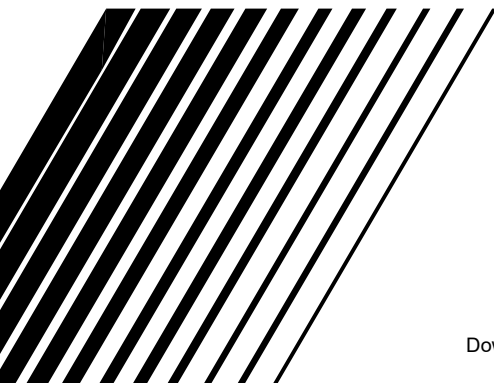

*plain English
approved*
by the word centre

Thank you for buying this **JVC** colour television.

To make sure you fully understand how to use your new TV, please read this manual thoroughly before you begin.

Safety precautions

■ Warning

To prevent fire or shock hazard, do not expose this appliance to rain or moisture.

■ Caution

To ensure personal safety, observe the following rules regarding the use of this unit.

- 1 Operate only from the power source specified (AC 220 – 240 V, 50 Hz) on the unit.
- 2 Avoid damaging the AC plug and power cord.
- 3 Avoid improper installation and never position the unit where good ventilation is unattainable.
When installing this television, distance recommendations must be maintained between the floor and wall, as well as instalment in a tightly enclosed area or piece of furniture. Please adhere to the minimum distance guidelines shown for safe operation.

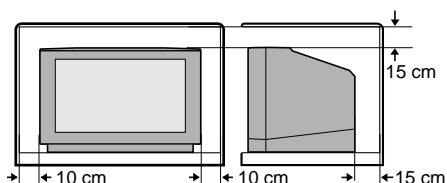

- 4 Do not allow objects or liquid into the cabinet openings.
- 5 In the event of a fault, unplug the unit and call a service technician. Do not attempt to repair it yourself or remove the rear cover.
- 6 The surface of the TV screen is easily damaged. Be very careful with it when handling the TV.
Should the TV screen become soiled, wipe it with a soft dry cloth. Never rub it forcefully. Never use any cleaner or detergent on it.
- 7 When you don't use this TV set for a long period of time, be sure to disconnect the power plug from the AC outlet.
- 8 Do not hold the front panel door when moving the TV, if you do you may break it.

■ Warning

DO NOT cut off the mains plug from this equipment. If the plug fitted is not suitable for the power points in your home or the cable is too short to reach a power point, then obtain an appropriate safety approved extension lead or adaptor or consult your dealer.

If nonetheless the mains plug is cut off, remove the fuse and dispose of the plug immediately, to avoid a possible shock hazard by inadvertent connection to the mains supply.

If a new mains plug has to be fitted, then follow the instruction given below:

Important

Do not make any connection to the larger terminal which is marked with the letter E or by the safety earth symbol \perp or coloured green or green-and-yellow.

The wires in the mains lead on this product are coloured in accordance with the following code:

Blue: Neutral
Brown: Live

As these colours may not correspond with the coloured marking identifying the terminals in your plug proceed as follows:

The wire which is coloured blue must be connected to the terminal which is marked with the letter N or coloured black.

The wire which is coloured brown must be connected to the terminal which is marked with the letter L or coloured red.

When replacing the fuse only a correctly rated approved type should be used and be sure to re-fit the fuse cover.

If in doubt — consult a competent electrician.

How to replace the fuse

Open the fuse compartment with a blade screwdriver, and replace the fuse.

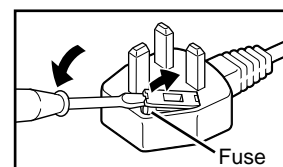

■ Guidelines for safe operation

This equipment has been designed and manufactured to comply with international safety standards. However, as with any electrical appliance, care must be taken to ensure optimal results and operational safety.

- Before attempting to use this equipment, read the operating instructions thoroughly.
- Ensure that all electrical connections (including the mains plug, extension leads, etc.) have been made in accordance with the manufacturer's instructions.
- If ever in doubt about the installation, operation or safety of this equipment, consult your dealer.
- Handle all glass panels or covers with care.
- Never operate this equipment if it appears damaged or operates abnormally. Turn the power off, disconnect the main power plug and consult your dealer.
- Never remove any affixed panels or covers. Doing so may result in electrical shock.
- Never leave this equipment operating unattended unless otherwise specifically stated that it is designed to do so or in standby mode. Only use the designated power switch to turn off the power and ensure that all potential users are instructed how to do so. Make special arrangements for infirm or handicapped persons.
- Never watch TV while operating a motor vehicle. It is illegal to watch TV while driving.
- Never listen to headphones at high volume. Doing so may damage your hearing.
- Never obstruct the ventilation of this equipment. Doing so may cause overheating and result in a malfunction or damage.
- Never use makeshift stands or attempt to affix legs with wood screws. When using a manufacturer's approved stand or legs, use only the fixtures provided and follow the installation instructions.
- Never allow this equipment to be exposed to rain or moisture.
- Never allow anyone, especially children, to insert anything into an opening in the case. Doing so may result in a fatal electrical shock.
- Never guess or take chances with electrical equipment of any kind. It is better to be safe than sorry.

Setting up your TV

■ Connecting the aerial and video cassette recorder (VCR)

If you are connecting a VCR, follow A → B → C → D in the diagram opposite.

If you are not connecting a VCR, follow ① → ②.

- For more details, see the manuals that came with the equipment you want to connect.
- The connecting cables are not provided.
- You can watch a video using the VCR without doing C. For details, see your VCR instruction manual.
- To connect more equipment, please see "Further preparation" on page 30.
- If you connect a decoder to a T-V LINK compatible VCR, set the DECODER (EXT-2) function to ON. For details, see "Using the DECODER (EXT-2) function" on page 29. Otherwise, you will not be able to watch scrambled channels.

To use the T-V LINK functions, you must have a T-V LINK compatible VCR connected by a SCART cable C to the EXT-2 terminal on the TV. For details about T-V LINK functions, see "T-V LINK functions" on page 7.

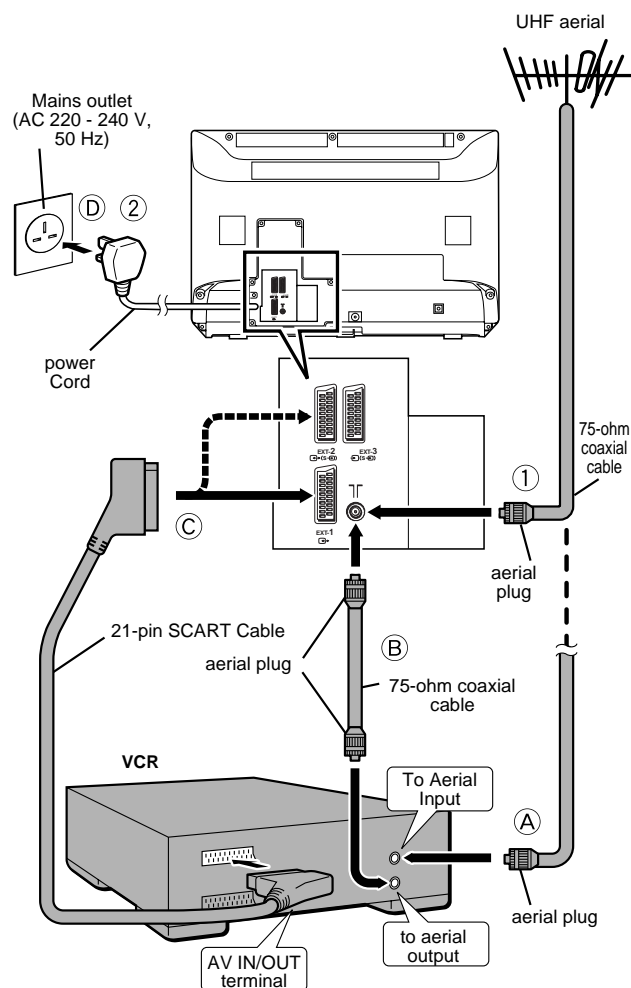

■ Putting batteries into the remote control

Use two AAA/R03 dry cell batteries.

Insert the batteries holding from the ⊖ end, making sure the ⊕ and ⊖ terminals are correctly lined up.

To open the battery compartment, slide the door downwards and lift off. Replace the door by sliding it upwards until it fastens into place.

- Follow the warnings printed on the batteries.
- Battery life is about six months to one year, depending on how much you use the remote control.
- If the remote control does not work properly, fit new batteries.
- The batteries we supply are only for setting up and testing your TV. Please replace them as soon as you need to.
- Always use good-quality batteries.

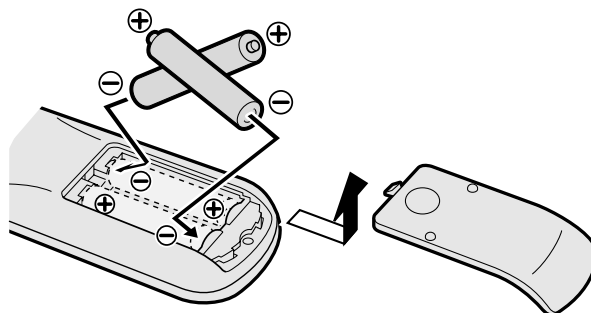

■ Initial settings

When the TV is first turned on, it goes into the initial setting mode, and you will see the JVC logo. Follow the instructions on the screen to make the initial settings.

1 Press the main power button on the TV

The power lamp lights red (for power on), then green (for TV on) and the JVC logo is appears.



- If the power lamp stays red and does not change to green:
your TV is in the standby mode. Press the  (standby) button on the remote control to turn your TV on.
- If the JVC logo does not appear this is because your TV has already been turned on for the first time:
use the “LANGUAGE” and “AUTO PROGRAM” functions to make the initial settings. For details, see “INSTALL” on page 24.

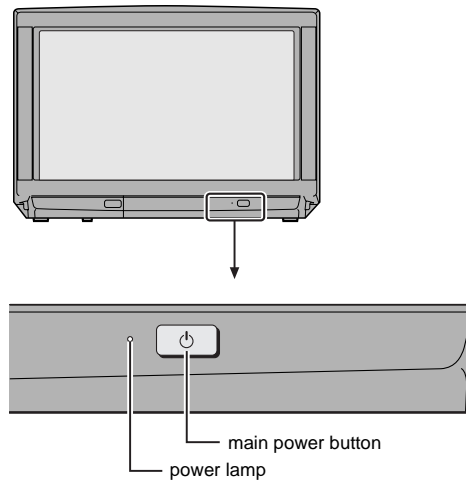

2 Press the button

The LANGUAGE menu appears.

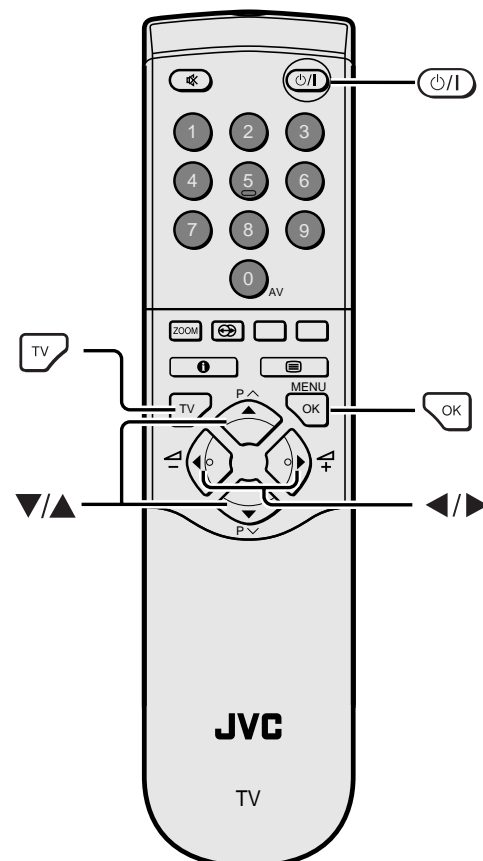

3 Press the / buttons to choose ENGLISH

The on-screen display will then be in English.

To receive SKY 1 you need a satellite tuner. You must have the satellite tuner set to SKY 1 before starting the AUTO PROGRAM function which follows.

4 Press the button to start the AUTO PROGRAM function

The AUTO PROGRAM menu appears and the TV channels you receive are automatically stored in the programme numbers list (PR).

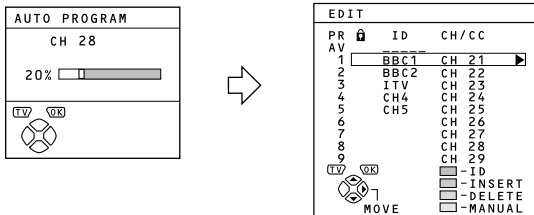

To cancel the AUTO PROGRAM function:
Press the  button.

5 After the TV channels have been registered in the programme numbers list (PR), the EDIT menu appears

If you want to, you can now edit the programme numbers (PR) using the EDIT/MANUAL function. For details, see "EDIT/MANUAL" on page 25.

If you do not want to edit programme numbers (PR), go to the next step.

6 Press the button to display the T-V LINK menu

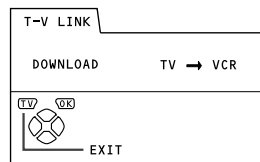

7 Follow the T-V LINK menu according to the type of VCR you have connected to the EXT-2 terminal

If you do not have a T-V LINK compatible VCR connected:

Press the  button to leave the T-V LINK menu.
The T-V LINK menu disappears.

If you have a T-V LINK compatible VCR connected:

Follow the operating procedure "Downloading data to a VCR" on page 29 to transmit the programme number (PR) data.

8 Now, the initial settings are complete, and you can watch the TV

Note:

- BBC1, BBC2, ITV, Channel 4 and Channel 5 are automatically set to programme numbers PR 1 to PR 5. SKY 1 is set to programme number PR 6, but no TV channel name (ID) is set. If the TV doesn't receive one of these TV channels, that programme number (PR) will not be set.
- If a TV channel you want to view is not set to a programme number (PR), you can set it using the MANUAL function. For details, see "EDIT/MANUAL" on page 25.
- The AUTO PROGRAM function does not set the programme number PR 0 (AV) for your video cassette recorder. You will need to set this using the MANUAL function.
- In some areas you may get TV reception from more than one transmitter, for example different ITV regions. In this case each TV channel could be set twice. If this happens, the first set of channels will have the stronger signal. If you want to delete the second set of channels, you will have to do it manually (see page 27).

If you have had any problems setting up your new TV, please call the JVC Helpline at 0870 330 5000

Enjoy your new JVC TV!

T-V LINK functions

When you have a T-V LINK compatible VCR connected to the EXT-2 Terminal on the TV, it is easier to set up the VCR and to view videos. T-V LINK uses the following features:

■ Pre-set download

The VCR will automatically download the registered data on the TV channels from the TV. This means you do not need to set up the program channels on your VCR manually. The preset download function automatically begins when the initial setting is complete or whenever you carry out the AUTO PROGRAM or EDIT/MANUAL functions.

You can also carry out this function using your VCR controls.

When "FEATURE NOT AVAILABLE" is displayed:

If "FEATURE NOT AVAILABLE" is displayed, the download was not performed correctly. Before trying to download again, check that:

- the VCR power is turned on
- the VCR is T-V LINK compatible
- the VCR is connected to the EXT-2 terminal
- the SCART cable is fully wired.

■ Direct Rec

"What You See Is What You Record"

You can easily record to VCR the images that you are watching on the TV.

For details, read the manual for your VCR.

Use your VCR controls. "VCR IS RECORDING" is displayed.

In the following situations, the VCR will stop recording if the TV is turned off, if the TV channel or input is changed, or if the menu is displayed on the TV:

- when recording images from an external device connected to the TV (for example a camcorder)
- when recording a TV channel after it has been unscrambled on a decoder
- when recording a TV channel by using the TV's output because the VCR's own tuner cannot properly receive that channel
- You cannot carry out Direct Rec using your TV's control.
- Generally, the VCR cannot record a TV channel that it cannot receive properly on its own tuner, even if you can view that TV channel on the TV. However, some VCRs can record a TV channel by using the TV's output if that channel can be viewed on the TV. For details, see your VCR instruction manual.

■ TV auto power on/VCR image view

When the VCR starts playing, the TV automatically turns on and the images from the EXT-2 terminal appear on the screen.

When the VCR menu is operated, the TV automatically turns on and the images from the EXT-2 terminal appear on the screen.

This function does not happen if your TV's main power is turned off. Set your TV's main power to on (standby mode).

Note:

- A "T-V LINK compatible VCR" means a JVC video cassette recorder with the T-V LINK logo, or with one of the following logos. However, these VCRs may support some or all of the features described earlier. For details, see your VCR instruction manual.

"Q-LINK" (a trademark of Panasonic Corporation)

"Data Logic" (a trademark of Metz Corporation)

"Easy Link" (a trademark of Phillips Corporation)

"Megalogic" (a trademark of Grundig Corporation)

"SMARTLINK" (a trademark of Sony Corporation).

Using your TV—the basics

■ Turn the main power on

Press the main power button on the TV

The power lamp lights red and your TV is in the standby mode.

If the Power lamp lights green, the TV is already on.

To turn the main power off:

Press the main power button again.

The power lamp goes off.

To save energy, turn the main power off if you are not using the TV for a long time.

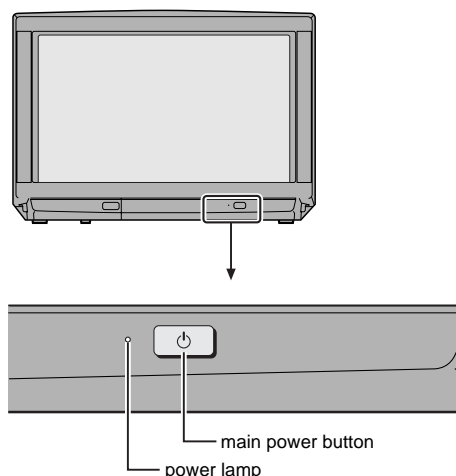

■ Turn the TV on from standby mode

Press the (standby) button, the button, the / buttons or the number buttons

The power lamp goes from red to green and your TV will be turned on.

To turn the TV off:



Press the  (standby) button again.

The power lamp changes from green to red and the TV goes into standby mode.

■ Choose a TV channel

Choose the programme number (PR) that the TV channel has been set to.



Use the / buttons:

Press the / buttons to choose the programme number (PR) you want.

Use the number buttons:

Enter the programme number (PR) of the channel using the number buttons.





Example

- PR12 → press  and .
- PR6 → press .

Use the PR LIST:



- 1 Press the  (information) button to display the PR LIST

PR	LIST
PR	LOCK ID
AV	
1	BBC1
2	BBC2
3	ITV
4	CH4
5	CH5
6	
7	
8	
9	

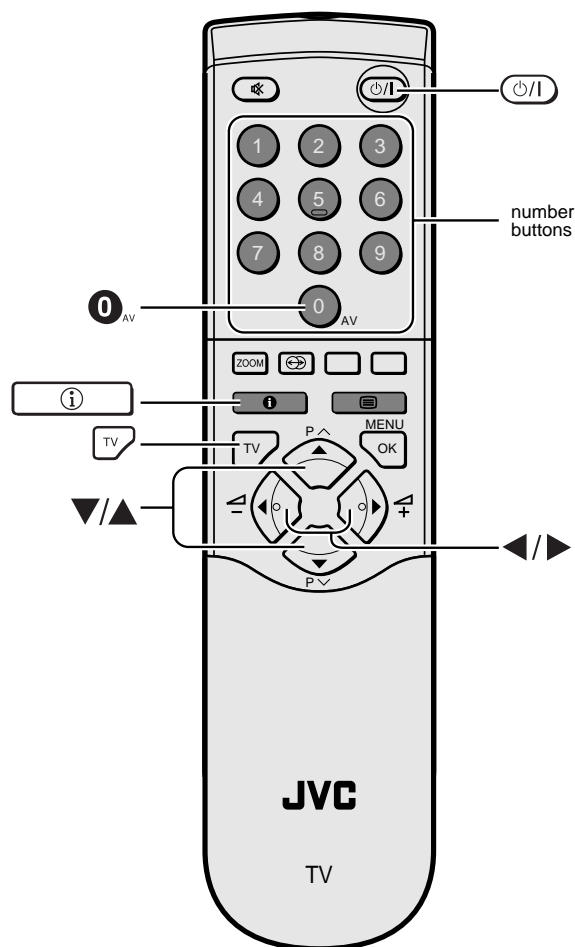
  -10   +10



2 Press the ◀/▶ and ▼/▲ buttons to choose a programme number (PR). Then press the button.

- For Programme numbers (PR) where you have the CHILD LOCK function set, the  (CHILD LOCK) mark appears next to the programme number (PR) in the PR LIST.
- You cannot use the ▼/▲ buttons to choose a Programme number (PR) which has the CHILD LOCK set.
- Even if you try to choose a programme number (PR) with the CHILD LOCK set, the  (CHILD LOCK) mark will appear, and you cannot watch the TV channel. To watch the TV channel, see “CHILD LOCK” on page 22.

■ Changing the volume

Press the ◀/▶ buttons to change the volume.

The volume indicator appears, and the volume changes, as you press the $-/+$ buttons.

■ Watching images from external equipment

Choose the EXT terminal that the external equipment has been connected to.

Use the button:

Press the  button to choose an EXT terminal.

Pressing the  button changes the choice as follows:

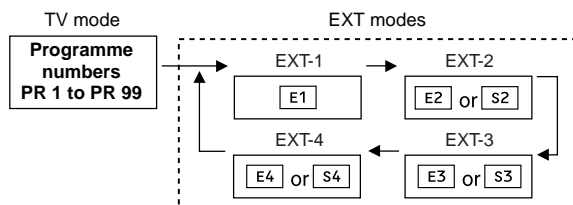

Use the ▼/▲ buttons:

Press the ▼/▲ buttons to choose an EXT terminal

Use the PR LIST:

1 Press the (information) button to display the PR LIST

2 Press the ◀/▶ and ▼/▲ buttons to choose an EXT terminal. Then press the button

- The EXT terminals are listed after programme number PR 99.
- You can choose two types of video input signal: S-VIDEO (Y/C signal) and regular video (composite signal). For details, see “ (S-VIDEO input)” on page 20.
- If you do not have a clear picture or no colour appears, change the colour system manually. See “COLOUR SYSTEM” on page 18.
- If you choose an EXT terminal with no input signal, the EXT terminal number becomes fixed on the screen.
- This TV set can automatically change over the input according to a special signal from an external device. (The EXT-4 terminal does not support it.)

To use the programme number PR 0 (AV):

When the TV and VCR are connected only by the aerial cable, choosing the programme number PR 0 (AV) allows you to view images from the VCR. Set the VCR RF channel to programme number PR 0 (AV) manually. For details, see “EDIT/MANUAL” on page 25.

Pressing the  button changes the choice as follows:

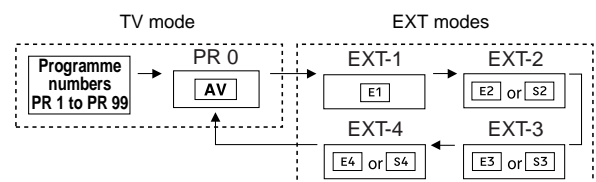

- The VCR sends its playback image along the aerial cable as an RF (radio frequency) signal.
- Also see your VCR instruction manual.

To return to a TV channel:

Press the  button, the ▼/▲ buttons or the number buttons.

■ Using the buttons on the TV

- 1** Press the P ∇/\wedge buttons to turn the TV on from standby mode
- 2** Press the P ∇/\wedge buttons to choose a programme number (PR) or an EXT terminal
- 3** Press the \triangleleft (volume) button and the $-/+$ buttons to change the volume
 - 1** Press the \triangleleft (volume) button
The volume level indicator appears
 - 2** Press the $-/+$ buttons while the volume level indicator is on screen

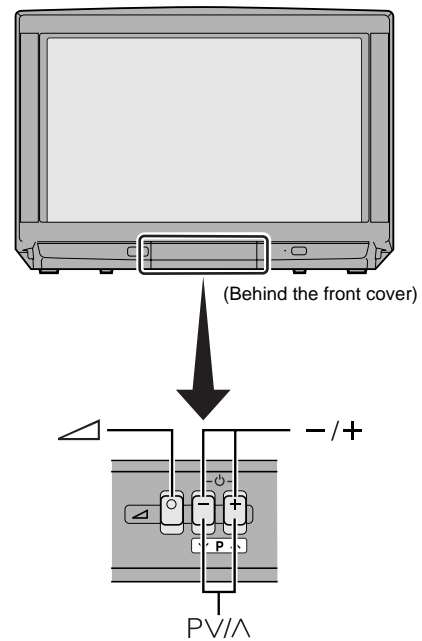

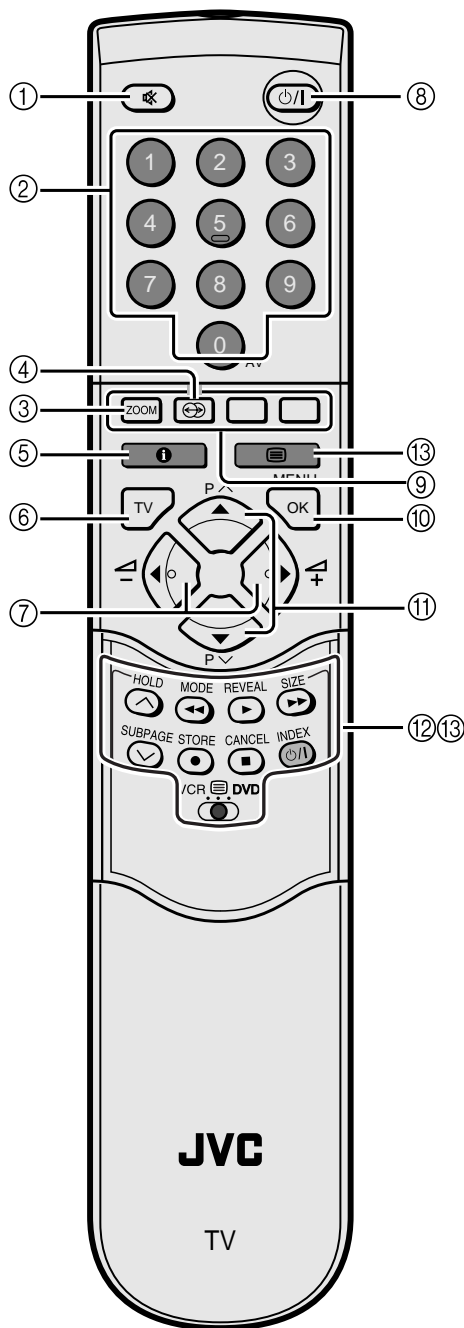

Remote control buttons and functions



① Muting button

You can turn the sound off instantly.

Press the  (muting) button to turn off the sound. Pressing the  (muting) button again restores the previous volume level

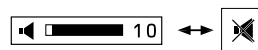

② Number buttons

You can choose a programme number (PR) by entering the programme number

Example:

- PR12 → press ① and ②.
- PR6 → press ⑥.

You can also press the  button repeatedly to choose an EXT terminal.

③ ZOOM button

You can change the screen size by changing to the picture aspect ratio. The normal aspect ratio is 4:3 (width:height). Choose the ideal one from the following ZOOM modes.

AUTO(WSS):

When a WSS (Wide Screen Signalling) signal, which shows the aspect ratio of the picture, is included in the broadcast signal or the signal from an external device, the TV automatically changes the ZOOM mode to 16:9 ZOOM mode or FULL mode according to the WSS signal.

If a WSS signal is not included, the picture is displayed in accordance with the ZOOM mode set with the 4:3 AUTO ASPECT function.

- For details of the 4:3 AUTO ASPECT function, see "4:3 AUTO ASPECT" on page 18.
- When the AUTO(WSS) mode does not function correctly due to poor WSS signal quality or when you want to change the ZOOM mode, press the  button and change to another ZOOM mode.

REGULAR:

Use to view a normal picture (4:3 aspect ratio) as this is its original shape.



PANORAMIC:

This stretches the left and right sides of a normal picture (4:3 aspect ratio) to fill the screen, without making the picture appear unnatural.

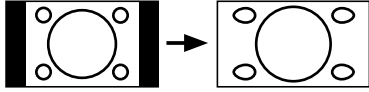

- The top and bottom of the picture are slightly cut off.

14:9 ZOOM:

This zooms up the wide picture (14:9 aspect ratio) to the upper and lower limits of the screen.

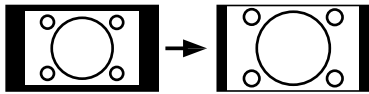

16:9 ZOOM:

This zooms up the wide picture (16:9 aspect ratio) to the full screen.

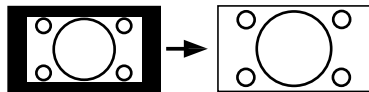

16:9 ZOOM SUBTITLE:

This zooms up the wide picture (16:9 aspect ratio) with subtitles to the full screen.

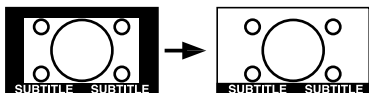

FULL:

This uniformly stretches the left and right sides of a normal picture (4:3 aspect ratio) to fill the wide TV screen.

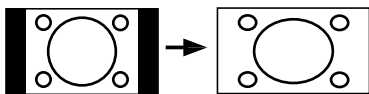

- For 16:9 aspect ratio pictures that have been squeezed into a normal picture (4:3 aspect ratio), use the FULL mode to restore the picture to its original shape.

Choose the ZOOM mode

- 1 Press the **ZOOM** button to display the ZOOM menu

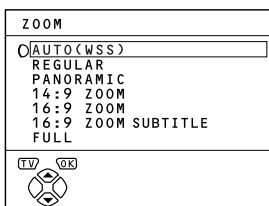

- 2 Press the **▼/▲** buttons to choose a ZOOM mode. Then press the **OK** button

The picture expands and the chosen ZOOM mode is displayed in about 5 seconds.

- The ZOOM mode may be automatically changed due to the control signal from an external device. When you want to return to the previous ZOOM mode, choose the ZOOM mode again.

Adjusting the visible area of the picture

If subtitles or the top (or bottom) of the picture are cut off, you can adjust the visible area of the picture manually.

- 1 Press the **ZOOM** button

The ZOOM menu appears.

- 2 Press the **OK** button to display the ZOOM mode indicator.

The indicator appears.

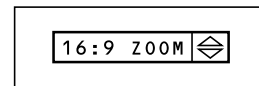

- 3 While it is displayed, press the **▼/▲** buttons to change the height of the picture.

- You cannot adjust the visible area in REGULAR or FULL mode.

4 HYPER SOUND button

You can enjoy sounds with a wider ambience.

Press the **↔** (HYPER SOUND) button to turn the HYPER SOUND function on or off

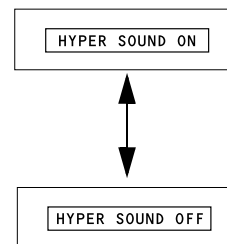

- The HYPER SOUND function does not work properly with mono sound.
- The HYPER SOUND function can be also turned on or off by using the SOUND SETTING menu. For details, see "HYPER SOUND" on page 19.

⑤ Information button

You can display the PR LIST or the current time on the screen.

Press the  (information) button

Pressing the  (information) button changes the display as follows:

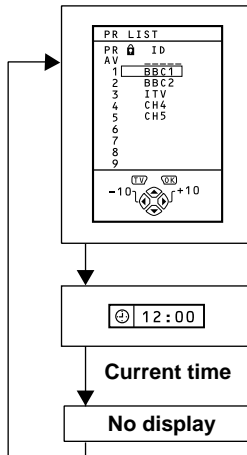

- You can choose programme numbers (PR) or EXT terminals with the PR LIST. For details, see "Use the PR LIST:" on page 8.
- This TV uses teletext data to set the time. If the TV has not received a TV channel that has teletext programmes since it was turned on, the time display is blank. To see the time, choose a TV channel that has teletext programmes. The time will still be displayed as long as you do not turn off the TV, even if you choose other TV channels.
- When watching videos, the incorrect time is sometimes displayed.
- The  (information) button will also operate menus. For details, see "Using the TV's menus" on page 16.

⑥ TV button

You can return to a TV channel instantly.

Press the  button.

The TV returns to the TV mode and a TV channel appears.

- The  button will also operate menus. For details, see "Using the TV's menus" on page 16.

⑦ ◀▶ Buttons

You can adjust the volume.

Press the  buttons to adjust the sound.

- The  buttons will also operate menus. For details, see "Using the TV's menus" on page 16.

⑧ Standby button

Press the  (standby) button to turn the TV on or off.

When the TV is turned on, the power lamp changes from red to green.

⑨ Colour buttons

The colour buttons are used for the teletext operations or the menu operations. For details, see "⑬ Teletext control buttons and VCR/⏏/DVD switch" on page 14 or "Using the TV's menus" on page 16.

⑩ OK button

The  button is used to operate menus. For details, see "Using the TV's menus" on page 16.

⑪ ▼/▲ Buttons

You can choose a programme number (PR) or an EXT terminal.

Press the ▼/▲ buttons to choose a Programme number (PR) or an EXT terminal.

The ▼/▲ buttons will also operate menus. For details, see "Using the TV's menus" on page 16.

⑫ VCR/DVD control buttons and VCR/⏏/DVD switch

These buttons will operate a JVC brand VCR or DVD player. Pressing a button that looks the same as the device's original remote control button has the same effect as the original remote control.

1 Set the VCR/⏏/DVD switch to the VCR or DVD position.

VCR:

When you are using a VCR, set the switch to the VCR position.

DVD:

When you are using a DVD player, set the switch to the DVD position.

⏏ (Text):

When you are viewing Teletext programmes, set the switch to the  (Text) position.

2 Press the VCR/DVD control button to control your VCR or DVD player

- If your device is not made by JVC, these buttons will not work.
- Even if your device is made by JVC, some of these buttons may not work, depending on the device you are using.
- You can use the ▼/▲ buttons to choose a TV channel the VCR will receive, or choose the chapter the DVD player plays back.
- Some models of DVD player use the ▼/▲ buttons for both operating the fast forward/backward functions and for choosing the chapter. In this case, the ◀▶ buttons do not work.

13 Teletext control buttons and VCR/DVD switch

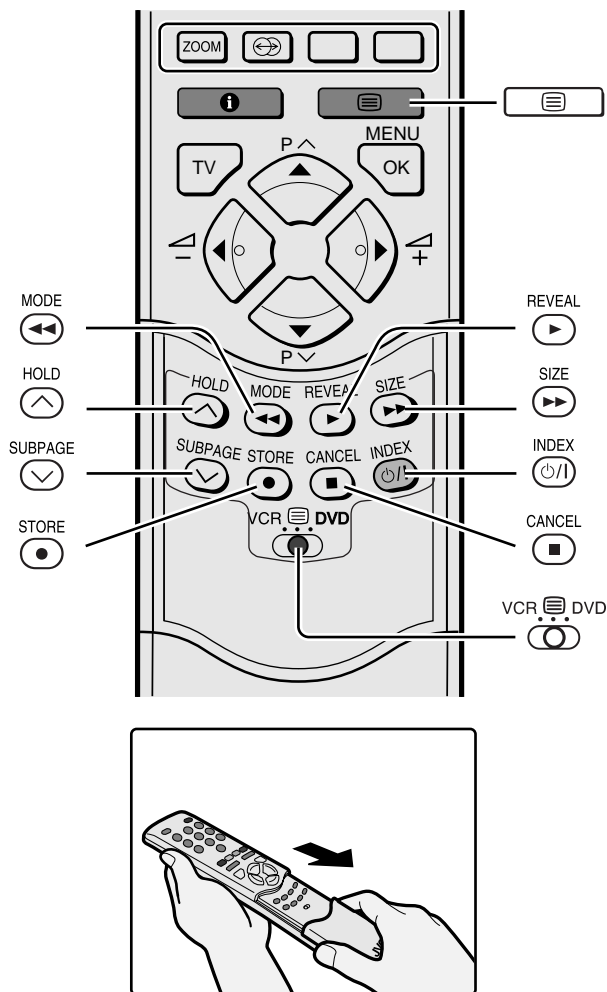

4 Choose a teletext page by pressing the ▼/▲ buttons, number buttons or colour buttons

To return to the TV mode:

Press the button or (Text) button.

- If you have trouble receiving teletext broadcasts, contact your local dealer or the teletext station.
- In Text mode, the ZOOM mode is fixed to FULL.
- You cannot operate menus when viewing a teletext programme.

Using the List Mode

You can store the numbers of your favourite teletext pages in memory and call them up quickly using the colour buttons.

To store the page numbers:

1 Press the button to go into the List mode

The page numbers you have stored are displayed at the bottom of the screen.

2 Press a colour button to choose a position. Then press the number buttons to enter the page number

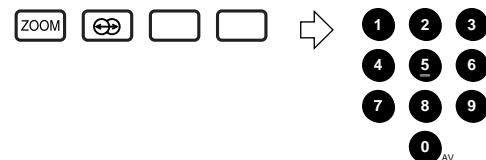

3 Press and hold down the button

The four page numbers blink white to show that they are stored in memory.

To call up a stored page:

1 Press the button to enter the List mode

2 Press a colour button having a stored page



To leave the List mode:

Press the button again.

Basic operation

You can view two types of teletext broadcasts on the TV: FLOF (Fastext) and WST (World Standard Text).

1 Choose a TV channel with a teletext broadcast

2 Set the VCR/DVD switch to the (Text) position



3 Press the (Text) button to display the teletext

Pressing the (Text) button changes the mode as follows:

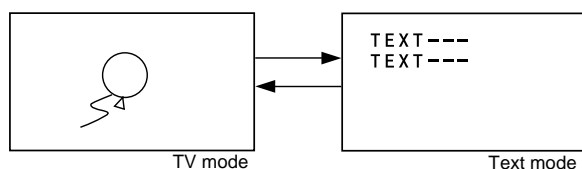

Hold

You can hold a teletext page on the screen for as long as you want, even while several other teletext pages are being received.

Press the  button

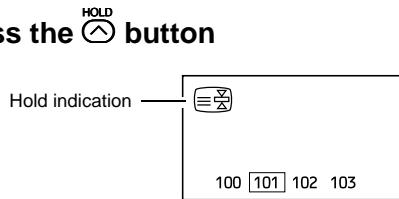

To cancel the Hold function:

Press the  button again.

Sub-page

Some teletext pages include sub-pages that are automatically displayed.

You can hold any sub-page, or view it at any time.

- 1 Press the  button to operate the sub-page function
- 2 Press the Number buttons to enter a sub-page number

Example:

- 3rd sub-page → press **0**, **0**, **0** and **3**.

To cancel the sub-page function:

Press the  button again.

- You can also choose a sub-page by pressing the red or green button.

Reveal

Some teletext pages include hidden text (such as the answers to a quiz).

You can display the hidden text.

Each time you press the  button, text is hidden or revealed

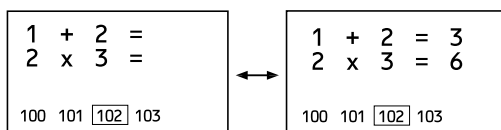

Size

You can double the height of the teletext display.

Press the  button.

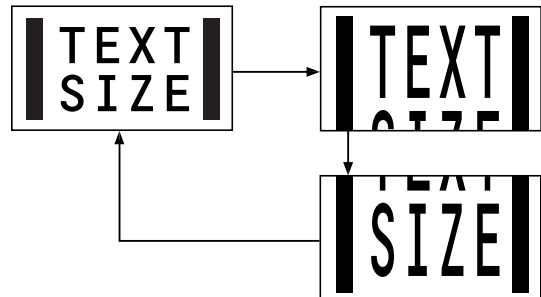

Index

You can return to the index page instantly.

Press the  button

FLOF (Fastext)/WST (World Standard Text):

Returns to page 100 or a previously specified page.

List mode:

Returns to the page number displayed in the lower left area of the screen.

Cancel

You can search for a teletext page while watching TV.

- 1 Press the number button to enter a page number, or press a colour button



The TV searches for a teletext page.

- 2 Press the  button.

The TV programme appears. When the TV finds the teletext page, its page number appears in the upper left of the screen.

- 3 Press the  button to return to a teletext page when the page number is on the screen

Note:

- The TV mode cannot be resumed by pressing the  button. To return to the TV mode press the  button.

Using the TV's menus

This TV has a number of functions you can operate using menus. To use all your TV's functions fully, you need to understand how to use the basic menus.

1 Press the button to display the MENU (main menu)

The MENU (main menu) appears. In it, the titles of the menus are displayed.

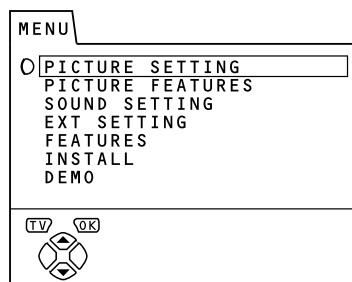

2 Press the / buttons to choose a menu title, and press the button

The menu appears.

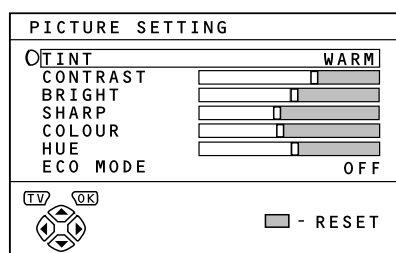

3 Follow the menus according to the function you want to use

- For more details, see the descriptions of each menu and its functions, on the following pages.
- The display appearing at the bottom of a menu shows you a button on the remote control that you can use when you operate a chosen function.

4 Press the button to complete the setting

The menu disappears.

To return to the previous menu:

Press the  (information) button.

To exit a menu instantly:

Press the  button.

Picture setting

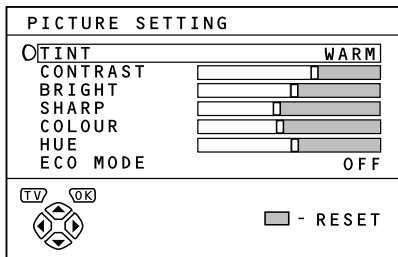

To display the PICTURE SETTING menu:

- 1 Press the button to display the MENU (main menu)
- 2 Press the / buttons to choose PICTURE SETTING, and press the button

■ TINT

You can select one of three TINT modes (three kinds of picture settings) to adjust the picture settings automatically.

- 1 Press the / buttons to choose TINT
- 2 Press the / buttons to choose a mode

COOL:

A cool white colour base with a boost in the colour and contrast levels that creates a more vivid picture.

WARM:

A warm orange/red colour base that creates the appropriate colour and contrast levels for watching films.

NORMAL:

A normal white colour base with normal colour and contrast levels.

- 3 Press the button to complete the setting

The menu disappears.

■ Picture adjustment

You can change the picture settings of each TINT mode as you like.

The picture settings changed are stored in the TINT mode.

- 1 Press the / buttons to choose an item.
- 2 Press the / buttons to change the setting.

◀	Item	▶
Lower	CONTRAST (picture contrast)	Higher
Darker	BRIGHT (picture brightness)	Brighter
Softer	SHARP (picture sharpness)	Sharper
Lighter	COLOUR (picture colour)	Deeper
Reddish	HUE (picture hue)	Greenish

- You can change the HUE setting (picture hue) only when the colour system is NTSC 3.58 or NTSC 4.43. (See "Specifications" on page 34.)

To return to the default settings in each TINT mode:

Press the blue button.

This returns the picture settings in the TINT mode you have chosen to the default settings, and stores them in the TINT mode.

- 3 Press the button to complete the settings

The menu disappears.

■ ECO MODE

When you set the ECO MODE function to ON, the screen contrast is automatically adjusted to a setting suitable for the brightness of your room. This reduces eye strain for you and the amount of power the TV uses.

- 1 Press the / buttons to choose ECO MODE

- 2 Press the / buttons to choose ON

To cancel the ECO MODE function:

Press the / buttons to choose OFF.

- 3 Press the button to complete the setting

The menu disappears.

Picture features

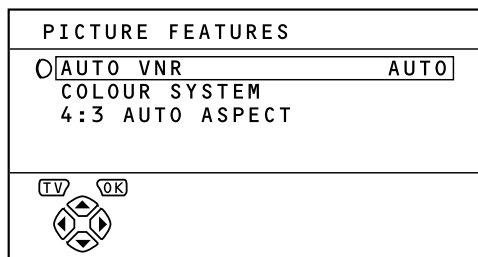

To display the PICTURE FEATURES menu:

- 1 Press the button to display MENU (main menu)
- 2 Press the buttons to choose PICTURE FEATURES, and press the button

■ AUTO VNR

VNR Stands for “video noise reduction”.

The AUTO VNR function reduces any “noise” (interference or snowing) in the current picture. The function also adjusts the optimum sharpness of the picture (SHARP).

- 1 Press the buttons to choose AUTO VNR
- 2 Press the buttons to choose AUTO

MIN:

The AUTO VNR function is cancelled. If you set the mode to AUTO but feel that the sharpness of the original picture has not been reproduced fully, change the mode to MIN. However, any noise remaining in the original picture may be emphasized.

MAX:

This mode always reduces any noise as much as possible, irrespective of state of the picture. When you set the mode to AUTO but still notice some noise, change the mode to MAX. However, this may reduce the sharpness of the picture.

- 3 Press the button to complete the setting.

The menu disappears.

■ COLOUR SYSTEM

The colour system is chosen automatically. However, if the picture is not clear or no colour appears, choose the colour system manually.

- 1 Press the buttons to choose COLOUR SYSTEM. Then press the button

The sub-menu of the COLOUR SYSTEM function appears.

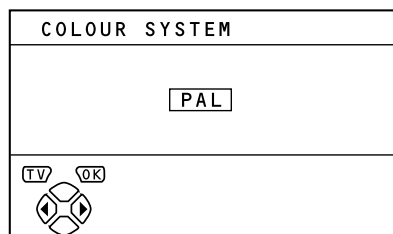

- 2 Press the buttons to choose the appropriate colour system.

PAL:

PAL system

NTSC 3.58:

NTSC 3.58 MHz system

NTSC 4.43

NTSC 4.43 MHz system

AUTO:

This function detects a colour system from the input signal. You can only use this when you are viewing a picture from programme number PR 0 (AV), or on EXT terminal.

- 3 Press the button to complete the setting

The menu disappears.

- The AUTO function may not work properly if you have poor signal quality. If the picture is abnormal in the AUTO function, choose another colour system manually.
- You cannot choose NTSC 3.58 or NTSC 4.43 for programme numbers PR 0 (AV) to PR 99.

■ 4:3 AUTO ASPECT

This function only works when the ZOOM mode is set to AUTO(WSS) mode. It sets the ZOOM mode you want to use for when a WSS signal is not included in the broadcast signal or the signal from an external device. You can choose one of three ZOOM modes.

- For details of the AUTO(WSS) mode, see the “AUTO (WSS)” section within “③ ZOOM button” on page 11.

- 1 Press the buttons to choose 4:3 AUTO ASPECT. Then press the button

The sub-menu of the 4:3 AUTO ASPECT function appears.

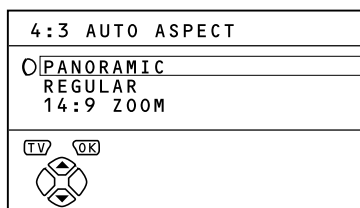

- 2 Press the buttons to choose a ZOOM mode

- 3 Press the button to complete the setting

The menu disappears.

Sound setting

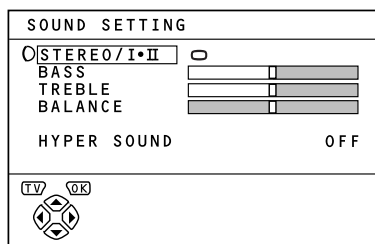

To display the SOUND SETTING menu:

- 1 Press the button to display the MENU (main menu)
- 2 Press the buttons to choose SOUND SETTING. Then press the button

■ STEREO / I•II

When you are viewing a bilingual broadcast programme, you can choose the sound from Bilingual I (Sub I) or Bilingual II (Sub II). If you have poor reception on a stereo broadcast, you can change from stereo to mono sound so that you can hear the broadcast more clearly and easily.

- 1 Press the buttons to choose STEREO / I•II
- 2 Press the buttons to choose a sound mode

:Stereo sound

:mono sound

I :Bilingual I (sub I)

II :Bilingual II (sub II)

- 3 Press the button to complete the setting

The menu disappears.

- The sound mode you can choose differs depending on the TV programme.
- This function does not work in the EXT modes. And this function does not appear in the SOUND SETTING menu.

■ Sound adjustment

You can adjust the sound to your liking.

- 1 Press the buttons to choose an item
- 2 Press the buttons to adjust it

	Item	
Weaker	BASS	Stronger
Weaker	TREBLE	Stronger
Left	BALANCE	Right

- 3 Press the button to complete the setting

The menu disappears.

■ HYPER SOUND

You can enjoy sounds with a wider ambience.

- 1 Press the buttons to choose HYPER SOUND
- 2 Press the buttons to choose ON
To cancel the HYPER SOUND function:
Press the buttons to choose OFF.
- 3 Press the button to complete the setting

The menu disappears

- The HYPER SOUND function does not work properly with mono sound.
- You can turn the HYPER SOUND function on or off with a single press. For details, see “ HYPER SOUND button” on page 12.

EXT SETTING

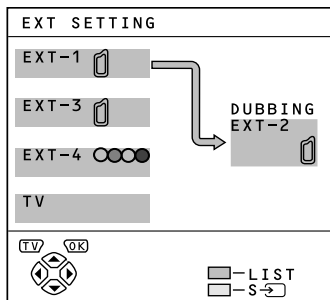

To display the EXT SETTING menu:

- 1 Press the **OK** button to display the MENU (main menu)
- 2 Press the **▼/▲** buttons to choose EXT SETTING. Then press the **OK** button

■ S-V (S-VIDEO input)

You can connect a device (such as an S-VHS VCR) to enjoy the high-quality picture of the S-VIDEO signal (Y/C signal).

Preparation:

- First read the device's instruction manual and "Further preparation" on page 30 to connect the device to the TV properly. Second, follow the device's instruction manual to set the device so that it sends an S-VIDEO signal (Y/C signal) to the TV.
- Do not set S-V (S-VIDEO input) to an EXT terminal connected to a device which cannot output an S-VIDEO (Y/C signal). If it is set wrongly, a picture cannot appear.

- 1 Press the **▼/▲** buttons or **◀/▶** buttons to choose an EXT terminal

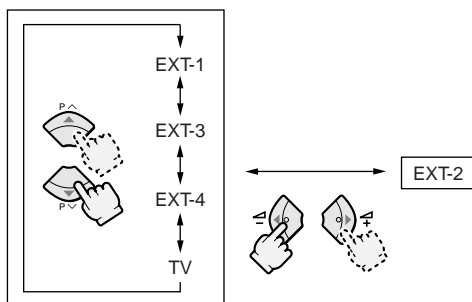

- 2 Press the yellow button and set the **S-V** (S-VIDEO input)

An **S-V** (S-VIDEO input) mark is displayed. You can view an S-VIDEO signal (Y/C signal) instead of the regular video signal (composite signal).

To cancel the S-V (S-VIDEO input) setting:

Press the yellow button and turn off the **S-V** (S-VIDEO input) mark.

The regular video signal (composite signal) pictures are resumed.

- 3 Press the **OK** button to complete the setting.

The menu disappears.

- The EXT-1 terminal does not support S-VIDEO signal (Y/C signal) and you cannot set **S-V** (S-VIDEO input) in the EXT-1 terminal.
- Setting **S-V** (S-VIDEO input) changes the head character from "E" to "S". When an EXT terminal receives a normal video signal, "E1", "E2", "E3" or "E4" appears on the display. This changes to "S2", "S3" or "S4" when it receives an S-VIDEO signal.
- Even a device which can output an S-VIDEO signal (Y/C signal) may output a regular video signal (composite signal) depending on the device setting. If a picture cannot appear because the **S-V** (S-VIDEO input) setting has been made, read the device instruction manual carefully again to check for the device settings.

■ LIST

You can store a name for each of the devices connected to each EXT terminal. Giving a name to an EXT terminal makes the EXT terminal number appear on the screen, together with its name.

- 1 Press the **▼/▲** buttons or **◀/▶** buttons to choose an EXT terminal

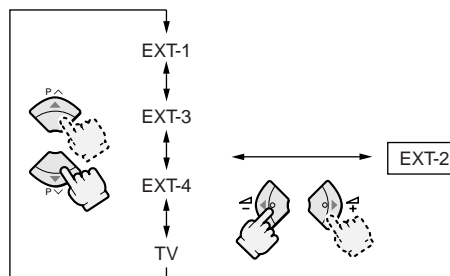

- 2 Press the blue button to display the name list (LIST)

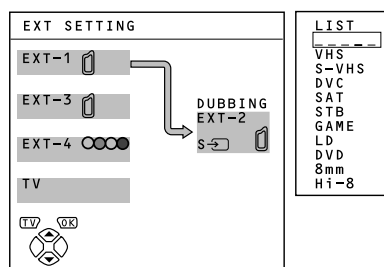

3 Press the ▼/▲ buttons to choose a name. Then press the  button.

The LIST disappears and the name is assigned to the EXT terminal.

To erase a name assigned to the EXT terminal:

Choose a blank space.

4 Press the  button to complete the setting.

The menu disappears.

- You cannot choose an EXT terminal name that is not on the name list (LIST).

3 Press the  button to complete the setting.

The menu disappears.

- During dubbing, you cannot turn off the TV. Turning off the TV also turns off the output from the EXT-2 terminal.
- When you choose an EXT terminal as an output, you can view a TV programme or a picture from the other EXT terminal while dubbing the picture from a device connected to the EXT terminal onto a VCR connected to the EXT-2 terminal.
- The RGB signals from TV games cannot be output. Teletext programmes cannot be output.

■ DUBBING

You can choose a signal source to be output from the EXT-2 terminal.

You can do this with the output signal of the device connected to another EXT terminal, or the picture and sound from a TV channel you are currently viewing.

1 Press the ◀/▶ buttons to choose the EXT-2 terminal.

2 Press the ▼/▲ buttons to choose another EXT terminal or TV.

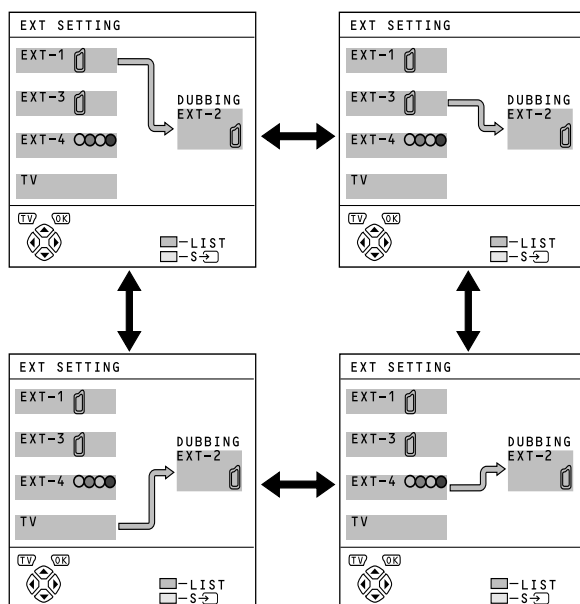

The arrow in the menu represents a signal flow. The left side of the arrow shows a signal source output from the EXT-2 terminal.

EXT-1/EXT-3/EXT-4:

The output signal of the device connected to an EXT terminal passes through the TV and is output from the EXT-2 terminal.

TV:

The picture and sound of the TV channel you are currently viewing are output from the EXT-2 terminal.

FEATURES

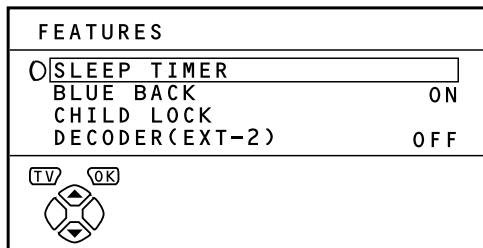

To display the FEATURES menu:

- 1 Press the button to display the MENU (main menu)
- 2 Press the buttons to choose FEATURES. Then press the button

■ SLEEP TIMER

You can set the TV to automatically turn off after a set time.

- 1 Press the buttons to choose SLEEP TIMER. Then press the button

A sub-menu of the SLEEP TIMER function appears.

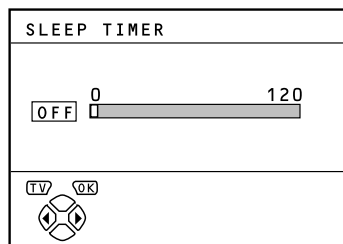

- 2 Press the buttons to set the period of time

You can set the time for up to 120 minutes (2 hours) in 10 minute steps.

To cancel the SLEEP TIMER function:

Press the button to set the period of time to "OFF."

- 3 Press the button to complete the setting

The menu disappears.

- One minute before the SLEEP TIMER function turns off the TV, "GOOD NIGHT!" appears.
- The SLEEP TIMER function cannot be used to turn off the TV's main power.
- When the SLEEP TIMER function is on, you can display the sub-menu of the SLEEP TIMER function again to confirm or change the remaining period of time of the SLEEP TIMER function. Press the button to leave the menu after confirming or changing the remaining time.

■ BLUE BACK

You can set the TV to automatically change to a blue screen and mute the sound if the signal is weak or absent, or when there is no input from an external device.

- 1 Press the buttons to choose BLUE BACK
- 2 Press the buttons to choose ON

To cancel the BLUE BACK function:

Press the buttons to choose OFF.

- 3 Press the button to complete the setting

The menu disappears.

■ CHILD LOCK

When there is a TV channel you do not want your children to watch, you can use the CHILD LOCK function to lock out the TV channel. Even when a child chooses a programme number (PR) for a locked TV channel the screen will change to blue and display (CHILD LOCK) so the TV channel cannot be viewed. Unless you enter a pre-set ID number by a special operation, the lock cannot be released and the child cannot view the TV channel.

To set the CHILD LOCK function

- 1 Press the buttons to choose CHILD LOCK. Then press the button.

"SET ID NO." (ID number setting screen) appears.

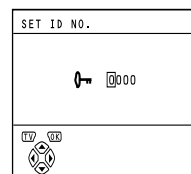

- 2 To set the ID number you want

- 1 Press the buttons to choose a number
- 2 Press the buttons to move the cursor

- 3 Press the button.

The sub-menu of CHILD LOCK appears.

PR		ID	CH / CC
AV			
1		BBC1	CH 21
2		BBC2	CH 22
3		ITV	CH 23
4		CH4	CH 24
5		CH5	CH 25
6			CH 26
7			CH 27
8			CH 28
9			CH 29

- LOCK

- 4 Press the buttons to choose a TV channel

Every time you press the buttons, the programme number (PR) changes, and the picture of the TV channel registered in the programme number (PR) is displayed on the screen.

5 Press the blue button and set the CHILD LOCK function.

 (CHILD LOCK) appears and the TV channel is locked.

To reset the CHILD LOCK function:

Press the blue button again.

 (CHILD LOCK) disappears.

6 Press the  button to complete the setting.

The menu disappears.

- To disable easy resetting of the CHILD LOCK function, the menu disappears if you choose the CHILD LOCK function and press the  button.

To view a locked TV channel

1 Choose a programme number (PR) for a locked TV channel, by using the number buttons or PR LIST

The screen changes to blue and the  (CHILD LOCK) appears. You cannot view the TV channel.

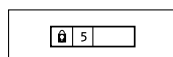

2 Press the  (information) button to display "ID NO." (ID No. input screen)

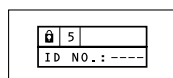



3 Press the number buttons to enter the ID number

The lock is temporarily released so you can view the TV channel.

If you have forgotten the ID number:

Perform step 1 of "To set the CHILD LOCK function". After confirming the ID number, press the  button to exit the menu.

- Even if you reset the lock temporarily, it does not mean that the CHILD LOCK function set for the TV channel is cancelled. The next time anyone tries to view the TV channel, it will be locked again.
- When you want to cancel the CHILD LOCK function, you must perform the operation "To set the CHILD LOCK function" again.
- To stop it being easy to choose the programme number (PR) of a locked TV channel, the programme number (PR) has been set so that it cannot be chosen by the / buttons or the buttons of the TV.
- To stop it being easy to reset of the lock, "ID NO." (ID No. input screen) is set so that it cannot appear unless you press the  (Information) button.

■ DECODER (EXT-2)

You can only use this function if you have a decoder connected to a T-V LINK compatible VCR, which in turn is connected to the EXT-2 terminal. To use this function, see "Using the DECODER (EXT-2) function" on page 29.

- If you have not connected a decoder with a T-V LINK compatible VCR to the EXT-2 terminal, setting this function to "ON" by mistake causes the picture/sound of a TV channel you are currently viewing to disappear.

INSTALL

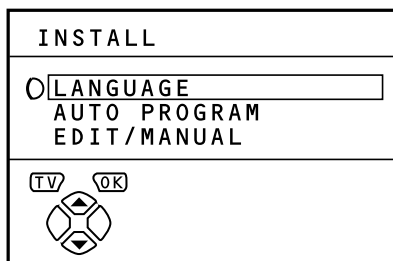

To display the INSTALL menu:

- 1 Press the **OK** button to display the MENU (main menu)
- 2 Press the **▼/▲** buttons to choose the INSTALL menu. Then press the **OK** button

■ LANGUAGE

You can choose the language you want to use for the on-screen display from the language list in the menu.

- 1 Press the **▼/▲** buttons to choose LANGUAGE. Then press the **OK** button

A sub-menu of the LANGUAGE function appears.



- 2 Press the **▼/▲** buttons to choose a language
- 3 Press the **OK** button to complete the setting

The menu disappears.

■ AUTO PROGRAM

To receive SKY 1 you need a satellite tuner. You must have the satellite tuner set to SKY 1 before starting the AUTO PROGRAM function.

You can automatically store the TV channels for which you have the best reception. Store them in the TV's programme numbers (PR) list by doing the following.

- 1 Press the **▼/▲** buttons to choose AUTO PROGRAM
- 2 Press the **OK** button to start the AUTO PROGRAM function

The AUTO PROGRAM menu appears and the TV channels you receive are automatically registered in the programme numbers (PR) list.

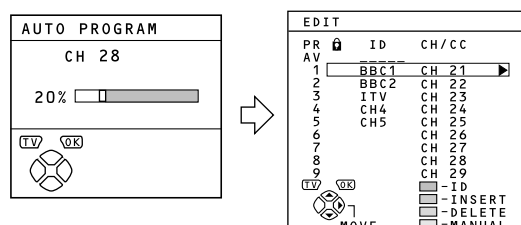

To cancel the AUTO PROGRAM function:

Press the **TV** button.

- 3 After the TV channels have been stored in the programme numbers (PR) list, the EDIT menu appears

You can now edit the programme numbers (PR) list using the EDIT/MANUAL function. For details, see "EDIT/MANUAL" on page 25.

When not using the EDIT/MANUAL function:

If you do not need to use the EDIT/MANUAL function, go to the next step.

- 4 Press the **OK** button to display the T-V LINK menu

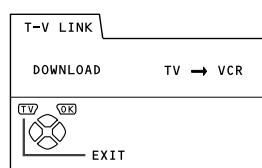

- 5 Operate the T-V LINK menu according to the type of video cassette recorder (VCR) you have connected to the EXT-2 terminal

If you do not have a T-V LINK compatible VCR connected:

Press the **TV** button to leave the T-V LINK menu.

The T-V LINK menu disappears, and all the settings are completed.

If you have a T-V LINK compatible VCR connected:

See "Downloading data to a VCR" on page 29 to transmit the programme number (PR) data to the VCR.

- If a TV channel you want to view is not set to a Programme number (PR), set it manually using the MANUAL function. For details, see "EDIT/MANUAL" on page 25.
- The AUTO PROGRAM function does not set the programme number PR 0 (AV) for your video cassette recorder. You will need to set this using the manual function.
- In some areas you may get TV reception from more than one transmitter, for example, different ITV regions. In this case each TV channel could be set twice. If this happens, the first set of channels will have the stronger signal. If you want to delete the second set of channels, you will have to do it manually (see page 27).

■ EDIT/MANUAL

The EDIT/MANUAL functions are divided into two types:

- editing the current programme numbers (PR) (EDIT functions); and
- manually storing a TV channel you want to view a programme number (PR) (MANUAL function).

Here are the details about these functions:

MOVE:

This function changes the programme number (PR) of a TV channel.

ID:

This function registers a channel name (ID) to a TV channel.

INSERT:

This function adds a new TV channel in the current programme numbers (PR) list by using the CH number.

DELETE:

This function deletes a TV channel you do not want to list.

MANUAL:

This function manually stores a new TV channel in a programme number (PR).

- For programme number PR 0, "AV" appears in the programme numbers (PR) list.
- An EXT terminal number does not appear in the programme numbers (PR) list.
- The CH number is a number unique to the TV and corresponds to the channel number of a TV channel. For the relationship between a channel number and a CH number, see "CH NUMBER" on page 27.
- You cannot use the INSERT function if you do not know the channel number of a TV channel. Use the MANUAL function to register a TV channel in the programme number (PR) list.

Caution:

- Using the MOVE, DELETE or INSERT functions rewrites the current programme numbers (PR) list. Therefore, the programme numbers (PR) of some of the TV channels will change.
- Using the MANUAL function for a TV channel for which the CHILD LOCK function has been set cancels the CHILD LOCK function for that channel.
- Using the MANUAL function for a TV channel for which the DECODER (EXT-2) function has been set to ON returns the setting of the DECODER (EXT-2) function for that channel to OFF.
- When a TV channel has already been registered in PR 99, using the INSERT function deletes that TV channel.

1 Press the ▼/▲ buttons to choose EDIT/MANUAL. Then press the button

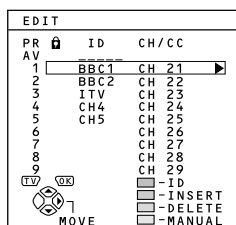

2 Follow the options for the function you want to use

3 Press the button to complete the settings

The T-V LINK menu appears.

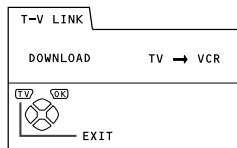

4 Follow the T-V LINK menu according to the type of VCR you have connected to the EXT-2 terminal

If you do not have a T-V LINK compatible VCR connected:

Press the  button to leave the T-V LINK menu.

The T-V LINK menu disappears and all the settings are completed.

If you have a T-V LINK compatible VCR connected:

Follow the operating procedure "Downloading data to a VCR" on page 29 to transmit the programme number (PR) data to the VCR.

MOVE

1 Press the ▼/▲ buttons to choose a TV channel

Every time you press the ▼/▲ buttons, the programme number (PR) changes, and the picture of the TV channel stored in the programme number (PR) appears on the screen.

2 Press the ► button to start the MOVE function

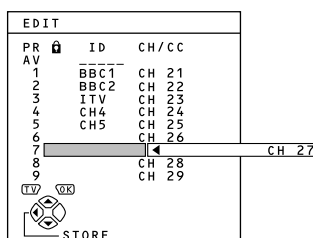

3 Press the ▼/▲ buttons to choose a new programme number (PR)

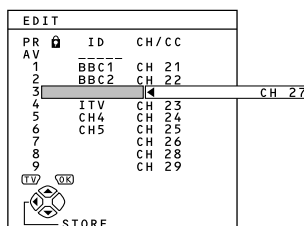

To cancel the MOVE function:

Press the  (information) button.

4 Press the ◀ button to change the programme number (PR) of a TV channel to a new programme number (PR)

ID

1 Press the ▼/▲ buttons to choose a TV channel

Every time you press the ▼/▲ buttons, the programme number (PR) changes, and the picture of the TV channel stored in the programme number (PR) appears on the screen.

2 Press the red button to start the ID function

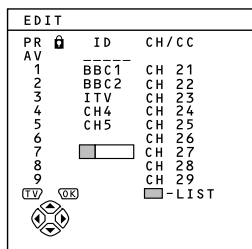

3 Press the ▼/▲ buttons to choose the first character of a channel name (ID) you want to give the TV channel

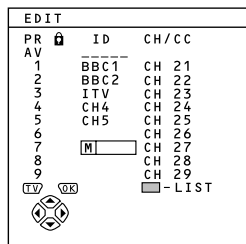

4 Press the blue button to display the ID LIST (channel name list)

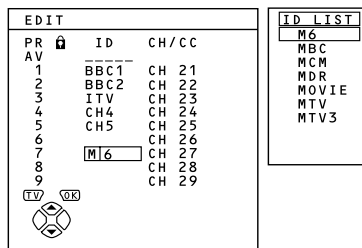

5 Press the ▼/▲ buttons to choose the channel name (ID)

To cancel the ID function:

Press the ⓘ (Information) button.

6 Press the OK button to give a channel name (ID) to a TV channel

- You can give your own unique channel name (ID) to the TV channel. When you have finished step 3, do not go to step 4. Press the ◀/▶ buttons to move the cursor, and press the ▼/▲ buttons to choose each character of the channel name (ID). Then press the OK button to register the channel name (ID) to the TV channel.

INSERT

Preparation:

- You need to find the CH number for the TV channel. Find the CH number from the "CH NUMBER" table on page 27 based on the channel number of the TV channel.

1 Press the ▼/▲ buttons to choose a Programme number (PR) for which you will register a new TV channel

2 Press the green button and start the INSERT function

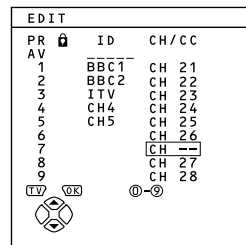

To cancel the INSERT function:

Press the ⓘ (Information) button.

3 Press the number buttons to enter the remaining CH number

The TV shifts to registration mode.

When the registration is completed, the picture of the TV channel appears on the screen.

- The CH number is a number given to each broadcast frequency that carries a TV channel. If the TV cannot detect the TV channel corresponding to the broadcast frequency indicated by the CH number, a "no-signal" picture appears.

DELETE

1 Press the ▼/▲ buttons to choose a TV channel

Every time you press the ▼/▲ buttons, the programme number (PR) changes over, and the picture of the TV channel stored in the programme number list (PR) appears on the screen.

2 Press the yellow button to delete the TV channel

The TV channel is deleted from the programme numbers (PR) list.

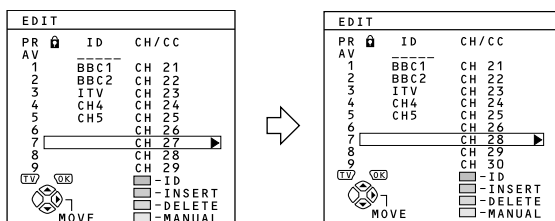

MANUAL

1 Press the ▼/▲ buttons to choose a programme number (PR) for a new TV channel

2 Press the blue button to activate the MANUAL function

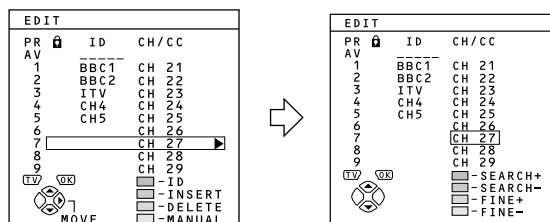

To cancel the MANUAL function:

Press the (Information) button.

3 Press the green or red button to search for a TV channel

Scanning stops when the TV finds a TV channel. Then the TV channel is displayed.

4 Press the green or red button repeatedly until the TV channel you want appears

If the TV channel reception is poor:

Press the blue or yellow button to fine-tune the TV channel.

5 Press the button and register the TV channel to a programme number (PR)

The normal EDIT menu appears.

CH NUMBER

- When you want to use the INSERT function on page 26, find the CH number corresponding to the channel number of the TV channel from this table.

If you want to know a particular TV channel's channel menu, look in TV listings magazines or contact the broadcaster.





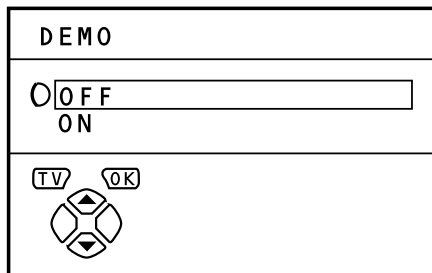

CH	Channel	CH	Channel
CH 21	E21	CH 46	E46
CH 22	E22	CH 47	E47
CH 23	E23	CH 48	E48
CH 24	E24	CH 49	E49
CH 25	E25	CH 50	E50
CH 26	E26	CH 51	E51
CH 27	E27	CH 52	E52
CH 28	E28	CH 53	E53
CH 29	E29	CH 54	E54
CH 30	E30	CH 55	E55
CH 31	E31	CH 56	E56
CH 32	E32	CH 57	E57
CH 33	E33	CH 58	E58
CH 34	E34	CH 59	E59
CH 35	E35	CH 60	E60
CH 36	E36	CH 61	E61
CH 37	E37	CH 62	E62
CH 38	E38	CH 63	E63
CH 39	E39	CH 64	E64
CH 40	E40	CH 65	E65
CH 41	E41	CH 66	E66
CH 42	E42	CH 67	E67
CH 43	E43	CH 68	E68
CH 44	E44	CH 69	E69
CH 45	E45		

DEMO



The DEMO function automatically demonstrates some of the TV functions.

To display the DEMO menu:

- 1 Press the  button to display the MENU (main menu)**
- 2 Press the / buttons to choose DEMO. Then press the  button**
- 1 Press the / buttons to choose ON**
- 2 Press the  button to complete the setting**



The DEMO function is set to ON, and the demonstration will start.

To stop the demonstration:

Press one of the buttons on the remote control.

When the DEMO function is set to ON:

Each time the TV is turned on, the demonstration starts automatically. If you do not want that to happen, cancel the DEMO function:

- 1 Display the DEMO menu again**
- 2 Press the / buttons to choose OFF**
- 3 Press the  button to cancel the DEMO function**

Other menus

■ Downloading data to a VCR

You can send to the latest programme numbers (PR) data to a VCR with the T-V LINK function.

- You can only do this when a T-V LINK compatible VCR is connected to the EXT-2 terminal.
- This only works when the T-V LINK menu is being displayed.

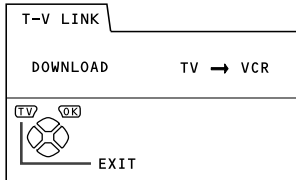

1 Turn on the VCR

2 Press the button

The data transmission begins.

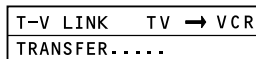

The T-V LINK menu disappears once the data transmission ends.

When the T-V LINK menu changes over to another menu:

The TV has finished its menu. This new menu is operated from the VCR. See the VCR instruction manual for what to do next.

- If "FEATURE NOT AVAILABLE" appears at the T-V LINK menu, check the following three items. Then press the  button to retry data transmission.
 - Has a T-V LINK compatible VCR been connected to the EXT-2 terminal?
 - Has the VCR power been turned on?
 - Does the SCART cable that connects the EXT-2 terminal to the T-V LINK compatible VCR have all its proper connections?

■ Using the DECODER (EXT-2) function

If you have a decoder connected to a T-V LINK compatible VCR, which in turn is connected to the EXT-2 terminal, use the DECODER (EXT-2) function to unscramble the scrambled TV channels.

1 Turn on the decoder power

2 Display the scrambled TV channel on the TV

Even if the decoder is working, a scrambled picture appears.

3 Press the button to display the MENU

The MENU (main menu) appears.

4 Press the / buttons to choose FEATURES. Then press the button.

The FEATURES menu appears.

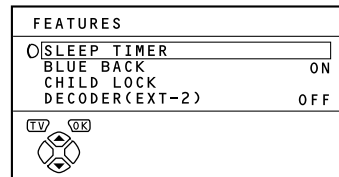

5 Press the / buttons to choose DECODER (EXT-2). Then press the / buttons to choose ON

An unscrambled picture appears.

To cancel the DECODER (EXT-2) function:

Press the / buttons to choose OFF.

6 Press the button to complete the setting

The T-V LINK menu appears.

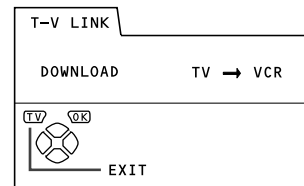

7 Follow "Downloading data to a VCR" on page 29 to transmit the programme number (PR) data to the VCR

8 If you have another TV channel you want to unscramble using a decoder, repeat steps 2 to 7.

- If the DECODER (EXT-2) function has been set to "ON" but the TV channel cannot be unscrambled, check the following:
 - Has the decoder been connected to the VCR properly according to the VCR and decoder instruction manuals?
 - Has the decoder power been turned on?
 - Can the TV channel be unscrambled with a decoder?
 - Do you need to change the VCR settings in order to connect the decoder? Confirm that the VCR is set properly by rechecking the VCR instruction manual.

Further preparation

■ Connecting external equipment

Connect the equipment to the TV, making the correct rear panel and front panel connections.

Before connecting anything:

- Read the manuals that came with the equipment. Depending on the equipment, the connection method may be different from the diagram. Also, the equipment settings may need to change depending on the connection method.
- Turn off all the equipment including the TV.
- The "Specifications" on page 34 give the details of the EXT terminals. If you are connecting equipment not listed in the following connection diagram, see the table to choose the best EXT terminal.
- Connecting cables are not supplied.

- ① VCR (composite signal)
- ② VCR (composite signal/S-VIDEO signal)
- ③ T-V LINK compatible VCR (composite signal/S-VIDEO signal)
- ④ Decoder
- ⑤ DVD player (composite signal/S-VIDEO signal)
- ⑥ DVD player (composite signal/RGB signal)
- ⑦ TV game (composite signal/RGB signal)
- ⑧ TV game (composite signal/S-VIDEO signal)
- ⑨ Headphones
- ⑩ Camcorder (composite signal/S-VIDEO signal)
- ⑪ SCART cable
- ⑫ Audio cable
- ⑬ Video cable
- ⑭ S-VIDEO cable

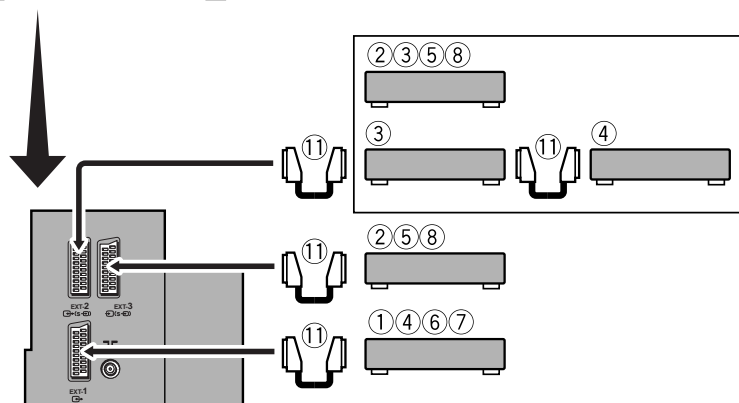
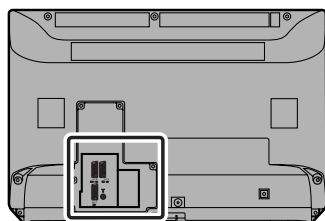
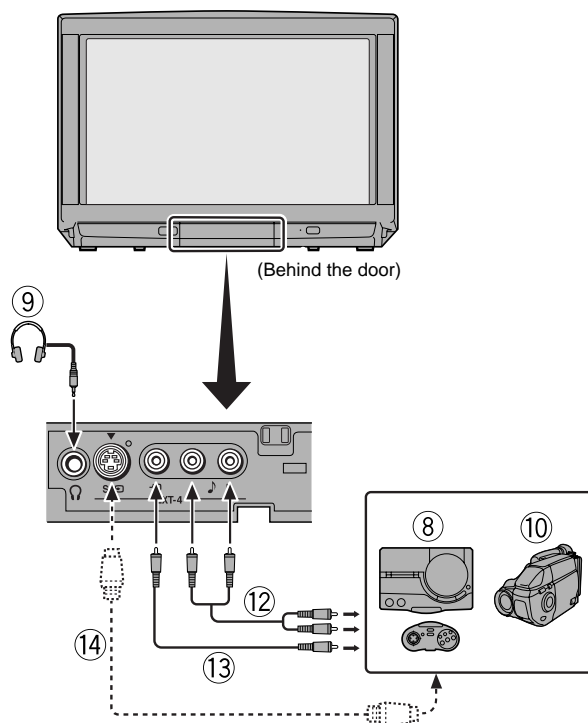

Equipment which can output the S-VIDEO signal (Y/C signal) such as an S-VHS VCR

Connect the equipment to an EXT terminal (but not the EXT-1 terminal).

You can choose between an S-VIDEO signal (Y/C signal) and a regular video signal (composite signal). For details of how to operate the equipment, see “S(S-VIDEO input)” on page 20.

T-V LINK compatible VCR

Be sure to connect the T-V LINK compatible VCR to the EXT-2 terminal. If not, the T-V LINK function will not work properly.

- When connecting a T-V LINK compatible VCR to the EXT-2 terminal, be sure to connect the decoder to the VCR. If not, the T-V LINK function may not work properly. After you have stored TV channels in the programme numbers (PR) list, set the DECODER (EXT-2) function for the programme number (PR) to ON to unscramble a scrambled TV channel. For details, see “Using the DECODER (EXT-2) function” on page 29.

Connecting headphones

Connect the headphones with a stereo mini-jack (3.5mm diameter) to the headphone jack at the TV front panel.

- When you connect the headphones, the TV speakers go off.

Video or sound signal output from the EXT-2 terminal

You can change over the output of the video/sound signal from the EXT-2 terminal. This is useful when you want to dub the video/sound from another device onto the VCR connected to the EXT-2 terminal. For details on how to do this, see “DUBBING” on page 21.

TV output from the EXT-1 terminal

The video/sound signal of a TV channel you are viewing is always output from the EXT-1 terminal.

- Changing over a programme number (PR) also changes over the TV output from the EXT-1 terminal.
- The video/sound signal from an EXT terminal cannot be output.
- Teletext programmes cannot be output.

TV buttons and parts

■ Front panel

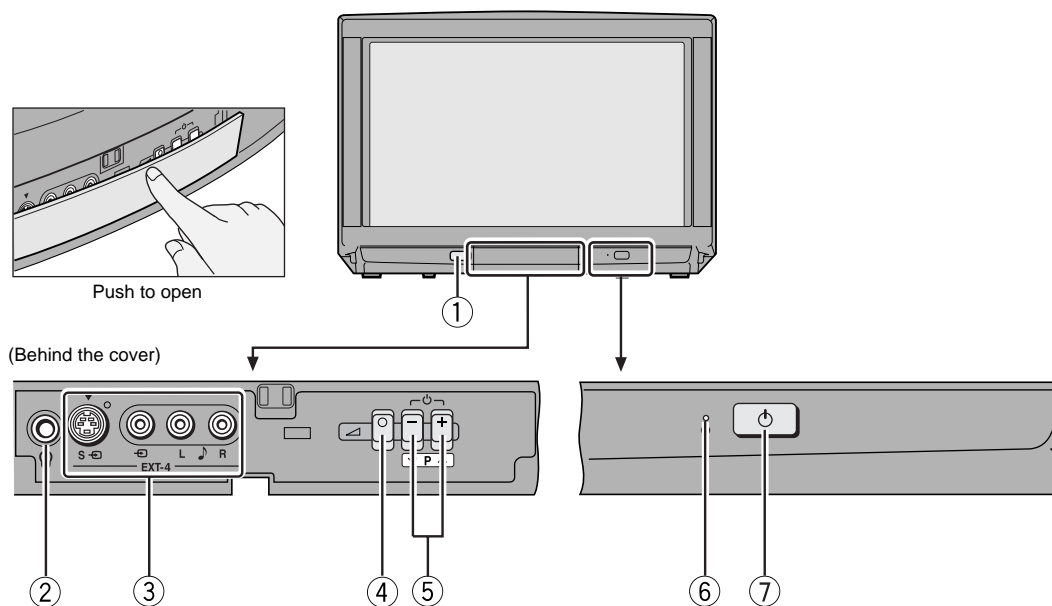

① Remote control sensor and ECO sensor	
② Headphone jack (mini jack)	page 30
③ EXT-4 terminal	pages 20 and 30
④ (Volume) button	page 10

⑤ P ∇/Δ buttons / $-/+$ buttons	page 10
⑥ Power lamp	pages 5 and 8
⑦ Main power button	pages 5 and 8

• Do not hold the TV by the front panel cover when moving the TV set. If you do, you may break the cover.

■ Rear Panel

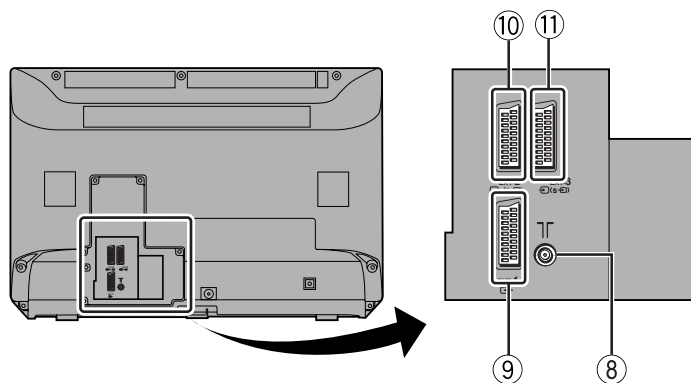

⑧ Aerial socket	page 4
⑨ EXT-1 terminal	pages 4, 20 and 30

⑩ EXT-2 terminal	pages 4, 7, 20 and 30
⑪ EXT-3 terminal	pages 20 and 30

Troubleshooting

If a problem arises while you are using the TV, please read this troubleshooting guide carefully before you ask to have the TV repaired. You may be able to fix it easily by yourself. For example, if the mains plug is disconnected from the mains outlet, or the TV aerial has problems, you may think there is a problem with the TV itself.

Important:

- This troubleshooting guide only covers problems whose causes are not easy to decide. If you have a question when you are operating a function, read the page(s) for that function carefully, not this troubleshooting guide.
- If you follow the advice in this troubleshooting guide without any success, unplug the mains plug and ask for your TV to be repaired. Do not attempt to repair the TV by yourself or to remove the rear cover of the TV.

If you cannot turn on the TV

- Is the mains plug connected to the mains outlet?
- Is the power lamp lit? If not, press the main power button.

No picture or no sound

- Have you chosen a TV channel with very poor reception? If so, the BLUE BACK function will be activated: the entire screen becomes blue, and the sound is muted. If you still want to view the TV channel, follow the description "BLUE BACK" on page 22 to try to change the BLUE BACK function setting to OFF.
- Have you connected headphones to the TV?
Connecting headphones to the TV turns off the TV speakers.

Poor picture

- If noise (snow) totally block out the picture, there may be a problem with the aerial or aerial cable. Check the following to try to solve the problem:
 - Have the TV and aerial been connected properly?
 - Has the aerial cable been damaged?
 - Is the aerial pointing in the right direction?
 - Is the aerial itself faulty?
- If the TV or aerial suffers interference from other equipment, stripes or noise may appear in the picture. Move any equipment such as an amplifier, personal computer, or a hair drier, that can cause interference away from your TV. Or try moving the TV. If the aerial suffers interference from a radio tower or high-voltage wire, please contact your local dealer.
- If the TV suffers interference from signals reflecting from mountains or buildings, double-pictures (ghosting) will occur. Try to change the aerial's direction or replace it with one with better directionality.
- Are your COLOUR SYSTEM settings correct? Follow the description "COLOUR SYSTEM" on page 18 to try to solve the trouble.
- Have the COLOUR and BRIGHT settings been adjusted properly? Follow the description "Picture adjustment" on page 17 to try to adjust them properly.
- Videotaping teletext is not recommended because it may not record correctly.
- When a white and bright still image (such as a white dress) is displayed on the screen, the white part may look as if it is coloured. This is unavoidable due to the nature of the picture tube itself, and not due to a TV failure. When the picture disappears from the screen, the unnatural colours will also disappear.



Poor sound

- Have you adjusted BASS or TREBLE properly? If not, follow the description "Sound adjustment" on page 19.
- When TV channel reception is poor, it can be hard to hear stereo or bilingual sound. In this case, follow the description "STEREO / I•II" on page 19 to hear the sound more easily by changing it to a mono sound.

If the TV does not respond to the remote control

- Have the batteries of the remote control worn out? Follow the description "Putting batteries into the remote control" on page 4 and replace them with new batteries.
- Have you attempted to use the remote control from the sides or rear of the TV or from more than seven metres away from the TV? Use the remote control in the front of your TV or from less than seven metres away.
- When you are viewing a teletext programme, you cannot operate the menus. Press the  button to return to the ordinary TV programme, and then try operating the menus.
- If the TV will not respond suddenly, press the main power button on the TV and turn off the main power. Press the main power button again to turn on the TV. If the TV returns to a normal state, it is not a failure.

Other issues

- When the SLEEP TIMER function operates, the TV is automatically turned off. If the TV is turned off suddenly, try to press the  (standby) button to turn on the TV once again. If the TV goes back to normal, there is no problem.
- When a WSS signal is included in the broadcast signal or the signal from an external device, or when the TV is receiving a control signal from an external device, the ZOOM mode will change automatically. When you want to return to the previous ZOOM mode, press the  button to choose the ZOOM mode again.
- If you bring a magnetised device such as a speaker near to your TV, the picture may be warped or unnatural colors now appear at the corners of the screen. In this case, keep the device away from your TV. If speakers cause this to happen, use magnetic-shielded speakers instead.
- The TV may make a crackling sound due to a sudden change in temperature. The picture or sound may be normal. If you hear crackling sounds frequently while you are viewing the TV, there may be other causes. As a precaution, ask your service technician to inspect it.
- Touching the screen may cause you to feel a slight electric shock due to its static electricity. This is unavoidable due to the construction of the picture tube. It is not a problem with the TV. You can rest assured that this static discharge is not harmful.

Specifications

Item	Model	AV28WT5EK*	AV24WT5EK*
Broadcasting systems		CCIR I	
Colour systems		PAL • The EXT terminals also support the NTSC 3.58/4.43 MHz system.	
Channels and frequencies		E21-E69	
Sound-multiplex systems		NICAM (I) system	
Teletext systems		FLOF (Fastext), WST (World Standard Text)	
Power requirements		220 - 240 V AC, 50 Hz	
Power consumption		Maximum: 156 W, Average: 122 W, Standby: 0.8 W	Maximum: 127 W, Average: 92 W, Standby: 0.8 W
Picture tube size		Viewable area 66 cm (measured diagonally)	Viewable area 56 cm (measured diagonally)
Audio output		Rated Power output: 5 W + 5 W	
Speakers		(10 cm × 3 cm) oval × 2	
EXT-1 terminal		Euroconnector (21-pin, SCART) • Video input, Audio L/R inputs and RGB inputs are available. • TV broadcast outputs (Video and Audio L/R) are available.	
EXT-2 terminal		Euroconnector (21-pin, SCART) • Video input, S-VIDEO (Y/C) input and Audio L/R inputs are available. • Video and Audio L/R outputs are available. • T-V LINK functions are available.	
EXT-3 terminal		Euroconnector (21-pin, SCART) • Video input, S-VIDEO (Y/C) input and Audio L/R inputs are available.	
EXT-4 terminal		RCA connectors × 3 S-VIDEO connector × 1 • Video input, S-VIDEO (Y/C) input and Audio L/R inputs are available.	
Headphone jack		Stereo mini-jack (3.5 mm in diameter)	
Dimensions (W × H × D)		716 mm × 489 mm × 496 mm	645 mm × 427 mm × 443 mm
Weight		34.2 kg	23.1 kg
Accessories		Remote control unit × 1 (RM-C55 (Silver) or RM-C51 (Black) is supplied.) AAA/R03 dry cell battery × 2	

* A basic model number. The actual model number may have characters added (such as "S" for silver) showing the colour of the TV set.

We may change the design and specifications without notice.

Pictures displayed on the screen using this TV's ZOOM functions should not be shown for any commercial or demonstration purpose in public places (cafes, hotels, etc.) without the consent of the owners of copyright of the original picture sources, as this would be an infringement of copyright.

JVC

Free Manuals Download Website

<http://myh66.com>

<http://usermanuals.us>

<http://www.somanuals.com>

<http://www.4manuals.cc>

<http://www.manual-lib.com>

<http://www.404manual.com>

<http://www.luxmanual.com>

<http://aubethermostatmanual.com>

Golf course search by state

<http://golfingnear.com>

Email search by domain

<http://emailbydomain.com>

Auto manuals search

<http://auto.somanuals.com>

TV manuals search

<http://tv.somanuals.com>