



## COLOR TELEVISION

**AV-14FN15**  
**AV-20NN15**

### Contents

Knowing your TV's features .....	2
Remote control buttons and basic functions .	3
TV buttons and functions .....	5
Setting up your TV .....	6
Basic setting for picture .....	8
Advanced setting for picture .....	9
Original features for picture .....	9
Advanced setting for sound .....	9
Favorite channel and video setting .....	10
Customized setting .....	11
TV channel presetting .....	12
Additional preparation .....	13
Troubleshooting .....	13
Specifications .....	14

## *INSTRUCTIONS*

Thank you for buying this JVC color television.

To make sure you understand how to use your new TV, please read this manual thoroughly before you begin.

## Safety Instructions

---

**WARNING: TO PREVENT FIRE OR SHOCK HAZARD, DO NOT EXPOSE THIS APPLIANCE TO RAIN OR MOISTURE.**

**CAUTION: TO ENSURE PERSONAL SAFETY, OBSERVE THE FOLLOWING RULES REGARDING THE USE OF THIS TV.**

- 1 Operate only from the power source indicated on the rear of the TV.
- 2 Avoid damaging the power cord and AC plug. When unplugging the TV, grasp the AC plug. Do not pull on the power cord.
- 3 Never block or cover the cabinet ventilation openings. Never install the TV where good ventilation is unattainable. When installing this TV, leave space for ventilation around the TV more than the minimum distances as shown in the diagram.
- 4 Do not allow objects or liquid into the cabinet openings.
- 5 In the event of a fault, unplug the unit and call a JVC service technician. Do not attempt to repair it yourself or remove the rear cover.
- 6 The surface of the TV screen is easily damaged. Be very careful with it when handling the TV. Should the TV screen become soiled, wipe it with a soft dry cloth. Never rub it forcefully. Never use any cleaner or detergent on it.
- 7 If you are not going to use this TV for a long period of time, be sure to disconnect the AC plug from the AC socket.
- 8 The apparatus shall not be exposed to dripping or splashing and that no objects filled with liquids, such as vases, shall be placed on the apparatus.

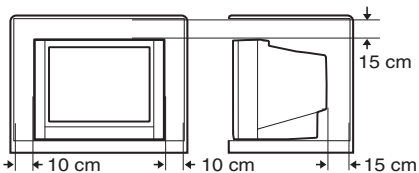

## Knowing your TV's functions

---

### Main features

Function	Description
<b>Closed caption</b>	You can display dialog on the screen from TV broadcasts with Closed caption system. You also may be able to display some information in text form if available.
<b>Favorite CH (Channel)</b>	You can register up to four favorite channels for quick recall with one press.
<b>AI Volume</b>	TV adjusts automatically the volume to the same level for all TV channels to avoid sudden change of the volume when selecting different TV channel.
<b>VNR</b>	You can reduce the picture noise when viewing noisy TV programs or video sources.
<b>White balance</b>	You can choose one of three tones of white to match to the video source such as movie, sports, etc. Changing White balance affects the appearance of all other colors on the screen.
<b>Child lock</b>	To prevent accidental operation by your children, you can disable the control buttons on the TV.

# Remote control buttons and basic functions

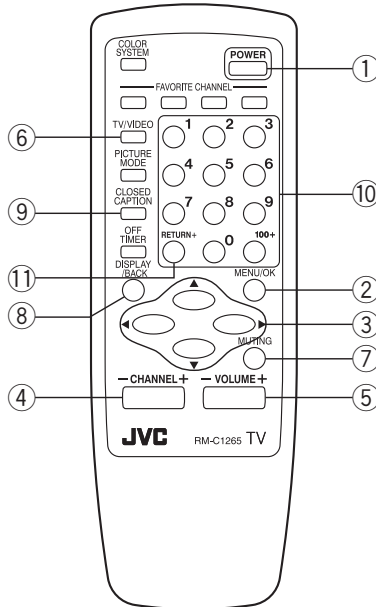

RM-C1265

No. Press	To
① POWER	Turn on or off the TV from standby mode.
② MENU/OK	Display menu and confirm selected function.
③ ▲/▼/◀/▶	Select and adjust menu function.
④ CHANNEL -/+	Select the desired channel number.
⑤ VOLUME -/+	Adjust the volume level.
⑥ TV/VIDEO	Select TV or VIDEO terminal input.
⑦ MUTING	Turn off the volume. Press this button again to resume the volume.
⑧ DISPLAY/BACK	Display the program number or video terminal number on the screen. On the other hand, you can use this button to return to the previous menu.
⑨ CLOSED CAPTION	Display information in text which are broadcasted by some TV channels.
⑩ 0-9, 100+	Select the program number. For three-digit program numbers, press 100+, then press the number button.
⑪ RETURN+	<p>a) Return to the frequently viewed channels with one touch.</p> <ol style="list-style-type: none"> <li>1 Choose the channel you want to register.</li> <li>2 Press and hold RETURN+ button until "RETURN PLUS PROGRAMMED!" appears. To cancel, press and hold RETURN+ button until "RETURN PLUS CANCELED!" appears.</li> </ol> <p>b) Return to the previously viewed channel, if you have not set or have canceled the Return channel as above.</p>

## Remote control buttons and basic functions

### How to operate menus and menu locations

TO	Operation	Note
Display the MENU.	Press the MENU/OK button ②.	To exit the MENU, press the DISPLAY/BACK button* ⑧ or choose EXIT menu.
Display the top menu.	Press ▲/▼ buttons ③ to choose a menu title. Then press MENU/OK button ②.	Press ▼ button ③ to display the next page for more functions.
Display the 2nd menu.	Press ▲/▼ buttons ③ to choose a menu title. Then press MENU/OK button ②.	
Display the 3rd menu.	Press ▲/▼ buttons ③ to choose a menu title. Then press MENU/OK button ②.	
Return to the previous menu.	Press the DISPLAY/BACK button* ⑧.	-
Choose the setting of a function.	Press ▲/▼ buttons ③ to choose a function. Then press the ◀▶ buttons ③ to change the setting.	Press the MENU/OK button ② to exit from the menu.
Adjust the effect level of a function.	Press ▲/▼ buttons ③ to choose a function. Then press the ◀▶ buttons ③ to adjust the effect level.	
Display the sub menu of a function.	Press ▲/▼ buttons ③ to choose a function. Then press MENU/OK button ② to display the sub menu.	-

The following chart shows locations of functions in menus.

In this manual, location of a function is described as follows:

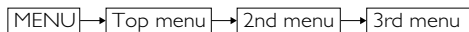

**Note:** Some functions have the 4th menu as the sub-menus.

\*To exit the menu, the on screen display will show BACK indicated in blue. But it doesn't refer to the blue button on the remote control. Instead, it refers to the DISPLAY/BACK button on the remote control.

	Top menu	2nd menu	Location	3rd menu	Location	
MENU	INPUT	EXT. INPUT	P.11	-	-	
		DISPLAY	P.11	-	-	
		CLOSED CAPTION	P.9	-	-	
	PICTURE * If you want to adjust PICTURE SETTING menu, you must set PICTURE MODE menu to USER.	PICTURE MODE	PICTURE MODE	P.8	-	-
			PICTURE SETTING	P.8	-	-
			WHITE BALANCE	P.8	-	-
			PICTURE FEATURES	-	VNR	P.11
				FAVORITE CH SETTING	P.10	
				VIDEO SETTING	P.10	
				COLOR SYSTEM	P.8	
	SOUND	AI VOLUME	P.9	-	-	
	FEATURES	OFF TIMER	P.11	-	-	
		CHILD LOCK	P.11	-	-	
	INSTALL	AUTO PROGRAM	P.12	-	-	
		CHANNEL SUMMARY	P.12	-	-	
		BLUE BACK	P.9	-	-	
		AUTO SHUTOFF	P.11	-	-	
	EXIT	-	-	-	-	

# TV buttons and functions

The following illustrations are for AV-14FN15 and AV-20NN15 only, which are used for explanation purposes. Your TV may not look exactly like the illustration.

## Front of the TV

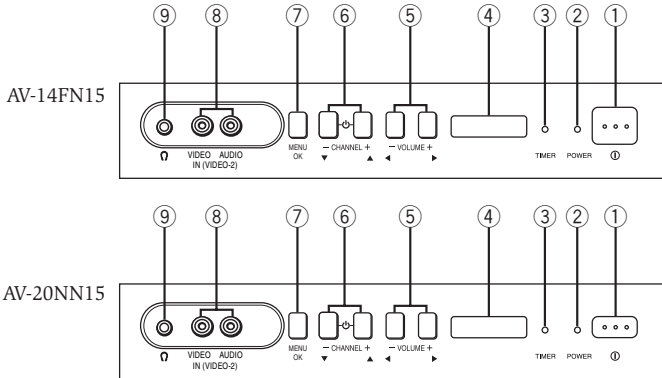

## Rear of the TV

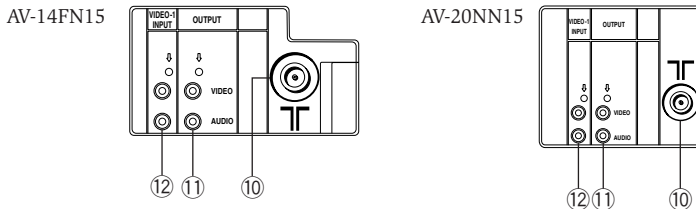

No. Button/terminal	Description
① ① (main power)	Press to turn on or turn off the TV's main power.
② Power lamp	Indicate the TV is being turned on or off. No color : TV's main power is being turned off. Red : TV's main power is being turned on.
③ TIMER lamp	Lights when the TV is in the OFF TIMER mode.
④ Remote control sensor	
⑤ VOLUME -/+	Press to adjust the volume level.
⑥ CHANNEL -/+	Press to select the desired channel.
⑦ MENU	Press to display the menu.
⑧ IN (VIDEO-2)	Video and audio input jacks for VIDEO-2 mode.
⑨ $\Omega$	Headphone jack.
⑩ $\Gamma$	Antenna socket.
⑪ OUTPUT	Video and audio output jacks.
⑫ VIDEO-1 INPUT	Video and audio input jacks for VIDEO-1 mode.

## How to operate the menus with the TV button

TV button	Work as same as the button on the remote control unit	Note
MENU	MENU/OK button	To display main menu and exit menu after finish setting.
CHANNEL -/+	$\nabla/\blacktriangle$ button	To select menu function.
VOLUME -/+	$\blacktriangleleft/\blacktriangleright$ button	To adjust the desired function.

# Setting up your TV

## CAUTION

- Turn off the equipment including the TV before connecting.

### 1 Connecting the antenna

#### To install rod antenna

Install into the top-rear holder. Once installed, it cannot be removed.

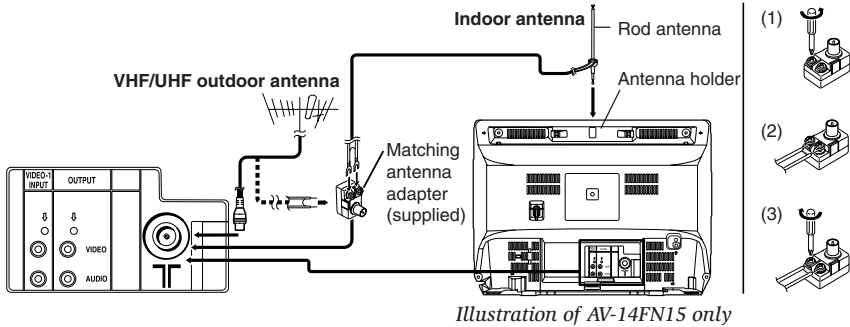

If you connect a VCR, connect the antenna output jack of your VCR and the antenna jack on the TV with the antenna cable. Then connect the output jacks of your VCR and the VIDEO-1 input jacks of the TV with the video cable and audio cables. For details, see the manual of your VCR.

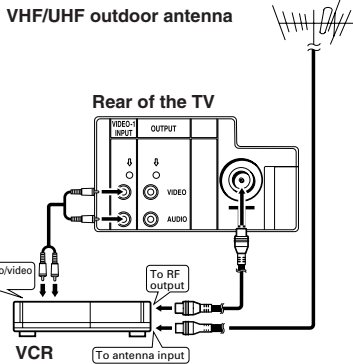

The illustration shown is just a sample. It may not be same as your TV.

### 2 Connecting the compatible AC plug to the AC outlet.

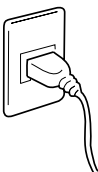

### 3 Inserting batteries into the remote control.

Insert two batteries by following the  $\oplus$  and  $\ominus$  polarities and inserting the  $\ominus$  end first.

#### CAUTION:

Follow the cautions printed on the batteries.

#### Notes:

- Use AA/R6/UM-3 dry cell batteries.
- If the remote control does not work properly, install new batteries. The supplied batteries are for testing, not regular use.

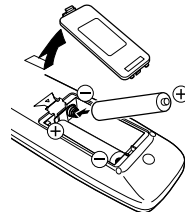

### 4 Turn on the TV by pressing the main power button.

JVC logo appears on the screen.

**JVC**

## Setting up your TV (continued)

### 5 Making the initial settings

Set up your TV by pressing MENU/OK button or waiting for 15 seconds, then the TV will operate by following steps as below:

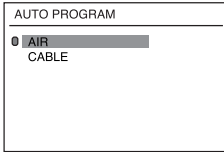

- Press ▲/▼ button to select AIR or CABLE, press the MENU/OK button. TV will start searching for the channels.

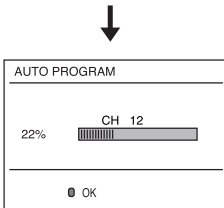

To stop AUTO PROGRAM, press MENU/OK button.

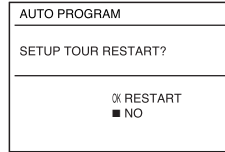

- Press the red button to cancel the SETUP TOUR RESTART function. If you want to make initial settings again when the next time you turn on the TV, press the MENU/OK button to activate the SETUP TOUR RESTART function.

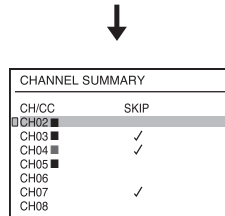

- To complete the initial setting, press the MENU/OK button. To set undesired channels to be skipped, see page 12.

- If the JVC logo does not appear, use AUTO PROGRAM function to make the initial settings. This function is located in the INSTALL menu.
- If the JVC logo appears, although you had made the initial settings, press the TV/VIDEO button to exit from initial settings.

# Basic setting for picture

## COLOR SYSTEM

You can select the appropriate color system when the picture is not clear or no color appears.

Press the COLOR SYSTEM button to select a setting.

In TV mode: **NTSC 3.58 MHz (Fixed)**

In VIDEO mode:

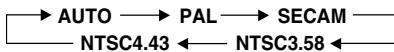

To operate this function with a menu:

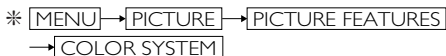

For the color system in each country or region, see the table below:

Area	Country or Region	System
Asia, Middle East	Bahrain, Kuwait, Oman, Qatar, United Arab Emirates, Yemen, etc. Indonesia, Malaysia, Singapore, Thailand, India, etc.	PAL
	China, Vietnam, etc.	PAL
	Hong Kong, etc.	PAL
	Islamic Republic of Iran, Lebanon, Saudi Arabia, etc.	SECAM
	Philippines, Taiwan, Myanmar, etc.	NTSC
Europe	Russia, etc.	SECAM
	Czech Republic, Poland, etc.	PAL
	Germany, Holland, Belgium, etc.	PAL
	UK, etc.	PAL
Oceania	Australia, New Zealand, etc.	PAL
Africa	Republic of South Africa, etc.	PAL
	Nigeria, etc.	PAL
	Egypt, Morocco, etc.	SECAM

## PICTURE MODE

You can choose the desired picture setting with one touch.

Press the PICTURE MODE button to select a setting.

SOFT	Softens contrast and sharpness.
BRIGHT	Heightens contrast and sharpness.
STANDARD	Standard picture setting.
USER	You can change this picture setting as you like. Select USER and adjust following items in the PICTURE SETTING menu. (PICTURE, BRIGHT, DETAIL, COLOR, TINT*)

\*TINT can only be adjusted in NTSC system.

To operate this function with a menu:



To return the USER setting to the default, press the blue button when the PICTURE SETTING menu appears.

## Adjusting the picture - USER

You can adjust the desired picture setting when selecting USER in PICTURE MODE.

**1** Select the USER in PICTURE MODE under PICTURE menu.



**2** Select the PICTURE SETTING in PICTURE menu, then adjust the setting.



PICTURE	◀ : Lower	▶ : Higher
BRIGHT	◀ : Darker	▶ : Brighter
DETAIL	◀ : Softer	▶ : Higher
COLOR	◀ : Lighter	▶ : Deeper
TINT*	◀ : Reddish	▶ : Greenish

\*TINT can only be adjusted in NTSC system.

## WHITE BALANCE

You can change the white balance of the picture to better match the type of video being viewed. Select the WHITE BALANCE in the PICTURE menu, then choose the desired setting.



NORMAL	Normal white balance.
COOL	Bluish white.
WARM	Reddish white.

\* About the basic operations of the menu, please see the "How to operate menus and menus locations" on page 4.



## Advance setting for picture

---

### BLUE BACK

You can set the TV to automatically change to a blue screen and mute the sound if the signal is weak or absent, or when there is no input from an antenna.

Select the BLUE BACK in the INSTALL menu, then choose ON or OFF.

\* [MENU] → [INSTALL] → [BLUE BACK]

If you wish to continue viewing the poor picture, cancel the BLUE BACK function.

## Original features for picture

---

### CLOSED CAPTION

If they are included in a program, you can view closed captions or text information.

Press the CLOSED CAPTION button to select a setting.

→ OFF → CLOSED CAPTION → TEXT

To operate this function with a menu:

- 1 Select the CLOSED CAPTION in INPUT menu, then choose "CAPTION" or "TEXT".

\* [MENU] → [INPUT] → [CLOSED CAPTION]

- 2 Press the ◀▶ button to select the desired caption or text channel.

## Advanced setting for sound

---

### AI VOLUME

You can adjust the volume of all the channels and video inputs to the same level automatically.

Select the AI VOLUME in SOUND menu, then choose ON or OFF.

\* [MENU] → [SOUND] → [AI VOLUME]

\* About the basic operations of the menu, please see the "How to operate menus and menu locations" on page 4.

# Favorite channel and video setting

## To register the favorite channel

You can register and recall 4 favorite channels by using the color buttons (red, green, yellow, blue).

- 1 In TV mode, select a TV channel (CH02-CH69, CC01-CC125) you desired to register.
- 2 Press and hold a color button for 3 seconds or more.  
"FAVORITE CHANNEL ■ PROGRAMMED!" appears on the screen and current channel is registered.
- 3 To register other favorite channels, repeat Step 1 to 2.

To recall the favorite channel, press the color button.

When the TV is in menu mode, favorite channel function is not available.

## To adjust favorite channel setting (FAVORITE CH SETTING)

You can adjust the picture settings for the favorite channels.

- 1 Display the PICTURE menu and select FAVORITE CH SETTING in PICTURE FEATURES menu.  
\* MENU → PICTURE → PICTURE FEATURES → FAVORITE CH SETTING
- 2 Select FAVORITE CHANNEL in FAVORITE CH SETTING menu, then choose the desired favorite channel.  
\* FAVORITE CH SETTING → FAVORITE CHANNEL

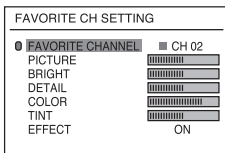

- 3 Select EFFECT, then press ◀▶ button to choose ON.  
To cancel the settings, choose OFF.
- 4 Select the desired item that you wish to adjust.

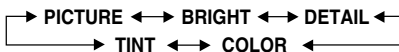

- 5 Press the MENU/OK button to exit the menu.

## To adjust the video setting (VIDEO SETTING)

You can adjust the picture settings for video inputs.

- 1 Display the PICTURE menu and select VIDEO SETTING in PICTURE FEATURES menu.  
\* MENU → PICTURE → PICTURE FEATURES → VIDEO SETTING
- 2 Select VIDEO STATUS in VIDEO SETTING menu, then choose the desired video input.

\* VIDEO SETTING → VIDEO STATUS

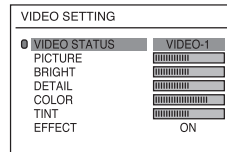

- 3 Select EFFECT, then press ◀▶ button to choose ON. To cancel the settings, choose OFF.
- 4 Select the desired item that you wish to adjust.

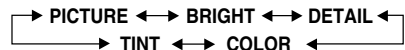

- 5 Press the MENU/OK button to exit the menu.

\* About the basic operations of the menu, please see the "How to operate menus and menu locations" on page 4.

# Customized setting

## VNR

You can reduce the picture noise.

Select the VNR in the PICTURE FEATURES menu under PICTURE menu, then choose a setting of VNR function.

\* [MENU] → [PICTURE] → [PICTURE FEATURES]  
→ [VNR]

OFF	VNR is turned off.
AUTO	Effect of VNR is automatically controlled.
MIN	Effect of VNR becomes minimum level.
MAX	Effect of VNR becomes maximum level.

If you select MAX, the picture becomes softer even if the original picture is sharp.

## CHILD LOCK

You can disable the front control buttons of the TV.

Select the CHILD LOCK in the FEATURES menu, then choose ON or OFF.

\* [MENU] → [FEATURES] → [CHILD LOCK]

## OFF TIMER

You can set the TV to turn off automatically to standby mode after a set time.

Press the OFF TIMER button to select a desired period of time.

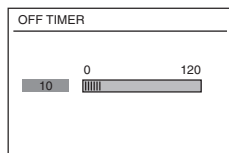

You can set the period of time to a maximum of 120 minutes in 10-minute steps.

To operate this function with a menu:

\* [MENU] → [FEATURES] → [OFF TIMER]

When the elapsed of time left one minute, "GOOD NIGHT!" appears on the screen.

You can display the OFF TIMER menu again to confirm or change the remaining time.

## AUTO SHUTOFF

You can set the TV to turn off automatically when no signal is received for about 15 minutes or longer after the end of a broadcast.

Select AUTO SHUTOFF in INSTALL menu, then choose ON or OFF.

\* [MENU] → [INSTALL] → [AUTO SHUTOFF]

The AUTO SHUTOFF function does not turn off the TV's main power.

The AUTO SHUTOFF function is not available in video mode.

## EXT. INPUT (TV/VIDEO)

You can select TV or video terminal input with one touch.

Press the TV/VIDEO button to select an input.

To operate this function with a menu:

\* [MENU] → [INPUT] → [EXT.INPUT]

## DISPLAY

You can display the program number, video terminal number on the screen.

Press the DISPLAY button to display the indication on screen.

To operate this function with a menu:

\* [MENU] → [INPUT] → [DISPLAY]

\* About the basic operations of the menu, please see the "How to operate menus and menu locations" on page 4.

# TV channel presetting

## To register the TV channels automatically

You can register the TV channels into the TV's channel list automatically.

**1** Display the INSTALL menu.

\* [MENU] → [INSTALL]

**2** Choose AUTO PROGRAM, then press the MENU/OK button.

**3** Press the ▲/▼ button to select AIR or CABLE, then press the MENU/OK button. AUTO PROGRAM function starts, and the channels received are registered automatically.

**4** "SETUP TOUR RESTART?" appears.

To start the SETUP TOUR	Press the MENU/OK button. Then proceed to step 5 of "Setting up your TV" on page 7.
-------------------------	---

To skip the SETUP TOUR	Press the Red button.
------------------------	-----------------------

**5** The CHANNEL SUMMARY menu appears.

For details of "SETUP TOUR", see page 7.

## CHANNEL SUMMARY

You can set undesired channels to be skipped. Channels set to be skipped cannot be selected by the CHANNEL -/+ button.

**1** Display the INSTALL menu.

\* [MENU] → [INSTALL]

**2** Choose CHANNEL SUMMARY, then press the MENU/OK button. CHANNEL SUMMARY menu appears.

CHANNEL SUMMARY	
CH/CC	SKIP
CH02	
CH03	✓
CH04	✓
CH05	
CH06	
CH07	✓
CH08	

**3** Choose the channel which you want to skip. The skip can be set to all channels of AIR (CH02-CH69) and CABLE (CC01-CC125).

**4** Press the yellow button to skip the channel. To cancel the skip, press the blue button.

**5** Press the MENU/OK button to exit the menu.

\* About the basic operations of the menu, please see the "How to operate menus and menu locations" on page 4.

## Additional preparation

The illustrations shown in this section are for AV-20NN15 only, which are used for explanation purposes. Your TV may not look exactly the same as the illustration.

### Before connecting

- Read the manuals provided with the devices for the proper connection.
- Turn off all the devices including the TV.
- Note that connecting cables are not supplied.

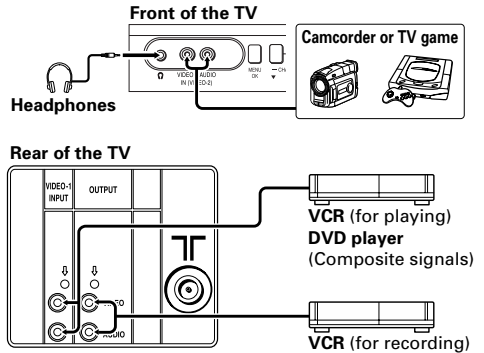

## Troubleshooting

If a problem occurs when you are using the TV, check the following troubleshooting guide before calling for repair.

No picture, no sound	<ul style="list-style-type: none"> <li>• Deactivate the BLUE BACK function if it is turned on.</li> </ul>	Cannot operate the remote control	<ul style="list-style-type: none"> <li>• The batteries may be exhausted. Replace with new batteries (see page 6).</li> <li>• Ensure that you are operating the remote less than seven meters from the front of your TV.</li> </ul>
Snowy picture	<ul style="list-style-type: none"> <li>• Check the antenna cable and its connection with the TV.</li> </ul>	Cannot operate the menus	<ul style="list-style-type: none"> <li>• Press TV/VIDEO button to return to TV mode and try operating the menus.</li> </ul>
Stripes appear on the picture	<ul style="list-style-type: none"> <li>• Interference occurs caused by other devices such as an amplifier, personal computer, or a hair drier. Move such devices away from your TV.</li> </ul>	Cannot operate the front control buttons	<ul style="list-style-type: none"> <li>• Deactivate the CHILD LOCK function if it is turned on (see page 11).</li> </ul>
Double-pictures (ghosting) occur	<ul style="list-style-type: none"> <li>• Interference occurs caused by signal reflecting from mountains or building. Try to adjust the antenna direction or use a better directionality antenna.</li> </ul>	TV turns off suddenly	<ul style="list-style-type: none"> <li>• This may due to the AUTO SHUT OFF function is activated. Press the POWER button to turn on the TV.</li> </ul>
Poor picture	<ul style="list-style-type: none"> <li>• Choose the appropriate color system. Refer to "COLOR SYSTEM" on page 8.</li> <li>• Adjust the COLOR or BRIGHT setting. Refer to "Adjusting the picture - USER" on page 8.</li> </ul>	Color patches appear at the corner of the screen	<ul style="list-style-type: none"> <li>• This may due to a magnetized device such as a speaker near to your TV. Keep the device apart from your TV. Alternately, you can also use the magnetically shielded speaker.</li> </ul>
White and bright still image look as if it were colored	<ul style="list-style-type: none"> <li>• Inevitable phenomenon due to the nature of the picture tube. This is not a malfunction.</li> </ul>	Image takes a short period to be displayed	<ul style="list-style-type: none"> <li>• A short periode of time is required to stabilize the image. This is not a malfunction.</li> </ul>
Top of the image from software products or video tape is distorted	<ul style="list-style-type: none"> <li>• This is due to the condition of the video signal whereby the image was not recorded properly. This is not a malfunction.</li> </ul>	TV emits a crackling sound	<ul style="list-style-type: none"> <li>• This is due to a sudden change in temperature and it is not a malfunction. If the crackling sound is too frequent, request your service technician for inspection.</li> </ul>
		Feel a slight electric shock when touching the TV screen	<ul style="list-style-type: none"> <li>• This is due to the static electricity of the picture tube and it will not harm the human body. This is not a malfunction.</li> </ul>

# Specifications

---

## TV RF systems

M

## Color systems

TV mode: NTSC 3.58 MHz

VIDEO mode: PAL, SECAM, NTSC 3.58 MHz, NTSC 4.43 MHz

## Receiving channels

VHF low channel (VL), VHF high channel (VH), UHF channel (U)

Receives cable channels in mid band, super band and hyper band.

## Power requirements

AC 110 to 240 V, 50/60 Hz

## External input / output

VIDEO-1: VIDEO input, AUDIO input

VIDEO-2: VIDEO input, AUDIO input,

OUTPUT: VIDEO output, AUDIO output

Headphone jack: stereo mini jack (3.5 mm diameter,  
sound is monaural)

## Viewing Screen size (Visible area)

AV-14FN15: 335.4 mm

AV-20NN15: 480.0 mm

***Design and specifications are subject to change without notice.***

**MEMO**

---



# JVC



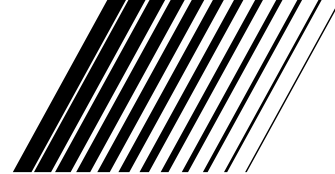

## COLOR TELEVISION

**AV-21CA15**

**AV-21YA15**

**AV-14FT15**

EQUALIZER • CINEMA SURROUND • COMPONENT INPUT

### Contents

Knowing your TV's features .....	3
Remote control buttons and basic functions .....	4
TV buttons and functions .....	6
Setting up your TV .....	7
Basic setting for picture .....	9
Advanced setting for picture .....	11
Basic setting for sound .....	12
Advanced setting for sound .....	13
Favorite channel and video setting .....	14
Customized setting .....	15
TV channel presetting .....	17
Additional preparation .....	18
Troubleshooting .....	19
Specifications .....	20



## INSTRUCTIONS

GGT0071-001A-H

Thank you for buying this JVC color television.  
To make sure you understand how to use your new TV, please read this manual thoroughly before you begin.

**WARNING: TO PREVENT FIRE OR SHOCK HAZARD, DO NOT EXPOSE THIS APPLIANCE TO RAIN OR MOISTURE.**

**CAUTION: TO ENSURE PERSONAL SAFETY, OBSERVE THE FOLLOWING RULES REGARDING THE USE OF THIS TV.**

- 1 Operate only from the power source indicated on the rear of the TV.
- 2 Avoid damaging the power cord and mains plug. When unplugging the TV, grasp the mains plug. Do not pull on the power cord.
- 3 Never block or cover the ventilation openings.  
Never install the TV where good ventilation is unattainable.  
When installing this TV, leave spaces for ventilation around the TV of more than the minimum distances as shown.

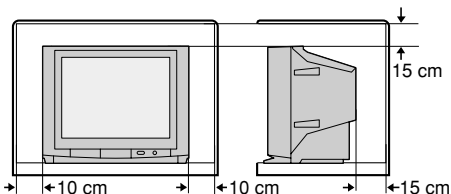

- 4 Do not allow objects or liquid into the cabinet openings.
- 5 In the event of a fault, unplug the unit and call a service technician. Do not attempt to repair it yourself or remove the rear cover.
- 6 The surface of the TV screen is easily damaged. Be very careful with it when handling the TV. Should the TV screen become soiled, wipe it with a soft dry cloth. Never rub it forcefully. Never use any cleaner or detergent on it.

- 7 If you are not going to use this TV for a long period of time, be sure to disconnect the AC plug from the AC socket.
- 8 The apparatus shall not be exposed to dripping or splashing and that no objects filled with liquids, such as vases, shall be placed on the apparatus.

**WARNING: <AV-21YA15 only>**

**A REMOVABLE PLASTIC COVER IS FIXED TO THE TELEVISION'S FRONT AUDIO/VIDEO CONNECTOR. TO PREVENT THIS COVER FROM BEING ACCIDENTALLY SWALLOWED BY BABIES OR CHILDREN, REMOVE IT FROM THE TELEVISION AND STORE IT IN A SAFE PLACE. IF THE COVER IS SWALLOWED SEEK THE ADVICE OF A DOCTOR IMMEDIATELY.**

# Knowing your TV's features

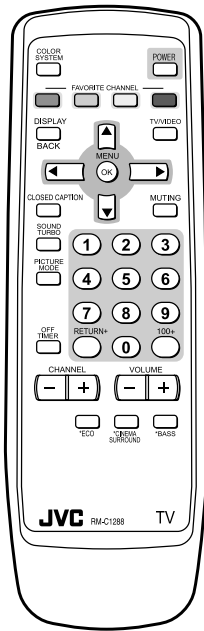

## Main features

<b>MTS</b>	You can listen to the stereo sound or SAP from TV program broadcasting by MTS system. (SAP: Second audio program.)
<b>CLOSED CAPTION</b>	You can display dialog on the screen from TV broadcasting with Closed Caption system. You may also be able to display some information in text form if available.
<b>FAVORITE CH (Channel)</b>	You can register up to four favorite channels for quick recall with one press.
<b>AI VOLUME</b>	TV adjusts the volume automatically to the same level for all TV channels to avoid sudden change of the volume when selecting different TV channel.
<b>VNR</b>	You can reduce the picture noise when viewing noisy TV programs or video sources.

## Confirm your TV's functions

Some functions shown in this remote control may not be available for your TV.

When you press a button concerned to a function that is not available for your TV, it does not work and the logo "Ø" appears on the screen. For a function that is not available for your TV, it is not displayed in the menu.

# Remote control buttons and basic functions

No.	Press	To
1	POWER	Turn on or off the TV from standby mode.
2	MENU/OK	Display menu and confirm selected function.
3	▲ / ▼ / ◀ / ▶	Select and adjust menu function.
4	CHANNEL +/-	Select the desired channel number.
5	VOLUME +/-	Adjust the volume level.
6	TV/VIDEO	Select TV or video terminal input.
7	MUTING	Turn off the volume. Press this button again to resume the volume.
8	DISPLAY/BACK	Display the program number or video terminal number on the screen. On the other hand, you can use this button to return to the previous menu.
9	CLOSED CAPTION	Display information in text which are broadcasted by some TV channels.
10	0~9, 100+	Select the program number. For three digits program number, press 100+, then press the number button.
11	RETURN +	a) Return to the frequently view channel with one touch. <ol style="list-style-type: none"> <li>1 Choose the channel you want to register.</li> <li>2 Press and hold RETURN+ button until "RETURN PLUS PROGRAMMED!" appears.</li> </ol> To cancel, press and hold RETURN+ button until "RETURN PLUS CANCELED!" appears. b) Return to the previously viewed channel, if you have not set or have canceled the Return channel as above.

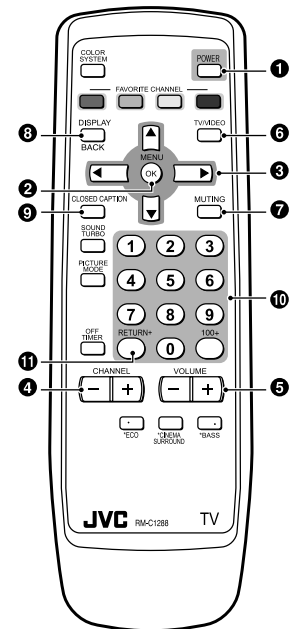

## Remote control buttons and basic functions (continued)

### How to operate menus and menus locations

To	Operation	Note
Display the MENU	Press the MENU/OK button ②.	To exit the MENU, press the DISPLAY/BACK button* ③ or choose EXIT menu.
Display the top menu	Press ▲/▼ buttons ③ to choose a menu title. Then press MENU/OK button ②.	Press ▼ button ③ to display the next page for more functions.
Display the 2nd menu	Press ▲/▼ buttons ③ to choose a menu title. Then press MENU/OK button ②.	
Display the 3rd menu	Press ▲/▼ buttons ③ to choose a menu title. Then press MENU/OK button ②.	
Return to the previous menu	Press the DISPLAY/BACK button* ③.	–
Choose the setting of a function	Press ▲/▼ buttons ③ to choose a function. Then press the ◀/▶ buttons ③ to change the setting.	Press the MENU/OK button ② to exit from the menu.
Adjust the effect level of a function	Press ▲/▼ buttons ③ to choose a function. Then press the ◀/▶ buttons ③ to adjust the effect level.	
Display the sub menu of a function.	Press the ▲/▼ buttons ③ to choose a function. Then press MENU/OK buttons ② to display the sub menu.	–

The following chart shows locations of functions in menus. In this manual, location of a function is described as follows:

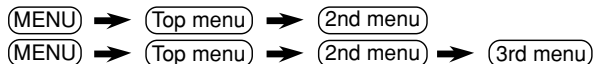

Note: Some functions have the 4th menus as the sub-menus.

\* To exit the menu, the on screen display will show BACK indicated in blue. But it doesn't refer to the blue button on the remote control. Instead, it refers to the DISPLAY/BACK button on the remote control.

	Top menu	2nd menu	Location	3rd menu	Location
MENU	INPUT	EXT. INPUT	P.16	–	–
		DISPLAY	P.16	–	–
		CLOSED CAPTION	P.15	–	–
	PICTURE * If you want to adjust PICTURE SETTING menu, you must set PICTURE MODE menu to USER.	PICTURE MODE	P.9	–	–
		PICTURE SETTING	P.10	–	–
		WHITE BALANCE	P.10	–	–
		PICTURE FEATURES	–	–	VNR
	–		–	FAVORITE CH SETTING	P.14
	–		–	VIDEO SETTING	P.14
	–	–	–	COLOR SYSTEM	P.9
	SOUND * If you want to adjust EQUALIZER menu, you must set SOUND MODE menu to USER.	AI VOLUME	P.13	–	–
		MTS	P.13	–	–
		SOUND MODE	P.12	–	–
		EQUALIZER	P.13	–	–
		BALANCE	P.12	–	–
		SOUND TURBO	P.12	–	–
	FEATURES	CINEMA SURROUND	P.13	–	–
		OFF TIMER	P.15	–	–
	INSTALL	CHILD LOCK	P.15	–	–
		AUTO PROGRAM	P.17	–	–
		CHANNEL SUMMARY	P.17	–	–
BLUE BACK		P.11	–	–	
EXIT	AUTO SHUTOFF	P.16	–	–	
	–	–	–	–	

# TV buttons and functions

The illustrations shown below is for AV-14FT15 and AV-21YA15 only, which are used for explanation purpose.

Your TV may not look exactly the same as illustrated.

## Front of the TV

### AV-14FT15

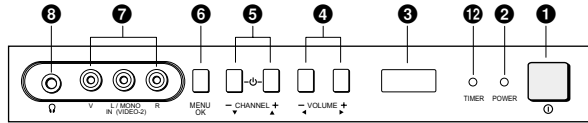

### AV-21YA15

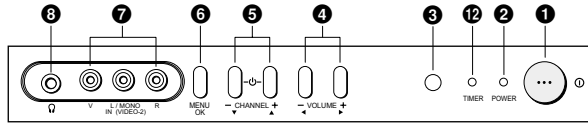

## Rear of the TV

### AV-14FT15

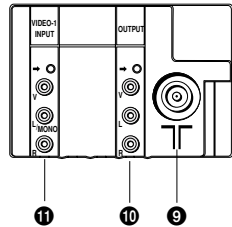

### AV-21YA15

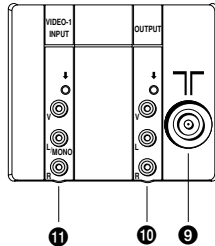

No.	Button/terminal	Description	Page
①	① (main power)	Press to turn on or turn off the TV's main power.	-
②	POWER lamp	Indicate the TV is being turned on or off. No color: TV's main power is being turned off. Red: TV's main power is being turned on. Note: When you turn off the power switch while TV is in standby mode, the light of power lamp will be off in 10 -15 seconds.	-
③	Remote control sensor		-
④	VOLUME -/+	Press to adjust the volume level.	-
⑤	CHANNEL -/+	Press to select the desired channel.	-
⑥	MENU	Press to display the menu.	-
⑦	IN (VIDEO-2)	Video and audio input jacks for VIDEO-2 mode.	18
⑧		Headphone jack.	18
⑨		Aerial socket.	7
⑩	OUTPUT	Video and audio output jacks. (The component video signal cannot be output.)	18
⑪	VIDEO-1 INPUT	Video or S-VIDEO, and audio input jacks for VIDEO-1 mode	7
⑫	TIMER lamp	Indicate the OFF TIMER function is being turned on or off. No color : The OFF TIMER function is being turned off. Orange : The OFF TIMER function is being turned on.	-

## How to operate the menus with the TV button

TV button	Work as same as the button on the remote control unit	Note
MENU	MENU/OK button	To display main menu and exit menu after finish setting.
CHANNEL +/-	▼/▲ button	To select menu function.
VOLUME +/-	◀▶ button	To adjust the desired function.

# Setting up your TV

## CAUTION

- Turn off the equipment including the TV before connecting.

### 1 Connecting the aerial cable.

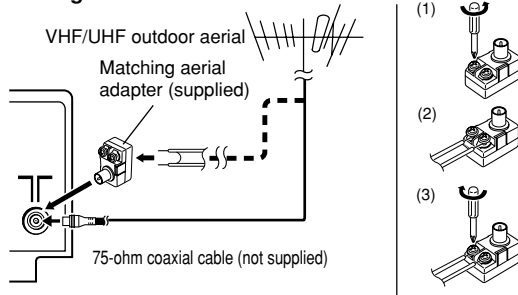

\* Except model AV-21CA15

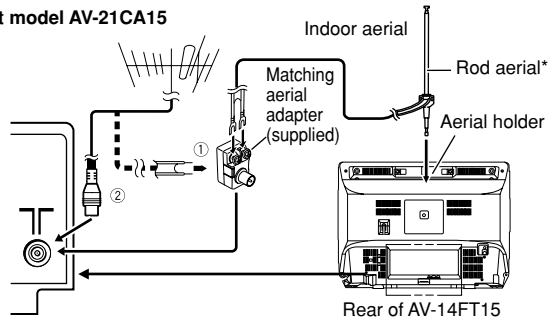

If you connect a VCR, connect the aerial output jack of your VCR and the aerial jack on the TV with the aerial cable. Then connect the output jacks of your VCR and the VIDEO-1 input jacks of the TV with the video cable and audio cables. For details, see the manual of your VCR.

### Rear of TV

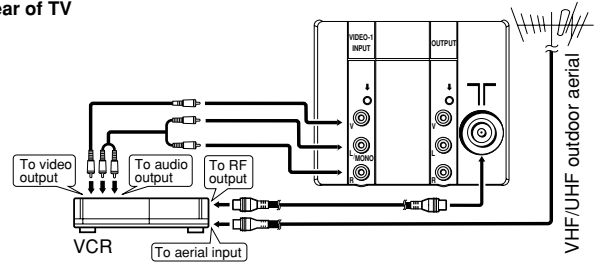

The illustration shown is just a sample. It may not be same as your TV.

### 2 Connecting the compatible main plug to the AC outlet.



### 3 Inserting batteries into the remote control.

Insert two batteries by following the ⊕ and ⊖ polarities and inserting the ⊖ end first.

#### CAUTION:

Follow the cautions printed on the batteries.

Notes:

- Use AA/R6/UM-3 dry cell batteries.
- If the remote control does not work properly, fit new batteries. The supplied batteries are for testing, not regular use.

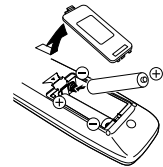

### 4 Turn on the TV by pressing the main power button.

JVC logo appears on the screen.

**JVC**

## Setting up your TV (continued)

### 5 Making the initial settings

Set up your TV by pressing MENU/OK button or waiting for 15 seconds, then the TV will operate by following steps as below:

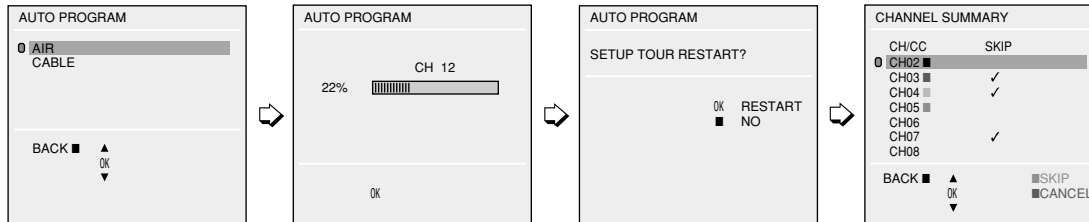

- Press ▲/▼ button to select AIR or CABLE, press the MENU/OK button. TV will start searching for the channels.
- To stop AUTO PROGRAM, press MENU/OK button.
- Press the red button to cancel the SETUP TOUR RESTART function. If you want to make initial settings again when the next time you turn on the TV, press the MENU/OK button to activate the SETUP TOUR RESTART function.
- To complete the initial setting, press the MENU/OK button. To set undesired channels to be skipped, see page 17.

If the JVC logo does not appear, use AUTO PROGRAM function to make the initial settings. This function is located in the INSTALL menu.

If the JVC logo appears, although you had made the initial settings, press the TV/VIDEO button to exit from initial settings.



# Basic setting for picture

## COLOR SYSTEM

You can select the appropriate color system when the picture is not clear or no color appears.

Press the COLOR SYSTEM button to select a setting.

In TV mode: NTSC 3.58 MHz (Fixed).

In VIDEO mode:

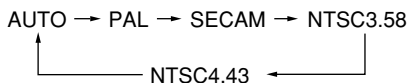

To operate this function with a menu:

\* (MENU) ➔ (PICTURE menu) ➔ (PICTURE FEATURES menu)  
➔ (COLOR SYSTEM)

For the color system in each country or region, see the table below:

Area	Country or Region	System
Asia, Middle East	Bahrain, Kuwait, Oman, Qatar, United Arab Emirates, Yemen, etc.	PAL
	Indonesia, Malaysia, Singapore, Thailand, India, etc.	PAL
	China, Vietnam, etc.	PAL
	Hong Kong, etc.	PAL
	Islamic Republic of Iran, Lebanon, Saudi Arabia, etc.	SECAM
Europe	Philippines, Taiwan, Myanmar, etc.	NTSC
	Russia, etc.	SECAM
	Czech Republic, Poland, etc.	PAL
	Germany, Holland, Belgium, etc.	PAL
	UK, etc.	PAL
Oceania	Australia, New Zealand, etc.	PAL
Africa	Republic of South Africa, etc.	PAL
	Nigeria, etc.	PAL
	Egypt, Morocco, etc.	SECAM

## PICTURE MODE

You can choose the desired picture setting with one-touch. Press the PICTURE MODE button to select a setting.

SOFT	Softens contrast and sharpness.
BRIGHT	Heightens contrast and sharpness.
STANDARD	Standard picture setting.
USER	You can change this picture setting as you like. Select USER and adjust following items in the PICTURE SETTING menu. (PICTURE, BRIGHT, DETAIL, COLOR, TINT*)

\*TINT can only be adjusted in NTSC system.

To operate this function with a menu:

(MENU) ➔ (PICTURE menu) ➔ (PICTURE MODE)

To return the USER setting to the default, press the blue button when the PICTURE SETTING menu appears.

\* About the basic operations of the menu, please see the "How to operate menus and menus locations" on page 5.

## Basic setting for picture (continued)

### Adjusting the picture - USER

You can adjust the desired picture setting when selecting USER in PICTURE MODE.

1 Select the USER in PICTURE MODE under PICTURE menu.

\* (MENU) → (PICTURE menu) → (PICTURE MODE)  
→ (USER)

2 Select the PICTURE SETTING in PICTURE menu, then adjust the setting.

\* (MENU) → (PICTURE menu) → (PICTURE SETTING)

PICTURE	◀ : Lower	▶ : Higher
BRIGHT	◀ : Darker	▶ : Brighter
DETAIL	◀ : Softer	▶ : Higher
COLOR	◀ : Lighter	▶ : Deeper
TINT*	◀ : Reddish	▶ : Greenish

\*TINT can only be adjusted in NTSC system.

### WHITE BALANCE

You can change the white balance of the picture to better match the type of video being viewed.

Select the WHITE BALANCE in the PICTURE menu, then choose the desired setting.

\* (MENU) → (PICTURE menu) → (WHITE BALANCE)

NORMAL	Normal white balance.
COOL	Bluish white.
WARM	Reddish white.

\* About the basic operations of the menu, please see the “How to operate menus and menu locations” on page 5.

# Advanced setting for picture

---

## BLUE BACK

You can set the TV to automatically change to a blue screen and mute the sound if the signal is weak or absent, or when there is no input from an antenna.

Select the BLUE BACK in the INSTALL menu, then choose ON or OFF.

\* (MENU) → (INSTALL menu) → (BLUE BACK)

If you wish to continue viewing the poor picture, cancel the BLUE BACK function.

\* About the basic operations of the menu, please see the “How to operate menus and menus locations” on page 5.

# Basic setting for sound

## SOUND MODE

You can choose the desired sound setting.  
Select the SOUND MODE in SOUND menu, then choose the setting.

\* (MENU) → (SOUND menu) → (SOUND MODE)

USER	You can change this sound setting as you like. Select USER and adjust the frequencies in EQUALIZER (100, 300, 1K, 3K, 8K Hz). For details, see "EQUALIZER" on page 13.
DYNAMIC	Emphasize on both vocal sound and music.
MUSIC	Emphasize on music effect.
NEWS	Emphasize on vocal sound.

## BALANCE

You can adjust the volume balance between the left and right speakers.  
Select the BALANCE in SOUND menu, then adjust the setting.

\* (MENU) → (SOUND menu) → (BALANCE)

## SOUND TURBO

You can enjoy the emphatic low and high frequency levels.  
Press the SOUND TURBO to select ON or OFF.  
To operate this function with a menu:

\* (MENU) → (SOUND menu) → (SOUND TURBO)

\* About the basic operations of the menu, please see the "How to operate menus and menu locations" on page 5.

# Advanced setting for sound

## CINEMA SURROUND

You can enjoy an enhanced sound for wider audience.  
Press the CINEMA SURROUND button to select a setting.

OFF	Cancel the function.
HIGH	Listen to sound with more wider audience effect.
LOW	Listen to sound with less wider audience effect.
MONO	Listen to mono sound with stereo effect.

To operate this function with a menu:

\* (MENU) → (SOUND menu) → (CINEMA SURROUND)

If slight volume distortion occurs when you select HIGH mode, change the setting to LOW mode. The CINEMA SURROUND effect will be less noticeable.

If you use CINEMA SURROUND and SOUND TURBO together, volume distortion might occur.

## MTS

You can enjoy the stereo and SAP broadcasted programs.  
Select the MTS in SOUND menu, then choose the desired mode.

\* (MENU) → (SOUND menu) → (MTS)

STEREO	Select stereo sound.
SAP	Select second audio programs.
MONO	Select monaural sound.

This function is not available in video mode.

## EQUALIZER

You can adjust the sound level of each frequencies when selecting USER mode in SOUND MODE.

1 Select the USER in SOUND MODE under SOUND menu.

\* (MENU) → (SOUND menu) → (SOUND MODE) → (USER)

2 Select the EQUALIZER in SOUND menu.

\* (MENU) → (SOUND menu) → (EQUALIZER)

The following display appears.

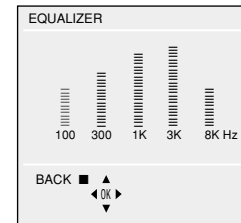

3 Select and adjust the desired frequencies.

4 Press the MENU/OK button to exit the menu.

Adjust high frequency will affect higher pitch sound and vice versa.

## AI VOLUME

You can adjust the volume of all the channels and video inputs to the same level automatically.

Select the AI VOLUME in SOUND menu, then choose ON or OFF.

\* (MENU) → (SOUND menu) → (AI VOLUME)

\* About the basic operations of the menu, please see the "How to operate menus and menus locations" on page 5.

# Favorite channel and video setting

## To register the favorite channel

You can register and recall 4 favorite channels by using the color buttons (red, green, yellow, blue).

- 1 In TV mode, select a TV channel (CH02-CH69, CC01-CC125) you desired to register.
- 2 Press and hold a color button for 3 seconds or more. "FAVORITE CHANNEL ■ PROGRAMMED!" appears on the screen and current channel is registered.
- 3 To register other favorite channels, repeat Step 1 to 2. To recall the favorite channel, press the color button. When the TV is in menu mode, favorite channel function is not available.

## To adjust favorite channel setting (FAVORITE CH SETTING)

You can adjust the picture and sound settings for the favorite channels.

- 1 Display the PICTURE menu and select FAVORITE CH SETTING in PICTURE FEATURES menu.  
\* (MENU) → (PICTURE menu) → (PICTURE FEATURES menu) → (FAVORITE CH SETTING)
- 2 Select FAVORITE CHANNEL in FAVORITE CH SETTING menu, then choose the desired favorite channel.  
\* (FAVORITE CH SETTING) → (FAVORITE CHANNEL)
- 3 Select EFFECT, then press ◀▶ button to choose ON.  
To cancel the settings, choose OFF.

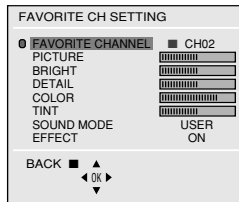

- 4 Select the desired item that you wish to adjust.

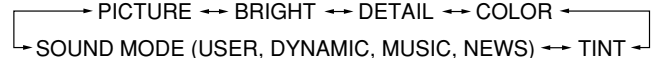

- 5 Press the MENU/OK button to exit the menu.

## To adjust the video setting (VIDEO SETTING)

You can adjust the picture and sound settings for video inputs.

- 1 Display the PICTURE menu and select VIDEO SETTING in PICTURE FEATURES menu.  
\* (MENU) → (PICTURE menu) → (PICTURE FEATURES menu) → (VIDEO SETTING)
- 2 Select VIDEO STATUS in VIDEO SETTING menu, then choose the desired video input.  
\* (VIDEO SETTING) → (VIDEO STATUS)
- 3 Select EFFECT, then press ◀▶ button to choose ON.  
To cancel the settings, choose OFF.

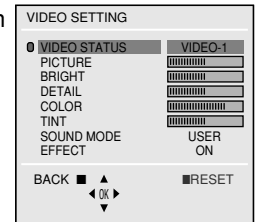

- 4 Select the desired item that you wish to adjust.

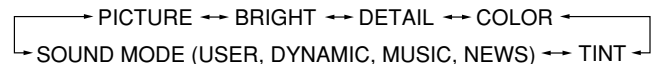

- 5 Press the MENU/OK button to exit the menu.

\* About the basic operations of the menu, please see the "How to operate menus and menus locations" on page 5.

# Customized setting

## VNR

You can reduce the picture noise.

Select the VNR in the PICTURE FEATURES menu under PICTURE menu, then choose a setting of VNR function.

\* (MENU) → (PICTURE menu) → (PICTURE FEATURES menu)  
→ (VNR)

OFF	VNR is turned off.
AUTO	Effect of VNR is automatically controlled.
MIN	Effect of VNR becomes minimum level.
MAX	Effect of VNR becomes maximum level.

If you select MAX, the picture becomes softer even if the original picture is sharp.

## CLOSED CAPTION

If they are included in a program, you can view closed captions or text information.

Press the CLOSED CAPTION button to select a setting.

→ OFF → CLOSED CAPTION → TEXT

1 Select the CLOSED CAPTION in INPUT menu, then choose CAPTION or TEXT.

\* (MENU) → (INPUT menu) → (CLOSED CAPTION)

2 Press the ◀▶ button to select the desired caption or text channel.

## CHILD LOCK

You can disable the front control buttons of the TV.

Select the CHILD LOCK in the FEATURES menu, then choose ON or OFF.

\* (MENU) → (FEATURES menu) → (CHILD LOCK)

## OFF TIMER

You can set the TV to turn off automatically to standby mode after a set time.

Press the OFF TIMER button to select a desired period of time.

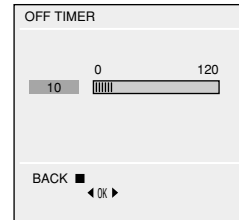

You can set the period of time to a maximum of 120 minutes in 10 minutes step.

To operate this function with a menu:

\* (MENU) → (FEATURES menu) → (OFF TIMER)

When the elapsed of time left one minute, "GOOD NIGHT!" appears on the screen.

You can display the OFF TIMER menu again to confirm or change the remaining time.

\* About the basic operations of the menu, please see the "How to operate menus and menus locations" on page 5.

## Customized setting (continued)

---

### AUTO SHUTOFF

You can set the TV to turn off automatically when no signal is received for about 15 minutes or longer after the end of a broadcast.

Select AUTO SHUTOFF in INSTALL menu, then choose ON or OFF.

\* (MENU) → (INSTALL menu) → (AUTO SHUTOFF)

The AUTO SHUTOFF function does not turn off the TV's main power.

The AUTO SHUTOFF function is not available in video mode.

### EXT. INPUT (TV/VIDEO)

You can select TV or video terminal input with one touch.

Press the TV/VIDEO button to select an input.

To operate this function with a menu:

\* (MENU) → (INPUT menu) → (EXT. INPUT)

### DISPLAY

You can display the program number and video terminal number on the screen.

Press the DISPLAY button to display the indication on the screen.

To operate this function with a menu:

\* (MENU) → (INPUT menu) → (DISPLAY)

\* About the basic operations of the menu, please see the "How to operate menus and menus locations" on page 5.



# TV channel presetting

## To register the TV channels automatically

You can register the TV channels into the TV's channel list automatically.

1 Display the INSTALL menu.

\* (MENU) → (INSTALL menu)

2 Choose AUTO PROGRAM, then press the MENU/OK button.

3 Press the ▲/▼ button to select AIR or CABLE, then press the MENU/OK button.

AUTO PROGRAM function starts, and the channels received are registered automatically.

4 "SETUP TOUR RESTART?" appears.

To start the SETUP TOUR	Press the MENU/OK button. Then proceed to step 5 of "Setting up your TV" on page 8.
-------------------------	---

To skip the SETUP TOUR	Press the Red button.
------------------------	-----------------------

5 The CHANNEL SUMMARY menu appears.

For details of "SETUP TOUR", see page 8.

## CHANNEL SUMMARY

You can set undesired channels to be skipped.

Channels are to be skipped cannot be selected by the CHANNEL +/- button.

1 Display the INSTALL menu.

\* (MENU) → (INSTALL menu)

2 Choose CHANNEL SUMMARY, then press the MENU/OK button.

CHANNEL SUMMARY menu appears.

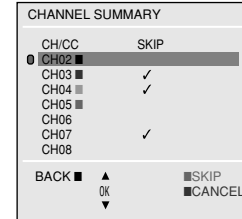

3 Choose the channel which you want to skip.

The skip can be set to all channels of AIR (CH02-CH69) and CABLE (CC01-CC125).

4 Press the yellow button to skip the channel.

To cancel the skip, press the blue button.

5 Press the MENU/OK button to exit the menu.

\* About the basic operations of the menu, please see the "How to operate menus and menus locations" on page 5.

# Additional preparation

The illustrations shown in this section are for AV-14FT15 and AV-21YA15 only, which are used for explanation purpose. Your TV may not look exactly the same as illustrated.

## Before connecting

- Read the manuals provided with the devices for the proper connection.
- Turn off all the devices including the TV.
- Note that connecting cables are not supplied.

## Connecting to front video input terminal

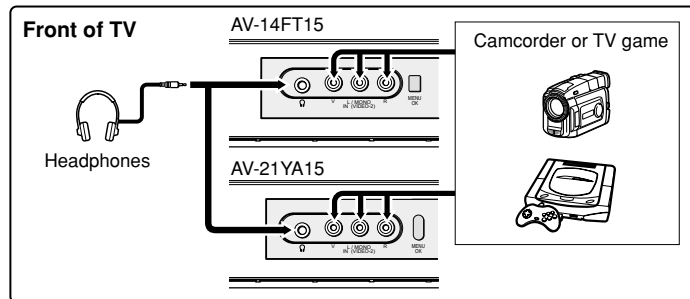

## Connecting to rear component/video input terminal and output terminal

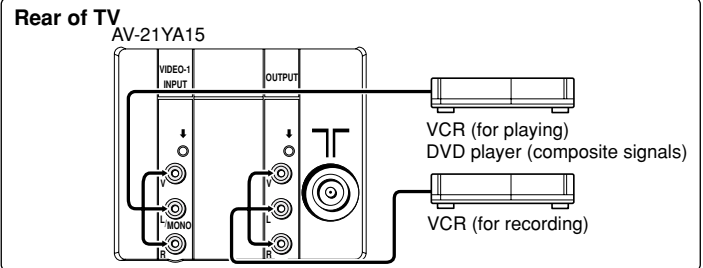
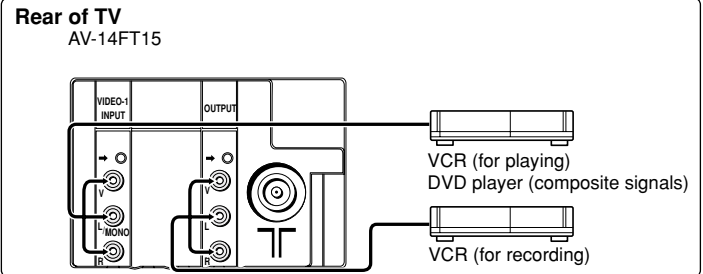

# Troubleshooting

If a problem occurs when you are using the TV, check the below troubleshooting guide before calling for repair.

• No picture, no sound	• Deactivate the BLUE BACK function if it is turned on.
• Snowy picture	• Check the aerial cable and its connection with the TV.
• Stripes appear on the picture	• Interference occurs caused by other devices such as an amplifier, personal computer, or a hair drier. Move such devices away from your TV.
• Double-pictures (ghosting) occur	• Interference occurs caused by signal reflecting from mountains or building. Try to adjust the aerial's direction or use a better directionality antenna.
• Poor picture	• Choose the appropriate color system. Refer to "COLOR SYSTEM" on page 9. • Adjust the COLOR or BRIGHT setting. Refer to "Adjusting the picture - USER" on page 10.
• White and bright still image look as if it were colored	• Inevitable phenomenon due to the nature of the picture tube. This is not a malfunction.
• Top of the image from software products or video tape is distorted	• This is due to the condition of the video signal whereby the image was not recorded properly. This is not a malfunction.
• Poor sound	• Adjust the sound frequency properly. Refer to "EQUALIZER" on page 13.
• Stereo or bilingual sound is unclear	• TV channel reception is poor. Change the stereo/bilingual mode to mono sound (see page 13).

• Cannot operate the remote control	• The batteries may be exhausted. Replace with new batteries (see page 7). • Ensure that you are operating the remote less than seven meters from the front of your TV.
• Cannot operate the menus	• Press TV/VIDEO button to return to TV mode and try operating the menus.
• Cannot operate the front control buttons	• Deactivate the CHILD LOCK function if it is turned on (see page 15).
• TV is turned off suddenly	• This may due to the AUTO SHUTOFF function is activated. Press the POWER button to turn on the TV.
• Color patches appear at the corner of the screen	• This may due to the magnetized device such as a speaker near to your TV. Keep the device apart from your TV. Alternately, you can also use the magnetic-shielded speaker.
• Image takes a short period to be displayed	• Image required time to stabilize before display. This is not a malfunction.
• TV may emitted crackling sound	• This is due to a sudden change in temperature and it is not a malfunction. If the crackling sound is too frequent, request your service technician for inspection.
• Feel a slight electric shock when touching the TV screen	• This is due to the static electricity of the picture tube and it will not harm the human body. This is not a malfunction.

# Specifications

---

## TV RF systems

M

## Color systems

TV mode: NTSC 3.58 MHz

VIDEO mode: PAL, SECAM, NTSC 3.58 MHz, NTSC 4.43 MHz

## Receiving channels

VHF low channel (VL), VHF high channel (VH), UHF channel (U)

Receives cable channels in mid band, super band and hyper band.

## External input / output

VIDEO-1: VIDEO input, AUDIO L/R input

VIDEO-2: VIDEO input, AUDIO L/R input

OUTPUT: VIDEO output, AUDIO L/R output

Headphone jack: Stereo mini jack (3.5 mm diameter)

## Sound-multiplex systems

MTS (Multi-Channel Television Sound)

## Viewing Screen size (Visible area)

AV-21CA15: XXX.X mm

AV-21YA15: 508.0 mm

AV-14FT15: 335.4 mm

***Design and specifications subject to change without notice.***

# JVC

## Free Manuals Download Website

<http://myh66.com>

<http://usermanuals.us>

<http://www.somanuals.com>

<http://www.4manuals.cc>

<http://www.manual-lib.com>

<http://www.404manual.com>

<http://www.luxmanual.com>

<http://aubethermostatmanual.com>

Golf course search by state

<http://golfingnear.com>

Email search by domain

<http://emailbydomain.com>

Auto manuals search

<http://auto.somanuals.com>

TV manuals search

<http://tv.somanuals.com>