

JVC



COLOUR TELEVISION

D.I.S.T.
Digital Image Scaling Technology

HV-Z34L1 HV-Z29V1

Contents

Setting up your TV.	3
TV buttons and functions.	6
Remote control buttons and functions.	8
Using the TV's menu.	19
PICTURE menu	20
FEATURES menu	21
SOUND menu	24
FEATURES menu	26
SETUP menu	29
Additional preparation	36
Troubleshooting.	40
Specifications	43

INSTRUCTIONS



LCT1457-001A-H
1003-CR-JMT

© 2003 VICTOR COMPANY OF JAPAN, LIMITED

Thank you for buying this JVC colour television.

To make sure you understand how to use your new TV, please read this manual thoroughly before you begin.

WARNING: TO PREVENT FIRE OR SHOCK HAZARD, DO NOT EXPOSE THIS APPLIANCE TO RAIN OR MOISTURE.

CAUTION: TO ENSURE PERSONAL SAFETY, OBSERVE THE FOLLOWING RULES REGARDING THE USE OF THIS TV.

- 1 Operate only from the power source indicated on the rear of the TV.
- 2 Avoid damaging the power cord and mains plug. When unplugging the TV, grasp the mains plug. Do not pull on the power cord.
- 3 Never block or cover the ventilation openings.
Never install the TV where good ventilation is unattainable.
When installing this TV, leave spaces for ventilation around the TV of more than the minimum distances as shown.

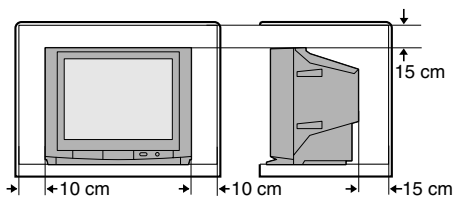

- 4 Do not allow objects or liquid into the cabinet openings.
- 5 In the event of a fault, unplug the unit and call a service technician. Do not attempt to repair it yourself or remove the rear cover.
- 6 The surface of the TV screen is easily damaged. Be very careful with it when handling the TV. Should the TV screen become soiled, wipe it with a soft dry cloth. Never use rub it forcefully. Never use any cleaner or detergent on it.
- 7 If you are not going to use this TV for a long period of time, be sure to disconnect the AC plug from the AC socket.
- 8 The apparatus shall not be exposed to dripping or splashing and that no objects filled with liquids, such as vases, shall be placed on the apparatus.

D.I.S.T. demonstration

To start the D.I.S.T. demonstration:

Press the **MENU** button to display the menu bar. Then press the yellow button.

A picture split in two (D.I.S.T. turned on and D.I.S.T. turned off) will appear on the screen.

To quit the D.I.S.T. demonstration:

Press the yellow button, **BACK** button, **CHANNEL** \vee/\wedge buttons or any of the number buttons.

Setting up your TV

CAUTION

- Turn off all the equipment including the TV before connecting anything.

1 Connecting the woofer unit (only for HV-Z29V1)

1 Fitting the woofer unit

Align the projection on the base of the woofer unit with the hole in the top of the TV, and insert the connector into the woofer terminal.

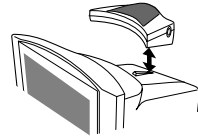

2 Connecting the supplied woofer connector to the BASS SPEAKER OUT terminal on the back of the TV

If the woofer unit is not connected, you will not be able to enjoy the bass sound.

- Connect so that the lever is raised.
- When disconnecting the woofer connector, do so while pushing the lever.

2 Connecting the aerial and VCR

- Aerial cable is not supplied. Use a good quality 75-ohm coaxial cable.
- Read the manual that came with the VCR before connecting.

If not connecting a VCR (see Fig. A):

Connect an aerial cable to the aerial socket on this TV.

If connecting a VCR (see Fig. B):

- 1 Connect the aerial cable to the aerial input socket on the VCR, and connect the VCR and TV with another aerial cable.

- 2 Connect the VCR's VIDEO OUT (video output) jack and the TV's VIDEO jack with a video cable.

To connect a VCR to the TV with an S-VIDEO cable:

Connect the VCR's S-VIDEO OUT (S-VIDEO output) connector and TV's S connector with an S-VIDEO cable (A), instead of connecting with a video cable.

- 3 Connect the VCR's AUDIO OUT (audio L/R output) jacks and the TV's AUDIO jacks (L/MONO and R) with an audio cable.

- If the VCR's audio output is in mono, connect the VCR's AUDIO OUT (audio output) jack and the TV's AUDIO L/MONO jack with an audio cable.

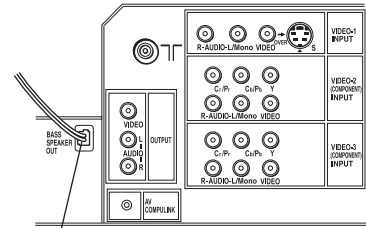

Lever

Fig. A

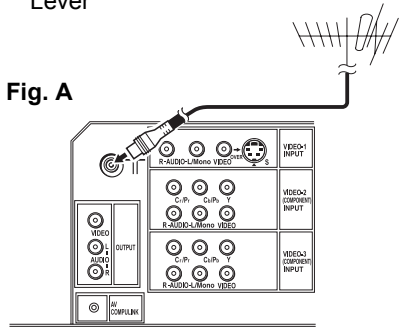
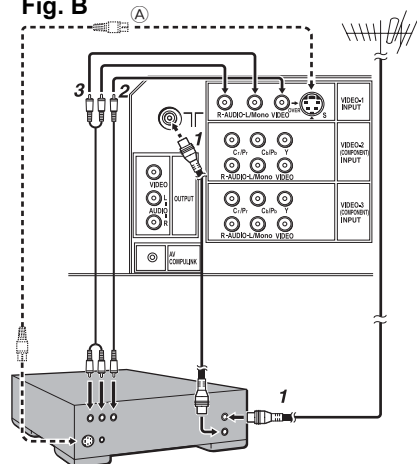

Fig. B



3 Connecting the power cord

Connect the mains plug to the AC outlet.

4 Putting the batteries into the remote control

Use two AA/R6 batteries.

Insert the batteries from the ⊖ end, making sure the ⊕ and ⊖ polarities are correct.

- Follow the warnings printed on the batteries.
- If the remote control does not work properly, replace the batteries.
- The batteries we supply are only for setting up and testing your TV. Please replace them as soon as necessary.

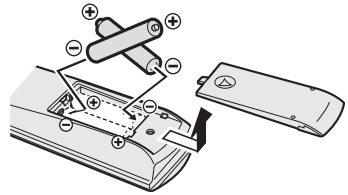

5 Making the initial settings (SETUP TOUR)

When the TV is first turned on, it enters the initial setting mode, and the JVC logo is displayed.

1 Press the main power button on the TV.

- The TV is turned on, and the JVC logo appears.
- If the POWER lamp on the TV lights red and does not change to green, your TV is in the standby mode. Press the ⏻/⏪ button on the remote control to turn the TV on.
 - If the JVC logo does not appear, your TV has already been turned before. In this case, use the “LANGUAGE”, “TELETEXT LANGUAGE” and “AUTO PROGRAM” functions to make the initial settings. For details, see “SETUP menu” on page 29.

2 Press the OK button on the remote control.

The LANGUAGE menu appears. You can choose a language for the on-screen language.

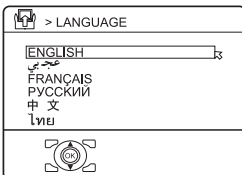
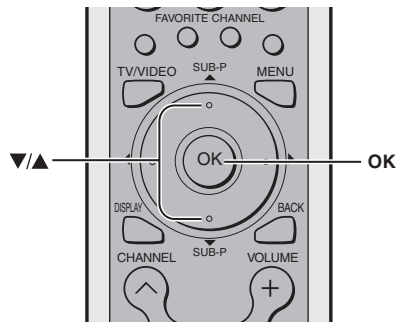
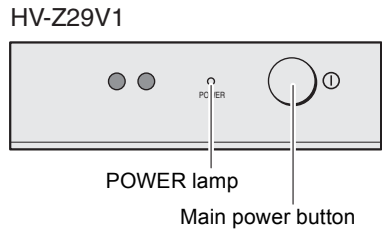
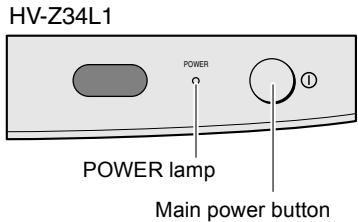

- 3 Press the ▼/▲ buttons to choose ENGLISH. Then press the OK button on the remote control.**

The TELETEXT LANGUAGE menu appears. Set the teletext language group that corresponds to the language of the teletext program that you want to watch. For details, see “TELETEXT LANGUAGE” on page 34.

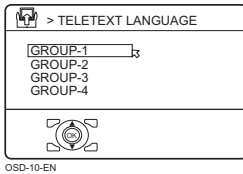

O5D-10-EN

- 4 Press the ▼/▲ buttons to choose a group. Then press the OK button.** The AUTO PROGRAM function starts. The TV channels you receive are automatically stored in the PR (programme numbers) LIST.

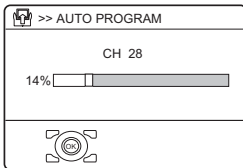

D0004-EN

- To stop the AUTO PROGRAM function, press the OK button.

- 5 After the TV channels have been stored in the programme numbers (PR) list, the EDIT menu appears.**

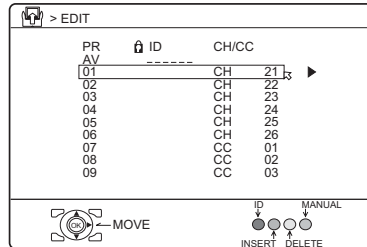

D0038-EN

- You can proceed to edit the programme numbers list using the EDIT/MANUAL function. For details, see “EDIT/MANUAL” on page 30.
- If a TV channel you want to view is not stored in the programme numbers list, you can register it using the MANUAL function. For details, see “EDIT/MANUAL” on page 30.
- The AUTO PROGRAM function does not store a TV channel to the programme number 0 (AV).
- If you do not need to use the EDIT/MANUAL function, press the OK button to close the EDIT menu.

Now, setting up is complete. Please enjoy your new JVC TV!

TV buttons and functions

HV-Z34L1

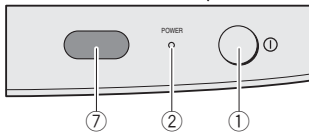
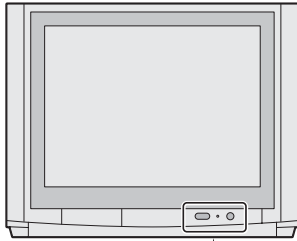

HV-Z29V1

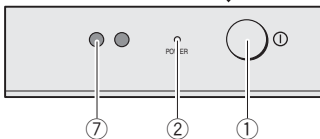
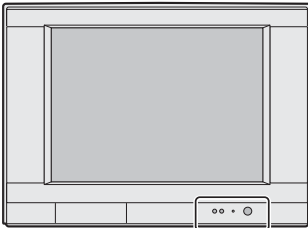

HV-Z29V1

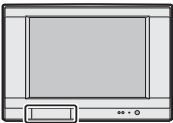

HV-Z34L1

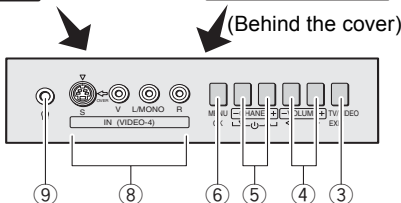
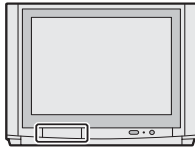

Turn the main power on

Press the main power button ①.

The POWER lamp ② lights red and your TV is in the standby mode.

To turn the main power off:

Press the main power button again. The POWER lamp ② goes off.

Turn the TV on from standby mode

Press the CHANNEL-/+ buttons ⑤.

The POWER lamp ② lights red to green and your TV will be turned on.

- You can also turn on the TV by pressing the TV/VIDEO button ③ while it is in standby mode.

Choose a TV channel

Press the CHANNEL-/+ buttons ⑤.

Choose a VIDEO terminal

Press the TV/VIDEO button ③ or CHANNEL-/+ buttons ⑤.

Adjust the volume

Press the VOLUME-/+ buttons ④.

The volume level indicator appears.

MENU button ⑥

Press to open the menu.

For details, see "Operation with the buttons on the TV" on page 20.

Remote control sensor ⑦

VIDEO-4 terminal ⑧

See page 36.

Headphone jack ⑨

Connect the headphones with a stereo mini-jack (3.5mm in diameter).

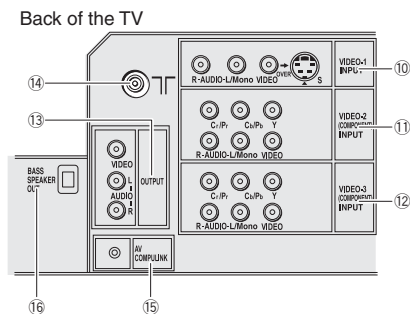

VIDEO-1 terminal ⑩

- See pages 3 and 36.

VIDEO-2 (COMPONENT) terminal ⑪

- See pages 33 and 36.

VIDEO-3 (COMPONENT) terminal ⑫

- See pages 33 and 36.

OUTPUT terminal ⑬

- See page 37.

Aerial socket ⑭

Connect the aerial cable.

- See page 3.

AV COMPU LINK terminal ⑮

- See page 38.

BASS SPEAKER OUT terminal ⑯ (only for HV-Z29V1)

- See page 3.

Remote control buttons and functions



Turn the TV on from standby mode

Press the **⏻/⏿** button.

The POWER lamp lights red to green and your TV will be turned on.

- You can turn on the TV from the standby mode by pressing the TV/VIDEO button, the CHANNEL ∇/\wedge buttons or the number buttons.

To turn the TV off:

Press the **⏻/⏿** button again.

The POWER lamp changes from green to red and the TV enters standby mode.

To turn the TV on or off, set the PIP/TV/DVD switch on the remote control to the TV or PIP position and press the **⏻/⏿** button.

If the PIP/TV/DVD switch on the remote control is set to the DVD position, the TV will not be turned on or off even if the **⏻/⏿** button is pressed.

Choose a TV channel

Choose a programme number in which a TV channel has been set.

Press the **CHANNEL ∇/\wedge** buttons or enter the programme number (PR) with the number buttons.

Example:

- PR 6 → press **6**
- PR 12 → press **1** and **2**
 - You can select a channel from the PR LIST. For details, see “DISPLAY button” on page 11.
 - If you do not have a clear picture or no colour appears, follow the operation procedure “COLOUR SYSTEM” on page 23.

Adjust the volume

Press the **VOLUME-/+** buttons.

Watch images from an external device

Choose a VIDEO terminal to which the external device has been connected.

Press the **TV/VIDEO** button.

- You can choose a VIDEO terminal with the **CHANNELV/∧** buttons or from the **PR LIST**.

To return to a TV channel:

Press the **TV/VIDEO** button, the **CHANNELV/∧** buttons or the number buttons.

🔇 (Muting) button

Press the 🔇 (Muting) button to turn off the volume. Pressing the 🔇 (Muting) button again resumes the previous volume level.

ZOOM button

You can change the screen size according to the picture aspect ratio. Choose the optimum one from the following ZOOM modes.

1 Press the ZOOM button to display the ZOOM menu.

- The ZOOM button works only in the normal screen.

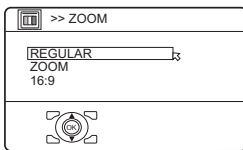

2 Press the ▼/▲ buttons to choose a ZOOM mode. Then press the OK button.

REGULAR:

Use to view a normal picture (4:3 aspect ratio) as its original size is.

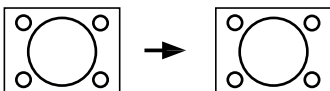

ZOOM:

You can zoom up the Wide picture (16:9 aspect ratio) to fill the TV screen.

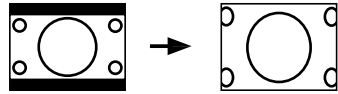

- The left side and right side of the Wide picture (16:9 aspect ratio) will be cut off.

16:9:

This mode converts a normal picture (4:3 aspect ratio) into a Wide picture (16:9 aspect ratio).



- Use for picture with a 16:9 aspect ratio that have been squeezed into a normal picture (4:3 aspect ratio), you can restore their original dimensions.
- When a 1125i signal is input, the 16:9 aspect ratio is chosen automatically.

CINEMA SURROUND button

You can enjoy an enhanced sound for a wider audience by using CINEMA SURROUND function.

Press the **CINEMA SURROUND** button to select one of **CINEMA SURROUND** modes.

HIGH/LOW:

When you listen to the stereo sound, please select HIGH or LOW mode.

You can enjoy the sound for a wider audience similar to the experience at the theatre.

When you combine the functions of SOUND MODE, SUPER BASS and DIGITAL BBE, you can enjoy more powerful sound.

- In case that you setting up the CINEMA SURROUND function to HIGH mode, there may be slight volume distortion. In case that occurs, please switch the HIGH mode to LOW mode, the effect of CINEMA SURROUND functions will be less noticeable, however, the volume distortion will be corrected.

MONO:

Select the MONO mode, when you listen to the mono sound.

You can enjoy the sound for a wider audience similar to stereo sound.

OFF:

The CINEMA SURROUND function switches off.

SOUND MODE button

You can select the SOUND MODE of you liking from 4 types of sound modes to fully enjoy the sound of your TV.

Press the SOUND MODE button to select one of sound modes.

DYNAMIC:

Dynamic sound is created by enhancing high and low tones.

You can get the 3D effect by using the CINEMA SURROUND function in this mode.

MUSIC:

The mode suitable for music programmes.

Enjoy a concert hall-like atmosphere.

Combination with the CINEMA SURROUND function will bring wider range sound.

NEWS:

The mode suitable for news programmes makes the voice of the newscaster or the like easier to hear.

USER:

Save your own sound setting to memory with this mode.

The USER setting is performed with the "SOUND MODE" menu (see page 25).

BASS button

You can choose the SUPER BASS mode which emphasizes the bass sound.

Press tge BASS button to select one of SUPER BASS modes.

You can choose HIGH, MID or LOW.

Choosing LOW will reduce the bass sound and choosing HIGH will increase the bass sound.

RETURN+ button

The RETURN+ button has two functions; the RETURN+ function and the RETURN function. If a channel has been registered as the "Return Channel", the RETURN+ function operates. If there is no setting for the "Return Channel", the RETURN function operates.

RETURN+ function

By registering a channel you frequently view as the "Return Channel", you can select that channel at any time simply by pressing the RETURN+ button.

To register a TV channel as the "Return Channel":

Choose the Programme number to which the channel you want to register has been set, and press the RETURN+ button and hold for more than 3 seconds continuously. "RETURN PLUS PROGRAMMED!" is displayed and the registration is completed.

To cancel a TV channel registered as the "Return Channel":

While viewing any TV channel, press the RETURN+ button and hold for more than 3 seconds continuously. "RETURN PLUS CANCELED!" is displayed and the registration is cancelled.

- When you turn off the TV, the registration for the "Return Channel" is cancelled.
- If you want to view the "Return Channel" and another TV channel alternately, first choose a channel other than the "Return Channel". And then press the RETURN+ button to change the channel to the "Return Channel" In this way, you can view two channels alternately by pressing the RETURN+ button.

RETURN function

The TV temporarily memorises the TV channel that was chosen right before the current TV channel as the “Last Channel”. By pressing the RETURN+ button, you can alternately view the current TV channel and the “Last Channel”.

- If you want to view two channels alternately by using the RETURN function, first choose one TV channel and then choose the other TV channel with the Number buttons. If you choose the TV channel without using the Number buttons, there are cases where a channel other than the one you first chose is registered as the “Last Channel”.

DISPLAY button

You can display the PR LIST, programme number or VIDEO terminal number on the screen.

Press the DISPLAY button.

Pressing the DISPLAY button changes the display as follows:

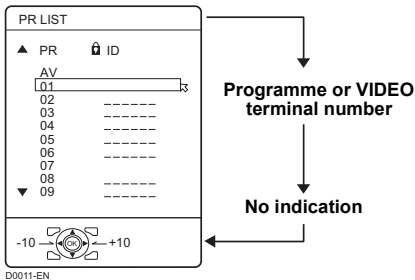

Choose a TV channel or a VIDEO terminal

1 Press the DISPLAY button to display the PR LIST.

2 Press the ▼/▲ and ◀/▶ buttons to choose a programme number or VIDEO terminal. Then press the OK button.

- For programme numbers with the CHANNEL GUARD function set, the  (CHANNEL GUARD) mark is displayed next to the programme number in the PR LIST.
- The VIDEO terminals are registered after the programme number PR99.
- The AV channel (channel number 0) in the PR LIST will be chosen only if you connect the VCR to the TV with an aerial cable without connecting a video cable.

Favorite channel registration

You can register your favorite TV channels with the colour buttons (Red, Green, Yellow and Blue). After registration you can recall the favorite channel by pressing the colour button.

1 In the normal screen, choose a TV channel (PR01-99) you want to register.

For detailed operation, see “Choose a TV channel” on page 8.

2 Press and hold a colour button for 3 seconds or more.

Then “FAVORITE CH PROGRAMMED” appears on the screen and the current channel is registered.

- If the chosen channel is already registered as the favorite channel, when a colour button is pressed, the registered colour button icon appears on the top right of the screen.
- You cannot register in the Text mode, or while multiple screens, such as PIP (picture in picture) are displayed.
- Also you cannot register if the chosen channel is guarded with the CHANNEL GUARD function and the screen is blue, or if an on-screen menu is displayed.
- Starting the AUTO PROGRAM deletes the registered favorite channel.

■ Recalling the favorite channel

Press the colour button, then the registered favorite channel will be displayed.

- You cannot recall the favorite channel in the Text mode, Menu mode where an on-screen menu is displayed.
- The picture effect dedicated for the colour button applies. For details, see "Setting the picture effect" below:

■ Setting the picture effect

Each colour button has a dedicated picture effect. When you choose a favorite channel with a colour button, the dedicated picture effect is used. When shipped, the factory set picture effect is used for this purpose. However, you can set this picture effect as required. For details, see "FAVORITE SETTING" on page 28.

■ Showing the favorite channels

Press the DISPLAY button to display the PR LIST.

You can see the favorite channel that has the registered colour button icon at the right of the channel number.

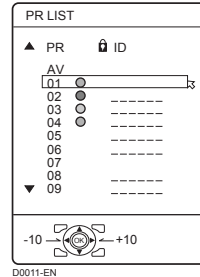

Twin and PIP (picture in picture) function

You can view two pictures (Main picture and sub picture). Two different TV programmes can be watched at the same time or a TV programme and a video programme from an external device can be watched at the same time.

Operate with the PIP/TV/DVD switch set to the PIP position.

Twin mode

Press .

Each time it is pressed the mode changes as shown below.

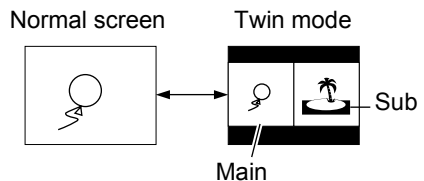

PIP (picture in picture) mode

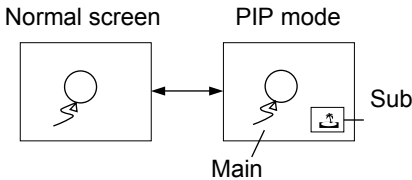

Press .

Each time it is pressed the mode changes as shown below.



To return to the normal screen:

Press the  or  again, or press the BACK button.

- The  and  buttons do not work in the Text mode.
- Twin and PIP functions do not work for a picture of 1125i signal.
- A picture of 625p or 525p signal cannot be displayed as the sub-picture. Pay attention to the following.
 - When the VIDEO-2 or VIDEO-3 picture is a picture of 625p or 525p signal, you cannot choose VIDEO-2 or VIDEO-3 with the SUB-P▼/▲ buttons.
 - When the VIDEO-2 or VIDEO-3 picture signal is changed to 625p, 525p or 1125i signal while the VIDEO-2 or VIDEO-3 picture is displayed as the sub-picture, the Twin or PIP modes is cancelled.

■ Listening to the sound of the sub-picture:

You can listen to the sound of the sub-picture with the headphones while listening to the sound of the main-picture from the TV speakers.

For details, see "HEADPHONE VOLUME" on page 25.

- The sub-picture sound is monaural.

■ TV channel selection

For the main picture:

Choose a channel using the CHANNELV/∧ buttons or the number buttons.

For the sub picture:

Choose a channel using the SUB-P▼/▲ buttons.

■ Input source selection (TV, VIDEO-1, -2, -3 or -4)

For the main picture:

Press the TV/VIDEO button.

Each time you press the button, the input source changes as follows (the one used for the sub picture will be skipped):

VIDEO-1 → VIDEO-2 → VIDEO-3 → VIDEO-4 → TV

For the sub picture:

Press the  (Input) button.

Each time you press the button, the input source changes as follow (the one used for the main picture will be skipped):

VIDEO-1 → VIDEO-2 → VIDEO-3 → VIDEO-4 → TV

■ Swapping the pictures

Press the (Swap) button.

Each time you press the button, the main picture and the sub picture will be swapped.

- The pictures cannot be swapped when a picture of 625p or 525p signal from VIDEO-2 or VIDEO-3 is being displayed as the main picture.

■ Changing the sub picture position (in PIP mode only)

You can position the sub picture to one of corners of the main picture.

Press the  (Position) button.

Each time you press the button, the sub picture moves clockwise (lower right → lower left → upper left → upper right).

■ Setting the colour system of the sub picture

You can choose the colour system of the sub picture.

The setting is performed with the "COLOUR SYSTEM" menu (see page 23) when in the Twin mode or PIP mode.

Multi-picture function

You can display multi-pictures that enable you to easily find a program you want to view.

1 Set the PIP/TV/DVD switch to the PIP position

2 Press the button to display multi-pictures

The channels are displayed in the channel number order.

The multi-pictures will appear in one of the two multi-picture modes.

9 pictures multi:

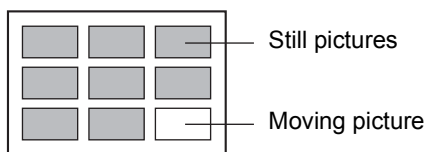

5 pictures multi:

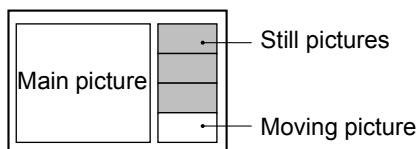

- To display the next multi-pictures, press the  button.

3 Choose the screen you want to view

The picture you choose changes to a moving picture.

9 pictures multi:

Choose by pressing ◀/▶▼/▲.

5 pictures multi:

Choose by pressing ▼/▲.

4 Press the OK button

The multi-pictures disappears and the chosen picture appears.

Changing the multi-picture mode:

See "MULTI" on page 24.

Cancelling the multi-pictures

Press the BACK button, CHANNEL V/∧ buttons, the number buttons or OK button.

- You can also enter this mode while in the Twin mode, but not in the Text mode.
- Pictures will appear in the assigned order in the PR LIST (PR01-99).
- The guarded channel with the CHANNEL GUARD function will be skipped and will not be displayed.
- Pictures from external devices cannot be displayed in the 9-pictures multi mode.
- In the 5-pictures multi mode, the picture from external devices can only be displayed as the main picture.
- In the 5 pictures multi mode, 1125i signal cannot be displayed as the main picture.
- The RETURN+ button is disabled in the 9 pictures multi mode.
- In the multi-picture mode, the menu cannot be displayed.
- In the 5 pictures multi mode, the sound in the moving picture can be listened through the headphone.

Freeze function

1 Set the PIP/TV/DVD switch to the PIP position.

2 Press the  (Freeze) button.

Still picture is captured and displayed on the right side of the screen. On the left, the moving picture is displayed. While watching a picture, you can capture a still picture you want. The captured still picture and the moving picture are displayed at a time. (They are the pictures of the same source.)

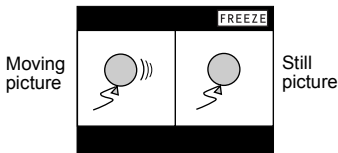

To return to the normal screen:

Press the  (Freeze) button again or press the BACK button, the CHANNEL \vee/\wedge buttons or the number buttons.

- The  (Freeze) button do not work in the Text mode, Twin mode, or PIP mode.
- The FREEZE function does not work for picture of 1125i signal.

Strobe function

You can display eight consecutive still pictures and one moving picture at a time. (They are the pictures of the same source.)

1 Set the PIP/TV/DVD switch to the PIP position.

2 Press the STROBE button.

Eight consecutive still pictures which are captured at intervals of about 0.2 second are displayed in the order of "1" to "9". (These numbers are not actually displayed.)

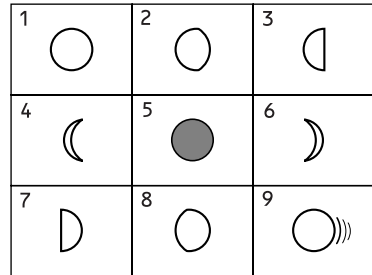

To return to the normal screen:

Press the STROBE button again or press the BACK button, the CHANNEL \vee/\wedge buttons or the number buttons.

- If signal level of the main picture is weak, the still images become abnormal.
- The STROBE button do not work in the Text mode, Twin mode, or PIP mode.
- The STROBE function does not work for picture of 1125i signal.
- The menu cannot be displayed in the STROBE mode.

Operating a JVC brand DVD player

You can operate a JVC brand DVD player. Pressing the button having the same appearance as the original remote control button of a device makes the function work in the same way as the original remote control.

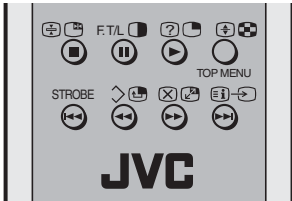

1 Set the PIP//TV/DVD Switch to the DVD position

When you are operating the DVD player, set the switch to the DVD position.

- You can turn the DVD player on or off with the \odot/I (Standby) button.
- You can also press the MENU or TOP MENU button and display the DVD disc menu screen, and then operate by pressing the $\blacktriangleleft/\blacktriangleright/\blacktriangledown/\blacktriangleup$ buttons.

2 Press the DVD Control Button to control your DVD player

- If your device is not made by JVC, these buttons cannot be used.
- Even if your device is made by JVC, some of these buttons or any one of the buttons may not work, depending on the device.

You cannot turn the TV on or off when the PIP//TV/DVD switch is set to the DVD position. When you turn the TV on or off, set the PIP//TV/DVD switch to the TV or PIP position.

Viewing a teletext programme

- 1 Choose a TV channel with a teletext broadcast.
- 2 Set the PIP//TV/DVD switch to the TV position.



3 Press \equiv (Text) button to display the teletext.

Pressing \equiv (Text) button changes the mode as follows:

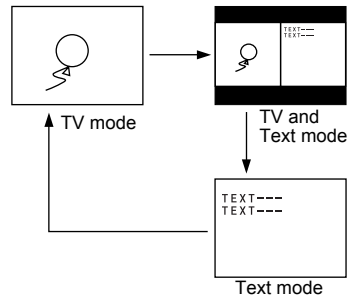

4 Choose a teletext page by pressing the CHANNEL \vee/\wedge buttons, number buttons or colour buttons.

To return to the TV mode:

Press the \equiv (Text), BACK or TV/VIDEO button.

- If you have trouble receiving teletext broadcasts, consult your local dealer or the broadcast station.
- In the Text mode, the ZOOM mode is fixed to the REGULAR mode.
- No menu operations are possible when viewing a teletext programme.
- If characters on a teletext programme do not appear properly, change the TELETEXT LANGUAGE setting. For details, see "TELETEXT LANGUAGE" on page 34.

 (Hold) button

You can hold a teletext page on the screen for as long as you want, even while several other teletext pages are being received.

Press the  (Hold) button.

The  (hold) are displayed at the top left of the screen.

To cancel the Hold function:

Press the  (Hold) button again.

 (Reveal) button

Some teletext pages include hidden text (such as answers to a quiz).

You can display the hidden text.

Each time you press the  (Reveal) button, text is hidden or revealed.

 (Size) button

You can double the height of teletext display.

Press the  (Size) button.** (Index) button**

You can return to the index page instantly.

Press the  (Index) button.

- In the List mode, you can return to the page number displayed in the lower left area of the screen.

 (Cancel) button

You can search for a teletext page while watching TV.

1 Press the number button to enter a page number, or press the colour button.

The TV searches for a teletext page.

2 Press the  (Cancel) button.

The TV programme appears. When the TV finds the teletext page, its page number appears in the upper left of the screen.

3 Press the  (Cancel) button to return to a teletext page when the page number is on the screen.

- You cannot return to the TV mode with the  (Cancel) button.

Sub-page

Some teletext pages include sub-pages that are automatically displayed.

1 Choose a teletext page that includes sub-pages.

Sub-page numbers that can be viewed are automatically displayed at the top of the screen.

2 Press the /▶ buttons to choose a sub-page number.

Using the List mode

You can store the numbers of your favorite teletext pages in memory and call them up quickly using the colour buttons.

To store the page numbers:

1 Press the F.T/L button to engage the List mode.

The stored page numbers are displayed at the bottom of the screen.

2 Press a colour button to choose a position. Then press the number buttons to enter the page number.

3 Press and hold down the \diamond (Store) button.

The four page numbers blink white to indicate that they are stored in memory.

To call up a stored page:

1 Press the F.T/L button to engage the List mode.

2 Press a colour button to which a page has been assigned.

To exit the List mode:

Press the F.T/L button again.

Using the TV's menu

This TV has a number of functions you can operate using menus.

To fully utilize all your TV's functions, you need to understand the basic menu operating techniques fully.

Buttons used to operate the menus

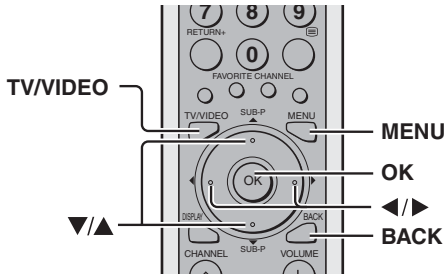

- 1 Press the **MENU** button to display the menu bar

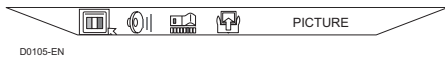

- 2 Press the **◀/▶** buttons to choose the menu you want to use and then press the **OK** button



- 3 Press the **▼/▲** buttons to choose the item to be set, press the **◀/▶** buttons to set the item, and then press the **OK** button

If there are sub-menus, use the **◀/▶/▼/▲** buttons to operate them.

- Press the **BACK** button to return to the previous menu.
- Press the **TV/VIDEO** or **MENU** button to exit from the menu.

Types of menu



PICTURE menu

Choose to set the screen settings.



SOUND menu

Choose to set the sound settings.



FEATURES menu

Choose to set the sleep timer and child lock settings.



SET UP menu

Choose to edit the channels or set the display language settings.

The menu guide area can be made to appear and disappear for some menus. While the menu is displayed, press the **DISPLAY** button to change between the guide area being displayed and not displayed.

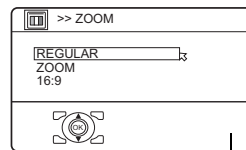

D0017-EN



Guide area

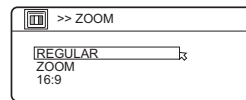

D1017-EN

- The guide area for some menus will still be displayed even if the **DISPLAY** button is pressed. This is not a malfunction.

Operation with the buttons on the TV

You can also operate the menus using the buttons on the front panel of the TV.

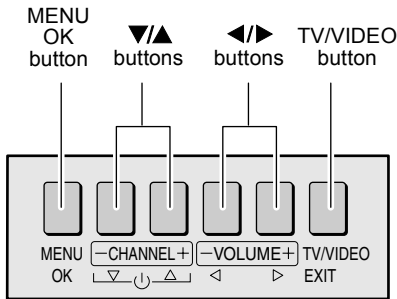

- The OK button acts as the MENU button when the menu bar is not displayed, and as the OK button when the menu bar is displayed.
- Press the TV/VIDEO button to exit from the menu.

PICTURE menu

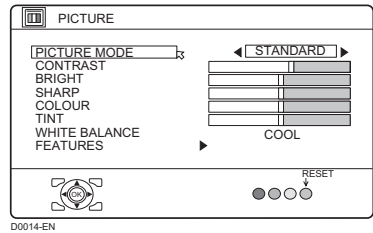

■ PICTURE MODE

You can choose one of three PICTURE MODEs to adjust the picture settings automatically.

BRIGHT:

Heightens contrast and sharpness.

STANDARD:

Standardizes picture adjustment.

SOFT:

Softens contrast and sharpness.

■ Adjusting the picture

You can change the picture settings of each picture mode, as you like. The picture settings changed are stored in the picture mode.

CONTRAST

You can adjust the picture contrast.

◀ : lower

▶ : higher

BRIGHT

You can adjust the picture brightness.

◀ : darker

▶ : brighter

SHARP

You can adjust the picture sharpness.

◀ : softer

▶ : sharper

COLOUR

You can adjust the picture colour.

◀ : lighter

▶ : deeper

TINT

You can adjust the picture tint.

◀ : reddish

▶ : greenish

- You can change the TINT setting (picture tint) only when the colour system is NTSC 3.58 or NTSC 4.43.

To return to the default settings in each PICTURE MODE:

Press the blue button. This will return the picture settings in the currently chosen PICTURE MODE to the default settings, and stores them in the PICTURE MODE again.

■ WHITE BALANCE

You can select one of three WHITE BALANCE modes (three tones of white) to adjust the white balance of the picture. Since white is the colour which is used as a reference for all the other colours, changing the WHITE BALANCE mode affects the appearance of all the other colours on the screen.

COOL:

A bluish white. Using this mode when watching bright pictures allows you to enjoy a more vivid and bright picture.

MID:

The normal white colour.

WARM:

A radish white. Using this mode when watching films allows you to enjoy colours that are characteristic of films.

FEATURES menu

Choose FEATURES in the "PICTURE" menu and press the **OK** or **▶** button to display the sub-menu.

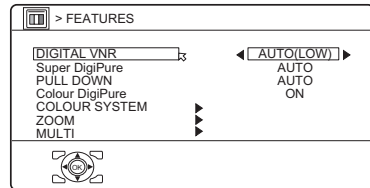
**■ DIGITAL VNR**

The DIGITAL VNR function cuts down the amount of noise in the original picture. You can choose from the four DIGITAL VNR function settings of AUTO(LOW), AUTO(HIGH), MIN and MAX.

AUTO(LOW)/AUTO(HIGH):

The TV will automatically adjust the level of the DIGITAL VNR effect to match the amount of noise in the picture, giving you the best possible picture.

- If you set the DIGITAL VNR effect too high it can make the picture less sharp. It is recommended to use the AUTO(LOW) setting if you can. If you set the DIGITAL VNR function to AUTO(LOW) but still notice some noise, change the setting from AUTO(LOW) to AUTO(HIGH).

MIN:

The level of the DIGITAL VNR effect is set to the minimum. If you set the DIGITAL VNR function to AUTO(LOW) but feel that the sharpness of the original picture has not been reproduced fully, change the setting from AUTO(LOW) to MIN.

- The MIN setting is not suitable for low-quality pictures which contain a lot of noise.

MAX:

The level of the DIGITAL VNR effect is set to the maximum. If you set the DIGITAL VNR function to AUTO(HIGH) but still notice some noise, change the setting from AUTO(HIGH) to MAX.

- The MAX setting is not suitable for high-quality pictures which contain very little noise.

■ **Super DigiPure**

The Super DigiPure function uses the latest in digital technology to give you a natural-looking picture. The Super DigiPure function includes the following two functions.

DigiPure function:

This function helps to create a natural-looking picture by eliminating unnecessary edges from high-contrast and crisp images. For images with low-contrast, edges are added to produce a sharper, more detailed picture.

You can choose from the three DigiPure function settings of AUTO, MIN and MAX.

- If you set the DigiPure effect too high on a low-quality picture that contains a lot of noise, this may actually make the noise worse. We recommend you use the AUTO setting if you can.

Picture motion compensation function:

This function displays fast-moving pictures (for example, the players or ball in a football game) more smoothly and naturally on the screen.

- The effect level of the picture motion compensation function cannot be changed. The effect level is the same no matter which of the AUTO, MIN or MAX settings is used.

AUTO:

The TV will automatically adjust the level of the DigiPure effect to match the amount of noise in the picture, giving the best possible picture.

MIN:

The level of DigiPure effect is set to the minimum. When you set the Super DigiPure function to AUTO and notice some noise, change the setting from AUTO to MIN.

- The MIN setting is not suitable for high-quality pictures which contain very little noise.

MAX:

The level of DigiPure effect is set to the maximum. If you set the Super DigiPure function to AUTO but feel that the original picture quality has not been reproduced fully, change the setting from AUTO to MAX.

- The MAX setting is not suitable for low-quality pictures which contain a lot of noise.

OFF:

The Super DigiPure function is turned off.

■ **PULL DOWN**

The PULL DOWN function displays a cinema film picture more smoothly and naturally on the screen.

AUTO:

This function is turned on. Normally keep this function set to AUTO.

ON :

This function is turned on.

OFF:

This function is turned off.

- The motion may appear unnatural when viewing images with the NTSC colour system. To make the motion smoother, switch the PULL DOWN function from AUTO or ON to OFF.

■ Colour DigiPure

Makes the colour outline stand out and increases the sharpness giving a clearer picture.

ON:

Colour DigiPure works. Normally use with this function turned on.

OFF:

Colour DigiPure doesn't work. This gives a less clear picture than when this function is turned on.

■ COLOUR SYSTEM

The colour system is chosen automatically. However, if the picture is not clear or no colour appears, choose the colour system manually.

1 Choose COLOUR SYSTEM. Then press the OK or ► button

The sub-menu of the COLOUR SYSTEM function appears.

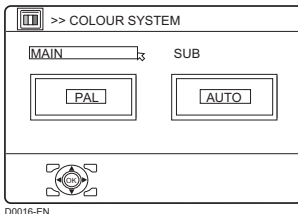

2 Press the ◀/▶ buttons to choose MAIN or SUB

MAIN:

You can change the colour system of the main-picture.

SUB:

You can change the colour system of the sub-picture.

- Choose MAIN when a sub-picture is not displayed.

3 Press the ▼/▲ buttons to choose the appropriate colour system. Then press the OK button

PAL:

PAL system

SECAM:

SECAM system

NTSC 3.58:

NTSC 3.58 MHz system

NTSC 4.43:

NTSC 4.43 MHz system

AUTO:

This function detects a colour system from the input signal.

- The AUTO function may not function properly if you have poor signal quality. If the picture is abnormal in the AUTO function, choose another colour system manually.

For colour system in your country or region, refer to the table below:

Area	Country or Region	System
Asia, Middle East	Bahrain, Kuwait, Oman, Qatar, United Arab Emirates, Yemen, etc.	PAL
	Indonesia, Malaysia, Singapore, Thailand, India, etc.	
	China, Vietnam, etc.	PAL
	Hong Kong, etc.	PAL
	Islamic Republic of Iran, Lebanon, Saudi Arabia, etc.	SECAM
	Philippines, Taiwan, Myanmar, etc.	NTSC
Europe	Russia, etc.	SECAM
	Czech Republic, Poland, etc.	PAL
	Germany, Holland, Belgium, etc.	PAL
	UK, etc.	PAL
Oceania	Australia, New Zealand, etc.	PAL
Africa	Republic of South Africa, etc.	PAL
	Nigeria, etc.	PAL
	Egypt, Morocco, etc.	SECAM

■ ZOOM

You can change the screen size according to the picture aspect ratio. Choose the optimum one from three ZOOM modes.

- 1 Choose **ZOOM**, then press the **OK** or **▶** button.

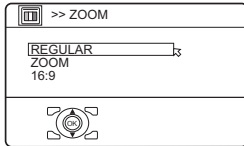

- 2 Press the **▼/▲** buttons to choose a **ZOOM** mode. Then press the **OK** button.

- You can choose a ZOOM mode from REGULAR, ZOOM or 16:9 modes. For details, see “ZOOM button” on page 9.

■ MULTI

Choosing the number of pictures for the Multi-picture function.

- 1 Choose **MULTI**, then press the **OK** or **▶** button.

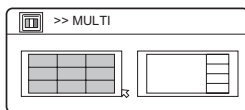

- 2 Press the **◀/▶** buttons to choose the number of pictures. Then press the **OK** button.

SOUND menu

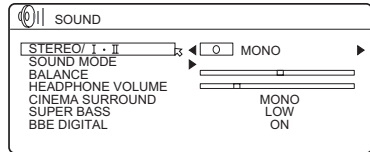

OSD-3-EN

- Functions in the “SOUND” menu other than “HEADPHONE VOLUME” work for the TV speakers. They do not work for the sound from the headphones.
- When the headphones are connected and only one screen is displayed, “STEREO/I•II” and “HEADPHONE VOLUME” can be used.

■ STEREO / I•II

When you are viewing a bilingual broadcast programme, you can choose the sound from Bilingual I (sub I) or Bilingual II (sub II). When the stereo broadcasting is received poorly, you can change from stereo to mono sound so that you can hear the broadcast more clearly and easily.

∞ : Stereo sound

○ : mono sound

I : Bilingual I (sub I)

II : Bilingual II (sub II)

MONO: Cancels the Multi Sound function, and the sound becomes monaural.

- The sound mode you can choose differs depending on the TV programme.
- This function does not work in the VIDEO modes.

■ SOUND MODE

Register your preferred pattern in the SOUND MODE USER.

1 Choose SOUND MODE, then press the OK or ► button.

The "SOUND MODE" menu appears.

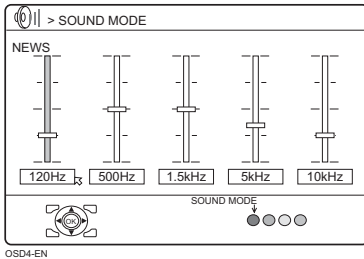

2 Press the red button and choose your preferred SOUND MODE.

3 Press the ◀/▶ buttons and choose the frequency to adjust, then press the ▼/▲ buttons and adjust the frequency.

- The adjusted frequency is registered to USER.
- When DYNAMIC, MUSIC, or NEWS is chosen and the frequency is adjusted, the SOUND MODE automatically changes to USER.
- Adjust the other frequencies according to your preference.
- After adjusting the frequencies in step 3, pressing the blue button will return to the SOUND MODE pattern chosen in step 2.
- You can choose a SOUND MODE function with the SOUND MODE button. For details, see "SOUND MODE button" on page 10.

■ BALANCE

You can adjust the volume balance between the left and right speakers.

- ◀ : turn the left speaker's volume level up.
- ▶ : turn the right speaker's volume level up.

■ HEADPHONE VOLUME

Adjust the volume of the sub-picture sound which is heard through the headphones when set to Twin mode, PIP mode or 5 pictures multi.

- ◀ : Reduce volume
- ▶ : Increase volume

- When not set to Twin mode or PIP mode, the headphone volume is adjusted with the ◀ -/+ (volume) buttons.

■ CINEMA SURROUND

You can enjoy Surround sound with a "live" effect by using the CINEMA SURROUND function.

- You can choose a CINEMA SURROUND mode from HIGH, LOW, MONO and OFF modes. For details, see "CINEMA SURROUND button" on page 9.
- You can also operate the CINEMA SURROUND function with the CINEMA SURROUND button. For details, see "CINEMA SURROUND button" on page 9.

■ SUPER BASS

You can choose the SUPER BASS mode which emphasizes the bass sound.

- You can choose HIGH, MID or LOW. Choosing LOW will reduce the bass sound and choosing HIGH will increase the bass sound.
- You can also operate the SUPER BASS function with the BASS button. For details, see "BASS button" on page 10.

■ BBE DIGITAL

You can use the BBE DIGITAL function to enjoy easy-to-listen sound that is faithful to the original sound recorded.

- You can choose ON or OFF.
- Licensed by BBE Sound, Inc. BBE is a registered trademark of BBE Sound, Inc.

FEATURES menu

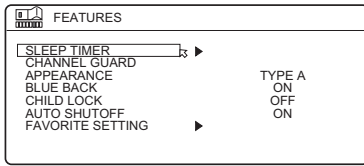

OSD-5-EN

■ SLEEP TIMER

You can set the TV to automatically turn off after a set time.

- 1 Choose **SLEEP TIMER**, then press the **OK** or **▶** button.

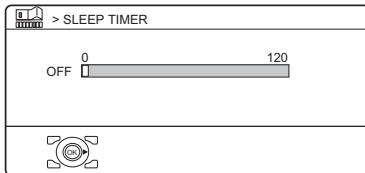

D0024-EN

- 2 Press the **◀/▶** buttons to set the period of time.

The TV begins count down from the set time.

- You can set the period of time a maximum of 120 minutes (2 hours) in 10 minute steps.

To cancel this function:

- Press the **◀** button to set a period of time to "OFF".

- 3 Press the **OK** button to complete the setting.

The menu disappears.

- One minute before this function turns off the TV, "GOOD NIGHT!" appears.
- This function cannot be used to turn off the TV's main power.
- When this function is on, you can display the SLEEP TIMER menu again to confirm or change the remaining time.

■ CHANNEL GUARD

When there is a TV channel you do not want your children to watch, you can lock out the channel. Even when a child chooses a programme number for a locked out channel the screen will change to blue and display **Ⓜ** so the channel cannot be viewed.

To set this function:

- 1 Choose **CHANNEL GUARD**, then press the number **0** button.

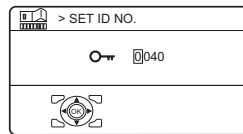

D0025-EN

- 2 Set the ID number you want.

To choose a number:

Press the **▼/▲** buttons.

To move a cursor:

Press the **◀/▶** buttons.

- 3 Press the **OK** button.

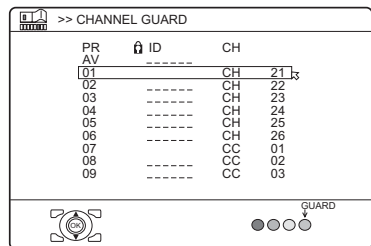

D0026-EN

- 4 Press the **▼/▲** buttons to choose a TV channel.

- The TV shows the TV programme which the chosen TV channel is now broadcasting.

- 5 Press the **blue** button to set this function to the TV channel.

Ⓜ (CHANNEL GUARD) appears and the TV channel is locked.

To cancel this function:

Press the blue button again.

Ⓜ (CHANNEL GUARD) disappears and the lock is released.

6 Press the OK button to complete the setting.

The menu disappears.

To view a locked TV channel:**1 Choose a programme number in which a TV channel locked with the number buttons or PR LIST.**

The screen changes to blue and the Ⓜ (CHANNEL GUARD) appears.

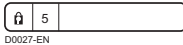

- You cannot choose a locked TV channel with the CHANNEL ∇/Δ buttons.

2 Press the DISPLAY button to display "ID NO." (ID number input screen).**3 Press the number buttons to enter the ID number.**

The lock is temporarily released so you can view the TV channel.

If you have forgotten the ID number:

Perform step 1 of "To set this function:" on page 26. After confirming the ID number, press the TV/VIDEO button to exit the menu.

- When you would like to cancel the CHANNEL GUARD function, you must perform the operation "To set this function" again.

■ APPEARANCE

Press the $\blacktriangleleft/\blacktriangleright$ button and choose the format in which the channel number is displayed from the three types: TYPE A, TYPE B and TYPE C.

■ BLUE BACK

You can set the TV to automatically change to a blue screen and mute the sound if the signal is weak or absent, or when there is no input from an external device.

ON:

This function is turned on.

OFF:

This function is turned off.

■ CHILD LOCK

You can disable the front control buttons of the TV. When this function is set to ON, the TV can be operated only by using the remote control.

Use this function to prevent children from operating the TV at their own discretion (without parent consent).

ON:

This function is turned on.

OFF:

This function is turned off.

Turning the power off with the main power button cancels the CHILD LOCK.

■ AUTO SHUTOFF

You can set the power to turn off if no signal is received and no operation is performed for about 15 minutes or longer after the end of a broadcast.

ON:

This function is turned on.

OFF:

This function is turned off.

- The AUTO SHUTOFF function does not turn off the TV's main power.
- The AUTO SHUTOFF will not work for a VIDEO mode.

■ FAVORITE SETTING

You can set a dedicated picture effect for the favorite channels registered to the colour buttons (Red, Green, Yellow and Blue). For favorite channel registration, see "Favorite channel registration" on page 11.

- 1 Choose **FAVORITE SETTING**, then press the **OK** or **▶** button.

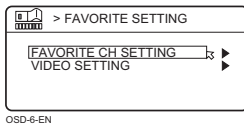

- 2 Choose **FAVORITE CH SETTING**, then press **OK** or **▶** button.

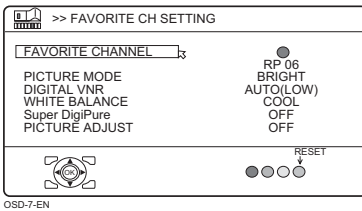

- 3 Press the **▼/▲** button to choose **FAVORITE CHANNEL**, then press the **◀/▶** button to choose the registered favorite channel.

Each time you press the **◀/▶** button, the colour button icon (Red, Green, Yellow or Blue) of the registered favorite channel and its channel number (e.g. PR1) appear.

- 4 Set the picture effect.

Press the **▼/▲** button to choose an item listed in the following table and press the **◀/▶** button to choose one of options.

- As explained in the table, if PICTURE EFFECT is set to OFF, the dedicated picture effect for the favorite channel is not used. In this case, normal picture effect is used.

- For details of each item, see "PICTURE MODE" on page 20, "DIGITAL VNR" on page 21, "WHITE BALANCE" on page 21, "Super DigiPure" on page 22.

Item	Options
PICTURE MODE	BRIGHT*, STANDARD, SOFT
DIGITAL VNR	AUTO (LOW)*, AUTO (HIGH), MIN, MAX
WHITE BALANCE	COOL, MID*, WARM
Super DigiPure	AUTO*, MAX, OFF, MIN
PICTURE EFFECT	ON*: Above picture effect applies to the chosen favorite channel. OFF: No picture effect applies.

*: When shipped

- Pressing the blue button returns each setting back to initial setting and cancels the favorite channel registration.

- 5 Press the **OK** button to complete the setting.

■ VIDEO SETTING

You can set a dedicated picture effect for the video inputs, VIDEO-1 to -4.

- 1 Choose **FAVORITE SETTING**, then press the **OK** or **▶** button.
- 2 Choose **VIDEO SETTING**, then press the **OK** or **▶** button.

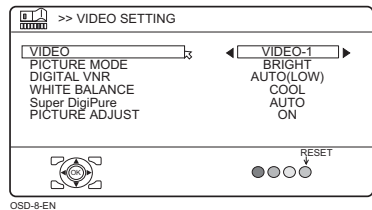

3 Press the **▼/▲** button to choose **VIDEO**, then press the **◀/▶** button to choose one of video inputs, **VIDEO-1** to **-4**.

4 Set the picture effect.

Press the **▼/▲** button to choose an item listed in the following table and press the **◀/▶** button to choose one of options.

- As explained in the table, if PICTURE EFFECT is set to OFF, the dedicated picture effect for the video inputs is not used. In this case, normal picture effect is used.

Item	Options
PICTURE MODE	BRIGHT*, STANDARD, SOFT
DIGITAL VNR	AUTO (LOW), AUTO (HIGH), MIN*, MAX
WHITE BALANCE	COOL, MID*, WARM
Super DigiPure	AUTO, MAX*, OFF, MIN
PICTURE EFFECT	ON*: Above picture effect applies to the chosen video input. OFF: No picture effect applies.

*: When shipped

- For details of each item, see "PICTURE MODE" on page 20, "DIGITAL VNR" on page 21, "WHITE BALANCE" on page 21, "Super DigiPure" on page 22.
- When the signal is 625p or 525p:
 - In "DIGITAL VNR", AUTO (LOW and HIGH) cannot be selected.
 - In "Super DigiPure", AUTO cannot be selected.
- Pressing the blue button will return the picture effect to the factory set value.

5 Press the **OK** button to complete the setting.

SETUP menu

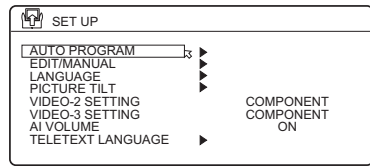

OSD-9-EN

■ AUTO PROGRAM

You can automatically register the TV channels which can be received well at your residence in the TV's programme numbers by performing the following.

1 Choose AUTO PROGRAM, then press the OK button.

The AUTO PROGRAM function starts. The TV channels you receive are automatically stored in the programme numbers list.

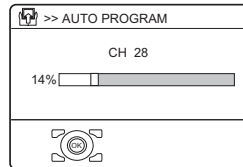

D0004-EN

- To stop the AUTO PROGRAM function, press the OK button.

2 After the TV channels have been stored in the programme number list, the EDIT menu appears.

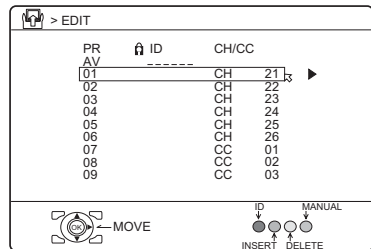

D0038-EN

- You can proceed to edit the programme numbers list using the EDIT/MANUAL function. For details, see "EDIT/MANUAL" on page 30
- If a TV channel you want to view is not stored in the programme numbers list, you can register it using the MANUAL function.
For details, see "EDIT/MANUAL" on page 30.
- The AUTO PROGRAM function does not store a TV channel to the programme number 0 (AV).
- If you do not need to use the EDIT/MANUAL function, press the OK button to exit the EDIT menu.
- Starting the AUTO PROGRAM deletes the registered favorite channel.

■ EDIT/MANUAL

The EDIT/MANUAL functions are divided into two types: editing of the current programme numbers (EDIT functions) and manual registration of a TV channel you want to view to the programme number (MANUAL function).

CAUTION

- Using the MOVE, DELETE or INSERT function rewrites the current programme numbers list.
Resultingly, the programme number of some of the TV channels will change.
- When a TV channel which has been locked out using the CHANNEL GUARD function, using the MANUAL function for that TV channel cancels the CHANNEL GUARD function.
- When a TV channel has already been registered in PR 99, using the INSERT function deletes the TV channel.

- 1 Choose **EDIT/MANUAL**, then press the **OK** or **▶** button.

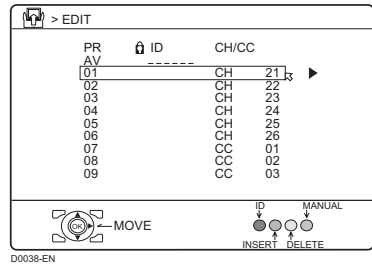

- 2 Follow the operation description of a function you want to use and operate the function.

MOVE:

This function changes a programme number of a TV channel.

ID:

This function registers a Channel name (ID) to a TV channel.

INSERT:

This function adds a new TV channel in the current programme numbers list by using the CH/CC number.

DELETE:

This function deletes an unnecessary TV Channel.

MANUAL:

This function manually registers a new TV channel in a programme number.

- 3 Press the **OK** button to complete the setting.

- For programme number PR 0, "AV" appears in the programme numbers list.

FUNCTIONS

MOVE

- 1 Press the **▼/▲** buttons to choose a TV channel.
- 2 Press the **▶** button to start the MOVE function.

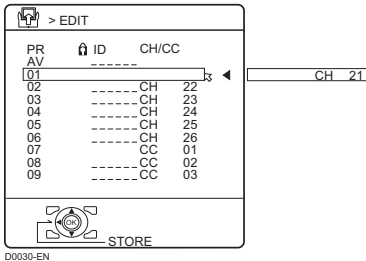

- 3 Press the **▼/▲** buttons to choose a new programme number.

To cancel the MOVE function:
Press the BACK button.

- 4 Press the **◀** button to change the programme number of a TV channel to a new programme number.

ID

- 1 Press the **▼/▲** buttons to choose a TV channel.
- 2 Press the red button to start the ID function.
- 3 Enter a channel name (ID). Press the **▼/▲** buttons to choose a character. Press the **◀/▶** buttons to move the cursor.

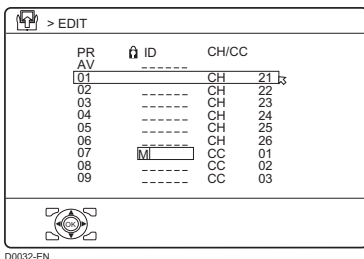

To cancel the ID function:

Press the BACK button.

- 4 Press the OK button to register a channel name to a TV channel.

DELETE

- 1 Press the **▼/▲** buttons to choose a TV channel.
- 2 Press the yellow button to delete the TV channel.

The TV channel is deleted from the programme numbers list.

MANUAL

- 1 Press the **▼/▲** buttons to choose a programme number to which you want to register a new TV channel.
- 2 Press the blue button to activate the MANUAL function.

At the right side following the CH/CC number, the SYSTEM (sound system) of the TV channel appears.

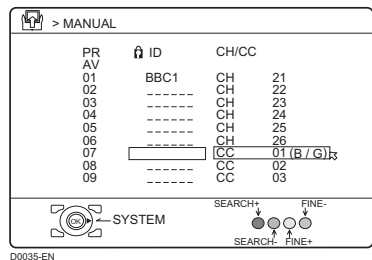

To cancel the MANUAL function:

Press the BACK button.

3 Press the ► button to choose the system (sound system) for a TV channel you want to register.

- For the sound systems in each country or region, refer to the table below:

Area	Country or Region	System
Asia, Middle East	Bahrain, Kuwait, Oman, Qatar, United Arab Emirates, Yemen, etc. Indonesia, Malaysia, Singapore, Thailand, India, etc.	B/G
	China, Vietnam, etc.	D/K
	Hong Kong, etc.	I
	Islamic Republic of Iran, Lebanon, Saudi Arabia, etc.	B/G
	Philippines, Taiwan, Myanmar, etc.	M
Europe	Russia, etc.	D/K
	Czech Republic, Poland, etc.	D/K
	Germany, Holland, Belgium, etc.	B/G
	UK, etc.	I
Oceania	Australia, New Zealand, etc.	B/G
Africa	Republic of South Africa, etc.	I
	Nigeria, etc.	B/G
	Egypt, Morocco, etc.	B/G

4 Press the green or red button to search for a TV channel.

Scanning stops when the TV finds a TV channel. Then the TV channel is displayed.

5 Press the green or red button repeatedly until the TV channel you want appears.

If the TV channel reception is poor:
Press the blue or yellow button to fine-tune the TV channel.

If you cannot hear the normal sound even when the picture of the TV channel appears normally:

The SYSTEM setting is wrong. Press the ► button and choose a SYSTEM that has normal sound.

6 Press the OK button and register the TV channel to a programme number.
The normal EDIT menu is resumed.

INSERT

Preparation:

- Find the CH/CC number corresponding to the channel number of the TV channel from page 35.

1 Press the ▼/▲ buttons to choose a programme number for which you will register a new TV channel.

2 Press the green button to start the INSERT function.

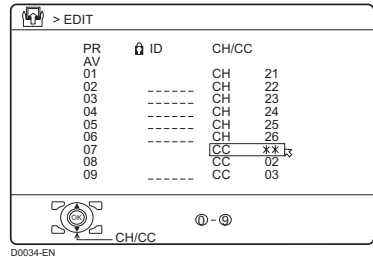

3 Press the ▼/▲ buttons to choose “CC” or “CH” according to the CH/CC number of the TV channel.

To cancel the INSERT function:
Press the BACK button.

4 Press the Number buttons to enter the remaining CH/CC number.

The TV shifts to registration mode. When the registration is completed, the picture of the TV channel appears on the screen.

- The CH/CC number is a number indicating the broadcast frequency to the TV. If the TV cannot detect the TV channel corresponding to the broadcast frequency indicated by the CH/CC number, a picture in the no-signal state appears.

■ LANGUAGE

You can choose the language you want to use for the on-screen display from the language list in a menu.

- 1 Choose **LANGUAGE**, then press the **OK** button.

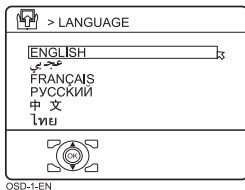

- 2 Press the **▼/▲** buttons to choose a language.
- 3 Press the **OK** button to complete the setting.
The menu disappears.

■ PICTURE TILT

There are cases where the Earth's magnetic force may make the picture tilt. If this happens, you can correct the picture tilt.

- 1 Choose **PICTURE TILT**, then press the **OK** or **▶** button.

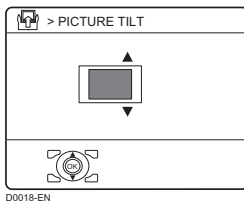

- 2 Press the **▼/▲** buttons until the picture becomes level. Then press the **OK** button.

■ VIDEO-2 SETTING/VIDEO-3 SETTING

Set the VIDEO-2 SETTING or VIDEO-3 SETTING correctly according to the video signal input from the external device connected to the VIDEO-2 or VIDEO-3 terminal. If this setting is incorrect, images will not be displayed.

VIDEO:

If a normal video signal (composite video signal) is input.

COMPONENT:

If a Component video signal (Y, Cb/Pb, Cr/Pr signals) is input.

- For detailed connecting methods, see "Additional preparation" on page 36. This Television is compatible with the 1125i, 625p or 525p video signal only when the component video signal is input.
- When the input signal is 1125i, 625p or 525p, each signal type is displayed at the upper right side on the TV screen by setting the input to VIDEO-2 or VIDEO-3.

■ AI VOLUME

You can prevent the sudden increase or decrease of sound that occurs when changing the channel to another channel or switching the VIDEO mode to another VIDEO mode.

ON:

This function is turned on.

OFF:

This function is turned off.

- The AI VOLUME function may not operate as expected if the sound input level from a broadcast station (or video software) is extremely low.
- When the Video or the DVD is used, it is recommended to select OFF to get more dynamic sound.

■ TELETEXT LANGUAGE

There are four types of teletext language groups. Set the teletext language group that corresponds to the language of the teletext program that you want to watch.

1 Choose TELETEXT LANGUAGE, then press the OK or ► button.

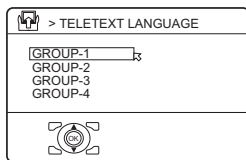

2 Press the ▼/▲ buttons to choose a group.

Group	Languages
GROUP-1	Turkish, Hungarian, English, German, French, Italian, Spanish, Portuguese, Greek, Swedish, Finnish
GROUP-2	Polish, Serbian, Croatian, Slovenian, Czech, Slovak, Rumanian, Hungarian, German, French, Italian, Swedish, Finnish
GROUP-3	Russian, Bulgarian, Lettish, Lithuanian, Estonian, Ukrainian, Serbian, Croatian, Slovenian, Czech, Slovak, English, German
GROUP-4	Arabic, Czech, Slovak, Hungarian, English, German, French, Italian, Spanish, Portuguese, Swedish, Finnish

3 Press the OK button to complete the setting.

The menu disappears.

- Languages that are not included in the teletext language group that you select, the sub-titles of the teletext program will not be displayed properly.

CH/CC number

When you want to use the INSERT function on page 32, find the CH/CC number corresponding to the Channel number of the TV channel from this table.

US: The US channel numbers are the channel numbers used in the United States, Philippines, etc. CCIR: The CCIR channel numbers are the channel numbers used in the Middle East, Southeast Asia, etc. OIRT: The OIRT channel numbers are the channel numbers used in Eastern Europe, Russia, Vietnam, etc. AUSTRALIA: The AUSTRALIA channel numbers are the channel numbers used in Australia, etc.

Channel					Channel				
CH	US	CCIR	OIRT	AUSTRALIA	CC	US	CCIR	OIRT	AUSTRALIA
CH 02	US-2	E2	R1	AU-0	CC 01		S-1		
CH 03	US-3	E3		AU-1	CC 02		S-2		AU-5
CH 04	US-4	E4	R2	AU-2	CC 03		S-3		
CH 05	US-5	E5	R6	AU-6	CC 04		S-4		
CH 06	US-6	E6	R7	AU-7	CC 05		S-5		
CH 07	US-7	E7	R8	AU-8	CC 06		S-6		AU-5A
CH 08	US-8	E8	R9	AU-9	CC 07		S-7		
CH 09	US-9	E9			CC 08		S-8		
CH 10	US-10	E10	R10	AU-10	CC 09		S-9		
CH 11	US-11	E11	R11	AU-11	CC 10		S-10		
CH 12	US-12	E12	R12		CC 11		S-11		
CH 13	US-13				CC 12		S-12		
CH 14	US-14, W+29				CC 13		S-13		
CH 15	US-15, W+30				CC 14	A	S-14		
CH 16	US-16, W+31				CC 15	B	S-15		
CH 17	US-17, W+32				CC 16	C	S-16		
CH 18	US-18, W+33				CC 17	D	S-17		
CH 19	US-19, W+34				CC 18	E	S-18		
CH 20	US-20, W+35				CC 19	F	S-19		
CH 21	US-21, W+36	E21			CC 20	G	S-20		
CH 22	US-22, W+37	E22			CC 21	H	S-21		
CH 23	US-23, W+38	E23			CC 22	I	S-22		
CH 24	US-24, W+39	E24			CC 23	J	S-23		
CH 25	US-25, W+40	E25			CC 24	K	S-24		
CH 26	US-26, W+41	E26			CC 25	L	S-25		
CH 27	US-27, W+42	E27			CC 26	M	S-26		
CH 28	US-28, W+43	E28			CC 27	N	S-27		
CH 29	US-29, W+44	E29			CC 28	O	S-28		
CH 30	US-30, W+45	E30			CC 29	P	S-29		
CH 31	US-31, W+46	E31			CC 30	Q	S-30		
CH 32	US-32, W+47	E32			CC 31	R	S-31		
CH 33	US-33, W+48	E33			CC 32	S	S-32		
CH 34	US-34, W+49	E34			CC 33	T	S-33		
CH 35	US-35, W+50	E35			CC 34	U	S-34		
CH 36	US-36, W+51	E36			CC 35	V	S-35		
CH 37	US-37, W+52	E37			CC 36	W	S-36		
CH 38	US-38, W+53	E38			CC 37	W+1	S-37		
CH 39	US-39, W+54	E39			CC 38	W+2	S-38		
CH 40	US-40, W+55	E40			CC 39	W+3	S-39		
CH 41	US-41, W+56	E41			CC 40	W+4	S-40		
CH 42	US-42, W+57	E42			CC 41	W+5	S-41		
CH 43	US-43, W+58	E43			CC 42	W+6			
CH 44	US-44, W+59	E44			CC 43	W+7			
CH 45	US-45, W+60	E45			CC 44	W+8			
CH 46	US-46, W+61	E46			CC 45	W+9			
CH 47	US-47, W+62	E47			CC 46	W+10			
CH 48	US-48, W+63	E48			CC 47	W+11			
CH 49	US-49, W+64	E49			CC 48	W+12			
CH 50	US-50, W+65	E50			CC 49	W+13			
CH 51	US-51, W+66	E51			CC 50	W+14			
CH 52	US-52, W+67	E52			CC 51	W+15			
CH 53	US-53, W+68	E53			CC 52	W+16			
CH 54	US-54, W+69	E54			CC 53	W+17			
CH 55	US-55, W+70	E55			CC 54	W+18			
CH 56	US-56, W+71	E56			CC 55	W+19			
CH 57	US-57, W+72	E57			CC 56	W+20			
CH 58	US-58, W+73	E58			CC 57	W+21			
CH 59	US-59, W+74	E59			CC 58	W+22			
CH 60	US-60, W+75	E60			CC 59	W+23			
CH 61	US-61, W+76	E61			CC 60	W+24			
CH 62	US-62, W+77	E62			CC 61	W+25			
CH 63	US-63, W+78	E63			CC 62	W+26			
CH 64	US-64, W+79	E64			CC 63	W+27			
CH 65	US-65, W+80	E65			CC 64	W+28			
CH 66	US-66, W+81	E66			CC 75		X		
CH 67	US-67, W+82	E67			CC 76		Y	R3	
CH 68	US-68, W+83	E68			CC 77		Z	R4	AU-3
CH 69	US-69, W+84	E69			CC 78		Z+1	R5	
					CC 79		Z+2		AU-4
					CC 95	A-5			
					CC 96	A-4			
					CC 97	A-3			
					CC 98	A-2			
					CC 99	A-1			

Additional preparation

■ Connecting the external devices

Connect the devices to the TV, paying attention to the following connection diagram.

Before connecting anything:

- Read the manuals provided with the devices. Depending on the devices, the connection method may differ from the figure. In addition, the device settings may be changed depending on the connection method to secure proper operation.
- Turn off all the devices including the TV.
- The “Specifications” on page 43 contains the details of the VIDEO terminals. If you are connecting a device not listed in the following connection diagram, see the “Specifications” to choose the best VIDEO terminal.
- Note that connecting cables are not supplied.

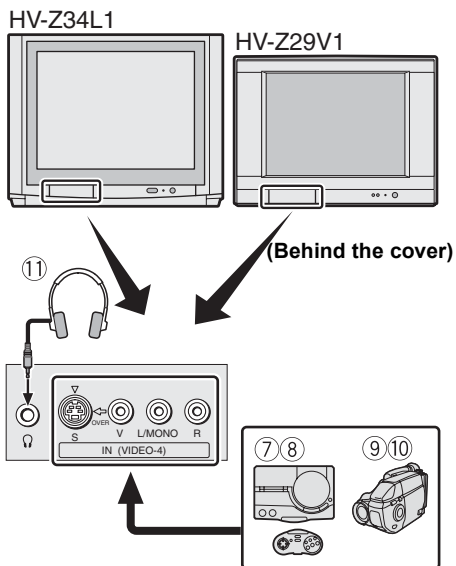

- ① VCR (composite signal)
- ② VCR (S-VIDEO signal; Y/C)
- ③ VCR for recording (composite signal)
- ④ DVD player (composite signal)
- ⑤ DVD player (S-VIDEO signal; Y/C)
- ⑥ DVD player (component video signals; Y, Cb/Pb, Cr/Pr)
- ⑦ TV game (composite signal)
- ⑧ TV game (S-VIDEO signal; Y/C)
- ⑨ Camcorder (composite signal)
- ⑩ Camcorder (S-VIDEO signal; Y/C)
- ⑪ Headphones

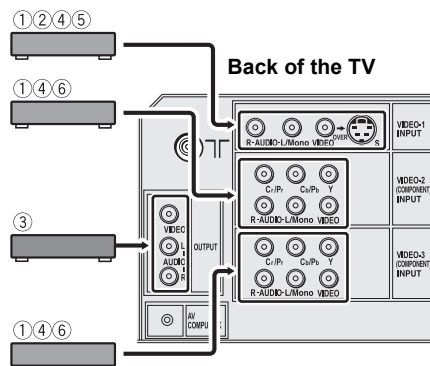

Connecting methods

- 1 **Connect the TV's VIDEO jack and the device's VIDEO OUT (video output) jack with a video cable.**

If connecting a device to the TV with an S-VIDEO cable:

Connect the VCR's S-VIDEO OUT (S-VIDEO output) connector and the TV's S connector with an S-VIDEO cable, instead of connecting with a video cable.

Note that the connection with a video cable will be ignored in case you connect a VCR to the TV with both video cable and S-VIDEO cable.

If connecting a DVD player to the TV with a component video cable.

Connect three jacks (Y, Cb/Pb, Cr/Pr) in the VIDEO-2 or VIDEO-3 terminal and the DVD player's COMPONENT (component video output) jacks with a component video cables, instead of connection with a video cable. Then set the VIDEO-2 SETTING/VIDEO-3 SETTING to COMPONENT, according to "VIDEO-2 SETTING/VIDEO-3 SETTING" on page 33.

- If you have a DVD player that outputs 1125i, 625p or 525p video signals as a component video signal, then by attaching the device to the television with a component video cable you can see the actual images that are recorded on a DVD disc as an original image source.

If connecting a device to the VIDEO-2 (COMPONENT) or VIDEO-3 (COMPONENT) terminal with a video cable.

Connect the TV's VIDEO jack and the device's VIDEO OUT (video output) jack with a video cable.

Then set the VIDEO-2 SETTING or VIDEO-3 SETTING to VIDEO according to "VIDEO-2 SETTING/VIDEO-3 SETTING" on page 33.

- In the VIDEO-4 terminal, the VIDEO jack is indicated by "V".

- 2 **Connect the TV's AUDIO jacks (L/MONO and R) and the device's AUDIO OUT (audio L/R output) jacks with an audio cable.**

If the device's sound output is in mono:

Connect the device's AUDIO OUT jack and the TV's L/MONO jack with an audio cable.

Connecting devices to the OUTPUT terminal

The signals of the images and sound you are currently viewing with this TV are output through the OUTPUT terminal. By connecting a VCR to the OUTPUT terminal, you can record the currently shown image and sound to that VCR. To do this, connect the VCR and OUTPUT terminal following the steps below.

- 1 **Connect the VIDEO jack in the OUTPUT terminal and the VCR's VIDEO IN (video input) jack with a video cable.**
- 2 **Connect the AUDIO jacks (L and R) in the OUTPUT terminal and the VCR's AUDIO IN (audio L/R input) jacks with an audio cable.**
 - When you turn off the TV, the signals from the OUTPUT terminal are also turned off.
 - The component signals input from the VIDEO-2 (COMPONENT) or VIDEO-3 (COMPONENT) terminal cannot be output through the OUTPUT terminal.

Connecting Headphones

Connect the headphones with a stereo mini jack (of 3.5 mm in diameter) to the Headphone jack at the TV front panel.

■ Connecting AV COMPU LINK Supported Devices

AV COMPU LINK remote control system is a system in which related devices are automatically controlled when you operate one device.

If you apply this system to the TV, you can have the TV automatically perform the required operations by operating one external device. You don't have to use the TV's remote control to turn on the TV or change the VIDEO modes.

Examples of the AV COMPU LINK remote control system operations

Simply by pressing the PLAY button on a VCR or a DVD player, you can view images from the device.

Simply by inserting a prerecorded tape (a tape with the record safety tab removed) to a VCR, you can view the tape.

Simply by operating the AV Control Receiver, you can have the TV turned on/off (in standby mode) or the VIDEO mode changed correctly.

- The performance of the AV COMPU LINK remote control system varies depending on the connected device. See the device's instruction manual.
- When you select "TV SOUND" as the input source with the AV Control Receiver, there are cases where the TV's MUTING function automatically operates and the sound from the TV's speakers is muted.

In such cases, press the VOLUME-/+ buttons or the MUTING button on the TV's remote control to cancel the MUTING function. You can regain the sound from the TV's speakers.

Conditions to use the AV COMPU LINK remote control system

- A device equipped with an AV COMPU LINK terminal is required.
- You must connect the TV and the device with an AV COMPU LINK cable. AV COMPU LINK cable is not supplied with this TV. If an AV COMPU LINK cable is unavailable, connect them with a cable with dia. 3.5 mm (mono) male plugs at both ends.
- You must connect the device to an appropriate VIDEO terminal and set it up correctly. Otherwise the AV COMPU LINK remote control system will not function correctly. For details, see "Setting up the AV COMPU LINK remote control system".
- The TV must be in standby mode (the POWER lamp lighting red). If the TV's Main power is off (the POWER lamp off), the AV COMPU LINK remote control system does not function.

Setting up the AV COMPU LINK remote control system

CAUTION:

- With some devices, the setup method differs from the ones explained here. Be sure to read the device's instruction manual thoroughly before setting it up.

1 Connect the device to the TV's VIDEO-1, VIDEO-2 (COMPONENT) or VIDEO-3 (COMPONENT) terminal.

If you want to connect a DVD player to the TV with a component video cable:

Connect the DVD player to the TV's VIDEO-2 (COMPONENT) or VIDEO-3 (COMPONENT) terminal.

- For detailed connecting instructions, see "Connecting the external devices" on page 36.

2 Connect the TV's AV COMPU LINK terminal and the device's AV COMPU LINK terminal with an AV COMPU LINK cable.

3 Change the device's setting according to the VIDEO terminal it is connected to.

If a VCR is connected to the VIDEO-1 terminal:

Set the VCR's remote control code to A code.

If a DVD player is connected to the VIDEO-1 terminal:

Set the DVD player's AV COMPULINK MODE to DVD2.

If a VCR is connected to the VIDEO-2 (COMPONENT) terminal:

Set the VCR's remote control code to B code.

If a DVD player is connected to the VIDEO-2 (COMPONENT) terminal:

Set the DVD player's AV COMPULINK MODE to DVD3.

If a DVD player is connected to the VIDEO-3 (COMPONENT) terminal with a component video cable:

Set the DVD player's AV COMPULINK MODE to DVD1.

- For instructions on how to change the device's setting, refer to the device's instruction manual.
- If the device you are connecting has neither the remote control code nor the AV COMPULINK MODE, then connect it to the TV's VIDEO-1 terminal.

Troubleshooting

If a problem arises while you are using the TV, please read this “Troubleshooting” well before you request having the TV repaired. You may be able to fix it easily by yourself. For example, if the AC plug is disconnected from the AC outlet, or the TV aerial has problems, you may think there is a problem with the TV itself.

Important:

- This Troubleshooting guide only covers problems whose causes are not easy to determine. If a question arise when you are operating a function, read the page(s) corresponding to the operation of the function well, not this Troubleshooting guide.
- After you have followed the Troubleshooting description or the operating description of the functions concerned without any success, remove the AC plug from the AC outlet and request a repair of your TV. Do not attempt to repair the TV by yourself or remove the rear cover of the TV.

■ If you cannot turn on the TV

- Is the AC plug connected to the AC outlet?
- Is the POWER lamp lit? If not, press the Main power button.
- Make sure to set the PIP/TV/DVD switch to the TV or PIP position. You cannot turn the TV on when the PIP/TV/DVD switch is set to the DVD position.

■ If you cannot turn off the TV

- Make sure to set the PIP/TV/DVD switch to the TV or PIP position. You cannot turn the TV off when the PIP/TV/DVD switch is set to the DVD position.

■ No picture/No sound

- Have you chosen a TV channel whose reception is extremely bad? In this case, the BLUE BACK function will be activated, the entire screen becomes blue, and the sound is muted. In spite of this, if you want to view the TV channel, follow the description “BLUE BACK” on page 27 to try to change the BLUE BACK function setting to OFF.
- Are your SOUND SYSTEM settings for the TV channels correct? Follow the description “EDIT/MANUAL” on page 30 to use the MANUAL function to try to change the SYSTEM setting.

■ Poor picture

- If noise totally obscures the picture (snow), the aerial or aerial cable may have trouble. Check the following to try to solve the trouble:
 - Has the TV and aerial been connected properly?
 - Has the aerial cable been damaged?
 - Is the aerial pointed to the right direction?
 - Is the aerial itself faulty?
- If the TV or aerial receives interference from the other devices, stripes or noise may appear in the picture. Move such device as an amplifier, personal computer, or a hair drier that can cause interference away from your TV, or try changing its location. If the aerial suffers interference from a radio tower or high-voltage wire, please contact your local dealer.
- If the TV receives interferences from signal reflecting from mountains or building, double-pictures (ghosting) will occur.
 - Try to change the aerial’s direction or replace the antenna with the one with better directionality.
- Are your COLOUR SYSTEM settings for the TV channels correct? Follow the description “COLOUR SYSTEM” on page 23 to try to solve the trouble.

- Has COLOUR or BRIGHT been controlled properly? Follow the description “Adjusting the picture” on page 20 to try to adjust them properly.
- Videotaping teletext is not recommended because it may not record correctly.
- When a white and bright still image (such as a white dress) is displayed on the screen, the white part may look as if it were coloured.
It is a phenomenon unavoidable due to the nature of the picture tube itself, and not due to a TV failure.
When the picture disappears from the screen, the unnatural colours will also disappear.
- When viewing images from commercially available video software products, or videos from videotapes which have been recorded improperly, the top of the image may be distorted. This is due to the condition of the video signal, and not because of malfunction.

■ Poor sound

- When the TV channel reception is poor, it can be hard to hear the stereo or bilingual sound. In this case, follow the description “STEREO / I•II” on page 24 to hear the sound more easily by changing it to a mono sound.

■ Operation disabled

- Have the batteries of the remote control become exhausted?
Follow the description “Putting the batteries into the remote control” on page 4 and replace them with new batteries to try solve the problem.
- Have you attempted to use the remote control at the sides or rear of the TV or at a location more than seven meters apart from the TV location? Operate the remote control in the front of your TV or a location less than seven meters from your TV to try to solve the problem.
- When you are viewing a teletext programme, you cannot operate the menus.
Press the BACK or TV/VIDEO button to return the teletext programme to the ordinary TV programme to try operating the menus.
- Is the CHILD LOCK function set to ON? If the CHILD LOCK function is set to ON, you cannot operate the TV with the front control buttons of the TV. Follow the description “CHILD LOCK” on page 27 to try to set the CHILD LOCK function to OFF.
- If the TV operation becomes disabled suddenly, press the Main power button on the TV and turn off the main power. Try to press the Main power button again to turn on the main power. If the TV returns to a normal state, it is not a failure.
- The following functions do not operate when receiving 1125i, video signal.
 - Twin, PIP, Multi-display, FREEZE and STROBE functions

■ **Other concerns**

- When the AUTO SHUTOFF function operates, the TV is automatically turned off.
If the TV is turned off suddenly, try to press the \odot /I button to turn on the TV once again. At this time, if the TV resumes a normal state, there is no problem.
- If you bring a magnetized device such as a speaker near to your TV, a picture may be warped or unnatural colours appear at the corners of the screen. In this case, keep the device apart from your TV. If the speaker causes such phenomena, use the magnetic-shielded speaker instead.
- A picture may be tilted due to the influence of the earth's magnetism. In this case, use the "PICTURE TILT" on page 33 to complete the tilt.
- It takes a short period of time from the time an operation such as changing channels is performed until an image is displayed. This is not a malfunction. This is the time required for the image to stabilize before it can be displayed.
- The TV may emit a crackling sound due to a sudden change in temperature. It does not matter if a picture or sound does not show any abnormality. If you hear crackling sounds frequently while you are viewing the TV, other causes may be assumed.
For precautionary purposes, request your service technician to inspect it.

- Touching the screen may cause you feel a slight electric shock due to its static electricity.
It is an unavoidable phenomenon due to the construction of the picture tube. It is not a problem with the TV. You can rest assured that this static discharge does not have harmful influence over the human body.

Specifications

Broadcasting systems	B, G, I, D, K, K1, M
Colour systems	PAL, SECAM, NTSC3.58/4.43MHz
Channels and frequencies	VHF low channel (VL) =46.25 to 168.25 MHz VHF high channel (VH) =175.25 to 463.25 MHz UHF channel (U) =471.25 to 863.25 MHz • Receives cable channels in mid band (X to Z+2, S1 to S10), super band (S11 to S20) and hyper band (S21 to S41).
Sound-multiplex systems	A2 (B/G), NICAM (B/G, I, D/K) system
Teletext systems	FLOF(Fastext), WST(World Standard Text)
Languages displayed by teletext	Please see the table in the description "TELETEXT LANGUAGE" on page 34.
Power requirements	AC 110 to 240V, 50/60Hz
Audio output	Rated Power output: 15W + 15W [HV-Z34L1], 10W + 10W + 18W [HV-Z29V1]
VIDEO-1 terminal	RCA connector × 3, S-VIDEO connector × 1 • Video input, S-VIDEO (Y/C) input and Audio L/R inputs are available.
VIDEO-2 (COMPONENT)	RCA connector × 6 • Video input, Component video (Y, Cb/Pb, Cr/Pr) input and Audio L/R inputs are available. • 625p, 525p and 1125i signals are available.
VIDEO-3 (COMPONENT)	RCA connector × 6 • Video input, Component video (Y, Cb/Pb, Cr/Pr) input and Audio L/R inputs are available. • 625p, 525p and 1125i signals are available.
VIDEO-4 terminal	RCA connector × 3, S-VIDEO connector × 1 • Video input, S-VIDEO (Y/C) input and Audio L/R inputs are available.
OUTPUT terminal	RCA connector × 3 • Video output and Audio L/R outputs are available.
Headphone jack	Stereo mini-jack (3.5 mm in diameter)
Accessories	Remote control unit × 1 (RM-C1850) AA/R6 dry cell battery × 2 Woofer unit × 1 [HV-Z29V1 only]
Speakers	HV-Z34L1: 12cm round × 2, 3.5cm round × 2 HV-Z29V1: (13cm × 6.5cm) oval × 2, 13cm round × 1(Woofer unit)

Design and specifications subject to change without notice.

Pictures displayed on the screen using this TV's ZOOM functions should not be shown for any commercial or demonstration purpose in public places (cafes, hotels, etc.) without the consent of the owners of copyright of the original picture sources, as this constitutes an infringement of copyright.

This TV does not conform to the PAL-D Chinese broadcasting system.

此种电视机不适用于PAL-D中国广播制式。



JVC



COLOUR TELEVISION

D.I.S.T.
Digital Image Scaling Technology

HV-Z34L1 HV-Z29V1

Contents

Setting up your TV.	3
TV buttons and functions.	6
Remote control buttons and functions.	8
Using the TV's menu.	19
PICTURE menu	20
FEATURES menu	21
SOUND menu	24
FEATURES menu	26
SETUP menu	29
Additional preparation	36
Troubleshooting.	40
Specifications	43

INSTRUCTIONS

 LCT1460-001A-H
1103-CR-JMT

© 2003 VICTOR COMPANY OF JAPAN, LIMITED

Thank you for buying this JVC colour television.

To make sure you understand how to use your new TV, please read this manual thoroughly before you begin.

WARNING: TO PREVENT FIRE OR SHOCK HAZARD, DO NOT EXPOSE THIS APPLIANCE TO RAIN OR MOISTURE.

CAUTION: TO ENSURE PERSONAL SAFETY, OBSERVE THE FOLLOWING RULES REGARDING THE USE OF THIS TV.

- 1 Operate only from the power source indicated on the rear of the TV.
- 2 Avoid damaging the power cord and mains plug. When unplugging the TV, grasp the mains plug. Do not pull on the power cord.
- 3 Never block or cover the ventilation openings.
Never install the TV where good ventilation is unattainable.
When installing this TV, leave spaces for ventilation around the TV of more than the minimum distances as shown.

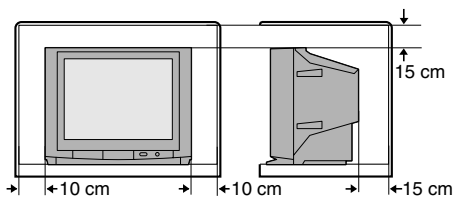

- 4 Do not allow objects or liquid into the cabinet openings.
- 5 In the event of a fault, unplug the unit and call a service technician. Do not attempt to repair it yourself or remove the rear cover.
- 6 The surface of the TV screen is easily damaged. Be very careful with it when handling the TV. Should the TV screen become soiled, wipe it with a soft dry cloth. Never use rub it forcefully. Never use any cleaner or detergent on it.
- 7 If you are not going to use this TV for a long period of time, be sure to disconnect the AC plug from the AC socket.
- 8 The apparatus shall not be exposed to dripping or splashing and that no objects filled with liquids, such as vases, shall be placed on the apparatus.

D.I.S.T. demonstration

To start the D.I.S.T. demonstration:

Press the **MENU** button to display the menu bar. Then press the yellow button.

A picture split in two (D.I.S.T. turned on and D.I.S.T. turned off) will appear on the screen.

To quit the D.I.S.T. demonstration:

Press the yellow button, **BACK** button, **CHANNEL** \vee/\wedge buttons or any of the number buttons.

Setting up your TV

CAUTION

- Turn off all the equipment including the TV before connecting anything.

1 Connecting the woofer unit (only for HV-Z29V1)

1 Fitting the woofer unit

Align the projection on the base of the woofer unit with the hole in the top of the TV, and insert the connector into the woofer terminal.

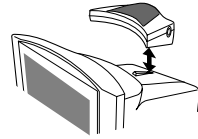

2 Connecting the supplied woofer connector to the BASS SPEAKER OUT terminal on the back of the TV

If the woofer unit is not connected, you will not be able to enjoy the bass sound.

- Connect so that the lever is raised.
- When disconnecting the woofer connector, do so while pushing the lever.

2 Connecting the aerial and VCR

- Aerial cable is not supplied. Use a good quality 75-ohm coaxial cable.
- Read the manual that came with the VCR before connecting.

If not connecting a VCR (see Fig. A):

Connect an aerial cable to the aerial socket on this TV.

If connecting a VCR (see Fig. B):

- 1 Connect the aerial cable to the aerial input socket on the VCR, and connect the VCR and TV with another aerial cable.

- 2 Connect the VCR's VIDEO OUT (video output) jack and the TV's VIDEO jack with a video cable.

To connect a VCR to the TV with an S-VIDEO cable:

Connect the VCR's S-VIDEO OUT (S-VIDEO output) connector and TV's S connector with an S-VIDEO cable (A), instead of connecting with a video cable.

- 3 Connect the VCR's AUDIO OUT (audio L/R output) jacks and the TV's AUDIO jacks (L/MONO and R) with an audio cable.

- If the VCR's audio output is in mono, connect the VCR's AUDIO OUT (audio output) jack and the TV's AUDIO L/MONO jack with an audio cable.

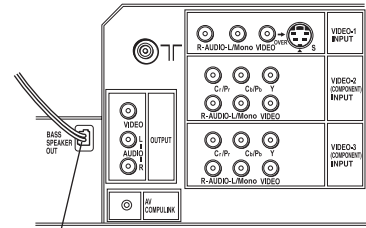

Lever

Fig. A

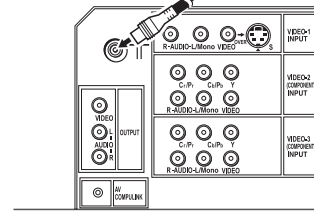
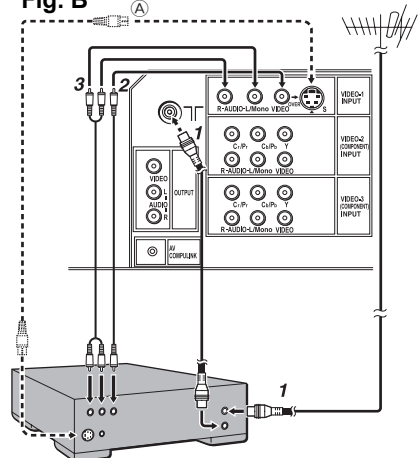

Fig. B



3 Connecting the power cord

Connect the mains plug to the AC outlet.

4 Putting the batteries into the remote control

Use two AA/R6 batteries.

Insert the batteries from the ⊖ end, making sure the ⊕ and ⊖ polarities are correct.

- Follow the warnings printed on the batteries.
- If the remote control does not work properly, replace the batteries.
- The batteries we supply are only for setting up and testing your TV. Please replace them as soon as necessary.

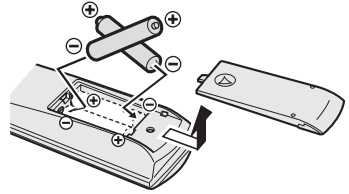

5 Making the initial settings (SETUP TOUR)

When the TV is first turned on, it enters the initial setting mode, and the JVC logo is displayed.

1 Press the main power button on the TV.

- The TV is turned on, and the JVC logo appears.
- If the POWER lamp on the TV lights red and does not change to green, your TV is in the standby mode. Press the ⏻/⏪ button on the remote control to turn the TV on.
 - If the JVC logo does not appear, your TV has already been turned before. In this case, use the “LANGUAGE”, “TELETEXT LANGUAGE” and “AUTO PROGRAM” functions to make the initial settings. For details, see “SETUP menu” on page 29.

2 Press the OK button on the remote control.

The LANGUAGE menu appears. You can choose a language for the on-screen language.

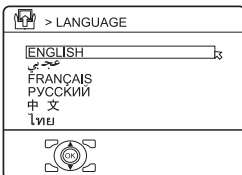
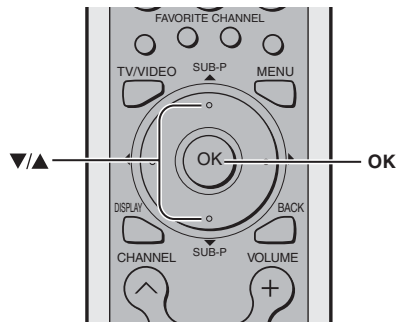
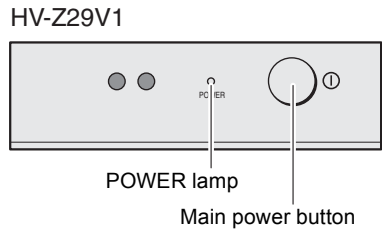
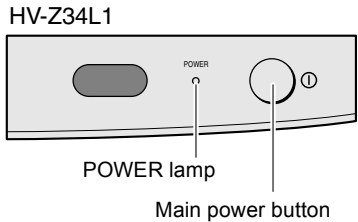

- 3 Press the ▼/▲ buttons to choose ENGLISH. Then press the OK button on the remote control.**

The TELETEXT LANGUAGE menu appears. Set the teletext language group that corresponds to the language of the teletext program that you want to watch. For details, see “TELETEXT LANGUAGE” on page 34.

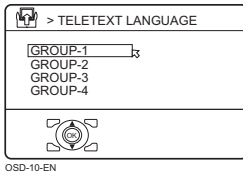

O5D-10-EN

- 4 Press the ▼/▲ buttons to choose a group. Then press the OK button.** The AUTO PROGRAM function starts. The TV channels you receive are automatically stored in the PR (programme numbers) LIST.

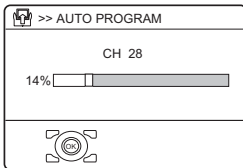

D0004-EN

- To stop the AUTO PROGRAM function, press the OK button.

- 5 After the TV channels have been stored in the programme numbers (PR) list, the EDIT menu appears.**

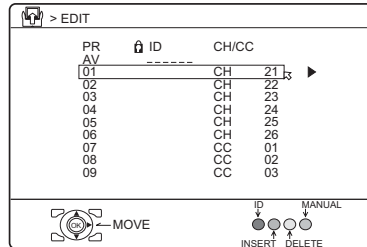

D0038-EN

- You can proceed to edit the programme numbers list using the EDIT/MANUAL function. For details, see “EDIT/MANUAL” on page 30.
- If a TV channel you want to view is not stored in the programme numbers list, you can register it using the MANUAL function. For details, see “EDIT/MANUAL” on page 30.
- The AUTO PROGRAM function does not store a TV channel to the programme number 0 (AV).
- If you do not need to use the EDIT/MANUAL function, press the OK button to close the EDIT menu.

Now, setting up is complete. Please enjoy your new JVC TV!

TV buttons and functions

HV-Z34L1

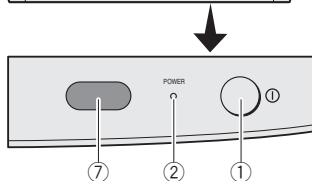
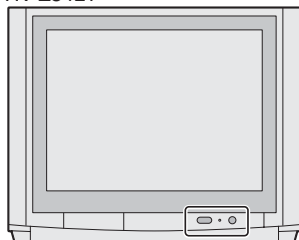

HV-Z29V1

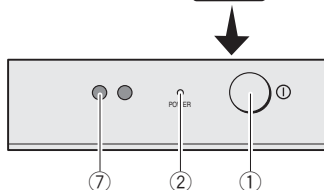
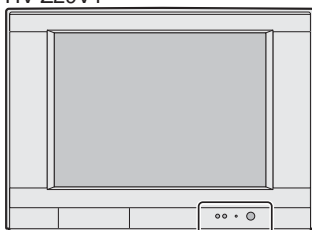

HV-Z29V1



HV-Z34L1

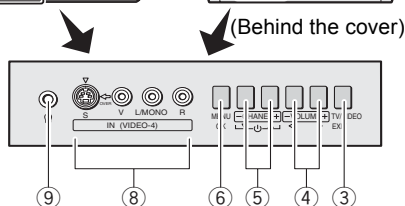

Turn the main power on

Press the main power button ①.

The POWER lamp ② lights red and your TV is in the standby mode.

To turn the main power off:

Press the main power button again. The POWER lamp ② goes off.

Turn the TV on from standby mode

Press the CHANNEL-/+ buttons ⑤.

The POWER lamp ② lights red to green and your TV will be turned on.

- You can also turn on the TV by pressing the TV/VIDEO button ③ while it is in standby mode.

Choose a TV channel

Press the CHANNEL-/+ buttons ⑤.

Choose a VIDEO terminal

Press the TV/VIDEO button ③ or CHANNEL-/+ buttons ⑤.

Adjust the volume

Press the VOLUME-/+ buttons ④.

The volume level indicator appears.

MENU button ⑥

Press to open the menu.

For details, see "Operation with the buttons on the TV" on page 20.

Remote control sensor ⑦

VIDEO-4 terminal ⑧

See page 36.

Headphone jack ⑨

Connect the headphones with a stereo mini-jack (3.5mm in diameter).

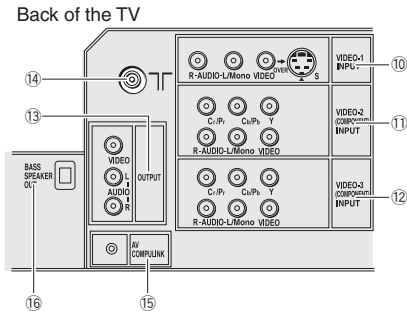

VIDEO-1 terminal ⑩

- See pages 3 and 36.

VIDEO-2 (COMPONENT) terminal ⑪

- See pages 33 and 36.

VIDEO-3 (COMPONENT) terminal ⑫

- See pages 33 and 36.

OUTPUT terminal ⑬

- See page 37.

Aerial socket ⑭

Connect the aerial cable.

- See page 3.

AV COMPU LINK terminal ⑮

- See page 38.

BASS SPEAKER OUT terminal ⑯ (only for HV-Z29V1)

- See page 3.

Remote control buttons and functions



Turn the TV on from standby mode

Press the **⏻/⏿** button.

The POWER lamp lights red to green and your TV will be turned on.

- You can turn on the TV from the standby mode by pressing the TV/VIDEO button, the CHANNEL ∇/\wedge buttons or the number buttons.

To turn the TV off:

Press the **⏻/⏿** button again.

The POWER lamp changes from green to red and the TV enters standby mode.

To turn the TV on or off, set the PIP/TV/DVD switch on the remote control to the TV or PIP position and press the **⏻/⏿** button.

If the PIP/TV/DVD switch on the remote control is set to the DVD position, the TV will not be turned on or off even if the **⏻/⏿** button is pressed.

Choose a TV channel

Choose a programme number in which a TV channel has been set.

Press the **CHANNEL ∇/\wedge** buttons or enter the programme number (PR) with the number buttons.

Example:

- PR 6 → press **6**
- PR 12 → press **1** and **2**
 - You can select a channel from the PR LIST. For details, see “DISPLAY button” on page 11.
 - If you do not have a clear picture or no colour appears, follow the operation procedure “COLOUR SYSTEM” on page 23.

Adjust the volume

Press the **VOLUME-/+** buttons.

Watch images from an external device

Choose a VIDEO terminal to which the external device has been connected.

Press the **TV/VIDEO** button.

- You can choose a VIDEO terminal with the **CHANNELV/∧** buttons or from the **PR LIST**.

To return to a TV channel:

Press the **TV/VIDEO** button, the **CHANNELV/∧** buttons or the number buttons.

🔇 (Muting) button

Press the 🔇 (Muting) button to turn off the volume. Pressing the 🔇 (Muting) button again resumes the previous volume level.

ZOOM button

You can change the screen size according to the picture aspect ratio. Choose the optimum one from the following ZOOM modes.

1 Press the ZOOM button to display the ZOOM menu.

- The ZOOM button works only in the normal screen.

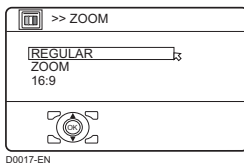

2 Press the ▼/▲ buttons to choose a ZOOM mode. Then press the OK button.

REGULAR:

Use to view a normal picture (4:3 aspect ratio) as its original size is.

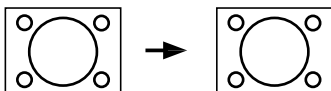

ZOOM:

You can zoom up the Wide picture (16:9 aspect ratio) to fill the TV screen.

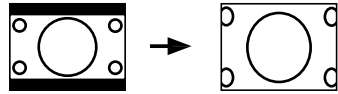

- The left side and right side of the Wide picture (16:9 aspect ratio) will be cut off.

16:9:

This mode converts a normal picture (4:3 aspect ratio) into a Wide picture (16:9 aspect ratio).

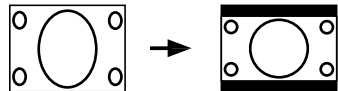

- Use for picture with a 16:9 aspect ratio that have been squeezed into a normal picture (4:3 aspect ratio), you can restore their original dimensions.
- When a 1125i signal is input, the 16:9 aspect ratio is chosen automatically.

CINEMA SURROUND button

You can enjoy an enhanced sound for a wider audience by using CINEMA SURROUND function.

Press the **CINEMA SURROUND** button to select one of **CINEMA SURROUND** modes.

HIGH/LOW:

When you listen to the stereo sound, please select HIGH or LOW mode.

You can enjoy the sound for a wider audience similar to the experience at the theatre.

When you combine the functions of SOUND MODE, SUPER BASS and DIGITAL BBE, you can enjoy more powerful sound.

- In case that you setting up the CINEMA SURROUND function to HIGH mode, there may be slight volume distortion. In case that occurs, please switch the HIGH mode to LOW mode, the effect of CINEMA SURROUND functions will be less noticeable, however, the volume distortion will be corrected.

MONO:

Select the MONO mode, when you listen to the mono sound.

You can enjoy the sound for a wider audience similar to stereo sound.

OFF:

The CINEMA SURROUND function switches off.

SOUND MODE button

You can select the SOUND MODE of you liking from 4 types of sound modes to fully enjoy the sound of your TV.

Press the SOUND MODE button to select one of sound modes.

DYNAMIC:

Dynamic sound is created by enhancing high and low tones.

You can get the 3D effect by using the CINEMA SURROUND function in this mode.

MUSIC:

The mode suitable for music programmes.

Enjoy a concert hall-like atmosphere.

Combination with the CINEMA SURROUND function will bring wider range sound.

NEWS:

The mode suitable for news programmes makes the voice of the newscaster or the like easier to hear.

USER:

Save your own sound setting to memory with this mode.

The USER setting is performed with the "SOUND MODE" menu (see page 25).

BASS button

You can choose the SUPER BASS mode which emphasizes the bass sound.

Press tge BASS button to select one of SUPER BASS modes.

You can choose HIGH, MID or LOW.

Choosing LOW will reduce the bass sound and choosing HIGH will increase the bass sound.

RETURN+ button

The RETURN+ button has two functions; the RETURN+ function and the RETURN function. If a channel has been registered as the "Return Channel", the RETURN+ function operates. If there is no setting for the "Return Channel", the RETURN function operates.

RETURN+ function

By registering a channel you frequently view as the "Return Channel", you can select that channel at any time simply by pressing the RETURN+ button.

To register a TV channel as the "Return Channel":

Choose the Programme number to which the channel you want to register has been set, and press the RETURN+ button and hold for more than 3 seconds continuously. "RETURN PLUS PROGRAMMED!" is displayed and the registration is completed.

To cancel a TV channel registered as the "Return Channel":

While viewing any TV channel, press the RETURN+ button and hold for more than 3 seconds continuously. "RETURN PLUS CANCELED!" is displayed and the registration is cancelled.

- When you turn off the TV, the registration for the "Return Channel" is cancelled.
- If you want to view the "Return Channel" and another TV channel alternately, first choose a channel other than the "Return Channel". And then press the RETURN+ button to change the channel to the "Return Channel" In this way, you can view two channels alternately by pressing the RETURN+ button.

RETURN function

The TV temporarily memorises the TV channel that was chosen right before the current TV channel as the “Last Channel”. By pressing the RETURN+ button, you can alternately view the current TV channel and the “Last Channel”.

- If you want to view two channels alternately by using the RETURN function, first choose one TV channel and then choose the other TV channel with the Number buttons. If you choose the TV channel without using the Number buttons, there are cases where a channel other than the one you first chose is registered as the “Last Channel”.

DISPLAY button

You can display the PR LIST, programme number or VIDEO terminal number on the screen.

Press the DISPLAY button.

Press the DISPLAY button changes the display as follows:

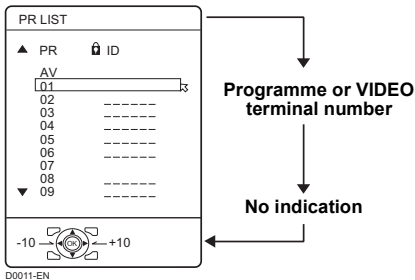

Choose a TV channel or a VIDEO terminal

1 Press the DISPLAY button to display the PR LIST.

2 Press the ▼/▲ and ◀/▶ buttons to choose a programme number or VIDEO terminal.

Then press the OK button.

- For programme numbers with the CHANNEL GUARD function set, the  (CHANNEL GUARD) mark is displayed next to the programme number in the PR LIST.
- The VIDEO terminals are registered after the programme number PR99.
- The AV channel (channel number 0) in the PR LIST will be chosen only if you connect the VCR to the TV with an aerial cable without connecting a video cable.

Favorite channel registration

You can register your favorite TV channels with the colour buttons (Red, Green, Yellow and Blue). After registration you can recall the favorite channel by pressing the colour button.

1 In the normal screen, choose a TV channel (PR01-99) you want to register.

For detailed operation, see “Choose a TV channel” on page 8.

2 Press and hold a colour button for 3 seconds or more.

Then “FAVORITE CH PROGRAMMED” appears on the screen and the current channel is registered.

- If the chosen channel is already registered as the favorite channel, when a colour button is pressed, the registered colour button icon appears on the top right of the screen.
- You cannot register in the Text mode, or while multiple screens, such as PIP (picture in picture) are displayed.
- Also you cannot register if the chosen channel is guarded with the CHANNEL GUARD function and the screen is blue, or if an on-screen menu is displayed.
- Starting the AUTO PROGRAM deletes the registered favorite channel.

■ Recalling the favorite channel

Press the colour button, then the registered favorite channel will be displayed.

- You cannot recall the favorite channel in the Text mode, Menu mode where an on-screen menu is displayed.
- The picture effect dedicated for the colour button applies. For details, see "Setting the picture effect" below:

■ Setting the picture effect

Each colour button has a dedicated picture effect. When you choose a favorite channel with a colour button, the dedicated picture effect is used. When shipped, the factory set picture effect is used for this purpose. However, you can set this picture effect as required. For details, see "FAVORITE SETTING" on page 28.

■ Showing the favorite channels

Press the DISPLAY button to display the PR LIST.

You can see the favorite channel that has the registered colour button icon at the right of the channel number.

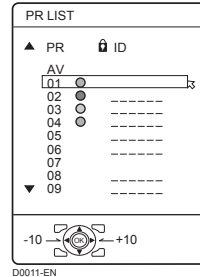

Twin and PIP (picture in picture) function

You can view two pictures (Main picture and sub picture). Two different TV programmes can be watched at the same time or a TV programme and a video programme from an external device can be watched at the same time.

Operate with the PIP/TV/DVD switch set to the PIP position.

Twin mode

Press .

Each time it is pressed the mode changes as shown below.

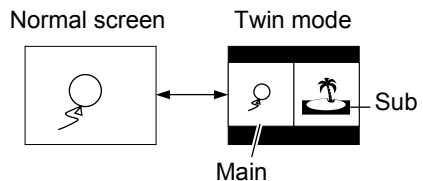

PIP (picture in picture) mode

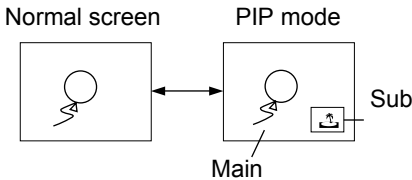

Press .

Each time it is pressed the mode changes as shown below.



To return to the normal screen:

Press the  or  again, or press the BACK button.

- The  and  buttons do not work in the Text mode.
- Twin and PIP functions do not work for a picture of 1125i signal.
- A picture of 625p or 525p signal cannot be displayed as the sub-picture.
 - Pay attention to the following.
 - When the VIDEO-2 or VIDEO-3 picture is a picture of 625p or 525p signal, you cannot choose VIDEO-2 or VIDEO-3 with the SUB-P▼/▲ buttons.
 - When the VIDEO-2 or VIDEO-3 picture signal is changed to 625p, 525p or 1125i signal while the VIDEO-2 or VIDEO-3 picture is displayed as the sub-picture, the Twin or PIP modes is cancelled.

■ Listening to the sound of the sub-picture:

You can listen to the sound of the sub-picture with the headphones while listening to the sound of the main-picture from the TV speakers.

For details, see "HEADPHONE VOLUME" on page 25.

- The sub-picture sound is monaural.

■ TV channel selection

For the main picture:

Choose a channel using the CHANNELV/∧ buttons or the number buttons.

For the sub picture:

Choose a channel using the SUB-P▼/▲ buttons.

■ Input source selection (TV, VIDEO-1, -2, -3 or -4)

For the main picture:

Press the TV/VIDEO button.

Each time you press the button, the input source changes as follows (the one used for the sub picture will be skipped):

VIDEO-1 → VIDEO-2 → VIDEO-3 → VIDEO-4 → TV

For the sub picture:

Press the  (Input) button.

Each time you press the button, the input source changes as follow (the one used for the main picture will be skipped):

VIDEO-1 → VIDEO-2 → VIDEO-3 → VIDEO-4 → TV

■ Swapping the pictures

Press the (Swap) button.

Each time you press the button, the main picture and the sub picture will be swapped.

- The pictures cannot be swapped when a picture of 625p or 525p signal from VIDEO-2 or VIDEO-3 is being displayed as the main picture.

■ Changing the sub picture position (in PIP mode only)

You can position the sub picture to one of corners of the main picture.

Press the  (Position) button.

Each time you press the button, the sub picture moves clockwise (lower right → lower left → upper left → upper right).

■ Setting the colour system of the sub picture

You can choose the colour system of the sub picture.

The setting is performed with the "COLOUR SYSTEM" menu (see page 23) when in the Twin mode or PIP mode.

Multi-picture function

You can display multi-pictures that enable you to easily find a program you want to view.

1 Set the PIP/TV/DVD switch to the PIP position

2 Press the button to display multi-pictures

The channels are displayed in the channel number order.

The multi-pictures will appear in one of the two multi-picture modes.

9 pictures multi:

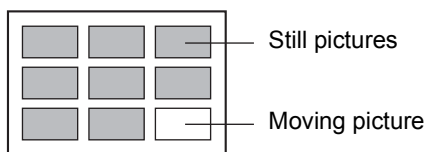

5 pictures multi:

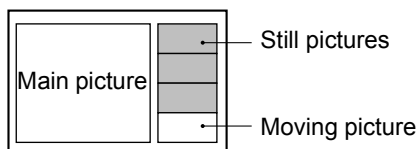

- To display the next multi-pictures, press the  button.

3 Choose the screen you want to view

The picture you choose changes to a moving picture.

9 pictures multi:

Choose by pressing ◀/▶▼/▲.

5 pictures multi:

Choose by pressing ▼/▲.

4 Press the OK button

The multi-pictures disappears and the chosen picture appears.

Changing the multi-picture mode:

See "MULTI" on page 24.

Cancelling the multi-pictures

Press the BACK button, CHANNEL V/∧ buttons, the number buttons or OK button.

- You can also enter this mode while in the Twin mode, but not in the Text mode.
- Pictures will appear in the assigned order in the PR LIST (PR01-99).
- The guarded channel with the CHANNEL GUARD function will be skipped and will not be displayed.
- Pictures from external devices cannot be displayed in the 9-pictures multi mode.
- In the 5-pictures multi mode, the picture from external devices can only be displayed as the main picture.
- In the 5 pictures multi mode, 1125i signal cannot be displayed as the main picture.
- The RETURN+ button is disabled in the 9 pictures multi mode.
- In the multi-picture mode, the menu cannot be displayed.
- In the 5 pictures multi mode, the sound in the moving picture can be listened through the headphone.

Freeze function

1 Set the PIP/TV/DVD switch to the PIP position.

2 Press the  (Freeze) button.

Still picture is captured and displayed on the right side of the screen. On the left, the moving picture is displayed. While watching a picture, you can capture a still picture you want. The captured still picture and the moving picture are displayed at a time. (They are the pictures of the same source.)

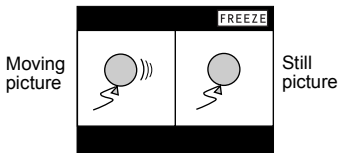

To return to the normal screen:

Press the  (Freeze) button again or press the BACK button, the CHANNEL \vee/\wedge buttons or the number buttons.

- The  (Freeze) button do not work in the Text mode, Twin mode, or PIP mode.
- The FREEZE function does not work for picture of 1125i signal.

Strobe function

You can display eight consecutive still pictures and one moving picture at a time. (They are the pictures of the same source.)

1 Set the PIP/TV/DVD switch to the PIP position.

2 Press the STROBE button.

Eight consecutive still pictures which are captured at intervals of about 0.2 second are displayed in the order of "1" to "9". (These numbers are not actually displayed.)

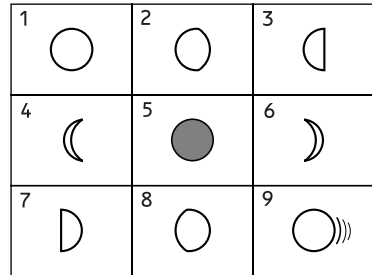

To return to the normal screen:

Press the STROBE button again or press the BACK button, the CHANNEL \vee/\wedge buttons or the number buttons.

- If signal level of the main picture is weak, the still images become abnormal.
- The STROBE button do not work in the Text mode, Twin mode, or PIP mode.
- The STROBE function does not work for picture of 1125i signal.
- The menu cannot be displayed in the STROBE mode.

Operating a JVC brand DVD player

You can operate a JVC brand DVD player. Pressing the button having the same appearance as the original remote control button of a device makes the function work in the same way as the original remote control.

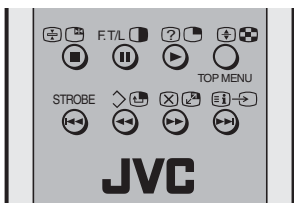

1 Set the PIP//TV/DVD Switch to the DVD position

When you are operating the DVD player, set the switch to the DVD position.

- You can turn the DVD player on or off with the \odot/I (Standby) button.
- You can also press the MENU or TOP MENU button and display the DVD disc menu screen, and then operate by pressing the $\blacktriangleleft/\blacktriangleright/\blacktriangledown/\blacktriangleup$ buttons.

2 Press the DVD Control Button to control your DVD player

- If your device is not made by JVC, these buttons cannot be used.
- Even if your device is made by JVC, some of these buttons or any one of the buttons may not work, depending on the device.

You cannot turn the TV on or off when the PIP//TV/DVD switch is set to the DVD position. When you turn the TV on or off, set the PIP//TV/DVD switch to the TV or PIP position.

Viewing a teletext programme

- 1 Choose a TV channel with a teletext broadcast.
- 2 Set the PIP//TV/DVD switch to the TV position.



3 Press \equiv (Text) button to display the teletext.

Pressing \equiv (Text) button changes the mode as follows:

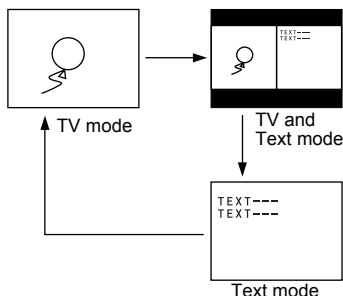

4 Choose a teletext page by pressing the CHANNEL \vee/\wedge buttons, number buttons or colour buttons.

To return to the TV mode:

Press the \equiv (Text), BACK or TV/VIDEO button.

- If you have trouble receiving teletext broadcasts, consult your local dealer or the broadcast station.
- In the Text mode, the ZOOM mode is fixed to the REGULAR mode.
- No menu operations are possible when viewing a teletext programme.
- If characters on a teletext programme do not appear properly, change the TELETEXT LANGUAGE setting. For details, see "TELETEXT LANGUAGE" on page 34.

 (Hold) button

You can hold a teletext page on the screen for as long as you want, even while several other teletext pages are being received.

Press the  (Hold) button.

The  (hold) are displayed at the top left of the screen.

To cancel the Hold function:

Press the  (Hold) button again.

 (Reveal) button

Some teletext pages include hidden text (such as answers to a quiz).

You can display the hidden text.

Each time you press the  (Reveal) button, text is hidden or revealed.

 (Size) button

You can double the height of teletext display.

Press the  (Size) button.** (Index) button**

You can return to the index page instantly.

Press the  (Index) button.

- In the List mode, you can return to the page number displayed in the lower left area of the screen.

 (Cancel) button

You can search for a teletext page while watching TV.

1 Press the number button to enter a page number, or press the colour button.

The TV searches for a teletext page.

2 Press the  (Cancel) button.

The TV programme appears. When the TV finds the teletext page, its page number appears in the upper left of the screen.

3 Press the  (Cancel) button to return to a teletext page when the page number is on the screen.

- You cannot return to the TV mode with the  (Cancel) button.

Sub-page

Some teletext pages include sub-pages that are automatically displayed.

1 Choose a teletext page that includes sub-pages.

Sub-page numbers that can be viewed are automatically displayed at the top of the screen.

2 Press the /▶ buttons to choose a sub-page number.

Using the List mode

You can store the numbers of your favorite teletext pages in memory and call them up quickly using the colour buttons.

To store the page numbers:

1 Press the F.T/L button to engage the List mode.

The stored page numbers are displayed at the bottom of the screen.

2 Press a colour button to choose a position. Then press the number buttons to enter the page number.

3 Press and hold down the \diamond (Store) button.

The four page numbers blink white to indicate that they are stored in memory.

To call up a stored page:

1 Press the F.T/L button to engage the List mode.

2 Press a colour button to which a page has been assigned.

To exit the List mode:

Press the F.T/L button again.

Using the TV's menu

This TV has a number of functions you can operate using menus.

To fully utilize all your TV's functions, you need to understand the basic menu operating techniques fully.

Buttons used to operate the menus

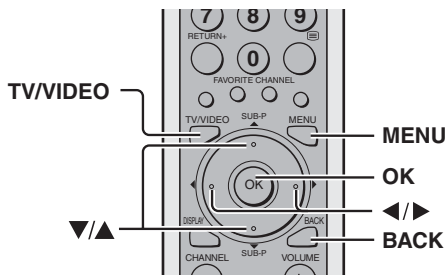

- 1 Press the **MENU** button to display the menu bar



- 2 Press the **◀/▶** buttons to choose the menu you want to use and then press the **OK** button



- 3 Press the **▼/▲** buttons to choose the item to be set, press the **◀/▶** buttons to set the item, and then press the **OK** button

If there are sub-menus, use the **◀/▶/▼/▲** buttons to operate them.

- Press the **BACK** button to return to the previous menu.
- Press the **TV/VIDEO** or **MENU** button to exit from the menu.

Types of menu



PICTURE menu

Choose to set the screen settings.



SOUND menu

Choose to set the sound settings.



FEATURES menu

Choose to set the sleep timer and child lock settings.



SET UP menu

Choose to edit the channels or set the display language settings.

The menu guide area can be made to appear and disappear for some menus. While the menu is displayed, press the **DISPLAY** button to change between the guide area being displayed and not displayed.

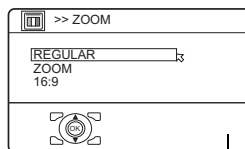

Guide area

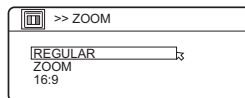

D1017-EN

- The guide area for some menus will still be displayed even if the **DISPLAY** button is pressed. This is not a malfunction.

Operation with the buttons on the TV

You can also operate the menus using the buttons on the front panel of the TV.

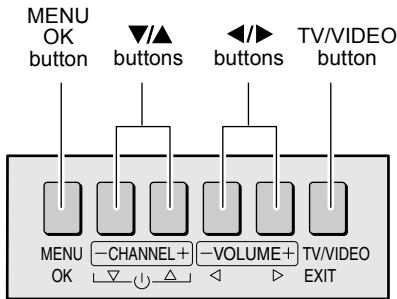

- The OK button acts as the MENU button when the menu bar is not displayed, and as the OK button when the menu bar is displayed.
- Press the TV/VIDEO button to exit from the menu.

PICTURE menu

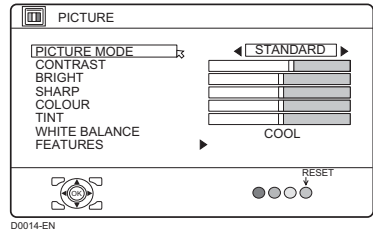

■ PICTURE MODE

You can choose one of three PICTURE MODEs to adjust the picture settings automatically.

BRIGHT:

Heightens contrast and sharpness.

STANDARD:

Standardizes picture adjustment.

SOFT:

Softens contrast and sharpness.

■ Adjusting the picture

You can change the picture settings of each picture mode, as you like. The picture settings changed are stored in the picture mode.

CONTRAST

You can adjust the picture contrast.

◀ : lower

▶ : higher

BRIGHT

You can adjust the picture brightness.

◀ : darker

▶ : brighter

SHARP

You can adjust the picture sharpness.

◀ : softer

▶ : sharper

COLOUR

You can adjust the picture colour.

◀ : lighter

▶ : deeper

TINT

You can adjust the picture tint.

◀ : reddish

▶ : greenish

- You can change the TINT setting (picture tint) only when the colour system is NTSC 3.58 or NTSC 4.43.

To return to the default settings in each PICTURE MODE:

Press the blue button. This will return the picture settings in the currently chosen PICTURE MODE to the default settings, and stores them in the PICTURE MODE again.

■ WHITE BALANCE

You can select one of three WHITE BALANCE modes (three tones of white) to adjust the white balance of the picture. Since white is the colour which is used as a reference for all the other colours, changing the WHITE BALANCE mode affects the appearance of all the other colours on the screen.

COOL:

A bluish white. Using this mode when watching bright pictures allows you to enjoy a more vivid and bright picture.

MID:

The normal white colour.

WARM:

A radish white. Using this mode when watching films allows you to enjoy colours that are characteristic of films.

FEATURES menu

Choose FEATURES in the "PICTURE" menu and press the **OK** or ▶ button to display the sub-menu.

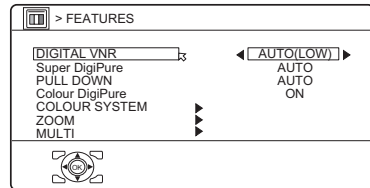
**■ DIGITAL VNR**

The DIGITAL VNR function cuts down the amount of noise in the original picture. You can choose from the four DIGITAL VNR function settings of AUTO(LOW), AUTO(HIGH), MIN and MAX.

AUTO(LOW)/AUTO(HIGH):

The TV will automatically adjust the level of the DIGITAL VNR effect to match the amount of noise in the picture, giving you the best possible picture.

- If you set the DIGITAL VNR effect too high it can make the picture less sharp. It is recommended to use the AUTO(LOW) setting if you can. If you set the DIGITAL VNR function to AUTO(LOW) but still notice some noise, change the setting from AUTO(LOW) to AUTO(HIGH).

MIN:

The level of the DIGITAL VNR effect is set to the minimum. If you set the DIGITAL VNR function to AUTO(LOW) but feel that the sharpness of the original picture has not been reproduced fully, change the setting from AUTO(LOW) to MIN.

- The MIN setting is not suitable for low-quality pictures which contain a lot of noise.

MAX:

The level of the DIGITAL VNR effect is set to the maximum. If you set the DIGITAL VNR function to AUTO(HIGH) but still notice some noise, change the setting from AUTO(HIGH) to MAX.

- The MAX setting is not suitable for high-quality pictures which contain very little noise.

■ **Super DigiPure**

The Super DigiPure function uses the latest in digital technology to give you a natural-looking picture. The Super DigiPure function includes the following two functions.

DigiPure function:

This function helps to create a natural-looking picture by eliminating unnecessary edges from high-contrast and crisp images. For images with low-contrast, edges are added to produce a sharper, more detailed picture.

You can choose from the three DigiPure function settings of AUTO, MIN and MAX.

- If you set the DigiPure effect too high on a low-quality picture that contains a lot of noise, this may actually make the noise worse. We recommend you use the AUTO setting if you can.

Picture motion compensation function:

This function displays fast-moving pictures (for example, the players or ball in a football game) more smoothly and naturally on the screen.

- The effect level of the picture motion compensation function cannot be changed. The effect level is the same no matter which of the AUTO, MIN or MAX settings is used.

AUTO:

The TV will automatically adjust the level of the DigiPure effect to match the amount of noise in the picture, giving the best possible picture.

MIN:

The level of DigiPure effect is set to the minimum. When you set the Super DigiPure function to AUTO and notice some noise, change the setting from AUTO to MIN.

- The MIN setting is not suitable for high-quality pictures which contain very little noise.

MAX:

The level of DigiPure effect is set to the maximum. If you set the Super DigiPure function to AUTO but feel that the original picture quality has not been reproduced fully, change the setting from AUTO to MAX.

- The MAX setting is not suitable for low-quality pictures which contain a lot of noise.

OFF:

The Super DigiPure function is turned off.

■ **PULL DOWN**

The PULL DOWN function displays a cinema film picture more smoothly and naturally on the screen.

AUTO:

This function is turned on. Normally keep this function set to AUTO.

ON :

This function is turned on.

OFF:

This function is turned off.

- The motion may appear unnatural when viewing images with the NTSC colour system. To make the motion smoother, switch the PULL DOWN function from AUTO or ON to OFF.

■ Colour DigiPure

Makes the colour outline stand out and increases the sharpness giving a clearer picture.

ON:

Colour DigiPure works. Normally use with this function turned on.

OFF:

Colour DigiPure doesn't work. This gives a less clear picture than when this function is turned on.

■ COLOUR SYSTEM

The colour system is chosen automatically. However, if the picture is not clear or no colour appears, choose the colour system manually.

1 Choose COLOUR SYSTEM. Then press the OK or ► button

The sub-menu of the COLOUR SYSTEM function appears.

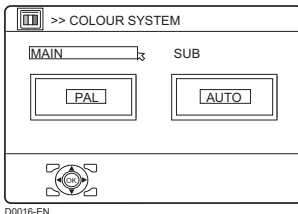

2 Press the ◀/▶ buttons to choose MAIN or SUB

MAIN:

You can change the colour system of the main-picture.

SUB:

You can change the colour system of the sub-picture.

- Choose MAIN when a sub-picture is not displayed.

3 Press the ▼/▲ buttons to choose the appropriate colour system. Then press the OK button

PAL:

PAL system

SECAM:

SECAM system

NTSC 3.58:

NTSC 3.58 MHz system

NTSC 4.43:

NTSC 4.43 MHz system

AUTO:

This function detects a colour system from the input signal.

- The AUTO function may not function properly if you have poor signal quality. If the picture is abnormal in the AUTO function, choose another colour system manually.

For colour system in your country or region, refer to the table below:

Area	Country or Region	System
Asia, Middle East	Bahrain, Kuwait, Oman, Qatar, United Arab Emirates, Yemen, etc.	PAL
	Indonesia, Malaysia, Singapore, Thailand, India, etc.	PAL
	China, Vietnam, etc.	PAL
	Hong Kong, etc.	PAL
	Islamic Republic of Iran, Lebanon, Saudi Arabia, etc.	SECAM
Europe	Philippines, Taiwan, Myanmar, etc.	NTSC
	Russia, etc.	SECAM
	Czech Republic, Poland, etc.	PAL
	Germany, Holland, Belgium, etc.	PAL
Oceania	UK, etc.	PAL
	Australia, New Zealand, etc.	PAL
Africa	Republic of South Africa, etc.	PAL
	Nigeria, etc.	PAL
	Egypt, Morocco, etc.	SECAM

■ ZOOM

You can change the screen size according to the picture aspect ratio. Choose the optimum one from three ZOOM modes.

- 1 Choose **ZOOM**, then press the **OK** or **▶** button.

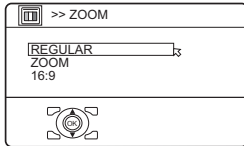

D0017-EN

- 2 Press the **▼/▲** buttons to choose a **ZOOM** mode. Then press the **OK** button.

- You can choose a ZOOM mode from REGULAR, ZOOM or 16:9 modes. For details, see “ZOOM button” on page 9.

■ MULTI

Choosing the number of pictures for the Multi-picture function.

- 1 Choose **MULTI**, then press the **OK** or **▶** button.

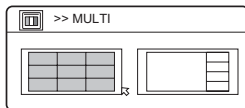

OSD-2-EN

- 2 Press the **◀/▶** buttons to choose the number of pictures. Then press the **OK** button.

SOUND menu

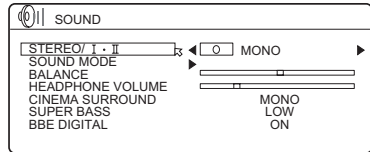

OSD-3-EN

- Functions in the “SOUND” menu other than “HEADPHONE VOLUME” work for the TV speakers. They do not work for the sound from the headphones.
- When the headphones are connected and only one screen is displayed, “STEREO/I•II” and “HEADPHONE VOLUME” can be used.

■ STEREO / I•II

When you are viewing a bilingual broadcast programme, you can choose the sound from Bilingual I (sub I) or Bilingual II (sub II). When the stereo broadcasting is received poorly, you can change from stereo to mono sound so that you can hear the broadcast more clearly and easily.

∞ : Stereo sound

○ : mono sound

I : Bilingual I (sub I)

II : Bilingual II (sub II)

MONO: Cancels the Multi Sound function, and the sound becomes monaural.

- The sound mode you can choose differs depending on the TV programme.
- This function does not work in the VIDEO modes.

■ SOUND MODE

Register your preferred pattern in the SOUND MODE USER.

1 Choose SOUND MODE, then press the OK or ► button.

The "SOUND MODE" menu appears.

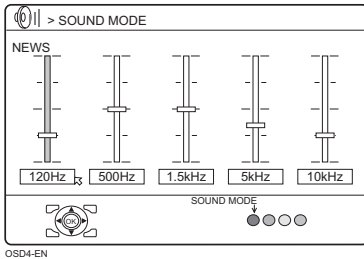

2 Press the red button and choose your preferred SOUND MODE.

3 Press the ◀/▶ buttons and choose the frequency to adjust, then press the ▼/▲ buttons and adjust the frequency.

- The adjusted frequency is registered to USER.
- When DYNAMIC, MUSIC, or NEWS is chosen and the frequency is adjusted, the SOUND MODE automatically changes to USER.
- Adjust the other frequencies according to your preference.
- After adjusting the frequencies in step 3, pressing the blue button will return to the SOUND MODE pattern chosen in step 2.
- You can choose a SOUND MODE function with the SOUND MODE button. For details, see "SOUND MODE button" on page 10.

■ BALANCE

You can adjust the volume balance between the left and right speakers.

- ◀ : turn the left speaker's volume level up.
- ▶ : turn the right speaker's volume level up.

■ HEADPHONE VOLUME

Adjust the volume of the sub-picture sound which is heard through the headphones when set to Twin mode, PIP mode or 5 pictures multi.

- ◀ : Reduce volume
- ▶ : Increase volume

- When not set to Twin mode or PIP mode, the headphone volume is adjusted with the ◀ -/+ (volume) buttons.

■ CINEMA SURROUND

You can enjoy Surround sound with a "live" effect by using the CINEMA SURROUND function.

- You can choose a CINEMA SURROUND mode from HIGH, LOW, MONO and OFF modes. For details, see "CINEMA SURROUND button" on page 9.
- You can also operate the CINEMA SURROUND function with the CINEMA SURROUND button. For details, see "CINEMA SURROUND button" on page 9.

■ SUPER BASS

You can choose the SUPER BASS mode which emphasizes the bass sound.

- You can choose HIGH, MID or LOW. Choosing LOW will reduce the bass sound and choosing HIGH will increase the bass sound.
- You can also operate the SUPER BASS function with the BASS button. For details, see "BASS button" on page 10.

■ BBE DIGITAL

You can use the BBE DIGITAL function to enjoy easy-to-listen sound that is faithful to the original sound recorded.

- You can choose ON or OFF.
- Licensed by BBE Sound, Inc. BBE is a registered trademark of BBE Sound, Inc.

FEATURES menu

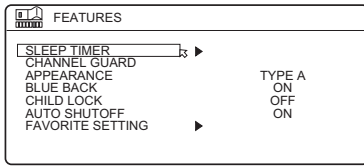

OSD-5-EN

■ SLEEP TIMER

You can set the TV to automatically turn off after a set time.

- 1 Choose **SLEEP TIMER**, then press the **OK** or **▶** button.

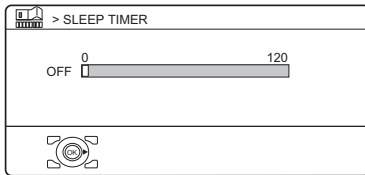

D0024-EN

- 2 Press the **◀/▶** buttons to set the period of time.

The TV begins count down from the set time.

- You can set the period of time a maximum of 120 minutes (2 hours) in 10 minute steps.

To cancel this function:

- Press the **◀** button to set a period of time to "OFF".

- 3 Press the **OK** button to complete the setting.

The menu disappears.

- One minute before this function turns off the TV, "GOOD NIGHT!" appears.
- This function cannot be used to turn off the TV's main power.
- When this function is on, you can display the SLEEP TIMER menu again to confirm or change the remaining time.

■ CHANNEL GUARD

When there is a TV channel you do not want your children to watch, you can lock out the channel. Even when a child chooses a programme number for a locked out channel the screen will change to blue and display **Ⓜ** so the channel cannot be viewed.

To set this function:

- 1 Choose **CHANNEL GUARD**, then press the number **0** button.

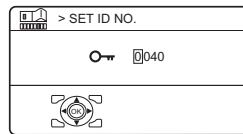

D0025-EN

- 2 Set the ID number you want.

To choose a number:

Press the **▼/▲** buttons.

To move a cursor:

Press the **◀/▶** buttons.

- 3 Press the **OK** button.

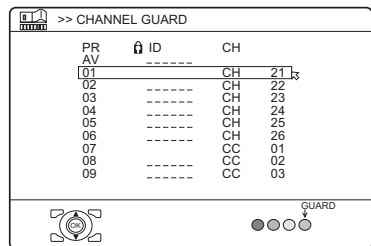

D0026-EN

- 4 Press the **▼/▲** buttons to choose a TV channel.

- The TV shows the TV programme which the chosen TV channel is now broadcasting.

- 5 Press the **blue** button to set this function to the TV channel.

Ⓜ (CHANNEL GUARD) appears and the TV channel is locked.

To cancel this function:

Press the blue button again.

Ⓜ (CHANNEL GUARD) disappears and the lock is released.

6 Press the OK button to complete the setting.

The menu disappears.

To view a locked TV channel:**1 Choose a programme number in which a TV channel locked with the number buttons or PR LIST.**

The screen changes to blue and the Ⓜ (CHANNEL GUARD) appears.



- You cannot choose a locked TV channel with the CHANNEL ∇/Δ buttons.

2 Press the DISPLAY button to display "ID NO." (ID number input screen).**3 Press the number buttons to enter the ID number.**

The lock is temporarily released so you can view the TV channel.

If you have forgotten the ID number:

Perform step 1 of "To set this function:" on page 26. After confirming the ID number, press the TV/VIDEO button to exit the menu.

- When you would like to cancel the CHANNEL GUARD function, you must perform the operation "To set this function" again.

■ APPEARANCE

Press the $\blacktriangleleft/\blacktriangleright$ button and choose the format in which the channel number is displayed from the three types: TYPE A, TYPE B and TYPE C.

■ BLUE BACK

You can set the TV to automatically change to a blue screen and mute the sound if the signal is weak or absent, or when there is no input from an external device.

ON:

This function is turned on.

OFF:

This function is turned off.

■ CHILD LOCK

You can disable the front control buttons of the TV. When this function is set to ON, the TV can be operated only by using the remote control.

Use this function to prevent children from operating the TV at their own discretion (without parent consent).

ON:

This function is turned on.

OFF:

This function is turned off.

Turning the power off with the main power button cancels the CHILD LOCK.

■ AUTO SHUTOFF

You can set the power to turn off if no signal is received and no operation is performed for about 15 minutes or longer after the end of a broadcast.

ON:

This function is turned on.

OFF:

This function is turned off.

- The AUTO SHUTOFF function does not turn off the TV's main power.
- The AUTO SHUTOFF will not work for a VIDEO mode.

■ FAVORITE SETTING

You can set a dedicated picture effect for the favorite channels registered to the colour buttons (Red, Green, Yellow and Blue). For favorite channel registration, see "Favorite channel registration" on page 11.

- 1 Choose **FAVORITE SETTING**, then press the **OK** or **▶** button.

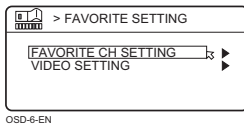

- 2 Choose **FAVORITE CH SETTING**, then press **OK** or **▶** button.

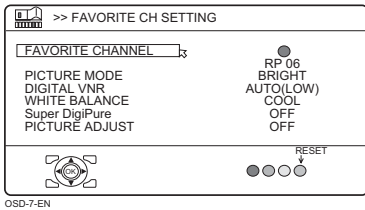

- 3 Press the **▼/▲** button to choose **FAVORITE CHANNEL**, then press the **◀/▶** button to choose the registered favorite channel.

Each time you press the **◀/▶** button, the colour button icon (Red, Green, Yellow or Blue) of the registered favorite channel and its channel number (e.g. PR1) appear.

- 4 Set the picture effect.

Press the **▼/▲** button to choose an item listed in the following table and press the **◀/▶** button to choose one of options.

- As explained in the table, if PICTURE EFFECT is set to OFF, the dedicated picture effect for the favorite channel is not used. In this case, normal picture effect is used.

- For details of each item, see "PICTURE MODE" on page 20, "DIGITAL VNR" on page 21, "WHITE BALANCE" on page 21, "Super DigiPure" on page 22.

Item	Options
PICTURE MODE	BRIGHT*, STANDARD, SOFT
DIGITAL VNR	AUTO (LOW)*, AUTO (HIGH), MIN, MAX
WHITE BALANCE	COOL, MID*, WARM
Super DigiPure	AUTO*, MAX, OFF, MIN
PICTURE EFFECT	ON*: Above picture effect applies to the chosen favorite channel. OFF: No picture effect applies.

*: When shipped

- Pressing the blue button returns each setting back to initial setting and cancels the favorite channel registration.

- 5 Press the **OK** button to complete the setting.

■ VIDEO SETTING

You can set a dedicated picture effect for the video inputs, VIDEO-1 to -4.

- 1 Choose **FAVORITE SETTING**, then press the **OK** or **▶** button.
- 2 Choose **VIDEO SETTING**, then press the **OK** or **▶** button.

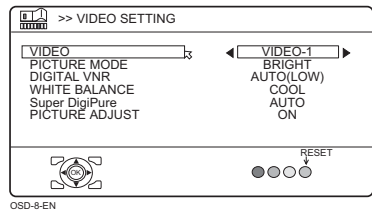

3 Press the ▼/▲ button to choose **VIDEO**, then press the ◀/▶ button to choose one of video inputs, **VIDEO-1** to **-4**.

4 Set the picture effect.

Press the ▼/▲ button to choose an item listed in the following table and press the ◀/▶ button to choose one of options.

- As explained in the table, if PICTURE EFFECT is set to OFF, the dedicated picture effect for the video inputs is not used. In this case, normal picture effect is used.

Item	Options
PICTURE MODE	BRIGHT*, STANDARD, SOFT
DIGITAL VNR	AUTO (LOW), AUTO (HIGH), MIN*, MAX
WHITE BALANCE	COOL, MID*, WARM
Super DigiPure	AUTO, MAX*, OFF, MIN
PICTURE EFFECT	ON*: Above picture effect applies to the chosen video input. OFF: No picture effect applies.

*: When shipped

- For details of each item, see "PICTURE MODE" on page 20, "DIGITAL VNR" on page 21, "WHITE BALANCE" on page 21, "Super DigiPure" on page 22.
- When the signal is 625p or 525p:
 - In "DIGITAL VNR", AUTO (LOW and HIGH) cannot be selected.
 - In "Super DigiPure", AUTO cannot be selected.
- Pressing the blue button will return the picture effect to the factory set value.

5 Press the OK button to complete the setting.

SETUP menu

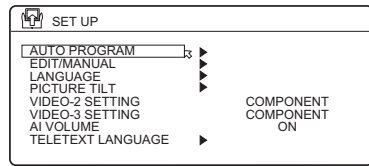

OSD-9-EN

■ AUTO PROGRAM

You can automatically register the TV channels which can be received well at your residence in the TV's programme numbers by performing the following.

1 Choose AUTO PROGRAM, then press the OK button.

The AUTO PROGRAM function starts. The TV channels you receive are automatically stored in the programme numbers list.

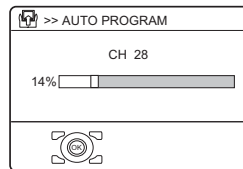

D0004-EN

- To stop the AUTO PROGRAM function, press the OK button.

2 After the TV channels have been stored in the programme number list, the EDIT menu appears.

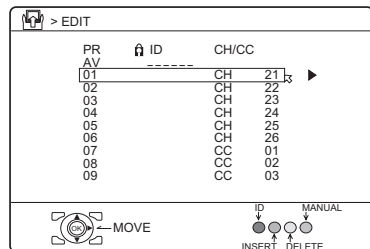

D0038-EN

- You can proceed to edit the programme numbers list using the EDIT/MANUAL function. For details, see “EDIT/MANUAL” on page 30
- If a TV channel you want to view is not stored in the programme numbers list, you can register it using the MANUAL function.
For details, see “EDIT/MANUAL” on page 30.
- The AUTO PROGRAM function does not store a TV channel to the programme number 0 (AV).
- If you do not need to use the EDIT/MANUAL function, press the OK button to exit the EDIT menu.
- Starting the AUTO PROGRAM deletes the registered favorite channel.

■ EDIT/MANUAL

The EDIT/MANUAL functions are divided into two types: editing of the current programme numbers (EDIT functions) and manual registration of a TV channel you want to view to the programme number (MANUAL function).

CAUTION

- Using the MOVE, DELETE or INSERT function rewrites the current programme numbers list.
Resultingly, the programme number of some of the TV channels will change.
- When a TV channel which has been locked out using the CHANNEL GUARD function, using the MANUAL function for that TV channel cancels the CHANNEL GUARD function.
- When a TV channel has already been registered in PR 99, using the INSERT function deletes the TV channel.

- 1 Choose **EDIT/MANUAL**, then press the **OK** or **▶** button.

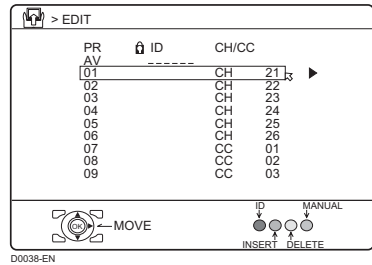

- 2 Follow the operation description of a function you want to use and operate the function.

MOVE:

This function changes a programme number of a TV channel.

ID:

This function registers a Channel name (ID) to a TV channel.

INSERT:

This function adds a new TV channel in the current programme numbers list by using the CH/CC number.

DELETE:

This function deletes an unnecessary TV Channel.

MANUAL:

This function manually registers a new TV channel in a programme number.

- 3 Press the **OK** button to complete the setting.

- For programme number PR 0, “AV” appears in the programme numbers list.

FUNCTIONS

MOVE

- 1 Press the **▼/▲** buttons to choose a TV channel.
- 2 Press the **▶** button to start the MOVE function.

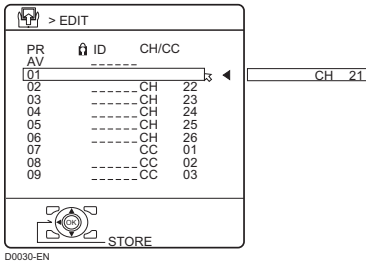

- 3 Press the **▼/▲** buttons to choose a new programme number.

To cancel the MOVE function:
Press the BACK button.

- 4 Press the **◀** button to change the programme number of a TV channel to a new programme number.

ID

- 1 Press the **▼/▲** buttons to choose a TV channel.
- 2 Press the red button to start the ID function.
- 3 Enter a channel name (ID). Press the **▼/▲** buttons to choose a character. Press the **◀/▶** buttons to move the cursor.

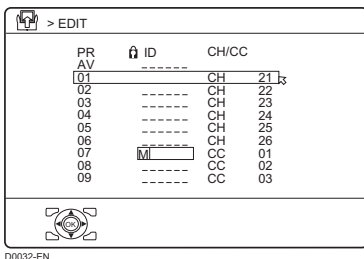

To cancel the ID function:

Press the BACK button.

- 4 Press the OK button to register a channel name to a TV channel.

DELETE

- 1 Press the **▼/▲** buttons to choose a TV channel.
- 2 Press the yellow button to delete the TV channel.

The TV channel is deleted from the programme numbers list.

MANUAL

- 1 Press the **▼/▲** buttons to choose a programme number to which you want to register a new TV channel.
- 2 Press the blue button to activate the MANUAL function.

At the right side following the CH/CC number, the SYSTEM (sound system) of the TV channel appears.

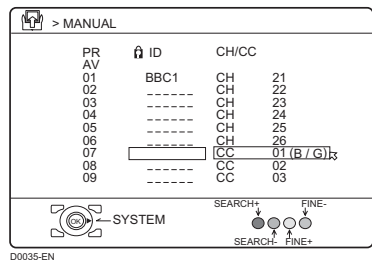

To cancel the MANUAL function:

Press the BACK button.

3 Press the ► button to choose the system (sound system) for a TV channel you want to register.

- For the sound systems in each country or region, refer to the table below:

Area	Country or Region	System
Asia, Middle East	Bahrain, Kuwait, Oman, Qatar, United Arab Emirates, Yemen, etc. Indonesia, Malaysia, Singapore, Thailand, India, etc.	B/G
	China, Vietnam, etc.	D/K
	Hong Kong, etc.	I
	Islamic Republic of Iran, Lebanon, Saudi Arabia, etc.	B/G
	Philippines, Taiwan, Myanmar, etc.	M
Europe	Russia, etc.	D/K
	Czech Republic, Poland, etc.	D/K
	Germany, Holland, Belgium, etc.	B/G
	UK, etc.	I
Oceania	Australia, New Zealand, etc.	B/G
Africa	Republic of South Africa, etc.	I
	Nigeria, etc.	B/G
	Egypt, Morocco, etc.	B/G

4 Press the green or red button to search for a TV channel.

Scanning stops when the TV finds a TV channel. Then the TV channel is displayed.

5 Press the green or red button repeatedly until the TV channel you want appears.

If the TV channel reception is poor:
Press the blue or yellow button to fine-tune the TV channel.

If you cannot hear the normal sound even when the picture of the TV channel appears normally:

The SYSTEM setting is wrong. Press the ► button and choose a SYSTEM that has normal sound.

6 Press the OK button and register the TV channel to a programme number.
The normal EDIT menu is resumed.

INSERT

Preparation:

- Find the CH/CC number corresponding to the channel number of the TV channel from page 35.

1 Press the ▼/▲ buttons to choose a programme number for which you will register a new TV channel.

2 Press the green button to start the INSERT function.

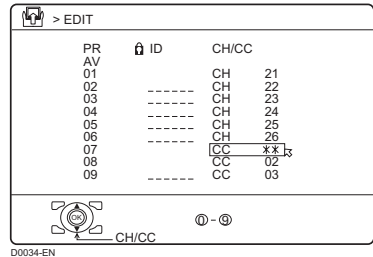

3 Press the ▼/▲ buttons to choose “CC” or “CH” according to the CH/CC number of the TV channel.

To cancel the INSERT function:
Press the BACK button.

4 Press the Number buttons to enter the remaining CH/CC number.

The TV shifts to registration mode. When the registration is completed, the picture of the TV channel appears on the screen.

- The CH/CC number is a number indicating the broadcast frequency to the TV. If the TV cannot detect the TV channel corresponding to the broadcast frequency indicated by the CH/CC number, a picture in the no-signal state appears.

■ LANGUAGE

You can choose the language you want to use for the on-screen display from the language list in a menu.

- 1 Choose **LANGUAGE**, then press the **OK** button.

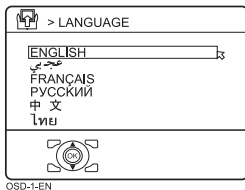

- 2 Press the **▼/▲** buttons to choose a language.
- 3 Press the **OK** button to complete the setting.
The menu disappears.

■ PICTURE TILT

There are cases where the Earth's magnetic force may make the picture tilt. If this happens, you can correct the picture tilt.

- 1 Choose **PICTURE TILT**, then press the **OK** or **▶** button.

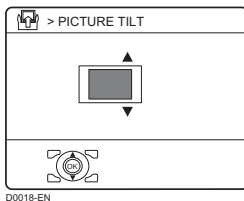

- 2 Press the **▼/▲** buttons until the picture becomes level. Then press the **OK** button.

■ VIDEO-2 SETTING/VIDEO-3 SETTING

Set the VIDEO-2 SETTING or VIDEO-3 SETTING correctly according to the video signal input from the external device connected to the VIDEO-2 or VIDEO-3 terminal. If this setting is incorrect, images will not be displayed.

VIDEO:

If a normal video signal (composite video signal) is input.

COMPONENT:

If a Component video signal (Y, Cb/Pb, Cr/Pr signals) is input.

- For detailed connecting methods, see "Additional preparation" on page 36. This Television is compatible with the 1125i, 625p or 525p video signal only when the component video signal is input.
- When the input signal is 1125i, 625p or 525p, each signal type is displayed at the upper right side on the TV screen by setting the input to VIDEO-2 or VIDEO-3.

■ AI VOLUME

You can prevent the sudden increase or decrease of sound that occurs when changing the channel to another channel or switching the VIDEO mode to another VIDEO mode.

ON:

This function is turned on.

OFF:

This function is turned off.

- The AI VOLUME function may not operate as expected if the sound input level from a broadcast station (or video software) is extremely low.
- When the Video or the DVD is used, it is recommended to select OFF to get more dynamic sound.

■ TELETEXT LANGUAGE

There are four types of teletext language groups. Set the teletext language group that corresponds to the language of the teletext program that you want to watch.

1 Choose TELETEXT LANGUAGE, then press the OK or ► button.

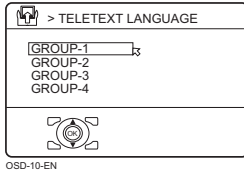

2 Press the ▼/▲ buttons to choose a group.

Group	Languages
GROUP-1	Turkish, Hungarian, English, German, French, Italian, Spanish, Portuguese, Greek, Swedish, Finnish
GROUP-2	Polish, Serbian, Croatian, Slovenian, Czech, Slovak, Rumanian, Hungarian, German, French, Italian, Swedish, Finnish
GROUP-3	Russian, Bulgarian, Lettish, Lithuanian, Estonian, Ukrainian, Serbian, Croatian, Slovenian, Czech, Slovak, English, German
GROUP-4	Arabic, Czech, Slovak, Hungarian, English, German, French, Italian, Spanish, Portuguese, Swedish, Finnish

3 Press the OK button to complete the setting.

The menu disappears.

- Languages that are not included in the teletext language group that you select, the sub-titles of the teletext program will not be displayed properly.

CH/CC number

When you want to use the INSERT function on page 32, find the CH/CC number corresponding to the Channel number of the TV channel from this table.

US: The US channel numbers are the channel numbers used in the United States, Philippines, etc. CCIR: The CCIR channel numbers are the channel numbers used in the Middle East, Southeast Asia, etc. OIRT: The OIRT channel numbers are the channel numbers used in Eastern Europe, Russia, Vietnam, etc. AUSTRALIA: The AUSTRALIA channel numbers are the channel numbers used in Australia, etc.

Channel					Channel				
CH	US	CCIR	OIRT	AUSTRALIA	CC	US	CCIR	OIRT	AUSTRALIA
CH 02	US-2	E2	R1	AU-0	CC 01		S-1		
CH 03	US-3	E3		AU-1	CC 02		S-2		AU-5
CH 04	US-4	E4	R2	AU-2	CC 03		S-3		
CH 05	US-5	E5	R6	AU-6	CC 04		S-4		
CH 06	US-6	E6	R7	AU-7	CC 05		S-5		
CH 07	US-7	E7	R8	AU-8	CC 06		S-6		AU-5A
CH 08	US-8	E8	R9	AU-9	CC 07		S-7		
CH 09	US-9	E9			CC 08		S-8		
CH 10	US-10	E10	R10	AU-10	CC 09		S-9		
CH 11	US-11	E11	R11	AU-11	CC 10		S-10		
CH 12	US-12	E12	R12		CC 11		S-11		
CH 13	US-13				CC 12		S-12		
CH 14	US-14, W+29				CC 13		S-13		
CH 15	US-15, W+30				CC 14	A	S-14		
CH 16	US-16, W+31				CC 15	B	S-15		
CH 17	US-17, W+32				CC 16	C	S-16		
CH 18	US-18, W+33				CC 17	D	S-17		
CH 19	US-19, W+34				CC 18	E	S-18		
CH 20	US-20, W+35				CC 19	F	S-19		
CH 21	US-21, W+36	E21			CC 20	G	S-20		
CH 22	US-22, W+37	E22			CC 21	H	S-21		
CH 23	US-23, W+38	E23			CC 22	I	S-22		
CH 24	US-24, W+39	E24			CC 23	J	S-23		
CH 25	US-25, W+40	E25			CC 24	K	S-24		
CH 26	US-26, W+41	E26			CC 25	L	S-25		
CH 27	US-27, W+42	E27			CC 26	M	S-26		
CH 28	US-28, W+43	E28			CC 27	N	S-27		
CH 29	US-29, W+44	E29			CC 28	O	S-28		
CH 30	US-30, W+45	E30			CC 29	P	S-29		
CH 31	US-31, W+46	E31			CC 30	Q	S-30		
CH 32	US-32, W+47	E32			CC 31	R	S-31		
CH 33	US-33, W+48	E33			CC 32	S	S-32		
CH 34	US-34, W+49	E34			CC 33	T	S-33		
CH 35	US-35, W+50	E35			CC 34	U	S-34		
CH 36	US-36, W+51	E36			CC 35	V	S-35		
CH 37	US-37, W+52	E37			CC 36	W	S-36		
CH 38	US-38, W+53	E38			CC 37	W+1	S-37		
CH 39	US-39, W+54	E39			CC 38	W+2	S-38		
CH 40	US-40, W+55	E40			CC 39	W+3	S-39		
CH 41	US-41, W+56	E41			CC 40	W+4	S-40		
CH 42	US-42, W+57	E42			CC 41	W+5	S-41		
CH 43	US-43, W+58	E43			CC 42	W+6			
CH 44	US-44, W+59	E44			CC 43	W+7			
CH 45	US-45, W+60	E45			CC 44	W+8			
CH 46	US-46, W+61	E46			CC 45	W+9			
CH 47	US-47, W+62	E47			CC 46	W+10			
CH 48	US-48, W+63	E48			CC 47	W+11			
CH 49	US-49, W+64	E49			CC 48	W+12			
CH 50	US-50, W+65	E50			CC 49	W+13			
CH 51	US-51, W+66	E51			CC 50	W+14			
CH 52	US-52, W+67	E52			CC 51	W+15			
CH 53	US-53, W+68	E53			CC 52	W+16			
CH 54	US-54, W+69	E54			CC 53	W+17			
CH 55	US-55, W+70	E55			CC 54	W+18			
CH 56	US-56, W+71	E56			CC 55	W+19			
CH 57	US-57, W+72	E57			CC 56	W+20			
CH 58	US-58, W+73	E58			CC 57	W+21			
CH 59	US-59, W+74	E59			CC 58	W+22			
CH 60	US-60, W+75	E60			CC 59	W+23			
CH 61	US-61, W+76	E61			CC 60	W+24			
CH 62	US-62, W+77	E62			CC 61	W+25			
CH 63	US-63, W+78	E63			CC 62	W+26			
CH 64	US-64, W+79	E64			CC 63	W+27			
CH 65	US-65, W+80	E65			CC 64	W+28			
CH 66	US-66, W+81	E66			CC 75		X		
CH 67	US-67, W+82	E67			CC 76		Y	R3	
CH 68	US-68, W+83	E68			CC 77		Z	R4	AU-3
CH 69	US-69, W+84	E69			CC 78		Z+1	R5	
					CC 79		Z+2		AU-4
					CC 95	A-5			
					CC 96	A-4			
					CC 97	A-3			
					CC 98	A-2			
					CC 99	A-1			

Additional preparation

■ Connecting the external devices

Connect the devices to the TV, paying attention to the following connection diagram.

Before connecting anything:

- Read the manuals provided with the devices. Depending on the devices, the connection method may differ from the figure. In addition, the device settings may be changed depending on the connection method to secure proper operation.
- Turn off all the devices including the TV.
- The “Specifications” on page 43 contains the details of the VIDEO terminals. If you are connecting a device not listed in the following connection diagram, see the “Specifications” to choose the best VIDEO terminal.
- Note that connecting cables are not supplied.

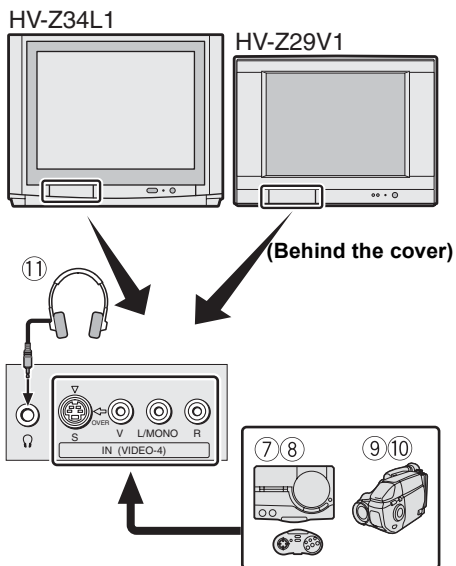

- ① VCR (composite signal)
- ② VCR (S-VIDEO signal; Y/C)
- ③ VCR for recording (composite signal)
- ④ DVD player (composite signal)
- ⑤ DVD player (S-VIDEO signal; Y/C)
- ⑥ DVD player (component video signals; Y, Cb/Pb, Cr/Pr)
- ⑦ TV game (composite signal)
- ⑧ TV game (S-VIDEO signal; Y/C)
- ⑨ Camcorder (composite signal)
- ⑩ Camcorder (S-VIDEO signal; Y/C)
- ⑪ Headphones

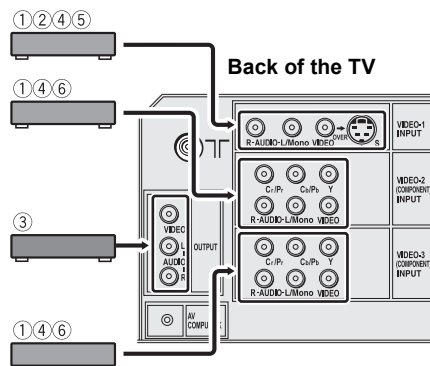

Connecting methods

- 1 **Connect the TV's VIDEO jack and the device's VIDEO OUT (video output) jack with a video cable.**

If connecting a device to the TV with an S-VIDEO cable:

Connect the VCR's S-VIDEO OUT (S-VIDEO output) connector and the TV's S connector with an S-VIDEO cable, instead of connecting with a video cable.

Note that the connection with a video cable will be ignored in case you connect a VCR to the TV with both video cable and S-VIDEO cable.

If connecting a DVD player to the TV with a component video cable.

Connect three jacks (Y, Cb/Pb, Cr/Pr) in the VIDEO-2 or VIDEO-3 terminal and the DVD player's COMPONENT (component video output) jacks with a component video cables, instead of connection with a video cable. Then set the VIDEO-2 SETTING/VIDEO-3 SETTING to COMPONENT, according to "VIDEO-2 SETTING/VIDEO-3 SETTING" on page 33.

- If you have a DVD player that outputs 1125i, 625p or 525p video signals as a component video signal, then by attaching the device to the television with a component video cable you can see the actual images that are recorded on a DVD disc as an original image source.

If connecting a device to the VIDEO-2 (COMPONENT) or VIDEO-3 (COMPONENT) terminal with a video cable.

Connect the TV's VIDEO jack and the device's VIDEO OUT (video output) jack with a video cable.

Then set the VIDEO-2 SETTING or VIDEO-3 SETTING to VIDEO according to "VIDEO-2 SETTING/VIDEO-3 SETTING" on page 33.

- In the VIDEO-4 terminal, the VIDEO jack is indicated by "V".

- 2 **Connect the TV's AUDIO jacks (L/MONO and R) and the device's AUDIO OUT (audio L/R output) jacks with an audio cable.**

If the device's sound output is in mono: Connect the device's AUDIO OUT jack and the TV's L/MONO jack with an audio cable.

Connecting devices to the OUTPUT terminal

The signals of the images and sound you are currently viewing with this TV are output through the OUTPUT terminal. By connecting a VCR to the OUTPUT terminal, you can record the currently shown image and sound to that VCR. To do this, connect the VCR and OUTPUT terminal following the steps below.

- 1 **Connect the VIDEO jack in the OUTPUT terminal and the VCR's VIDEO IN (video input) jack with a video cable.**
- 2 **Connect the AUDIO jacks (L and R) in the OUTPUT terminal and the VCR's AUDIO IN (audio L/R input) jacks with an audio cable.**
 - When you turn off the TV, the signals from the OUTPUT terminal are also turned off.
 - The component signals input from the VIDEO-2 (COMPONENT) or VIDEO-3 (COMPONENT) terminal cannot be output through the OUTPUT terminal.

Connecting Headphones

Connect the headphones with a stereo mini jack (of 3.5 mm in diameter) to the Headphone jack at the TV front panel.

■ Connecting AV COMPU LINK Supported Devices

AV COMPU LINK remote control system is a system in which related devices are automatically controlled when you operate one device.

If you apply this system to the TV, you can have the TV automatically perform the required operations by operating one external device. You don't have to use the TV's remote control to turn on the TV or change the VIDEO modes.

Examples of the AV COMPU LINK remote control system operations

Simply by pressing the PLAY button on a VCR or a DVD player, you can view images from the device.

Simply by inserting a prerecorded tape (a tape with the record safety tab removed) to a VCR, you can view the tape.

Simply by operating the AV Control Receiver, you can have the TV turned on/off (in standby mode) or the VIDEO mode changed correctly.

- The performance of the AV COMPU LINK remote control system varies depending on the connected device. See the device's instruction manual.
- When you select "TV SOUND" as the input source with the AV Control Receiver, there are cases where the TV's MUTING function automatically operates and the sound from the TV's speakers is muted.

In such cases, press the VOLUME-/+ buttons or the MUTING button on the TV's remote control to cancel the MUTING function. You can regain the sound from the TV's speakers.

Conditions to use the AV COMPU LINK remote control system

- A device equipped with an AV COMPU LINK terminal is required.
- You must connect the TV and the device with an AV COMPU LINK cable. AV COMPU LINK cable is not supplied with this TV. If an AV COMPU LINK cable is unavailable, connect them with a cable with dia. 3.5 mm (mono) male plugs at both ends.
- You must connect the device to an appropriate VIDEO terminal and set it up correctly. Otherwise the AV COMPU LINK remote control system will not function correctly. For details, see "Setting up the AV COMPU LINK remote control system".
- The TV must be in standby mode (the POWER lamp lighting red). If the TV's Main power is off (the POWER lamp off), the AV COMPU LINK remote control system does not function.

Setting up the AV COMPU LINK remote control system

CAUTION:

- With some devices, the setup method differs from the ones explained here. Be sure to read the device's instruction manual thoroughly before setting it up.

1 Connect the device to the TV's VIDEO-1, VIDEO-2 (COMPONENT) or VIDEO-3 (COMPONENT) terminal.

If you want to connect a DVD player to the TV with a component video cable:

Connect the DVD player to the TV's VIDEO-2 (COMPONENT) or VIDEO-3 (COMPONENT) terminal.

- For detailed connecting instructions, see "Connecting the external devices" on page 36.

2 Connect the TV's AV COMPU LINK terminal and the device's AV COMPU LINK terminal with an AV COMPU LINK cable.

3 Change the device's setting according to the VIDEO terminal it is connected to.

If a VCR is connected to the VIDEO-1 terminal:

Set the VCR's remote control code to A code.

If a DVD player is connected to the VIDEO-1 terminal:

Set the DVD player's AV COMPULINK MODE to DVD2.

If a VCR is connected to the VIDEO-2 (COMPONENT) terminal:

Set the VCR's remote control code to B code.

If a DVD player is connected to the VIDEO-2 (COMPONENT) terminal:

Set the DVD player's AV COMPULINK MODE to DVD3.

If a DVD player is connected to the VIDEO-3 (COMPONENT) terminal with a component video cable:

Set the DVD player's AV COMPULINK MODE to DVD1.

- For instructions on how to change the device's setting, refer to the device's instruction manual.
- If the device you are connecting has neither the remote control code nor the AV COMPULINK MODE, then connect it to the TV's VIDEO-1 terminal.

Troubleshooting

If a problem arises while you are using the TV, please read this “Troubleshooting” well before you request having the TV repaired. You may be able to fix it easily by yourself. For example, if the AC plug is disconnected from the AC outlet, or the TV aerial has problems, you may think there is a problem with the TV itself.

Important:

- This Troubleshooting guide only covers problems whose causes are not easy to determine. If a question arise when you are operating a function, read the page(s) corresponding to the operation of the function well, not this Troubleshooting guide.
- After you have followed the Troubleshooting description or the operating description of the functions concerned without any success, remove the AC plug from the AC outlet and request a repair of your TV. Do not attempt to repair the TV by yourself or remove the rear cover of the TV.

■ If you cannot turn on the TV

- Is the AC plug connected to the AC outlet?
- Is the POWER lamp lit? If not, press the Main power button.
- Make sure to set the PIP/TV/DVD switch to the TV or PIP position. You cannot turn the TV on when the PIP/TV/DVD switch is set to the DVD position.

■ If you cannot turn off the TV

- Make sure to set the PIP/TV/DVD switch to the TV or PIP position. You cannot turn the TV off when the PIP/TV/DVD switch is set to the DVD position.

■ No picture/No sound

- Have you chosen a TV channel whose reception is extremely bad? In this case, the BLUE BACK function will be activated, the entire screen becomes blue, and the sound is muted. In spite of this, if you want to view the TV channel, follow the description “BLUE BACK” on page 27 to try to change the BLUE BACK function setting to OFF.
- Are your SOUND SYSTEM settings for the TV channels correct? Follow the description “EDIT/MANUAL” on page 30 to use the MANUAL function to try to change the SYSTEM setting.

■ Poor picture

- If noise totally obscures the picture (snow), the aerial or aerial cable may have trouble. Check the following to try to solve the trouble:
 - Has the TV and aerial been connected properly?
 - Has the aerial cable been damaged?
 - Is the aerial pointed to the right direction?
 - Is the aerial itself faulty?
- If the TV or aerial receives interference from the other devices, stripes or noise may appear in the picture. Move such device as an amplifier, personal computer, or a hair drier that can cause interference away from your TV, or try changing its location. If the aerial suffers interference from a radio tower or high-voltage wire, please contact your local dealer.
- If the TV receives interferences from signal reflecting from mountains or building, double-pictures (ghosting) will occur.
 - Try to change the aerial’s direction or replace the antenna with the one with better directionality.
- Are your COLOUR SYSTEM settings for the TV channels correct? Follow the description “COLOUR SYSTEM” on page 23 to try to solve the trouble.

- Has COLOUR or BRIGHT been controlled properly? Follow the description “Adjusting the picture” on page 20 to try to adjust them properly.
- Videotaping teletext is not recommended because it may not record correctly.
- When a white and bright still image (such as a white dress) is displayed on the screen, the white part may look as if it were coloured.
It is a phenomenon unavoidable due to the nature of the picture tube itself, and not due to a TV failure.
When the picture disappears from the screen, the unnatural colours will also disappear.
- When viewing images from commercially available video software products, or videos from videotapes which have been recorded improperly, the top of the image may be distorted. This is due to the condition of the video signal, and not because of malfunction.

■ Poor sound

- When the TV channel reception is poor, it can be hard to hear the stereo or bilingual sound. In this case, follow the description “STEREO / I•II” on page 24 to hear the sound more easily by changing it to a mono sound.

■ Operation disabled

- Have the batteries of the remote control become exhausted?
Follow the description “Putting the batteries into the remote control” on page 4 and replace them with new batteries to try solve the problem.
- Have you attempted to use the remote control at the sides or rear of the TV or at a location more than seven meters apart from the TV location? Operate the remote control in the front of your TV or a location less than seven meters from your TV to try to solve the problem.
- When you are viewing a teletext programme, you cannot operate the menus.
Press the BACK or TV/VIDEO button to return the teletext programme to the ordinary TV programme to try operating the menus.
- Is the CHILD LOCK function set to ON? If the CHILD LOCK function is set to ON, you cannot operate the TV with the front control buttons of the TV. Follow the description “CHILD LOCK” on page 27 to try to set the CHILD LOCK function to OFF.
- If the TV operation becomes disabled suddenly, press the Main power button on the TV and turn off the main power. Try to press the Main power button again to turn on the main power. If the TV returns to a normal state, it is not a failure.
- The following functions do not operate when receiving 1125i, video signal.
 - Twin, PIP, Multi-display, FREEZE and STROBE functions

■ **Other concerns**

- When the AUTO SHUTOFF function operates, the TV is automatically turned off.
If the TV is turned off suddenly, try to press the \odot /I button to turn on the TV once again. At this time, if the TV resumes a normal state, there is no problem.
- If you bring a magnetized device such as a speaker near to your TV, a picture may be warped or unnatural colours appear at the corners of the screen. In this case, keep the device apart from your TV. If the speaker causes such phenomena, use the magnetic-shielded speaker instead.
- A picture may be tilted due to the influence of the earth's magnetism. In this case, use the "PICTURE TILT" on page 33 to complete the tilt.
- It takes a short period of time from the time an operation such as changing channels is performed until an image is displayed. This is not a malfunction. This is the time required for the image to stabilize before it can be displayed.
- The TV may emit a crackling sound due to a sudden change in temperature. It does not matter if a picture or sound does not show any abnormality. If you hear crackling sounds frequently while you are viewing the TV, other causes may be assumed.
For precautionary purposes, request your service technician to inspect it.

- Touching the screen may cause you feel a slight electric shock due to its static electricity.
It is an unavoidable phenomenon due to the construction of the picture tube. It is not a problem with the TV. You can rest assured that this static discharge does not have harmful influence over the human body.

Specifications

Broadcasting systems	B, G, I, D, K, K1, M
Colour systems	PAL, SECAM, NTSC3.58/4.43MHz
Channels and frequencies	VHF low channel (VL) =46.25 to 168.25 MHz VHF high channel (VH) =175.25 to 463.25 MHz UHF channel (U) =471.25 to 863.25 MHz • Receives cable channels in mid band (X to Z+2, S1 to S10), super band (S11 to S20) and hyper band (S21 to S41).
Sound-multiplex systems	A2 (B/G), NICAM (B/G, I, D/K) system
Teletext systems	FLOF(Fastext), WST(World Standard Text)
Languages displayed by teletext	Please see the table in the description "TELETEXT LANGUAGE" on page 34.
Power requirements	AC 110 to 240V, 50/60Hz
Audio output	Rated Power output: 15W + 15W [HV-Z34L1], 10W + 10W + 18W [HV-Z29V1]
VIDEO-1 terminal	RCA connector × 3, S-VIDEO connector × 1 • Video input, S-VIDEO (Y/C) input and Audio L/R inputs are available.
VIDEO-2 (COMPONENT)	RCA connector × 6 • Video input, Component video (Y, Cb/Pb, Cr/Pr) input and Audio L/R inputs are available. • 625p, 525p and 1125i signals are available.
VIDEO-3 (COMPONENT)	RCA connector × 6 • Video input, Component video (Y, Cb/Pb, Cr/Pr) input and Audio L/R inputs are available. • 625p, 525p and 1125i signals are available.
VIDEO-4 terminal	RCA connector × 3, S-VIDEO connector × 1 • Video input, S-VIDEO (Y/C) input and Audio L/R inputs are available.
OUTPUT terminal	RCA connector × 3 • Video output and Audio L/R outputs are available.
Headphone jack	Stereo mini-jack (3.5 mm in diameter)
Accessories	Remote control unit × 1 (RM-C1850) AA/R6 dry cell battery × 2 Woofer unit × 1 [HV-Z29V1 only]
Speakers	HV-Z34L1: 12cm round × 2, 3.5cm round × 2 HV-Z29V1: (13cm × 6.5cm) oval × 2, 13cm round × 1(Woofer unit)

Design and specifications subject to change without notice.

Pictures displayed on the screen using this TV's ZOOM functions should not be shown for any commercial or demonstration purpose in public places (cafes, hotels, etc.) without the consent of the owners of copyright of the original picture sources, as this constitutes an infringement of copyright.



Free Manuals Download Website

<http://myh66.com>

<http://usermanuals.us>

<http://www.somanuals.com>

<http://www.4manuals.cc>

<http://www.manual-lib.com>

<http://www.404manual.com>

<http://www.luxmanual.com>

<http://aubethermostatmanual.com>

Golf course search by state

<http://golfingnear.com>

Email search by domain

<http://emailbydomain.com>

Auto manuals search

<http://auto.somanuals.com>

TV manuals search

<http://tv.somanuals.com>