

JVC

ENGLISH

PD-42DX PD-35DX

PDP COLOUR TELEVISION

INSTRUCTIONS



D.I.S.T.
Digital Image Scaling Technology

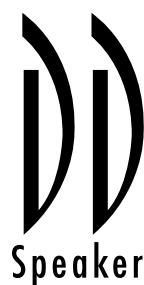

Speaker

LCT1373-001A

Thank you for buying this JVC colour television.

To make sure you understand how to use your new TV, please read this manual thoroughly before you begin.

WARNING: TO PREVENT FIRE OR SHOCK HAZARD, DO NOT EXPOSE THIS APPLIANCE TO RAIN OR MOISTURE.

WARNING

Always use the power cords which are supplied with the TV and receiver.

Some power cords are supplied with this TV. Use the power cord which best suits the area in which you live, and insert it into a correctly earthed outlet.

Failure to use the supplied power cord or to insert it into a correctly earthed outlet may result in electric shocks.

WARNING

To ensure safety in an emergency such as an earthquake, and to prevent accidents, ensure that measures are taken to prevent the TV dropping or falling over.

- Use the supplied screws to firmly attach the supplied hooks to the back of the TV, and use commercially available cord to fix the TV to rigid components such as walls and columns.

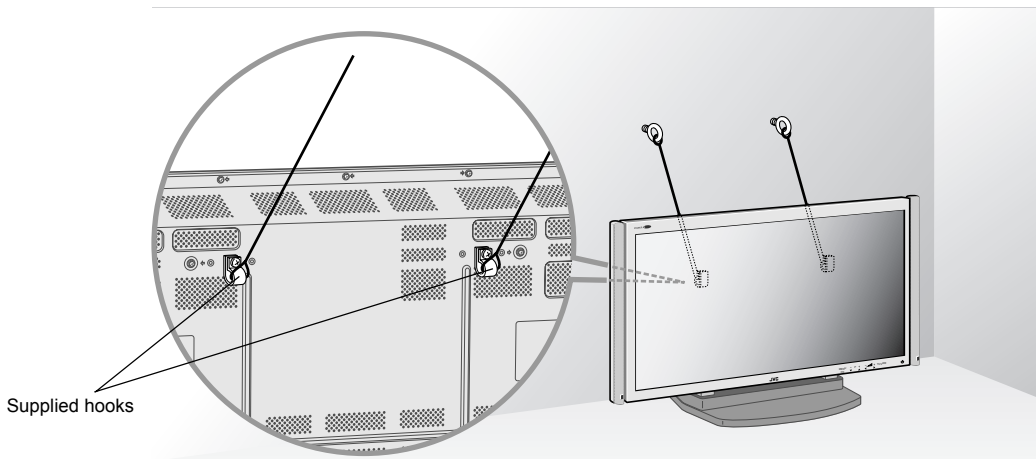

CAUTION:

- Operate only from the power source specified (AC 110–240 V, 50/60 Hz) on the unit.
- Avoid damaging the AC plug and power cord.
- When you are not using this unit for a long period of time, it is recommended that you disconnect the power cord from the main outlet.
- The ambient temperature for using this unit is 0° to 40°C (32° to 104°F). Using the unit outside of this range may lead to it not working correctly or being broken.

Burn-in

A characteristic of Plasma Display Panels (PDPs) is that displaying the same image for a long time causes a part of the image to stay on the screen (this is called phosphor burn-in).

Avoid burn-in as follows.

- Do not display static images or characters for long periods of time.

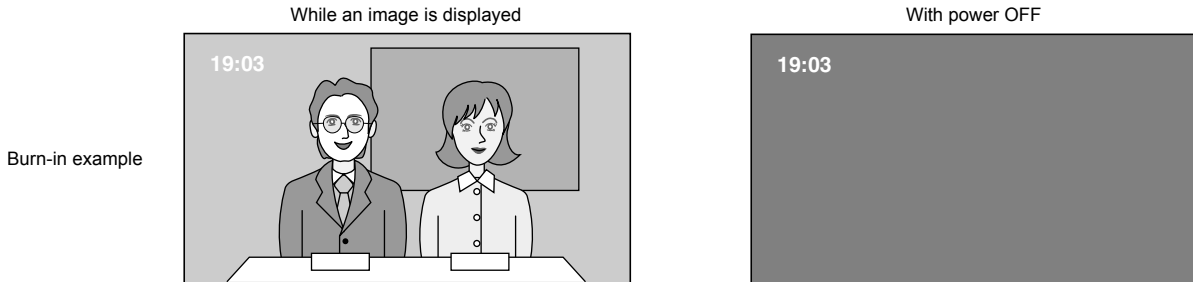

- Reduce CONTRAST and BRIGHT on the PICTURE SETTING menu (page 25) when viewing.

- Do not view for long periods of time in the REGULAR mode (page 18).

Screen size is normally chosen to ensure that the picture is displayed on the entire screen. After viewing in the REGULAR mode in which black bands may occur at the left and right of the screen, it is recommended to change to the PANORAMIC mode to display the picture on the entire screen.

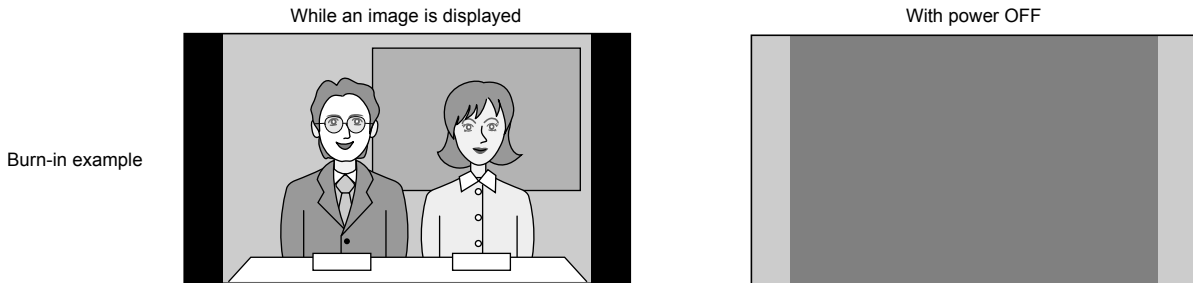

- Do not view for long periods of time using the PIP function (page 20) or MULTI-PICTURE function (page 21).

If Burn-in has occurred

If burn-in occurs, try the SNOW NOISE function (page 33). If burn-in is minimal it may gradually become less noticeable.

Note: Once burn-in occurs it will never disappear completely.

Point defects

PDPs use collections of fine pixels to display images. While there is no problem with more than 99.99% of these pixels, please understand that a very small number of pixels may not light or may light all the time.

Do not install the TV near electronic equipment that is susceptible to electromagnetic waves

It may cause interference in images, sound, etc. In particular, keep video equipment away from this product.

Effect on infrared devices

There may be interference while using infrared devices such as infrared cordless headphones.

Avoid improper installation and never position the unit where good ventilation is impossible. When installing this TV, distance recommendations must be maintained between the set and the wall, as well as inside a tightly enclosed area or piece of furniture.

Keep to the minimum distance guidelines shown for safe operation.

Failure to take the following precautions may cause damage to the television or remote control.**DO NOT block the TV's ventilation openings or holes.**

(If the ventilation openings or holes are blocked by a newspaper or cloth, etc., the heat may not be able to get out.)

DO NOT place anything on top of the TV.

(such as cosmetics or medicines, flower vases, potted plants, cups, etc.)

DO NOT allow objects or liquid into the cabinet openings.

(If water or liquid is allowed to enter this equipment, fire or electric shock may be caused.)

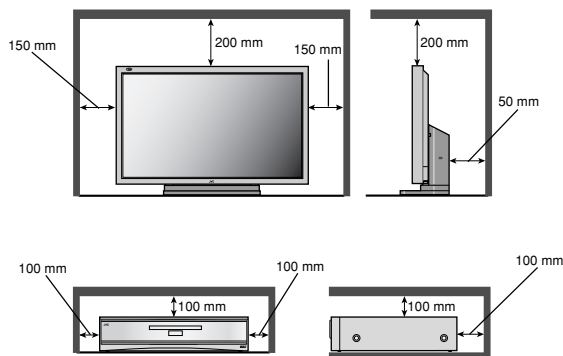
DO NOT place any naked flame sources, such as lighted candles, on the TV.

The surface of the TV screen is easily damaged. Be very careful with it when handling the TV.

Should the TV screen become soiled, wipe it with a soft dry cloth. Never rub it forcefully.

Never use any cleaner or detergent on it.

If there is a fault, unplug the unit and call a service technician. Do not attempt to repair it yourself or remove the rear cover.

D.I.S.T. demonstration

To start the D.I.S.T. demonstration:

Press the **OK** button to display the MENU (main menu). Then press the yellow button.

A picture split in two (D.I.S.T. turned on and D.I.S.T. turned off) will appear on the screen.

To quit the D.I.S.T. demonstration:

Press the yellow button, **TV** button, **P** ∇/\wedge buttons or any of the number buttons.

CONTENTS

Checking contents of packages.....	5	PICTURE FEATURES.....	26
Setting up your TV.....	6	DIGITAL VNR.....	26
Mounting the front speakers, and preparing the subwoofer	6	Super DigiPure	26
Installation.....	7	COLOUR SYSTEM	27
Putting the batteries into the Remote control.....	7	PULL DOWN.....	27
Connections.....	8	4:3 AUTO ASPECT.....	27
Connection diagram.....	8	COLOUR MANAGEMENT	27
Connecting the front speakers and subwoofer	10	PIP	28
Connecting the TV and receiver	11	SOUND SETTING	29
Connecting the aerial and VCR	12	STEREO / I • II	29
Connecting the power cord to the AC outlet	13	Sound Adjustment.....	29
Initial settings	14	SPEAKER	29
TV buttons and functions	15	BBE	29
Turn the TV on from standby mode	15	CINEMA SURROUND	29
Choose a TV channel	15	SUBWOOFER.....	29
Watch images from external devices	15	HEADPHONE	29
Adjust the volume	15	VIDEO SETTING	31
Using the headphone.....	15	ID LIST	31
Using the Menu.....	15	FEATURES.....	32
Remote control buttons and functions	16	SLEEP TIMER	32
Turn the TV on or off from standby mode.....	16	BLUE BACK	32
Choose a TV channel	16	CHANNEL GUARD.....	32
Adjust the volume	17	SNOW NOISE.....	33
Watch images from external devices	17	INSTALL.....	34
ZOOM function.....	18	LANGUAGE	34
CINEMA SURROUND function.....	19	AUTO PROGRAM.....	34
Displaying the current time	19	EDIT/MANUAL	34
Return to TV channel instantly.....	19	Changing the TELETEXT LANGUAGE setting... ..	37
Using the FREEZE function	19	Additional preparation.....	38
Using the PIP function	20	Connecting the external devices	38
Using the MULTI-PICTURE function	21	CH/CC numbers	40
Operating a JVC brand VCR or DVD player.....	21	Troubleshooting.....	41
Teletext function.....	22	Specifications.....	43
Basic operation	22		
Using the List Mode	22		
Hold.....	22		
Sub-page	23		
Reveal.....	23		
Size	23		
Index	23		
Cancel.....	23		
Using the TV's menu.....	24		
Basic operation	24		
PICTURE SETTING	25		
PICTURE MODE	25		
Picture Adjustment.....	25		
WHITE BALANCE.....	25		

Checking contents of packages

The TV and components are supplied in three packages.
Check that all components are present. Contact your retailer immediately if any components are missing.

■ TV

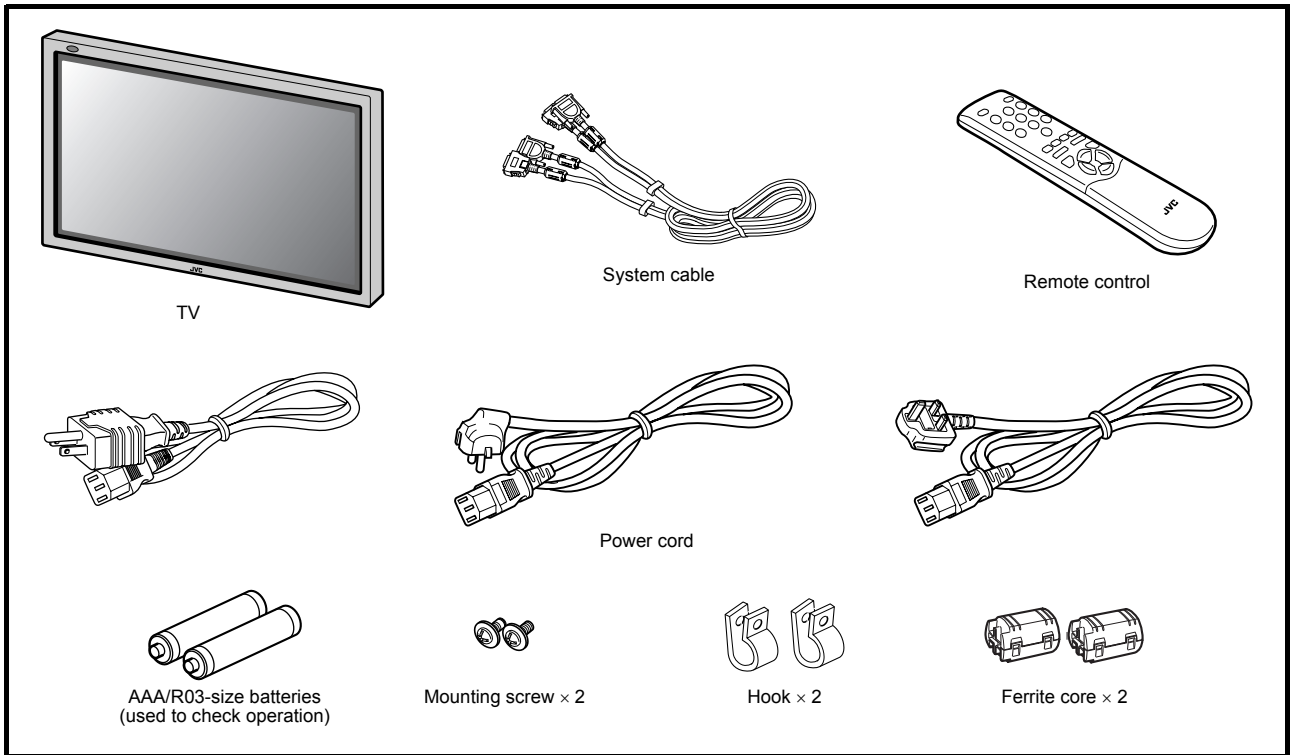

■ Receiver

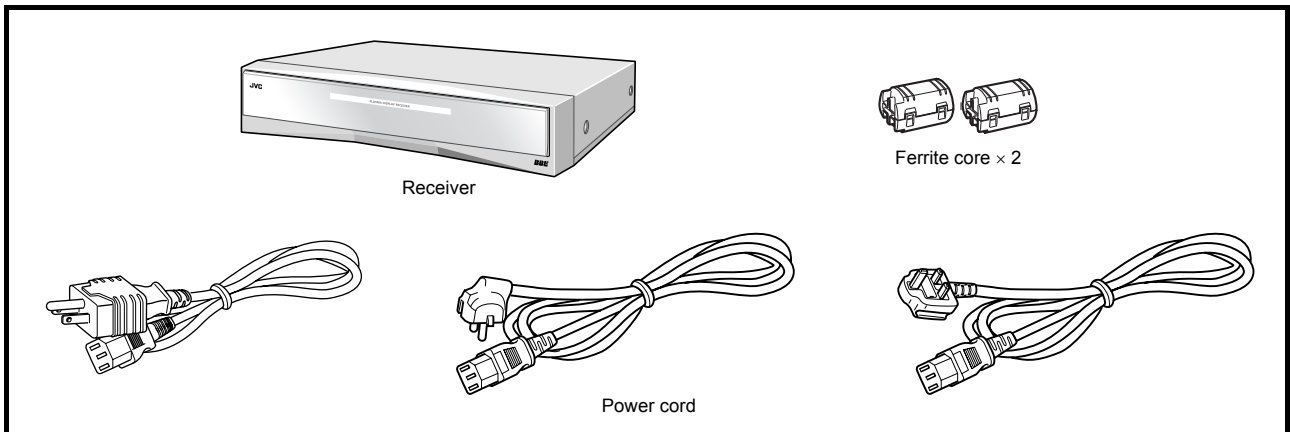

■ Speakers

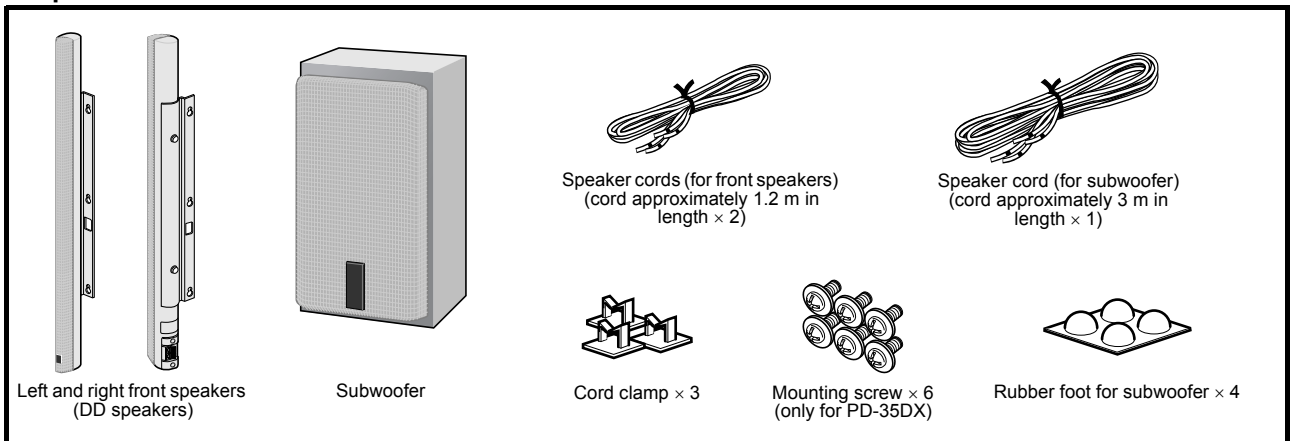

Setting up your TV

- Use the stand designed for this TV. For details of how to attach the stand, refer to the stand users manual.
- Ensure that the TV is installed on the wall by a skilled installer.

Mounting the front speakers, and preparing the subwoofer

■ Mounting the front speakers

Mount the supplied the DD speakers on the left and right of the TV.

- When using the stand designed for the TV, mount the TV on the stand beforehand.
- Place a soft cloth on the floor for protection before laying the TV down to attach the front speakers.

<PD-42DX>

1 Loosen the speaker mounting screws at the back of the TV

Using a Philips screwdriver, loosen the speaker mounting screws (three each side) until the heads project approximately 3 mm.

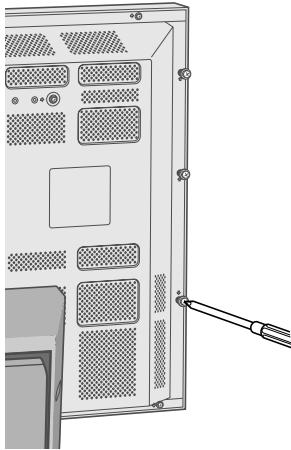

2 Attach the front speakers to the back of the TV

Place the heads of the screws in the screw holes in the front speaker mounting fixture, and slide the speaker downwards.

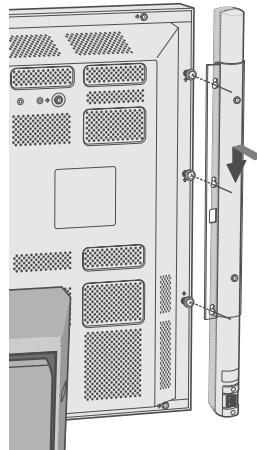

3 Lock the front speakers in place

Tighten the screws to lock the mounting fixture in place using a Philips screwdriver.

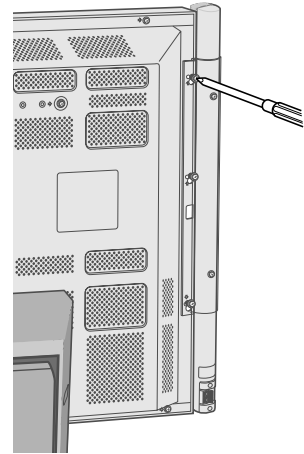

<PD-35DX>

1 Attach the speaker mounting screws to the back of the TV

Using a Philips screwdriver, tighten the speaker mounting screws (three each side) until approximately 3 mm is left protruding.

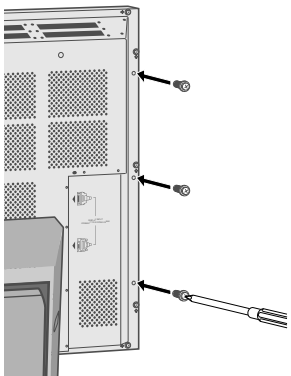

2 Attach the front speakers to the back of the TV

Place the heads of the screws in the screw holes in the front speaker mounting fixture, and slide the speaker downwards.

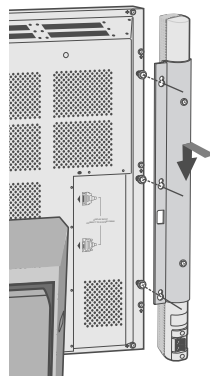

3 Lock the front speakers in place

Tighten the screws to lock the mounting fixture in place using a Philips screwdriver.

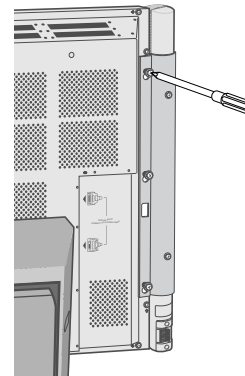

- Attach only the supplied DD speakers to the TV.

■ Preparing the subwoofer

Either stand the subwoofer vertically or lay it down on its side, peel the paper from the supplied rubber feet, and stick the feet in the four corners on the surface to be used as the base. The rubber feet prevent slipping and resonance, and also protect the speaker cord.

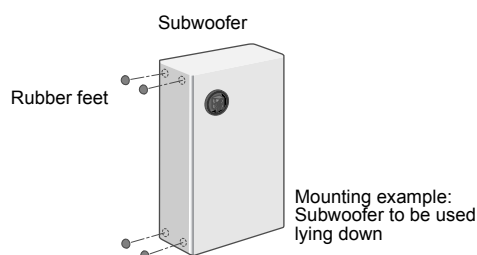

- The subwoofer is not designed to withstand electromagnetic fields. Furthermore, it vibrates in operation and should therefore not be installed near equipment such as VCR, or equipment where it will be subject to vibration or electromagnetic fields.

Installation

Cautions for installation

- Do not tilt the TV towards the left or right, or towards the back.
- Install the TV in a corner on a wall or on the floor so as to keep cords out of the way.
- Grip the TV (not the front speakers) when moving or installing it after mounting the front speakers to the TV.
- The TV will generate a slight amount of heat during operation. Ensure that sufficient space is available around the TV to allow satisfactory cooling.

Above the TV:	200 mm or more
Left and right of the TV:	150 mm or more
Behind the TV:	50 mm or more
Above, behind, left and right of the receiver:	100 mm or more

Installation example:

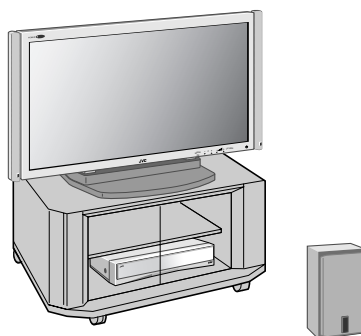

Putting the batteries into the Remote control

Use two AAA/R03 dry cell batteries.

Insert the batteries from the \ominus end, making sure the \oplus and \ominus polarities are correct.

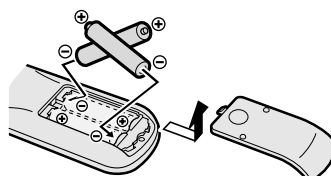

- Follow the warnings printed on the batteries.
- Battery life is about six months to one year, depending on your frequency of use.
- The batteries we supply are only for setting up and testing your TV, please replace them as soon as necessary.
- If the remote control does not work properly, replace the batteries.

Connections

Caution

- Turn off all equipment (including the TV) before connecting anything.

Connection diagram

<PD-42DX>

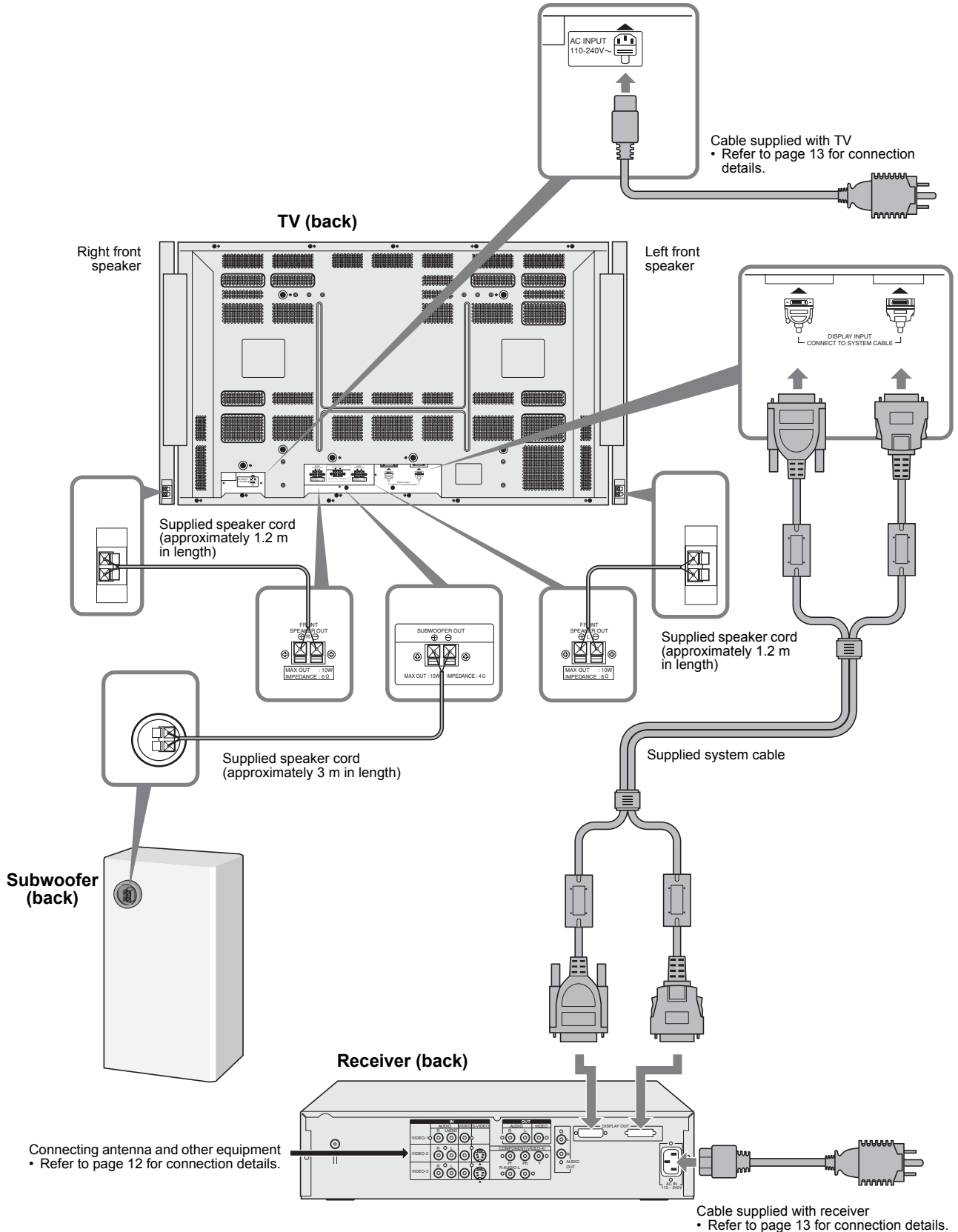

<PD-35DX>

ENGLISH

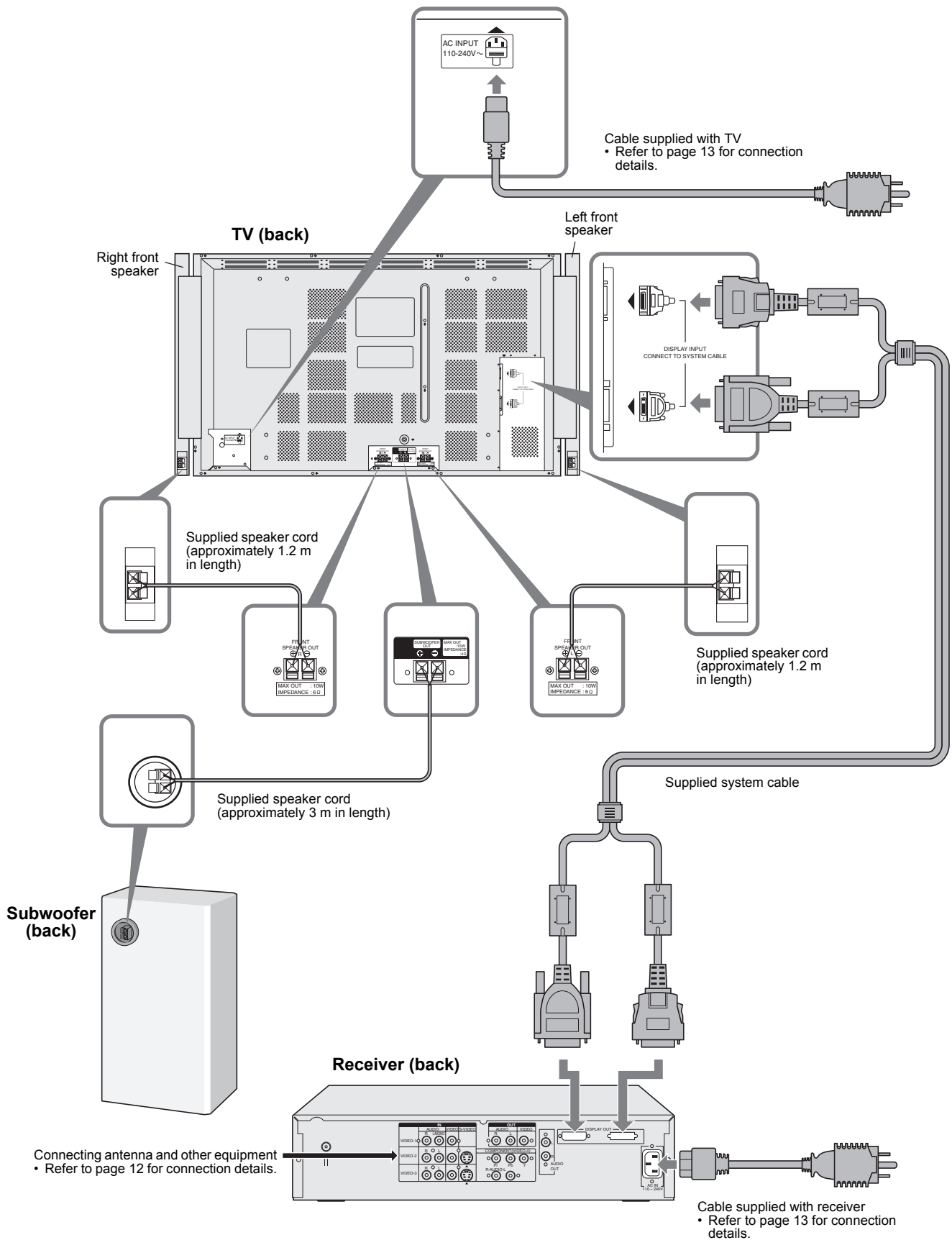

Connecting the front speakers and subwoofer

Use the supplied speaker cords to connect the speakers to the speaker terminals at the back of the TV.

■ Connecting the speaker cord to the front speaker terminal

Connect using the supplied front speaker cords (approximately 1.2 m in length).

1 Press the spring-loaded speaker input terminal lever in the direction of the arrow

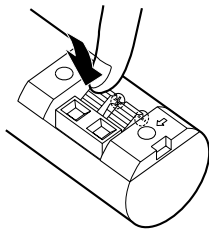

2 Press the core of the cord into the terminal and lock it in place by releasing the lever

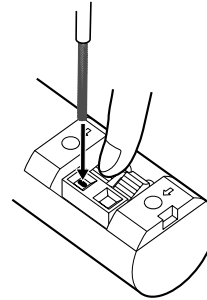

- Connect the cord with the black stripe to the \ominus terminal.
The stereo sensation and sound quality will be impaired if the polarity (\oplus , \ominus) of the speaker cords is reversed.

■ Connecting the speaker cord to the subwoofer terminal

Connect using the supplied subwoofer speaker cord (approximately 3 m in length).

1 Press the spring-loaded subwoofer speaker input terminal lever in the direction of the arrow

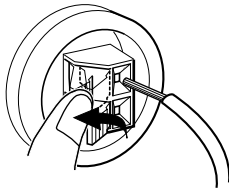

2 Press the core of the cord into the terminal and lock it in place by releasing the lever

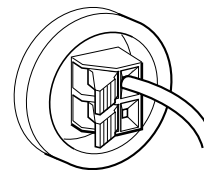

- Connect the cord with the black stripe to the \ominus terminal.
The stereo sensation and sound quality will be impaired if the polarity (\oplus , \ominus) of the speaker cords is reversed.

■ Connecting the speaker cord to the speaker terminal at the back of the TV

Connect the speaker cord from the right of the TV (when viewed from the front) to the speaker terminal R at the back of the TV.

Connect the speaker cord from the left of the TV (when viewed from the front) to the speaker terminal L at the back of the TV.

Connect the speaker cord from the subwoofer to the subwoofer terminal at the back of the TV.

1 Press the speaker terminal lever on the TV in the direction of the arrow

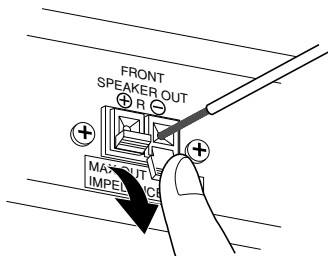

2 Press the core of the cord into the terminal

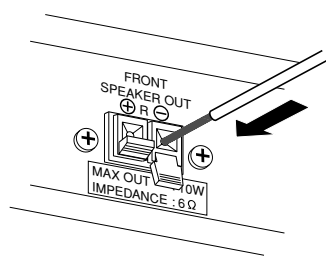

3 Push the terminal lever upwards

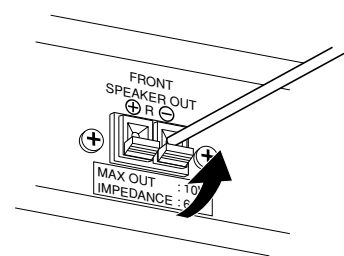

- Connect the cord with the black stripe to the \ominus terminal.
The stereo sensation and sound quality will be impaired if the polarity (\oplus , \ominus) of the speaker cords is reversed.

- The front speakers (DD speakers) and the subwoofer are for use only with this TV, and may be damaged if they are connected to another amplifier.

■ Bundling speaker cords

Use the supplied cord clamps to bundle the connected speaker cords together.

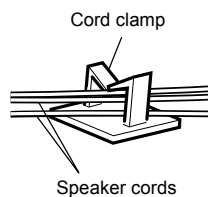

- Peel the paper from the back of the cord clamp and attach it to the desired location. To ensure that the cord clamp is firmly attached, wait a few minutes before inserting the speaker cords into the clamp.
- Ensure that the cord clamp is not attached above a ventilation hole at the back of the TV.

Connecting the TV and receiver

Use the supplied system cable to connect the TV to the receiver.

The two connectors are of different shapes.

Ensure that the pins on connector ① are oriented correctly, press the connector into the socket, and tighten the screws at left and right to lock it in place.

Press connector ② firmly into place until it is locked.

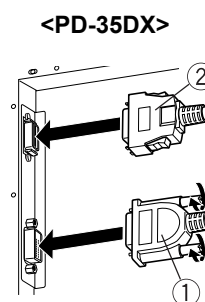
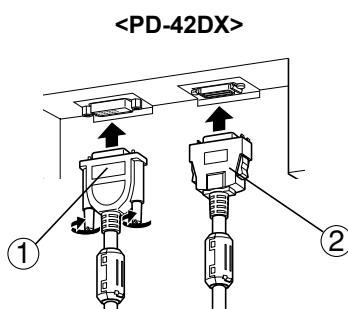

Disconnecting the system cable

Release connector ① by unscrewing the screws at left and right and removing it from the socket.

Release connector ② by removing it from the socket while pressing the release bottoms on either side.

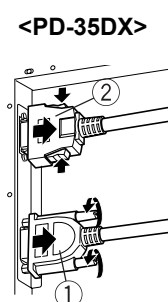
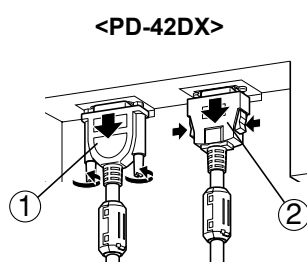

Connecting the aerial and VCR

- Aerial cable is not supplied. Use a good quality 75-ohm coaxial cable.
- Read the manual that came with the VCR before connecting.

If not connecting a VCR (see fig.A):

Connect an aerial cable to the aerial socket on this receiver.

If connecting a VCR (see fig.B):

- 1 Connect the aerial cable to the aerial input socket on the VCR, and connect the VCR and receiver with another aerial cable**
- 2 Connect the VCR's VIDEO OUT (video output) terminal and the receiver's VIDEO terminal with a video cable**
To connect a VCR to the receiver with an S-VIDEO cable:
Connect the VCR's S-VIDEO OUT (S-VIDEO output) terminal and receiver's "S" terminal with an S-VIDEO cable (A), instead of connecting with a video cable. Note that the connection with a video cable will be ignored in case you connect a VCR to the receiver with both video cable and S-VIDEO cable.
- 3 Connect the VCR's VIDEO OUT (audio L/R output) terminals and the receiver's AUDIO terminals (L/MONO and R) with an audio cable**

- If the VCR's audio output is in mono, connect the VCR's AUDIO OUT (audio output) terminal and the receiver's AUDIO L/MONO terminal with an audio cable.
- To connect additional external devices, please see "Connecting the external devices" on page 38.

Fig.A

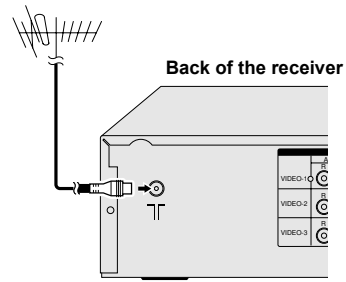
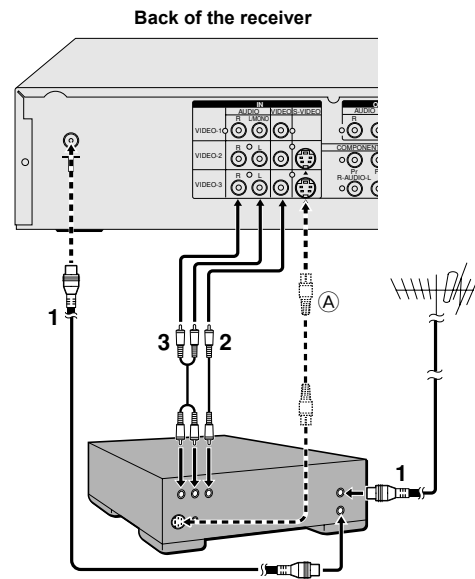

Fig.B



Connecting the power cord to the AC outlet

Insert the AC plugs on the power cords from the TV and receiver into AC outlets.

Caution

- Operate only from the power source specified (AC 110 – 240 V, 50/60 Hz) on the unit.
- Failure to use the supplied power cord or to insert it into a correctly earthed outlet may result in electric shocks.

Use the supplied power cord which best suits the area in which you live.

Attaching the ferrite cores

Attach ferrite cores to the power cord.

Using the power cord without ferrite cores may lead to noise (interference).

Open the ferrite core, insert the power cord and close the ferrite core.

Attach a ferrite core to each end of the power cord.

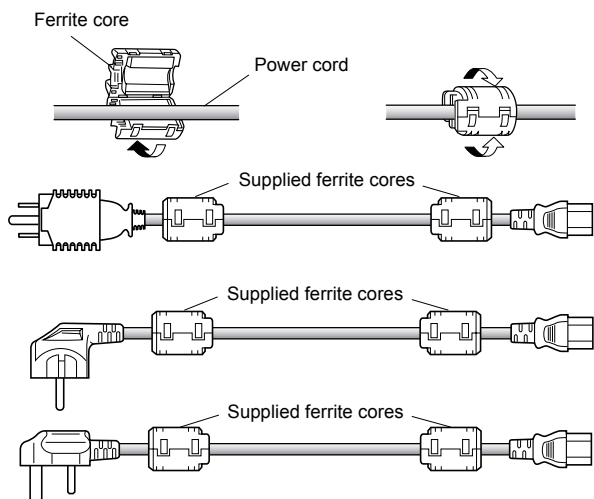

Back of the TV

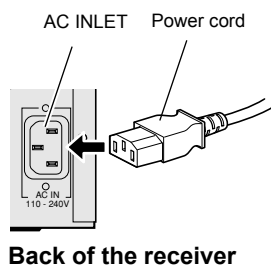
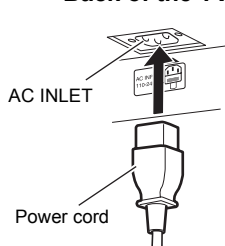

Receiver rear

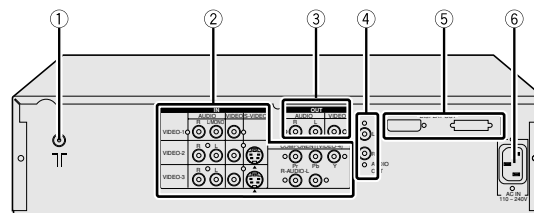

- ① Aerial socket (page 12)
- ② VIDEO terminals (pages 12, 31, 38)
VIDEO-1 terminal, VIDEO-2 terminal, VIDEO-3 terminal, COMPONENT (VIDEO-4) terminal
- ③ OUT terminal (page 39)
- ④ AUDIO OUT terminal (page 39)
- ⑤ DISPLAY OUT terminal (page 11)
- ⑥ AC INLET (page 13)

Insert the AC plug into a correctly earthed outlet.

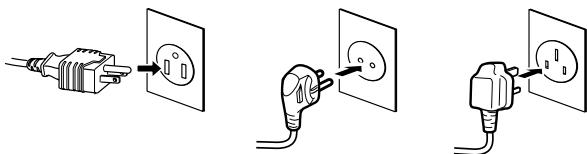

The receiver power lamp lights red, and the receiver is in the standby mode, when the AC plug on the power cord is connected to an AC outlet.

- Remove the AC plug from the outlet to completely disconnect the TV from the power supply.

Initial settings

When the TV is first turned on, it enters the initial setting mode, and the JVC logo is displayed. Follow the instructions on the on-screen display to make the initial settings.

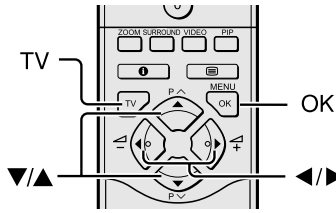

1 Press the TV button on the remote control

The receiver power lamp changes from red to green. After a short interval the TV power lamp lights green and the JVC logo is displayed.

- Check that the AC plugs on the power cords from the TV and receiver are connected to AC outlets.

Display front

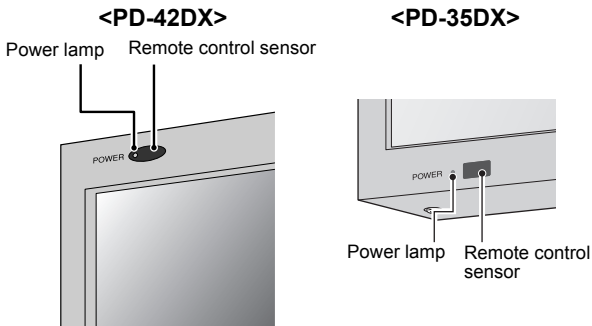

Receiver front

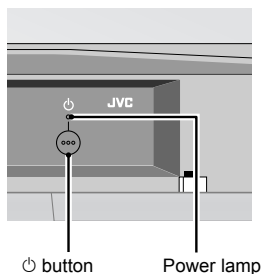

- If the power lamp stays red and does not change to green:
Your TV is in the standby mode. Press the TV (Standby) button again to turn your TV on.
- The JVC logo does not appear when your TV has been turned on once. In this case, use the "LANGUAGE" and "AUTO PROGRAM" functions to make the initial settings. For details, see "INSTALL" on page 34.

2 Press the OK button

The LANGUAGE menu appears.



3 Press the left and right arrow buttons to choose ENGLISH. Then press the OK button

English is set for the on-screen display description. The TELETEXT LANGUAGE menu appears as a sub-menu of the AUTO PROGRAM function.

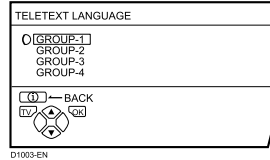

4 Press the up and down arrow buttons to choose the teletext language group that corresponds to language of teletext programme that you want to watch

Group	Languages
GROUP-1	Turkish, Hungarian, English, German, French, Italian, Spanish, Portuguese, Greek, Swedish, Finnish
GROUP-2	Polish, Serbian, Croatian, Slovenian, Czech, Slovak, Rumanian, Hungarian, German, French, Italian, Swedish, Finnish
GROUP-3	Russian, Bulgarian, Lettish, Lithuanian, Estonian, Ukrainian, Serbian, Croatian, Slovenian, Czech, Slovak, English, German
GROUP-4	Arabic, Czech, Slovak, Hungarian, English, German, French, Italian, Spanish, Portuguese, Swedish, Finnish

5 Press the OK button to start the AUTO PROGRAM function

The AUTO PROGRAM menu appears and received TV channels are automatically registered in the Programme numbers (PR).

- To cancel the AUTO PROGRAM function:
Press the TV button.

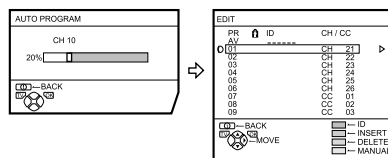

After the TV channels have been registered in the Programme numbers (PR), the EDIT menu appears

- You can proceed to edit the Programme numbers (PR) using the EDIT/MANUAL function. For details, see "EDIT/MANUAL" on page 34.
- If you do not need to use the EDIT/MANUAL function, go to the next step.

6 Press the OK button

TV buttons and functions

Display front

<PD-42DX>

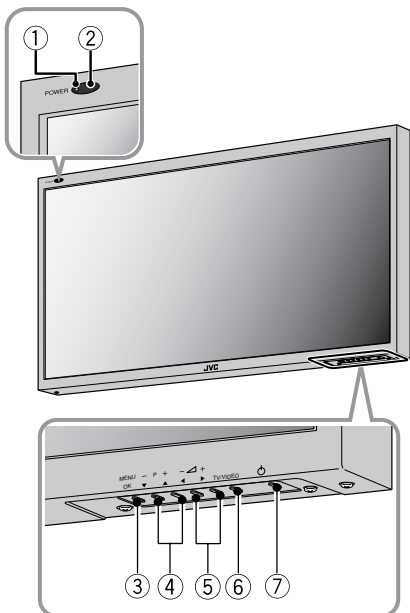

<PD-35DX>

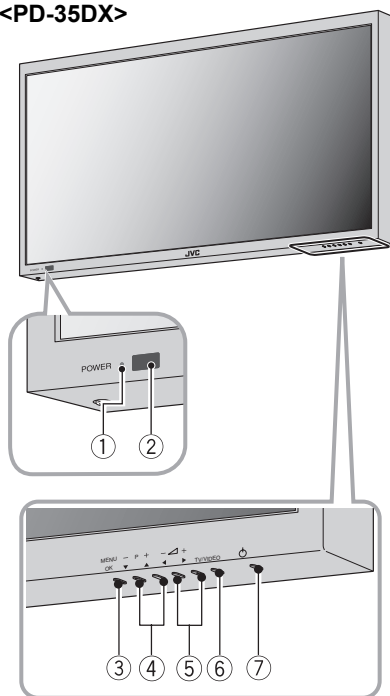

Refer to the pages in parentheses for details.

- ① Power lamp (page 14)
- ② Remote control sensor
- ③ MENU/OK button (pages 15, 24)
- ④ P V/∧ buttons (page 15)
- ⑤ ▽ (Volume) -/+ buttons (page 15)
- ⑥ TV/VIDEO button (page 15)
- ⑦ ⏻ (Stand by) button (page 15)

Receiver front

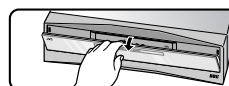

How to open the cover

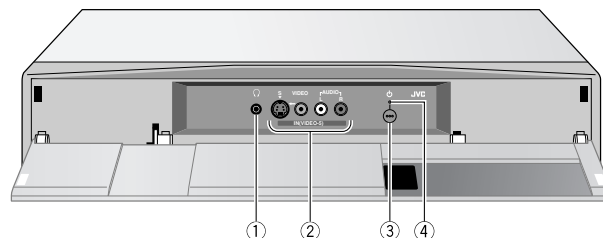

Refer to the pages in parentheses for details.

- ① Headphone jack (mini jack) (page 38)
- ② VIDEO-5 terminal (pages 31, 38)
- ③ ⏻ (Stand by) button (page 15)
- ④ Power lamp (page 14)

Turn the TV on from standby mode

Press the ⏻ button or P V/∧ buttons to turn the TV on from standby mode

- Check that the AC plugs on the power cords from the TV and receiver are connected to correctly AC outlets.

Choose a TV channel

Press the P V/∧ buttons to choose a programme number (PR) or an VIDEO terminal

Watch images from external devices

Press the VIDEO button to choose a VIDEO terminal

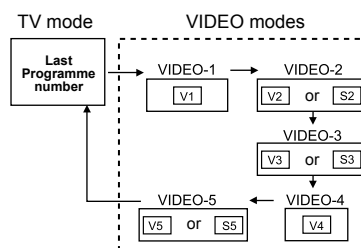

- The leading character is changed from V to S (e.g. V2 is changed to S2) when VIDEO-2, VIDEO-3, or VIDEO-5 are connected to the S terminal.

Adjust the volume

Press the -/+ buttons

The volume level indicator appears.

Using the headphone

- The headphone volume is adjusted with the "HEADPHONE" menu (see page 29).

Using the Menu

Use the MENU/OK button.

Refer to "Using the TV's menu" (see page 24) for details of using the menu.

Remote control buttons and functions

ENGLISH

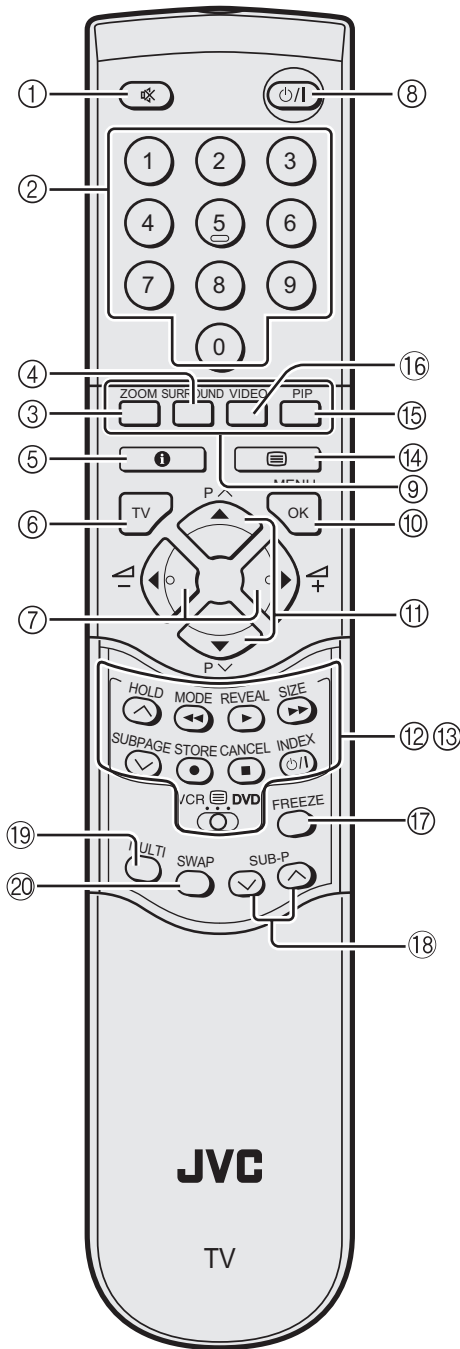

- ① Muting button
- ② Number buttons
- ③ **ZOOM** button
- ④ **SURROUND** button
- ⑤ Information button
- ⑥ **TV** button
- ⑦ ◀▶ buttons
- ⑧ ⏻ (Stand by) button
- ⑨ Colour buttons
- ⑩ **OK** button
- ⑪ ▼▲ buttons
- ⑫ VCR/DVD/Teletext control button
- ⑬ VCR DVD switch
- ⑭ (Text) button
- ⑮ **PIP** button
- ⑯ **VIDEO** button
- ⑰ **FREEZE** button
- ⑱ **SUB-P** ▼/▲ button
- ⑲ **MULTI** button
- ⑳ **SWAP** button

Turn the TV on or off from standby mode

Press the ⏻ (Standby) button to turn the TV on or off.

When the TV is turned on, the power lamp changes from red to green.

- The power can be turned on by pressing the **TV** button, ▼▲ buttons or Number buttons.
- Check that the AC plugs on the power cords from the TV and receiver are connected to AC outlets.

Choose a TV channel

- **Use the number buttons:**
Enter the programme number (PR) of the channel using the number buttons.

Example:

- PR 6 → press **6**
- PR 12 → press **1** and **2**

- **Use the ▼/▲ buttons:**
Press the ▼/▲ buttons to choose the programme number (PR) you want.

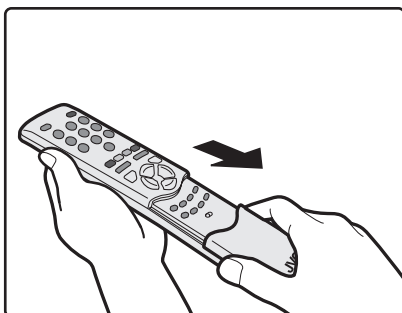

■ Use the PR LIST:

1 Press the **i** (Information) button to display the PR LIST

Pressing the **i** (Information) button changes the display as follows:

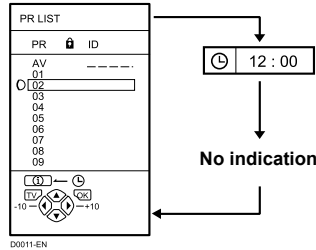

2 Press the **◀/▶** and **▼/▲** buttons to choose a Programme number (PR). Then press the **OK** button

- For Programme numbers (PR) with the CHANNEL GUARD function set, the **Ⓢ** (CHANNEL GUARD) mark is displayed next to the Programme number (PR) in the PR LIST.
 - You cannot use the **▼/▲** buttons to choose a Programme number (PR) with the CHANNEL GUARD function set.
 - Even if you try to choose a Programme number (PR) with the CHANNEL GUARD function set, the **Ⓢ** (CHANNEL GUARD) mark will appear, and you cannot watch the TV channel. To watch the TV channel, see “CHANNEL GUARD” on page 32.
-
- If you do not have a clear picture or no colour appears, follow the operation procedure “COLOUR SYSTEM” (see page 27).
 - The sound system is chosen automatically. However, if you cannot hear the sound normally even when the picture appears normally, choose the sound system manually. Refer to the MANUAL on the “INSTALL” menu (see page 34) for details of choosing the sound system.

Adjust the volume

Press the **◀/▶** buttons to adjust the volume.

The Volume indicator appears and the volume changes as you press the **◀/▶** buttons.

- The headphone volume is adjusted with the “HEADPHONE” menu (see page 29).

■ Muting the sound

Press the **Ⓜ** (muting) button to turn off the sound.

Pressing the **Ⓜ** (muting) button again restores the previous volume level.

Watch images from external devices

■ Use the **0 (AV)** button:

Press the **0 (AV)** button to choose a VIDEO terminal.

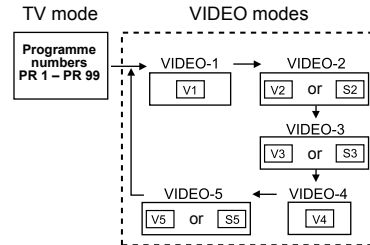

- The leading character is changed from V to S (eg V2 is changed to S2) when VIDEO-2, VIDEO-3, or VIDEO-5 are connected to the S terminal.

■ Use the **VIDEO** button:

Press the **VIDEO** button to choose a VIDEO terminal.

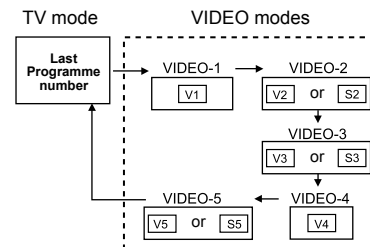

■ Use the **▼/▲** buttons:

Press the **▼/▲** buttons to choose a VIDEO terminal.

■ Use the PR LIST:

1 Press the **i** (Information) button to display the PR LIST

2 Press the **◀/▶** and **▼/▲** buttons to choose a VIDEO terminal. Then press the **OK** button

- The VIDEO terminals are registered after the Programme number PR 99.
- If you do not have a clear picture or no colour appears, change the colour system manually. See “COLOUR SYSTEM” on page 27.

To return to a TV channel:

Press the **TV** button, the **▼/▲** buttons or the Number buttons.

To use the Programme number PR 0 (AV):

When the TV and VCR are connected only by the Aerial cable, choosing the Programme number PR 0 (AV) allows you to view images from the VCR. Set the VCR RF channel to the Programme number PR 0 (AV) manually. For details, see "EDIT/MANUAL" on page 34.

Pressing the **0 (AV)** button changes the choice as follows:

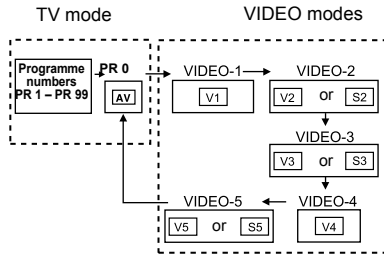

- The VCR RF channel is sent as the RF signal from the VCR.
- Also refer to your VCR instruction manual.

ZOOM function

You can change the screen size according to the picture aspect ratio. Choose the optimum one from the following ZOOM modes.

AUTO:

When a WSS (Wide Screen Signalling) signal, which shows the aspect ratio of the picture, is included in the broadcast signal or the signal from an external device, the TV automatically changes the ZOOM mode to 16:9 ZOOM mode or FULL mode according to the WSS signal. If a WSS signal is not included, the picture is displayed in accordance with the ZOOM mode set with the 4:3 AUTO ASPECT function.

- For details of the 4:3 AUTO ASPECT function, see "4:3 AUTO ASPECT" on page 27.
- When the AUTO(WSS) mode does not function correctly due to poor WSS signal quality or when you want to change the ZOOM mode, press the **ZOOM** button and change to another ZOOM mode.

REGULAR:

Use to view a normal picture (4:3 aspect ratio) as its original size is.

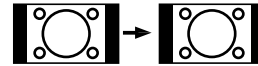

PANORAMIC:

This mode stretches the left and right sides of a normal picture (4:3 Aspect Ratio) to fill the screen, without making the picture appear unnatural.

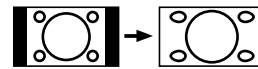

- The top and bottom of the picture are slightly cut off.

14:9 ZOOM:

This mode zooms up the Wide Picture (14:9 Aspect Ratio) to the upper and lower limits of the screen.



16:9 ZOOM:

This mode zooms up the Wide Picture (16:9 Aspect Ratio) to the full screen.

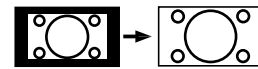

16:9 ZOOM SUBTITLE:

This mode zooms up the Wide Picture (16:9 Aspect Ratio) with subtitles to the full screen.

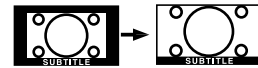

FULL:

This mode uniformly stretches the left and right sides of a normal picture (4:3 aspect ratio) to fill the wide TV screen.

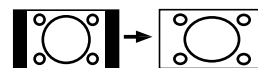

Use for pictures with a 16:9 aspect ratio that have been squeezed into a normal picture (4:3 aspect ratio), you can restore their original dimensions.

Choose the ZOOM mode

1 Press the **ZOOM** button to display the ZOOM menu

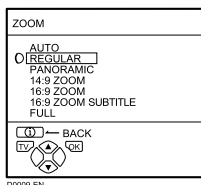

- The **ZOOM** button does not work in the twin pictures mode.

2 Press the **▼/▲** buttons to choose a ZOOM mode. Then press the **OK** button

The picture expands and the chosen ZOOM mode is displayed in about 5 seconds.

Adjusting the visible area of the picture

If subtitles or the top (or bottom) of the picture are cut off, adjust the visible area of the picture manually.

1 Press the **ZOOM** button

The ZOOM menu appears.

2 Press the **OK** button to display the ZOOM mode indication

Indicator is displayed.

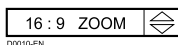

3 While it is displayed, press the **▼/▲** buttons to adjust the visible area vertically

- You cannot adjust the visible area in REGULAR or FULL mode.

CINEMA SURROUND function

You can enjoy sounds with a wider ambience.

Press the **SURROUND** button to turn the **CINEMA SURROUND** function on or off

- The CINEMA SURROUND function does not work properly with mono sound.
- The CINEMA SURROUND function can be also turned on or off by using the SOUND SETTING menu. For details, see "CINEMA SURROUND" on page 29.

Displaying the current time

You can display the Current Time on the screen.

Press the **i** (Information) button to display the current time

Pressing the **i** (Information) button changes the display as follows:

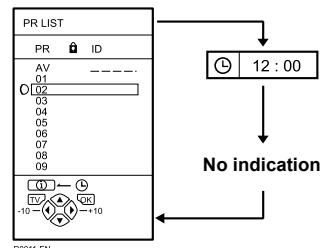

- This TV uses teletext data to set the current time. If the TV has not received a TV channel that has teletext programmes since it was turned on, the time display is blank. To view the current time, choose a TV channel that has teletext programmes.
- When watching videos, an incorrect current time is sometimes displayed.

Return to TV channel instantly

You can return to a TV channel instantly.

Press the **TV** button

The TV returns to the TV mode and a TV channel appears.

Using the FREEZE function

You can view the current programme as a still picture.

1 Press the **FREEZE** button

The still picture of the current picture will appear.



To cancel the **FREEZE** function:

Press the **FREEZE** button, the **▼/▲** buttons or the number buttons.

- The FREEZE function does not work while a sub-picture is displayed.
- The still picture cannot be output from the TV.
- The FREEZE function is cleared if no operation is performed for approximately one minute.

Using the PIP function

You can view two pictures (Main-picture and sub-picture). Two different TV programmes can be watched at the same time, or a TV programme and a video programme from an external device can be watched at the same time.

1 Press the **PIP** button

Pressing the **PIP** button changes the PIP mode as follows:

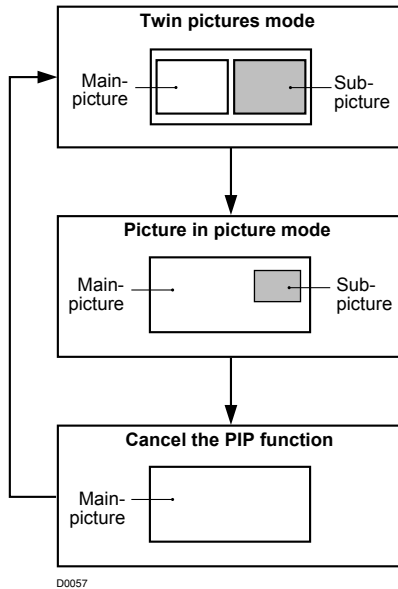

2 Press the **SUB-P** \vee/\wedge buttons to change the sub-picture to the picture from another TV channel or another VIDEO terminal

Listening to the sound of the sub-picture:

You can listen to the sound of the sub-picture with the headphones while listening to the sound of the main-picture from the TV speakers.

For details, see "HEADPHONE" on page 29.

- The sub-picture sound is monaural.

Changing the position of the sub-picture:

You can choose one of four positions.

For details, see "PIP POSITION:" on page 28.

Swapping the main-picture and sub-picture:

Press the **SWAP** button.

The main-picture and sub-picture will be swapped.

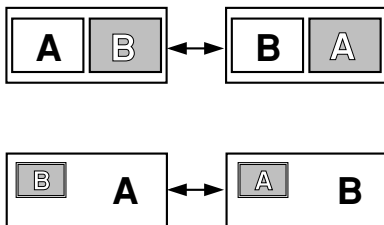

Cancelling the PIP function:

Press the **PIP** button or **TV** button.

- If the main-picture signal is poor, the quality of the sub-picture may also be poor.
- If the pictures have different standards, the top and bottom of one of them may be missing.
- If an external device is operated, the sub-picture may disappear. If this happens, press the **PIP** button again to redisplay the sub-picture.
- You cannot view a scrambled channel in the sub-picture. If the **SWAP** button is pressed when viewing a scrambled channel in the main-picture using an external decoder, the channel you have been viewing in the sub-picture will appear in both the main-picture and sub-picture.
- The **ZOOM** function does not work in the twin-picture mode.
- Do not press the **SWAP** button while you are recording the TV output on the VCR. If you do, the TV output signal will change.
- The **BLUE BACK** function does not work in the twin picture mode or the picture-in-picture mode.
- A progressive-scanning picture cannot be displayed as the sub-picture.
Pay attention to the following.
 - When the VIDEO-4 picture is a progressive-scanning picture, you cannot choose VIDEO-4 with the **SUB-P** \vee/\wedge buttons.
 - When the VIDEO-4 picture signal is changed to a progressive-scanning picture while the VIDEO-4 picture is displayed as the sub-picture, the PIP function is cancelled.
 - The pictures cannot be swapped when a progressive-scanning picture from VIDEO-4 is being displayed as the main picture.
- The sub-picture cannot be output from the TV.

Using the MULTI-PICTURE function

You can display multi-pictures that enable you to easily find a program you want to view.

1 Press the **MULTI** button to display multi-pictures

The channels are displayed in the channel number order. The multi-pictures will appear in one of the two multi-picture modes.

12-pictures multi:

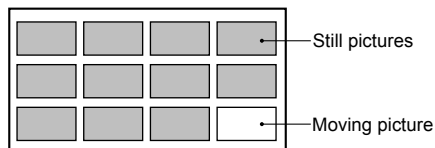

4-pictures multi:

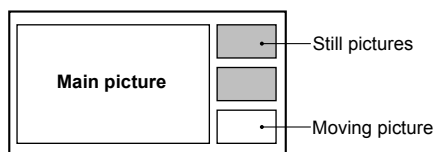

- To display the next multi-pictures, press the **MULTI** button.

2 Press the **SUB-P** ∇/\blacktriangle buttons to choose the screen you want to see

The chosen picture changes to a moving picture.

3 Press the **OK** button

The multi-pictures disappear and the chosen picture appears.

Changing the multi-picture mode:

See "MULTI-PICTURE:" on page 28.

Cancelling the multi-pictures:

Press the **TV** button, the ∇/\blacktriangle buttons, the number buttons or the **OK** button.

- Pictures from external devices cannot be displayed in the 12-pictures multi mode.
- In the 4-pictures multi mode, the picture from external devices can only be displayed as the main picture.

Operating a JVC brand VCR or DVD player

You can operate a JVC brand VCR or DVD player. Pressing the button having the same appearance as the original remote control button of a device makes the function work in the same way as the original remote control.

1 Set the **VCR** DVD Switch to the **VCR** or **DVD** position

VCR:

When you are operating the VCR, set the switch to the VCR position.

DVD:

When you are operating the DVD player, set the switch to the DVD position.

2 Press the **VCR/DVD Control Button** to control your VCR or DVD player

- If your device is not made by JVC, these buttons cannot be used.
- Even if your device is made by JVC, some of these buttons or any one of the buttons may not work, depending on the device.
- You can use the ∇/\blacktriangle buttons to choose a TV channel. The VCR will receive or choose the chapter the DVD player plays back.
- Some DVD player models use the ∇/\blacktriangle buttons for both operating of Fast forward/backward functions and choosing the chapter. In this case, the $\blacktriangleleft/\blacktriangleright$ buttons do not work.

Teletext function

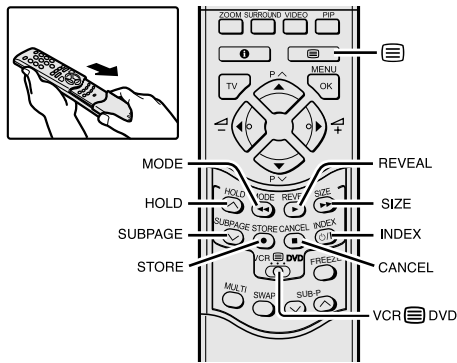

Basic operation

- 1 Choose a TV channel with a teletext broadcast
- 2 Set the VCR DVD switch to the (Text) position



- 3 Press (Text) button to display the teletext
Pressing (Text) button changes the mode as follows:

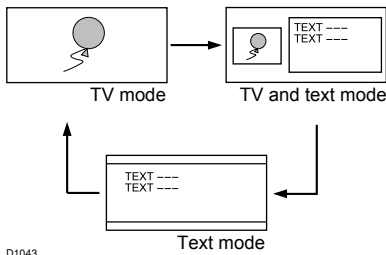

D1043

- 4 Choose a teletext page by pressing the /▲ buttons, Number buttons or Colour buttons

To return to the TV mode:
Press the **TV** button or (Text) button.

- If you have trouble receiving teletext broadcasts, consult your local dealer or the teletext station.
- The ZOOM function will not operate in the TV and text mode or Text mode.
- No menu operations are possible when viewing a teletext programme.
- Language display depends on the country which was set on the TELETEXT LANGUAGE menu. If characters on a Teletext programme do not appear properly, change the TELETEXT LANGUAGE Setting to other country's. For detail, "Changing the TELETEXT LANGUAGE setting" on page 37.

When viewing a teletext programme, the text periodically moves a little at a time towards either the top or bottom of the screen. This is to prevent burn-in and is not a malfunction.

Using the List Mode

You can store the numbers of your favourite teletext pages in memory and call them up quickly using the colour buttons.

■ To store the page numbers:

- 1 Press **MODE** button to engage the List mode

The stored page numbers are displayed at the bottom of the screen.

- 2 Press a Colour button to choose a position. Then press the Number buttons to enter the page number

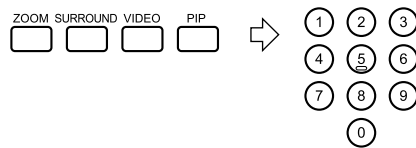

- 3 Press and hold down **STORE** button

The four page numbers blink white to indicate that they are stored in memory.

■ To call up a stored page:

- 1 Press the **MODE** button to engage the List mode

- 2 Press a colour button to which a page has been assigned

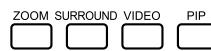

To exit the List mode:
Press the **MODE** button again.

Hold

You can hold a teletext page on the screen for as long as you want, even while several other teletext pages are being received.

Press the **HOLD** button

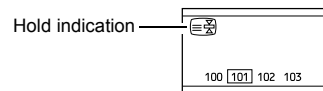

To cancel the Hold function:

Press **HOLD** button again.

- The Hold function is cleared if no operation is performed for approximately one minute.

Sub-page

Some teletext pages include sub-pages that are automatically displayed.
You can hold any sub-page, or view it at any time.

1 Press the **SUBPAGE** button to operate the Sub-page function

Sub-page numbers are displayed at the left of the screen.

Colour*	Meaning of sub-page number
Yellow	Currently being displayed.
White	Can be displayed.
Blue or Red	Cannot be displayed and it is not sent.

*: Background colour of the sub-page number.

2 Press the **▼/▲** buttons to choose a sub-page number

To cancel the Sub-page function:
Press the **SUBPAGE** button again.

Reveal

Some teletext pages include hidden text (such as answers to a quiz).
You can display the hidden text.

Each time you press the REVEAL button, text is hidden or revealed

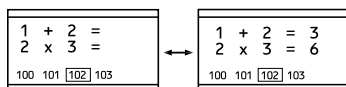

Size

You can double the height of the teletext display.

Press the **SIZE** button.

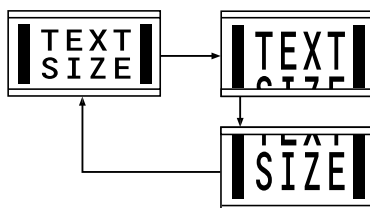

Index

You can return to the index page instantly.

Press INDEX button

Returns to page 100 or a previously specified page.

Cancel

You can search for a teletext page while watching TV.

1 Press the **Number** button to enter a page number, or press a **Colour** button

The TV searches for a teletext page.

2 Press **CANCEL** button

The TV programme appears. When the TV finds the teletext page, its page number appears in the upper left of the screen.

3 Press **CANCEL** button to return to a teletext page when the page number is on the screen

- The TV mode cannot be resumed even by pressing the **CANCEL** button. A TV programme is temporarily displayed instead of the teletext programme.

Using the TV's menu

This TV has a number of functions you can operate using menus. To fully utilize all your TV's functions, you need to understand the basic menu operating techniques fully.

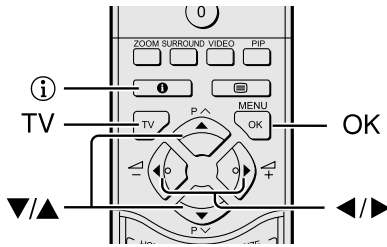

5 Press the OK button to complete the setting

The menu disappears.

- When watching the television with the NTSC system, the menus are displayed at about half of their normal vertical size.

Operation with the buttons on the TV

You can also operate the menus using the buttons on the front panel of the TV.

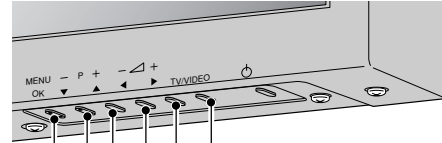

MENU/OK button up/down buttons left/right buttons TV/VIDEO button

The menu will disappear if no operation is performed for approximately one minute.

Basic operation

1 Press the OK button to display the MENU (main menu)

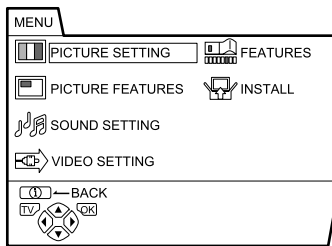

D0013-EN

- Press the **OK** button twice while watching the MULTI-PICTURE mode.
- The display appearing at the bottom of a menu indicates buttons on the remote control you can use when you operate a chosen function.

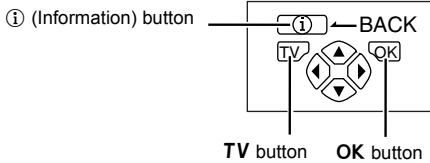

2 Press the left/right and up/down buttons to choose a menu title, and press the OK button

The menu appears.

To return to the previous menu:

Press the **i** (information) button.

To exit a menu instantly:

Press the **TV** button.

3 Press the up/down buttons to choose a function

- For details of the functions in the menus, see the following pages.

4 Press the left/right buttons to choose the setting of that function

- If you want to operate a function which appears only with its name, follow the descriptions of that function on the following pages.
- The display appearing at the bottom of a menu shows you a button on the remote control that you can use when you operate a chosen function.

PICTURE SETTING

Refer to "Using the TV's menu" (see page 24) for details of displaying the menu.

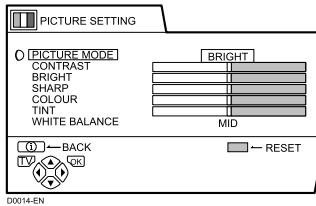

PICTURE MODE

You can choose one of three PICTURE MODEs to adjust the picture settings automatically.

BRIGHT:

Heightens contrast and sharpness.

STANDARD:

Standardizes picture adjustment.

SOFT:

Softens contrast and sharpness.

Picture Adjustment

You can change the picture settings of each PICTURE MODE mode as you like.

CONTRAST:

You can adjust the picture contrast.

◀ : lower

▶ : higher

BRIGHT:

You can adjust the picture brightness.

◀ : darker

▶ : brighter

SHARP:

You can adjust the picture sharpness.

◀ : softer

▶ : sharper

COLOUR:

You can adjust the picture colour.

◀ : lighter

▶ : deeper

TINT:

You can adjust the picture tint.

◀ : reddish

▶ : greenish

- You can change the TINT setting (picture hue) when the colour system is NTSC 3.58, NTSC 4.43 or a signal from the VIDEO-4 terminal.

However, operation is not possible when the PIP function main picture is set to VIDEO-4.

To return to the default settings in each PICTURE MODE :

Press the blue button.

- This returns the picture settings in the PICTURE MODE mode you have chosen to the default settings, and stores them in the PICTURE MODE mode.

WHITE BALANCE

You can select one of three WHITE BALANCE modes (three tones of white) to adjust the white balance of the picture. Since white is the colour which is used as a reference for all the other colours, changing the WHITE BALANCE mode affects the appearance of all the other colours on the screen.

COOL:

A bluish white. Using this mode when watching bright pictures allows you to enjoy a more vivid and bright picture.

MID:

The normal white colour.

WARM:

A reddish white. Using this mode when watching films allows you to enjoy colours that are characteristic of films.

PICTURE FEATURES

Refer to “Using the TV’s menu” (see page 24) for details of displaying the menu.

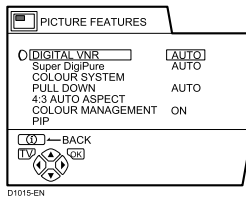

DIGITAL VNR

The DIGITAL VNR function cuts down the amount of noise in the original picture. You can choose from the three DIGITAL VNR function settings of AUTO, MIN and MAX.

AUTO:

The TV will automatically adjust the level of the DIGITAL VNR effect to match the amount of noise in the picture, giving you the best possible picture.

- If you set the DIGITAL VNR effect too high it can make the picture less sharp. It is recommended to use the AUTO setting if you can.
- AUTO cannot be chosen when you are watching the VIDEO-4 picture.

MIN:

The level of the DIGITAL VNR effect is set to the minimum. If you set the DIGITAL VNR function to AUTO but feel that the sharpness of the original picture has not been reproduced fully, change the setting from AUTO to MIN.

- The MIN setting is not suitable for low-quality pictures which contain a lot of noise.

MAX:

The level of the DIGITAL VNR effect is set to the maximum. If you set the DIGITAL VNR function to AUTO but still notice some noise, change the setting from AUTO to MAX.

- The MAX setting is not suitable for high-quality pictures which contain very little noise.
- When a progressive-scanning picture is being displayed, “DIGITAL VNR” cannot be selected.
- The DIGITAL VNR function does not work for progressive-scanning pictures.

Super DigiPure

The Super DigiPure function uses the latest in digital technology to give you a natural-looking picture. The Super DigiPure function includes the following two functions.

DigiPure function:

This function helps to create a natural-looking picture by eliminating unnecessary edges from high-contrast and crisp images. For images with low-contrast, edges are added to produce a sharper, more detailed picture.

You can choose from the three DigiPure function settings of AUTO, MIN and MAX.

- If you set the DigiPure effect too high on a low-quality picture that contains a lot of noise, this may actually make the noise worse. We recommend you use the AUTO setting if you can.

Picture motion compensation function:

This function displays fast-moving pictures (for example, the players or ball in a football game) more smoothly and naturally on the screen.

- The effect level of the picture motion compensation function cannot be changed. The effect level is the same no matter which of the AUTO, MIN or MAX settings is used.

1 Choose Super DigiPure

2 Press the ◀▶ buttons to choose a setting. Then press the OK button

AUTO:

The TV will automatically adjust the level of the DigiPure effect to match the amount of noise in the picture, giving the best possible picture.

- AUTO cannot be chosen when you are watching the VIDEO-4 picture.

MIN:

The level of DigiPure effect is set to the minimum. When you set the Super DigiPure function to AUTO and notice some noise, change the setting from AUTO to MIN.

- The MIN setting is not suitable for high-quality pictures which contain very little noise.

MAX:

The level of DigiPure effect is set to the maximum. If you set the Super DigiPure function to AUTO but feel that the original picture quality has not been reproduced fully, change the setting from AUTO to MAX.

- The MAX setting is not suitable for low-quality pictures which contain a lot of noise.

OFF:

The Super DigiPure function is turned off.

COLOUR SYSTEM

The colour system is chosen automatically. However, if the picture is not clear or no colour appears, choose the colour system manually.

1 Choose COLOUR SYSTEM. Then press the OK button

The sub-menu of the COLOUR SYSTEM function appears.

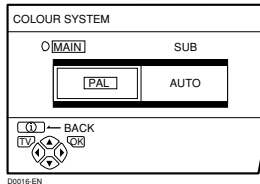

2 Press the ◀/▶ buttons to choose MAIN or SUB

MAIN:

You can change the colour system of the main-picture.

SUB:

You can change the colour system of the sub-picture.

- Choose MAIN when a sub-picture is not displayed.

3 Press the ▼/▲ buttons to choose the appropriate colour system. Then press the OK button

AUTO:

This function detects a colour system from the input signal. You can only use this when you are viewing a picture from programme number PR 0 (AV), or a VIDEO terminal.

Refer to the following table for the various international colour systems.

Colour system

Area	Country or region	System
Asia, Middle East	Bahrain, Kuwait, Oman, Qatar, United Arab Emirates, Yemen, etc. Indonesia, Malaysia, Singapore, Thailand, India, etc.	PAL
	China, Vietnam, etc	PAL
	Hong Kong, etc	PAL
	Islamic Republic of Iran, Lebanon, Saudi Arabia, etc.	SECAM
Europe	Russia, etc	SECAM
	Czech Republic, Poland, etc	PAL
	Germany, Holland, Belgium, etc	PAL
	UK, etc	PAL
Oceania	Australia, New Zealand, etc	PAL
Africa	Republic of South Africa, etc	PAL
	Nigeria, etc	PAL
	Egypt, Morocco, etc	SECAM

- The AUTO function may not function properly if you have poor signal quality. If the picture is abnormal in the AUTO function, choose another colour system manually.
- When in the Programme numbers PR 0 (AV) to PR 99, you cannot choose NTSC 3.58 or NTSC 4.43.

PULL DOWN

The PULL DOWN function displays a cinema film picture more smoothly and naturally on the screen.

AUTO:

The television automatically recognizes the type of signal and turns the function on and off.

ON:

This function is turned on.

OFF:

This function is turned off.

- The motion may appear unnatural when viewing images with the NTSC colour system. When the PULL DOWN function is set to AUTO or ON, the motion may appear unnatural when viewing images with the NTSC colour system.
- You cannot select this function in the twin pictures mode or the picture in picture mode.

4:3 AUTO ASPECT

You can choose one of three ZOOM modes, REGULAR, PANORAMIC or 14:9 ZOOM, as the ZOOM mode for the normal picture (4:3 aspect ratio).

1 Choose 4:3 AUTO ASPECT then press the OK button

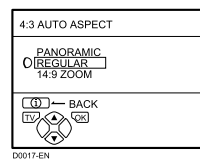

2 Press the ▼/▲ buttons to choose a ZOOM mode. Then press the OK button

COLOUR MANAGEMENT

This TV supports the COLOUR MANAGEMENT function to ensure dull colours are compensated to produce natural hues.

The COLOUR MANAGEMENT function is on by default.

ON:

COLOUR MANAGEMENT function is turned on.

OFF:

COLOUR MANAGEMENT function is turned off.

- Set this function to ON under normal conditions.

PIP

PIP POSITION:

You can choose one of four positions for the sub-picture.

- 1 Press the ▼/▲ buttons to choose PIP. Then press the OK button**

The PIP menu appears.

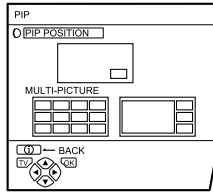

- 2 Press the ▼/▲ buttons to choose PIP POSITION**

- 3 Press the ◀/▶ buttons to choose the position. Then press the OK button**

MULTI-PICTURE:

Choosing the number of pictures for the MULTI-PICTURE function

- 1 Press the ▼/▲ buttons to choose PIP. Then press the OK button**

The PIP menu appears.

- 2 Press the ▼/▲ buttons to choose MULTI-PICTURE**

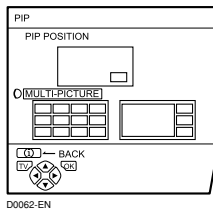

- 3 Press the ◀/▶ buttons and choose the number of pictures. Then press the OK button**

SOUND SETTING

Refer to “Using the TV’s menu” (see page 24) for details of displaying the menu.

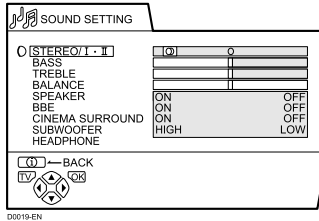

STEREO / I • II

When you are viewing a bilingual broadcast programme, you can choose the sound from Bilingual I (Sub I) or Bilingual II (Sub II). When the stereo broadcasting is received poorly, you can change from stereo to mono sound so that you can hear the broadcast more clearly and easily.

∞ : Stereo sound

○ : mono sound

I : Bilingual I (sub I)

II : Bilingual II (sub II)

- The sound mode you can choose differs depending on the TV programme.
- This function does not work in the VIDEO modes. And this function does not appear in the SOUND SETTING menu.

Sound Adjustment

You can adjust the sound to your liking.

BASS:

You can adjust the low tone of the sound.

◀ : weaker

▶ : strong

TREBLE:

You can adjust the high tone of the sound.

◀ : weaker

▶ : strong

BALANCE:

You can adjust the volume balance between the left and right speaker.

◀ : turn the left speaker’s volume level up.

▶ : turn the right speaker’s volume level up.

SPEAKER

You can turn off the sound from the TV speakers; but you should only do this if an audio system is connected to the TV as a substitute for the TV speakers.

ON:

The TV speakers issue sound.

OFF:

The TV speakers does not issue sound.

BBE

You can use the BBE function to enjoy easy-to-listen sound that is faithful to the original sound recorded.

ON:

This function is turned on.

OFF:

This function is turned off.

- Licensed by BBE Sound, Inc. BBE is a registered trademark of BBE Sound, Inc.

CINEMA SURROUND

You can enjoy Surround sound with a “live” effect by using the CINEMA SURROUND function.

ON:

CINEMA SURROUND function is turned on.

OFF:

CINEMA SURROUND function is turned off.

SUBWOOFER

Choose the strength of the bass sounds from the subwoofer.

HIGH:

Emphasizes the bass sounds from the subwoofer.

LOW:

Reduces the strength of the bass sounds from the subwoofer.

HEADPHONE

You need to use the HEADPHONE menu to adjust the volume of the headphones.

The HEADPHONE menu can also be used to set whether or not sound comes from the TV speakers when the headphones are being used and to perform the settings for the sound coming from the headphones.

- 1 Press the ▼/▲ buttons to choose HEADPHONE. Then press the OK button

The sub-menu of the HEADPHONE function appears.

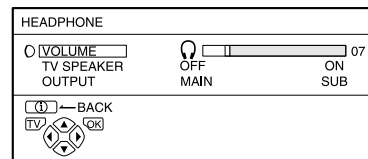

- 2 Press the ▼/▲ buttons to choose a function. Then press the ◀/▶ buttons to change the setting

VOLUME:

You can change the volume of the headphones.

TV SPEAKER:

You can turn the TV’s speakers on or off.

ON:

The sound comes from the TV’s speakers when using the headphones.

OFF:

The sound does not come from the TV’s speakers when using the headphones.

OUTPUT:

You can choose the sound output to the headphones.

MAIN:

You can listen to the sound of the main-picture with your headphones.

SUB:

You can listen to the sound of the sub-picture with your headphones.

- When the sub-picture is a television programme, the sound becomes monaural.

3 Press the OK button

Hint:

When a sub-picture is displayed, the sound of the sub-picture can be listened to with the headphones while listening to the sound of the main-picture with the TV speakers. To do this, set TV SPEAKER to ON and OUTPUT to SUB.

-
- Headphones do not work with sound adjusted for BASS and TREBLE, BBE effect sound, and CINEMA SURROUND effect sound.
-

VIDEO SETTING

Refer to “Using the TV’s menu” (see page 24) for details of displaying the menu.

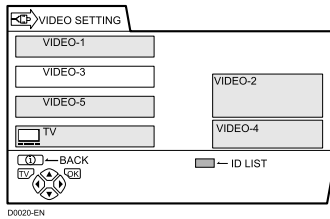

ID LIST

You can have a name corresponding to the devices connected for each VIDEO terminal. Giving a name to a VIDEO terminal makes the VIDEO terminal number appear on the screen, together with the name.

1 Choose a VIDEO terminal

The image from the chosen external equipment is displayed in the background on the menu. The image on the TV is displayed if the TV is chosen.

2 Press the blue button to display the name list (ID LIST)

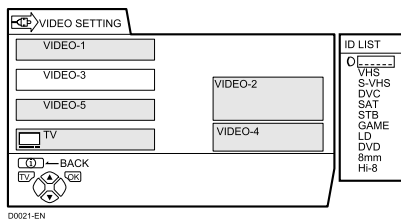

3 Press the ▼/▲ buttons to choose a name. Then press the OK button

The ID LIST disappears and the name is assigned to the VIDEO terminal.

- You cannot assign a VIDEO terminal name not found in the name list (ID LIST).

To erase a name assigned to the VIDEO terminal:

Choose a blank space.

4 Press the OK button to complete the setting

FEATURES

Refer to "Using the TV's menu" (see page 24) for details of displaying the menu.

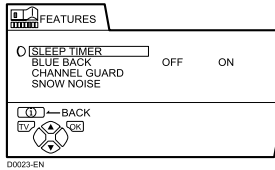

SLEEP TIMER

You can set the TV to automatically turn off after a specified period of time.

1 Choose SLEEP TIMER, then press the OK button

A Sub-menu of the SLEEP TIMER function appears.

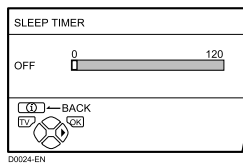

2 Press the ◀/▶ buttons to set the period of time. Then press the OK button

You can set the period of time a maximum of 120 minutes (2 hours) in 10 minute increments.

- One minute before the SLEEP TIMER function turns off the TV, "GOOD NIGHT!" appears.
- The SLEEP TIMER function cannot be used to turn off the TV's main power.
- When the SLEEP TIMER function is on, you can display the Sub-menu of the SLEEP TIMER function again to confirm and/or change the remaining period of time of the SLEEP TIMER function. Press the OK button to exit the menu after confirming and / or changing the remaining time.

To cancel the SLEEP TIMER function:

Press the ◀ button to set a period of time to "OFF".

BLUE BACK

You can set the TV to automatically change to a blue screen and mute the sound if the signal is weak or absent, or when there is no input from an external device.

ON:

This function is turned on.

OFF:

This function is turned off.

CHANNEL GUARD

When there is a TV channel you wish your children not to watch, you can use the CHANNEL GUARD function to lock out the TV channel. Even when a child chooses a Programme number (PR) in which a locked TV channel has been registered, the screen will change to blue and displays  (CHANNEL GUARD) so the TV channel cannot be viewed. Unless you enter a pre-set ID number by a special operation, the lock cannot be released and the child cannot view the TV channel programmes.

To set the CHANNEL GUARD function

1 Choose CHANNEL GUARD, then press the 0 (AV) button

"SET ID NO." (ID number setting screen) appears.

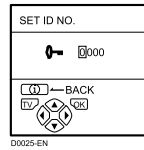

2 Set the ID number to your liking

- 1 Press the ▼/▲ buttons to choose a number.
- 2 Press the ◀/▶ buttons to move the cursor.

3 Press the OK button

The Sub-menu of CHANNEL GUARD appears.

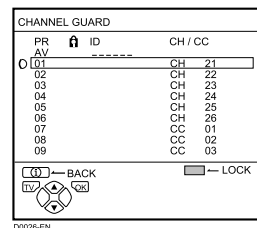

4 Press the ▼/▲ buttons to choose a TV channel

Every time you press the ▼/▲ buttons, the Programme number (PR) changes, and the picture of the TV channel registered in the Programme number (PR) is displayed on the screen.

5 Press the blue button and set the CHANNEL GUARD function. Then press the OK button

 (CHANNEL GUARD) appears and the TV channel is locked.

To reset the CHANNEL GUARD function:

Press the blue button again.

 (CHANNEL GUARD) disappears.

To disable easy resetting of the CHANNEL GUARD function, the menu disappears by choosing the CHANNEL GUARD function and pressing the OK button as in the ordinary menu operation.

To view a locked TV channel

1 Choose a Programme number (PR) in which a TV channel locked with the Number buttons or PR LIST

The screen changes to blue and the  (CHANNEL GUARD) appears. You cannot view the TV channel.

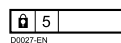

2 Press the ⓘ (Information) button to display "ID NO." (ID NO. input screen)

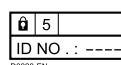

3 Press the Number buttons to enter the ID number

The lock is temporarily released so you can view the TV channel.

If you have forgotten the ID number:

Perform step 1 of “To set the CHANNEL GUARD function”. After confirming the ID number, press the **TV** button to exit the menu.

-
- Even if you reset the lock temporarily, it does not mean that the CHANNEL GUARD function set for the TV channel is cancelled. The next time anyone attempts to view the TV channel, it will be locked again.
 - When you would like to cancel the CHANNEL GUARD function, you must perform the operation “To set the CHANNEL GUARD function” again.
 - To disable easy choosing of a Programme number (PR) in which a locked TV channel has been registered, the Programme number (PR) has been set that it cannot be chosen by the ▼/▲ buttons or the operation buttons at the TV.
 - To disable easy resetting of the lock, “ID NO.” (ID NO. input screen) is set so that it cannot appear unless you press the ⓘ (Information) button.
-

SNOW NOISE

When burn-in is minimal, burn-in and residual images may be softened with the SNOW NOISE function.

1 Choose SNOW NOISE**2 Press the OK button**

Snow appears on the screen. Leave the TV in this condition for a few hours.

3 After a few hours, press the TV, number buttons, or ⏻/I button

Press the ⏻ button for the TV.

The SNOW NOISE function has no effect if used only for a short time.

INSTALL

Refer to “Using the TV’s menu” (see page 24) for details of displaying the menu.

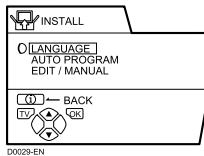

LANGUAGE

You can choose the language you want to use for the on-screen display from the language list in a menu.

- 1 Choose **LANGUAGE**, then press the **OK** button
A sub-menu of the LANGUAGE function appears.



- 2 Press the **◀/▶** and **▼/▲** buttons to choose a language. Then press the **OK** button

AUTO PROGRAM

You can automatically register the TV channels which can be received well at your residence in the TV’s Programme numbers (PR) by performing the following.

- 1 Choose **AUTO PROGRAM**. Then press the **OK** button

The TELETEXT LANGUAGE menu appears as a sub-menu of the AUTO PROGRAM function.

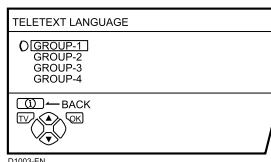

- 2 Press the **▼/▲** buttons to choose the teletext language group that corresponds to the language of teletext programme that you want to watch

Group	Languages
GROUP-1	Turkish, Hungarian, English, German, French, Italian, Spanish, Portuguese, Greek, Swedish, Finnish
GROUP-2	Polish, Serbian, Croatian, Slovenian, Czech, Slovak, Rumanian, Hungarian, German, French, Italian, Swedish, Finnish
GROUP-3	Russian, Bulgarian, Lettish, Lithuanian, Estonian, Ukrainian, Serbian, Croatian, Slovenian, Czech, Slovak, English, German
GROUP-4	Arabic, Czech, Slovak, Hungarian, English, German, French, Italian, Spanish, Portuguese, Swedish, Finnish

- 3 Press the **OK** button to start the **AUTO PROGRAM** function

The AUTO PROGRAM menu appears and received TV channels are automatically registered in the Programme numbers (PR).

- To cancel the AUTO PROGRAM function, press the **TV** button.

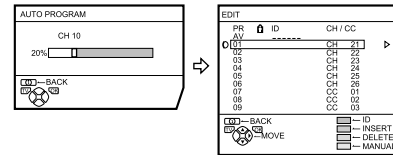

After the TV channels have been registered in the Programme numbers (PR), the **EDIT** menu appears.

- You can proceed to edit the Programme numbers (PR) using the **EDIT/MANUAL** function. For details, see “EDIT/MANUAL” on page 34.
- If you do not need to use the **EDIT/MANUAL** function, go to the next step.

- 4 Press the **OK** button

EDIT/MANUAL

The **EDIT/MANUAL** functions are divided into two types: editing of the current Programme numbers (PR) (**EDIT** functions) and manual registration of a TV channel you want to view to the Programme number (PR) (**MANUAL** function). The details about these functions are as follows:

Caution

- Using the **MOVE**, **DELETE** or **INSERT** function rewrites the current Programme numbers (PR) list. Resultingly, the Programme number (PR) of some of the TV channels will change.
- Using the **MANUAL** function for a TV channel for which the **CHANNEL GUARD** function has been set cancels the **CHANNEL GUARD** function for the TV channel.
- When a TV channel has already been registered in PR 99, using the **INSERT** function deletes the TV channel.

- 1 Choose **EDIT/MANUAL**, then press the **OK** button

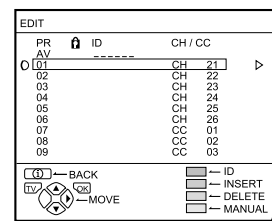

- For Programme number PR 0, “AV” appears in the Programme numbers (PR) list.
- A VIDEO terminal number does not appear in the Programme numbers (PR) list.
- The CH/CC number is a number unique to the TV and corresponding to the Channel number of a TV channel. For the relationship of a Channel number and a CH/CC number, see “CH/CC numbers” on page 40.

2 Follow the operation description of a function you want to use and operate the function

MOVE:

This function changes a Programme number (PR) of a TV channel.

ID:

This function registers a Channel name (ID) to a TV channel.

INSERT:

This function adds a new TV channel in the current Programme numbers (PR) list by using the CH/CC number.

- You cannot use the INSERT function if you do not know a Channel number of a TV channel. Use the MANUAL function to register a TV channel in the Programme number (PR).

DELETE:

This function deletes an unnecessary TV channel.

MANUAL:

This function manually registers a new TV channel in a Programme number (PR).

3 Press the OK button

■ **MOVE**

1 Press the ▼/▲ buttons to choose a TV channel

Every time you press the ▼/▲ buttons, the Programme number (PR) is changed over, and the picture of the TV channel registered in the Programme number (PR) appears on the screen.

2 Press the ► button to start the MOVE function

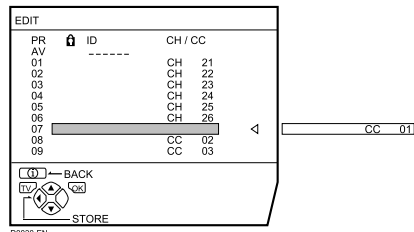

3 Press the ▼/▲ buttons to choose a new Programme number (PR)

To cancel the MOVE function:

Press the ⓘ (Information) button.

4 Press the ◀ button to change the Programme number (PR) of a TV channel to a new Programme number (PR)

■ **ID**

1 Press the ▼/▲ buttons to choose a TV channel

Every time you press the ▼/▲ buttons, the Programme number (PR) is changed over, and the picture of the TV channel registered in the Programme number (PR) appears on the screen.

2 Press the red button to start the ID function

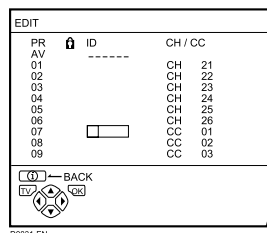

3 Enter a channel name (ID). Press the ▼/▲ buttons to choose a character. Press the ◀/▶ buttons to move the cursor.

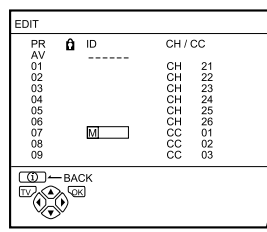

To cancel the ID function:

Press the ⓘ (Information) button.

4 Press the OK button to register a Channel name (ID) to a TV channel

■ **INSERT**

Preparation:

- A CH/CC number unique to this TV and corresponding to the Channel number of a TV channel is required. Find the corresponding CH/CC number from a table "CH/CC numbers" on page 40 based on the Channel number of the TV channel.

1 Press the ▼/▲ buttons to choose a Programme number (PR) for which you will register a new TV channel

2 Press the green button and start the INSERT function

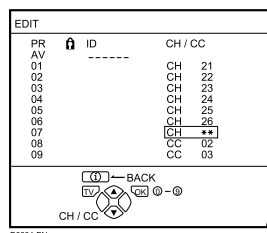

3 Press the ▼/▲ buttons to choose "CC" or "CH" according to the CH/CC number of the TV channel

To cancel the INSERT function:

Press the ⓘ (Information) button.

4 Press the Number buttons to enter the remaining CH/CC number

The TV shifts to registration mode.
 When the registration is completed, the picture of the TV channel appears on the screen.

- The CH/CC number is a number indicating the broadcast frequency to the TV. If the TV cannot detect the TV channel corresponding to the broadcast frequency indicated by the CH/CC number, a picture in the no-signal state appears.

■ DELETE

1 Press the ▼/▲ buttons to choose a TV channel

Every time you press the ▼/▲ buttons, the Programme number (PR) is changed over, and the picture of the TV channel registered in the Programme number (PR) appears on the screen.

2 Press the yellow button to delete the TV channel

The TV channel is deleted from the Programme numbers (PR) list.

■ MANUAL

1 Press the ▼/▲ buttons to choose a Programme number (PR) to which you want to register a new TV channel

2 Press the blue button to activate the MANUAL function

At the right side following the CH/CC number, the SYSTEM (broadcasting system) of the TV channel appears.

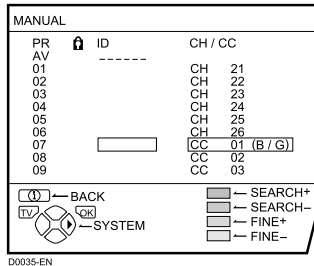

To cancel the MANUAL function:
 Press the ⓘ (Information) button.

3 Press the ► button to choose the SYSTEM (sound system) for a TV channel you want to register

Refer to the following table for the various international sound systems.

Sound system

Area	Country or region	System
Asia, Middle East	Bahrain, Kuwait, Oman, Qatar, United Arab Emirates, Yemen, etc. Indonesia, Malaysia, Singapore, Thailand, India, etc.	B/G
	China, Vietnam, etc.	D/K
	Hong Kong, etc.	I
	Islamic Republic of Iran, Lebanon, Saudi Arabia, etc.	B/G
Europe	Russia, etc.	D/K
	Czech Republic, Poland, etc.	D/K
	Germany, Holland, Belgium, etc.	B/G
	UK, etc.	I
Oceania	Australia, New Zealand, etc.	B/G
Africa	Republic of South Africa, etc.	I
	Nigeria, etc.	B/G
	Egypt, Morocco, etc.	B/G

4 Press the green or red button to search for a TV channel

Scanning stops when the TV finds a TV channel. Then the TV channel is displayed.

5 Press the green or red button repeatedly until the TV channel you want appears

If the TV channel reception is poor:
 Press the blue or yellow button to fine-tune the TV channel.

If you cannot hear the normal sound even when the picture of the TV channel appears normally:
 The SYSTEM setting is wrong. Press the ► button and choose a SYSTEM that has normal sound.

6 Press the OK button and register the TV channel to a Programme number (PR)

The normal EDIT menu is resumed.

Changing the TELETEXT LANGUAGE setting

After the AUTO PROGRAM function is completed, you can change the country you have already set by using the AUTO PROGRAM function.

1 Display the INSTALL menu

When the EDIT menu is currently being displayed:

Press the **i** (Information) to return to the INSTALL menu.

2 Press the ▼/▲ buttons to choose AUTO PROGRAM. Then press the OK button

A TELETEXT LANGUAGE menu appears as a sub-menu of the AUTO PROGRAM function.

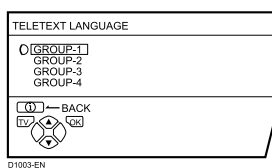

01003-EN

Group	Languages
GROUP-1	Turkish, Hungarian, English, German, French, Italian, Spanish, Portuguese, Greek, Swedish, Finnish
GROUP-2	Polish, Serbian, Croatian, Slovenian, Czech, Slovak, Rumanian, Hungarian, German, French, Italian, Swedish, Finnish
GROUP-3	Russian, Bulgarian, Lettish, Lithuanian, Estonian, Ukrainian, Serbian, Croatian, Slovenian, Czech, Slovak, English, German
GROUP-4	Arabic, Czech, Slovak, Hungarian, English, German, French, Italian, Spanish, Portuguese, Swedish, Finnish

3 Press the ▼/▲ buttons to choose a group

4 Press the TV button to complete the setting

The menu disappears.

Additional preparation

Connecting the external devices

Connect the devices to the TV, paying attention to the following connection diagram.

Before connecting anything:

- Read the manuals provided with the devices. Depending on the devices, the connection method may differ from the figure. In addition, the device settings may be changed depending on the connection method to secure proper operation.
- Turn off all the devices including the TV.
- The "Specifications" on page 43 contains the details of the VIDEO terminals. If you are connecting a device not listed in the following connection diagram, see the table to choose the best VIDEO terminal.
- Note that connecting cables are not supplied.

- ① VCR (composite signal)
- ② VCR (S-VIDEO signal; Y/C)
- ③ VCR for recording (composite signal)
- ④ DVD player (composite signal)
- ⑤ DVD player (S-VIDEO signal; Y/C)
- ⑥ DVD player (component video signals; Pr/Pb/Y)
- ⑦ TV game (composite signal/S-VIDEO signal; Y/C)
- ⑧ Headphones
- ⑨ Camcorder (composite signal/S-VIDEO signal; Y/C)
- ⑩ Audio/Video cable
- ⑪ Video cable
- ⑫ Audio cable
- ⑬ S-VIDEO cable
- ⑭ Component cable

ENGLISH

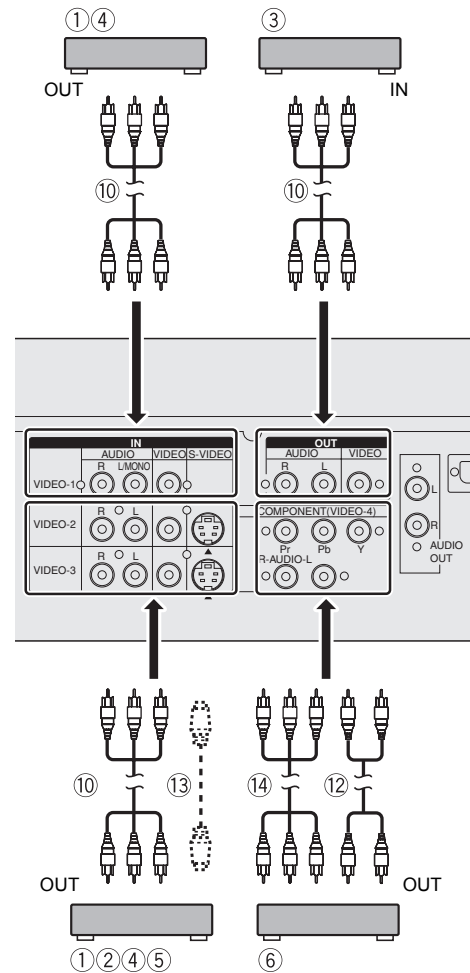
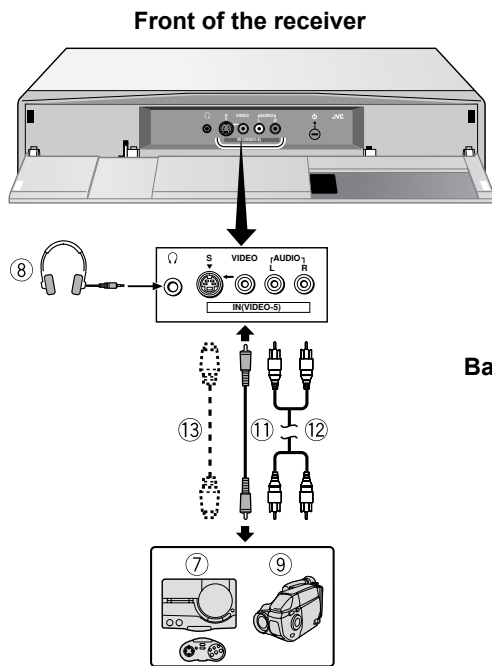

■ Connecting devices to the OUT terminal

The signals of the images and sound you are currently viewing with this TV are output through the OUT terminal. By connecting a VCR to the OUT terminal, you can record the currently shown image and sound to that VCR. To do this, connect the VCR and OUT terminal following the steps below.

1 Connect the VIDEO in the OUT terminals and the VCR's VIDEO IN (video input) terminal with a video cable

2 Connect the AUDIO (L and R) in the OUT terminals and the VCR's AUDIO IN (audio L/R input) terminals with an audio cable

- When you turn off the TV, the signals from the OUT terminal are also turned off.
- No signal is output when VIDEO-4 is chosen.

■ Connecting headphones

Connect the headphones with a stereo mini-jack (of 3.5 mm in diameter) to the headphone jack at the receiver.

- The headphone volume is adjusted with the "HEADPHONE" menu (see page 29).

■ Connecting Speakers/Amplifier

See the Audio equipment connection diagram, then connect the audio equipment you desire to the TV.

You can use external front speakers to listen to the TV sound instead of the TV speakers.

Before connecting anything:

- Read the manuals provided with the amplifier and speakers.
- Turn the TV and amplifier off.
- To prevent magnetism from the speakers adversely affecting the TV screen, use magnetically-shielded speakers for the front speakers.
- Note that connecting cables are not supplied.

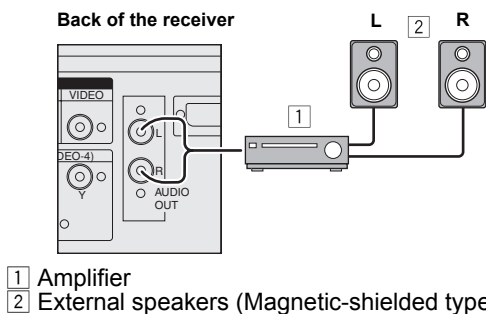

- The output from the AUDIO OUT terminal is not interrupted by headphone connection to the TV. You cannot cut the sound from the front speaker even if you connect a headphone to the TV.
- Adjust the volume of the external speakers with the amplifier.

CH/CC numbers

When you want to use the INSERT function on page 35, find the CH/CC number corresponding to the Channel number of the TV channel from this table.

CCIR: The CCIR channel numbers are the channel numbers used in the Middle East, Southeast Asia, etc.

OIRT: The OIRT channel numbers are the channel numbers used in Eastern Europe, Russia, Vietnam, etc.

AUSTRALIA: The AUSTRALIA channel numbers are the channel numbers used in Australia, etc.

ENGLISH

CH	CCIR	Channel OIRT	AUSTRALIA
CH02	E2	R1	AU-0
CH03	E3		AU-1
CH04	E4	R2	AU-2
CH05	E5	R6	AU-6
CH06	E6	R7	AU-7
CH07	E7	R8	AU-8
CH08	E8	R9	AU-9
CH09	E9		
CH10	E10	R10	AU-10
CH11	E11	R11	AU-11
CH12	E12	R12	
CH13			
CH14			
CH15			
CH16			
CH17			
CH18			
CH19			
CH20			
CH21	E21		
CH22	E22		
CH23	E23		
CH24	E24		
CH25	E25		
CH26	E26		
CH27	E27		
CH28	E28		
CH29	E29		
CH30	E30		
CH31	E31		
CH32	E32		
CH33	E33		
CH34	E34		
CH35	E35		
CH36	E36		
CH37	E37		
CH38	E38		
CH39	E39		
CH40	E40		
CH41	E41		
CH42	E42		
CH43	E43		
CH44	E44		
CH45	E45		
CH46	E46		
CH47	E47		
CH48	E48		
CH49	E49		
CH50	E50		
CH51	E51		
CH52	E52		
CH53	E53		
CH54	E54		
CH55	E55		
CH56	E56		
CH57	E57		
CH58	E58		
CH59	E59		
CH60	E60		
CH61	E61		
CH62	E62		
CH63	E63		
CH64	E64		
CH65	E65		
CH66	E66		
CH67	E67		
CH68	E68		
CH69	E69		
CH70			

CC	CCIR	Channel OIRT	AUSTRALIA
CC01	S-1		AU-5
CC02	S-2		
CC03	S-3		
CC04	S-4		
CC05	S-5		
CC06	S-6		AU-5A
CC07	S-7		
CC08	S-8		
CC09	S-9		
CC10	S-10		
CC11	S-11		
CC12	S-12		
CC13	S-13		
CC14	S-14		
CC15	S-15		
CC16	S-16		
CC17	S-17		
CC18	S-18		
CC19	S-19		
CC20	S-20		
CC21	S-21		
CC22	S-22		
CC23	S-23		
CC24	S-24		
CC25	S-25		
CC26	S-26		
CC27	S-27		
CC28	S-28		
CC29	S-29		
CC30	S-30		
CC31	S-31		
CC32	S-32		
CC33	S-33		
CC34	S-34		
CC35	S-35		
CC36	S-36		
CC37	S-37		
CC38	S-38		
CC39	S-39		
CC40	S-40		
CC41	S-41		
CC42			
CC43			
CC44			
CC45			
CC46			
CC47			
CC48			
CC49			
CC50			
CC51			
CC52			
CC53			
CC54			
CC55			
CC56			
CC57			
CC58			
CC59			
CC60			
CC61			
CC62			
CC63			
CC64			
CC75	X		
CC76	Y	R3	
CC77	Z	R4	AU-3
CC78	Z+1	R5	
CC79	Z+2		AU-4
CC95			
CC96			
CC97			
CC98			
CC99			

Troubleshooting

If a problem arises while you are using the TV, please read this “Troubleshooting” well before you request having the TV repaired. You may be able to fix it easily by yourself. For example, if the AC plug is disconnected from the AC outlet, or the TV aerial has problems, you may think there is a problem with the TV itself.

Important:

- This Troubleshooting guide only covers problems whose cause are not easy to determine. If a question arise when you are operating a function, read the page(s) corresponding to the operation of the function well, not this Troubleshooting guide.
- After you have followed the Troubleshooting description or the operating description of the functions concerned without any success, remove the AC plug from the AC outlet and request a repair of your TV. Do not attempt to repair the TV by yourself or remove the rear cover of the TV.

■ If you cannot turn on the TV

- Are the AC plugs on the power cords from the TV and receiver connected to AC outlets?

■ No picture/No sound

- Have you chosen a TV channel whose reception is extremely bad? In this case, the BLUE BACK function will be activated, the entire screen becomes blue, and the sound is muted. In spite of this, if you want to view the TV channel, follow the description “BLUE BACK” on page 32 to try to change the BLUE BACK function setting to OFF.
- Have you set the SPEAKER function to OFF? Follow the description “SPEAKER” on page 29 to confirm the SPEAKER function setting to try to solve the problem.
- If the SYSTEM setting for a TV channel is incorrect, it may prevent the sound from being issued. Follow the description “EDIT/MANUAL” on page 34 to use the MANUAL function to try to change the SYSTEM setting.

■ Poor picture

- If noise totally obscures the picture (snow), the aerial or aerial cable may have trouble. Check the following to try to solve the trouble:
 - Has the TV and aerial been connected properly?
 - Has the aerial cable been damaged?
 - Is the aerial pointed to the right direction?
 - Is the aerial itself faulty?
- If the TV or aerial receives interference from the other devices, stripes or noise may appear in the picture. Move such devices as an amplifier, personal computer, or a hair drier that can cause interference away from your TV, or try changing its location. If the aerial suffers interference from a radio tower or high-voltage wire, please contact your local dealer.
- If the TV receives interference from signal reflecting from mountains or building, double-pictures (ghosting) will occur. Try to change the aerial’s direction or replace the antenna with the one with better directionality.
- Are your COLOUR SYSTEM settings for the TV channels correct? Follow the description “COLOUR SYSTEM” on page 27 to try to solve the trouble.
- Has COLOUR or BRIGHT been controlled properly? Follow the description “Picture Adjustment” on page 25 to try to adjust them properly.
- Videotaping teletext is not recommended because it may not record correctly.
- When viewing images from commercially available video software products, or videos from videotapes which have been recorded improperly, the top of the image may be distorted. This is due to the condition of the video signal, and not because of malfunction.





■ Poor sound

- Have you adjusted BASS or TREBLE properly? If not, follow the description “Sound Adjustment” on page 29 to try to adjust them properly.
- When the TV channel reception is poor, it can be hard to hear the stereo or bilingual sound. In this case, follow the description “STEREO / I • II” on page 29 to hear the sound more easily by changing it to a mono sound.

■ Operation disabled

- Have the batteries of the remote control become exhausted? Follow the description “Putting the batteries into the Remote control” on page 7 and replace them with new batteries to try to solve the problem.
- Have you attempted to use the remote control at the sides or rear of the TV or at a location more than seven meters apart from the TV location? Operate the remote control in the front of your TV or a location less than seven meters from your TV to try to solve the problem.
- When you are viewing a teletext programme, you cannot operate the menus. Press the **TV** button to return the teletext programme to the ordinary TV programme to try operating the menus.
- If the TV suddenly stops responding, disconnect the power cords of the TV and receiver from the AC outlets. Connect them to the AC outlets again to turn on the TV. If the TV returns to a normal state, it is not a failure.

■ Other concerns

- When the SLEEP TIMER function operates, the TV is automatically turned off. If the TV is turned off suddenly, try to press the  (Standby) button to turn on the TV once again. At this time, if the TV resumes a normal state, there is no problem.
- When a WSS signal is included in the broadcast signal or the signal from an external device, the ZOOM mode will change automatically. When you want to return to the previous ZOOM mode, press the **ZOOM** button to choose the ZOOM mode again.
- It takes a short period of time from the time an operation such as changing channels is performed until an image is displayed. This is not a malfunction. This is the time required for the image to stabilize before it can be displayed.
- The TV may emit a crackling sound due to a sudden change in temperature. It does not matter if a picture or sound does not show any abnormality. If you hear crackling sounds frequently while you are viewing the TV, other causes may be assumed. For precautionary purposes, request your service technician to inspect it.
- In the twin pictures mode the sub-picture may disappear when the external device is operated. If this happens, press the **PIP** button and display the sub-picture again.
- The headphone volume is adjusted with the "HEADPHONE" menu. It cannot be adjusted with the   buttons or  (volume)  buttons.
- When TV SPEAKER in the "HEADPHONE" menu is ON, even if the headphones are connected, sound is emitted from the TV speaker. When you do not want to emit sound from the TV speaker, turn the setting OFF.

Specifications

Item	Model	PD-42DX	PD-35DX
Broadcasting systems		B, G, I, D, K, K1	
Colour systems		PAL, SECAM • The EXT terminals also support the NTSC 3.58/4.43 MHz system.	
Channels and frequencies		VHF low channel (VL) =46.25 to 168.25 MHz VHF high channel (VH) =175.25 to 463.25 MHz UHF channel (U) =471.25 to 855.25 MHz • Receives cable channels in mid band (X to Z+2, S1 to S10), super band (S11 to S20) and hyper band (S21 to S41).	
Sound-multiplex systems		A2 (B/G, D/K), NICAM (B/G, I, D/K) system	
Teletext systems		FLOF (Fastext), TOP, WST (World Standard System)	
Languages displayed by teletext		Please see the table in the description "Changing the TELETEXT LANGUAGE setting" on page 37.	
Power requirements		AC 110 to 240 V, 50/60 Hz	
Power consumption		TV: Average: 338 W, Standby: 0.5 W	TV: Average: 243 W, Standby: 0.5 W
		Receiver: Average: 35 W, Standby: 2.4 W	
Screen size		Viewable area 105.7 cm (measured diagonally)	Viewable area 90.2 cm (measured diagonally)
Audio output		Rated Power output: 10 W + 10 W + 15 W (Woofer)	
Speakers		DD speaker ((9.5 cm × 1 cm) oval × 1) × 2 Subwoofer (16 cm round woofer × 1) × 1	
VIDEO-1 terminal		RCA connectors × 3 • Video input and Audio L/R inputs are available.	
VIDEO-2 terminal		RCA connectors × 3, S-VIDEO connector × 1 • Video input, S-VIDEO (Y/C) input, Audio L/R inputs are available.	
VIDEO-3 terminal		RCA connectors × 3, S-VIDEO connector × 1 • Video input, S-VIDEO (Y/C) input, Audio L/R inputs are available.	
VIDEO-4 terminal		RCA connectors × 5 • Component video (Pr, Pb, Y) inputs and Audio L/R inputs are available. • progressive-scanning signals (625p or 525p) are available.	
VIDEO-5 terminal		RCA connectors × 3, S-VIDEO connector × 1 • Video input, S-VIDEO (Y/C) input and Audio L/R inputs are available.	
OUT terminal		RCA connectors × 3 • Video output and Audio L/R outputs are available.	
AUDIO OUT terminal		RCA connectors × 2 • Audio L/R outputs are available.	
Headphone jack		Stereo mini-jack (3.5 mm in diameter)	
Dimensions (W × H × D)		TV: 1035 mm × 640 mm × 98 mm 1123 mm × 640 mm × 98 mm (When mounting the DD speakers)	TV: 887 mm × 545 mm × 99 mm 975 mm × 545 mm × 103 mm (When mounting the DD speakers)
		DD speaker: 42 mm × 639 mm × 54 mm	DD speaker: 42 mm × 545 mm × 54 mm
		Receiver: 435 mm × 99 mm × 382 mm	
		Subwoofer: 435 mm × 230 mm × 126 mm	
Weight		TV: 33.0 kg 35.5 kg (When mounting the DD speakers)	TV: 27.2 kg 29.3 kg (When mounting the DD speakers)
		DD speaker: 0.8 kg (Except for mounting fixture)	DD speaker: 0.7 kg (Except for mounting fixture)
		Receiver: 5.3 kg	
		Subwoofer: 3.7 kg	
Accessories		Refer to "Checking contents of packages" on page 5.	

Design and specifications subject to change without notice.

Pictures displayed on the screen using this TV's ZOOM functions should not be shown for any commercial or demonstration purpose in public places (cafes, hotels, etc.) without the consent of the owners of copyright of the original picture sources, as this constitutes an infringement of copyright.





Free Manuals Download Website

<http://myh66.com>

<http://usermanuals.us>

<http://www.somanuals.com>

<http://www.4manuals.cc>

<http://www.manual-lib.com>

<http://www.404manual.com>

<http://www.luxmanual.com>

<http://aubethermostatmanual.com>

Golf course search by state

<http://golfingnear.com>

Email search by domain

<http://emailbydomain.com>

Auto manuals search

<http://auto.somanuals.com>

TV manuals search

<http://tv.somanuals.com>