

# JVC

ENGLISH  
DEUTSCH  
FRANÇAIS  
NEDERLANDS  
CASTELLANO  
ITALIANO  
PORTUGUÊS

**D.I.S.T.**  
Digital Image Scaling Technology

InteriArt

**PD-42X50BU**  
**PD-42X50BJ**  
**PD-42X50BS**

**T-V LINK**

**PDP COLOUR TELEVISION**

**INSTRUCTIONS**

**PDP FARBFERNSEHGERÄT**

**BEDIENUNGSANLEITUNG**

**PDP TELEVISEUR COULEUR**

**MANUEL D'INSTRUCTIONS**

**PDP KLEURENTELEVISIE**

**GEBRUIKSAANWIJZING**

**PDP TELEVISOR A COLOR**

**MANUAL DE INSTRUCCIONES**

**PDP TELEVISORE A COLORI**

**ISTRUZIONI**

**PDP TELEVISOR A CORES**

**INSTRUÇÕES**

*plain English  
approved*

by the word centre

## ■ Warning

**DO NOT cut off the mains plug from this equipment.** If the plug fitted is not suitable for the power points in your home or the cable is too short to reach a power point, then obtain an appropriate safety approved extension lead or adaptor or consult your dealer.

If nonetheless the mains plug is cut off, remove the fuse and dispose of the plug immediately, to avoid a possible shock hazard by inadvertent connection to the mains supply.

If a new mains plug has to be fitted, then follow the instruction given below:

### Important

**Do not** make any connection to the larger terminal which is marked with the letter E or by the safety earth symbol  $\perp$  or coloured green or green-and-yellow.

The wires in the mains lead on this product are coloured in accordance with the following code:

Blue: Neutral

Brown: Live

As these colours may not correspond with the coloured marking identifying the terminals in your plug proceed as follows:

The wire which is coloured blue must be connected to the terminal which is marked with the letter N or coloured black.

The wire which is coloured brown must be connected to the terminal which is marked with the letter L or coloured red.

When replacing the fuse, use only a correctly rated approved type and always re-fit the fuse cover.

## ■ If in doubt — consult a competent electrician.

### How to replace the fuse

Open the fuse compartment with a blade screwdriver, and replace the fuse.

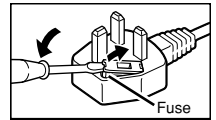

## ■ Guidelines for safe operation

This equipment has been designed and manufactured to comply with international safety standards. However, as with any electrical appliance, care must be taken to ensure optimal results and operational safety.

- Before attempting to use this equipment, read the operating instructions thoroughly.
- Ensure that all electrical connections (including the mains plug, extension leads, etc.) have been made in accordance with the manufacturer's instructions.
- If ever in doubt about the installation, operation or safety of this equipment, consult your dealer.
- Handle all glass panels or covers with care.
- Never operate this equipment if it appears damaged or operates abnormally. Turn the power off, disconnect the main power plug and consult your dealer.
- Never remove any affixed panels or covers. Doing so may result in electrical shock.
- Never leave this equipment operating unattended unless otherwise specifically stated that it is designed to do so or in standby mode. Only use the designated power switch to turn off the power and ensure that all potential users are instructed how to do so. Make special arrangements for infirm or handicapped persons.
- Never watch TV while operating a motor vehicle. It is illegal to watch TV while driving.
- Never listen to headphones at high volume. Doing so may damage your hearing.
- Never obstruct the ventilation of this equipment. Doing so may cause overheating and result in a malfunction or damage.
- Never use makeshift stands or attempt to affix legs with wood screws. When using a manufacturer's approved stand or legs, use only the fixtures provided and follow the installation instructions.
- Never allow this equipment to be exposed to rain or moisture.
- Never allow anyone, especially children, to insert anything into an opening in the case. Doing so may result in a fatal electrical shock.
- Never guess or take chances with electrical equipment of any kind. It is better to be safe than sorry.

Thank you for buying this JVC colour television.

To make sure you understand how to use your new TV, please read this manual thoroughly before you begin.

**WARNING: TO PREVENT FIRE OR SHOCK HAZARD, DO NOT EXPOSE THIS APPLIANCE TO RAIN OR MOISTURE.**

## WARNING

Always use the power cords which are supplied with the TV.

Some power cords are supplied with this TV. Use the power cord which best suits the area in which you live, and insert it into a correctly earthed outlet.

Failure to use the supplied power cord or to insert it into a correctly earthed outlet may result in electric shocks.

---

## CAUTION:

- Operate only from the power source specified (AC 110 – 240 V, 50 Hz) on the unit.
  - Avoid damaging the AC plug and power cord.
  - When you are not using this unit for a long period of time, it is recommended that you disconnect the power cord from the main outlet.
- 

### Distance recommendations

Avoid improper installation and never position the unit where good ventilation is impossible.

When installing this TV, distance recommendations must be maintained between the set and the wall, as well as inside a tightly enclosed area or piece of furniture.

Keep to the minimum distance guidelines shown for safe operation.

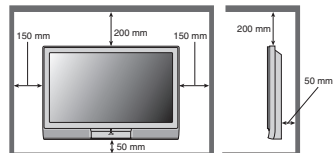

## Burn-in

A characteristic of Plasma Display Panels (PDPs) is that displaying the same image for a long time causes a part of the image to stay on the screen (this is called phosphor burn-in).

### Avoid burn-in as follows.

- Use the **PICTURE SHIFT** function. To prevent burn-in, the picture displayed on the screen is shifted up, down and to the left and right at regular intervals. See page 45 for details.
- Even if the PICTURE SHIFT function is turned off, the picture may shift to the left or right when the channel or input is changed.
- The **PICTURE MODE** function is initially set to **BRIGHT**. Unless the TV is being watched in an extremely bright room, we recommend you change the **PICTURE MODE** setting to either **STANDARD** or **SOFT**. Doing so will reduce the chance of burn-in and extend the life of the PDP. See “**PICTURE MODE**” on page 29.
- Do not display static images or characters for long periods of time.

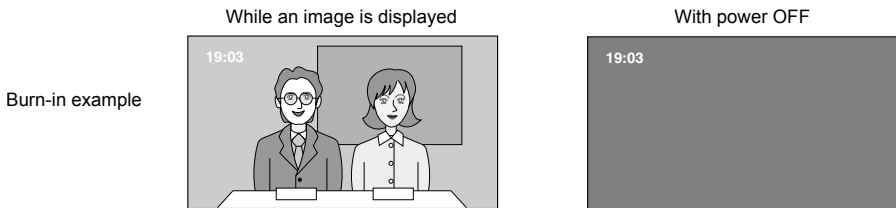

- Reduce **CONTRAST** and **BRIGHT** on the **PICTURE** menu (page 29) when viewing.
- Do not view for long periods of time in the **REGULAR** mode (page 18).  
Screen size is normally chosen to ensure that the picture is displayed on the entire screen. After viewing in the **REGULAR** mode in which black bands may occur at the left and right of the screen, it is recommended to change to the **PANORAMIC** mode to display the picture on the entire screen.

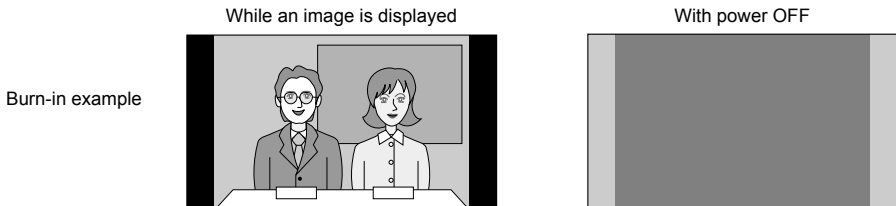

- Do not view for long periods of time using the **MULTI-PICTURE** function (page 20).

### If Burn-in has occurred

If burn-in occurs, try the **REFRESH** function (page 37). If burn-in is minimal it may gradually become less noticeable.

**Note:** Once burn-in occurs it will never disappear completely.

**Pixel defects**

PDPs use collections of fine dots (“pixels”) to display images. While there is no problem with more than 99.99% of these pixels, please understand that a very small number of pixels may not light, or may light all the time.

**Do not install the TV near electronic equipment that is susceptible to electromagnetic waves**

It may cause interference in images, sound, etc. In particular, keep video equipment away from this product.

**Effect on infrared devices**

There may be interference while using infrared devices such as infrared cordless headphones.

**Failure to take the following precautions may result in damage to the TV or remote control.****DO NOT block the TV’s ventilation openings or holes.**

(If the ventilation openings or holes are blocked by a newspaper or cloth, etc., the heat may not be able to get out.)

**DO NOT place anything on top of the TV.**

(such as cosmetics or medicines, flower vases, cups, etc.)

**DO NOT allow objects or liquid into the cabinet openings.**

(If water or liquid is allowed to enter this equipment, fire or electric shock may be caused.)

**DO NOT place any naked flame sources, such as lighted candles, on the TV.**

The surface of the TV screen is easily damaged. Be very careful with it when handling the TV. Should the TV screen become soiled, wipe it with a soft dry cloth. Never rub it hard. Never use any cleaner or detergent on it.

In the event of a fault, unplug the unit and call a service technician. Do not attempt to repair it yourself or remove the rear cover.

**PICTURE MANAGEMENT demonstration**

To start the PICTURE MANAGEMENT demonstration:

Press the **MENU** button to display the menu bar. Then press the yellow button.

A picture split in two (PICTURE MANAGEMENT turned on and PICTURE MANAGEMENT turned off) will appear on the screen.

To quit the PICTURE MANAGEMENT demonstration:

Press the yellow button, **TV** button, **P**  $\vee/\wedge$  buttons or any of the number buttons.

# CONTENTS

<b>Checking the contents of packages</b> .....	<b>5</b>	<b>PICTURE menu</b> .....	<b>29</b>
<b>Setting up your TV</b> .....	<b>6</b>	PICTURE MODE.....	29
Installation.....	6	CONTRAST .....	29
Connecting the aerial and video cassette recorder (VCR).....	7	BRIGHT.....	29
Connecting the power cord to the AC outlet.....	8	SHARP.....	29
Putting the batteries into the remote control.....	8	COLOUR.....	29
Initial settings .....	9	HUE.....	29
T-V LINK functions .....	12	COLOUR TEMP.....	29
<b>TV buttons and functions</b> .....	<b>14</b>	FEATURES .....	30
Turn the TV on from standby mode .....	14	<b>SOUND menu</b> .....	<b>33</b>
Choose a TV channel .....	14	STEREO / I • II .....	33
Adjust the volume .....	14	BASS.....	33
Using the Menu.....	14	TREBLE .....	33
<b>Remote control buttons and functions</b> .....	<b>15</b>	BALANCE .....	33
Turn the TV on or off from standby mode ...	15	3D SOUND.....	33
Choose a TV channel and watch images from external devices .....	16	A.H.B. (Active Hyper Bass).....	33
Adjust the volume .....	17	BBE.....	34
Information function .....	17	SPEAKER .....	34
ZOOM function.....	18	<b>FEATURES menu</b> .....	<b>35</b>
3D SOUND function.....	19	SLEEP TIMER .....	35
Return to TV channel instantly.....	19	CHILD LOCK.....	35
Using the FREEZE function.....	19	APPEARANCE.....	36
Using the MULTI-PICTURE function .....	20	BLUE BACK.....	36
Favourite channel function.....	22	REFRESH.....	37
Operating a JVC brand VCR or DVD player.....	23	FAVOURITE SETTING .....	37
<b>Teletext function</b> .....	<b>24</b>	<b>SET UP menu</b> .....	<b>38</b>
Basic operation .....	24	AUTO PROGRAM.....	38
Using the List Mode .....	24	EDIT/MANUAL .....	38
Hold.....	25	LANGUAGE .....	42
Sub-page .....	25	DECODER (EXT-2).....	42
Reveal.....	25	EXT SETTING.....	43
Size.....	25	PICTURE SHIFT .....	45
Index.....	26	HDMI SETTING .....	45
Cancel.....	26	<b>Displaying a computer screen</b> .....	<b>46</b>
<b>Using the TV's menu</b> .....	<b>27</b>	Connecting to the computer .....	46
Basic operation .....	27	Looking at images from a computer.....	46
		Table of signals for each type of computer.....	46
		<b>Additional preparation</b> .....	<b>47</b>
		Connecting external equipment .....	47
		Using the HDMI terminal .....	50
		<b>CH/CC numbers</b> .....	<b>52</b>
		<b>Troubleshooting</b> .....	<b>54</b>
		<b>Specifications</b> .....	<b>56</b>

# Checking the contents of packages

Check that all components are present. Contact your retailer immediately if any components are missing.

<b>Model</b>	<b>PD-42X50BU</b>	<b>PD-42X50BJ/PD-42X50BS</b>
TV and Table top stand	0	1
TV and Wall mounting unit	1	0
Remote control unit	1 (RM-C1811H)	
AA/R6 batteries	2 (used to check operation)	
Ferrite core	1 (attach to power cord)	
Power cord	Use the power cord which best suits your area.	

# Setting up your TV

---

- **Be sure to have someone help you when you lift up the TV. The TV is too heavy to lift up by yourself. If the TV falls, it will cause injuries and damage.**
- 

## Installation

---

- **Only use JVC approved accessories with your model.**

### **Warning for wall mounting unit:**

- Use only authorized service personnel to install your TV in order to prevent accidents. Do not try to install your TV by yourself.
- We sell this product on the understanding that it will be assembled and installed by qualified service personnel.
- Please read the instruction manual for the wall mounting unit before starting installation in order to prevent accidents.
- We are not liable for any damage caused by faulty assembly, faulty wall mounting, insecure wall mounting, misuse, alterations, or natural disasters.

### **Cautions for installation**

- Do not tilt the TV towards the left or right, or towards the back.
- Install the TV in a corner on a wall or on the floor so as to keep cords out of the way.
- The TV will generate a slight amount of heat during operation. Ensure that sufficient space is available around the TV to allow satisfactory cooling. See “Distance recommendations” on page 1.



**Caution**

- Turn off all the equipment including the TV before connecting anything.

**Connecting the aerial and video cassette recorder (VCR)**

- The connecting cables are not provided.
- For further details, refer to the manuals provided with the devices to be connected.

■ **If you are connecting a VCR, follow ① → ② → ③ in the diagram opposite.**

■ **If you are not connecting a VCR, follow ①.**

To use the T-V LINK functions, you must have a T-V LINK compatible VCR connected by a SCART cable ③ to the EXT-2 terminal on the TV. For details about T-V LINK functions, see “T-V LINK functions” on page 12.

- You can watch a video using the VCR without doing ③. For details, see your VCR instruction manual.
- To connect more equipment, please see “Connecting external equipment” on page 47.
- To connect additional audio equipment, see “Connecting speakers/amplifier” on page 48.
- If you connect a decoder to a T-V LINK compatible VCR, set the DECODER (EXT-2) function to ON. For details, see “DECODER (EXT-2)” on page 42. Otherwise, you will not be able to watch scrambled channels.

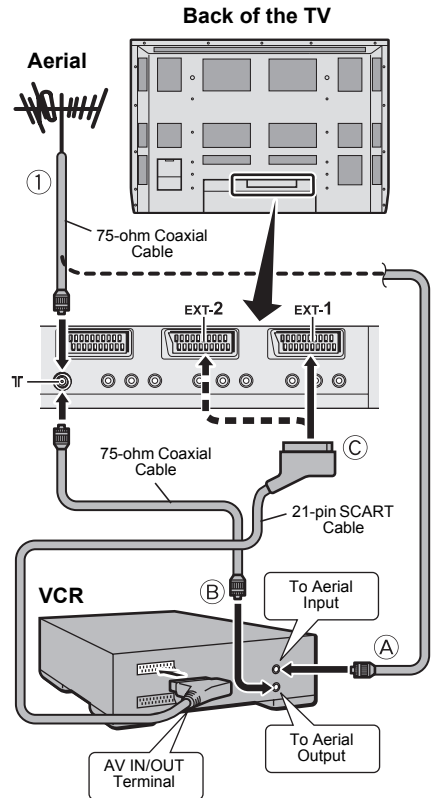

## ■ Rear Panel

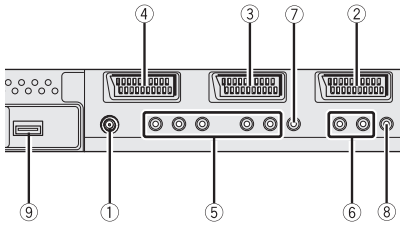

- ① Aerial socket (page 7)
- ② EXT-1 terminal (pages 7, 43, 47)
- ③ EXT-2 terminal (pages 7, 12, 43, 47)
- ④ EXT-3 terminal (pages 43, 47)
- ⑤ EXT-4 terminal (pages 43, 47)
- ⑥ AUDIO OUT terminal (page 48)
- ⑦ CENTRE CH input terminal (page 49)
- ⑧ Subwoofer out terminal (page 48)
- ⑨ HDMI terminal (page 50)

## Connecting the power cord to the AC outlet

### Attaching the ferrite cores

Using the power cord without ferrite core may lead to noise (interference). Attach the ferrite core to the AC plug end of the power cord for the TV.

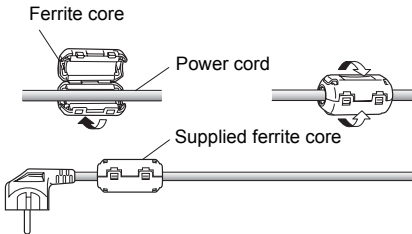

Insert the AC plug on the power cord from the TV into AC outlet.

### Caution

- Operate only from the power source specified (AC 110 – 240 V, 50 Hz) on the unit.
- Failure to use the supplied power cord or to insert it into a correctly earthed outlet may result in electric shocks.

### Back of the TV

Use the supplied power cord which best suits the area in which you live.

Insert the AC plug into a correctly earthed outlet.

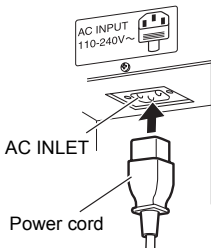

## Putting the batteries into the remote control

Use two AA/R6 dry cell batteries.

Insert the batteries from the  $\ominus$  end, making sure the  $\oplus$  and  $\ominus$  polarities are correct.

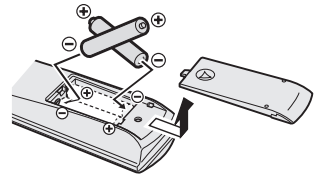

- Follow the warnings printed on the batteries.
- Battery life is about six months to one year, depending on how much you use the remote control.
- The batteries we supply are only for setting up and testing your TV, please replace them as soon as you need to.
- If the remote control does not work properly, replace the batteries.

## Initial settings

When the TV is first turned on, it goes into the initial settings mode, and you will see the JVC logo. Follow the instructions on the screen display to make the initial settings.

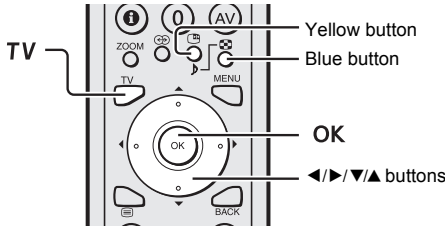

### 1 Press the button on the TV

The power lamp lights blue and the JVC logo appears.

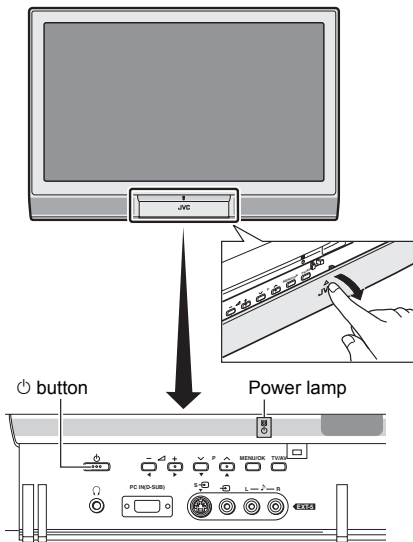

- If the JVC logo does not appear this is because your TV has already been turned on for the first time: use the “LANGUAGE” and “AUTO PROGRAM” functions to make the initial settings. For details, see “SET UP menu” on page 38.

### 2 Press the OK button

The LANGUAGE menu appears.

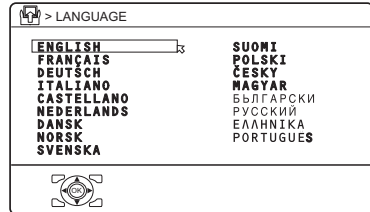

### 3 Press the ▼/▲ buttons to choose ENGLISH. Then press the OK button

The on-screen display will then be in English.

The COUNTRY menu appears as a sub-menu of the AUTO PROGRAM function. There are two COUNTRY menus. Pressing the yellow button changes the COUNTRY menu as follows:

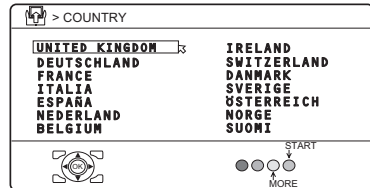

### 4 Press the ◀/▶ and ▼/▲ buttons to choose the country where you are

#### • For users in the UK

To receive SKY 1 you need a satellite tuner. You must have the satellite tuner set to SKY 1 before starting the AUTO PROGRAM function which follows.

**5 Press the blue button to start the AUTO PROGRAM function**

The AUTO PROGRAM menu appears and received TV channels are automatically stored in the programme numbers (PR).

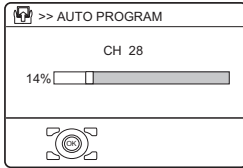

D0004-EN

- Perform the “ACI function” operation (see page 11) when “ACI START/ACI SKIP” is displayed.
- To cancel the AUTO PROGRAM function:  
Press the **TV** button.



**After the TV channels have been registered in the programme numbers (PR), the EDIT menu appears**

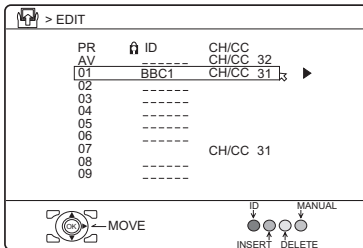

D0038-EN

- If you want to, you can now edit the programme numbers (PR) using the EDIT/MANUAL function. For details, see “EDIT/MANUAL” on page 38.
- If you do not want to edit programme numbers (PR), go to the next step.

**6 Press the OK button to display the T-V LINK menu**

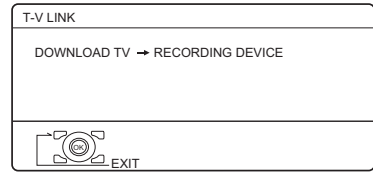

D0005-EN

**If you do not have a T-V LINK compatible VCR connected:**

Press the **TV** button to exit the T-V LINK menu.

The T-V LINK menu disappears.

**If you have a T-V LINK compatible VCR connected to the EXT-2 terminal:**

Follow the operating procedure “Downloading the data to VCR” on page 11 to transmit the Programme number (PR) data.

**Now, the initial settings are complete, and you can watch the TV**

- **When the COUNTRY setting is UNITED KINGDOM:**  
BBC1, BBC2, ITV, Channel 4 and Channel 5 are automatically set to the programme numbers PR1 to PR5. If the TV doesn’t receive one of these TV channels, that programme number (PR) will not be set. Programme number PR6 is not normally set.
- **When the COUNTRY setting is not UNITED KINGDOM:**  
If your TV can detect the TV channel name from the TV channel broadcast signal, the TV channel name is assigned to the programme number (PR) to which the TV channel has been set. However, which TV channels are set to which programme numbers (PR) will depend on the area in which you live.
- If a TV channel you want to view is not set to a programme number (PR), you can set it using the MANUAL function. For details, see “EDIT/MANUAL” on page 38.

- The AUTO PROGRAM function does not set the programme number PR 0 (AV) for your video cassette recorder. You will need to set this using the MANUAL function.
- In some areas you may get TV reception from more than one transmitter, for example different ITV regions. In this case each TV channel could be set twice. If this happens, the first set of channels will have the stronger signal. If you want to delete the second set of channels, you will have to do it manually (see page 38).

**For users in the UK:**

If you have any problems setting up your new TV, please call the **JVC** Helpline on **0870 330 5000**.

**For users in the Republic of Ireland:**

If you have any problems setting up your new TV, please call the **JVC** Helpline on **1890-582500**.

## ■ ACI function

This TV has an ACI function which decodes the ACI (Automatic Channel Installation) data.

Using the ACI function allows all TV channels transmitted from the cable TV station to be properly registered quickly according to the data from the cable TV station.

### If “ACI START/ACI SKIP” appears in the AUTO PROGRAM menu:

You can use the ACI (Automatic Channel Installation) function to decode the ACI data and complete the registration of all the TV channels in a short period of time.

### Press the ▼/▲ buttons to choose ACI START. Then press the OK button to start the ACI function

Depending on your cable TV station, there may be a broadcast selection menu set up by the cable TV station.

Follow the menu instructions and use the ◀/▶ and ▼/▲ buttons to operate the menu. After you have made the setting, press the **OK** button.

- If you have any questions about the items in the Broadcast Selection menu or how to operate the menu, please contact your cable TV station.
- If you don't want to use the ACI function, press the ▼/▲ buttons to choose ACI SKIP and then press **OK**.
- When the cable TV broadcast reception is poor, the ACI function will not work properly.
- If there is an error in the ACI data itself, the TV channel cannot be registered properly. If this happens, turn the ACI function off (ACI SKIP) and use the AUTO PROGRAM function. Alternatively, use the EDIT/MANUAL function to correct the Programme number (PR) setting.

### If “ACI ERROR” is displayed in the AUTO PROGRAM menu:

“ACI ERROR” means that the ACI function is not working properly. Press the ◀ button to start the ACI function again.

If “ACI ERROR” still appears even after you have tried to start the ACI function several times, press the ▶ button to start the AUTO PROGRAM function. It does not cause any problem because all the TV channels are registered to the Programme numbers (PR) by the AUTO PROGRAM function.

## ■ Downloading the data to VCR

You can transmit to the latest Programme numbers (PR) data to a VCR with the T-V LINK function.

### Caution

- This only works when a T-V LINK compatible VCR is connected to the EXT-2 terminal.
- This only works when the T-V LINK menu is being displayed.

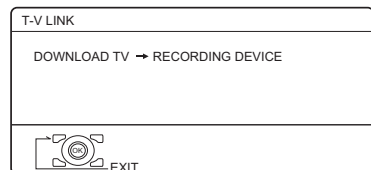

D0005-EN

## 1 Turn on the VCR

### 2 Press the OK button

The data transmission begins.

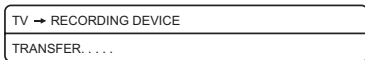

The T-V LINK menu disappears once the data transmission ends.

#### When the T-V LINK menu is changed over to another menu:

The TV has finished its menu. This new menu is operated from the VCR. See the VCR instruction manual for what to do next.

#### If "FEATURE NOT AVAILABLE" appears at the T-V LINK menu:

Check the following three items. Then press the ◀ button to retry data transmission.

- Has a T-V LINK compatible VCR been connected to the EXT-2 terminal?
- Has the VCR power been turned on?
- Does the SCART cable that is connected to the EXT-2 terminal to T-V LINK compatible VCR have all its proper connections?

## T-V LINK functions

When you have a T-V LINK compatible VCR connected to the EXT-2 Terminal on the TV, it is easier to set up the VCR and to view videos. T-V LINK uses the following features:

#### To use T-V LINK functions:

A "T-V LINK compatible VCR" means a JVC video cassette recorder with the T-V LINK logo, or with one of the following logos. However, these VCRs may support some or all of the features described earlier. For details, see your VCR instruction manual.

"Q-LINK" (a trademark of Panasonic Corporation)

"Data Logic" (a trademark of Metz Corporation)

"Easy Link" (a trademark of Phillips Corporation)

"Megalogic" (a trademark of Grundig Corporation)

"SMARTLINK" (a trademark of Sony Corporation).

#### ■ Pre-set download

The VCR will automatically download the registered data on the TV channels from the TV. This means you do not need to set up the program channels on your VCR manually. The preset download function automatically begins when the initial setting is complete or whenever you carry out the AUTO PROGRAM or EDIT/MANUAL functions. You can also carry out this function using your VCR controls.

#### When "FEATURE NOT AVAILABLE" is displayed:

If "FEATURE NOT AVAILABLE" is displayed, the download was not performed correctly. Before trying to download again, check that:

- the VCR power is turned on
- the VCR is T-V LINK compatible
- the VCR is connected to the EXT-2 terminal
- the SCART cable is fully wired.

## ■ Direct Rec

“What You See Is What You Record”

You can easily record to VCR the images that you are watching on the TV.

For details, read the manual for your VCR.

Use your VCR controls. “VCR IS RECORDING” is displayed.

**In the following situations, the VCR will stop recording if the TV is turned off, if the TV channel or input is changed, or if the menu is displayed on the TV:**

- when recording images from an external device connected to the TV (for example a camcorder)
- when recording a TV channel after it has been unscrambled on a decoder
- when recording a TV channel by using the TV’s output because the VCR’s own tuner cannot properly receive that channel.

When the VCR is not ready (for example when there is no tape inserted), “NO RECORDING” is displayed.

You cannot carry out Direct Rec using your TV’s control.

Generally, the VCR cannot record a TV channel that it cannot receive properly on its own tuner, even if you can view that TV channel on the TV. However, some VCRs can record a TV channel by using the TV’s output if that channel can be viewed on the TV. For details, see your VCR instruction manual.

# TV buttons and functions

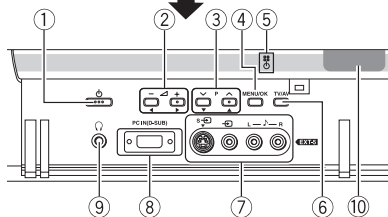
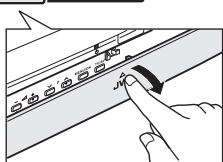

See the pages in brackets for details.

- ① (power) button
- ② (Volume)  $-/+$  buttons
- ③ P  $\vee/\wedge$  buttons
- ④ MENU/OK button (page 27)
- ⑤ Power lamp (page 9)
- ⑥ TV/AV button (page 27)
- ⑦ EXT-5 terminal (pages 43, 47)
- ⑧ PC IN (D-SUB) terminal (page 46)
- ⑨ Headphone jack (mini jack) (page 47)
- ⑩ Remote control sensor

---

## Turn the TV on from standby mode

---

Press the button or the P  $\vee/\wedge$  buttons to turn the TV on from standby mode.

When the TV is turned on, the power lamp lights blue.

**To turn the TV off:**

Press the button again.

The power lamp goes off.

### Caution

- The button on the TV does not fully isolate the TV from the AC supply. If you are not going to use the TV for a long period, be sure to disconnect the AC plug from the AC socket.

---

## Choose a TV channel

---

Press the P  $\vee/\wedge$  buttons to choose a programme number (PR) or an EXT terminal

Press the TV/AV button to change between TV and external input.

---

## Adjust the volume

---

Press the (Volume)  $-/+$  buttons

The volume level indicator appears.

---

## Using the Menu

---

Use the MENU/OK button

Refer to “Using the TV’s menu” (see page 27) for details of using the menu.



# Remote control buttons and functions

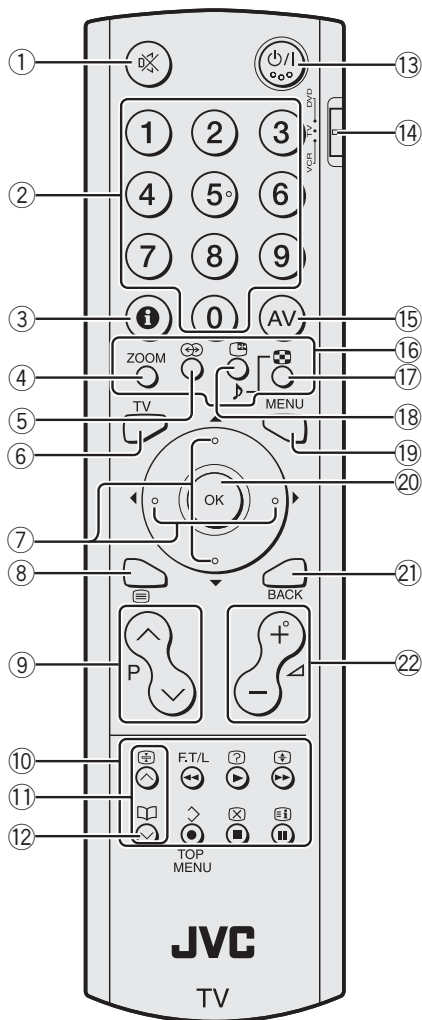

- 1 Muting button
- 2 Number buttons
- 3 Information button
- 4 **ZOOM** button
- 5 **TV** button
- 6 **TV** button
- 7 ◀/▶/▼/▲ buttons
- 8 (Text) button
- 9 **P** V/∧ buttons
- 10 VCR/DVD/Teletext control buttons
- 11 V/∧ buttons
- 12 (Favourite) button
- 13 ⏻/⏼ (Standby) button
- 14 VCR/TV/DVD switch
- 15 **AV** button
- 16 Colour buttons
- 17 (Multi) button
- 18 (Freeze/Select) button
- 19 **MENU** button
- 20 **OK** button
- 21 **BACK** button
- 22 ◀ (Volume) -/+ buttons

## Turn the TV on or off from standby mode

**Press the ⏻/⏼ (standby) button to turn the TV on or off**

When the TV is turned on, the power lamp lights blue.

- The power can be turned on by pressing the **TV** button, **P** V/∧ buttons or Number buttons.

To turn the TV on or off, set the VCR/TV/DVD switch on the remote control to the TV position and press the ⏻/⏼ button. If the VCR/TV/DVD switch on the remote control is set to a position other than TV, the TV will not be turned on or off even if the ⏻/⏼ button is pressed.

## Choose a TV channel and watch images from external devices

### ■ Use the number buttons: Enter the programme number (PR) of the channel using the number buttons.

Example:

- PR 6 → press **6**
- PR 12 → press **1** and **2**

### ■ Use the P $\nabla/\blacktriangle$ buttons: Press the P $\nabla/\blacktriangle$ buttons to choose the programme number (PR) you want or an EXT terminal.

### ■ Use the AV button: Press the AV button to choose an EXT terminal.

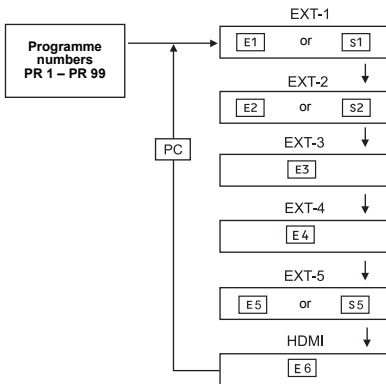

- You can choose a video input signal from the S-VIDEO signal (Y/C signal) and regular video signal (composite signal). For details, see “S-IN (S-VIDEO input)” on page 43.
- If you do not have a clear picture or no colour appears, change the colour system manually. See “COLOUR SYSTEM” on page 32.
- If you choose an EXT terminal with no input signal, the EXT terminal number becomes fixed on the screen.

- This TV set has a function which can automatically change over the input according to a special signal output from an external device. (The EXT-4, EXT-5 and EXT-6 (HDMI) terminals do not support this function.)
- Since this TV is designed to make full use of the resolution of the original video source, the motion may appear unnatural when the video source is input with 625p progressive-scanning component signals. If this happens, change the output setting of the connected device to 625i interlace-scanning component signal output. See the instructions that came with the device for more information.
- The PC sound is the same as the EXT-5 sound.

### To return to a TV channel:

Press the **TV** button, the  $\nabla/\blacktriangle$  buttons or the number buttons.

### To use the programme number PR 0 (AV):

When the TV and VCR are connected only by the aerial cable, choosing the programme number PR 0 (AV) allows you to view images from the VCR. Set the VCR RF channel to the programme number PR 0 (AV) manually. For details, see “EDIT/MANUAL” on page 38.

Pressing the **AV** button changes the choice as follows:

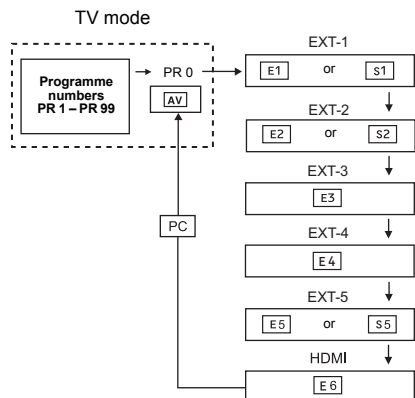

- The VCR sends its playback image along the aerial cable as an RF (radio frequency) signal.
- Also see your VCR instruction manual.

## Adjust the volume

Press the  **-/+** buttons to adjust the volume.

The volume indicator appears and the volume changes as you press the  **-/+** buttons.

### ■ Muting the sound

Press the  (muting) button to turn off the sound.

Pressing the  (muting) button again restores the previous volume level.

## Information function

You can see the channel number of the programme you are watching, the current time or the PR LIST.

From the PR LIST, you can choose a channel or EXT terminal.

Press the  (Information) button to display the information you want to see.

Pressing the  (Information) button changes the display as follows:

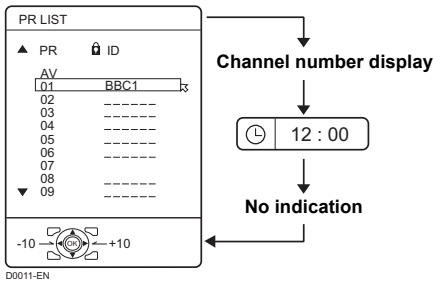

### Channel number display:

The channel number and channel name (when the channel name is registered) of the programme you are watching or the EXT terminal number is displayed.

### Time display:



The current time of the teletext data is displayed.

If the TV has not received a TV channel that has teletext programmes since it was turned on, the time display is blank. To view the current time, choose a TV channel that has teletext programmes.

- An incorrect current time is sometimes displayed when watching videos.

### PR LIST:

The programme number (PR) and EXT terminal list is displayed.

Pressing the **OK** button after choosing the programme number (PR) or EXT terminal with the    buttons will display the chosen programme or EXT terminal.

- For programme numbers (PR) for which the CHILD LOCK function is set, the  (CHILD LOCK) mark is displayed. For details see “CHILD LOCK” on page 35.

## ZOOM function

You can change the screen size according to the picture aspect ratio. Choose the optimum one from the following ZOOM modes.

- The ZOOM mode is fixed at FULL when you are using the TV as a PC screen.

### AUTO:

When a WSS (Wide Screen Signalling) signal, which shows the aspect ratio of the picture, is included in the broadcast signal or the signal from an external device, the TV automatically changes the ZOOM mode to 16:9 ZOOM mode or FULL mode according to the WSS signal.

If a WSS signal is not included, the picture is displayed according to the ZOOM mode set with the 4:3 AUTO ASPECT function.

- For details of the 4:3 AUTO ASPECT function, see “4:3 AUTO ASPECT” on page 32.
- When the AUTO (WSS) mode does not function correctly due to poor WSS signal quality or when you want to change the ZOOM mode, press the **ZOOM** button and change to another ZOOM mode.

### REGULAR:

Use to view a normal picture (4:3 aspect ratio) as this is its original shape.



### PANORAMIC:

This stretches the left and right sides of a normal picture (4:3 aspect ratio) to fill the screen, without making the picture appear unnatural.

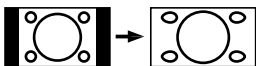

- The top and bottom of the picture are slightly cut off.

### 14:9 ZOOM:

This zooms up the wide picture (14:9 aspect ratio) to the upper and lower limits of the screen.



### 16:9 ZOOM:

This zooms up the wide picture (16:9 aspect ratio) to the full screen.

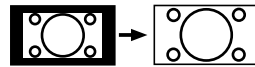

### 16:9 ZOOM SUBTITLE:

This zooms up the wide picture (16:9 aspect ratio) with subtitles to the full screen.



### FULL:

This uniformly stretches the left and right sides of a normal picture (4:3 aspect ratio) to fill the wide TV screen.

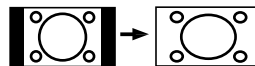

- For 16:9 aspect ratio pictures that have been squeezed into a normal picture (4:3 aspect ratio), use the FULL mode to restore the picture to its original shape.

## ■ Choose the ZOOM mode

### 1 Press the **ZOOM** button to display the ZOOM menu

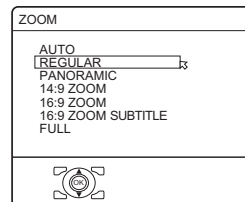

D0009-EN

### 2 Press the **▼/▲** buttons to choose a ZOOM mode. Then press the **OK** button

The picture expands and the chosen ZOOM mode is displayed in about 5 seconds.

- The ZOOM mode may be automatically changed by the control signal from an external device. When you want to return to the previous ZOOM mode, choose the ZOOM mode again.
- The ZOOM mode is fixed at FULL when watching a 1125i picture signal from the HDMI terminal.

## ■ Adjusting the visible area of the picture

If subtitles or the top (or bottom) of the picture are cut off, you can adjust the visible area of the picture manually.

### 1 Press the **ZOOM** button

The ZOOM menu appears.

### 2 Press the **OK** button to display the ZOOM mode indicator

The indicator appears.



### 3 While it is displayed, press the **▼/▲** buttons to change the position of the picture

- You cannot adjust the visible area in REGULAR or FULL mode.

## 3D SOUND function

You can enjoy sounds with a wider ambience.

- This function does not work for the sound from headphones.

### Press the **3D** button to select one of 3D SOUND modes

#### HIGH/LOW:

When you listen to stereo sound, please select HIGH or LOW mode.

You can enjoy sound similar to the experience at the theatre.

When you combine the functions of A.H.B. and BBE, you can enjoy more powerful sound.

- When you set the 3D SOUND function to HIGH mode, there may be slight volume distortion. If that occurs, please switch to LOW mode. The effect of 3D SOUND functions will be less noticeable, but the volume distortion will be corrected.

#### MONO:

Select the MONO mode, when you listen to the mono sound.

You can enjoy the sound for a wider audience similar to stereo sound.

#### OFF:

The 3D SOUND function switches off.

- You can choose the 3D SOUND mode with the "SOUND menu" (see page 33).

## Return to TV channel instantly

You can return to a TV channel instantly.

### Press the **TV** button

The TV returns to the TV mode and a TV channel appears.

## Using the FREEZE function

You can view the current programme as a still picture.

### 1 Press the **FREEZE** button

The still picture of the current picture will appear.



### To cancel the FREEZE function:

Press the **FREEZE** button, the **P**  $\nabla/\wedge$  buttons or the number buttons.

- The FREEZE function does not work while a sub-picture is displayed.
- The still picture cannot be output from the TV.
- The FREEZE function does not work for pictures from PC and HDMI signals.

## Using the MULTI-PICTURE function

### 1 Press the button

The MULTI-PICTURE menu appears.

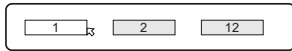

D0101-EN

### 2 Press the / buttons to choose the number of screens and then press the OK button



Choose to return to one screen.

D0102



Choose to change to 2-pictures multi.

D0103



Choose to change to 12-pictures multi.

D0104

### 2-pictures multi:

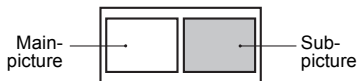

D0056

With 1125i and 750p signals, the screen is split into two as shown below.

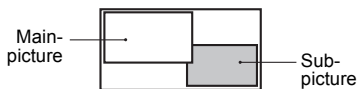





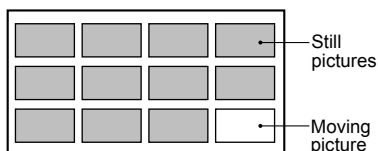

D1056

### 12-pictures multi:





D0058-EN

- When set to 2-pictures multi, you can view a TV picture and a picture from an external device. You cannot view a TV picture on more than one screen at the same time.
- When 12-pictures multi is set, pictures from external devices are not displayed.
- When set to 2-pictures multi, the main-picture can be changed by pressing the **P**   buttons. The sub-picture screen can be changed by pressing the /  buttons.  
When set to 12-pictures multi and there are more than 12 pictures, the next or previous 12 screens can be displayed by pressing the /  buttons.

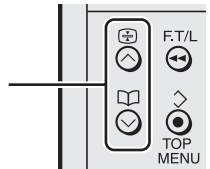
Changing the sub-picture  
Displaying the next or  
previous 12 screens



- When set to 2-pictures multi, the main-picture sound from the TV speaker can be changed to the sub-picture sound by pressing the  button. (The speaker mark moves from the main-picture to the sub-picture.)  
The sound changes to the main-picture sound if the  button is pressed again.  
When the headphones are connected, you can listen to the sound from the side at which the speaker mark is displayed. No sound comes from the TV speaker.

- A picture of EXT-4 cannot be displayed as the sub-picture.
- The MULTI-PICTURE function does not work for PC and HDMI signals.
- You cannot view a scrambled channel in the sub-picture.
- When set to 12-pictures multi, press the ◀/▶/▼/▲ buttons to choose the screen you want to view and the press the **OK** button to display that picture on the whole screen.
- The BLUE BACK function does not work when the MULTI-PICTURE function is being used.
- The ZOOM function does not work when the MULTI-PICTURE function is being used.

**To return the multi-picture to one screen:**

Press the  button, press the ◀/▶ buttons to choose one screen, and then press the **OK** button.

- Pressing the **TV** button will also return the display to one screen.

---

## Favourite channel function

---

You can register your favourite TV channels in the number buttons 1 to 4.

After registering, the channel can be called by pressing the  (favourite) button and a number button 1 to 4.

### ■ Favourite channel registration

#### 1 In the normal screen, choose a TV channel (PR 1 – PR 99) that you want to register

For details, refer to “Choose a TV channel and watch images from external devices” on page 16.

#### 2 Press and hold the (favourite) button for three seconds or more

Then “SET 1-4?” appears on the screen.

#### 3 Press one of the number buttons 1 to 4

The current channel is registered in the pressed number button.

After “PROGRAMMED!” appears on the screen, the favourite channel icon appears at the top-right of the screen.

- If the channel you are trying to register is already registered in one of the other number buttons 1 to 4, “NOT AVAILABLE” appears on the screen.
- Channels locked with the CHILD LOCK function cannot be registered.
- If AUTO PROGRAM is performed, the registered favourite channels are reset.

- 
- When you want to delete a favourite channel, delete the set channel and set contents with FAVOURITE SETTING (see page 37) in the FEATURES menu.
- 

### ■ Calling the favourite channel

#### 1 In the normal screen, press the (favourite) button

Then “FAVOURITE1-4?” appears.

#### 2 Press one of the number buttons 1 to 4

The called favourite channel appears on the screen.

- If a number button in which no channel is registered is pressed, “NO MEMORY” appears on the screen.

### ■ Setting the picture effect

When a favourite channel has been chosen, picture effect settings can be memorised for each favourite channel by setting the picture effects in the PICTURE menu (see page 29). The following items in the PICTURE menu (see page 29) are memorised.

PICTURE MODE  
CONTRAST  
BRIGHT  
SHARP  
COLOUR  
HUE  
COLOUR TEMP.  
DIGITAL VNR  
COLOUR SYSTEM

The last setting made for each item is memorised.



## ■ Showing the favourite channels

Press the ⓘ (information) button to display the PR LIST.

You can see the favourite channel that has the registered number button icon at the right of the channel number.

## Operating a JVC brand VCR or DVD player

These buttons will operate a JVC brand VCR or DVD player. Pressing a button that looks the same as the device's original remote control button has the same effect as the original remote control.

### 1 Set the VCR/TV/DVD Switch to the VCR or DVD position

#### VCR:

When you are operating the VCR, set the switch to the VCR position.

- You can turn the VCR on or off with the ⏻/⏪ (standby) button.

#### DVD:

When you are operating the DVD player, set the switch to the DVD position.

- You can turn the DVD player on or off with the ⏻/⏪ (standby) button.
- You can also press the **MENU** or **TOP MENU** button and display the DVD disc menu screen, and then operate by pressing the ◀/▶/▼/▲ buttons.

### 2 Press the VCR/DVD Control Button to control your VCR or DVD player

- If your device is not made by JVC, these buttons will not work.
- Even if your device is made by JVC, some of these buttons may not work, depending on the device you are using.
- You can use the √/∧ buttons to choose a TV channel the VCR will receive, or choose the chapter the DVD player plays back.
- Some models of DVD player use the √/∧ buttons for both operating the fast forward/backward functions and for choosing the chapter. In this case, the ◀◀/▶▶ buttons do not work.

You cannot turn the TV on or off when the VCR/TV/DVD switch is set to the VCR or DVD position.

When you turn the TV on or off, set the VCR/TV/DVD switch to the TV position.



- 2 Press a colour button to choose a position. Then press the number buttons to enter the page number**



- 3 Press and hold down the  $\diamond$  (Store) button**

The four page numbers blink white to show that they are stored in memory.

■ **To call up a stored page:**

- 1 Press the F.T/L button to enter the List mode**

- 2 Press a colour button having a stored page**

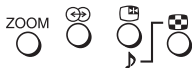

**To exit the List mode:**

Press the **F.T/L** button again.

## Hold

You can hold a teletext page on the screen for as long as you want, even while several other teletext pages are being received.

- Press the  $\square$  (Hold) button**

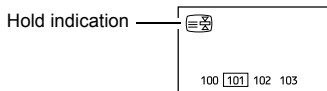

**To cancel the Hold function:**

Press  $\square$  (Hold) button again.

## Sub-page

Some teletext pages include sub-pages that are automatically displayed.

- 1 Choose a teletext page that includes sub-pages**

Sub-page numbers that can be viewed are automatically displayed at the top of the screen.

- 2 Press the  $\blacktriangleleft/\blacktriangleright$  buttons to choose a sub-page number**

## Reveal

Some teletext pages include hidden text (such as answers to a quiz).

You can display the hidden text.

- Each time you press the  $\square$  (Reveal) button, text is hidden or revealed**

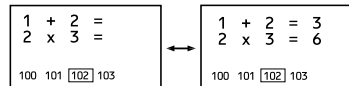

## Size

You can double the height of the teletext display.

- Press the  $\updownarrow$  (Size) button**

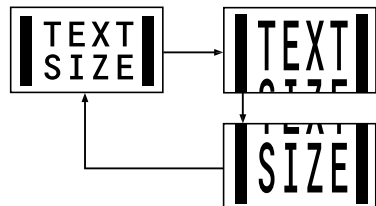

---

## Index

---

You can return to the index page instantly.

---

### **Press the (Index) button**

Returns to page 100 or a previously specified page.

---

---

## Cancel

---

You can search for a teletext page while watching TV.

---

### **1 Press the number button to enter a page number, or press a colour button**

The TV searches for a teletext page.

---

### **2 Press (Cancel) button**

The TV programme appears. When the TV finds the teletext page, its page number appears in the upper left of the screen.

---

### **3 Press (Cancel) button to return to a teletext page when the page number is on the screen**

- The TV mode cannot be resumed by pressing the  (Cancel) button. To return to the TV mode press **TV**.

# Using the TV's menu

This TV has a number of functions you can operate using menus. To use all your TV's functions, you need to understand the basic menu operating techniques fully.

## Buttons used to operate the menus

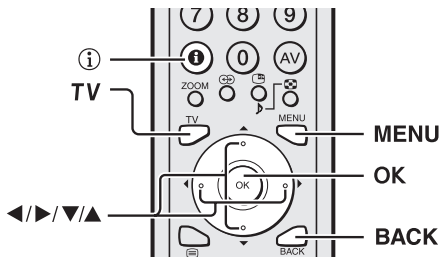

## Types of menu



**PICTURE menu**  
Choose to set the screen settings.



**SOUND menu**  
Choose to set the sound settings.



**FEATURES menu**  
Choose to set the sleep timer and child lock settings.



**SET UP menu**  
Choose to edit the channels or set the display language settings.

## Basic operation

- 1 Press the **MENU** button to display the menu bar

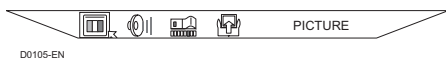

- 2 Press the **◀/▶** buttons to choose the menu you want to use and then press the **OK** button



- 3 Press the **▼/▲** buttons to choose the item to be set, press the **◀/▶** buttons to set the item, and then press the **OK** button

If there are sub-menus, use the **◀/▶/▼/▲** buttons to operate them.

- Press the **BACK** button to return to the previous menu.
- Press the **TV** or **MENU** button to exit from the menu.

The menu guide area can be made to appear and disappear for some menus. While the menu is displayed, press the **i** button to change between the guide area being displayed and not displayed.

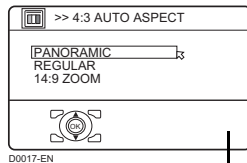

Guide area

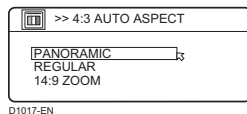

- The guide area for some menus will still be displayed even if the **i** button is pressed. This is not a fault.

### Operation with the buttons on the TV

You can also operate the menus using the buttons on the front panel of the TV.

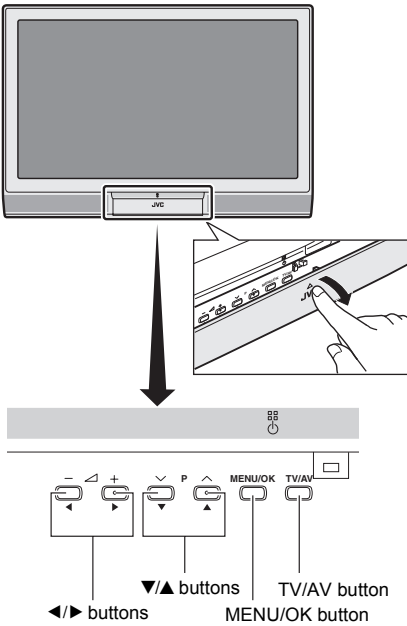

---

The menu will disappear after about one minute if no operation is performed.

---

# PICTURE menu

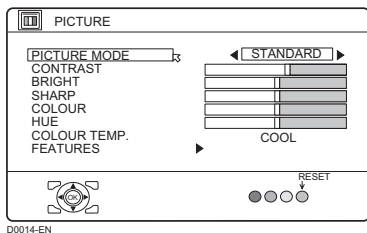

- While the PICTURE menu is displayed, pressing the blue button will set the CONTRAST, BRIGHT, SHARP, COLOUR, HUE settings to their default settings.
- When watching the picture from EXT-1 to EXT-6 (HDMI) or the PC, picture effect settings can be memorised for each external input by setting the picture effects in the PICTURE menu.

The following items in the PICTURE menu are memorised.

PICTURE MODE  
CONTRAST  
BRIGHT  
SHARP  
COLOUR  
HUE  
COLOUR TEMP.  
DIGITAL VNR  
COLOUR SYSTEM

The last setting made for each item is memorised.

## PICTURE MODE

You can choose one of three PICTURE MODEs to adjust the picture settings automatically.

### **BRIGHT:**

Heightens contrast and sharpness.

### **STANDARD:**

Standardizes picture adjustment.

### **SOFT:**

Softens contrast and sharpness.

## CONTRAST

You can adjust the picture contrast.

- ◀ : lower
- ▶ : higher

## BRIGHT

You can adjust the picture brightness.

- ◀ : darker
- ▶ : brighter

## SHARP

You can adjust the picture sharpness.

- ◀ : softer
- ▶ : sharper

## COLOUR

You can adjust the picture colour.

- ◀ : lighter
- ▶ : deeper

## HUE

You can adjust the picture tint.

- ◀ : reddish
- ▶ : greenish
- You can change the HUE setting (picture hue) when the colour system is NTSC 3.58, or NTSC 4.43.

## COLOUR TEMP.

You can select one of three COLOUR TEMP. modes (three tones of white) to adjust the white balance of the picture. Since white is the colour which is used as a reference for all the other colours, changing the COLOUR TEMP. mode affects the appearance of all the other colours on the screen.

### **COOL:**

A bluish white. Using this mode when watching bright pictures allows you to enjoy a more vivid and bright picture.

### **NORMAL:**

The normal white colour.

### WARM:

A reddish white. Using this mode when watching films allows you to enjoy colours that are characteristic of films.

## FEATURES

Choose FEATURES and press the **OK** or ► button to display the sub-menu.

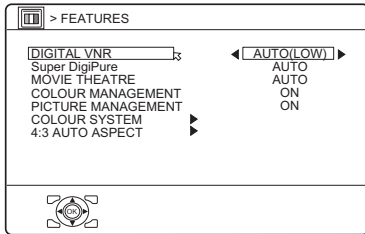

### ■ DIGITAL VNR

The DIGITAL VNR function cuts down the amount of 'noise' ('snow' or interference) in the original picture.

You can choose from the three DIGITAL VNR function settings of AUTO, MIN and MAX.

#### **AUTO(LOW)/AUTO(HIGH):**

The TV will automatically adjust the level of the DIGITAL VNR effect to match the amount of noise in the picture, giving you the best possible picture.

- If you set the DIGITAL VNR effect too high it can make the picture less sharp. It is recommended you use the AUTO(LOW) setting if you can. If you set the DIGITAL VNR function to AUTO(LOW) but still notice some noise, change the setting from AUTO(LOW) to AUTO(HIGH).

#### **MIN:**

The level of the DIGITAL VNR effect is set to the minimum. If you set the DIGITAL VNR function to AUTO(LOW) but feel that the sharpness of the original picture has not been reproduced fully, change the setting from AUTO(LOW) to MIN.

- The MIN setting is not suitable for low-quality pictures which contain a lot of noise.

#### **MAX:**

The level of the DIGITAL VNR effect is set to the maximum. If you set the DIGITAL VNR function to AUTO(HIGH) but still notice some noise, change the setting from AUTO(HIGH) to MAX.

- The MAX setting is not suitable for high-quality pictures which contain very little noise.

### ■ Super DigiPure

The Super DigiPure function uses the latest in digital technology to give you a natural-looking picture. The Super DigiPure function includes the following two functions.

#### **DigiPure function:**

This function helps to create a natural-looking picture by eliminating unnecessary edges from high-contrast and crisp images. For images with low-contrast, edges are added to produce a sharper, more detailed picture.

You can choose from the three DigiPure function settings of AUTO, MIN and MAX.

- If you set the DigiPure effect too high on a low-quality picture that contains a lot of noise, this may actually make the noise worse. We recommend you use the AUTO setting if you can.

#### **Picture motion compensation function:**

This function displays fast-moving pictures (for example, the players or ball in a football game) more smoothly and naturally on the screen.

- The effect level of the picture motion compensation function cannot be changed. The effect level is the same no matter which of the AUTO, MIN or MAX settings is used.

#### **AUTO:**

The TV will automatically adjust the level of the DigiPure effect to match the amount of noise in the picture, giving the best possible picture.



**MIN:**

The level of DigiPure effect is set to the minimum. When you set the Super DigiPure function to AUTO and notice some noise, change the setting from AUTO to MIN.

- The MIN setting is not suitable for high-quality pictures which contain very little noise.

**MAX:**

The level of DigiPure effect is set to the maximum. If you set the Super DigiPure function to AUTO but feel that the original picture quality has not been reproduced fully, change the setting from AUTO to MAX.

- The MAX setting is not suitable for low-quality pictures which contain a lot of noise.

**OFF:**

The Super DigiPure function is turned off.

**■ MOVIE THEATRE**

The MOVIE THEATRE function displays a cinema film picture more smoothly and naturally on the screen.

**AUTO:**

The television automatically recognizes the type of signal and turns the function on and off.

**ON:**

This function is turned on.

**OFF:**

This function is turned off.

- The motion may appear unnatural when viewing images with the NTSC colour system. When the MOVIE THEATRE function is set to AUTO or ON, the motion may appear unnatural when viewing images with the NTSC colour system.

**■ COLOUR MANAGEMENT**

This TV supports the COLOUR MANAGEMENT function to ensure dull colours are compensated to produce natural hues.

The COLOUR MANAGEMENT function is on by default.

**ON:**

COLOUR MANAGEMENT function is turned on.

**OFF:**

COLOUR MANAGEMENT function is turned off.

- 
- Set this function to ON under normal conditions.
- 

**■ PICTURE MANAGEMENT**

The PICTURE MANAGEMENT function makes it easier to see the dark areas when a picture has many dark areas, and makes it easier to see the bright areas when a picture has many bright areas. When the PICTURE MANAGEMENT function is turned on, the optimum picture settings are automatically set for each picture.

Normally use with this function on.

**■ COLOUR SYSTEM**

The colour system is chosen automatically. However, if the picture is not clear or no colour appears, choose the colour system manually.

**1 Choose COLOUR SYSTEM. Then press the OK or ► button**

The sub-menu of the COLOUR SYSTEM function appears.

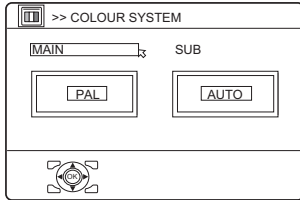

**2 Press the ◀/▶ buttons to choose MAIN or SUB**

**MAIN:**

You can change the colour system of the main-picture.

**SUB:**

You can change the colour system of the sub-picture.

- Choose MAIN when a sub-picture is not displayed.

**3 Press the ▼/▲ buttons to choose the appropriate colour system. Then press the OK button**

**PAL:**

PAL system

**SECAM:**

SECAM system

**NTSC 3.58:**

NTSC 3.58 MHz system

**NTSC 4.43:**

NTSC 4.43 MHz system

**AUTO:**

This function detects a colour system from the input signal. You can only use this when you are viewing a picture from programme number PR 0 (AV), or an EXT terminal.

- The AUTO function may not function properly if you have poor signal quality. If the picture is abnormal in the AUTO function, choose another colour system manually.
- When in the Programme numbers PR 0 (AV) to PR 99, you cannot choose NTSC 3.58 or NTSC 4.43. SECAM cannot be chosen when the COUNTRY setting is UNITED KINGDOM.
- COLOUR SYSTEM cannot be chosen when you are watching the EXT-4 picture, EXT-6 (HDMI) picture or a PC picture.

**■ 4:3 AUTO ASPECT**

You can choose one of three ZOOM modes, REGULAR, PANORAMIC or 14:9 ZOOM, as the ZOOM mode for the normal picture (4:3 aspect ratio).

**1 Choose 4:3 AUTO ASPECT then press the OK button**

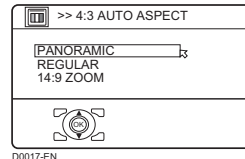

**2 Press the ▼/▲ buttons to choose a ZOOM mode**

# SOUND menu

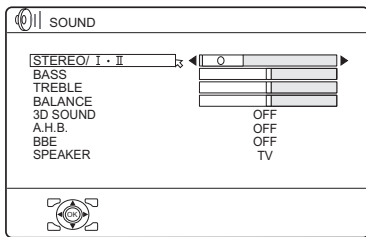

- When the headphones are connected, only “STEREO / I • II” and “SPEAKER” can be used.
- When the “SPEAKER” setting (see page 34) is CENTRE, BALANCE and 3D SOUND cannot be chosen from the SOUND menu.

## STEREO / I • II

When you are viewing a bilingual broadcast programme, you can choose the sound from Bilingual I (Sub I) or Bilingual II (Sub II). If you have poor reception on a stereo broadcast, you can change from stereo to mono sound so that you can hear the broadcast more clearly and easily.

⊙ : Stereo sound

○ : mono sound

I : Bilingual I (sub I)

II : Bilingual II (sub II)

- The sound mode you can choose differs depending on the TV programme.
- This function does not work in the EXT modes.

## BASS

You can adjust the low tone of the sound.

◀ : weaker

▶ : strong

## TREBLE

You can adjust the high tone of the sound.

◀ : weaker

▶ : strong

## BALANCE

You can adjust the volume balance between the left and right speaker.

◀ : turn the left speaker's volume level up.

▶ : turn the right speaker's volume level up.

## 3D SOUND

You can enjoy Surround sound with a “live” effect by using the 3D SOUND function.

- You can choose a 3D SOUND mode from HIGH, LOW, MONO and OFF modes. For details, see “3D SOUND function” on page 19.
- You can also operate the 3D SOUND function with the  button. For details, see “3D SOUND function” on page 19.

## A.H.B. (Active Hyper Bass)

Used when you want to emphasize the bass sound.

**ON:**

This function is turned on.

**OFF:**

This function is turned off.

---

## BBE

---

You can use the BBE function to enjoy easy-to-listen sound that is faithful to the original sound recorded.

**ON:**

This function is turned on.

**OFF:**

This function is turned off.

- 
- Licensed by BBE Sound, Inc. BBE is a registered trademark of BBE Sound, Inc.
- 

---

## SPEAKER

---

You can set the TV speaker mode for when connected to the CENTRE CH input terminal.

**TV:**

The TV sound is emitted from the TV speaker.

**CENTRE:**

The sound from the CENTRE CH input terminal is emitted from the TV speaker.

# FEATURES menu

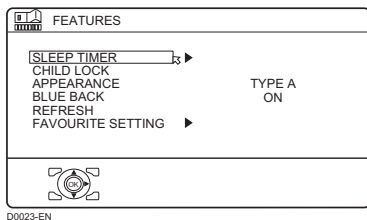

D0023-EN

## SLEEP TIMER

You can set the TV to automatically turn off after a set period of time.

### 1 Choose SLEEP TIMER. Then press the OK or ► button

A Sub-menu of the SLEEP TIMER function appears.

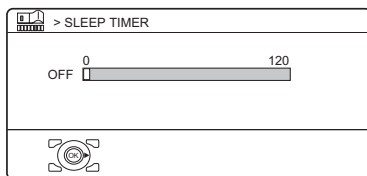

D0024-EN

### 2 Press the ◀/▶ buttons to set the period of time. Then press the OK button

You can set the period of time for up to 120 minutes (2 hours) in 10 minute steps.

- One minute before the SLEEP TIMER function turns off the TV, “GOODNIGHT!” appears.
- The SLEEP TIMER function cannot be used to turn off the TV’s main power.
- When the SLEEP TIMER function is on, you can display the sub-menu of the SLEEP TIMER function again to confirm or change the remaining period of time of the SLEEP TIMER function. Press the OK button to leave the menu after confirming or changing the remaining time.

### To cancel the SLEEP TIMER function:

Press the ◀ button to set the period of time to “OFF”.

## CHILD LOCK

When there is a TV channel you do not want your children to watch, you can use the CHILD LOCK function to lock out the TV channel. Even when a child chooses a programme number (PR) for a locked TV channel the screen will change to blue and display  (CHILD LOCK) so the TV channel cannot be viewed. Unless you enter a pre-set ID number by a special operation, the lock cannot be released and the child cannot view the TV channel.

### ■ To set the CHILD LOCK function

#### 1 Choose CHILD LOCK, then press the 0 button

“SET ID NO.” (ID number setting screen) appears.

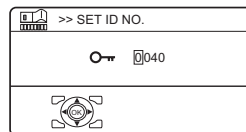

D0025-EN

#### 2 Set the ID number to your liking

1 Press the ▼/▲ buttons to choose a number.

2 Press the ◀/▶ buttons to move the cursor.

#### 3 Press the OK button

The Sub-menu of CHILD LOCK appears.

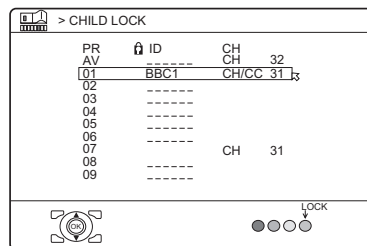

D0026-EN

**4 Press the ▼/▲ buttons to choose a TV channel**

Every time you press the ▼/▲ buttons, the Programme number (PR) changes, and the picture of the TV channel registered in the Programme number (PR) is displayed on the screen.

**5 Press the blue button and set the CHILD LOCK function. Then press the OK button**

🔒 (CHILD LOCK) appears and the TV channel is locked.

**To reset the CHILD LOCK function:**

Press the blue button again.

🔒 (CHILD LOCK) disappears.

To disable easy resetting of the CHILD LOCK function, the menu disappears if you choose the CHILD LOCK function and press the **OK** button.

**■ To view a locked TV channel**

**1 Choose a programme number (PR) of a locked TV channel with the number buttons or PR LIST**

The screen changes to blue and the 🔒 (CHILD LOCK) appears. You cannot view the TV channel.



**2 Press the ⓘ (Information) button to display “ID NO.” (ID No. input screen)**

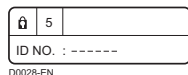

**3 Press the number buttons to enter the ID number**

The lock is temporarily released so you can view the TV channel.

**If you have forgotten the ID number:**

Perform step 1 of “To set the CHILD LOCK function”. After confirming the ID number, press the **TV** button to exit the menu.

- Even if you reset the lock temporarily, it does not mean that the CHILD LOCK function set for the TV channel is cancelled. The next time anyone tries to view the TV channel, it will be locked again.
- When you want to cancel the CHILD LOCK function, you must perform the operation “To set the CHILD LOCK function” again.
- To stop it being easy to choose the programme number (PR) of a locked TV channel, the programme number (PR) has been set so that it cannot be chosen with the ▼/▲ buttons or the buttons of the TV.
- To stop it being easy to reset the lock, “ID NO.” (ID No. input screen) is set so that it cannot appear unless you press the ⓘ (Information) button.

**APPEARANCE**

Press the ◀/▶ button and choose the format in which the channel number is displayed from the four types: TYPE A, TYPE B, TYPE C, and TYPE D.

- Set to TYPE D when shipped from factory. TYPE D sets all screens to semitransparent. The menu screens are not semitransparent when set to a type other than TYPE D.

**BLUE BACK**

You can set the TV to automatically change to a blue screen and mute the sound if the signal is weak or absent, or when there is no input from an external device.

**ON:**

This function is turned on.

**OFF:**

This function is turned off.

## REFRESH

When burn-in is minimal, burn-in and residual images may be softened with the REFRESH function.

### 1 Choose REFRESH

### 2 Press the OK button

Snow appears on the screen. Leave the TV in this condition for a few hours.

### 3 After a few hours, press the TV, number buttons, or ⏻/I button

Press the ⏻ button for the TV.

The REFRESH function has no effect if used only for a short time.

## FAVOURITE SETTING

Chose when deleting the favourite channels registered in the buttons 1 to 4.

### 1 Choose FAVOURITE SETTING, then press the OK or ► button

The FAVOURITE SETTING menu appears.

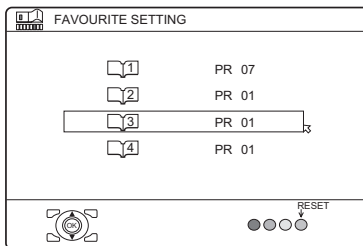

D0112-EN

### 2 Press the ▼/▲ buttons and chose the favourite channel that you want to delete

### 3 Press the blue button

The chosen favourite channel and set contents are deleted.

- For detail of the favourite channels, see “Favourite channel function” on page 22.

# SET UP menu

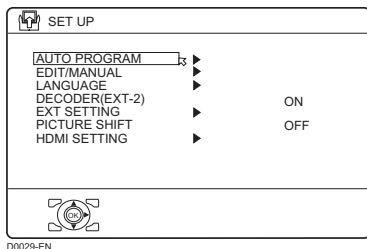

## AUTO PROGRAM

You can again perform the AUTO PROGRAM function TV channel automatic registration which was performed in the “Initial settings” (page 9).

To receive SKY 1 you need a satellite tuner. You must have the satellite tuner set to SKY 1 before starting the AUTO PROGRAM function.

### 1 Choose AUTO PROGRAM, then press the OK or ► button

The COUNTRY menu appears as a sub-menu of the AUTO PROGRAM function. There are two COUNTRY menus. Pressing the yellow button changes the COUNTRY menu as follows:

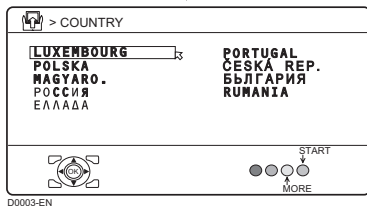
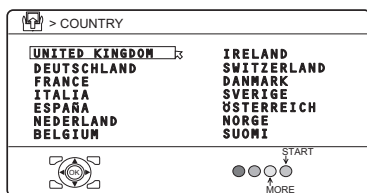

2 Press the ◀/▶ and ▼/▲ buttons to choose the country where you are

3 Perform steps 5 and 6 of the “Initial settings” (page 10)

## EDIT/MANUAL

The EDIT/MANUAL functions are divided into two types:

- editing the current programme numbers (PR) (EDIT functions); and
- manually storing a TV channel you want to view on a particular programme number (PR) (MANUAL function).

Here are the details about these functions:

### MOVE:

This function changes the programme number (PR) of a TV channel.

### ID:

This function registers a channel name (ID) to a TV channel.

### INSERT:

This function adds a new TV channel in the current programme numbers (PR) list by using the CH/CC number.

- You cannot use the INSERT function if you do not know the channel number of a TV channel. Use the MANUAL function to register a TV channel in the programme number (PR).

### DELETE:

This function deletes a TV channel you do not want to list.

### MANUAL:

This function manually stores a new TV channel in a programme number (PR).

### Caution

- Using the MOVE, DELETE or INSERT functions rewrites the current programme numbers (PR) list. Therefore, the programme numbers (PR) of some of the TV channels will change.
- Using the MANUAL function for a TV channel for which the CHILD LOCK function has been set cancels the CHILD LOCK function for that channel.



- Using the MANUAL function for a TV channel for which the DECODER (EXT-2) function has been set to ON returns the setting of the DECODER (EXT-2) function for that channel to OFF.
- When a TV channel has already been registered in PR 99, using the INSERT function deletes that TV channel.

## Basic operation

### 1 Choose EDIT/MANUAL, then press the OK or ► button

The EDIT menu appears.

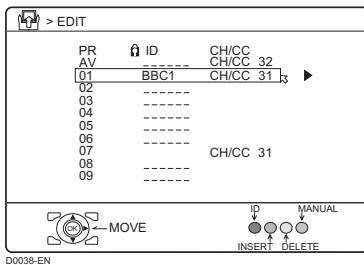

### 2 Follow the description for the function you want to use

### 3 Press the OK button to complete the settings

The T-V LINK menu appears.

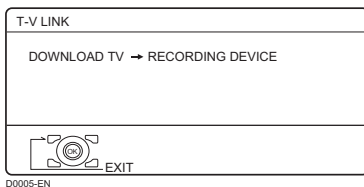

### If you do not have a T-V LINK compatible VCR connected:

Press the **TV** button to exit the T-V LINK menu.

The T-V LINK menu disappears.

### If you have a T-V LINK compatible VCR connected to the EXT-2 terminal:

Follow “Downloading the data to VCR” on page 11 to transmit the programme number (PR) data.

- For programme number PR 0, “AV” appears in the programme numbers (PR) list.
- An EXT terminal number does not appear in the programme numbers (PR) list.
- The CH/CC number is a number unique to the TV and corresponds to the channel number of a TV channel. For the relationship between a channel number and a CH/CC number, see “CH/CC numbers” on page 52.

## MOVE

### 1 Press the ▼/▲ buttons to choose a TV channel

Every time you press the ▼/▲ buttons, the programme number (PR) changes and the picture of the TV channel stored in the programme number (PR) appears on the screen.

### 2 Press the ► button to start the MOVE function

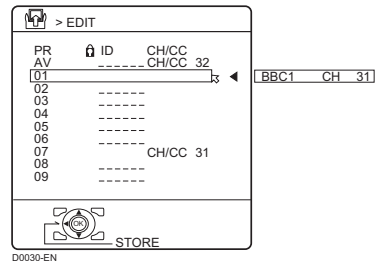

### 3 Press the ▼/▲ buttons to choose a new programme number (PR)

To cancel the MOVE function:  
Press the **BACK** button.

### 4 Press the ◀ button to change the programme number (PR) of a TV channel to a new programme number (PR)

**DELETE**

**1 Press the ▼/▲ buttons to choose a TV channel**

Every time you press the ▼/▲ buttons, the programme number (PR) changes and the picture of the TV channel stored in the programme number (PR) appears on the screen.

**2 Press the yellow button to delete the TV channel**

The TV channel is deleted from the programme numbers (PR) list.

**ID**

**1 Press the ▼/▲ buttons to choose a TV channel**

Every time you press the ▼/▲ buttons, the programme number (PR) changes and the picture of the TV channel stored in the programme number (PR) appears on the screen.

**2 Press the red button to start the ID function**

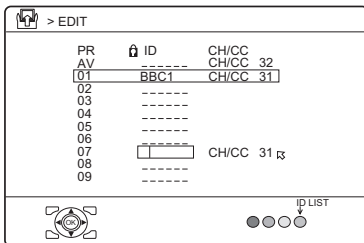

D0031-EN

**3 Press the ▼/▲ buttons to choose the first character of a channel name (ID) you want to give the TV channel**

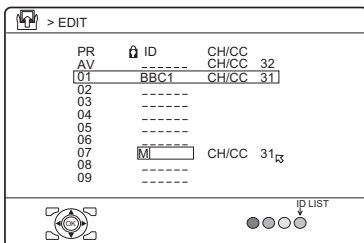

D0032-EN

**4 Press the blue button to display the ID LIST (channel name list)**

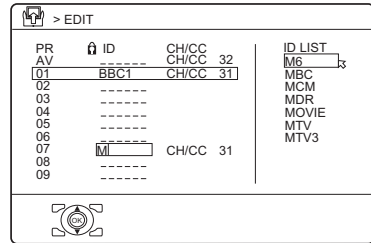

D0033-EN

**5 Press the ▼/▲ buttons to choose the channel name (ID)**

**To cancel the ID function:**

Press the **BACK** button.

**6 Press the OK button to give a channel name (ID) to a TV channel**

- You can give your own unique channel name (ID) to the TV channel. When you have finished step 3, do not go to step 4. Press the ◀/▶ buttons to move the cursor, and press the ▼/▲ buttons to choose each character of the channel name (ID). Then press the **OK** button to register the channel name (ID) to the TV channel.

**Before performing INSERT or MANUAL operation**

- If you register the TV channel (SECAM-L system) from a French station, be sure to set the COUNTRY setting to FRANCE. If the COUNTRY setting is not set to FRANCE, perform steps 1 and 2 of the “AUTO PROGRAM” (page 38) procedure and set the COUNTRY setting to FRANCE before pressing the **OK** button.
- A CH/CC number unique to this TV and corresponding to the Channel number of a TV channel is required. Find the corresponding CH/CC number from a table “CH/CC numbers” on page 52 based on the Channel number of the TV channel.

- When the COUNTRY setting is not FRANCE, use a two-digit CH/CC number. When the COUNTRY setting is FRANCE, use a three-digit CH/CC number.

## ■ INSERT

1 Press the ▼/▲ buttons to choose a programme number (PR) for which you will register a new TV channel

2 Press the green button and start the INSERT function

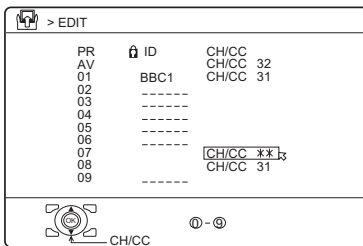

To cancel the INSERT function:  
Press the **BACK** button.

3 When the COUNTRY setting is UNITED KINGDOM:  
Press the number buttons to enter the remaining CH number

- You cannot enter CC numbers.

When the COUNTRY setting is not UNITED KINGDOM:

Press the ▼/▲ buttons to choose “CH” or “CC”, then enter the remaining CH or CC number

When the COUNTRY setting is FRANCE:

Choose “CH1”, “CH2”, “CC1” or “CC2”. The TV shifts to registration mode. When the registration is completed, the picture of the TV channel appears on the screen.

- The CH/CC number is a number given to each broadcast frequency that carries a TV channel. If the TV cannot detect the TV channel corresponding to the broadcast frequency indicated by the CH/CC number, a “no-signal” picture appears.

## ■ MANUAL

1 Press the ▼/▲ buttons to choose a programme number (PR) for a new TV channel

2 Press the blue button to activate the MANUAL function

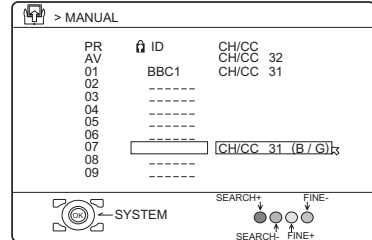

To cancel the MANUAL function:  
Press the **BACK** button.

When the COUNTRY setting is not UNITED KINGDOM:

At the right side following the CH/CC number, the SYSTEM (broadcasting system) of the TV channel appears.

3 When the COUNTRY setting is UNITED KINGDOM:  
Continue to step 4

When the COUNTRY setting is not UNITED KINGDOM:  
Press the ► button to choose the SYSTEM (broadcasting system) for a TV channel you want to register

TV channel (SECAM-L system) from a French station:

Set the SYSTEM to “L”. If it is set to one other than “L”, you cannot receive the TV channel of the SECAM-L system.

**Other TV channels:**

If you do not know the correct broadcasting system, set the SYSTEM to “I”. If “I” is not correct, you will not hear the sound normally when the TV detects a TV channel. In this case, retry to set the SYSTEM correctly so that no problem arises.

**4 Press the green or red button to search for a TV channel**

Scanning stops when the TV finds a TV channel. Then the TV channel is displayed.

**5 Press the green or red button repeatedly until the TV channel you want appears**

**If the TV channel reception is poor:**  
Press the blue or yellow button to fine-tune the TV channel.

**6 Press the OK button and register the TV channel to a Programme number (PR)**

The normal EDIT menu is resumed.

## LANGUAGE

The LANGUAGE setting which was performed in the “Initial settings” (page 9) can be changed.

**1 Choose LANGUAGE, then press the OK or ► button**

A sub-menu of the LANGUAGE function appears.

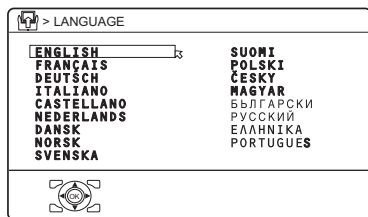

**2 Press the ◀/▶ and ▼/▲ buttons to choose a language. Then press the OK button**

## DECODER (EXT-2)

If you have a decoder connected to a T-V LINK compatible VCR, which in turn is connected to the EXT-2 terminal, use the DECODER (EXT-2) function to unscramble the scrambled TV channels.

**1 Turn on the decoder power**

**2 Display the scrambled TV channel on the TV**

Even if the decoder is working, a scrambled picture appears.

**3 Display the SET UP menu and choose DECODER (EXT-2)**

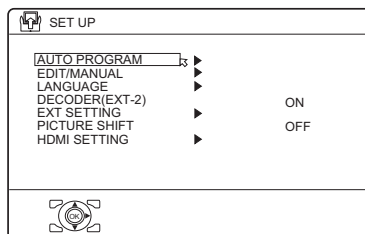

**4 Press the ◀/▶ buttons to choose ON**

An unscrambled picture appears.

**To cancel the DECODER (EXT-2) function:**

Press the ◀/▶ buttons to choose OFF.

**5 Press the OK button to complete the setting**

The T-V LINK menu appears.

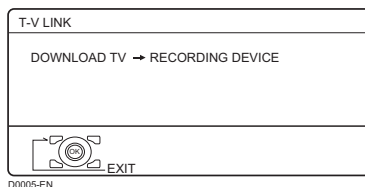

You can send the programme numbers data to a VCR with the T-V LINK function.

## 6 Turn on the VCR, and then press the OK button to transmit the data to VCR

The T-V LINK menu disappears once the data transmission ends.

## 7 If you have another TV channel capable of being unscrambled with a Decoder, repeat steps 2 to 6

If the DECODER (EXT-2) function has been set to "ON" but the TV channel cannot be unscrambled, check the following:

- Has the decoder been connected to the VCR properly according to the VCR and decoder instruction manuals?
- Has the decoder power been turned on?
- Can the TV channel be unscrambled with a decoder?
- Do you need to change the VCR settings in order to connect the decoder? Confirm that the VCR is set properly by rechecking the VCR instruction manual.

## EXT SETTING

### 1 Choose EXT SETTING, then press the OK or ► button

The EXT SETTING menu appears.

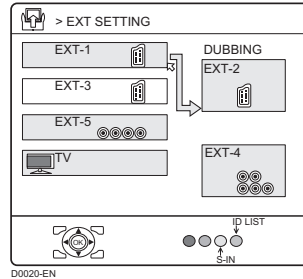

### 2 Follow the instructions for the function you want to use and operate the function

#### S-IN:

You can enjoy the high-quality picture of the 2 S-VIDEO signal (Y/C signal).

#### ID LIST:

You can have a name for each of the devices connected for each EXT terminal.

#### DUBBING:

You can choose a signal source to be output from an EXT-2 terminal.

### ■ S-IN (S-VIDEO input)

You can connect a device (such as an S-VHS VCR) to enjoy the high-quality picture of the S-VIDEO signal (Y/C signal).

#### Preparation:

- First read the device's instruction manual and "Additional preparation" on page 47 to connect the device to the TV properly. Second, follow the device's instruction manual to set the device so that it sends an S-VIDEO signal (Y/C signal) to the TV.
- Do not set S-IN (S-VIDEO input) to an EXT terminal connected to a device which cannot output an S-VIDEO (Y/C signal). If it is set wrongly, a picture cannot appear.

**1 Press the ◀▶ or ▼▲ buttons to choose an EXT terminal**

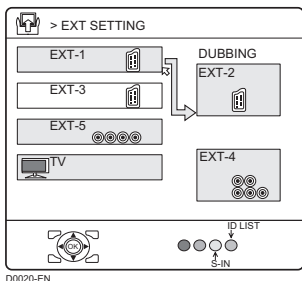

**2 Press the yellow button and set the S-IN (S-VIDEO input). Then press the OK button**

An S-IN (S-VIDEO input) mark is displayed. You can view an S-VIDEO signal (Y/C signal) instead of the regular video signal (composite signal).

**To cancel the S-IN (S-VIDEO input) setting:**

Press the yellow button and turn off S-IN (S-VIDEO input) mark. The regular video signal (composite signal) pictures are resumed.

- The EXT-3 terminal does not support S-VIDEO signal (Y/C signal) and you cannot set S-IN (S-VIDEO input) in the EXT-3 terminal.
- Setting S-IN (S-VIDEO input) changes the head character from “E” to “S”. When an EXT terminal receives a normal video signal, “E1”, “E2” or “E5” appears on the display. This changes to “S1”, “S2” or “S5” when it receives an S-VIDEO signal.
- Even a device which can output an S-VIDEO signal (Y/C signal) may output a regular video signal (composite signal) depending on the device setting. If a picture cannot appear because the S-IN (S-VIDEO input) setting has been made, read the device instruction manual carefully again to check for the device settings.

**■ ID LIST**

You can store a name for each of the devices connected to each EXT terminal. Giving a name to an EXT terminal makes the EXT terminal number appear on the screen, together with its name.

**1 Press the ◀▶ or ▼▲ buttons to choose an EXT terminal**

**2 Press the blue button to display the name list (ID LIST)**

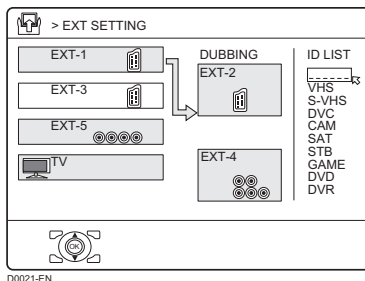

**3 Press the ▼▲ buttons to choose a name. Then press the OK button**

The ID LIST disappears and the name is assigned to the EXT terminal.

- You cannot assign an EXT terminal name not found in the name list (ID LIST).

**To erase a name assigned to the EXT terminal:**

Choose a blank space.

**4 Press the OK button to complete the setting**

## ■ DUBBING

You can choose a signal source to be output from the EXT-2 terminal.

You can do this with the output signals of the devices connected to other EXT terminals, or with the picture and sound from a TV channel you are currently viewing.

### 1 Press the ◀/▶ buttons to choose the arrow from the menu

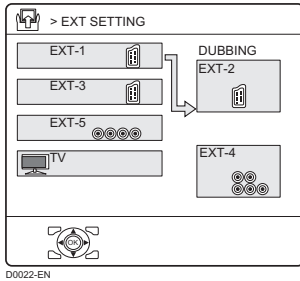

### 2 Press the ▼/▲ buttons to choose an EXT terminal or TV. Then press the OK button

The arrow in the menu represents a signal flow. The left side of the arrow shows a signal source output from the EXT-2 terminal.

#### EXT-1/EXT-3/EXT-5:

The output signal of the device connected to an EXT terminal passes through the TV and is output from the EXT-2 terminal.

#### TV:

The picture and sound of the TV channel you are currently viewing are output from the EXT-2 terminal.

- During dubbing, you cannot turn off the TV. Turning off the TV also turns off the output from the EXT-2 terminal.
- When you choose an EXT terminal as an output, you can view a TV programme or a picture from the other EXT terminal while dubbing the picture from a device connected to the EXT terminal onto a VCR connected to the EXT-2 terminal.
- The RGB signals from TV games cannot be output. Teletext programmes cannot be output.

## PICTURE SHIFT

The picture displayed on the screen is shifted up, down and to the left and right at regular intervals. In order to prevent burn-in, set this function to FAST or SLOW.

### 1 Choose PICTURE SHIFT

### 2 Press the ◀/▶ buttons to choose a mode

#### OFF:

PICTURE SHIFT is turned off.

#### SLOW:

The picture is shifted every 30 minutes.

#### FAST:

The picture is shifted every 10 minutes.

### 3 Press the OK button

The menu disappears.

## HDMI SETTING

This function is used if you have a DVI or HDMI compatible device connected to your TV. For details, see "Using the HDMI terminal" on page 50.

# Displaying a computer screen

This TV can be used as a computer screen.

## Connecting to the computer

Use a commercially available D-SUB cable to connect the TV's PC IN terminal to the computer's analogue RGB output terminal. If you want to listen to the sound from the computer, use a commercially available RCA cable to connect the EXT-5 sound input terminal to the computer's sound output terminal.

When the sound from the computer is mono, connect to the EXT-5 L terminal.

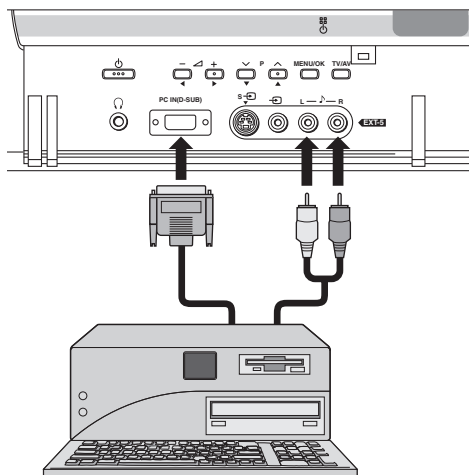

- Refer to the computer manual for a detailed explanation of the connections at the computer side.
- Ensure that the connectors are facing the correct way when connecting.
- After connecting, tighten the two screws to fix the connector in place.

## Looking at images from a computer

**After starting the computer, press the AV or P V/Λ buttons to choose "PC"**

"PC" is after EXT-6 (HDMI).

You can listen to the sound when the sound from the computer is connected to the EXT-5 sound input terminal.

- When the sound from the computer is connected to EXT-5, by choosing external input EXT-5 the sound from the computer can be listened to, but the images from the computer cannot be seen.

## Table of signals for each type of computer

Resolution	Vertical frequency (Hz)	Horizontal frequency (kHz)
640 × 480 (VGA)	60.0	31.5
1024 × 768 (XGA)	60.0	42.0

- \* Only the above formats are supported.
- \* Even with the above formats and at 60 Hz, some problems may be experienced depending on the quality of the synchronous signal. (Depending on the quality, some pictures may not be displayed properly.)
- \* Apple Macintosh\* computers are not supported.

### When a picture is not displayed

With some computers, some problems can be solved by changing the settings.

Check the computer's refresh rate and set it to 60 Hz.

Computers which cannot have their refresh rate set to 60 Hz cannot be used with this unit.

Refer to the computer's instruction manual.

\* Apple Macintosh is a registered trademark of Apple Computer, Inc.



# Additional preparation

## Connecting external equipment

Connect the equipment to the TV, making the correct rear panel and front panel connections.

### Before connecting anything:

- Read the manuals that came with the equipment.  
Depending on the equipment, the connection method may be different from the diagram. Also, the equipment settings may need to change depending on the connection method.
- Turn off all the equipment including the TV.
- The “Specifications” on page 56 give the details of the EXT terminals. If you are connecting equipment not listed in the following connection diagram, see the table to choose the best EXT terminal.
- Connecting cables are not supplied.

### ■ Connecting the PC

For details, see “Connecting to the computer” on page 46.

- ① VCR (composite signal)
- ② VCR (composite signal/S-VIDEO signal)
- ③ T-V LINK compatible VCR (composite signal/S-VIDEO signal)
- ④ Decoder
- ⑤ DVD player (composite signal/S-VIDEO signal)
- ⑥ DVD player (composite signal/RGB signal)
- ⑦ DVD player (component video signals; Y/Pb/Pr)
- ⑧ TV game (composite signal/RGB signal)
- ⑨ TV game (composite signal/S-VIDEO signal)
- ⑩ Headphones
- ⑪ Camcorder (composite signal/S-VIDEO signal)
- ⑫ SCART cable
- ⑬ Audio cable
- ⑭ Video cable
- ⑮ S-VIDEO cable
- ⑯ Component cable

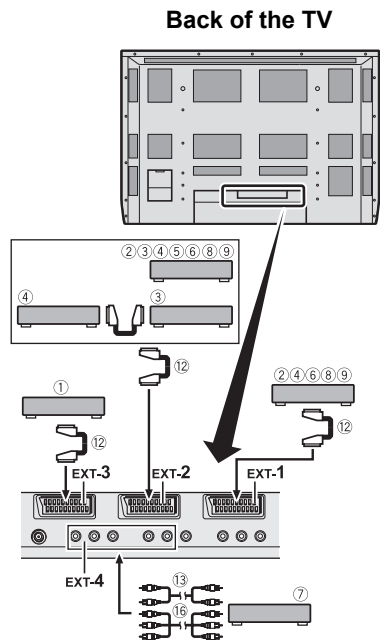
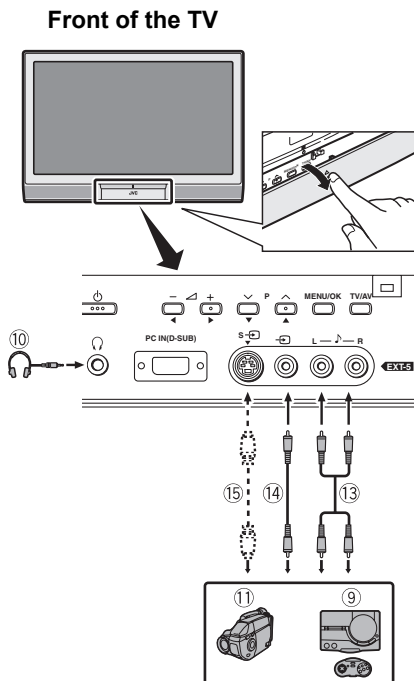

■ **Equipment which can output the S-VIDEO signal (Y/C signal) such as an S-VHS VCR**

Connect the equipment to an EXT terminal. You can choose between an S-VIDEO signal (Y/C signal) and a regular video signal (composite signal). For details of how to operate the equipment, see “S-IN (S-VIDEO input)” on page 43.

■ **T-V LINK compatible VCR**

Be sure to connect the T-V LINK compatible VCR to the EXT-2 terminal. If not, the T-V LINK function will not work properly.

- When connecting a T-V LINK compatible VCR to the EXT-2 terminal, be sure to connect the decoder to the VCR. If not, the T-V LINK function may not work properly. After you have stored TV channels in the programme numbers (PR) list, set the DECODER (EXT-2) function for the programme number (PR) to ON to unscramble a scrambled TV channel. For details, see “EXT SETTING” on page 43.

■ **Connecting headphones**

Connect the headphones with a stereo mini-jack (3.5 mm diameter) to the headphone socket at the TV rear panel.

- No sound comes from the TV speakers when the headphones are connected.

■ **Video or sound signal output from the EXT-2 terminal**

You can change over the output of the video/sound signal from the EXT-2 terminal. This is useful when you want to dub the video/sound from another device onto the VCR connected to the EXT-2 terminal. For details on how to do this, see “DUBBING” on page 45.

- The signals from EXT-4, EXT-6 (HDMI) and PC IN terminals cannot be output from EXT-2.

■ **TV output from the EXT-1 terminal**

The video/sound signal of a TV channel you are viewing is always output from the EXT-1 terminal.

- Changing over a programme number (PR) also changes over the TV output from the EXT-1 terminal.
- The video/sound signal from an EXT terminal cannot be output.
- Teletext programmes cannot be output.

■ **Connecting speakers/amplifier**

While referring to the audio equipment connection diagram, connect the audio equipment you want to the TV. You can use external front speakers to listen to the TV sound instead of the TV speakers.

**Before connecting anything:**

- Read the manuals provided with the amplifier and speakers.
- Turn the TV and amplifier off.
- To prevent magnetism from the speakers adversely affecting the TV screen, use magnetic-shielded speakers for the front speakers.
- Note that connecting cables are not supplied.

**Back of the TV**

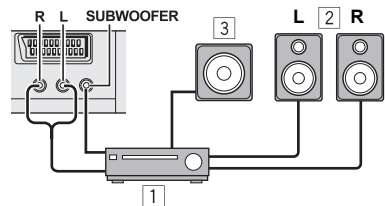

- 1 Amplifier
- 2 Front speakers (Magnetic-shielded type)
- 3 Subwoofer

- The output from the AUDIO OUT terminal is not interrupted by headphone connection to the TV. You cannot cut the sound from the front speaker even if you connect a headphone to the TV.
- Adjust the volume of the external speakers with the amplifier.
- Connect the subwoofer which carried an amplifier.

- The subwoofer is interlocked with the TV volume.
- You cannot connect an amplifier and a subwoofer at the same time.

### ■ Using the TV speaker as the surround centre speaker

The TV speaker can be used as the centre speaker when listening to Dolby Surround sound.

Connect the AV amp centre speaker output terminal and the TV CENTRE CH input terminal.

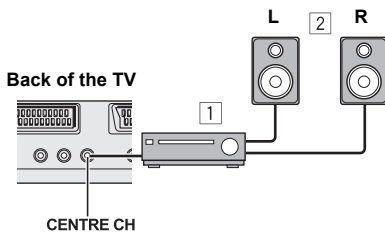

- 1 Amplifier
- 2 Front speakers (Magnetic-shielded type)

When using the TV speaker as the surround centre speaker, set the SOUND menu “SPEAKER” setting to “CENTRE”.

## Using the HDMI terminal

### ■ Connecting a HDMI compatible device

Connecting a HDMI compatible device such as a DVD player or DVR allows you to display high definition pictures on your TV in their digital form.

**Connect the HDMI cable from the digital out on the back of your HDMI device to the HDMI terminal on the back of the TV.**

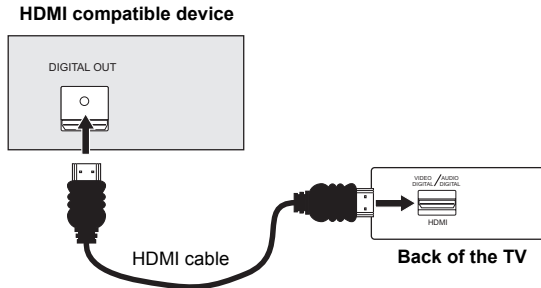

When you connect as shown above, set AUDIO in HDMI SETTING menu in the SET UP menu to DIGITAL. Refer to “Setting HDMI SETTING” below.

- To connect the DVI device to the HDMI terminal, connect the DVI terminal of the DVI device to the HDMI terminal of the TV with the DVI-HDMI converter cable, and the audio output terminal of the DVI device to the EXT-4 AUDIO L/R terminal of the TV with the audio cable. When these connections are made, set AUDIO in HDMI SETTING menu to ANALOGUE. Refer to “Setting HDMI SETTING” below.
- The HDMI terminal is not compatible with the picture signal of a personal computer.

The HDMI of the TV is compatible with the following video signals.

VGA	640 × 480	625p/50Hz	4:3
525i/60Hz	4:3	1125i/50Hz	16:9
525p/60Hz	4:3	1125i/60Hz	16:9
625i/50Hz	4:3		

### ■ Setting HDMI SETTING

- 1 Press the **MENU** button and display the menu bar, press the **◀/▶** buttons and choose **SET UP**, and press the **▼/▲** buttons and choose **HDMI SETTING**, and press then **OK** button

The HDMI SETTING menu appears.

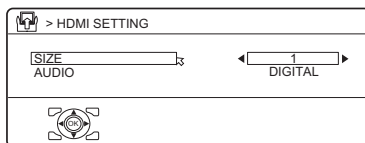

---

## 2 Press the ▼/▲ buttons and choose SIZE or AUDIO

- SIZE can only be chosen when the picture signal is 525p.

### When setting SIZE:

This option adjusts the position when a 525p picture signal is being displayed on the screen. There are two types of 525p picture signals: 640x480 and 720x480. If the displayed picture is slightly shifted, the position can be adjusted by choosing either 1 or 2. 1 or 2 can be chosen by pressing the ◀/▶ buttons.

### When setting AUDIO:

Choose DIGITAL when only connecting with the HDMI cable.  
Choose ANALOGUE when a DVI device is connected to the HDMI terminal and the audio output terminal of the DVI device is connected to the EXT-4 AUDIO terminal.  
DIGITAL or ANALOGUE can be chosen by pressing the ◀/▶ buttons.

# CH/CC numbers

When you want to use the INSERT function on page 41, find the CH/CC number corresponding to the Channel number of the TV channel from this table.

CH	Channel	CH	Channel	CC	Channel	CC	Channel
CH 02 / CH 202	E2, R1	CH 40 / CH 240	E40, R40	CC 01 / CC 201	S1	CC 31 / CC 231	S31
CH 03 / CH 203	E3, ITALY A	CH 41 / CH 241	E41, R41	CC 02 / CC 202	S2	CC 32 / CC 232	S32
CH 04 / CH 204	E4, ITALY B, R2	CH 42 / CH 242	E42, R42	CC 03 / CC 203	S3	CC 33 / CC 233	S33
CH 05 / CH 205	E5, ITALY D, R6	CH 43 / CH 243	E43, R43	CC 04 / CC 204	S4	CC 34 / CC 234	S34
CH 06 / CH 206	E6, ITALY E, R7	CH 44 / CH 244	E44, R44	CC 05 / CC 205	S5	CC 35 / CC 235	S35
CH 07 / CH 207	E7, ITALY F, R8	CH 45 / CH 245	E45, R45	CC 06 / CC 206	S6	CC 36 / CC 236	S36
CH 08 / CH 208	E8, R9	CH 46 / CH 246	E46, R46	CC 07 / CC 207	S7	CC 37 / CC 237	S37
CH 09 / CH 209	E9, ITALY G	CH 47 / CH 247	E47, R47	CC 08 / CC 208	S8	CC 38 / CC 238	S38
CH 10 / CH 210	E10, ITALY H, R10	CH 48 / CH 248	E48, R48	CC 09 / CC 209	S9	CC 39 / CC 239	S39
CH 11 / CH 211	E11, ITALY H+1, R11	CH 49 / CH 249	E49, R49	CC 10 / CC 210	S10	CC 40 / CC 240	S40
CH 12 / CH 212	E12, ITALY H+2, R12	CH 50 / CH 250	E50, R50	CC 11 / CC 211	S11	CC 41 / CC 241	S41
CH 21 / CH 221	E21, R21	CH 51 / CH 251	E51, R51	CC 12 / CC 212	S12	CC 75 / CC 275	X
CH 22 / CH 222	E22, R22	CH 52 / CH 252	E52, R52	CC 13 / CC 213	S13	CC 76 / CC 276	Y, R3
CH 23 / CH 223	E23, R23	CH 53 / CH 253	E53, R53	CC 14 / CC 214	S14	CC 77 / CC 277	Z, ITALY C, R4
CH 24 / CH 224	E24, R24	CH 54 / CH 254	E54, R54	CC 15 / CC 215	S15	CC 78 / CC 278	Z+1, R5
CH 25 / CH 225	E25, R25	CH 55 / CH 255	E55, R55	CC 16 / CC 216	S16	CC 79 / CC 279	Z+2
CH 26 / CH 226	E26, R26	CH 56 / CH 256	E56, R56	CC 17 / CC 217	S17		
CH 27 / CH 227	E27, R27	CH 57 / CH 257	E57, R57	CC 18 / CC 218	S18		
CH 28 / CH 228	E28, R28	CH 58 / CH 258	E58, R58	CC 19 / CC 219	S19		
CH 29 / CH 229	E29, R29	CH 59 / CH 259	E59, R59	CC 20 / CC 220	S20		
CH 30 / CH 230	E30, R30	CH 60 / CH 260	E60, R60	CC 21 / CC 221	S21		
CH 31 / CH 231	E31, R31	CH 61 / CH 261	E61, R61	CC 22 / CC 222	S22		
CH 32 / CH 232	E32, R32	CH 62 / CH 262	E62, R62	CC 23 / CC 223	S23		
CH 33 / CH 233	E33, R33	CH 63 / CH 263	E63, R63	CC 24 / CC 224	S24		
CH 34 / CH 234	E34, R34	CH 64 / CH 264	E64, R64	CC 25 / CC 225	S25		
CH 35 / CH 235	E35, R35	CH 65 / CH 265	E65, R65	CC 26 / CC 226	S26		
CH 36 / CH 236	E36, R36	CH 66 / CH 266	E66, R66	CC 27 / CC 227	S27		
CH 37 / CH 237	E37, R37	CH 67 / CH 267	E67, R67	CC 28 / CC 228	S28		
CH 38 / CH 238	E38, R38	CH 68 / CH 268	E68, R68	CC 29 / CC 229	S29		
CH 39 / CH 239	E39, R39	CH 69 / CH 269	E69, R69	CC 30 / CC 230	S30		

CH	Channel	CH	Channel	CC	Frequency (MHz)	CC	Frequency (MHz)
CH 102	F2	CH 141	F41	CC 110	116 - 124	CC 152	391 - 399
CH 103	F3	CH 142	F42	CC 111	124 - 132	CC 153	399 - 407
CH 104	F4	CH 143	F43	CC 112	132 - 140	CC 154	407 - 415
CH 105	F5	CH 144	F44	CC 113	140 - 148	CC 155	415 - 423
CH 106	F6	CH 145	F45	CC 114	148 - 156	CC 156	423 - 431
CH 107	F7	CH 146	F46	CC 115	156 - 164	CC 157	431 - 439
CH 108	F8	CH 147	F47	CC 116	164 - 172	CC 158	439 - 447
CH 109	F9	CH 148	F48	CC 123	220 - 228	CC 159	447 - 455
CH 110	F10	CH 149	F49	CC 124	228 - 236	CC 160	455 - 463
CH 121	F21	CH 150	F50	CC 125	236 - 244	CC 161	463 - 469
CH 122	F22	CH 151	F51	CC 126	244 - 252		
CH 123	F23	CH 152	F52	CC 127	252 - 260		
CH 124	F24	CH 153	F53	CC 128	260 - 268		
CH 125	F25	CH 154	F54	CC 129	268 - 276		
CH 126	F26	CH 155	F55	CC 130	276 - 284		
CH 127	F27	CH 156	F56	CC 131	284 - 292		
CH 128	F28	CH 157	F57	CC 132	292 - 300		
CH 129	F29	CH 158	F58	CC 133	300 - 306		
CH 130	F30	CH 159	F59	CC 141	306 - 311		
CH 131	F31	CH 160	F60	CC 142	311 - 319		
CH 132	F32	CH 161	F61	CC 143	319 - 327		
CH 133	F33	CH 162	F62	CC 144	327 - 335		
CH 134	F34	CH 163	F63	CC 145	335 - 343		
CH 135	F35	CH 164	F64	CC 146	343 - 351		
CH 136	F36	CH 165	F65	CC 147	351 - 359		
CH 137	F37	CH 166	F66	CC 148	359 - 367		
CH 138	F38	CH 167	F67	CC 149	367 - 375		
CH 139	F39	CH 168	F68	CC 150	375 - 383		
CH 140	F40	CH 169	F69	CC 151	383 - 391		

- 
- When two CH/CC numbers correspond to one Channel number, choose either one according to the current COUNTRY setting. When the COUNTRY setting is other than FRANCE, choose a two-digit CH/CC number. When the COUNTRY setting is FRANCE, choose a three-digit CH/CC number.
  - Find the CH/CC number (CC110 to CC161) corresponding to the TV channel (SECAM-L system) from a French cable TV station, based on the broadcast frequency of the TV channel. When you do not know the broadcast frequency, please contact the cable TV station.
  - The CH/CC numbers of CH102-CH169 and CC110-CC161 correspond to the TV channels being broadcast by a SECAM-L system. The other CH/CC numbers correspond to the TV channels being broadcast by a method other than a SECAM-L system.
-

# Troubleshooting

---

If a problem arises while you are using the TV, please read this troubleshooting guide carefully before you ask to have the TV repaired. You may be able to fix it easily by yourself. For example, if the mains plug is disconnected from the mains outlet, or the TV aerial has problems, you may think there is a problem with the TV itself.

## Important:

- This troubleshooting guide only covers problems whose causes are not easy to decide. If you have a question when you are operating a function, read the page(s) for that function carefully, not this troubleshooting guide.
- If you follow the advice in this troubleshooting guide without any success, unplug the mains plug and ask for your TV to be repaired. Do not attempt to repair the TV by yourself or to remove the rear cover of the TV.

## ■ If you cannot turn on the TV

- Is the mains plug connected to the mains outlet?
- Is the power lamp lit? If not, press the  $\odot$  button on the TV.
- Make sure you set the VCR/TV/DVD switch to the TV position. You cannot turn the TV on when the VCR/TV/DVD switch is set to the VCR or DVD position.

## ■ If you cannot turn off the TV

- Make sure you set the VCR/TV/DVD switch to the TV position. You cannot turn the TV off when the VCR/TV/DVD switch is set to the VCR or DVD position.

## ■ No picture or no sound

- Have you chosen a TV channel with very poor reception? If so, the BLUE BACK function will be activated: the entire screen becomes blue, and the sound is muted. If you still want to view the TV channel, follow the description “BLUE BACK” on page 36 to change the BLUE BACK function setting to OFF.
- If the SYSTEM setting for a TV channel is incorrect, it may prevent the sound from being issued. Follow the description “EDIT/MANUAL” on page 38 to use the MANUAL function to try to change the SYSTEM setting.

## ■ Poor picture

- If noise (snow) totally blocks out the picture, there may be a problem with the aerial or aerial cable. Check the following to try to solve the problem:

–Have the TV and aerial been connected properly?

–Has the aerial cable been damaged?

–Is the aerial pointing in the right direction?

–Is the aerial itself faulty?

- If the TV or aerial suffers interference from other equipment, stripes or noise may appear in the picture. Move any equipment such as an amplifier, personal computer, or a hair drier, that can cause interference away from your TV. Or try moving the TV. If the aerial suffers interference from a radio tower or high-voltage wire, please contact your local dealer.
- If the TV suffers interference from signals reflecting from mountains or buildings, double-pictures (ghosting) will occur. Try to change the aerial’s direction or replace it with one with better directionality.
- Are your COLOUR SYSTEM settings correct? Follow the description “COLOUR SYSTEM” on page 32 to try to solve the trouble.
- Have the COLOUR and BRIGHT settings been adjusted properly? Follow the description “BRIGHT” and “COLOUR” on page 29 to try to adjust them properly.
- Videotaping teletext is not recommended because it may not record correctly.



- When viewing images from commercially available video software products, or videos from videotapes which have been recorded improperly, the top of the image may be distorted. This is due to the condition of the video signal. There is nothing wrong with the TV.
- Since this TV is designed to make full use of the resolution of the original video source, the motion may appear unnatural when the video source is input with 625p progressive-scanning component signals. If this occurs, change the output setting of the connected device to 625i interlace-scanning component signal output. See the instructions that came with the device for more information.

### ■ Poor sound

- Have you adjusted BASS or TREBLE properly? If not, follow the description “BASS” or “TREBLE” on page 33.
- When TV channel reception is poor, it can be hard to hear stereo or bilingual sound. In this case, follow the description “STEREO / I • II” on page 33 to hear the sound more easily by changing it to a mono sound.

### ■ If the TV does not respond to the remote control

- Have the batteries of the remote control worn out? Follow the description “Putting the batteries into the remote control” on page 8 and replace them with new batteries.
- Have you attempted to use the remote control from the sides or rear of the TV or from more than seven metres away from the TV? Use the remote control in front of your TV or from less than seven metres away.
- When you are viewing a teletext programme, you cannot operate the menus. Press the **TV** button to return to the ordinary TV programme, and then try operating the menus.
- If the TV suddenly stops responding, press the  $\odot$  button on the TV and turn off the TV. Press the  $\odot$  button again to turn on the TV. If the TV returns to a normal state, it is not a failure.

### ■ Other issues

- When the SLEEP TIMER function operates, the TV is automatically turned off. If the TV suddenly turns off, try to press the  $\odot$ /I (standby) button to turn on the TV once again. If the TV goes back to normal, there is no problem.
- When the TV is receiving a wide-screen signal (WSS) or a signal from an external device affecting the screen size, the ZOOM mode automatically changes. When you want to resume the previous ZOOM mode, press the **ZOOM** button again.
- If you bring magnetised equipment such as a speaker near to your TV, the picture may be warped or unnatural colours may appear at the corners of the screen. In this case, keep the equipment away from your TV. If speakers cause this to happen, use magnetically-shielded speakers instead.
- It takes a short period of time from the time an operation such as changing channels is performed until an image is displayed. This is not a fault. This is the time needed for the image to stabilize before it can be displayed.
- The TV may make a crackling sound due to a sudden change in temperature. The picture or sound may be normal. If you hear crackling sounds frequently while you are viewing the TV, there may be other causes. As a precaution, ask your service technician to inspect it.
- Touching the screen may cause you to feel a slight electric shock due to its static electricity. This is unavoidable due to the construction of the picture tube. It is not a problem with the TV. You can rest assured that this static discharge is not harmful.

# Specifications

Model	PD-42X50BU/PD-42X50BJ/PD-42X50BS	
COUNTRY setting	When the COUNTRY setting is <b>UNITED KINGDOM</b>	When the COUNTRY setting is <b>not UNITED KINGDOM</b>
Broadcasting systems	CCIR I	CCIR B/G, I, D/K, L
Colour systems	PAL • The EXT terminals also support the NTSC 3.58/4.43 MHz system.	PAL, SECAM • The EXT terminals also support the NTSC 3.58/4.43 MHz system.
Channels and frequencies	E21-E69	IR A-J, E2-E12, E21-E69, S1-S41, X, Y, Z, Z+1, Z+2
Sound-multiplex systems	NICAM (I) system	NICAM (B/G, I, D/K, L) system, A2 (B/G, D/K) system
Teletext systems	FLOF (Fastext), WST (World Standard System)	FLOF (Fastext), TOP, WST (World Standard System)
Power requirements	110 - 240 V AC, 50 Hz	
Power consumption	287 W (Standby: 3.0 W)	
Screen size	Viewable area 106 cm (measured diagonally)	
Audio output	Rated Power output: 10 W + 10 W	
Speakers	6.6 cm round × 4	
EXT-1 terminal	Euroconnector (21-pin, SCART) • Video input, S-VIDEO (Y/C) input, Audio L/R inputs and RGB inputs are available. • TV broadcast outputs (Video and Audio L/R) are available.	
EXT-2 terminal	Euroconnector (21-pin, SCART) • Video input, S-VIDEO (Y/C) input, Audio L/R inputs and RGB inputs are available. • Video and Audio L/R outputs are available. • T-V LINK functions are available.	
EXT-3 terminal	Euroconnector (21-pin, SCART) • Video input and Audio L/R inputs are available.	
EXT-4 terminal	RCA connectors × 5 • Video input, Component video (Y, Pb, Pr) input and Audio L/R inputs are available. • 625p, 525p, 1125i and 750p signals are available. 750p signal is only available for 60Hz. • Some DVD players can output 625p, 525p and 750p signals.	
EXT-5 terminal	RCA connectors × 3 S-VIDEO connector × 1 • Video input, S-VIDEO (Y/C) input and Audio L/R inputs are available.	
EXT-6 (HDMI) terminal	HDMI connector × 1, Digital video input and digital audio input available (Refer to page 50 for details.).	
AUDIO OUT terminal	RCA connectors × 3 • Audio L/R outputs and SUBWOOFER output are available. • Output level 0.5 Vrms.	
AUDIO IN terminal	RCA connector × 1 • CENTRE CH input is available.	
PC INPUT terminal	Analog RGB D-SUB (15 pin) × 1 • PC signal is available. Refer to page 46 for details of the signals which can be input.	
Headphone jack	Stereo mini-jack (3.5 mm in diameter)	
Dimensions (W × H × D)	1045 mm × 729 mm × 115 mm (TV only)	
Weight	39.0 kg (TV only)	
Accessories	Refer to "Checking the contents of packages" on page 5.	

## We may change the design and specifications without notice.

Pictures displayed on the screen using this TV's ZOOM functions should not be shown for any commercial or demonstration purpose in public places (cafes, hotels, etc.) without the consent of the owners of copyright of the original picture sources, as this would be an infringement of copyright.

# JVC

## Free Manuals Download Website

<http://myh66.com>

<http://usermanuals.us>

<http://www.somanuals.com>

<http://www.4manuals.cc>

<http://www.manual-lib.com>

<http://www.404manual.com>

<http://www.luxmanual.com>

<http://aubethermostatmanual.com>

Golf course search by state

<http://golfingnear.com>

Email search by domain

<http://emailbydomain.com>

Auto manuals search

<http://auto.somanuals.com>

TV manuals search

<http://tv.somanuals.com>