

# JVC



ENGLISH

DEUTSCH

FRANÇAIS

NEDERLANDS

**CD RECEIVER**  
CD-RECEIVER  
RECEPTEUR CD  
CD-RECEIVER

## KD-LH7R/KD-LH5R



**KD-LH7R**

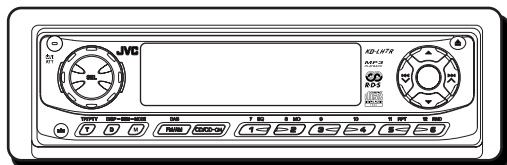

**MP3**  
PLAYBACK

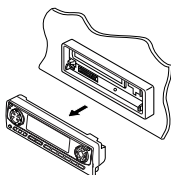

**KD-LH5R**

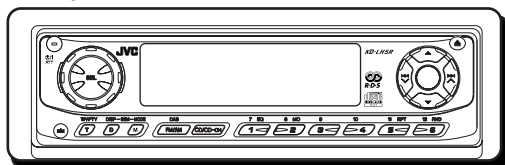

For installation and connections, refer to the separate manual.  
Für den Einbau und die Anschlüsse siehe das eigenständige Handbuch.  
Pour l'installation et les raccordements, se référer au manuel séparé.  
Bijzonderheden over de installatie en aansluiting van het apparaat vindt u in de desbetreffende handleiding.

## **INSTRUCTIONS** **BEDIENUNGSANLEITUNG** **MANUEL D'INSTRUCTIONS** **GEBRUIKSAANWIJZING**

GET0075-001A  
[E/EX]

## Position And Reproduction Of Labels

Bottom panel of the main unit

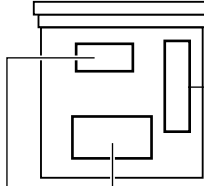

Name/Rating plate

**CAUTION:** Invisible laser radiation when open and interlock failed or defeated. AVOID DIRECT EXPOSURE TO BEAM. (e)

**ADVARSEL:** Usynlig laserstråling ved åbning, når sikkerhedsafbrydere er ude af funktion. Undgåudsættelse for stråling. (d)

**WARNING:** Osynlig laserstråling når denna del är öppnad och spärren är urkopplad. Betrakta ej strålen. (s)

**VARO:** Avattaessa ja suojalukitus ohitettaessa olet alttiina näkymättömälle lasersäteilylle. Älä katso säteeseen. (f)



**Caution:**

This product contains a laser component of higher laser class than Class 1.

## IMPORTANT FOR LASER PRODUCTS

**Precautions:**

1. CLASS 1 LASER PRODUCT

2. **CAUTION:** Invisible laser radiation when open and interlock failed or defeated. Avoid direct exposure to beam.

3. **CAUTION:** Do not open the top cover. There are no user-serviceable parts inside. Leave all servicing to qualified service personnel.

4. **CAUTION:** This CD player uses invisible laser radiation and is equipped with safety switches to prevent radiation emission when unloading CDs. It is dangerous to defeat the safety switches.

5. **CAUTION:** Use of controls, adjustments or performance of procedures other than those specified herein may result in hazardous radiation exposure.

### How to reset your unit

After detaching the control panel, press the reset button on the panel holder using a ball-point pen or similar tool.

This will reset the built-in microcomputer.

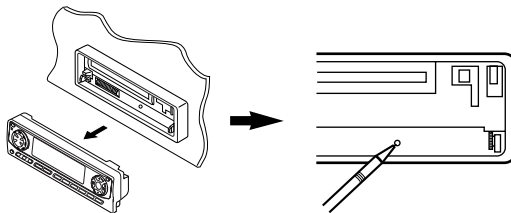

**Note:**

- Your preset adjustments – such as preset channels or sound adjustments – will also be erased.

**Note:**

For security reasons, a numbered ID card is provided with this unit, and the same ID number is imprinted on the unit's chassis. Keep the card in a safe place, as it will help the authorities to identify your unit if stolen.

### BEFORE USE

**\*For safety...**

- Do not raise the volume level too much, as this will block outside sounds, making driving dangerous.
- Stop the car before performing any complicated operations.

**\*Temperature inside the car...**

If you have parked the car for a long time in hot or cold weather, wait until the temperature in the car becomes normal before operating the unit.

Thank you for purchasing a JVC product. Please read all instructions carefully before operation, to ensure your complete understanding and to obtain the best possible performance from the unit.

# CONTENTS

How to reset your unit .....	2	<b>SOUND ADJUSTMENTS</b> .....	<b>29</b>
How to use the MODE (M) button .....	3	Adjusting the sound .....	29
<b>LOCATION OF THE BUTTONS</b> .....	<b>4</b>	Selecting preset sound modes (C-EQ: custom equalizer) .....	30
Control panel .....	4	Storing your own sound adjustments .....	31
Preparing the remote controller .....	5	<b>OTHER MAIN FUNCTIONS</b> .....	<b>32</b>
Remote controller .....	6	Setting the clock .....	32
<b>BASIC OPERATIONS</b> .....	<b>7</b>	Changing the general settings (PSM) .....	32
Turning on the power .....	7	Assigning names to the sources (only for KD-LH7R) .....	36
<b>RADIO OPERATIONS</b> .....	<b>8</b>	Detaching the control panel .....	37
Listening to the radio .....	8	<b>CD CHANGER OPERATIONS</b> .....	<b>38</b>
Storing stations in memory .....	10	Playing CDs .....	38
Tuning in to a preset station .....	11	Selecting CD playback modes .....	40
<b>RDS OPERATIONS</b> .....	<b>12</b>	<b>EXTERNAL COMPONENT OPERATIONS</b> ...	<b>41</b>
What you can do with RDS .....	12	Playing an external component .....	41
Other convenient RDS functions and adjustments .....	16	<b>DAB TUNER OPERATIONS</b> .....	<b>42</b>
<b>CD OPERATIONS</b> .....	<b>19</b>	Tuning in to an ensemble and one of the services .....	42
Playing a CD .....	19	Storing DAB services in memory .....	44
Locating a track or a particular portion on a CD .....	20	Tuning in to a preset DAB service .....	44
Selecting CD playback modes .....	21	What you can do more with DAB .....	45
Prohibiting CD ejection .....	22	<b>TROUBLESHOOTING</b> .....	<b>46</b>
Playing a CD Text .....	22	<b>MAINTENANCE</b> .....	<b>48</b>
<b>MP3 INTRODUCTION</b> .....	<b>23</b>	Handling CDs .....	48
<b>(ONLY FOR KD-LH7R)</b>		<b>SPECIFICATIONS</b> .....	<b>49</b>
What is MP3? .....	23		
How are MP3 files recorded and played back? .....	23		
<b>MP3 OPERATIONS</b> .....	<b>25</b>		
<b>(ONLY FOR KD-LH7R)</b>			
Playing an MP3 disc .....	25		
Locating a file or particular portion on an MP3 disc .....	26		
Selecting MP3 playback modes .....	28		

## How to use the MODE (M) button:

If you press MODE (M), the unit goes into functions mode and the number buttons work as different function buttons.

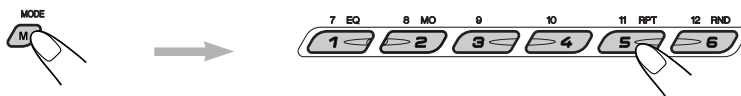

To use these buttons as number buttons again after pressing MODE (M), wait for 5 seconds without pressing any number button until the functions mode is cleared.

- Pressing MODE (M) again also clears the functions mode.



# LOCATION OF THE BUTTONS

ENGLISH

## Control panel

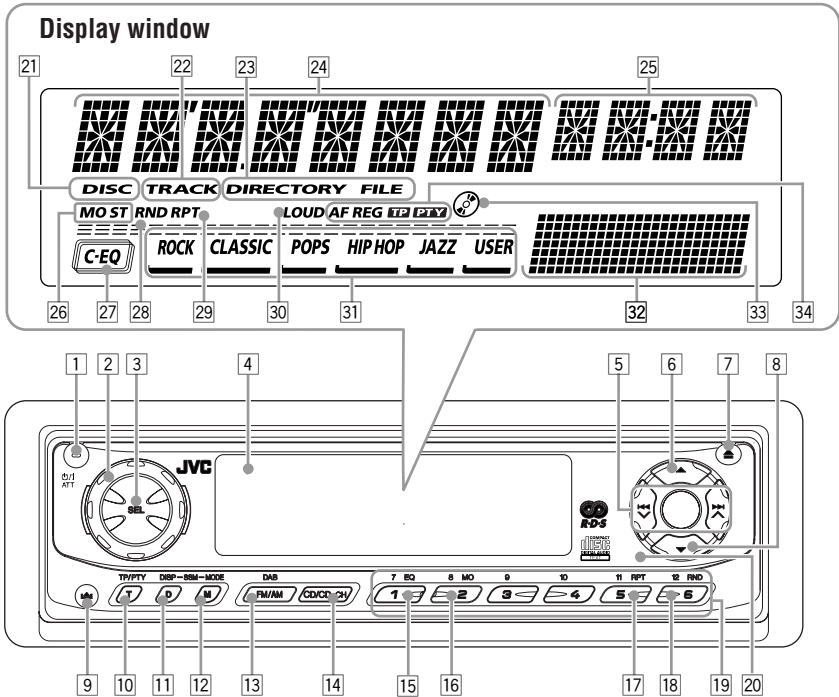

- 1  $\mathcal{P}$ /I ATT (standby/on/attenuator) button
- 2 Control dial
- 3 SEL (select) button
- 4 Display window
- 5  $\leftarrow \rightarrow \uparrow \downarrow$  buttons
- 6  $\uparrow$  (up) button
- 7  $\triangle$  (eject) button
- 8  $\downarrow$  (down) button
- 9  $\square$  (control panel release) button
- 10 TP/PTY (T) (traffic programme/programme type) button
- 11 DISP (D) (display) button
  - Also functions as SSM buttons when pressed together with MODE (M) button.
- 12 MODE (M) button
  - Also functions as SSM buttons when pressed together with DISP (D) (display) button.
- 13 FM/AM DAB button
- 14 CD/CD-CH button
- 15 EQ (equalizer) button
- 16 MO (monaural) button
- 17 RPT (repeat) button
- 18 RND (random) button

- 19 Number buttons
- 20 Remote sensor

### Display window

- 21 DISC indicator
- 22 TRACK indicator
- 23 MP3 indicators (only for KD-LH7R) DIRECTORY, FILE
- 24 Main display
- 25 Source/clock display
- 26 Tuner reception indicators MO (monaural), ST (stereo)
- 27 C-EQ (custom equalizer) indicator
- 28 RND (random) indicator
- 29 RPT (repeat) indicator
- 30 LOUD (loudness) indicator
- 31 Sound mode indicators ROCK, CLASSIC, POPS, HIP HOP, JAZZ, USER.
- 32 Volume (or audio) level indicator Equalization pattern indicator
- 33 CD-in indicator
- 34 RDS indicators AF, REG, TP, PTY



## Preparing the remote controller

This section is only for KD-LH7R.

KD-LH5R can also be remotely controlled with an optionally purchased remote controller. We recommend that you use remote controller RM-RK50 with your unit.

Before using the remote controller:

- Aim the remote controller directly at the remote sensor on the main unit. Make sure there is no obstacle in between.

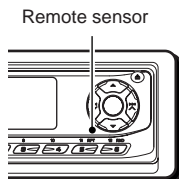

- Do not expose the remote sensor to strong light (direct sunlight or artificial lighting).

### Installing the battery

When the controllable range or effectiveness of the remote controller decreases, replace the battery.

#### 1. Remove the battery holder.

- 1) Push out the battery holder in the direction indicated by the arrow using a ball-point pen or a similar tool.
- 2) Remove the battery holder.

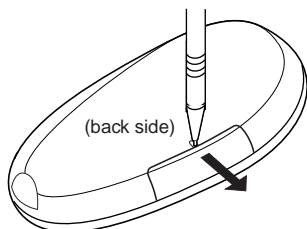

#### 2. Place the battery.

Slide the battery into the holder with the + side facing upwards so that the battery is fixed in the holder.

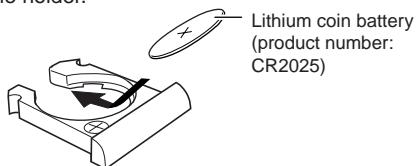

#### 3. Return the battery holder.

Insert again the battery holder pushing it until you hear a clicking sound.

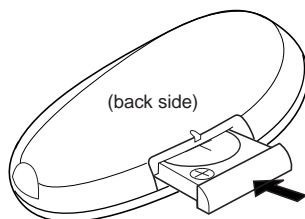

#### WARNING:

- Store the battery in a place where children cannot reach.  
If a child accidentally swallows the battery, consult a doctor immediately.
- Do not recharge, short, disassemble or heat the battery or dispose it in a fire.  
Doing any of these things may cause the battery to give off heat, crack or start a fire.
- Do not leave the battery with other metallic materials.  
Doing this may cause the battery to give off heat, crack or start a fire.
- When throwing away or saving the battery, wrap it in tape and insulate; otherwise, the battery may start to give off heat, crack or start a fire.
- Do not poke the battery with tweezers or similar tools.  
Doing this may cause the battery to give off heat, crack or start a fire.

#### CAUTION:

DO NOT leave the remote controller in a place (such as dashboards) exposed to direct sunlight for a long time. Otherwise, it may be damaged.



## Remote controller

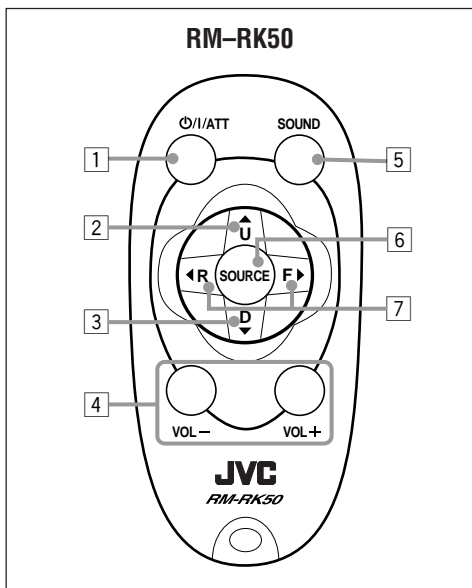

- 1 • Turns on the unit if pressed when the unit is turned off.
  - Turns off the unit if pressed and held until "SEE YOU" appears on the display.
  - Drops the volume level in a moment if pressed briefly.  
Press again to resume the volume.
- 2 • Selects the band while listening to the radio (or the DAB tuner).  
Each time you press the button, the band changes.
  - Skips to the next disc while listening to the CD changer.  
Each time you press the button, the disc number increases, and the selected disc starts playing.
  - Skips to the first file of the next directory while listening to an MP3 disc. Each time you press the button, you can move to the next directory and start playing the first file—not available for KD-LH5R.
- 3 • Selects the preset stations while listening to the radio (or the DAB tuner).  
Each time you press the button, the preset station number increases, and the selected station (or service) is tuned in.
  - Skips to the previous disc while listening to the CD changer.  
Each time you press the button, the disc number decreases, and the selected disc starts playing.
  - Skips to the first file of the previous directory while listening to an MP3 disc. Each time you press the button, you can move to the previous directory and start playing the first file—not available for KD-LH5R.
- 4 Functions the same as the control dial on the main unit.  
**NOTE:** This button does not function for the preferred setting mode adjustment.
- 5 Selects the sound (C-EQ) mode.  
Each time you press the button, the sound (C-EQ) mode changes.
- 6 Selects the source.  
Each time you press the button, the source changes.
- 7 • Searches stations while listening to the radio.
  - Selects services while listening to the DAB tuner if pressed briefly.
  - Searches ensembles while listening to the DAB tuner if pressed for more than 1 second.
  - Fast-forwards or reverses the track/file if pressed and held while listening to a disc.
  - Skips to the beginning of the next track/file or goes back to the beginning of the current (or previous) tracks/files if pressed briefly while listening to a disc.

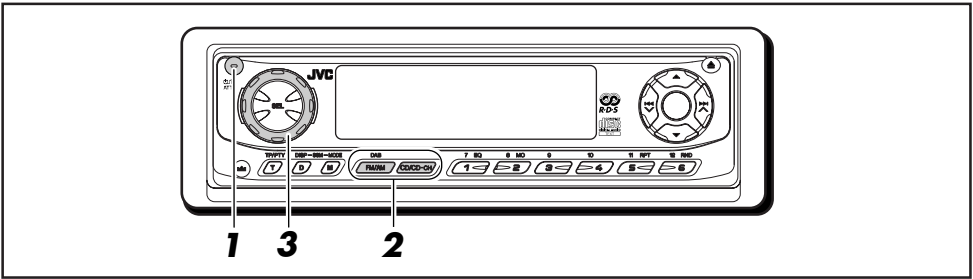

## Turning on the power

### 1 Turn on the power.



"HELLO" appears on the display.

#### Note on One-Touch Operation:

When you select a source in step 2 below, the power automatically comes on. You do not have to press this button to turn on the power.

### 2 Select the source.

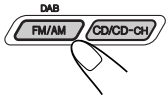

- To operate the tuner (FM or AM), see pages 8 – 18.
- To play a CD, see pages 19 – 22.
- To play an MP3 disc, see pages 23 – 28.
- To operate the CD changer, see pages 38 – 40.
- To operate the external component (LINE IN), see page 41.
- To operate the DAB tuner, see pages 42 – 45.

#### CAUTION on Volume Setting:

Discs produce very little noise compared with other sources. If the volume level is adjusted for the tuner, for example, the speakers may be damaged by the sudden increase in the output level. Therefore, lower the volume before playing a disc and adjust it as required during playback.

### 3 Adjust the volume.

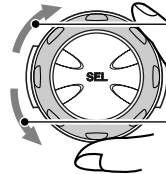

To increase the volume.

To decrease the volume.

Volume level appears

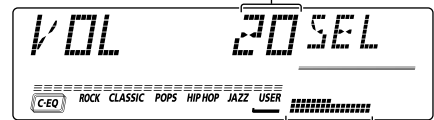

Volume or audio level indicator (see page 34)

### 4 Adjust the sound as you want. (See pages 29 – 31.)

#### To drop the volume in a moment

Press **ATT** briefly while listening to any source. "ATT" starts flashing on the display, and the volume level will drop in a moment.

To resume the previous volume level, press the button briefly again.

- If you turn the control dial, you can also restore the sound.

#### To turn off the power

Press **ATT** for more than one second.

"SEE YOU" appears, then the unit turns off.

- If you turn off the power while listening to a disc, CD play will start from where playback has been stopped previously, next time you turn on the power.

#### Note:

When you use this unit for the first time, set the built-in clock correctly, see page 32.



# RADIO OPERATIONS

ENGLISH

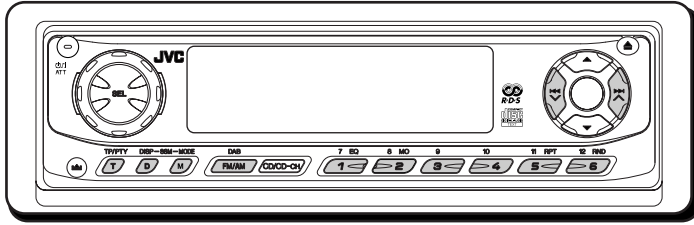

## Listening to the radio

You can use either automatic searching or manual searching to tune in to a particular station.

### Searching a station automatically: Auto search

#### 1 Select the band (FM1 – 3, AM).

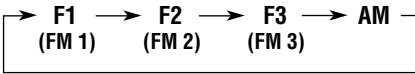
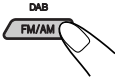

Selected band appears.

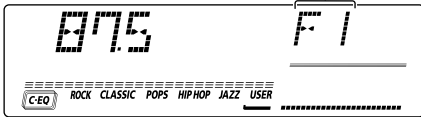

#### Note:

This receiver has three FM bands (FM1, FM2, FM3). You can use any one of them to listen to an FM broadcast.

#### 2 Start searching a station.

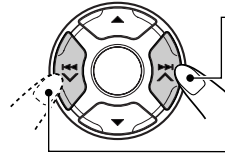

Press **▶▶|▲** to search stations of higher frequencies.

Press **|◀◀▼** to search stations of lower frequencies.

When a station is received, searching stops.

To stop searching before a station is received, press the same button you have pressed for searching.



## Searching a station manually: Manual search

### 1 Select the band (FM1 – 3, AM).

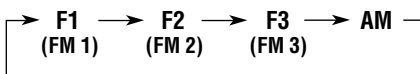
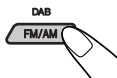

#### Note:

This receiver has three FM bands (FM1, FM2, FM3). You can use any one of them to listen to an FM broadcast.

### 2 Press and hold **▶▶|▲** or **◀◀|▼** until “MANU” (manual) starts flashing on the display.

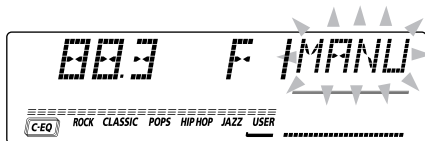

### 3 Tune in to a station you want while “MANU” is flashing.

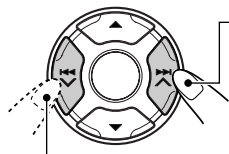

Press **▶▶|▲** to tune in to stations of higher frequencies.

Press **◀◀|▼** to tune in to stations of lower frequencies.

- If you release your finger from the button, the manual mode will automatically turn off after 5 seconds.
- If you hold down the button, the frequency keeps changing (in 50 kHz intervals for FM and 9 kHz intervals for AM – MW/LW) until you release the button.

### When an FM stereo broadcast is hard to receive:



- 1 Press MODE (M) to enter the functions mode while listening to an FM stereo broadcast. “MODE” appears on the upper part of the display, and the number buttons work as different function buttons.

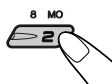

- 2 Press MO (monaural), while “MODE” is still on the display, so that the MO indicator lights up on the display. Then, each time you press MO (monaural), the MO indicator lights up and goes off alternately.

Lights up when receiving an FM broadcast in stereo.

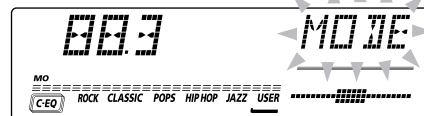
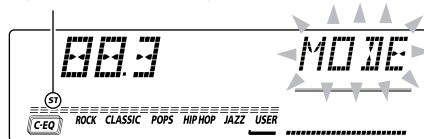

When the MO indicator is lit on the display, the sound you hear becomes monaural but the reception will be improved (the ST indicator goes off).



## Storing stations in memory

You can use one of the following two methods to store broadcasting stations in memory.

- Automatic preset of FM stations: SSM (Strong-station Sequential Memory)
- Manual preset of both FM and AM stations

### FM station automatic preset: SSM

You can preset 6 local FM stations in each FM band (FM1, FM2 and FM3).

- Select the FM band (FM1 – 3, AM) you want to store FM stations into.**

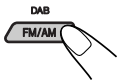

Each time you press the button, the band changes as follows:

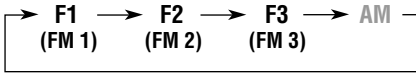

- Press and hold both buttons for more than 2 seconds.**

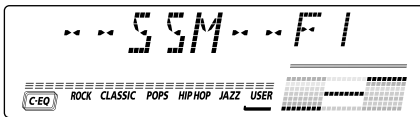

"SSM" appears, then disappears when automatic preset is over.

Local FM stations with the strongest signals are searched and stored automatically in the band number you have selected (FM1, FM2 or FM3). These stations are preset in the number buttons — No.1 (lowest frequency) to No.6 (highest frequency). When automatic preset is over, the station stored in number button 1 will be automatically tuned in.

## Manual preset

You can preset up to 6 stations in each band (FM1, FM2, FM3 and AM) manually.

Ex.: Storing an FM station of 88.3 MHz into the preset number 1 of the FM1 band.

- Select the band (FM1 – 3, AM) you want to store stations into (in this example, FM1).**

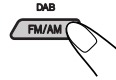

Each time you press the button, the band changes as follows:

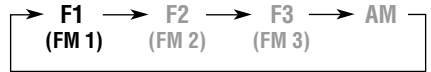

- Tune in to a station (in this example, of 88.3 MHz).**

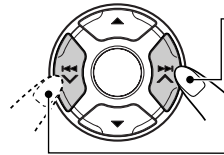

Press ►► ▲ to tune in to stations of higher frequencies.

Press ◀◀ ▼ to tune in to stations of lower frequencies.

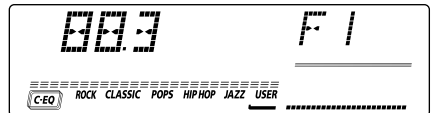

**3** Press and hold the number button (in this example, 1) for more than 2 seconds.

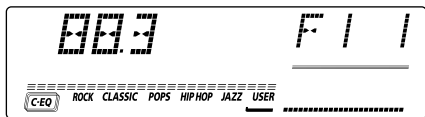
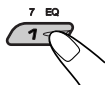

Selected band/preset number and "MEMO" (memory) appear alternately for a while.  $\updownarrow$

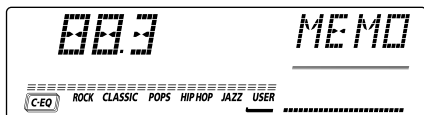

## Tuning in to a preset station

You can easily tune in to a preset station. Remember that you must store stations first. If you have not stored them yet, see "Storing stations in memory" on pages 10 and 11.

**1** Select the band (FM1 – 3, AM).

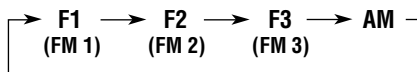
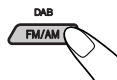

**2** Select the number (1 – 6) for the preset station you want.

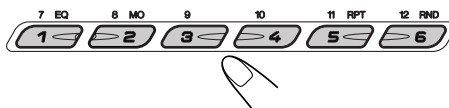

**4** Repeat the above procedure to store other stations into other preset numbers.

### Notes:

- A previously preset station is erased when a new station is stored in the same preset number.
- Preset stations are erased when the power supply to the memory circuit is interrupted (for example, during battery replacement). If this occurs, preset the stations again.



## What you can do with RDS

RDS (Radio Data System) allows FM stations to send an additional signal along with their regular programme signals. For example, the stations send their station names, as well as information about what type of programme they broadcast, such as sports or music, etc.

Another advantage of RDS function is called "Enhanced Other Networks." By using the Enhanced Other Networks data sent from a station, you can tune in to a different station of a different network broadcasting your favourite programme or traffic announcement while listening to another programme or to another source such as CD.

By receiving the RDS data, this unit can do the following:

- Tracing the same programme automatically (Network-Tracking Reception)
- Standby Reception of TA (Traffic Announcement) or your favourite programme
- PTY (Programme Type) search
- Programme search
- And some other functions

### Tracing the same programme automatically (Network-Tracking Reception)

When driving in an area where FM reception is not good, the tuner built in this unit automatically tunes in to another RDS station, broadcasting the same programme with stronger signals. So, you can continue to listen to the same programme in its finest reception, no matter where you drive. (See the illustration on the next page.)

Two types of the RDS data are used to make Network-Tracking Reception work correctly — PI (Programme Identification) and AF (Alternative Frequency).

Without receiving these data correctly from the RDS station you are listening to, Network-Tracking Reception will not operate.

## To use Network-Tracking Reception

You can select the different modes of network-tracking reception to continue listening to the same programme in its finest reception. When shipped from the factory, "AF" is selected.

- **AF:** Network-Tracking Reception is activated with Regionalization set to "off." With this setting, the unit switches to another station within the same network when the receiving signals from the current station become weak. (In this mode, the programme may differ from the one currently received.) The AF indicator lights up but the REG indicator does not.
- **AF REG:** Network-Tracking Reception is activated with Regionalization set to "on." With this setting, the unit switches to another station, within the same network, broadcasting the same programme when the receiving signals from the current station become weak. Both the AF indicator and the REG indicator light up.
- **OFF:** Network-Tracking Reception is deactivated. Neither the AF indicator nor the REG indicator lights up.

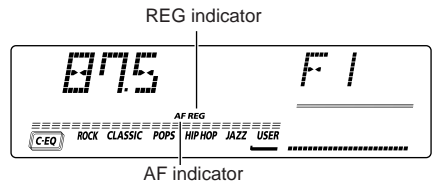

**Note:**

If a DAB tuner is connected and Alternative Reception (for DAB services) is activated, Network-Tracking Reception is also activated ("AF") automatically. On the other hand, Network-Tracking Reception cannot be deactivated without deactivating Alternative Reception. (See page 45.)



- 1** Press and hold SEL (select) for more than 2 seconds so that one of the PSM items appears on the display. (PSM: see page 33.)



- 2** Select “AF-REG (alternative frequency/regionalization reception)” if not shown on the display.



- 3** Select the desired mode – “AF,” “AF REG” or “OFF.”



- 4** Finish the setting.



The same programme can be received on different frequencies.

Programme 1  
broadcasting  
on frequency A

Programme 1  
broadcasting  
on frequency E

Programme 1  
broadcasting  
on frequency B

Programme 1  
broadcasting  
on frequency C

Programme 1  
broadcasting  
on frequency D

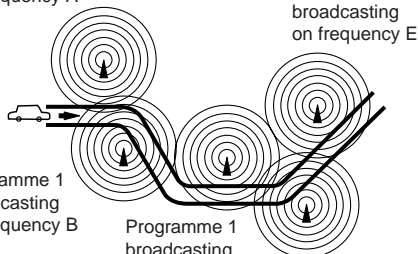

## Using TA Standby Reception

TA Standby Reception allows the unit to switch temporarily to Traffic Announcement (TA) from the current source (another FM station or CD and other connected components).

- TA Standby Reception will not work if you are listening to an AM station.



Press TP/PTY (T) to activate TA Standby Reception.

- When the current source is FM, the TP indicator either lights up or flashes.

- If the TP indicator lights up, TA Standby Reception is activated.

If a station starts broadcasting a traffic announcement, “TRAFFIC” appears on the display, and this unit automatically tunes in to the station. The volume changes to the preset TA volume level (see page 17) and the traffic announcement can be heard.

- If the TP indicator flashes, TA Standby Reception is not yet activated since the station being received does not provide the signals used for TA Standby Reception.

To activate TA Standby Reception, you need to tune in to another station providing these signals. Press ►► ▲ or ◀◀ ▼ to search for such a station.

When a station providing these signals is tuned in, the TP indicator stops flashing and remains lit. Now TA Standby Reception is activated.

- When the current source is other than FM, the TP indicator lights up.

If a station starts broadcasting a traffic announcement, “TRAFFIC” appears on the display, and this unit automatically changes the source and tunes in to the station.

To deactivate the TA Standby Reception, press TP/PTY (T) again.



## Using PTY Standby Reception

PTY Standby Reception allows the unit to switch temporarily to your favourite programme (PTY: Programme Type) from the current source (another FM station, CD or other connected components).

- *PTY Standby Reception will not work if you are listening to an AM station.*

You can select your favourite programme type for PTY Standby Reception.

When shipped from the factory, PTY Standby Reception is turned off. ("OFF" is selected for PTY Standby Reception.)

- 1 Press and hold SEL (select) for more than 2 seconds so that one of the PSM items appears on the display. (PSM: see page 33.)**



- 2 Select "PTY STBY (standby)" if not shown on the display.**



- 3 Select one of the twenty-nine PTY codes. (See page 18.)**

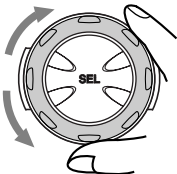

Selected code name appears on the display and is stored into memory.

- To cancel the PTY Standby Reception, select "OFF."

- 4 Finish the setting.**



- **When the current source is FM,** the PTY indicator either lights up or flashes.

- **If the PTY indicator lights up,** PTY Standby Reception is activated. If a station starts broadcasting the selected PTY programme, this unit automatically tunes in to the station.
- **If the PTY indicator flashes,** PTY Standby Reception is not yet activated since the station being received does not provide the signals used for PTY Standby Reception.

To activate PTY Standby Reception, you need to tune in to another station providing these signals. Press **▶▶** **▲** or **◀◀** **▼** to search for such a station. When a station providing these signals is tuned in, the PTY indicator stops flashing and remains lit. Now PTY Standby Reception is activated.

- **When the current source is other than FM,** the PTY indicator lights up.

If a station starts broadcasting the selected PTY programme, this unit automatically changes the source and tunes in to the station.

**To deactivate the PTY Standby Reception,** select "OFF" in step 3 on the left column. The PTY indicator disappears.

## Searching your favourite programme

You can search any one of the PTY codes. In addition, you can store your 6 favourite programme types in the number buttons. When shipped from the factory, the following 6 programme types have been stored in the number buttons (1 to 6).

To store your favourite programme types, see below.

To search your favourite programme type, see page 16.

1	2	3
POP M	ROCK M	EASY M
4	5	6
CLASSICS	AFFAIRS	VARIED

### To store your favourite programme types

- 1 Press and hold TP/PTY (T) for more than 2 seconds while listening to an FM station.

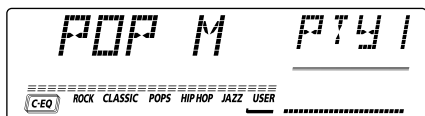

The last selected PTY code appears.

- 2 Select one of the twenty-nine PTY codes. (See page 18.)



Selected code name appears on the display.

- 3 Press and hold the number button for more than 2 seconds to store the PTY code selected into the preset number you want.

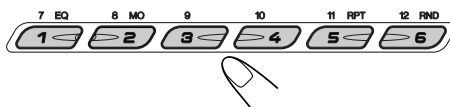

"MEMO" and the selected code name will flash alternately. Then, only the selected code name will continue flashing on the display.

- 4 Press and hold TP/PTY (T) for more than 2 seconds.





## To search your favourite programme type

- 1 Press and hold TP/PTY (T) for more than 2 seconds while listening to an FM station.

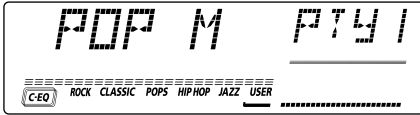

The last selected PTY code appears.

- 2 Select one of the PTY codes.



OR

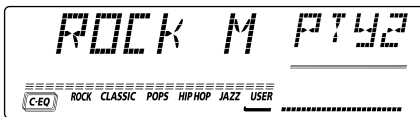
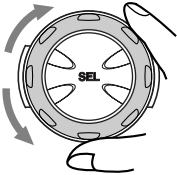

Ex.: When "ROCK M" is selected

- 3 Press ►►| ^ or ◀◀| v to start PTY search for your favourite programme.

- If there is a station broadcasting a programme of the same PTY code as you selected, that station is tuned in.
- If there is no station broadcasting a programme of the same PTY code as you selected, the station will not change.

### Note:

In some areas, the PTY search will not work correctly.

## Other convenient RDS functions and adjustments

### Changing the display mode while listening to an FM station

You can change the initial indication on the display to station name (PS NAME) or station frequency (FREQ) while listening to an FM RDS station.

- See also "Changing the general settings (PSM)" on pages 32 and 33.

- 1 Press and hold SEL (select) for more than 2 seconds so that one of the PSM items appears on the display.
- 2 Press ►►| ^ or ◀◀| v to select "TU DISP (tuner display)."
- 3 Turn the control dial to set to the desired indication ("PS NAME" or "FREQ").
- 4 Press SEL (select) to finish the setting.

### Note:

By pressing DISP (D), you can change the display while listening to an FM RDS station.

Each time you press the button, the following information appears on the display:

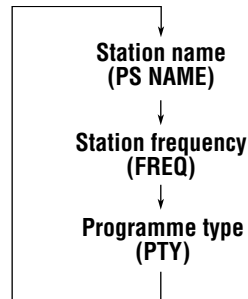

- Then, the display goes back to the original indication in several seconds.





## **Automatic selection of the station when using the number buttons**

Usually when you press the number button, the preset station is tuned in.

However, when the preset station is an RDS station, something different will happen. If the signals from that preset station are not sufficient for good reception, this unit, using the AF data, tunes in to another frequency broadcasting the same programme as the original preset station is broadcasting. (Programme search)

- The unit takes some time to tune in to another station using Programme search.

To activate programme search, follow the procedure below.

- See also “Changing the general settings (PSM)” on pages 32 and 33.

**1** Press and hold SEL (select) for more than 2 seconds so that one of the PSM items appears on the display.

**2** Press ►►| ▲ or |◄◄ ▼ to select “P(Programme)-SEARCH.”

**3** Turn the control dial clockwise to select “ON.”  
Now programme search is activated.

**4** Press SEL (select) to finish the setting.

**To cancel programme search**, repeat the same procedure and select “OFF” in step 3 by turning the control dial counterclockwise.

## **Setting the TA volume level**

You can preset the volume level for TA Standby Reception. When a traffic programme is received, the volume level automatically changes to the preset level.

- See also “Changing the general settings (PSM)” on pages 32 and 33.

**1** Press and hold SEL (select) for more than 2 seconds so that one of the PSM items appears on the display.

**2** Press ►►| ▲ or |◄◄ ▼ to select “TA VOL.”

**3** Turn the control dial to set to the desired volume.  
You can set it from “VOL 00” to “VOL 50.”

**4** Press SEL (select) to finish the setting.

## **Automatic clock adjustment**

When shipped from the factory, the clock built in this unit is set to be readjusted automatically using the CT (Clock Time) data in the RDS signal.

If you do not want to use automatic clock adjustment, follow the procedure below.

- See also “Changing the general settings (PSM)” on pages 32 and 33.

**1** Press and hold SEL (select) for more than 2 seconds so that one of the PSM items appears on the display.

**2** Press ►►| ▲ or |◄◄ ▼ to select “AUTO ADJ.”

**3** Turn the control dial counterclockwise to select “OFF.”

Now automatic clock adjustment is canceled.

**4** Press SEL (select) to finish the setting.

**To reactivate clock adjustment**, repeat the same procedure and select “ON” in step 3 by turning the control dial clockwise.

### ***Note:***

*You must stay tuned to the same station for more than 2 minutes after setting “AUTO ADJ” to “ON.” Otherwise, the clock time will not be adjusted. (This is because the unit takes up to 2 minutes to capture the CT data in the RDS signal.)*

**PTY codes**

<b>NEWS:</b>	News	<b>SOCIAL:</b>	Programmes on social activities
<b>AFFAIRS:</b>	Topical programmes expanding on current news or affairs	<b>RELIGION:</b>	Programmes dealing with any aspect of belief or faith, or the nature of existence or ethics
<b>INFO:</b>	Programmes which impart advice on a wide variety of topics	<b>PHONE IN:</b>	Programmes where people can express their views either by phone or in a public forum
<b>SPORT:</b>	Sport events	<b>TRAVEL:</b>	Programmes about travel destinations, package tours, and travel ideas and opportunities
<b>EDUCATE:</b>	Educational programmes	<b>LEISURE:</b>	Programmes concerned with recreational activities such as gardening, cooking, fishing, etc.
<b>DRAMA:</b>	Radio plays	<b>JAZZ:</b>	Jazz music
<b>CULTURE:</b>	Programmes on national or regional culture	<b>COUNTRY:</b>	Country music
<b>SCIENCE:</b>	Programmes on natural science and technology	<b>NATION M:</b>	Current popular music from another nation or region, in that country's language
<b>VARIED:</b>	Other programmes like comedies or ceremonies	<b>OLDIES:</b>	Classic pop music
<b>POP M:</b>	Pop music	<b>FOLK M:</b>	Folk music
<b>ROCK M:</b>	Rock music	<b>DOCUMENT:</b>	Programmes dealing with factual matters, presented in an investigative style
<b>EASY M:</b>	Easy-listening music		
<b>LIGHT M:</b>	Light music		
<b>CLASSICS:</b>	Classical music		
<b>OTHER M:</b>	Other music		
<b>WEATHER:</b>	Weather information		
<b>FINANCE:</b>	Reports on commerce, trading, the Stock Market, etc.		
<b>CHILDREN:</b>	Entertainment programmes for children		

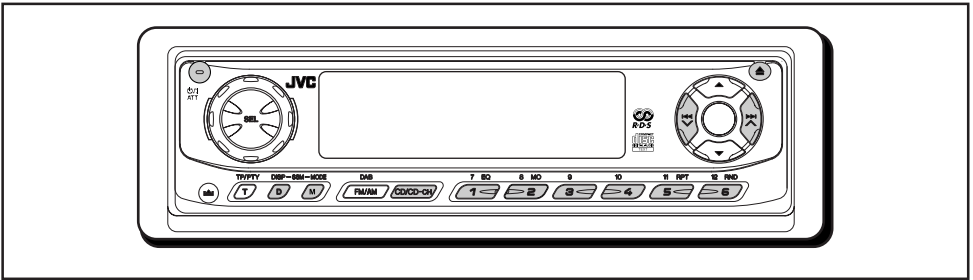

## Playing a CD

**1** Open the control panel.

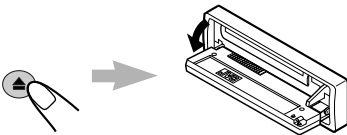

**2** Insert a disc into the loading slot.

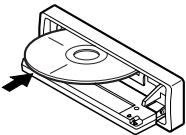

The unit turns on, draws a disc and starts playback automatically.

**3** Close the control panel by hand.

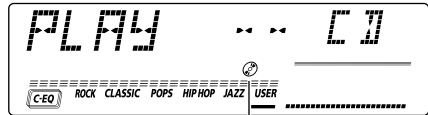
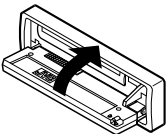

The CD-in indicator lights up.

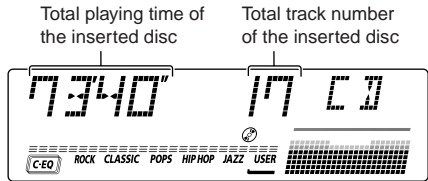

Total playing time of the inserted disc

Total track number of the inserted disc

Source indication will change to the clock time if "CLOCK" is set to "ON." (See page 34)

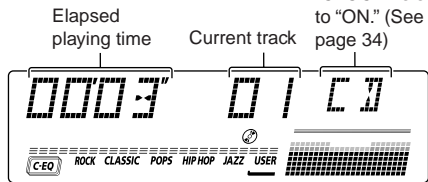

Elapsed playing time

Current track

### Notes:

- When a disc is already in the loading slot, selecting "CD" as the source starts CD play.
- When a disc is inserted upside down, the disc automatically ejects (if the control panel is open). If the control panel is closed, "PLEASE" and "EJECT" appear alternately.
- If you change the source, CD play also stops (without ejecting the disc). Next time you select "CD" as the source, CD play starts from where playback has been stopped previously.



## To stop play and eject the disc

Press **▲**.  
CD play stops, the control panel opens, then the disc automatically ejects from the loading slot. If you change the source, the CD play also stops (without ejecting the disc this time).

### Notes:

- If the ejected disc is not removed for about 15 seconds, the disc is automatically inserted again into the loading slot to protect it from dust. (CD play will not start this time.)
- You can eject the disc even when the unit is turned off.

## Locating a track or a particular portion on a CD

### To fast-forward or reverse the track

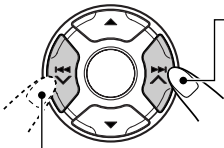

Press and hold **▶▶|▲**, while playing a disc, to fast-forward the track.

Press and hold **◀◀|▼**, while playing a disc, to reverse the track.

### To go to the next or previous tracks

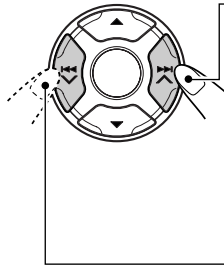

Press **▶▶|▲** briefly, while playing a disc, to go ahead to the beginning of the next track.

Each time you press the button consecutively, the beginning of the next tracks is located and played back.

Press **◀◀|▼** briefly, while playing a disc, to go back to the beginning of the current track.

Each time you press the button consecutively, the beginning of the previous tracks is located and played back.

### To go to a particular track directly

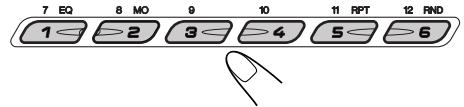

Press the number button corresponding to the track number to start its playback.

- To select a track number from 1 – 6:  
Press 1 (7) – 6 (12) briefly.
- To select a track number from 7 – 12:  
Press and hold 1 (7) – 6 (12) for more than 1 second.



# Selecting CD playback modes

## To play back tracks at random (Random Play)

You can play back all tracks on the disc at random.



1 Press MODE (M) to enter the functions mode while playing a disc. "MODE" appears on the upper part of the display, and the number buttons work as different function buttons.

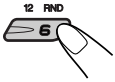

2 Press RND (random), while "MODE" is still on the display, so that the RND indicator lights up on the display. Then, each time you press RND (random), the random play mode turns on and off alternately.

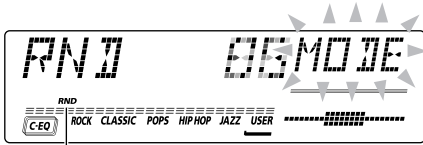

RND indicator

When the random mode is turned on, the RND indicator lights up on the display and a track randomly selected starts playing.

## To play back tracks repeatedly (Repeat Play)

You can play back the current track repeatedly.



1 Press MODE (M) to enter the functions mode while playing a disc. "MODE" appears on the upper part of the display, and the number buttons work as different function buttons.

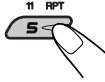

2 Press RPT (repeat), while "MODE" is still on the display, so that the RPT indicator lights up on the display. Then, each time you press RPT (repeat), the repeat play mode turns on and off alternately.

Track number of the currently playing track

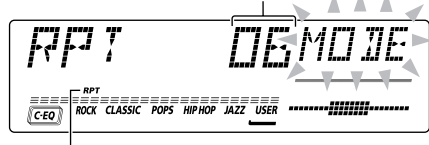

RPT indicator

When the repeat mode is turned on, the RPT indicator lights up on the display.



## Prohibiting CD ejection

You can prohibit CD ejection and can lock a disc in the loading slot.

While pressing CD/CD-CH, press and hold  $\odot$ /I ATT for more than 2 seconds.



“NO EJECT” flashes on the display for about 5 seconds, and the disc is locked and cannot be ejected.

To cancel the prohibition and unlock the disc, press  $\odot$ /I ATT again for more than 2 seconds, while pressing CD/CD-CH.

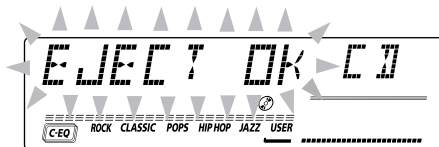

“EJECT OK” flashes on the display for about 5 seconds, and the disc is unlocked.

## Playing a CD Text

In a CD Text, some information about the disc (its disc title, performer and track title) is recorded. You can show these disc information on the display.

Select text display mode while playing a CD Text.



Each time you press the button, the display changes as follows:



### Notes:

- When the disc title/performer is shown, the DISC indicator lights up.  
When the track title is shown, the TRACK indicator lights up.
- The display shows up to 8 characters at one time and scrolls if there are more than 8 characters. Some characters or symbols will not be shown (and be blanked) on the display.  
(Ex. “ABC&!d#” ⇒ “ABCA D ”)
- When you press DISP (D) while playing a conventional CD, “NO NAME” appears for the disc title/performer and the track title.

# MP3 INTRODUCTION

This chapter is only for KD-LH7R.

## What is MP3?

MP3 is an abbreviation of Motion Picture Experts Group (or MPEG) Audio Layer 3\*. MP3 is simply a file format with a data compression ratio of 1:10 (128 Kbps\*\*). That means, by using MP3 format, one CD-R or CD-RW can contain 10 times as much data volume as a regular CD can.

- \* This player is not compatible with the data encoded with Layer 1 and 2 formats.
- \*\* Bit rate is the average number of bits that one second of audio data will consume. The unit used is Kbps (1000 bits/second). To get a better audio quality, choose a higher bit rate. The most popular bit rate for encoding is 128 Kbps.

This unit is incorporated with an MP3 decoder. You can play back MP3 files (tracks) recorded on CD-Rs, CD-RWs, and CD-ROMs.

## Compatible with ID3v1

Extra information data such as album title, performer name, song title, recording year, music genre and a brief comment can be stored within an MP3 file.

This unit can show ID3v1 tags (album name, performer name and song title) on the display. (See page 36.)

- Some characters cannot be shown correctly.
- This unit is not compatible with ID3v2.

### Other Main Features in this unit:

- Maximum number of directories/files: 289 (Total)
- Available characters for directory/file names: A–Z, 0–9, \_ (underscore)
- Maximum number of characters for file name (ISO 9660 Level 1): 12 (inclusive of separation mark—“.” and extension code—“mp3”) (ISO 9660 Level 2): 31 (inclusive of separation mark—“.” and extension code—“mp3”) (Joliet): 64 (inclusive of separation mark—“.” and extension code—“mp3”)
- Maximum number of characters for directory name: 64

## Precautions when recording MP3 files on a CD-R or CD-RW

This unit can only read MP3 files that are recorded in the format that is compliant with ISO 9660 Level 1, Level 2 or Joliet.

## How are MP3 files recorded and played back?

MP3 “files (tracks)” can be recorded in “directories (folders)”—in PC terminology. During recording, the files and directories can be arranged in a way similar to arranging files and directories/folders of computer data. “Root” is similar to the root of a tree. Every file and directory can be linked to and be accessed from the root.

Playback order, file search order, and directory search order of the MP3 files recorded on a disc are determined by the writing (or encoding) application; therefore, playback order may be different from the one you have intended while recording the directories and the files.

The illustration on the next page shows an example of how MP3 files are recorded on a CD-R or CD-RW, how they are played back, and how they are searched on this unit.

### Notes:

- The unit can read a CD-ROM containing MP3 files. However, if non-MP3 files are recorded together with MP3 files, this unit will take a longer time to scan the disc. It may also cause the unit to malfunction.
- The unit cannot read or play an MP3 file without the extension code—mp3.
- The unit is not compatible with Playlist\*.

\* A playlist is a simple text file, used on a PC, which enables users to make their own playback order without physically rearranging the files.

## MP3 directory/file configuration

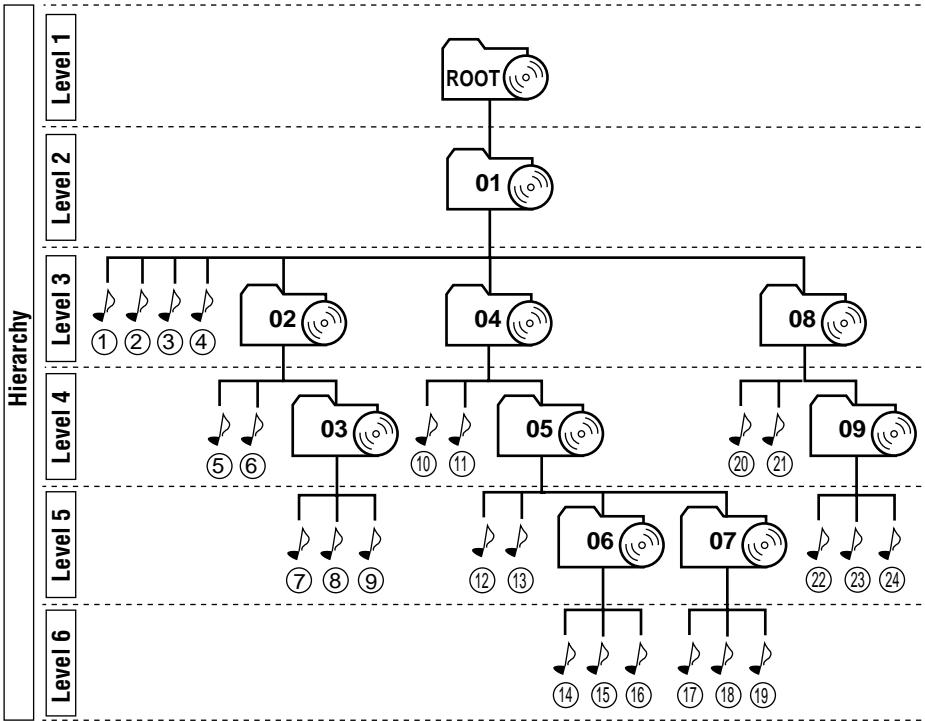

	: Root
	: Directories
	: MP3 files

### Note:

There is no limit to the number of hierarchy levels (nested directories). However, up to 8 hierarchy levels is recommended for stable operations.

## MP3 playback/search order

- The numbers in circles below the MP3 files (🎵) indicate the playback order and search order of the MP3 files. Normally this unit plays back MP3 files in the recorded order.
- The numbers inside the directories indicate the playback order and search order of the directories on an MP3 disc. Normally this unit plays back MP3 files in the directories in the recorded order.



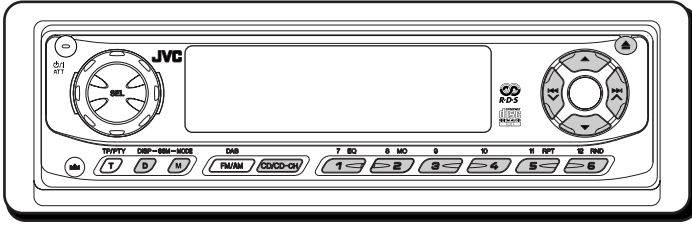

This chapter is only for KD-LH7R.

Refer also to "CD OPERATIONS" on pages 19 to 22.

## Playing an MP3 disc

**1** Open the control panel.

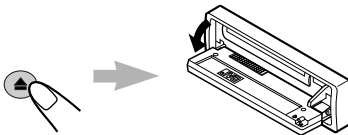

**2** Insert an MP3 disc into the loading slot.

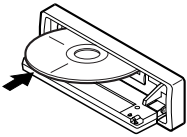

The unit draws the disc. Playback starts automatically from the first file of the first directory once disc scan is complete.

**3** Close the control panel by hand.

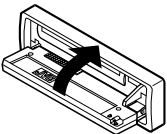

The display changes to show the following:

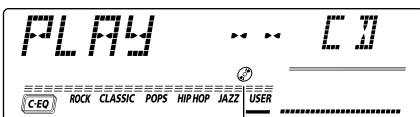

CD-in indicator lights up.



CD-in indicator lights up.



Ex.: When the disc contains 13 directories and 125 MP3 files.

### Notes:

- All the files on the disc will be played repeatedly until you stop playback—All File Repeat Play.
- MP3 discs require a longer readout time. (It differs due to the complexity of the directory/file configuration.)
- If you change the source or turn the power off, MP3 playback stops (without ejecting the disc). Next time you select disc play as the source or turn the power on, MP3 playback starts from where playback has been stopped previously.

## To change the display information



While playing back an MP3 file, you can change the file information shown on the display. Each time you press DISP (D), the display changes to show the following:

- When “TAG DISP” is set to “TAG ON” (initial setting: see page 36)

Album name/performer (directory name\*)

Track title (file name\*)

Elapsed playing time (with track No.)

\* If an MP3 file does not have ID3 tags, directory name and file name appear.

- When “TAG DISP” is set to “TAG OFF”

Directory name

File name

Elapsed playing time (with track No.)

### Note:

The display shows up to 8 characters at one time and scrolls if there are more than 8 characters. See also “To select the scroll mode – SCROLL” on page 35.

## To stop play and eject the disc

Press ▲.

Playback stops, the control panel moves down, and the disc automatically ejects from the loading slot.

## Locating a file or particular portion on an MP3 disc

### To fast-forward or reverse the file

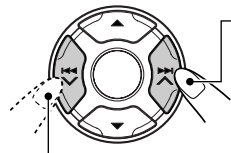

Press and hold ►►► ▲ while playing an MP3 disc, to fast-forward the file.

Press and hold ◀◀◀ ▼ while playing an MP3 disc, to reverse the file.

### Note:

During this operation, you can only hear intermittent sounds. (The elapsed playing time also changes intermittently on the display.)

### To skip to the next or previous files

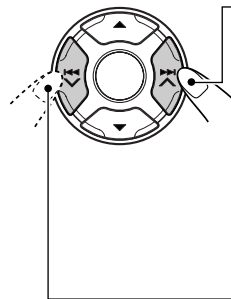

Press ►►► ▲ briefly while playing, to skip ahead to the beginning of the next file. Each time you press the button consecutively, the beginning of the next files is located and played back. (See “MP3 playback/search order” on page 24.)

Press ◀◀◀ ▼ briefly, while playing, to skip back to the beginning of the current file. Each time you press the button consecutively, the beginning of the previous files is located and played back. (See “MP3 playback/search order” on page 24.)



## To go to a particular directory directly

### IMPORTANT:

To directly select the directories using the number button(s), it is required that directories are assigned 2 digit numbers at the beginning of their directory names. (This can only be done during the recording of CD-Rs or CD-RWs.)

Ex.: If directory name is "01 ABC"

→ press 1 to go to Directory 01 ABC.

If directory name is "1 ABC,"  
pressing 1 does not work.

If directory name is "12 ABC"

→ press and hold 6 (12) to go to  
Directory 12 ABC.

Press the number button corresponding to the directory number to start playing the first file in the selected directory.

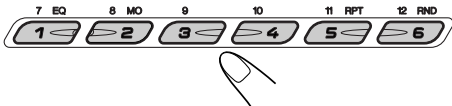

- To select a directory number from 01 – 06:  
Press 1 (7) – 6 (12) briefly.
- To select a directory number from 07 – 12:  
Press and hold 1 (7) – 6 (12) for more than 1 second.

### Notes:

- If "MP3" flashes on the display after you have selected a directory, it means that the directory does not contain any MP3 files.
- You cannot directly select a directory with a number greater than 12.

**To select a particular file in a directory,** press ►►| ▲ or |◄◄ ▼ after selecting the directory.

## To skip to the next directory

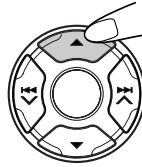

Press ▲ (up) briefly while playing an MP3 disc. Each time you press the button consecutively, the next directory is located (and the first file in the directory starts playing, if recorded).

### Note:

*If the directory does not contain any MP3 files, it is skipped.*

## To skip to the previous directory

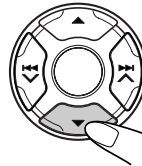

Press ▼ (down) briefly while playing an MP3 disc. Each time you press the button consecutively, the previous directory is located (and the first file in the directory starts playing, if recorded).

### Note:

*If the directory does not contain any MP3 files, it is skipped.*



## Selecting MP3 playback modes

### To play back files at random (Random Play)

You can play back all files on the MP3 disc at random.

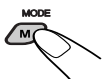

- 1 Press MODE (M) while playing an MP3 disc. The unit enters the functions mode.

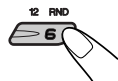

- 2 Press RND (random), while "MODE" is still on the display, so that the RND indicator lights up on the display. Then, each time you press RND (random), the random play mode changes as follows:

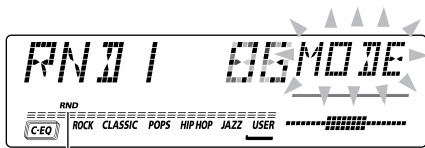

RND indicator

Mode	RND Indicator	Plays at random
RND1	Lights	All files of the current directory.
RND2	Flashes	All files on the disc.

### To play back files repeatedly (Repeat Play)

You can play back the current file or all the files in the current directory repeatedly.

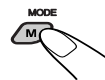

- 1 Press MODE (M) while playing an MP3 disc. The unit enters the functions mode.

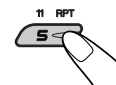

- 2 Press RPT (repeat), while "MODE" is still on the display, so that the RPT indicator lights up on the display. Then, each time you press RPT (repeat), the repeat play mode changes as follows:



Track number of the currently playing track

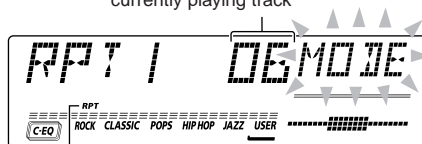

RPT indicator

Mode	RPT Indicator	Plays repeatedly
RPT1	Lights	The current file (or specified file).
RPT2	Flashes	All files of the current directory (or specified directory).



## Adjusting the sound

You can adjust the sound characteristics to your preference.

### 1 Select the item you want to adjust.



Each time you press the button, the adjustable items change as follows:

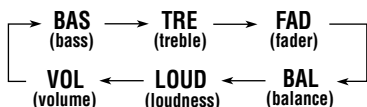

### 2 Adjust the level.

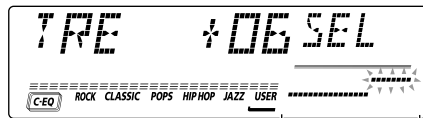
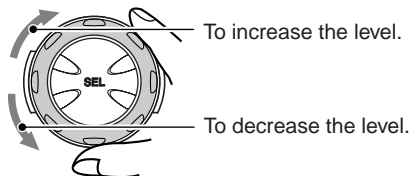

Equalization pattern changes as you adjust the bass or treble.

Indication	To do:	Range
BAS	Adjust the bass.	-06 (min.)   +06 (max.)
TRE	Adjust the treble.	-06 (min.)   +06 (max.)
FAD*	Adjust the front and rear speaker balance.	R06 (Rear only)   F06 (Front only)
BAL	Adjust the left and right speaker balance.	L06 (Left only)   R06 (Right only)
LOUD	Boost low and high frequencies to produce a well-balanced sound at low volume level.	LOUD ON   LOUD OFF
VOL	Adjust the volume.	00 (min.)   50 (max.)

#### Note:

Normally, the control dial works as the volume control. So you do not have to select "VOL" to adjust the volume level.

\* If you are using a two-speaker system, set the fader level to "00."



# Selecting preset sound modes (C-EQ: custom equalizer)

You can select a preset sound mode (C-EQ: custom equalizer) suitable to the music genre.

- There is a time limit in doing the following procedure. If the setting is canceled before you finish, start from step 1 again.

## 1 Press MODE (M).



“MODE” appears on the upper part of the display, and the number buttons work as different function buttons.

## 2 Press EQ (equalizer) while “MODE” is still on the display.

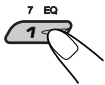

The last selected sound mode is recalled and applied to the current source.

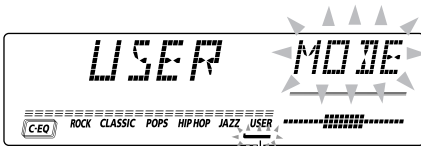

Sound mode indicator flashes.

Ex.: If you have selected “USER” previously

## 3 Select the sound mode you want.

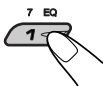

Each time you press the button, the sound modes change as follows:

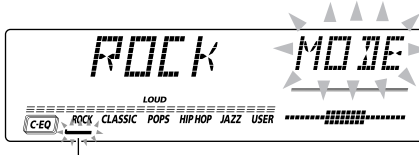

Sound mode indicator flashes.

Ex.: When you select “ROCK”

Indication	For:	Preset values		
		BAS	TRE	LOUD
USER	(Flat sound)	00	00	OFF
ROCK	Rock or disco music	+03	+01	ON
CLASSIC	Classical music	+01	-02	OFF
POPS	Light music	+04	+01	OFF
HIP HOP	Funk or Rap music	+02	00	ON
JAZZ	Jazz music	+02	+03	OFF

### Note:

You can adjust each sound mode to your preference, and store it in memory.

If you want to adjust and store your original sound mode, see “Storing your own sound adjustments” on page 31.

## To store a sound mode separately for each playback source (C-EQ Link)

You can select a sound mode and store it in memory. It will be recalled every time you select the same source and will be shown on the display. A sound mode can be stored for each of the following sources — FM1, FM2, FM3, AM, CD and external components.

- See also “Changing the general settings (PSM)” on page 32 and 33.

- 1 Press and hold SEL (select) for more than 2 seconds so that one of the PSM items appears on the display.
- 2 Press ►►| ▲ or |◄◄ ▼ to select “CEQ LINK (custom equalizer link).”
- 3 Turn the control dial clockwise to select “LINK ON.”
- 4 Press SEL (select) to finish the setting.

To cancel C-EQ Link, repeat the same procedure and select “LINK OFF” in step 3.

### Note:

When the “CEQ LINK” setting is changed, sound mode (C-EQ) is automatically reset to “USER.”



- When “CEQ LINK” is set to “LINK ON”  
The selected sound mode can be stored in memory for the current source. Each time you change to the same source, the same sound mode is also recalled and shown on the display. The C-EQ indicator also flashes.
- When “CEQ LINK” is set to “LINK OFF”  
The selected sound mode effect applies to any source.

## Storing your own sound adjustments

You can adjust the sound modes to your preference and store your own adjustments in memory.

- There is a time limit in doing the following procedure. If the setting is canceled before you finish, start from step 1 again.

### 1 Press MODE (M).



“MODE” appears on the upper part of the display, and the number buttons work as different function buttons.

### 2 Press EQ (equalizer) while “MODE” still on the display.

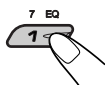

The last selected sound mode is recalled and applied to the current source.

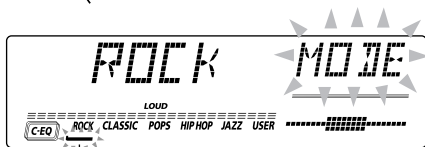

Sound mode indicator flashes.

Ex.: If you have selected “ROCK” previously

### 3 Select the sound mode you want to adjust.

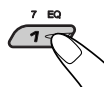

### 4 Select the item you want to adjust.

• See page 29 for details.



### 5 Adjust the level.

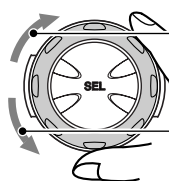

To increase the level.

To decrease the level.

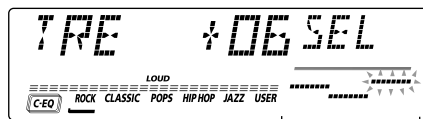

Equalization pattern changes as you adjust the bass or treble.

Ex.: When you adjust “TRE”

### 6 Repeat steps 4 and 5 to adjust the other items.

### 7 Repeat the same procedure to store other sound modes.

To reset to the factory settings, repeat the same procedure and reassign the preset values listed in the table on page 30.

## Setting the clock

- 1 Press and hold SEL (select) for more than 2 seconds so that one of the PSM items appears on the display. (See page 33.)



- 2 Set the hour.

- 1 Select "CLOCK H (hour)" if not shown on the display.
- 2 Adjust the hour.

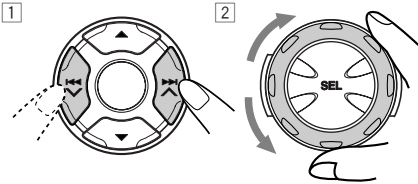

- 3 Set the minute.

- 1 Select "CLOCK M (minute)".
- 2 Adjust the minute.

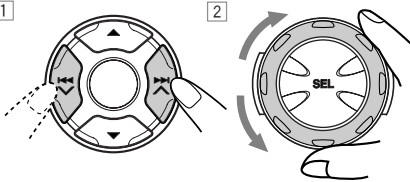

- 4 Set the clock system.

- 1 Select "24H/12H."
- 2 Select "24H" or "12H."

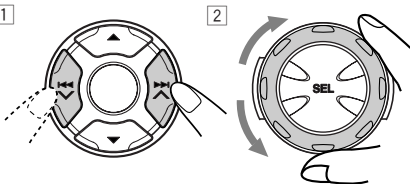

- 5 Finish the setting.



To check other information during play, press DISP (D).

Each time you press the button, the other information (either the clock or the source name) will be shown on the upper part of the display for a while.

- Pressing DISP (D) with the unit turned off will show the clock time for about 5 seconds.

## Changing the general settings (PSM)

You can change the items listed on the next page by using the PSM (Preferred Setting Mode) control.

### Basic Procedure

- 1 Press and hold SEL (select) for more than 2 seconds so that one of the PSM items appears on the display. (See page 33.)



- 2 Select the PSM item you want to adjust. (See page 33.)

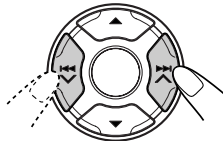

- 3 Adjust the PSM item selected.







- 4** Repeat steps 2 and 3 to adjust the other PSM items if necessary. **5** Finish the setting.

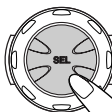
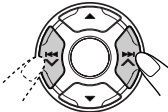

**Preferred Setting Mode (PSM) items**

<b>1</b>  Hold.	<b>2</b>  Select.	<b>3</b>  Set. Counter-clockwise      Clockwise		Factory-preset settings	See page
<b>CLOCK H</b>	Hour adjustment	Back	Advance	0:00	32
<b>CLOCK M</b>	Minute adjustment	Back	Advance		
<b>CEQ LINK</b>	Custom equalizer link	LINK OFF	LINK ON	LINK OFF	30, 34
<b>24H/12H</b>	24/12-hour time display	12H	24H	24H	32
<b>AUTO ADJ</b>	Automatic clock setting	OFF	ON	ON	17
<b>CLOCK</b>	Clock display	OFF	ON	ON	34
<b>TU DISP</b>	Tuner display	FREQ	PS NAME	PS NAME	16
<b>AF-REG</b>	Alternate frequency/ Regionalization reception	AF	AF REG	AF	12
<b>PTY STBY</b>	PTY standby	OFF → 29 programme types (see page 18)		OFF	14
<b>TA VOL</b>	Traffic announcement volume	VOL 00 — VOL 50		VOL 20	17
<b>P-SEARCH</b>	Programme search	OFF	ON	OFF	17
<b>DAB AF**</b>	Alternate frequency search	AF OFF	AF ON	AF ON	45
<b>DAB VOL**</b>	DAB volume adjustment	DAB VOL -12 to DAB VOL 12		DAB VOL 00	45
<b>LEVEL</b>	Level indicator	OFF	AUDIO 1	AUDIO 2	34
<b>DIMMER***</b>	Dimmer mode	AUTO	OFF	AUTO	34
<b>TEL</b>	Telephone muting	OFF	MUTING 1	OFF	34
<b>BEEP</b>	Key-touch tone	OFF	ON	ON	35
<b>SCROLL</b>	Scroll mode	ONCE	AUTO	ONCE	35
<b>EXT IN****</b>	External component	CHANGER	LINE IN	CHANGER	35
<b>TAG DISP***</b>	Tag display	TAG OFF	TAG ON	TAG ON	35

• Press SEL (select) to finish the setting.

\* Displayed only when "DAB AF" is set to "AF OFF".

\*\* Displayed only when the DAB tuner is connected.

\*\*\* Only for KD-LH7R.

\*\*\*\* Displayed only when one of the following sources is selected – FM, AM and CD.

### To set Custom Equalizer Link – CEQ LINK

A different sound mode (C-EQ) can be stored in memory for each source so that you can change the sound modes simply by changing the sources. When shipped from the factory, this mode is deactivated.

- LINK ON: Different sound modes for different sources.
- LINK OFF: One sound mode for all sources.

### To set the clock display – CLOCK

You can set the clock to be shown on the display when the unit is turned on. When shipped from the factory, the clock is set to be shown on the display.

- ON: Clock display is turned on.
- OFF: Clock display is turned off. When "OFF" is selected, the current source name or station band appears instead of the clock display (except when "LINE IN" is selected as the source).

### To select the level meter – LEVEL

You can select the level display according to your preference. When shipped from the factory, "AUDIO 2" is selected.

- AUDIO 1: Level meter illuminates from bottom to top.
- AUDIO 2: Alternates level meter (moves from bottom to top) and illumination display.
- OFF: Erases the audio level indicator.

### To select the dimmer mode – DIMMER (only for KD-LH7R)

When you turn on the car head lights, the display automatically dims (Auto Dimmer). When shipped from the factory, Auto Dimmer mode is activated.

- AUTO: Activates Auto Dimmer.
- OFF: Cancels Auto Dimmer.
- ON: Always dims the display.

**Note:**

*Auto Dimmer equipped with this unit may not work correctly on some vehicles, particularly on those having a control dial for dimming. In this case, set the dimmer mode to "ON" or "OFF."*

### To select the telephone muting – TEL

This mode is used when a cellular phone system is connected. Depending on the phone system used, select either "MUTING 1" or "MUTING 2," whichever mutes the sounds from this unit. When shipped from the factory, this mode is deactivated.

- MUTING 1: Select this if this setting can mute the sounds.
- MUTING 2: Select this if this setting can mute the sounds.
- OFF: Cancels the telephone muting.

### To turn on/off the key-touch tone – BEEP

You can deactivate the key-touch tone if you do not want it to beep each time you press a button. When shipped from the factory, the key-touch tone is activated.

- ON: Activates the key-touch tone.
- OFF: Deactivates the key-touch tone.

### To select the scroll mode – SCROLL

You can select the scroll mode for the disc information if it consists of more than 8 characters. When shipped from the factory, Auto Scroll mode is set to "ONCE."

- ONCE: Scrolls only once.
- AUTO: Repeats the scroll (in 5-second intervals).
- OFF: Cancels Auto Scroll.

### To select the external component to use – EXT IN

You can connect the external component to the CD changer jack on the rear using the Line Input Adaptor KS-U57 (not supplied).

To use the external component as the playback source through this unit, you need to select which component – CD changer or external component – to use.

When shipped from the factory, CD changer is selected as the external component.

- LINE IN: To use the external component other than CD changer.
- CHANGER: To use the CD changer.

**Note:**

*For connecting the Line Input Adaptor KS-U57 and the external component, refer to the Installation/Connection Manual (separate volume).*

### To turn the tag display on or off – TAG DISP (only for KD-LH7R)

An MP3 file can contain file information called "ID3 Tag" where its album name, performer, track title, etc. are recorded.

There are two versions—ID3v1 (ID3 Tag version 1) and ID3v2 (ID3 Tag version 2). This unit is compatible only with ID3v1.

When shipped from the factory, "TAG ON" is selected.

- TAG ON: Turns on the ID3 tag display while playing MP3 files.  
\* If an MP3 file does not have ID3 tags, directory name and file name appear.

**Note:**

*If you change the setting from "TAG OFF" to "TAG ON" while playing an MP3 file, the tag display will be activated when the next file starts playing.*

- TAG OFF: Turns off the ID3 tag display while playing MP3 files. (Only the directory name and file name can be shown.)

# Assigning names to the sources

This section is only for KD-LH7R.

You can assign names to discs (both in this unit and in the CD changer).  
 After assigning a name, it will appear on the display when you select the source.

Sources	Maximum number of characters
CDs*	up to 32 characters (up to 40 discs)

\* You cannot assign a name to a CD Text or an MP3 disc.

**1** Select a source you want to assign a name to.



When you select a source, the power automatically comes on.

**2** Press and hold SEL (select) for more than 2 seconds while pressing DISP (D).

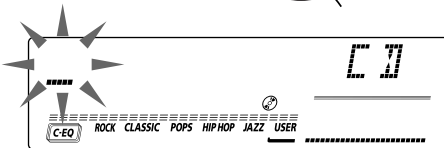

Ex.: When you select CD as the source

**3** Select a character.



• See next column for available characters.

**4** Move the cursor to the next (or previous) character position.



**5** Repeat steps 3 and 4 until you finish inputting the name.

**6** Finish the procedure while the last selected character is flashing.



## To erase the input characters

Insert spaces using the same procedure described above.

## Available characters

A	B	C	D	E	F	G	H	I	J
K	L	M	N	O	P	Q	R	S	T
U	V	W	X	Y	Z	0	1	2	3
4	5	6	7	8	9	-	/	<	>
space									

### Notes:

- When you try to assign a name to the 41st disc, "NAME FULL" appears on the display. (In this case, delete unwanted names before assignment.)
- When the CD changer is connected, you can assign names to CDs in the CD changer. These names can also be shown on the display if you insert the CDs in this unit.
- These characters are also used while showing ID3 tags of the MP3 disc.  
 Some characters or symbols will not be shown (and be blanked) on the display.  
 (Ex. "ABC&!d#" ⇒ "ABCA D ")

## Detaching the control panel

You can detach the control panel when leaving the car.

When detaching or attaching the control panel, be careful not to damage the connectors on the back of the control panel and on the panel holder.

### Detaching the control panel

Before detaching the control panel, be sure to turn off the power.

#### 1 Unlock the control panel.

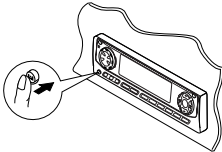

#### 2 Pull the control panel out of the unit.

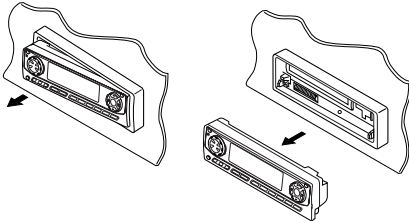

#### 3 Put the detached control panel into the provided case.

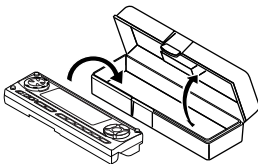

## Attaching the control panel

#### 1 Insert the right side of the control panel into the groove on the panel holder.

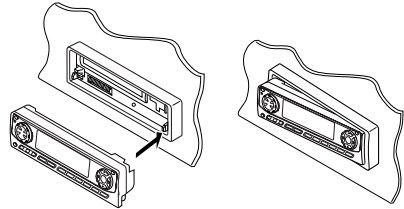

#### 2 Press the left side of the control panel to fix it to the panel holder.

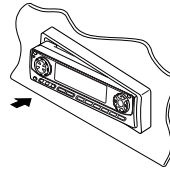

#### Note on cleaning the connectors:

If you frequently detach the control panel, the connectors will deteriorate.

To minimize this possibility, periodically wipe the connectors with a cotton swab or cloth moistened with alcohol, being careful not to damage the connectors.

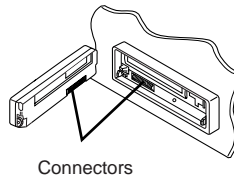



# CD CHANGER OPERATIONS

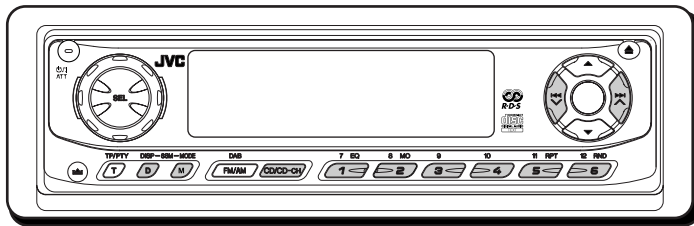

We recommend that you use one of the CH-X series with your unit.

If you have another CD automatic changer, consult your JVC car audio dealer for connections.

- For example, if your CD automatic changer is one of the KD-MK series, you need a cord (KS-U15K) for connecting it to this unit.

Before operating your CD automatic changer:

- Refer also to the Instructions supplied with your CD changer.
- If no discs are in the magazine of the CD changer or the discs are inserted upside down, "NO DISC" will appear on the display. If this happens, remove the magazine and set the discs correctly.
- If "RESET 1" – "RESET 8" appears on the display, something is wrong with the connection between this unit and the CD changer. If this happens, check the connection and make sure the cords are connected firmly. Then, press the reset button of the CD changer.

## Playing CDs

### Select the CD automatic changer (CD-CH).

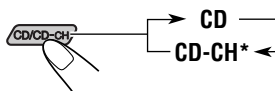

- \* If you have changed the "EXT IN" setting to "LINE IN" ( see page 35), you cannot select the CD changer.

Playback starts from the first track of the first disc. All tracks of all discs are played back.

Elapsed playing time    Track number    Disc number\*\*

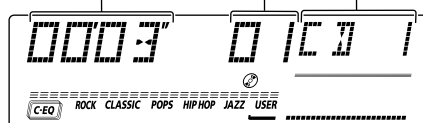

- \*\* When "CLOCK" is set to "ON" (see page 34), disc number will soon change to clock time.

### Note on One-Touch Operation:

When you press CD/CD-CH, the power automatically turns on. You do not have to press ATT to turn on the power.



### To fast-forward or reverse the track

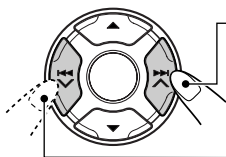

Press and hold **▶▶▶ ▲**, while playing a disc, to fast-forward the track.

Press and hold **◀◀◀ ▼**, while playing a disc, to reverse the track.

### To go to a particular disc directly

Press the number button corresponding to the disc number to start its playback (while the CD changer is playing).

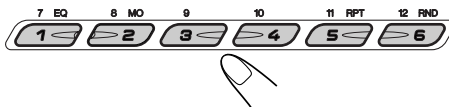

### To go to the next track or the previous tracks

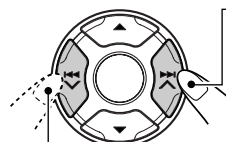

Press **▶▶▶ ▲** briefly, while playing a disc, to go ahead to the beginning of the next track. Each time you press the button consecutively, the beginning of the next track is located and played back.

Press **◀◀◀ ▼** briefly, while playing a disc, to go back to the beginning of the current track. Each time you press the button consecutively, the beginning of the previous tracks is located and played back.

- To select a disc number from 1 – 6:  
Press 1 (7) – 6 (12) briefly.
- To select a disc number from 7 – 12:  
Press and hold 1 (7) – 6 (12) for more than 1 second.

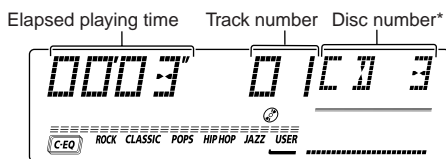

\* When "CLOCK" is set to "ON" (see page 34), disc number will soon change to clock time.

### To show the CD Text information

This is possible only when connecting a JVC CD automatic changer equipped with CD Text reading capability.

See "Playing a CD Text" on page 22.

### To go to the next discs or the previous discs

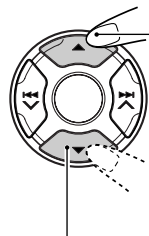

Press **▲**, while playing a disc, to go to the next disc. Each time you press the button consecutively, the first track of the next disc is located and played back.

Press **▼**, while playing a disc, to go to the previous disc. Each time you press the button consecutively, the first track of the previous disc is located and played back.



# Selecting CD playback modes

## To play back tracks at random (Random Play)



1 Press MODE (M) to enter the functions mode while playing a disc. "MODE" appears on the upper part of the display, and the number buttons work as different function buttons.

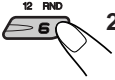

2 Press RND (random), while "MODE" is still on the display, so that the RND indicator lights up on the display. Then, each time you press RND (random), the random play mode changes as follows:

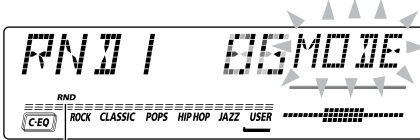

RND indicator lights up.

Ex.: When you select "RND1."

Mode	RND Indicator	Plays at random
RND1	Lights	All tracks of the current disc, then the tracks of the next disc and so on.
RND2	Flashes	All tracks of all discs inserted in the magazine.

## To play back tracks repeatedly (Repeat Play)



1 Press MODE (M) to enter the functions mode while playing a disc. "MODE" appears on the upper part of the display, and the number buttons work as different function buttons.

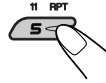

2 Press RPT (repeat), while "MODE" is still on the display, so that the RPT indicator lights up on the display. Then, each time you press RPT (repeat), the repeat play mode changes as follows:



Track number of the currently playing track

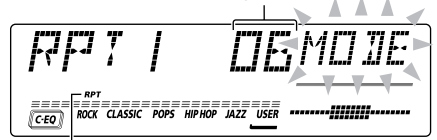

RPT indicator lights up.

Ex.: When you select "RPT1."

Mode	RPT Indicator	Plays repeatedly
RPT1	Lights	The current track (or specified track).
RPT2	Flashes	All tracks of the current disc (or specified disc).



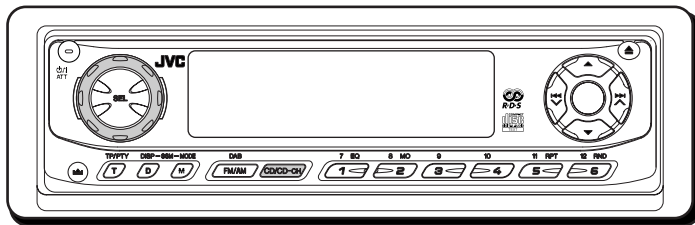

## Playing an external component

You can connect the external component to the CD changer jack on the rear using the Line Input Adaptor KS-U57 (not supplied).

### Preparations:

- For connecting the Line Input Adaptor KS-U57 and the external component, refer to the Installation/Connection Manual (separate volume).
- Before operating the external component using the following procedure, select the external input correctly. (See "To select the external component to use – EXT IN" on page 35.)

**2** Turn on the connected component and start playing the source.

**3** Adjust the volume.



**4** Adjust the sound characteristics you want. (See pages 29 – 31.)

**1** Select the external component (LINE IN).

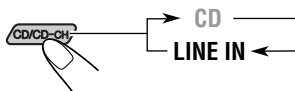

- If "LINE IN" does not appear on the display, see page 35 and select the external input ("LINE IN").
- Displayed only when one of the following sources is selected – FM, AM and CD.

### Note on One-Touch Operation:

When you press CD/CD-CH, the power automatically comes on. You do not have to press / I ATT to turn on the power.

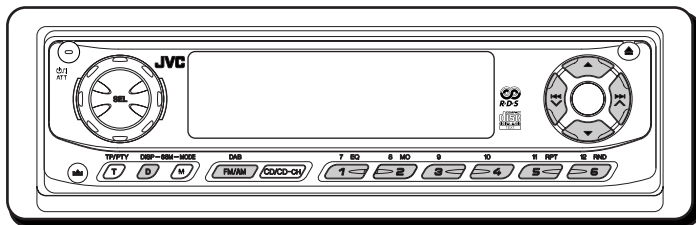

We recommend that you use DAB (Digital Audio Broadcasting) tuner KT-DB1500 with your unit. If you have another DAB tuner, consult your JVC IN-CAR ENTERTAINMENT dealer.

- Refer also to the Instructions supplied with your DAB tuner.

## What is DAB system?

DAB is one of the digital radio broadcasting systems available today. It can deliver CD quality sound without any annoying interference and signal distortion.

Furthermore, it can carry text, pictures and data.

In contrast to FM broadcast, where each programme is transmitted on its own frequency, DAB combines several programmes (called "services") to form one "ensemble."

With the DAB tuner connected with this unit, you can enjoy these DAB services.

## Tuning in to an ensemble and one of the services

A typical ensemble has 6 or more programmes (services) broadcast at the same time. After tuning in to an ensemble, you can select a service you want to listen to.

### Before you start....

Press DAB (FM/AM) briefly if CD, CD changer or external component is the current source.

### 1 Select the DAB tuner.

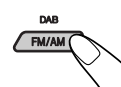

Each time you press and hold the button, the DAB tuner and the FM/AM tuner are alternately selected.

DAB ↔ FM/AM

### 2 Select the DAB band (DAB1, DAB2 or DAB3).

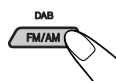

Each time you press the button, the DAB band changes as follows:

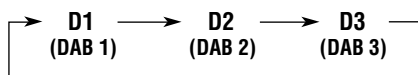

### Note:

This receiver has three DAB bands (DAB1, DAB2, DAB3). You can use any one of them to tune in to an ensemble.

### 3 Start searching an ensemble.

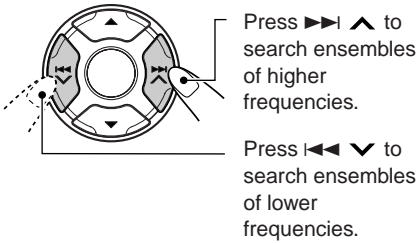

When an ensemble is received, searching stops.

**To stop searching before an ensemble is received**, press the same button you have pressed for searching.

### 4 Select a service you want to listen to.

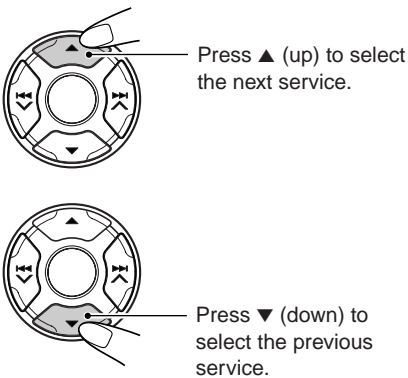

### To change the display information while tuning in to an ensemble

Normally service name is shown on the display. If you want to change the display information, press DISP (D).



Each time you press the button, the following information appears on the display for a while.

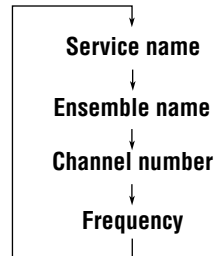

### To tune in to a particular ensemble without searching:

- 1 Press and hold DAB (FM/AM) to select DAB tuner as the source.
- 2 Press DAB (FM/AM) repeatedly to select the DAB band (DAB1, DAB2 or DAB3).
- 3 Press and hold >>>| ^ or |<<< v for more than 1 second.
- 4 Press >>>| ^ or |<<< v repeatedly until the ensemble you want is reached.
  - If you hold down the button, the frequency keeps changing until you release the button.

### To restore the FM/AM tuner

Press and hold DAB (FM/AM) again.

## Storing DAB services in memory

You can preset up to 6 DAB services in each DAB band (DAB1, DAB2 and DAB3) manually.

### 1 Select the DAB tuner.

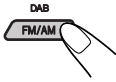

Each time you press and hold the button, the DAB tuner and the FM/AM tuner are alternately selected.

DAB ↔ FM/AM

### 2 Select the DAB band (DAB1, DAB2 or DAB3) you want.

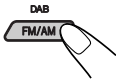

Each time you press the button, the DAB band changes as follows:

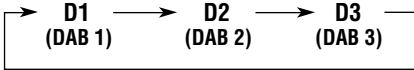

### 3 Tune in to an ensemble you want.



### 4 Select a service of the ensemble you want.



Press ▲ (up) to select the next service.



Press ▼ (down) to select the previous service.

### 5 Press and hold the number button (in this example, 1) you want to store the selected service into for more than 2 seconds.

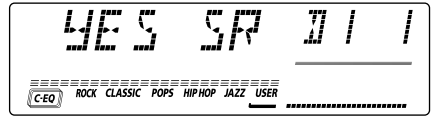
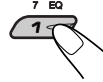

Selected band/preset number and "MEMO" (memory) appear alternately for a while.

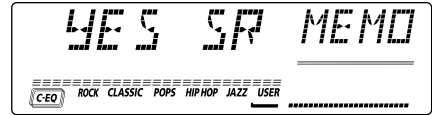

### 6 Repeat the above procedure to store other DAB services into other preset numbers.

#### Notes:

- A previously preset DAB service is erased when a new DAB service is stored in the same preset number.
- Preset DAB services are erased when the power supply to the memory circuit is interrupted (for example, during battery replacement). If this occurs, preset the DAB services again.

## Tuning in to a preset DAB service

You can easily tune in to a preset DAB service. Remember that you must store services first. If you have not stored them yet, see the column on the left.

### 1 Select the DAB tuner.

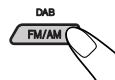

Each time you press and hold the button, the DAB tuner and the FM/AM tuner are alternately selected.

DAB ↔ FM/AM

## 2 Select the DAB band (DAB1, DAB2 or DAB3) you want.

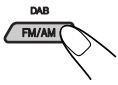

Each time you press the button, the DAB band changes as follows:

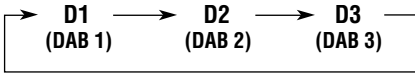

## 3 Select the number (1 – 6) for the preset DAB service you want.

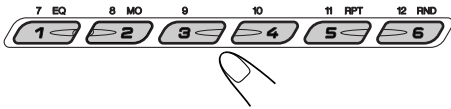

## To adjust the DAB volume level

You can adjust the input level of DAB tuner and store it in memory. By adjusting the input level properly to match it to the FM sound level, you will not need to adjust the volume level each time you change the source.

When shipped from the factory, DAB volume level is set at “00.”

- See also “Changing the general settings (PSM)” on pages 32 and 33.

- 1 Press and hold SEL (select) for more than 2 seconds so that one of the PSM items appears on the display.
- 2 Press ►|▲ or |◄▼ to select “DAB VOL (volume)”.
- 3 Turn the control dial to set to the desired volume.  
You can set it from “-12” to “12.”
- 4 Press SEL (select) to finish the setting.

## What you can do more with DAB

### Tracing the same program automatically (Alternative Reception)

You can keep listening to the same program.

- **While receiving a DAB service:**

When driving in an area where a service cannot be received, this unit automatically tunes in to another ensemble or FM RDS station, broadcasting the same program.

- **While receiving an FM RDS station:**

When driving in an area where a DAB service is broadcasting the same program as the FM RDS station is broadcasting, this unit automatically tunes in to the DAB service.

#### Note:

When reception switches between DAB and FM, the listening volume level may increase or decrease inconveniently. This change in the volume level results from unequal audio injection levels at broadcaster site, but not from the malfunction of this unit.

To prevent this inconvenience, you can adjust the DAB volume level (see next column).

### To use Alternative Reception

When shipped from the factory, Alternative Reception is activated.

- See also “Changing the general settings (PSM)” on pages 32 and 33.

- 1 Press and hold SEL (select) for more than 2 seconds so that one of the PSM items appears on the display.
- 2 Press ►|▲ or |◄▼ to select “DAB AF” (alternative frequency).
- 3 Turn the control dial to select the desired mode.
  - AF ON: Traces the program among DAB services and FM RDS stations — Alternative Reception. The AF indicator lights up on the display (see page 12).
  - AF OFF: Deactivates Alternative Reception.

#### Note:

When Alternative Reception (for DAB services) is activated, Network-Tracking Reception (for RDS stations: see page 12) is also activated automatically. On the other hand, Network-Tracking Reception cannot be deactivated without deactivating Alternative Reception.

- 4 Press SEL (select) to finish the setting.



# TROUBLESHOOTING

ENGLISH

What appears to be trouble is not always serious. Check the following points before calling a service center.

	Symptoms	Causes	Remedies
General Playback	<ul style="list-style-type: none"> <li>• Sound is sometimes interrupted.</li> </ul>	You are driving on rough roads.	Stop playback while driving on rough roads.
		Disc is scratched.	Change the disc.
		Connections are incorrect.	Check the cords and connections.
	<ul style="list-style-type: none"> <li>• Sound cannot be heard from the speakers.</li> </ul>	The volume level is set to the minimum level.	Adjust it to the optimum level.
		Connections are incorrect.	Check the cords and connections.
	<ul style="list-style-type: none"> <li>• CD cannot be played back.</li> </ul>	Disc is inserted upside down.	Insert the disc correctly.
	<ul style="list-style-type: none"> <li>• CD-R/CD-RW cannot be played back.</li> <li>• Tracks on the CD-R/CD-RW cannot be skipped.</li> </ul>	CD-R/CD-RW is not finalized.	<ul style="list-style-type: none"> <li>• Insert a finalized CD-R/CD-RW.</li> <li>• Finalize the CD-R/CD-RW with the component which you used for recording.</li> </ul>
		<ul style="list-style-type: none"> <li>• "NO DISC" appears on the display .</li> </ul>	No disc in the loading slot.
	Disc is inserted incorrectly.		Insert the disc correctly.
	<ul style="list-style-type: none"> <li>• Disc cannot be ejected.</li> </ul>	Disc is locked.	Unlock the disc (See page 22.)
<ul style="list-style-type: none"> <li>• This unit does not work at all.</li> </ul>	The built-in microcomputer may function incorrectly due to noise, etc.	Press the reset button on the panel holder using a ball-point pen after detaching the control panel. (The clock setting and preset stations stored in memory are erased.) (See page 2.)	
FM/AM	<ul style="list-style-type: none"> <li>• SSM (Strong-station Sequential Memory) automatic preset does not work.</li> </ul>	Signals are too weak.	Store stations manually.
	<ul style="list-style-type: none"> <li>• Static noise while listening to the radio.</li> </ul>	The antenna is not connected firmly.	Connect the antenna firmly.



Symptoms	Causes	Remedies	
<ul style="list-style-type: none"> <li>• “NO DISC” appears on the display .</li> </ul>	No disc in the magazine.	Insert a disc.	CD Changer
<ul style="list-style-type: none"> <li>• “RESET 8” appears on the display .</li> </ul>	This unit is not connected to a CD changer correctly.	Connect this unit and the CD changer correctly and press the reset button of the CD changer.	
<ul style="list-style-type: none"> <li>• “RESET 1” – “RESET 7” appears on the display.</li> </ul>	_____	Press the reset button of the CD changer.	
<ul style="list-style-type: none"> <li>• Disc cannot be played back.</li> </ul>	MP3 files do not have the extension code—mp3 in their file names.	Add the extension code—mp3 to their file names.	MP3 Playback (Only for KD-LH7R)
	MP3 files are not recorded in the format compliant with ISO 9660 Level 1, ISO 9660 Level 2, or Joliet.	Change the disc. (Record MP3 files using a compliant application.)	
<ul style="list-style-type: none"> <li>• Files skip, or 00'00” appears and playback stops.</li> </ul>	Files are encoded in Layer 1 or Layer 2 format.	Insert a disc that contains files encoded in Layer 3 format.	
<ul style="list-style-type: none"> <li>• Noise is generated.</li> </ul>	The file played back is not an MP3 file (although it has the extension code—mp3).	Skip to another file or change the disc. (Do not add the extension code—mp3 to non-MP3 files.)	
<ul style="list-style-type: none"> <li>• A longer readout time is required (“CHECK” keeps flashing on the display).</li> </ul>	Readout time varies due to the complexity of the directory/file configuration.	Do not use too many hierarchies and directories. Also, do not record any other types of audio tracks together with MP3 files.	
<ul style="list-style-type: none"> <li>• Files cannot be played back as you have intended them to play.</li> </ul>	Playback order is determined when the files are recorded.	_____	
<ul style="list-style-type: none"> <li>• Elapsed playing time is not correct.</li> </ul>	This sometimes occurs during play. This is caused by how the files are recorded on the disc.	_____	
<ul style="list-style-type: none"> <li>• “MP3” flashes on the display.</li> </ul>	There are no MP3 files in the current directory.	Select another directory.	
<ul style="list-style-type: none"> <li>• “NO FILES” appears on the display for a while, then “PLEASE” and “EJECT” appear alternately.</li> </ul>	There are no MP3 files in this disc.	Insert a disc that contains MP3 files.	
<ul style="list-style-type: none"> <li>• Correct characters are not displayed. (e.g. album name)</li> </ul>	This unit can only display alphabets (capital: A–Z, small: a–z), numbers, and a limited number of symbols.	_____	



## Handling CDs

This unit has been designed to reproduce CDs, CD-Rs, CD-RWs and CD Text.

Only for KD-LH7R:

- You can also play back MP3 discs.

### How to handle discs

When removing a disc from its case, press down the center holder of the case and lift the disc out, holding it by the edges.

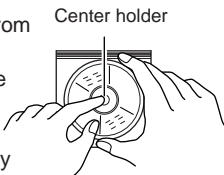

- Always hold the disc by the edges. Do not touch its recording surface.

When storing a disc into its case, gently insert the disc around the center holder (with the printed surface facing up).

- Make sure to store discs into the cases after use.

### To keep discs clean

A dirty disc may not play correctly. If a disc does become dirty, wipe it with a soft cloth in a straight line from center to edge.

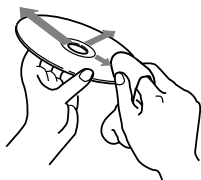

### To play new discs

New discs may have some rough spots around the inner and outer edges. If such a disc is used, this unit may reject the disc. To remove these rough spots, rub the edges with a pencil or ball-point pen, etc.

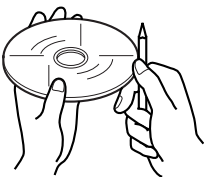

#### About mistracking:

*Mistracking may result from driving on extremely rough roads. This does not damage the unit and the disc, but will be annoying.*

*We recommend that you stop disc playback while driving on such rough roads.*

### Moisture condensation

Moisture may condense on the lens inside the unit in the following cases:

- After starting the heater in the car.
- If it becomes very humid inside the car.

Should this occur, the unit may malfunction. In this case, eject the disc and leave the unit turned on for a few hours until the moisture evaporates.

### When playing a CD-R or CD-RW

You can play back your original CD-Rs or CD-RWs recorded in audio CD format (or in MP3 format: only for KD-LH7R.) However, they may not be played back depending on their characteristics or recording conditions.

- User-edited CD-Rs (Recordable) and CD-RWs (Rewritable) can be played back only if they are already "finalized."
- Before playing back CD-Rs or CD-RWs, read their instructions or cautions carefully.
- Some CD-Rs or CD-RWs may not be played back on this unit because of their disc characteristics, damage or stain on them, or if the player's lens is dirty.
- CD-Rs or CD-RWs are susceptible to high temperatures or high humidity; so do not leave them inside your car.
- CD-RWs may require a longer readout time. (This is caused by the fact that the reflectance of CD-RWs is lower than for regular CDs.)

#### CAUTIONS:

- Do not insert 8 cm discs (single CDs) into the loading slot. (Such discs cannot be ejected.)
- Do not insert any disc of unusual shape—like a heart or flower; otherwise, it will cause a malfunction.
- Do not expose discs to direct sunlight or any heat source or place them in a place subject to high temperature and humidity. Do not leave them in a car.
- Do not use any solvent (for example, conventional record cleaner, spray, thinner, benzine, etc.) to clean discs.



## AUDIO AMPLIFIER SECTION

Maximum Power Output:

Front: 50 W per channel

Rear: 50 W per channel

Continuous Power Output (RMS):

Front: 19 W per channel into 4  $\Omega$ , 40 Hz to 20 000 Hz at no more than 0.8% total harmonic distortion.

Rear: 19 W per channel into 4  $\Omega$ , 40 Hz to 20 000 Hz at no more than 0.8% total harmonic distortion.

Load Impedance: 4  $\Omega$  (4  $\Omega$  to 8  $\Omega$  allowance)

Tone Control Range:

Bass:  $\pm 10$  dB at 100 Hz

Treble:  $\pm 10$  dB at 10 kHz

Frequency Response: 40 Hz to 20 000 Hz

Signal-to-Noise Ratio: 70 dB

Line-Out Level/Impedance: 2.0 V/20 k $\Omega$  load

Output Impedance: 1 k $\Omega$

## TUNER SECTION

Frequency Range:

FM: 87.5 MHz to 108.0 MHz

AM: (MW) 522 kHz to 1 620 kHz

(LW) 144 kHz to 279 kHz

### **[FM Tuner]**

Usable Sensitivity: 11.3 dBf (1.0  $\mu$ V/75  $\Omega$ )

50 dB Quieting Sensitivity: 16.3 dBf (1.8  $\mu$ V/75  $\Omega$ )

Alternate Channel Selectivity (400 kHz): 65 dB

Frequency Response: 40 Hz to 15 000 Hz

Stereo Separation: 30 dB

Capture Ratio: 1.5 dB

### **[AM Tuner]**

Sensitivity: 20  $\mu$ V

Selectivity: 35 dB

## CD PLAYER SECTION

Type: Compact disc player

Signal Detection System: Non-contact optical pickup (semiconductor laser)

Number of channels: 2 channels (stereo)

Frequency Response: 5 Hz to 20 000 Hz

Dynamic Range: 96 dB

Signal-to-Noise Ratio: 98 dB

Wow and Flutter: Less than measurable limit

### **[For KD-LH7R only:]**

MP3 recording format: MPEG 1/2 Audio Layer 3

Max. Bit rate: 320 Kbps

## GENERAL

Power Requirement:

Operating Voltage: DC 14.4 V

(11 V to 16 V allowance)

Grounding System: Negative ground

Allowable Operating Temperature: 0°C to +40°C

Dimensions (W  $\times$  H  $\times$  D):

Installation Size: 182 mm  $\times$  52 mm  $\times$  150 mm

Panel Size: 188 mm  $\times$  58 mm  $\times$  14 mm

Mass: 1.4 kg (excluding accessories)

*Design and specifications subject to change without notice.*

**Having TROUBLE with operation?**

**Please reset your unit**

Refer to page of How to reset your unit

**Haben Sie PROBLEME mit dem Betrieb?**

**Bitte setzen Sie Ihr Gerät zurück**

Siehe Seite Zurücksetzen des Geräts

**Vous avez des PROBLÈMES de fonctionnement?**

**Réinitialisez votre appareil**

Référez-vous à la page intitulée Comment réinitialiser votre appareil

**Hebt u PROBLEMEN met de bediening?**

**Stel het apparaat terug**

Zie de pagina met de paragraaf Het apparaat terugstellen

**JVC**

VICTOR COMPANY OF JAPAN, LIMITED



EN, GE, FR, NL

Download from [www.Somanuals.com](http://www.Somanuals.com). All Manuals Search And Download.



0102KKSMJTJEIN

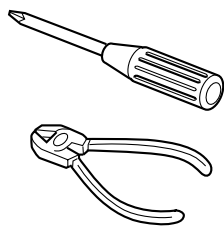

#### ENGLISH

- This unit is designed to operate on 12 V DC, NEGATIVE ground electrical systems.

## INSTALLATION (IN-DASH MOUNTING)

- The following illustration shows a typical installation. However, you should make adjustments corresponding to your specific car. If you have any questions or require information regarding installation kits, consult your JVC IN-CAR ENTERTAINMENT dealer or a company supplying kits.

**1 Before mounting:** Press (Control Panel Release button) to detach the control panel if already attached.

- \* When shipped from the factory, the control panel is packed in the hard case.

**2** Remove the trim plate.

**3** Remove the sleeve after disengaging the sleeve locks.

- 1 Stand the unit.

**Note:** When you stand the unit, be careful not to damage the fuse on the rear.

- 2 Insert the 2 handles between the unit and the sleeve, as illustrated, to disengage the sleeve locks.

- 3 Remove the sleeve.

**Note:** Be sure to keep the handles for future use after installing the unit.

**4** Install the sleeve into the dashboard.

- \* After the sleeve is correctly installed into the dashboard, bend the appropriate tabs to hold the sleeve firmly in place, as illustrated.

**5** Fix the mounting bolt to the rear of the unit's body and place the rubber cushion over the end of the bolt.

**6** Do the required electrical connections.

**7** Slide the unit into the sleeve until it is locked.

**8** Attach the trim plate.

**9** Attach the control panel.

#### DEUTSCH

- Dieses Gerät ist für einen Betrieb in elektrischen Anlagen mit 12 V Gleichstrom und (-) Erdung ausgelegt.

## EINBAU (IM ARMATURENBRETT)

- Die folgende Abbildung zeigt einen typischen Einbau. Dennoch müssen Sie entsprechend Ihrem jeweiligen Auto Anpassungen vornehmen. Bei irgendwelchen Fragen oder wenn Sie Informationen hinsichtlich des Einbausatzes brauchen, wenden Sie sich an ihren JVC Autoradiohändler oder ein Unternehmen das diese Einbausätze vertreibt.

**1 Vor dem Einbau:** Drücken Sie (Freigabe der Schalttafel), um die Arretierung der Schalttafel zu lösen, sofern diese bereits angebracht ist.

- \* Bei der Auslieferung ab Werk ist die Schalttafel im Etui verpackt.

**2** Den Frontrahmen herausnehmen.

**3** Die Halterung nach dem Entriegeln der Halterungssperren abnehmen.

- 1 Das Gerät aufstellen.

**Hinweis:** Beim Aufstellen des Geräts darauf achten, daß die Sicherung auf der Rückseite nicht beschädigt wird.

- 2 Die 2 Griffe zwischen dem Gerät und der Halterung wie abgebildet einstecken und die Halterungssperren entriegeln.

- 3 Die Halterung entfernen.

**Hinweis:** Sicherstellen, daß die Griffe für künftigen Gebrauch nach dem Einbau des Geräts aufbewahrt werden.

**4** Die Halterung im Armaturenbrett einbauen.

- \* Nach dem korrekten Einbau der Halterung im Armaturenbrett, die entsprechenden Riegel umknicken, um die Halterung an ihrem Platz zu sichern, siehe Abbildung.

**5** Die Befestigungsschraube an der Rückseite des Gerätekörpers befestigen und das Ende der Schraube mit einem Gummipuffer abdecken.

**6** Nehmen Sie die erforderlichen elektrischen Anschlüsse vor.

**7** Das Gerät in die Halterung schieben, bis es einrastet.

**8** Die Frontrahmen anbringen.

**9** Die Schalttafel anbringen.

#### FRANÇAIS

- Cet appareil est conçu pour fonctionner sur des sources de courant continu de 12 V à masse NEGATIVE.

## INSTALLATION (MONTAGE DANS LE TABLEAU DE BORD)

- L'illustration suivante est un exemple d'installation typique. Cependant, vous devez faire les ajustements correspondant à votre voiture particulière. Si vous avez des questions ou avez besoin d'information sur des kits d'installation, consulter votre revendeur d'autoradios JVC ou une compagnie d'approvisionnement.

**1 Avant le montage:** Appuyer sur (déblocage du panneau de commande) pour éventuellement détacher le panneau de commande.

- \* Lorsque ce panneau de commande sort d'usine, il est rangé dans un étui de transport.

**2** Retirer la plaque d'assemblage.

**3** Libérer les verrous du manchon et retirer le manchon.

- 1 Poser l'appareil à la verticale.

**Remarque:** Lorsque vous mettez l'appareil à la verticale, faire attention de ne pas endommager le fusible situé sur l'arrière.

- 2 Insérer les 2 poignées entre l'appareil et le manchon comme indiqué pour désengager les verrous de manchon.

- 3 Retirer le manchon.

**Remarque:** S'assurer de garder les poignées pour une utilisation ultérieure, après l'installation de l'appareil.

**4** Installer le manchon dans le tableau de bord.

- \* Après installation correcte du manchon dans le tableau de bord, plier les bonnes pattes pour maintenir fermement le manchon en place, comme montré.

**5** Monter le boulon de montage sur l'arrière du corps de l'appareil puis passer l'amortisseur en caoutchouc sur l'extrémité du boulon.

**6** Réaliser les connexions électriques.

**7** Faire glisser l'appareil dans le manchon jusqu'à ce qu'il soit verrouillé.

**8** Remonter la plaque d'assemblage.

**9** Remonter le panneau de commande.

#### NEDERLANDS

- Dit apparaat mag worden gebruikt bij elektrische systemen die werken op 12 V gelijkstroom met negatieve aarding.

## INSTALLATIE (INBOUW IN HET DASHBOARD)

- Op de volgende afbeelding kunt u zien hoe de installatie, normaal gesproken, in zijn werk gaat. U moet echter bij de installatie rekening houden met de bijzonderheden van uw eigen auto. Neem bij vragen of voor meer bijzonderheden over inbouwpakketten contact op met uw JVC car audio dealer of een dealer of een bedrijf dat inbouwpakketten levert.

**1 Voordat u aan de montage van het apparaat begint:** Druk op (het bedieningspaneel vrijgeven) als u het bedieningspaneel wilt loskoppelen indien dit aan de eenheid is vastgekoppeld.

- \* Standaard wordt het bedieningspaneel bij het verlaten van de fabriek los verpakt meegeleverd.

**2** Verwijder de sierplaat.

**3** Verwijder het huis nadat u de klemmen hebt losgemaakt.

- 1 Zet het apparaat rechtop.

**Opmerking:** Wanneer u het apparaat rechtop zet, moet u erop letten dat u de zekering aan de achterkant niet beschadigt.

- 2 Plaats de 2 hendels, zoals afgebeeld, tussen het apparaat en het huis, om de klemmen los te maken.

- 3 Verwijder het huis.

**Opmerking:** Bewaar de hendels nadat u het apparaat hebt geïnstalleerd, zodat u ze ook in de toekomst kunt gebruiken.

**4** Installeer het huis in het dashboard.

- \* Nadat het huis op de juiste wijze in het dashboard is geplaatst, moet u de palletjes, zoals afgebeeld, stevig op hun plaats duwen.

**5** Maak de bevestigingsbout aan de achterkant van het apparaat vast en plaats de rubberdop over het uiteinde van de bout.

**6** Breng de vereiste elektrische verbindingen tot stand.

**7** Schuif het apparaat in het huis totdat het vergrendeld is.

**8** Bevestig de sierplaat.

**9** Bevestig het bedieningspaneel.

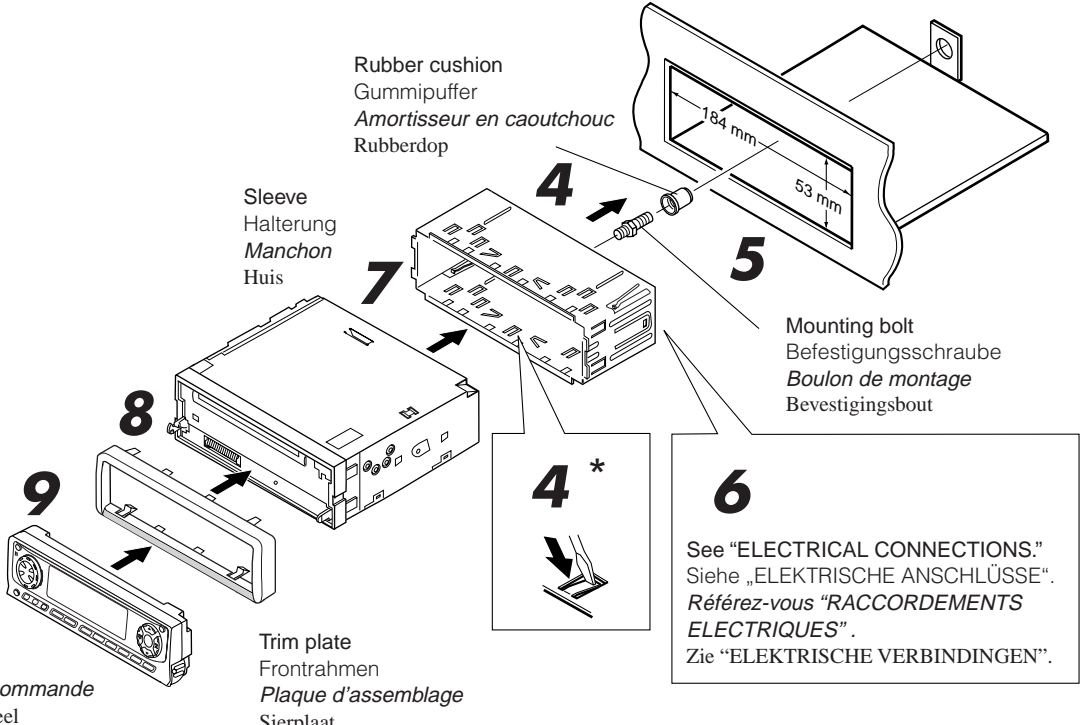
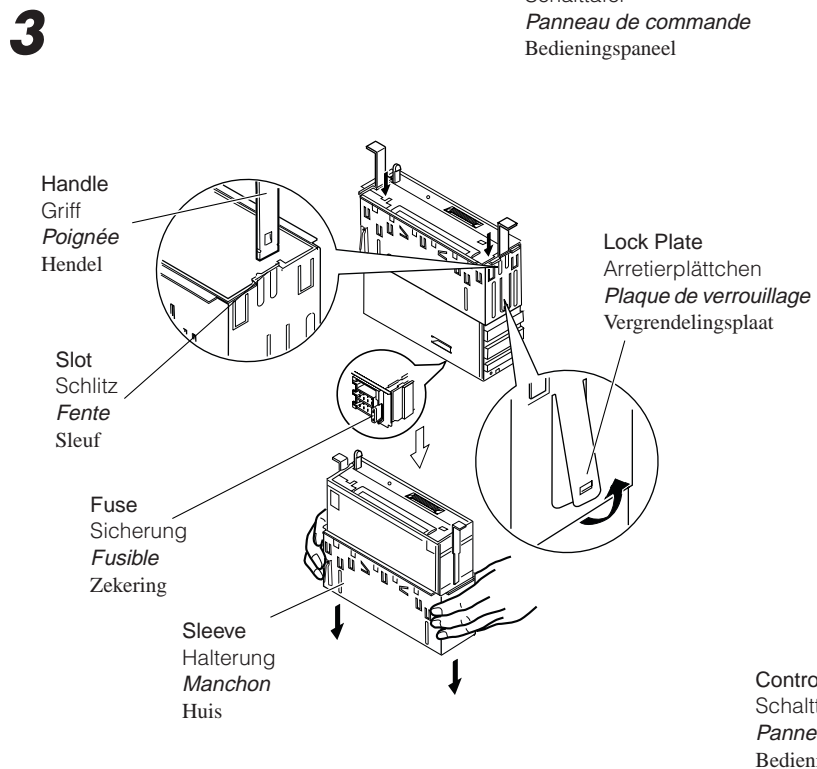
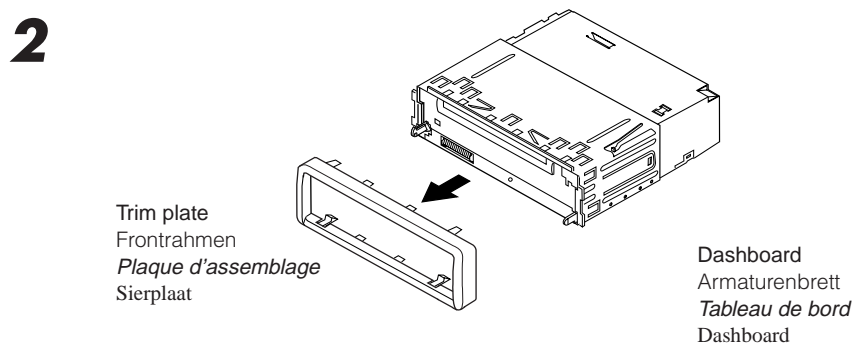
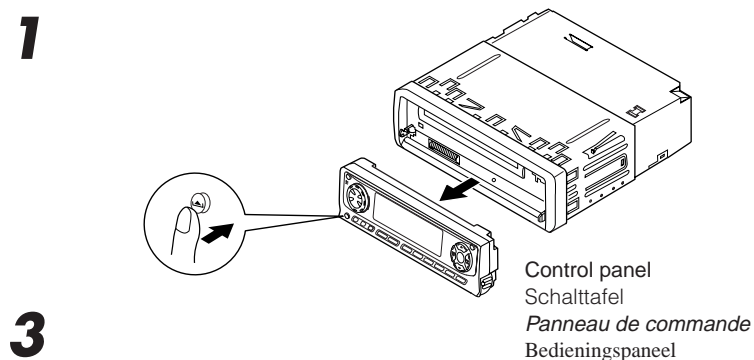



- When using the optional stay
- Beim Verwenden der Anker-Option
- Lors de l'utilisation du hauban en option
- Wanneer u de steun gebruikt (facultatief)

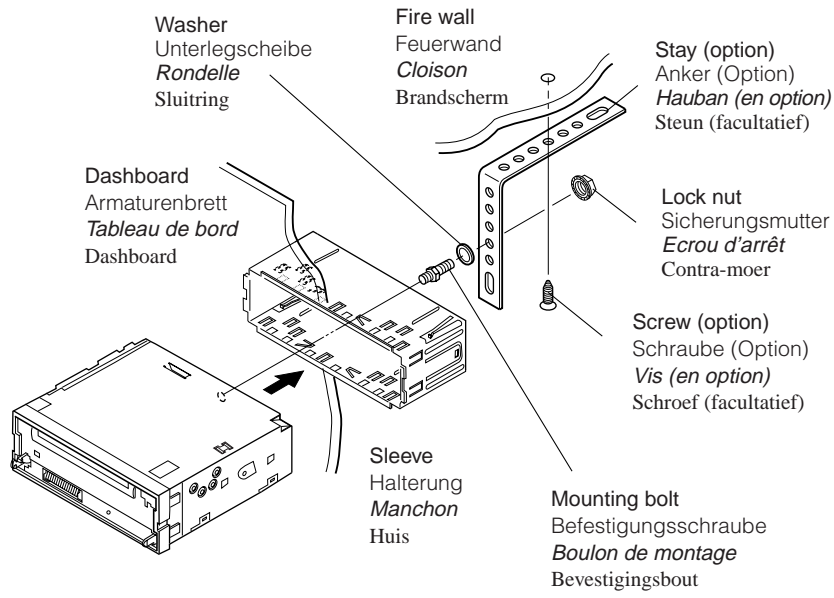

- When installing the unit without using the sleeve
- Beim Einbau des Geräts ohne Halterung
- Lors de l'installation de l'appareil sans utiliser de manchon
- Wanneer u het apparaat zonder huis installeert

In a Toyota for example, first remove the car radio and install the unit in its place.  
Zum Beispiel in einem Toyota zuerst das Autoradio ausbauen und dann das Gerät an seinem Platz einbauen.  
Par exemple dans un Toyota, retirer d'abord l'autoradio et installer l'appareil à la place.

Voorbeeld: Bij een Toyota moet u eerst de autoradio verwijderen en daarna het apparaat installeren.

- Flat type screws (M5 x 6 mm)\*
- Senkkopfschrauben (M5 x 6 mm)\*
- Vis à tête plate (M5 x 6 mm)\*
- Platkopfschroeven (M5 x 6 mm)\*

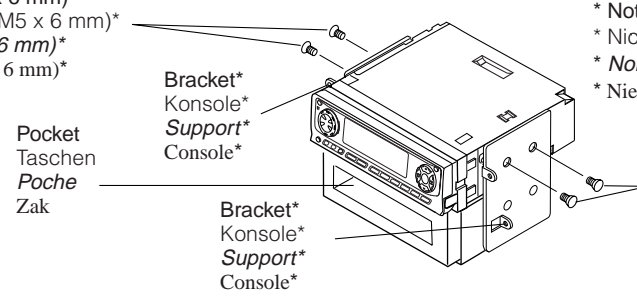

- \* Not included with this unit.
- \* Nicht Teil dieses Geräts.
- \* Non fourni avec cet appareil.
- \* Niet meegeleverd.

- Flat type screws (M5 x 6 mm)\*
- Senkkopfschrauben (M5 x 6 mm)\*
- Vis à tête plate (M5 x 6 mm)\*
- Platkopfschroeven (M5 x 6 mm)\*

**Note:** When installing the unit on the mounting bracket, make sure to use the 6 mm-long screws. If longer screws are used, they could damage the unit.

**Hinweis:** Beim Anbringen des Gerät an der Konsole sicherstellen, daß 6 mm lange Schrauben verwendet werden. Werden längere Schrauben verwendet, können sie das Gerät beschädigen.

**Remarque:** Lors de l'installation de l'appareil sur le support de montage, s'assurer d'utiliser des vis d'une longueur de 6 mm. Si des vis plus longues sont utilisées, elles peuvent endommager l'appareil.

**Opmerking:** Wanneer u het apparaat aan de bevestigingsklem vastmaakt, moet u de 6 mm lange schroeven gebruiken. Als u langere schroeven gebruikt, kan het apparaat worden beschadigd.

### Removing the unit

- Before removing the unit, release the rear section.
- 1 Remove the control panel.
- 2 Remove the trim plate.
- 3 Insert the 2 handles into the slots, as shown. Then, while gently pulling the handles away from each other, slide out the unit. **(Be sure to keep the handles after installing it.)**

### Ausbau des Geräts

- Vor dem Ausbau des Geräts den hinteren Teil freigeben.
- 1 Die Schalttafel abnehmen.
- 2 Den Frontrahmen herausnehmen.
- 3 Die 2 Griffe in die Schlitzte wie gezeigt stecken. Dann die Griffe behutsam auseinander ziehen und das Gerät herausziehen. **(Die Griffe nach dem Einbau auf jeden Fall aufbewahren.)**

### Retrait de l'appareil

- Avant de retirer l'appareil, libérer la section arrière.
- 1 Retirer le panneau de commande.
- 2 Retirer la plaque d'assemblage.
- 3 Introduire les deux poignées dans les fentes, comme montré. Puis, tout en tirant doucement les poignées écartées, faire glisser l'appareil pour le sortir. **(S'assurer de conserver les poignées après l'installation de l'appareil.)**

### Verwijderen van het apparaat

- Voordat u het apparaat verwijdert, moet u het achtergedeelte losmaken.
- 1 Verwijder het bedieningspaneel.
- 2 Verwijder de sierplaat.
- 3 Plaats de 2 hendels, zoals afgebeeld, in de sleuven. Daarna duwt u de hendels zachtjes uit elkaar en kunt u het apparaat naar buiten schuiven. **(Bewaar de hendels nadat u het apparaat hebt geïnstalleerd!)**

1

Control panel  
Schalttafel  
Panneau de commande  
Bedieningspaneel

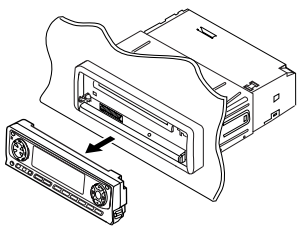

2

Trim plate  
Frontrahmen  
Plaque d'assemblage  
Sierplaat

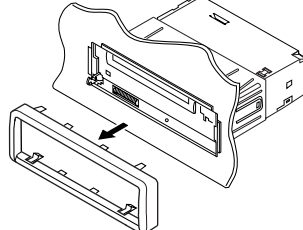

3

Handle  
Griff  
Poignée  
Hendel

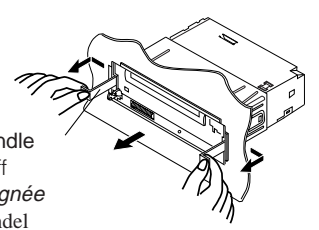

### Parts list for installation and connection

The following parts are provided with this unit. After checking them, please set them correctly.

Hard case/Control panel  
Etui/Schalttafel  
Etui de transport/Panneau de commande  
Behuizing/Bedieningspaneel

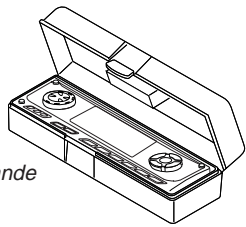

Power cord  
Stromkabel  
Cordon d'alimentation  
Stroomkabel

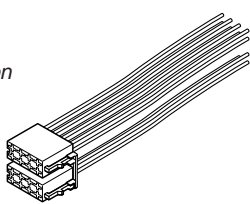

### Teileliste für den Einbau und Anschluß

Die folgenden Teile werden zusammen mit diesem Gerät geliefert. Nach ihrer Überprüfung, die Teile richtig einsetzen.

Sleeve  
Halterung  
Manchon  
Huis

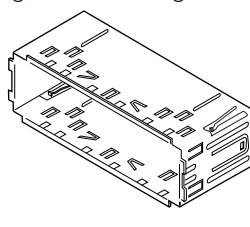

Handles  
Griffe  
Poignées  
Hendels



Washer (ø5)  
Unterlegscheibe(ø5)  
Rondelle (ø5)  
Sluitring (ø5)



### Liste des pièces pour l'installation et raccordement

Les pièces suivantes sont fournies avec cet appareil. Après vérification, veuillez les placer correctement.

Trim plate  
Frontrahmen  
Plaque d'assemblage  
Sierplaat

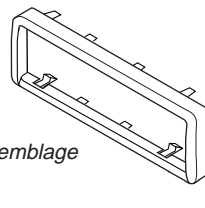

Lock nut (M5)  
Sicherungsmutter (M5)  
Ecrou d'arrêt (M5)  
Contra-moer (M5)



Mounting bolt (M5 x 20 mm)  
Befestigungsschraube (M5 x 20 mm)  
Boulon de montage (M5 x 20 mm)  
Bevestigingsbout (M5 x 20 mm)



### Lijst van onderdelen die u bij installatie en aansluiting nodig hebt

De volgende onderdelen worden bij het apparaat geleverd. Installeer ze op de juiste wijze, nadat u ze hebt gecontroleerd.

ONLY FOR KD-LH7R  
NUR FÜR KD-LH7R  
SEULEMENT POUR LE KD-LH7R  
ALLEEN VOOR KD-LH7R

Remote controller  
Fernbedienung  
Télécommande  
Afstandsbediening

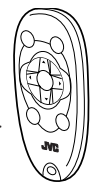

Battery  
Batterie  
Pile  
Batterij



Rubber cushion  
Gummipuffer  
Amortisseur en caoutchouc  
Rubberdop



## ELECTRICAL CONNECTIONS

To prevent short circuits, we recommend that you disconnect the battery's negative terminal and make all electrical connections before installing the unit. If you are not sure how to install this unit correctly, have it installed by a qualified technician.

### Note:

This unit is designed to operate on 12 V DC, **NEGATIVE ground electrical systems**. If your vehicle does not have this system, a voltage inverter is required, which can be purchased at JVC IN-CAR ENTERTAINMENT dealers.

- Replace the fuse with one of the specified rating. If the fuse blows frequently, consult your JVC IN-CAR ENTERTAINMENT dealer.
- If noise is a problem...  
This unit incorporates a noise filter in the power circuit. However, with some vehicles, clicking or other unwanted noise may occur. If this happens, connect the unit's **rear ground terminal** (see connection diagram) to the car's chassis using shorter and thicker cords, such as copper braiding or gauge wire. If noise still persists, consult your JVC IN-CAR ENTERTAINMENT dealer.
- Maximum input of the speakers should be no more than 50 W at the rear and 50 W at the front, with an impedance of 4 Ω to 8 Ω.
- **Be sure to ground this unit to the car's chassis.**
- The heat sink becomes very hot after use. Be careful not to touch it when removing this unit.

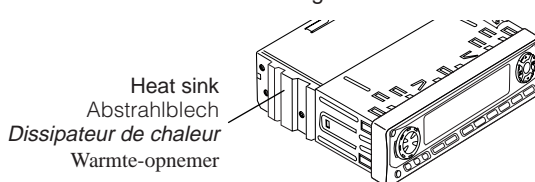

## ELEKTRISCHE ANSCHLÜSSE

Zur Vermeidung von Kurzschlüssen empfehlen wir, daß Sie den negativen Batterieanschluß abtrennen und alle elektrischen Anschlüsse herstellen, bevor das Gerät eingebaut wird. Sind Sie sich über den richtigen Einbau des Geräts nicht sicher, lassen Sie es von einem qualifizierten Techniker einbauen.

### Hinweis:

Dieses Gerät ist für einen Betrieb in **elektrischen Anlagen mit 12 V Gleichstrom und (-) Erdung** ausgelegt. Verfügt Ihr Fahrzeug nicht über diese Anlage, ist ein Spannungsinverter erforderlich, der bei JVC Autoradiohändler erworben werden kann.

- Die Sicherung mit einer der entsprechenden Nennleistung ersetzen. Brennt die Sicherung häufig durch, wenden Sie sich an ihren JVC Autoradiohändler.
- Sind Störgeräusche ein Problem...  
Dieses Gerät enthält ein Störfilter im Stromkreis. Bei manchen Fahrzeugen kann jedoch ein Klicken oder andere unerwünschte Störgeräusche auftreten. Sollte das der Fall sein, die **hintere Erdungsanschlussklemme** (siehe Schaltplan) des Geräts am Fahrwerk des Fahrzeugs anschließen, dabei kürzere und dickere Kabel wie beispielsweise Kupfergeflechttraht oder Stahldraht verwenden. Bleibt Störgeräusch bestehen, wenden Sie sich an Ihren JVC Autoradiohändler.
- Maximale Eingangsleistung der Lautsprecher nicht sein sollte mehr als 50 W hinten und 50 W vorne sein, mit einer Impedanz von 4 Ω bis 8 Ω.
- **Sicherstellen, daß das Gerät am Fahrwerk geerdet wird.**
- Das Abstrahlblech wird nach dem Gebrauch sehr heiß. Beim Ausbau des Geräts darauf achten, das Abstrahlblech nicht zu berühren.

## RACCORDEMENTS ELECTRIQUES

Pour éviter tout court-circuit, nous vous recommandons de débrancher la borne négative de la batterie et d'effectuer tous les raccordements électriques avant d'installer l'appareil. Si l'on n'est pas sûr de pouvoir installer correctement cet appareil, le faire installer par un technicien qualifié.

### Remarque:

Cet appareil est conçu pour fonctionner sur des sources de courant continu de 12 V à masse **NEGATIVE**. Si votre véhicule n'offre pas ce type d'alimentation, il vous faut un convertisseur de tension, que vous pouvez acheter chez un revendeur d'autoradios JVC.

- Remplacer le fusible par un de la valeur précisée. Si le fusible saute souvent, consulter votre revendeur d'autoradios JVC.
- Si le bruit est un problème...  
Cet appareil incorpore un filtre de bruit dans le circuit d'alimentation. Cependant, avec certains véhicules, quelques claquements ou autres bruits non désirés risquent de se produire. Si cela arrive, raccorder la borne arrière de masse de l'appareil au châssis de la voiture (voir le diagramme de raccordement) en utilisant des cordons les plus gros et les plus courts possibles telle qu'une barre de cuivre ou une tresse. Si le bruit persiste, consulter votre revendeur d'autoradios JVC.
- La puissance admissible des enceintes devrait n'être pas plus qu'c 50 W à l'arrière et à 50 W l'avant, avec une impédance de 4 Ω à 8 Ω.
- **S'assurer de raccorder la mise à la masse de cet appareil au châssis de la voiture.**
- Le dissipateur de chaleur devient très chaud après usage. Faire attention de ne pas le toucher en retirant cet appareil.

## ELEKTRISCHE VERBINDINGEN

Om kortsluiting te voorkomen adviseren wij u om de minpool van de accu los te maken en alle elektrische verbindingen tot stand te brengen voordat u het apparaat in de auto installeert. Als u niet zeker weet hoe u dit apparaat moet installeren, kunt u dit beter door een daartoe gekwalificeerde technicus laten doen.

### Opmerking:

Dit apparaat mag worden gebruikt bij elektrische systemen die werken op 12 V gelijkstroom met **negatieve aarding**. Als uw auto niet is uitgerust met een dergelijk systeem, is een spanningsomzetter vereist. Dit instrument kan worden aangeschaft bij JVC car audio dealers.

- Vervang de zekering door een exemplaar met het aangegeven vermogen. Als de zekering vaak doorslaat, moet u uw JVC car audio dealer raadplegen.
- Als u geluidsproblemen hebt...  
De krachtschakeling van dit apparaat heeft een ingebouwd geluidsfilter. In sommige voertuigen zijn tikgeluiden of andere ongewenste geluiden te horen. Als dit gebeurt, moet u de **massaklem aan de achterkant** (zie aansluitingsschema) aan het chassis van de auto vastmaken met behulp van een kortere en dickere kabel, zoals kopermanteldraad of tellerkabel. Als het geluid niet verdwijnt, moet u contact opnemen met uw JVC car audio dealer.
- Het maximum ingangsvermogen van de speakers moet achterin niet meer dan 50 W zijn en voorin 50 W, met een impedantie van 4 Ω tot 8 Ω.
- **Zorg ervoor dat dit apparaat door middel van een aardkabel is verbonden met het chassis van de auto.**
- De warmte-opnemer kan na gebruik erg heet worden. Raak de warmte-opnemer niet aan wanneer u dit apparaat van zijn plaats haalt.



**A Typical Connections / Typische Anschlüsse / Raccordements typiques / Normale verbindingen**

**Before connecting:** Check the wiring in the vehicle carefully. Incorrect connection may cause serious damage to this unit.

The leads of the power cord and those of the connector from the car body may be different in colour.

**1** Connect the colored leads of the power cord to the car battery, speakers and power aerial (if any) in the following sequence.

- ① Black: ground
- ② Yellow: to car battery (constant 12 V)
- ③ Red: to an accessory terminal
- ④ Blue with white stripe: to external component
- ⑤ Orange with white stripe: to car light control switch (only for KD-LH7R)
- ⑥ Brown: to cellular phone system (For details, refer to the instructions of the cellular phone.)
- ⑦ Others: to speakers

**2** Connect the aerial cord.

**3** Finally connect the wiring harness to the unit.

**Note:** If your vehicle does not have any accessory terminal, move the fuse from the fuse position 1 (initial position) to fuse position 2, and connect the red lead (A7) to the positive (+) battery terminal.

• The yellow lead (A4) is not used in this case.

**Vor dem Anschließen:** Die Verdrahtung im Fahrzeug sorgfältig überprüfen. Falsche Anschlüsse können ernsthafte Schäden am Gerät hervorrufen.

Die Leiter des Stromkabels und die Leiter des Anschlusses im Fahrzeug können sich farblich unterscheiden.

**1** Die farbigen Leitungen des Spannungsversorgungskabels an der Autobatterie, den Lautsprechern und dem Motorantenne (sofern vorhanden) in folgender Reihenfolge anschließen.

- ① Schwarz: Erdung
- ② Gelb: an Autobatterie (konstant 12 V)
- ③ Rot: an Zubehöranschlussklemme
- ④ Blau mit weißem Streifen: an Externe Komponente
- ⑤ Orange mit weißem Streifen: zum Autolichtschalter (nur für KD-LH7R)
- ⑥ Braun: an Mobiltelefon (Weitere Informationen entnehmen Sie bitte der Bedienungsanleitung des Mobiltelefons.)
- ⑦ Andere: an Lautsprecher

**2** Das Antennenkabel anschließen.

**3** Die Kabelbäume am Gerät anschließen.

**Hinweis:** Verfügt Ihr Fahrzeug nicht über eine Zubehöranschlussklemme, die Sicherung von der 1. Sicherungsposition (Erstposition) in die 2. Sicherungsposition versetzen, die rote Leitung (A7) an der (+) Batterieanschlussklemme anschließen.

• Die gelbe Leitung (A4) wird in diesem Fall nicht verwendet.

**Avant de commencer la connexion:** vérifiez attentivement le câblage du véhicule. Une connexion incorrecte peut endommager sérieusement l'appareil. Le fil du cordon d'alimentation et ceux des connecteurs du châssis de la voiture peuvent être différents en couleur.

**1** Connectez les fils de couleur du cordon d'alimentation à la batterie de la voiture, aux enceintes et à l'antenne automatique (s'il y en a une) dans l'ordre suivant.

- ① Noir: à la masse
- ② Jaune: à la batterie de la voiture (12 V constant)
- ③ Rouge: à la prise accessoire
- ④ Bleu avec bande blanche: à l'appareil extérieur
- ⑤ Orange avec bande blanche: à l'interrupteur d'éclairage de la voiture (seulement pour le KD-LH7R)
- ⑥ Marron: à un système de téléphone cellulaire (Pour les détails, se référer aux instructions du téléphone cellulaire.)
- ⑦ Autres: aux enceintes

**2** Connectez le cordon d'antenne.

**3** Finalement, connectez le faisceau de fils à l'appareil.

**Remarque:** Si votre véhicule ne possède pas de borne accessoire, déplacez le fusible de la position de fusible 1 (position originale) à la position de fusible 2 et connectez le fil rouge (A7) à la borne positive (+) de la batterie.

• Le fil jaune (A4) n'est pas utilisé dans ce cas.

**Alvorens de verbindingen tot stand te brengen:** moet u de bedrading in de auto zorgvuldig. Het apparaat kan door verkeerde verbindingen ernstige schade oplopen.

De draden van het stroomkabel verschillen mogelijk van kleur met de aansluitingen op het chassis van de auto.

**1** Sluit de gekleurde snoerdraden van de stroomkabel in de hierna genoemde volgorde aan op de accu van de auto, de luidsprekers en de antenne (indien aanwezig).

- ① Zwart: aarde
- ② Geel: naar de accu van de auto (constant 12 V)
- ③ Rood: naar de aansluitklem van de accessoire
- ④ Blauw met witte streep: naar de schakelaar voor de autoverlichting (alleen voor KD-LH7R)
- ⑤ Oranje met witte streep: naar de schakelaar voor de autoverlichting (alleen voor KD-LH7R)
- ⑥ Bruin: naar het mobiele-telefoonsysteem (Lees voor meer informatie de instructies die bij de mobiele telefoon worden geleverd.)
- ⑦ Andere: naar de speakers

**2** Sluit de antenne aan.

**3** Verbind de draadbundel daarna met het apparaat.

**Opmerking:** Als uw voertuig niet beschikt over een aansluitklem, moet u de zekering verplaatsen van stand 1 (beginstand) naar stand 2 en moet u de rode draad (A7) met de pluspool (+) van de accu verbinden.

• In dit geval wordt de gele draad (A4) niet gebruikt.

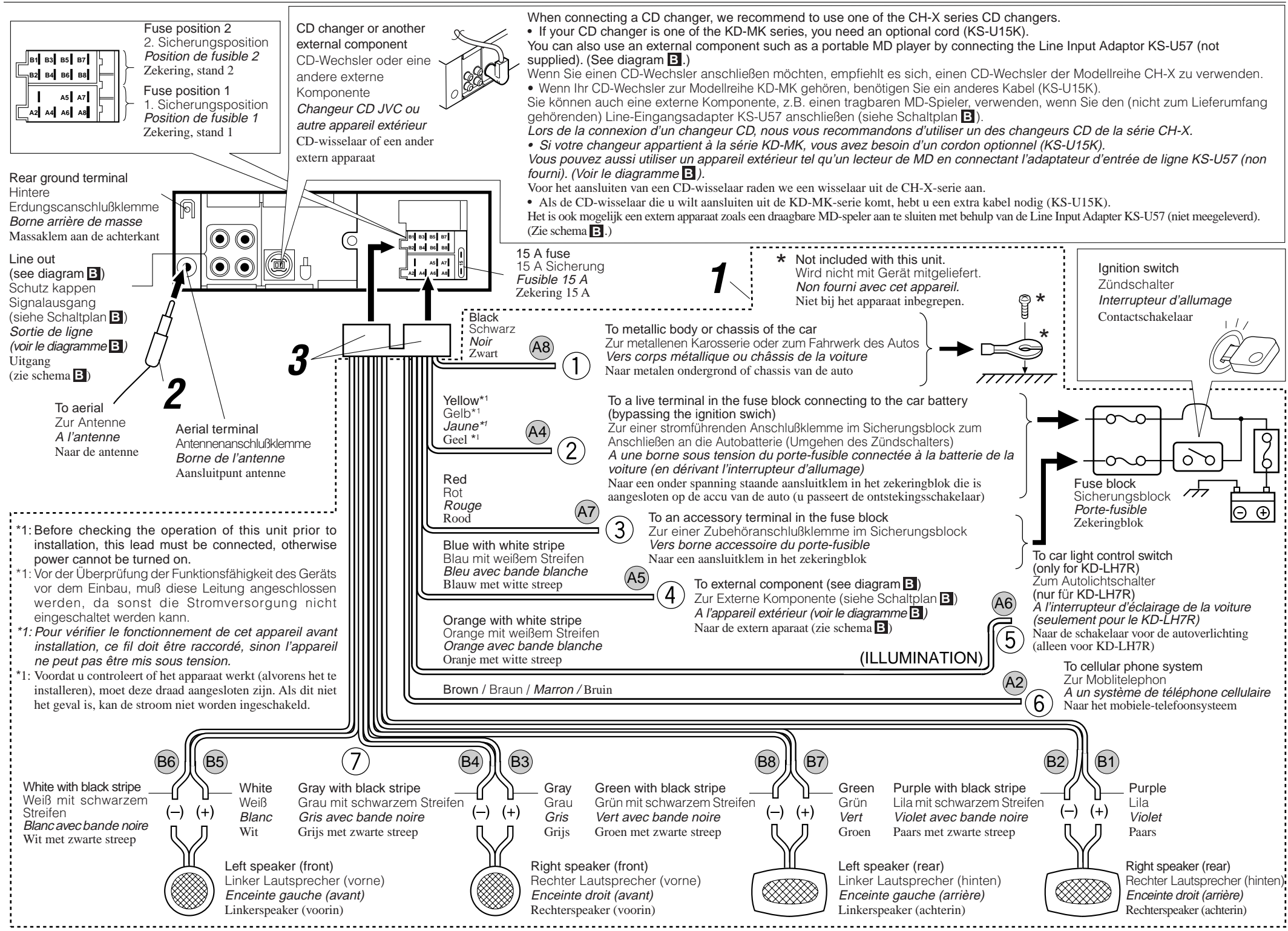

**PRECAUTIONS on power supply and speaker connections:**

- DO NOT connect the speaker leads of the power cord to the car battery; otherwise, the unit will be seriously damaged.
- Connect the black lead (ground), yellow lead (to car battery, constant 12 V), and red lead (to an accessory terminal) correctly.
- BEFORE connecting the speaker leads of the power cord to the speakers, check the speaker wiring in your car.
  - If the speaker wiring in your car is as illustrated in Fig. 1 and Fig. 2 below, DO NOT connect the unit using that original speaker wiring. If you do, the unit will be seriously damaged.
  - Redo the speaker wiring so that you can connect the unit to the speakers as illustrated in Fig. 3.
  - If the speaker wiring in your car is as illustrated in Fig. 3, you can connect the unit using the original speaker wiring in your car.
  - If you are not sure of the speaker wiring of your car, consult your JVC IN-CAR ENTERTAINMENT.

**VORSICHTSMASSREGELN beim Anschließen der Stromversorgung und Lautsprecher:**

- Die Lautsprecherleitungen des Netzkabels NICHT an der Autobatterie anschließen, da sonst das Gerät schwer beschädigt wird.
- Die schwarze Leitung (Erdung), die gelbe Leitung (zur Autobatterie, konstant 12 V) und die rote Leitung (zur Zubehöranschlussklemme) richtig anschließen.
- VOR dem Anschließen der Lautsprecherleitungen des Spannungsversorgungskabels an die Lautsprecher, die Lautsprecherverdrahtung in Ihrem Auto überprüfen.
  - Ist die Lautsprecherverdrahtung wie unten in „Fig. 1“ und „Fig. 2“ abgebildet, das Gerät NICHT mit der Originalverdrahtung der Lautsprecher anschließen, da sonst das Gerät schwer beschädigt wird.
  - Die Lautsprecherverdrahtung erneuern, so daß Sie das Gerät an den Lautsprechern wie in „Fig. 3“ abgebildet anschließen können.
  - Ist die Lautsprecherverdrahtung in Ihrem Auto wie in „Fig. 3“ abgebildet, können Sie das Gerät mit der Originalverdrahtung der Lautsprecher in Ihrem Auto anschließen.
  - Sind Sie sich über die Lautsprecherverdrahtung in Ihrem Auto nicht sicher, wenden Sie sich an Ihren JVC Autoradiohändler.

**PRECAUTIONS sur l'alimentation et la connexion des enceintes:**

- NE CONNECTEZ PAS les fils d'enceintes du cordon d'alimentation à la batterie; sinon, l'appareil serait sérieusement endommagé.
- Connectez correctement le fil noir (à la masse), le fil jaune (à la batterie de la voiture, 12 V constant) et le fil rouge (à la prise accessoire).
- AVANT de connecter les fils d'enceintes du cordon d'alimentation aux enceintes, vérifiez le câblage des enceintes de votre voiture.
  - Si le câblage des enceintes de votre voiture est comme montré sur la Fig. 1 ou Fig. 2 ci-dessous, NE CONNECTEZ PAS l'appareil en utilisant ce câblage original des enceintes. Si vous le faites, l'appareil sera sérieusement endommagé. Recommencez le câblage des enceintes de façon que vous puissiez connecter l'appareil aux enceintes comme montré sur la Fig. 3.
  - Si le câblage des enceintes de votre voiture est comme montré sur la Fig. 3, vous pouvez connecter l'appareil en utilisant ce câblage original d'enceintes pour votre voiture.
  - Si vous n'êtes pas sûrs du câblage d'enceintes de votre voiture, consultez votre revendeur d'autoradios JVC.

**VOORZORGSMAATREGELEN bij het verbinden van de stroomkabel met de speakers:**

- Verbind de speakerdraden van de stroomkabel NIET met de accu van de auto; als u dit wel doet, zal het apparaat ernstige schade oplopen.
- Sluit de zwarte draad (aarde), de gele draad (naar de accu van de auto, constant 12 V) en de rode draad (naar de aansluitklem van de accessoire) op de juiste wijze aan.
- VOORDAT u de speakerdraden van de stroomkabel met de speakers verbindt, moet u de bedrading van de speakers in uw auto controleren.
  - Als de bedrading van de speakers eruitziet zoals hieronder staat afgebeeld in Fig. 1 en Fig. 2, mag het apparaat NIET worden aangesloten met behulp van deze oorspronkelijke speakerbedrading. Als u dat wel doet, zal het apparaat ernstige schade oplopen.
  - Pas de bedrading van de speakers aan, zodat u het apparaat met de speakers kunt verbinden, zoals staat afgebeeld in Fig. 3.
  - Als de bedrading van de speakers eruitziet zoals staat afgebeeld in Fig. 3, kunt u het apparaat aansluiten met behulp van de oorspronkelijke speakerbedrading in uw auto.
  - Als u twijfels hebt over de speakerbedrading in uw auto, moet u contact opnemen met uw JVC car audio dealer raadplegen.

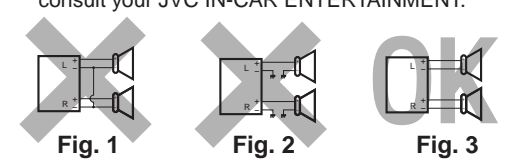



## Connecting the leads / Anschließen der Leitungen / Raccordement des fils / Aansluiting van de gekleurde draden

Twist the core wires when connecting.  
Die Kerndrähte beim Anschließen verdrehen.  
*Torsader les âmes des fils en les raccordant.*  
Draai de kernraden om elkaar heen wanneer u ze wilt aansluiten.

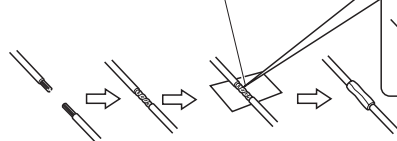

Solder the core wires to connect them securely.  
Die Kerndrähte anlöten, um sie fest anzuschließen.  
*Souder les âmes des fils pour les raccorder entre eux de façon sûre.*  
Soldeer de kernraden zodat ze stevig vast zitten.

### CAUTION / VORSICHT / PRECAUTION / LET OPI!

- To prevent short-circuit, cover the terminals of the UNUSED leads with insulating tape.
- Zur Vermeidung eines Kurzschlusses die Anschlußklemmen der NICHT VERWENDETEN Leitungen mit Isolierklebeband umwickeln.
- Pour éviter les court-circuits, couvrir les bornes des fils qui ne sont PAS utilisés avec de la bande isolante.
- Om kortsluiting te voorkomen, moet u de aansluitklemmen van ONGEBRUIKTE gekleurde draden met isolatieband bedekken.

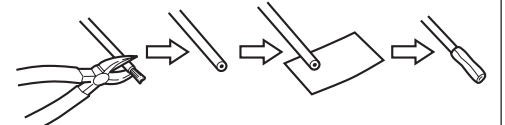

## B Connections Adding Other Equipment / Anschlüsse zum Hinzufügen von anderer Ausrüstung / Raccordement pour ajouter d'autres appareils / Aansluitingen voor het toevoegen van andere apparatuur

### Amplifier / Verstärker / Amplificateur / Versterker

You can connect an amplifier and other equipment to upgrade your car stereo system.

- Connect the remote lead (blue with white stripe) to the remote lead of the other equipment so that it can be controlled through this unit.
- For amplifier only:
  - Connect this unit's line-out terminals to the amplifier's line-in terminals.
  - Disconnect the speakers from this unit, connect them to the amplifier. Leave the speaker leads of this unit unused. (Cover the terminals of these unused leads with insulating tape, as illustrated above.)

Sie können einen Verstärker oder ein anderes Gerät anschließen, um Ihre Autostereoanlage zu erweitern.

- Schließen Sie das Fernbedienungskabel (blau mit weißem Streifen) an das Fernbedienungskabel des anderen Geräts an, so daß es über dieses Gerät gesteuert werden kann.
- Nur für den Verstärker:
  - Die Anschlußklemmen am Ausgang dieses Gerät an den Anschlußklemmen des Eingangs des Verstärkers anschließen.
  - Die Lautsprecher von diesem Gerät abtrennen und am Verstärker anschließen. Die Lautsprecherleitungen dieses Geräts unbenutzt lassen. (Die Anschlußklemmen dieser nicht verwendeten Leitungen mit Isolierklebeband umwickeln, siehe Abbildung oben.)

Vous pouvez connecter un amplificateur ou autre appareil pour améliorer votre système autoradio.

- Connectez le fil de commande à distance (bleu avec bande blanche) au fil de commande à distance de l'autre appareil de façon qu'il puisse être commandé via cet appareil.
- Pour l'amplificateur seulement:
  - Raccorder les bornes de sortie ligne de cet appareil aux bornes d'entrée ligne de l'amplificateur.
  - Déconnectez les enceintes de cet appareil et connectez-les à l'amplificateur. Laissez les fils d'enceintes de cet appareil inutilisés. (Recouvrir les extrémités de ces fils inutilisés avec de la bande isolante comme montré ci-dessus.)

Het is mogelijk om uw autostereosysteem uit te breiden met een versterker of andere apparatuur.

- Verbind de externe kabel (blauw met witte streep) met de externe kabel van het andere apparaat zodat deze op afstand vanaf deze apparaat kan worden bediend.
- Alleen voor een versterker:
  - Verbind de uitgang van het apparaat met de ingang van de versterker.
  - Koppel de speakers van dit apparaat los en verbind ze aan de versterker. Gebruik de speakerdraden van dit apparaat niet. (Plak de aansluitklemmen van deze speakerdraden met isolatieband af zoals hierboven is afgebeeld.)

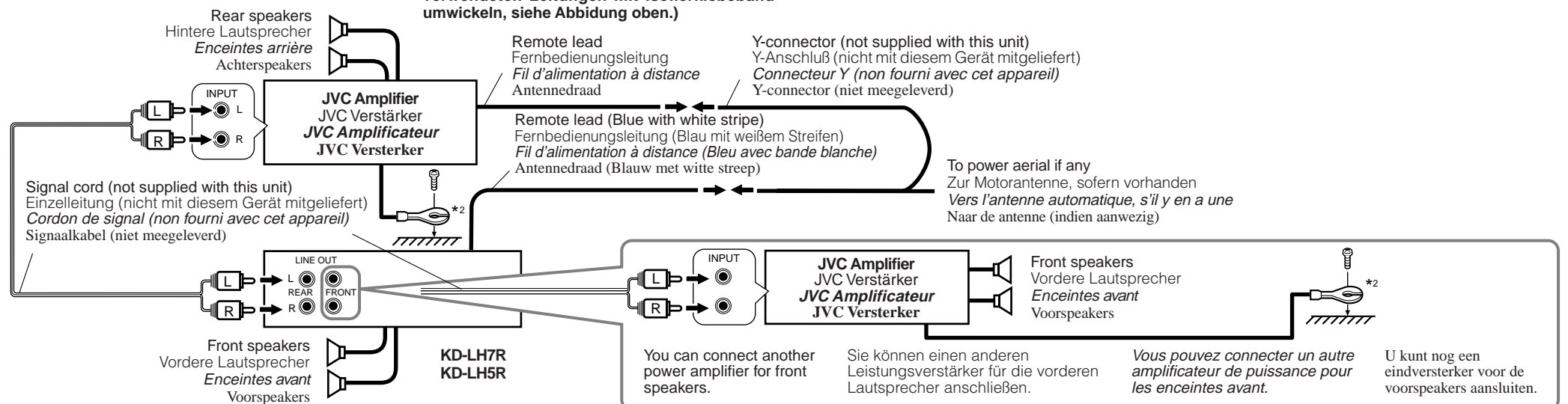

- \*2 Firmly attach the ground wire to the metallic body or to the chassis of the car—to the place not coated with paint (if coated with paint, remove the paint before attaching the wire). Failure to do so may cause damage to this unit.
- \*2 Verbinden Sie den Erdungsleiter mit der Karosserie oder dem Rahmen des Fahrzeugs. Die Kontaktstelle darf nicht lackiert sein (sollte die Kontaktstelle lackiert sein, entfernen Sie den Lack der Kontaktstelle, bevor Sie den Leiter befestigen). Wenn der Erdungsleiter nicht ordnungsgemäß angeschlossen wird, kann dieses Gerät beschädigt werden.
- \*2 Attachez solidement le fil de mise à la masse au châssis métallique de la voiture—à un endroit qui n'est pas recouvert de peinture (s'il est recouvert de peinture, enlevez d'abord la peinture avant d'attacher le fil). L'appareil peut être endommagé si cela n'est pas fait correctement.
- \*2 Bevestig de aarddraad goed met een metalen onderdeel of het chassis van de auto—bevestig op een niet-gelakt gedeelte (indien gelakt, schuur dan af alvorens de draad te bevestigen). Het toestel kan worden beschadigd indien de aarddraad niet goed is aangesloten.

## CD changer and DAB tuner / CD-Wechsler und DAB-Tuner / Changeur CD et tuner DAB / CD-wisselaar en DAB-tuner

You can connect a JVC CD changer and/or a JVC DAB (Digital Audio Broadcasting) tuner.

- For their connections, refer to the instructions supplied with them.

Sie können einen CD-Wechsler und/oder einen DAB-Tuner (Tuner für digitalen Rundfunk) von JVC anschließen.

- Weitere Informationen über den Anschluß können Sie der Bedienungsanleitung entnehmen, die dem jeweiligen Gerät beiliegt.

Vous pouvez connecter un changeur CD JVC et/ou un tuner DAB (Digital Audio Broadcast) JVC.

- Pour leurs connexions, référez-vous aux modes d'emploi qui les accompagnent.

Het is mogelijk een JVC CD-wisselaar en/of JVC DAB-tuner (Digital Audio Broadcasting) aan te sluiten.

- Zie de instructies van deze apparaten voor meer informatie over het tot stand brengen van deze aansluiting.

Connecting cord supplied with your DAB tuner  
Verbindingskabel, dat zum Lieferumfang des DAB-Tuners gehört  
*Cordon de connexion fourni avec votre tuner DAB*  
Verbindingskabel die met de DAB-tuner wordt meegeleverd

Connecting cord supplied with your CD changer  
Verbindingskabel, dat zum Lieferumfang des CD-Wechsler gehört  
*Cordon de connexion fourni avec votre changeur CD*  
Verbindingskabel die met de CD-wisselaar wordt meegeleverd

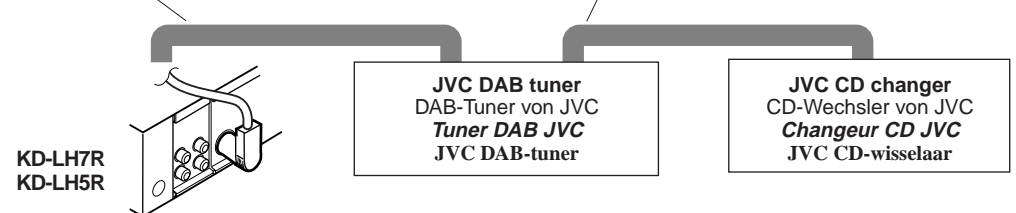

Connecting cord supplied with your DAB tuner or CD changer  
Verbindingskabel, dat zum Lieferumfang des DAB-Tuners oder CD-Wechslers gehört  
*Cordon de connexion fourni avec votre tuner DAB ou changeur CD*  
Verbindingskabel die met de DAB-tuner of CD-wisselaar wordt meegeleverd

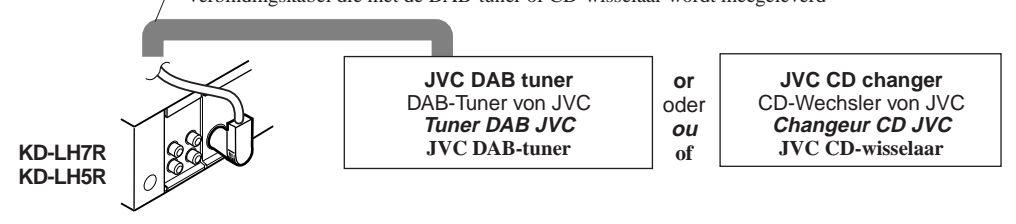

- You can connect both components in series as illustrated above.
- Es ist möglich, beide Komponenten in einer Serienschaltung entsprechend der obigen Darstellung anzuschließen.
- Vous pouvez connecter les deux appareils en série comme montré ci-dessus.
- Beide apparaten zijn volgens bovenstaande illustratie in serie aan te sluiten.

- CAUTION / VORSICHT / PRECAUTION / LET OPI!
- Before connecting the CD changer and/or the DAB tuner, make sure that the unit is turned off.
- Bevor Sie den CD-Wechsler und/oder den DAB-Tuner anschließen, vergewissern Sie sich, daß das Gerät ausgeschaltet ist.
- Avant de connecter le changeur CD et/ou le tuner DAB, s'assurer que l'unité est éteinte.
- Zorg ervoor dat de apparat is uitgeschakeld alvorens u de en/of DAB-tuner CD-wisselaar aansluit.

## External Component / Externe Komponente / Appareil extérieur / Extern apparaat

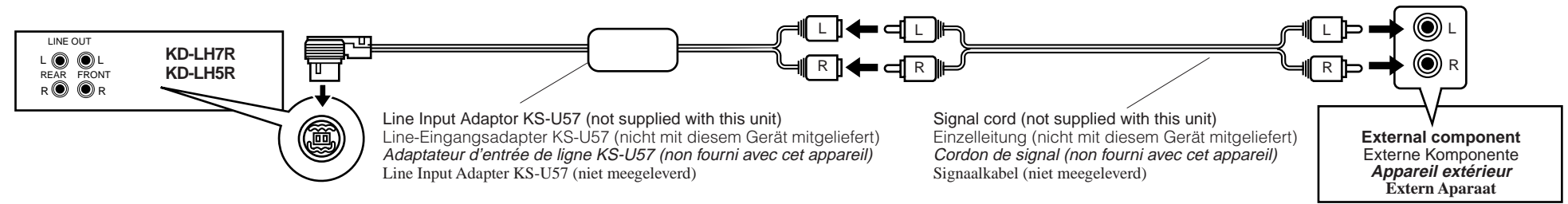

## TROUBLESHOOTING

- The fuse blows.**
  - Are the red and black leads connected correctly?
- Power cannot be turned on.**
  - Is the yellow lead connected?
- No sound from the speakers.**
  - Is the speaker output lead short-circuited?
- Sound is distorted.**
  - Is the speaker output lead grounded?
  - Are the "—" terminals of L and R speakers grounded in common?
- Unit becomes hot.**
  - Is the speaker output lead grounded?
  - Are the "—" terminals of L and R speakers grounded in common?

## FEHLERSUCHE

- Die Sicherung brennt durch.**
  - Sind die roten und schwarzen Leitungen richtig angeschlossen?
- Stromversorgung kann nicht eingeschaltet werden.**
  - Ist die gelbe Leitung angeschlossen?
- Kein Ton aus den Lautsprechern.**
  - Ist die Lautsprecherausgangsleitung kurzgeschlossen?
- Ton verzerrt.**
  - Ist die Lautsprecherausgangsleitung geerdet?
  - Sind die (—) Anschlußklemmen der linken und rechten Lautsprecher zusammen geerdet?
- Gerät wird heiß.**
  - Ist die Lautsprecherausgangsleitung geerdet?
  - Sind die (—) Anschlußklemmen der linken und rechten Lautsprecher zusammen geerdet?

## EN CAS DE DIFFICULTES

- Le fusible saute.**
  - Les fils rouge et noir sont-ils raccordés correctement?
- L'appareil ne peut pas être mise sous tension.**
  - Le fil jaune est-elle raccordée?
- Pas de son des enceintes.**
  - Le fil de sortie d'enceinte est-il court-circuité?
- Le son est déformé.**
  - Le fil de sortie d'enceinte est-il à la masse?
  - Les bornes "—" des enceintes gauche et droit sont-elles mises ensemble à la masse?
- L'appareil devient chaud.**
  - Le fil de sortie d'enceinte est-il à la masse?
  - Les bornes "—" des enceintes gauche et droit sont-elles mises ensemble à la masse?

## PROBLEMEN OPLOSSEN

- De zekering slaat door.**
  - Zijn de rode en de zwarte draden op de juiste manier aangesloten?
- De stroom kan niet worden ingeschakeld.**
  - Is de gele draad aangesloten?
- Er komt geen geluid uit de speakers.**
  - Is de uitgaande speakerdraad kortgesloten?
- Het geluid wordt vervormd.**
  - Is de uitgaande speakerdraad geaard?
  - Zijn de minpolen van de linker- en de rechterspeakers gemeenschappelijk geaard?
- Het apparaat raakt verhit.**
  - Is de uitgaande speakerdraad geaard?
  - Zijn de minpolen van de linker- en de rechterspeakers gemeenschappelijk geaard?

## Free Manuals Download Website

<http://myh66.com>

<http://usermanuals.us>

<http://www.somanuals.com>

<http://www.4manuals.cc>

<http://www.manual-lib.com>

<http://www.404manual.com>

<http://www.luxmanual.com>

<http://aubethermostatmanual.com>

Golf course search by state

<http://golfingnear.com>

Email search by domain

<http://emailbydomain.com>

Auto manuals search

<http://auto.somanuals.com>

TV manuals search

<http://tv.somanuals.com>