

# JVC



**CD RECEIVER**

**KD-SX980**

ENGLISH

**RECEPTOR CON CD**

**KD-SX980**

ESPAÑOL

**RECEPTEUR CD**

**KD-SX980**

FRANÇAIS

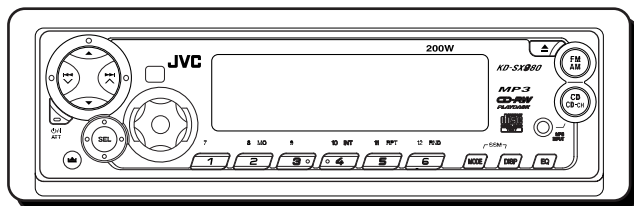
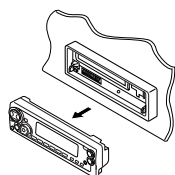

**MP3  
CD-RW  
PLAYBACK**

**COMPACT  
disc  
DIGITAL AUDIO  
TEXT**

For installation and connections, refer to the separate manual.  
Para la instalación y las conexiones, refiérase al manual separado.  
Pour l'installation et les raccordements, se référer au manuel séparé.

## **INSTRUCTIONS**

**MANUAL DE INSTRUCCIONES**  
**MANUEL D'INSTRUCTIONS**

### **For customer Use:**

Enter below the Model No. and Serial No. which are located on the top or bottom of the cabinet. Retain this information for future reference.

Model No. \_\_\_\_\_

Serial No. \_\_\_\_\_

GET0091-001A

[J]

**INFORMATION (For U.S.A.)**

This equipment has been tested and found to comply with the limits for a Class B digital device, pursuant to Part 15 of the FCC Rules. These limits are designed to provide reasonable protection against harmful interference in a residential installation. This equipment generates, uses, and can radiate radio frequency energy and, if not installed and used in accordance with the instructions, may cause harmful interference to radio communications. However, there is no guarantee that interference will not occur in a particular installation. If this equipment does cause harmful interference to radio or television reception, which can be determined by turning the equipment off and on, the user is encouraged to try to correct the interference by one or more of the following measures:

- Reorient or relocate the receiving antenna.
- Increase the separation between the equipment and receiver.
- Connect the equipment into an outlet on a circuit different from that to which the receiver is connected.
- Consult the dealer or an experienced radio/TV technician for help.

**IMPORTANT FOR LASER PRODUCTS****Precautions:**

1. CLASS 1 LASER PRODUCT
2. **CAUTION:** Invisible laser radiation when open and interlock failed or defeated. Avoid direct exposure to beam.
3. **CAUTION:** Do not open the top cover. There are no user-serviceable parts inside. Leave all servicing to qualified service personnel.
4. **CAUTION:** This CD player uses invisible laser radiation, however, is equipped with safety switches to prevent radiation emission when unloading CDs. It is dangerous to defeat the safety switches.
5. **CAUTION:** Use of controls, adjustments or performance of procedures other than those specified herein may result in hazardous radiation exposure.

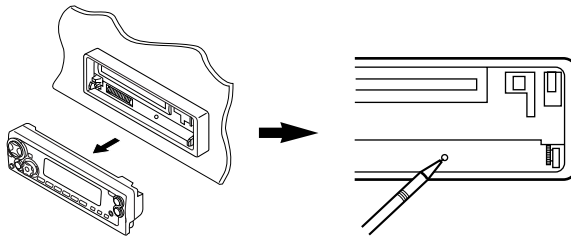
**How to reset your unit**

After detaching the control panel, press the reset button on the panel holder using a ball-point pen or a similar tool.

This will reset the built-in microcomputer.

**Note:**

*Your preset adjustments — such as preset channels or sound adjustments — will also be erased.*

**BEFORE USE****\*For safety....**

- Do not raise the volume level too much, as this will block outside sounds, making driving dangerous.
- Stop the car before performing any complicated operations.

**\*Temperature inside the car....**

*If you have parked the car for a long time in hot or cold weather, wait until the temperature in the car becomes normal before operating the unit.*

Thank you for purchasing a JVC product. Please read all instructions carefully before operation, to ensure your complete understanding and to obtain the best possible performance from the unit.

# CONTENTS

How to reset your unit .....	2	<b>MP3 OPERATIONS</b> .....	<b>16</b>
How to use the number buttons .....	3	Playing an MP3 disc .....	16
<b>LOCATION OF THE BUTTONS</b> .....	<b>4</b>	Locating a file or particular portion on an MP3 disc .....	17
Control panel .....	4	Selecting MP3 playback modes .....	19
Preparing the remote controller .....	5	<b>SOUND ADJUSTMENTS</b> .....	<b>21</b>
Remote controller .....	6	Adjusting the sound .....	21
<b>BASIC OPERATIONS</b> .....	<b>7</b>	Selecting preset sound modes (C-EQ: custom equalizer) .....	22
Turning on the power .....	7	Storing your own sound adjustments .....	23
<b>RADIO BASIC OPERATIONS</b> .....	<b>8</b>	<b>OTHER MAIN FUNCTIONS</b> .....	<b>24</b>
Listening to the radio .....	8	Setting the clock .....	24
Storing stations in memory .....	9	Changing the general settings (PSM) .....	24
Tuning in to a preset station .....	10	Assigning names to the sources .....	27
<b>CD OPERATIONS</b> .....	<b>11</b>	Detaching the control panel .....	29
Playing a CD .....	11	<b>CD CHANGER OPERATIONS</b> .....	<b>30</b>
Locating a track or particular portion on a disc .....	12	Playing CDs .....	30
Selecting CD playback modes .....	12	Selecting CD playback modes .....	32
Prohibiting CD ejection .....	13	<b>EXTERNAL COMPONENT OPERATIONS</b> ..	<b>33</b>
Playing a CD Text .....	13	Playing an external component .....	33
<b>MP3 INTRODUCTION</b> .....	<b>14</b>	<b>TROUBLESHOOTING</b> .....	<b>34</b>
What is MP3? .....	14	<b>MAINTENANCE</b> .....	<b>36</b>
How are MP3 files recorded and played back? .....	14	Handling discs .....	36
		<b>SPECIFICATIONS</b> .....	<b>37</b>

## How to use the number buttons:

If you press MODE, the unit goes into functions mode and the number buttons work as different function buttons.

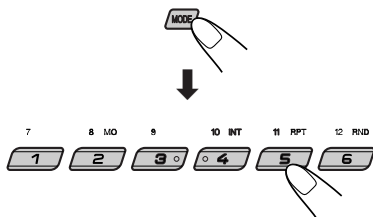

Time countdown indicator

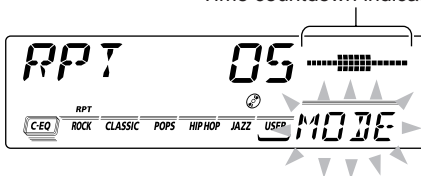

Ex.: When you press button 5 to enter the RPT function mode.

**To use these buttons as number buttons again after pressing MODE, wait for 5 seconds without pressing any number button until the functions mode is cleared.**

- Pressing MODE again also clears the functions mode.

## CAUTION on Volume Setting

CDs produce very little noise compared with other sources. If the volume level is adjusted for the tuner, for example, the speakers may be damaged by the sudden increase in the output level. Therefore, lower the volume before playing a disc and adjust it as required during playback.



# LOCATION OF THE BUTTONS

ENGLISH

## Control panel

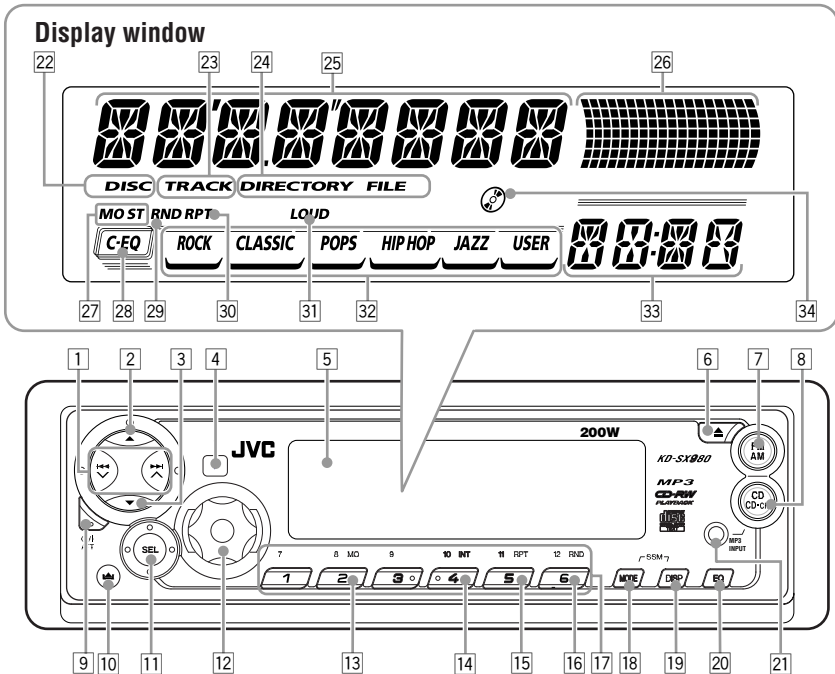

- 1 ◀◀ ▶▶ buttons
- 2 ▲ (up) button
- 3 ▼ (down) button
- 4 Remote sensor
- 5 Display window
- 6 ▲ (eject) button
- 7 FM AM button
- 8 CD CD-CH/MP3 INPUT button
- 9 ⏻/I/ATT (standby/on/attenuator) button
- 10 ⏏ (control panel release) button
- 11 SEL (select) button
- 12 Control dial
- 13 MO (monaural) button
- 14 INT (intro scan) button
- 15 RPT (repeat) button
- 16 RND (random) button
- 17 Number buttons
- 18 MODE button
  - Also functions as SSM buttons when pressed together with DISP (display) button.
- 19 DISP (display) button
  - Also functions as SSM buttons when pressed together with MODE button.

- 20 EQ (equalizer) button
- 21 MP3 INPUT jack

### Display window

- 22 DISC indicator
- 23 TRACK indicator
- 24 MP3 indicators  
DIRECTORY, FILE
- 25 Main display
- 26 Volume (or audio) level indicator  
Equalization pattern indicator
- 27 Tuner reception indicators  
MO (monaural), ST (stereo)
- 28 C-EQ (custom equalizer) indicator
- 29 RND (random) indicator
- 30 RPT (repeat) indicator
- 31 LOUD (loudness) indicator
- 32 Sound mode indicators  
ROCK, CLASSIC, POPS, HIP HOP, JAZZ,  
USER.
- 33 Source/clock display
- 34 CD-in indicator



## Preparing the remote controller

Before using the remote controller:

- Aim the remote controller directly at the remote sensor on the main unit. Make sure there is no obstacle in between.

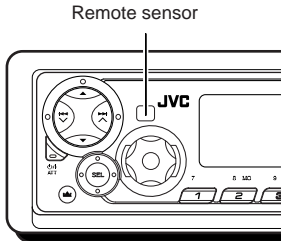

- Do not expose the remote sensor to strong light (direct sunlight or artificial lighting).

### Installing the battery

When the controllable range or effectiveness of the remote controller decreases, replace the battery.

#### 1. Remove the battery holder.

- 1) Push out the battery holder in the direction indicated by the arrow using a ball-point pen or a similar tool.
- 2) Remove the battery holder.

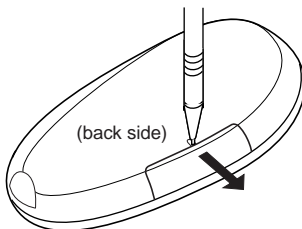

#### 2. Place the battery.

Slide the battery into the holder with the + side facing upwards so that the battery is fixed in the holder.

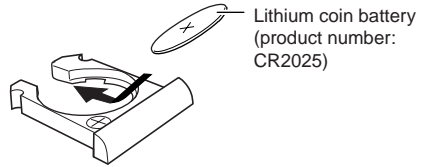

#### 3. Return the battery holder.

Insert again the battery holder pushing it until you hear a clicking sound.

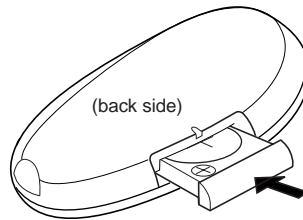

#### **WARNING:**

- Store the battery in a place where children cannot reach.  
If a child accidentally swallows the battery, consult a doctor immediately.
- Do not recharge, short, disassemble or heat the battery or dispose it in a fire.  
Doing any of these things may cause the battery to give off heat, crack or start a fire.
- Do not leave the battery with other metallic materials.  
Doing this may cause the battery to give off heat, crack or start a fire.
- When throwing away or saving the battery, wrap it in tape and insulate; otherwise, the battery may start to give off heat, crack or start a fire.
- Do not poke the battery with tweezers or similar tools.  
Doing this may cause the battery to give off heat, crack or start a fire.

#### **CAUTION:**

DO NOT leave the remote controller in a place (such as dashboards) exposed to direct sunlight for a long time. Otherwise, it may be damaged.



# Remote controller

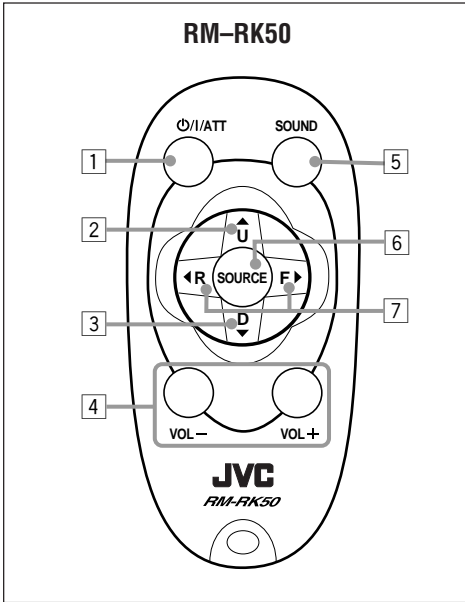

- 1 • Turns on the unit if pressed when the unit is turned off.
  - Turns off the unit if pressed and held until “SEE YOU” appears on the display.
  - Drops the volume level in a moment if pressed briefly. Press again to resume the volume.
- 2 • Selects the band while listening to the radio. Each time you press the button, the band changes.
  - Skips to the next disc while listening to the CD changer. Each time you press the button, the disc number increases, and the selected disc starts playing.
  - Skips to the first file of the next directory while listening to an MP3 disc. Each time you press the button, you can move to the next directory and start playing the first file.

- 3 • Selects the preset stations while listening to the radio. Each time you press the button, the preset station number increases, and the selected station is tuned into.
  - Skips to the previous disc while listening to the CD changer. Each time you press the button, the disc number decreases, and the selected disc starts playing.
  - Skips to the first file of the previous directory while listening to an MP3 disc. Each time you press the button, you can move to the previous directory and start playing the first file.
- 4 Functions the same as the control dial on the main unit.

**NOTE:** This button does not function for the preferred setting mode adjustment.
- 5 Selects the sound mode (C-EQ). Each time you press the button, the sound mode (C-EQ) changes.
- 6 Selects the source. Each time you press the button, the source changes.
- 7 • Searches stations while listening to the radio.
  - Fast-forwards or reverses the track/file if pressed and held while listening to a disc.
  - Skips to the beginning of the next track/file or goes back to the beginning of the current (or previous) tracks/files if pressed briefly while listening to a disc.

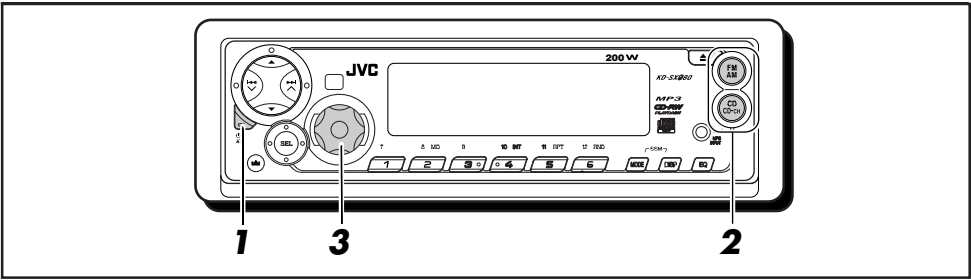

## Turning on the power

### 1 Turn on the power.



#### Note on One-Touch Operation:

When you select a source in step 2 below, the power automatically comes on. You do not have to press this button to turn on the power.

### 2 Select the source.

To select the tuner, press FM AM repeatedly.

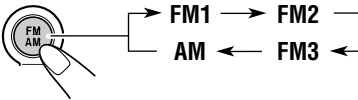

To select CD, CD changer (or "LINE IN"\*), press CD CD-CH repeatedly.

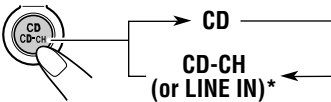

\* If "LINE IN" does not appear on the display, see page 27 and select the external input ("LINE IN").

To select "AUX IN" (component connected to the MP3 INPUT jack on the control panel), press and hold CD CD-CH.



### 3 Adjust the volume.

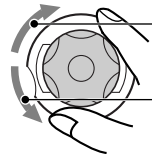

To increase the volume.

To decrease the volume.

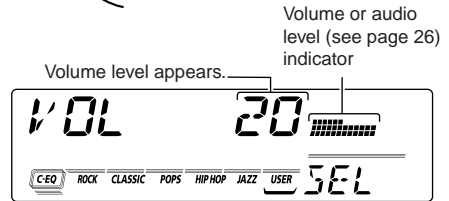

Volume or audio level (see page 26) indicator

Volume level appears.

### 4 Adjust the sound as you want. (See pages 21 – 23.)

#### To drop the volume in a moment

Press **I/ATT** briefly while listening to any source. "ATT" starts flashing on the display, and the volume level will drop in a moment.

To resume the previous volume level, press the button briefly again.

- If you turn the control dial clockwise, you can also restore the sound.

#### To turn off the power

Press **I/ATT** for more than one second. "SEE YOU" appears, then the unit turns off.

#### Note:

When you use this unit for the first time, set the built-in clock correctly, see page 24.

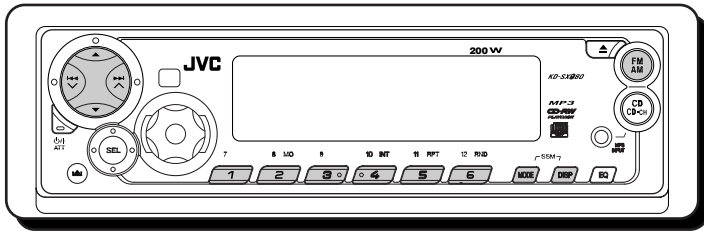

## Listening to the radio

You can use either automatic searching or manual searching to tune in to a particular station.

### Searching a station automatically: Auto search

- 1 Select the band (FM1 – 3, AM).

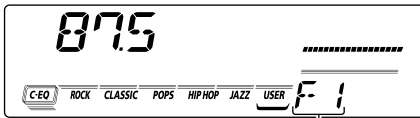
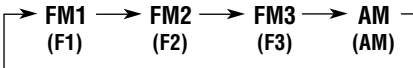

Selected band appears.\*

\* When "CLOCK" is set to "ON" (see page 26), the band indication will soon change to the clock time.

**Note:**

This receiver has three FM bands (FM1, FM2, FM3). You can use any one of them to listen to an FM broadcast.

- 2 Start searching a station.

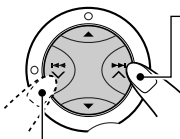

Press ►►► ▲ to search stations of higher frequencies.

Press ◄◄◄ ▼ to search stations of lower frequencies.

While searching stations, "SEEK" appears on the display.

When a station is received, searching stops.

**To stop searching before a station is received,** press the same button you have pressed for searching.

### Searching a station manually: Manual search

- 1 Select the band (FM1 – 3, AM).

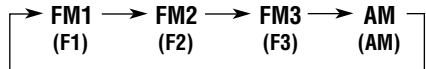

**Note:**

This receiver has three FM bands (FM1, FM2, FM3). You can use any one of them to listen to an FM broadcast.

- 2 Press and hold ►►► ▲ or ◄◄◄ ▼ until "MANU (manual)" starts flashing on the display.

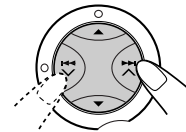

Selected band appears.

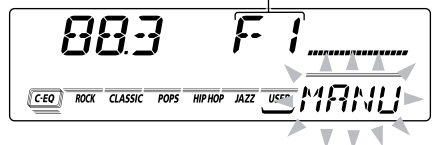



### 3 Tune in to a station you want while "MANU" is flashing.

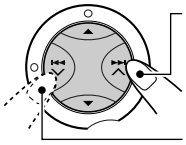

Press ►►▲ to tune in to stations of higher frequencies.

Press ◀◀▼ to tune in to stations of lower frequencies.

- If you release your finger from the button, the manual mode will automatically turn off after 5 seconds.
- If you hold down the button, the frequency keeps changing (in 200 kHz intervals for FM and 10 kHz for AM) until you release the button.

### When an FM stereo broadcast is hard to receive:



- 1 Press MODE to enter the functions mode while listening to an FM stereo broadcast. "MODE" appears on the lower part of the display, and the number buttons work as different function buttons.

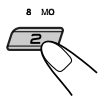

- 2 Press MO (monaural), while "MODE" is still on the display, so that the MO indicator lights up on the display. Then, each time you press MO (monaural), the MO indicator lights up and goes off alternately.

Lights up when receiving an FM broadcast in stereo.

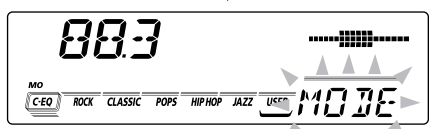
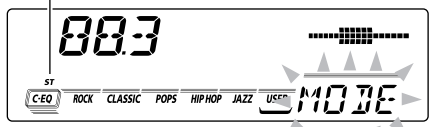

When the MO indicator is lit on the display, the sound you hear becomes monaural but the reception will be improved (the ST indicator goes off).

## Storing stations in memory

You can use one of the following two methods to store broadcasting stations in memory.

- Automatic preset of FM stations: SSM (Strong-station Sequential Memory)
- Manual preset of both FM and AM stations

### FM station automatic preset: SSM

You can preset 6 local FM stations in each FM band (FM1, FM2 and FM3).

#### 1 Select the FM band (FM1 – 3) you want to store FM stations into.



Each time you press the button, the band changes as follows:

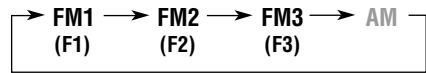

#### 2 Press and hold both buttons for more than 2 seconds.

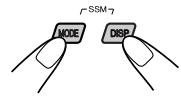

"SSM" appears, then disappears when automatic preset is over.

Local FM stations with the strongest signals are searched and stored automatically in the band number you have selected (FM1, FM2 or FM3). These stations are preset in the number buttons — No.1 (lowest frequency) to No.6 (highest frequency). When automatic preset is over, the station stored in number button 1 will be automatically tuned in.



## Manual preset

You can preset up to 6 stations in each band (FM1, FM2, FM3 and AM) manually.

Ex.: Storing an FM station of 88.3 MHz into the preset number 1 of the FM1 band

### 1 Select the band (FM1 – 3, AM) you want to store stations into (in this example, FM1).



Each time you press the button, the band changes as follows:

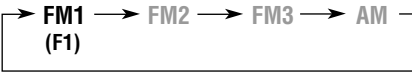

### 2 Tune in to a station of 88.3 MHz.

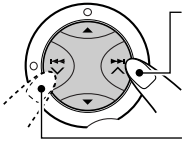

Press **▶▶ ▲** to tune in to stations of higher frequencies.

Press **◀◀ ▼** to tune in to stations of lower frequencies.

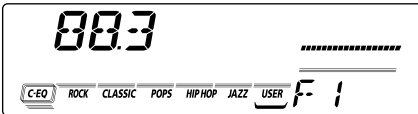

### 3 Press and hold the number button (in this example, 1) for more than 2 seconds.

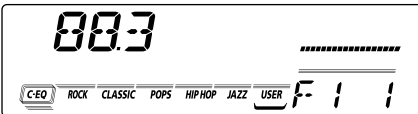

Selected band/preset number and "MEMO" (memory) appear alternately for a while.

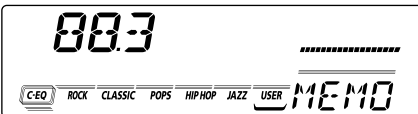

### 4 Repeat the above procedure to store other stations into other preset numbers.

#### Notes:

- A previously preset station is erased when a new station is stored in the same preset number.
- Preset stations are erased when the power supply to the memory circuit is interrupted (for example, during battery replacement). If this occurs, preset the stations again.

## Tuning in to a preset station

You can easily tune in to a preset station. Remember that you must store stations first. If you have not stored them yet, see "Storing stations in memory" on pages 9 and 10.

### 1 Select the band (FM1 – 3, AM).

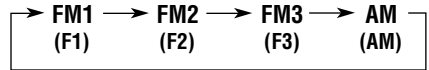

### 2 Select the number (1 – 6) for the preset station you want.

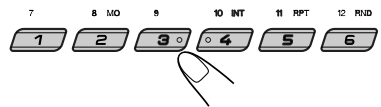

#### Note:

You can also use the **▲** (up) or **▼** (down) buttons on the unit to select the next or previous preset stations. Each time you press the **▲** (up) or **▼** (down) buttons, the next or previous preset station is tuned in.

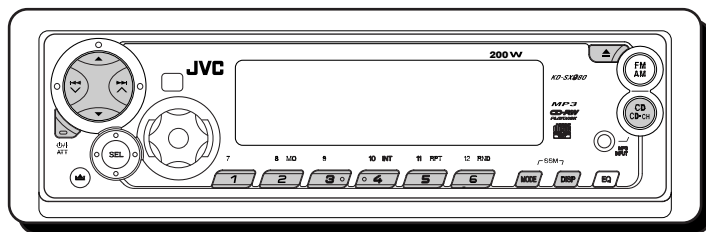

## Playing a CD

### 1 Open the control panel.

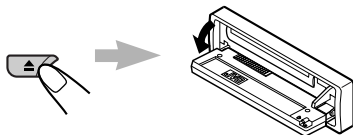

**Note:**

When an external component is connected to the MP3 INPUT jack on the control panel, be careful of handling a CD.

### 2 Insert a disc into the loading slot.

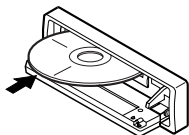

The unit turns on, draws the disc and starts playback automatically.

### 3 Close the control panel by hand.

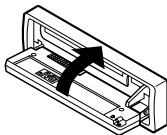

The CD-in indicator lights up.

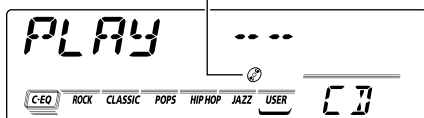

Total playing time of the inserted disc

Total track number of the inserted disc

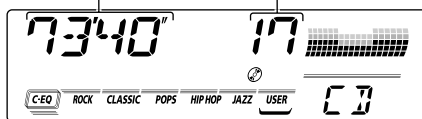

Elapsed playing time

Current track

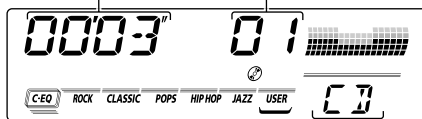

Changes to the clock time when "CLOCK" is set to "ON" (see page 26).

**Notes:**

- When a disc is in the loading slot, selecting "CD" as the source starts CD play.
- When a disc is inserted upside down, the disc automatically ejects (if the control panel is open). If the control panel is closed, "PLEASE" and "EJECT" appear alternately.
- When you open the control panel by pressing ▲, the CD automatically ejects.

### To stop play and eject the disc

Press ▲.

CD play stops, the control panel opens, then the CD automatically ejects from the loading slot. If you change the source, the CD play also stops (without ejecting the CD this time).

**Notes:**

- If the ejected disc is not removed within 15 seconds, the disc is automatically inserted again into the loading slot to protect it from dust. (CD play will not start this time.)
- You can eject the CD even when the unit is turned off.



## Locating a track or particular portion on a disc

### To fast-forward or reverse the track

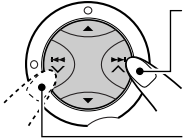

Press and hold **▶▶▶ ▲** while playing a disc, to fast-forward the track.

Press and hold **◀◀◀ ▼** while playing a disc, to reverse the track.

### To go to the next track or the previous tracks

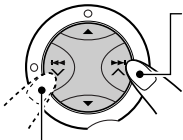

Press **▶▶▶ ▲** briefly while playing a disc, to go ahead to the beginning of the next track. Each time you press the button consecutively, the beginning of the next tracks is located and played back.

Press **◀◀◀ ▼** briefly while playing a disc, to go back to the beginning of the current track. Each time you press the button consecutively, the beginning of the previous tracks is located and played back.

### To go to a particular track directly

Press the number button corresponding to the track number to start its playback.

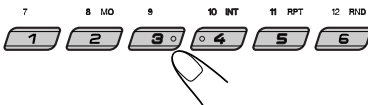

- To select a track number from 1 – 6:  
Press 1 (7) – 6 (12) briefly.
- To select a track number from 7 – 12:  
Press and hold 1 (7) – 6 (12) for more than 1 second.

## Selecting CD playback modes

### To play back tracks at random (Random Play)

You can play back all tracks on the disc at random.



- 1 Press **MODE** to enter the functions mode while playing a disc. "MODE" appears on the lower part of the display, and the number buttons work as different function buttons.



- 2 Press **RND** (random), while "MODE" is still on the display, so that the RND indicator lights up on the display. Then, each time you press RND (random), the random play mode turns on and off alternately.

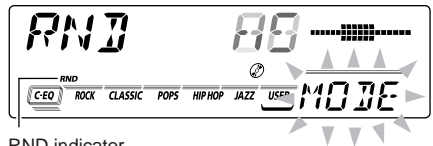

RND indicator

When the random mode is turned on, the RND indicator lights up on the display and a track randomly selected starts playing.

### To play back tracks repeatedly (Repeat Play)

You can play back the current track repeatedly.



- 1 Press **MODE** to enter the functions mode while playing a disc. "MODE" appears on the lower part of the display, and the number buttons work as different function buttons.



- 2 Press **RPT** (repeat), while "MODE" is still on the display, so that the RPT indicator lights up on the display. Then, each time you press RPT (repeat), the repeat play mode turns on and off alternately.

Track number of the currently playing track



RPT indicator

When the repeat mode is turned on, the RPT indicator lights up on the display.



## To play back only intros (Intro Scan)

You can play back the first 15 seconds of each track sequentially.



1 Press MODE to enter the functions mode while playing a disc. "MODE" appears on the lower part of the display, and the number buttons work as different function buttons.



2 Press INT (intro), while "MODE" is still on the display. Each time you press INT (intro) while playing a disc, the intro scan mode turns on and off alternately.

Track number of the currently playing track

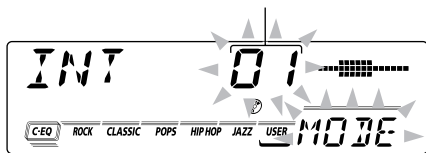

When the intro scan mode is turned on, "INT" appears on the display for 5 seconds and the track number flashes.

## Prohibiting CD ejection

You can prohibit CD ejection and can lock a disc in the loading slot.

While pressing CD CD-CH, press and hold  $\odot$ /I/ATT for more than 2 seconds.



"NO EJECT" flashes on the display for about 5 seconds, and the disc is locked and cannot be ejected.

To cancel the prohibition and unlock the disc, press  $\odot$ /I/ATT again for more than 2 seconds, while pressing CD CD-CH.

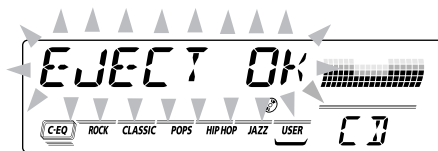

"EJECT OK" flashes on the display for about 5 seconds, and the disc is unlocked.

## Playing a CD Text

In a CD Text, some information about the disc (its disc title, performer and track title) is recorded. You can show these disc information on the display.

Select text display mode while playing a CD Text.



Each time you press the button, the display changes as follows:



### Notes:

- When the disc title/performer is shown, the DISC indicator lights up.
- When the track title is shown, the TRACK indicator lights up.
- The display shows up to 8 characters at one time and scrolls if there are more than 8 characters. Some characters or symbols will not be shown (and be blanked) on the display. (Ex. "ABC&d#" ⇒ "ABCA D ")
- When you press DISP (display) while playing a conventional CD, "NO NAME" appears for the disc title/performer and the track title.



# MP3 INTRODUCTION

## What is MP3?

MP3 is an abbreviation of Motion Picture Experts Group (or MPEG) Audio Layer 3. MP3 is simply a file format with a data compression ratio of 1:10 (128 Kbps\*). That means, by using MP3 format, one CD-R or CD-RW can contain 10 times as much data volume as a regular CD can.

\* Bit rate is the average number of bits that one second of audio data will consume. The unit used is Kbps (1000 bits/second). To get a better audio quality, choose a higher bit rate. The most popular bit rate for encoding is 128 Kbps.

This unit is incorporated with an MP3 decoder. You can play back MP3 files (tracks) recorded on CD-Rs, CD-RWs, and CD-ROMs.

## Compatible with ID3v1

Extra information data such as album title, performer name, song title, recording year, music genre and a brief comment can be stored within an MP3 file.

This unit can show ID3v1 tags (album name, performer name and song title) on the display. (See page 27.)

- Some characters cannot be shown correctly.
- This unit is not compatible with ID3v2.

### Other Main Features in this unit:

- Maximum number of directories/files: 289 (Total)
- Available characters for directory/file names: A–Z, 0–9, \_ (underscore)
- Maximum number of characters for file name (ISO 9660 Level 1): 12 (inclusive of separation mark—“.” and extension code—“mp3”)
- (ISO 9660 Level 2): 31 (inclusive of separation mark—“.” and extension code—“mp3”)
- (Joliet): 64 (inclusive of separation mark—“.” and extension code—“mp3”)
- Maximum number of characters for directory name: 31

## Precautions when recording MP3 files on a CD-R or CD-RW

This unit can only read MP3 files that are recorded in the format that is compliant with ISO 9660 Level 1, Level 2 or Joliet.

## How are MP3 files recorded and played back?

MP3 “files (tracks)” can be recorded in “directories (folders)”—in PC terminology. During recording, the files and directories can be arranged in a way similar to arranging files and directories/folders of computer data.

“Root” is similar to the root of a tree. Every file and directory can be linked to and be accessed from the root.

Playback order, file search order, and directory search order of the MP3 files recorded on a disc are determined by the writing (or encoding) application; therefore, playback order may be different from the one you have intended while recording the directories and the files.

The illustration on the next page shows an example of how MP3 files are recorded on a CD-R or CD-RW, how they are played back, and how they are searched on this unit.



### Notes:

- The unit can read a CD-ROM containing MP3 files. However, if non-MP3 files are recorded together with MP3 files, this unit will take a longer time to scan the disc. It may also cause the unit to malfunction.
- The unit cannot read or play an MP3 file without the extension code—mp3.
- The unit is not compatible with Playlist\*\*.

\*\* A playlist is a simple text file, used on a PC, which enables users to make their own playback order without physically rearranging the files.

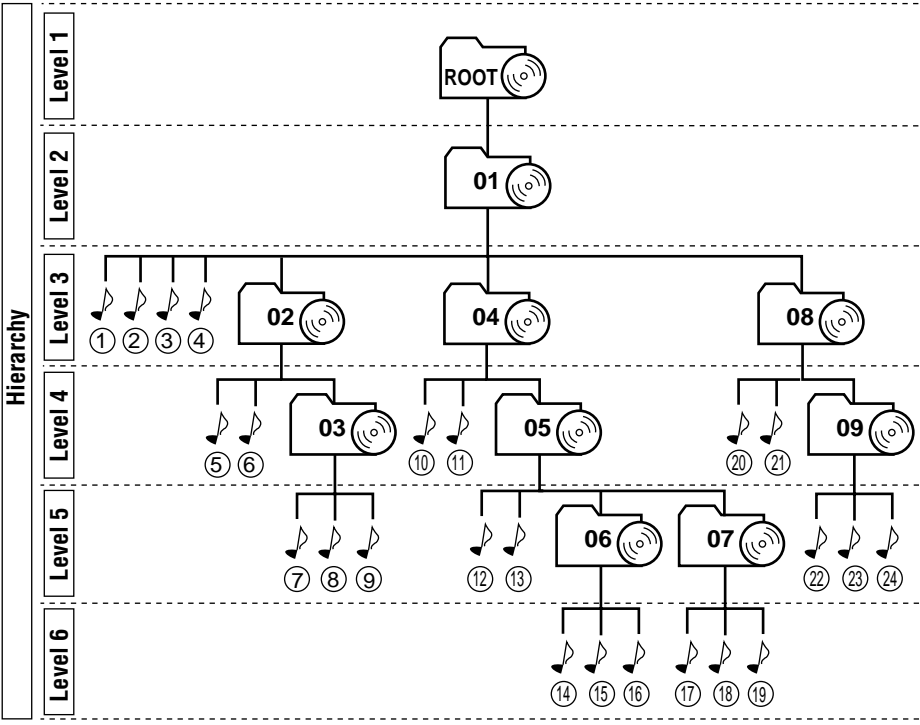
## MP3 directory/file configuration



	: Root
	: Directories
	: MP3 files

**Note:**

There is no limit to the number of hierarchy levels (nested directories). However, up to 8 hierarchy levels is recommended for stable operations.

## MP3 playback/search order (page 17)

- The numbers in circles below the MP3 files (  ) indicate the playback order and search order of the MP3 files. Normally this unit plays back MP3 files in the recorded order.
- The numbers inside the directories indicate the playback order and search order of the directories on an MP3 disc. Normally this unit plays back MP3 files in the directories in the recorded order.

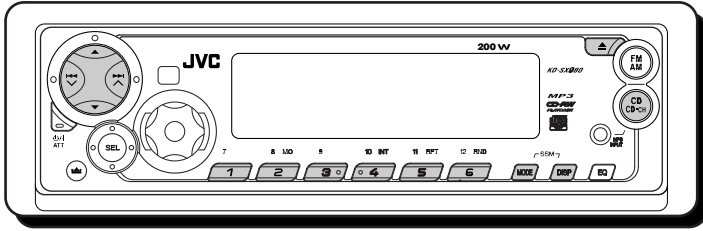

Refer also to “CD OPERATIONS” on pages 11 to 13.

The display changes to show the following:

## Playing an MP3 disc

### 1 Open the control panel.

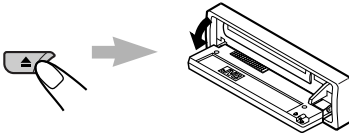

### 2 Insert an MP3 disc into the loading slot.

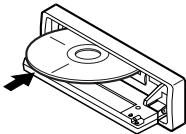

The unit draws the disc. Playback starts automatically from the first file of the first directory once disc check is completed.

### 3 Close the panel by hand.

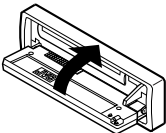

CD-in indicator lights up

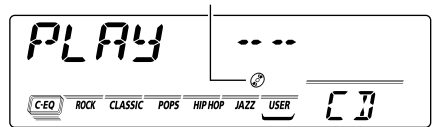

Ex.: When the disc contains 19 directories and 38 MP3 files.

#### Notes:

- All the files on the disc will be played repeatedly until you stop playback—All File Repeat Play.
- MP3 discs require a longer readout time. (It differs due to the complexity of the directory/file configuration.)
- If you change the source or turn the power off, MP3 playback stops (without ejecting the disc). Next time you select disc play as the source or turn the power on, MP3 playback starts from where playback has been stopped previously.



## To change the display information



While playing back an MP3 file, you can change the file information shown on the display. Each time you press DISP (display), the display changes to show the following:

- When “TAG DISP” is set to “TAG ON” (initial setting: see page 27)

Album name/performer (directory name\*)

Track title (file name\*)

Elapsed playing time (with track No.)

\* If an MP3 file does not have ID3 tags, directory name and file name appear.

- When “TAG DISP” is set to “TAG OFF”

Directory name

File name

Elapsed playing time  
(with track No.)

### Note:

The display shows up to 8 characters at one time and scrolls if there are more than 8 characters. See also “To select the scroll mode – SCROLL” on page 26.

## To stop play and eject the disc



Press .

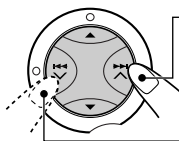

CD play stops, the control panel opens, then the CD automatically ejects from the loading slot. If you change the source, the CD play also stops (without ejecting the disc this time).

## Locating a file or particular portion on an MP3 disc

### To fast-forward or reverse the file



Press and hold   while playing an MP3 disc, to fast-forward the file.



Press and hold   while playing an MP3 disc, to reverse the file.

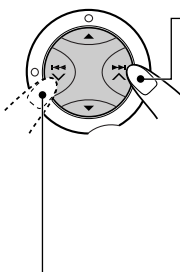

### Note:

During this operation, you can only hear intermittent sounds. (The elapsed playing time also changes intermittently on the display.)

### To skip to the next or previous files



Press   briefly while playing, to skip ahead to the beginning of the next file. Each time you press the button consecutively, the beginning of the next file is located and played back. (See “MP3 playback/search order” on page 15.)

Press   briefly, while playing, to skip back to the beginning of the current file. Each time you press the button consecutively, the beginning of the previous files is located and played back. (See “MP3 playback/search order” on page 15.)

## To go to a particular directory directly

### IMPORTANT:

To directly select the directories using the number button(s), it is required that directories are assigned 2 digit numbers at the beginning of their directory names. (This can only be done during the recording of CD-Rs or CD-RWs.)

Ex.: If directory name is "01 ABC"

- press 1 to go to Directory 01 ABC.
- If directory name is "1 ABC," pressing 1 does not work.

If directory name is "12 ABC"

- press and hold 6 (12) to go to Directory 12 ABC.

Press the number button corresponding to the directory number to start playing the first file in the selected directory.

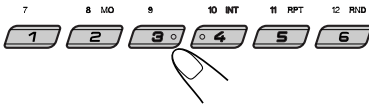

- To select a directory number from 01 – 06: Press 1 (7) – 6 (12) briefly.
- To select a directory number from 07 – 12: Press and hold 1 (7) – 6 (12) for more than 1 second.

### Notes:

- If "MP3" flashes on the display after you have selected a directory, it means that the directory does not contain any MP3 files.
- You cannot directly select a directory with a number greater than 12.

To select a particular file in a directory, press ►►| ▲ or |◀◀ ▼ after selecting the directory.

## To skip to the next directory

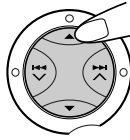

Press ▲ (up) briefly while playing an MP3 disc. Each time you press the button consecutively, the next directory is located (and the first file in the directory starts playing, if recorded).

Ex.1: While playing an MP3 file in Directory 01 (see the illustration on page 15)

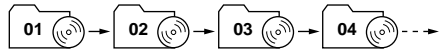

Ex.2: While playing an MP3 file in Directory 04 (see the illustration on page 15)

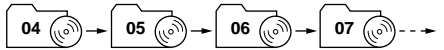

### Note:

If the directory does not contain any MP3 files, it is skipped.

## To skip to the previous directory

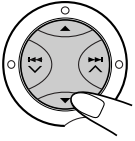

Press ▼ (down) briefly while playing an MP3 disc. Each time you press the button consecutively, the previous directory is located (and the first file in the directory starts playing, if recorded).

Ex.1: While playing an MP3 file in Directory 03 (see the illustration on page 15)

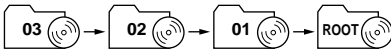

Ex.2: While playing an MP3 file in Directory 05 (see the illustration on page 15)

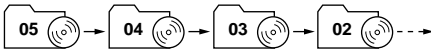

• If you reach the root, playback will not begin.

**Note:**

If the directory does not contain any MP3 files, it is skipped.

## Selecting MP3 playback modes

### To play back files at random (Random Play)

You can play back all files on the MP3 disc at random.



1 Press MODE to enter the functions mode while playing an MP3 disc. "MODE" flashes on the lower part of the display, and the number buttons work as different function buttons.

2 Press RND (random), while "MODE" flashes on the display, so that "RND1" or "RND2" appears on the display. Each time you press RND (random), the random play mode changes as follows:



Mode	RND Indicator	Plays at random
RND1	Lights	All files of the current directory.
RND2	Flashes	All files on the disc.



RND indicator

Ex.: When "RND1" is selected.

### To play back files repeatedly (Repeat Play)

You can play back the current file or all the files in the current directory repeatedly.



- 1 Press MODE to enter the functions mode while playing an MP3 disc. "MODE" flashes on the lower part of the display, and the number buttons work as different function buttons.



- 2 Press RPT (repeat) while "MODE" flashes on the display, so that "RPT1" or "RPT2" appears on the display. Each time you press RPT (repeat), the repeat play mode changes as follows:



Mode	RPT Indicator	Plays repeatedly
RPT1	Lights	The current file (or specified file).
RPT2	Flashes	All files of the current directory (or specified directory).

Track number of the currently playing track



RPT indicator

Ex.: When "RPT1" is selected.

### To play back only intros (Intro scan)

You can play back the first 15 seconds of each file sequentially.



- 1 Press MODE to enter the functions mode while playing an MP3 disc. "MODE" flashes on the lower part of the display, and the number buttons work as different function buttons.



- 2 Press INT (intro scan) while "MODE" flashes on the display, so that "INT1" or "INT2" appears on the display. Each time you press INT (intro), the intro scan play mode changes as follows:



Mode	Indicator	Plays the beginnings (15 seconds)
INT1	The FILE indicator flashes.	Of all files on the disc.
INT2	The DIRECTORY indicator flashes.	Of the first file of all directories.

Track number of the currently playing track

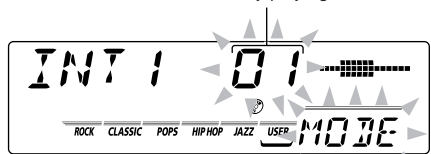

Ex.: When "INT1" is selected.



## Adjusting the sound

You can adjust the sound characteristics to your preference.

### 1 Select the item you want to adjust.



Each time you press the button, the adjustable items change as follows:

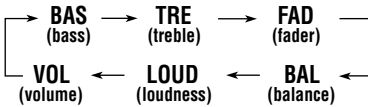

### 2 Adjust the level.

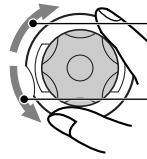

Equalization pattern changes as you adjust the bass or treble.

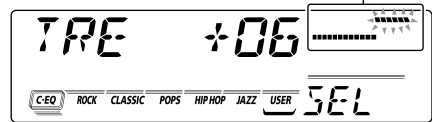

Ex.: When you adjust "TRE"

**Note:**

Normally the control dial works for volume adjustment. So you do not have to select "VOL" to adjust the volume level.

Indication	To do:	Range
BAS	Adjust the bass.	-06 (min.)   +06 (max.)
TRE	Adjust the treble.	-06 (min.)   +06 (max.)
FAD*	Adjust the front and rear speaker balance.	R06 (Rear only)   F06 (Front only)
BAL	Adjust the left and right speaker balance.	L06 (Left only)   R06 (Right only)
LOUD	Boost low and high frequencies to produce a well-balanced sound at low volume level.	LOUD ON   LOUD OFF
VOL	Adjust the volume.	00 (min.)   50 (max.)

\* If you are using a two-speaker system, set the fader level to "00."



## Selecting preset sound modes (C-EQ: custom equalizer)

You can select a preset sound mode (C-EQ: Custom Equalizer) suitable to the music genre.

### 1 Press EQ.



The last selected sound mode is recalled and applied to the current sound.

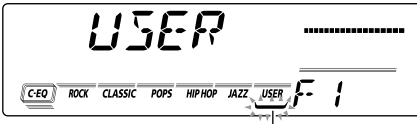

Sound mode indicator flashes

Ex.: If you have selected "USER" previously

### 2 Select the sound mode you want.



Each time you press the button, the sound modes change as follows:

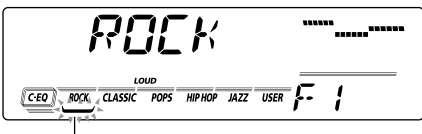

Sound mode indicator flashes.

Ex.: When you have selected "ROCK"

Indication	For:	Preset values		
		BAS	TRE	LOUD
USER	(Flat sound)	00	00	OFF
ROCK	Rock or disco music	+03	+01	ON
CLASSIC	Classical music	+01	-02	OFF
POPS	Light music	+04	+01	OFF
HIP HOP	Funk or Rap music	+02	00	ON
JAZZ	Jazz music	+02	+03	OFF

#### Note:

You can adjust each sound mode to your preference, and store it in memory.

If you want to adjust and store your original sound mode, see "Storing your own sound adjustments" on page 23.

## To store a sound mode separately for each playback source (C-EQ Link)

You can select a sound mode and store it in memory. It will be recalled every time you select the same source and will be shown on the display. A sound mode can be stored for each of the following sources — FM1, FM2, FM3, AM, CD and external components.

- 1 Press and hold SEL (select) for more than 2 seconds so that one of the PSM items appears on the display.
- 2 Press ►►|▲ or |◄◄▼ to select "CEQ LINK (custom equalizer link)."
- 3 Turn the control dial clockwise to select "LINK ON."
- 4 Press SEL (select) to finish the setting.

**To cancel C-EQ Link**, repeat the same procedure and select "LINK OFF" in step 3.

#### Note:

When you change the "CEQ LINK" setting, sound mode (C-EQ) is automatically reset to USER.

- When “CEQ LINK” is set to “LINK ON,”  
The selected sound mode can be stored in memory for the current source.  
Each time you change to the same source, the same sound mode is also recalled and shown on the display. The C-EQ indicator also flashes.
- When “CEQ LINK” is set to “LINK OFF”  
The selected sound mode effect applies to any source.

## Storing your own sound adjustments

You can adjust the sound modes to your preference and store your own adjustments in memory.

- There is a time limit in doing the following procedure. If the setting is canceled before you finish, start from step 1 again.

### 1 Call up the sound mode you want to adjust.



The last selected sound mode is recalled and applied to the current sound.



Sound mode indicator flashes

Ex.: If you have selected “ROCK” previously

### 2 Select the item you want to adjust.

- See page 21 for details.



### 3 Adjust the level.

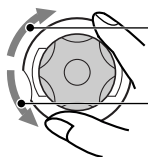

To increase the level.

To decrease the level.

Equalization pattern changes as you adjust the bass or treble.

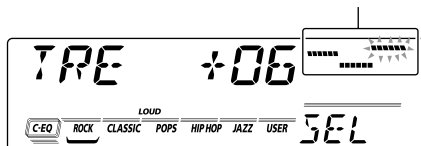

Ex.: When you adjust “TRE”

### 4 Repeat steps 2 and 3 to adjust the other items.

### 5 Repeat the same procedure to store other sound modes.

To reset to the factory settings, repeat the same procedure and reassign the preset values listed in the table on page 22.

## Setting the clock

- 1** Press and hold SEL (select) for more than 2 seconds so that one of the PSM items appears on the display. (See page 25.)



### 2 Set the hour.

- 1** Select "CLOCK H (hour)" if not shown on the display.
- 2** Adjust the hour.

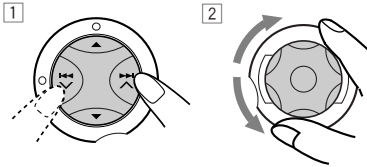

### 3 Set the minute.

- 1** Select "CLOCK M (minute)."
- 2** Adjust the minute.

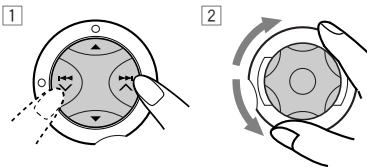

### 4 Finish the setting.



To check the current clock time while the unit is turned off, press DISP (display). The power turns on, the clock time is shown for 5 seconds, then the power turns off.

To check other information during play, press DISP (display). Each time you press the button, the other information (either the clock or the source name) will be shown on the lower part of the display for a while.

## Changing the general settings (PSM)

You can change the items listed on the next page by using the PSM (Preferred Setting Mode) control.

### Basic Procedure

- 1** Press and hold SEL (select) for more than 2 seconds so that one of the PSM items appears on the display. (See page 25.)



- 2** Select the PSM item you want to adjust. (See page 25.)

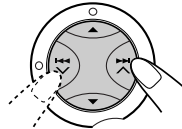

- 3** Adjust the PSM item selected.

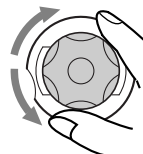



**4** Repeat steps 2 and 3 to adjust the other PSM items if necessary.

**5** Finish the setting.



**Preferred Setting Mode (PSM) items**

						Factory-preset settings	See page
Hold.	Select.	Set. Counter-clockwise	Clockwise				
<b>CLOCK H</b>	Hour adjustment	Back	Advance	1:00	24		
<b>CLOCK M</b>	Minute adjustment	Back	Advance				
<b>CEQ LINK</b>	Custom equalizer memory linkage	LINK OFF	LINK ON	LINK OFF	22, 26		
<b>CLOCK</b>	Clock display	OFF	ON	ON	26		
<b>LEVEL</b>	Level display	AUDIO 1 ↔ AUDIO 2 ↙ OFF ↘		AUDIO 2	26		
<b>DIMMER</b>	Dimmer mode	AUTO ↔ OFF ↙ ON ↘		AUTO	26		
<b>BEEP</b>	Key-touch tone	OFF	ON	ON	26		
<b>SCROLL</b>	Scroll mode	ONCE ↔ AUTO ↙ OFF ↘		ONCE	26		
<b>EXT IN*</b>	External component	CHANGER	LINE IN	CHANGER	26		
<b>AUX ADJ</b>	Auxiliary input level	A.ADJ 00 – A.ADJ 05		A.ADJ 00	27		
<b>TAG DISP</b>	Tag display	TAG OFF	TAG ON	TAG ON	27		

- Press SEL (select) to finish the setting.

\* Displayed only when one of the following sources is selected – FM, AM and CD.

## To set Custom Equalizer Link – CEQ LINK

A different sound mode (C-EQ) can be stored in memory for each source so that you can change the sound modes simply by changing the sources. When shipped from the factory, this mode is deactivated.

- LINK ON: Different sound modes for different sources.
- LINK OFF: One sound mode for all sources.

## To set the clock display – CLOCK

You can set the clock to be shown on the display when the unit is turned on.

When shipped from the factory, the clock is set to be shown on the display.

- ON: Clock display is turned on.
- OFF: Clock display is turned off. When "OFF" is selected, the current source name or station band appears instead of the clock display (except when "LINE IN" is selected as the source).

## To select the level meter – LEVEL

You can select the level display according to your preference.

When shipped from the factory, "AUDIO 2" is selected.

- AUDIO 1: Level meter illuminates from bottom to top.
- AUDIO 2: Alternates level meter (moves from bottom to top) and illumination display.
- OFF: Erases the audio level indicator.

## To select the dimmer mode – DIMMER

When you turn on the car head lights, the display automatically dims (Auto Dimmer).

When shipped from the factory, Auto Dimmer mode is activated.

- AUTO: Activates Auto Dimmer.
- OFF: Cancels Auto Dimmer.
- ON: Always dims the display.

### Note:

*Auto Dimmer equipped with this unit may not work correctly on some vehicles, particularly on those having a control dial for dimming.*

*In this case, set the dimmer mode to "ON" or "OFF."*

## To turn on/off the key-touch tone – BEEP

You can deactivate the key-touch tone if you do not want it to beep each time you press a button. When shipped from the factory, the key-touch tone is activated.

- ON: Activates the key-touch tone.
- OFF: Deactivates the key-touch tone.

## To select the scroll mode – SCROLL

You can select the scroll mode for the disc information (when the entire text cannot be shown all at once).

When shipped from the factory, Auto Scroll mode is set to "ONCE."

- ONCE: Scrolls only once.
- AUTO: Repeats the scroll (5-second intervals in between).
- OFF: Cancels Auto Scroll.

### Note:

*Even if the scroll mode is set to "OFF," you can scroll the display by pressing DISP (display) for more than 1 second.*

## To select the external component to use – EXT IN

You can connect the external component to the CD changer jack on the rear using the Line Input Adaptor KS-U57 (not supplied).

To use the external component as the playback source through this unit, you need to select which component – CD changer or external component – to use.

When shipped from the factory, CD changer is selected as the external component.

- LINE IN: To use the external component other than CD changer.
- CHANGER: To use the CD changer.

**Note:**

For connecting the Line Input Adaptor KS-U57 and the external component, refer to the Installation/Connection Manual (separate volume).

**To adjust the auxiliary input level – AUX ADJ**

Adjust the auxiliary input level properly when an external component is connected to the MP3 INPUT jack.

When shipped from the factory, the auxiliary input level is set at level "00."

If the input level of the connected component is not high enough, increase the input level properly. Without adjusting the line input level, you may be surprised at a loud sound when you change the source from the external component to another source.

**To turn the tag display on or off – TAG DISP**

An MP3 file can contain file information called "ID3 Tag" where its album name, performer, track title, etc. are recorded.

There are two versions—ID3v1 (ID3 Tag version 1) and ID3v2 (ID3 Tag version 2). This unit is compatible only with ID3v1.

When shipped from the factory, "TAG ON" is selected.

- TAG ON: Turns on the ID3 tag display while playing MP3 files.
  - If an MP3 file does not have ID3 tags, directory name and file name appear.

**Note:**

If you change the setting from "TAG OFF" to "TAG ON" while playing an MP3 file, the tag display will be activated when the next file starts playing.

- TAG OFF: Turns off the ID3 tag display while playing MP3 files. (Only the directory name and file name can be shown.)

**Assigning names to the sources**

You can assign names to station frequencies and discs (both in this unit and in the CD changer). After assigning a name, it will appear on the display when you select the source.

Sources	Maximum number of characters
Station frequencies	up to 8 characters (up to 30 station frequencies including both FM and AM)
CDs*	up to 32 characters (up to 40 discs)

\* You cannot assign a name to a CD Text or an MP3 disc.

**1 Select a source you want to assign a name to.**



When you select a source, the power automatically comes on.

**2 Press and hold SEL (select) for more than 2 seconds while pressing DISP (display).**

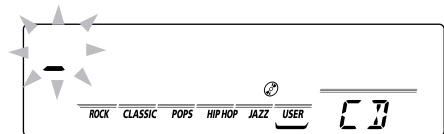

Ex.: When you select CD as the source

CONTINUED ON THE NEXT PAGE

**3 Select a character.**

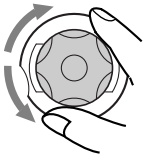

- See next column for available characters.

**4 Move the cursor to the next (or previous) character position.**

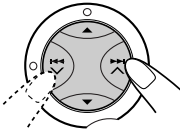

**5 Repeat steps 3 and 4 until you finish inputting the name.**

**6 Finish the procedure while the last selected character is flashing.**



**Available characters**

A	B	C	D	E	F	G	H	I	J
K	L	M	N	O	P	Q	R	S	T
U	V	W	X	Y	Z	0	1	2	3
4	5	6	7	8	9	-	/	<	>
space									

**Notes:**

- When you try to assign a name to the 41st disc, "NAME FULL" appears on the display. (In this case, delete unwanted names before assignment.)
- When the CD changer is connected, you can assign names to CDs in the CD changer. These names can also be shown on the display if you insert the CDs in this unit.

**To erase the input characters**

Insert spaces using the same procedure described above.

## Detaching the control panel

You can detach the control panel when leaving the car.

When detaching or attaching the control panel, be careful not to damage the connectors on the back of the control panel and on the panel holder.

### Detaching the control panel

Before detaching the control panel, be sure to turn off the power.

#### 1 Unlock the control panel.

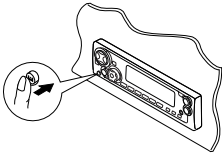

#### 2 Pull the control panel out of the unit.

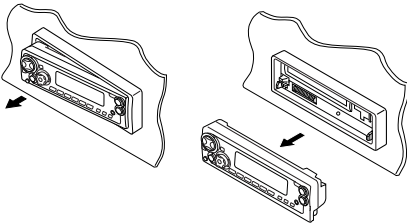

#### 3 Put the detached control panel into the provided case.

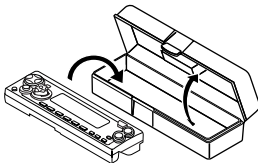

## Attaching the control panel

#### 1 Insert the right side of the control panel into the groove on the panel holder.

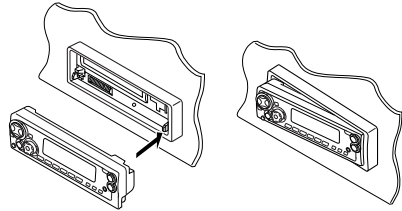

#### 2 Press the left side of the control panel to fix it to the panel holder.

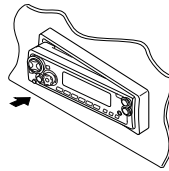

#### Note on cleaning the connectors:

If you frequently detach the control panel, the connectors will deteriorate.

To minimize this possibility, periodically wipe the connectors with a cotton swab or cloth moistened with alcohol, being careful not to damage the connectors.

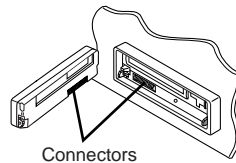



# CD CHANGER OPERATIONS

ENGLISH

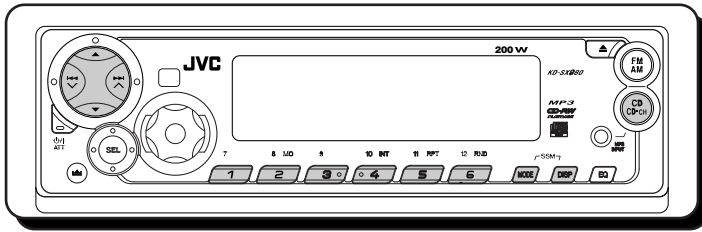

We recommend that you use one of the CH-X series with your unit.

If you have another CD automatic changer, consult your JVC car audio dealer for connections.

- For example, if your CD automatic changer is one of the KD-MK series, you need a cord (KS-U15K) for connecting it to this unit.

Before operating your CD automatic changer:

- Refer also to the Instructions supplied with your CD changer.
- If no discs are in the magazine of the CD changer or the discs are inserted upside down, "NO DISC" will appear on the display. If this happens, remove the magazine and set the discs correctly.
- If "RESET 1" – "RESET 8" appears on the display, something is wrong with the connection between this unit and the CD changer. If this happens, check the connection and make sure the cords are connected firmly. Then, press the reset button of the CD changer.

## Playing CDs

### Select the CD automatic changer (CD-CH).



- \* If you have changed "EXT IN" setting to "LINE IN" (see page 26), you cannot select the CD changer.

Playback starts from the first track of the first disc.

All tracks of all discs are played back.

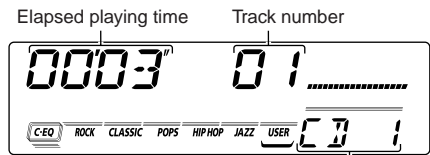

Disc number\*

- \* When "CLOCK" is set to "ON" (see page 26), disc number will soon change to clock time.

### Note on One-Touch Operation:

When you press CD CD-CH, the power automatically turns on. You do not have to press /ATT to turn on the power.

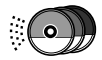

### To fast-forward or reverse the track

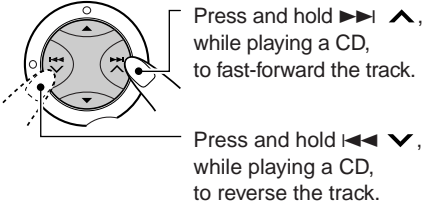

### To go to the next track or the previous tracks

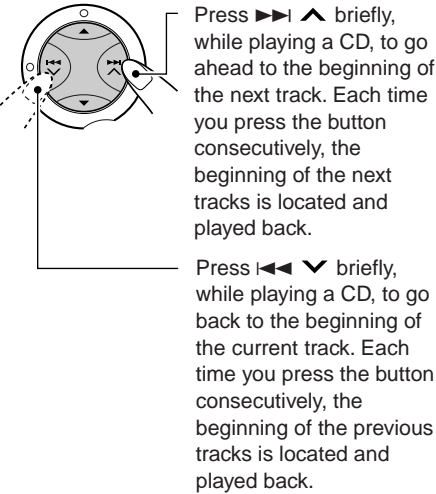

### To go to the next discs or the previous discs

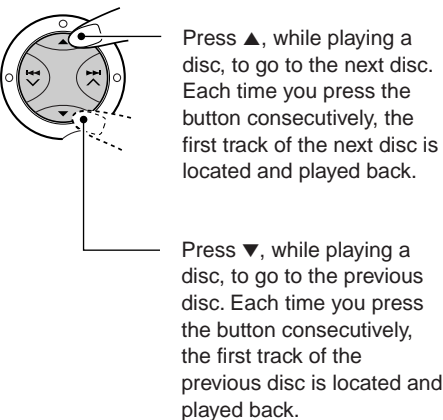

### To go to a particular disc directly

Press the number button corresponding to the disc number to start its playback (while the CD changer is playing).

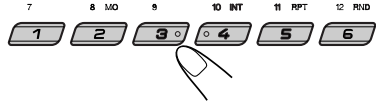

- To select a disc number from 1 – 6:  
Press 1 (7) – 6 (12) briefly.
- To select a disc number from 7 – 12:  
Press and hold 1 (7) – 6 (12) for more than 1 second.

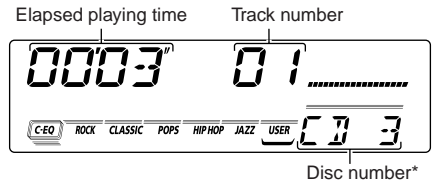

\* When "CLOCK" is set to "ON" (see page 26), disc number will soon change to clock time.

### To show the CD Text information

This is possible only when connecting a JVC CD automatic changer equipped with CD Text reading capability.

### Select text display mode while playing a CD Text.



Each time you press the button, the display changes as follows:



#### Notes:

- The display shows up to 8 characters at one time and scrolls if there are more than 8 characters.
- If a CD Text includes too much text information, some may not appear on the display.
- When you press DISP (display) while playing a conventional CD, "NO NAME" appears for the disc title/performer and the track title.



# Selecting CD playback modes

## To play back tracks at random (Random Play)



1 Press MODE to enter the functions mode while playing a disc. "MODE" appears on the lower part of the display, and the number buttons work as different function buttons.



2 Press RND (random), while "MODE" is still on the display, so that the RND indicator lights up on the display. Then, each time you press RND (random), the random play mode changes as follows:



Mode	RND Indicator	Plays at random
RND1	Lights	All tracks of the current disc, then the tracks of the next disc and so on.
RND2	Flashes	All tracks of all discs inserted in the magazine.

## To play back only intros (Intro Scan)

You can play back the first 15 seconds of each track sequentially.



1 Press MODE to enter the functions mode while playing a disc. "MODE" appears on the lower part of the display, and the number buttons work as different function buttons.



2 Press INT (intro), while "MODE" is still on the display. Then, each time you press INT (intro) while playing a disc, the intro scan mode changes as follows:



Mode	Indication	Plays the first 15 seconds
INT1	Track number flashes	Of all tracks on all inserted discs.
INT2	Disc number flashes	Of the first track on each inserted disc.

## To play back tracks repeatedly (Repeat Play)



1 Press MODE to enter the functions mode while playing a disc. "MODE" appears on the lower part of the display, and the number buttons work as different function buttons.



2 Press RPT (repeat), while "MODE" is still on the display, so that the RPT indicator lights up on the display. Then, each time you press RPT (repeat), the repeat play mode changes as follows:



Mode	RPT Indicator	Plays repeatedly
RPT1	Lights	The current track (or specified track).
RPT2	Flashes	All tracks of the current disc (or specified disc).



# EXTERNAL COMPONENT OPERATIONS

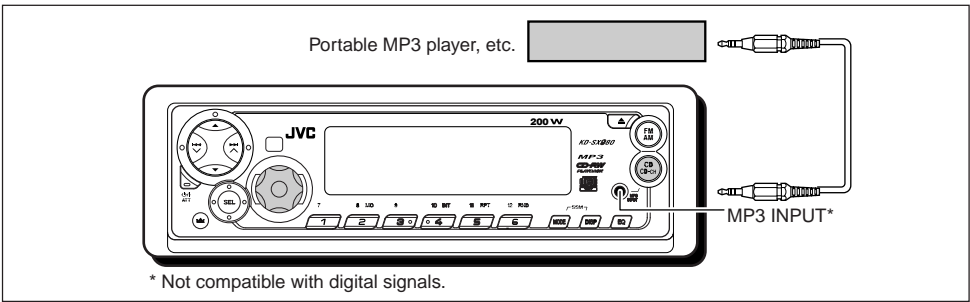

## Playing an external component

You can connect two external components to this unit.

Connect one to the CD changer jack on the rear using the Line Input Adaptor KS-U57 (not supplied), and the other to the MP3 INPUT jack on the control panel.

### Preparations:

- For connecting the Line Input Adaptor KS-U57 and the external component, refer to the Installation/Connection Manual (separate volume).
- Before operating the external component using the following procedure, select the external input correctly. (See "To select the external component to use – EXT IN" on page 26.)

### 1 Select the external component (LINE IN or AUX IN).

To select "LINE IN" (component connected to the CD changer jack on the rear), press CD CD-CH repeatedly.

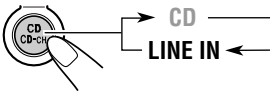

- If "LINE IN" does not appear on the display, see page 26 and select the external input ("LINE IN").
- Displayed only when one of the following sources is selected – FM, AM and CD.

To select "AUX IN" (component connected to the MP3 INPUT jack on the control panel), press and hold CD CD-CH.



### 2 Turn on the connected component and start playing the source.

### 3 Adjust the volume.

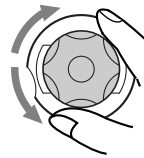

### 4 Adjust the sound characteristics you want. (See pages 21 – 23.)

#### Note on One-Touch Operation:

When you press CD CD-CH, the power automatically comes on. You do not have to press /ATT to turn on the power.



# TROUBLESHOOTING

What appears to be trouble is not always serious. Check the following points before calling a service center.

ENGLISH

	Symptoms	Causes	Remedies
General Playback	• CD cannot be played back.	Disc is inserted upside down.	Insert the disc correctly.
	• Sound is sometimes interrupted.	You are driving on rough roads.	Stop playback while driving on rough roads.
		Disc is scratched.	Change the disc.
		Connections are incorrect.	Check the cords and connections.
	• CD-R/CD-RW cannot be played back. • Tracks on the CD-R/CD-RW cannot be skipped.	CD-R/CD-RW is not finalized.	<ul style="list-style-type: none"> <li>• Insert a finalized CD-R/CD-RW.</li> <li>• Finalize the CD-R/CD-RW with the component which you used for recording.</li> </ul>
	• Sound cannot be heard from the speakers.	The volume level is set to the minimum level.	Adjust it to the optimum level.
		Connections are incorrect.	Check the cords and connections.
	• "NO DISC" appears on the display .	No disc in the loading slot.	Insert a disc into the loading slot.
		Disc is inserted incorrectly.	Insert the disc correctly.
	• Disc cannot be ejected.	Disc is locked.	Unlock the disc (See page 13.)
• This unit does not work at all.	The built-in microcomputer may function incorrectly due to noise, etc.	Press the reset button on the panel holder using a ball-point pen after detaching the control panel. (The clock setting and preset stations stored in memory are erased.) (See page 2.)	
FM/AM	• SSM (Strong-station Sequential Memory) automatic preset does not work.	Signals are too weak.	Store stations manually.
	• Static noise while listening to the radio.	The antenna is not connected firmly.	Connect the antenna firmly.



Symptoms	Causes	Remedies	
<ul style="list-style-type: none"> <li>• “NO DISC” appears on the display .</li> </ul>	No disc in the magazine.	Insert a disc.	CD Changer
<ul style="list-style-type: none"> <li>• “RESET 8” appears on the display .</li> </ul>	This unit is not connected to a CD changer correctly.	Connect this unit and the CD changer correctly and press the reset button of the CD changer.	
<ul style="list-style-type: none"> <li>• “RESET 1” – “RESET 7” appears on the display.</li> </ul>	_____	Press the reset button of the CD changer.	
<ul style="list-style-type: none"> <li>• Disc cannot be played back.</li> </ul>	No MP3 files are recorded on the disc.	Change the disc.	MP3 Playback
	MP3 files do not have the extension code—mp3 in their file names.	Add the extension code—mp3 to their file names.	
	MP3 files are not recorded in the format compliant with ISO 9660 Level 1 or 2.	Change the disc. (Record MP3 files using a compliant application.)	
<ul style="list-style-type: none"> <li>• Noise is generated.</li> </ul>	The file played back is not an MP3 file (although it has the extension code—mp3).	Skip to another file or change the disc. (Do not add the extension code—mp3 to non-MP3 files.)	
<ul style="list-style-type: none"> <li>• A longer readout time is required (“MP3 SCAN” keeps flashing on the display).</li> </ul>	Readout time varies due to the complexity of the directory/file configuration.	Do not use too many hierarchies and directories. Also, do not record any other types of audio tracks together with MP3 files.	
<ul style="list-style-type: none"> <li>• Files cannot be played back as you have intended them to play.</li> </ul>	Playback order is determined when the files are recorded.	_____	
<ul style="list-style-type: none"> <li>• Elapsed playing time is not correct.</li> </ul>	This sometimes occurs during play. This is caused by how the files are recorded on the disc.	_____	
<ul style="list-style-type: none"> <li>• “MP3” flashes on the display.</li> </ul>	There are no MP3 files in the current directory.	Select another directory.	
<ul style="list-style-type: none"> <li>• “NO FILES” appears on the display for a while, then “PLEASE” and “EJECT” appear alternately.</li> </ul>	There are no MP3 files in this disc.	Insert a disc that contains MP3 files.	
<ul style="list-style-type: none"> <li>• Correct characters are not displayed. (e.g. album name)</li> </ul>	This unit can only display alphabets (capital: A–Z, small: a–z), numbers, and a limited number of symbols.	_____	



## Handling discs

This unit has been designed to reproduce CDs and CD-Rs.

- You can also play back CD Text.
- You can also play back your original CD-Rs (Recordable) and CD-RWs (Rewritable) either in audio CD format or in MP3 format.

### How to handle discs

#### When removing a disc from its case, press

down the center holder of the case and lift the disc out, holding it by the edges.

- Always hold the disc by the edges. Do not touch its recording surface.



**When storing a disc into its case,** gently insert the disc around the center holder (with the printed surface facing up).

- Make sure to store discs into the cases after use.

### To keep discs clean

A dirty disc may not play correctly. If a disc does become dirty, wipe it with a soft cloth in a straight line from center to edge.



### To play new discs

New discs may have some rough spots around the inner and outer edges. If such a disc is used, this unit may reject the disc.

To remove these rough spots, rub the edges with a pencil or ball-point pen, etc.

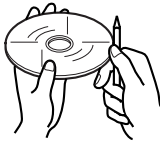

#### About mistracking:

Mistracking may result from driving on extremely rough roads. This does not damage the unit and the disc, but will be annoying. We recommend that you stop disc playback while driving on such rough roads.

## Moisture condensation

Moisture may condense on the lens inside the unit in the following cases:

- After starting the heater in the car.
- If it becomes very humid inside the car. Should this occur, the unit may malfunction. In this case, eject the disc and leave the unit turned on for a few hours until the moisture evaporates.

### When playing a CD-R or CD-RW

You can play back your original CD-Rs or CD-RWs recorded in audio CD format or in MP3 format. (However, they may not be played back depending on their characteristics or recording conditions.)

- User-edited CD-Rs (Recordable) and CD-RWs (Rewritable), where audio CD tracks are recorded, can be played back only if they are already "finalized."
- Before playing back CD-Rs or CD-RWs, read their instructions or cautions carefully.
- Some CD-Rs or CD-RWs may not be played back on this unit because of their disc characteristics, damage or stain on them, or if the player's lens is dirty.
- CD-Rs or CD-RWs are susceptible to high temperatures or high humidity; so do not leave them inside your car.
- CD-RWs may require a longer readout time. (This is caused by the fact that the reflectance of CD-RWs is lower than for regular CDs.)

#### CAUTIONS:

- Do not insert 8 cm (3 3/16") discs (single CDs) into the loading slot. (Such discs cannot be ejected.)
- Do not insert any disc of unusual shape — like a heart or flower; otherwise, it will cause a malfunction.
- Do not expose discs to direct sunlight or any heat source or place them in a place subject to high temperature and humidity. Do not leave them in a car.
- Do not use any solvent (for example, conventional record cleaner, spray, thinner, benzine, etc.) to clean discs.

## AUDIO AMPLIFIER SECTION

Maximum Power Output:

Front: 50 W per channel

Rear: 50 W per channel

Continuous Power Output (RMS):

Front: 19 W per channel into 4  $\Omega$ , 40 Hz to 20 000 Hz at no more than 0.8 % total harmonic distortion.

Rear: 19 W per channel into 4  $\Omega$ , 40 Hz to 20 000 Hz at no more than 0.8 % total harmonic distortion.

Load Impedance: 4  $\Omega$  (4  $\Omega$  to 8  $\Omega$  allowance)

Tone Control Range:

Bass:  $\pm 10$  dB at 100 Hz

Treble:  $\pm 10$  dB at 10 kHz

Frequency Response: 40 Hz to 20 000 Hz

Signal-to-Noise Ratio: 70 dB

Line-In Level/Impedance:

LINE IN: 1.5 V/20 k $\Omega$  load

MP3 INPUT: 3.5 mm dia. stereo mini jack (analog)

Line-Out Level/Impedance:

2.0 V/20 k $\Omega$  load (full scale)

Output Impedance: 1 k $\Omega$

## TUNER SECTION

Frequency Range:

FM: 87.5 MHz to 107.9 MHz

AM: 530 kHz to 1 710 kHz

### **[FM Tuner]**

Usable Sensitivity: 11.3 dBf (1.0  $\mu$ V/75  $\Omega$ )

50 dB Quieting Sensitivity:

16.3 dBf (1.8  $\mu$ V/75  $\Omega$ )

Alternate Channel Selectivity (400 kHz):

65 dB

Frequency Response: 40 Hz to 15 000 Hz

Stereo Separation: 35 dB

Capture Ratio: 1.5 dB

### **[AM Tuner]**

Sensitivity: 20  $\mu$ V

Selectivity: 35 dB

## CD PLAYER SECTION

Type: Compact disc player

Signal Detection System: Non-contact optical pickup (semiconductor laser)

Number of channels: 2 channels (stereo)

Frequency Response: 5 Hz to 20 000 Hz

Dynamic Range: 96 dB

Signal-to-Noise Ratio: 98 dB

Wow and Flutter: Less than measurable limit

MP3 decoding format: MPEG1/2 Audio Layer 3

Max. Bit Rate: 320 Kbps

## GENERAL

Power Requirement:

Operating Voltage: DC 14.4 V

(11 V to 16 V allowance)

Grounding System: Negative ground

Allowable Operating Temperature:

0°C to +40°C (32°F to 104°F)

Dimensions (W x H x D):

Installation Size:

182 mm x 52 mm x 150 mm

(7-3/16" x 2-1/16" x 5-15/16")

Panel Size:

188 mm x 58 mm x 14 mm

(7-7/16" x 2-5/16" x 5/8")

Mass: 1.4 kg (3.1 lbs) (excluding accessories)

*Design and specifications are subject to change without notice.*

If a kit is necessary for your car, consult your telephone directory for the nearest car audio speciality shop.



**JVC**

**MOBILE**  
ENTERTAINMENT

<http://www.jvcmobile.com>

*Visit us on-line for*

*Technical Support & Customer Satisfaction Survey.*

**US RESIDENTS ONLY**

**Having TROUBLE with operation?**

**Please reset your unit**

Refer to page of How to Reset

**Still having trouble??**

**USA ONLY**

**Call 1-800-252-5722**

<http://www.jvc.com>

**We can help you!**

**JVC**

VICTOR COMPANY OF JAPAN, LIMITED



EN, SP, FR



0102KKSMdTJEIN

Download from [Www.Somanuals.com](http://www.Somanuals.com). All Manuals Search And Download.

## Free Manuals Download Website

<http://myh66.com>

<http://usermanuals.us>

<http://www.somanuals.com>

<http://www.4manuals.cc>

<http://www.manual-lib.com>

<http://www.404manual.com>

<http://www.luxmanual.com>

<http://aubethermostatmanual.com>

Golf course search by state

<http://golfingnear.com>

Email search by domain

<http://emailbydomain.com>

Auto manuals search

<http://auto.somanuals.com>

TV manuals search

<http://tv.somanuals.com>