

# JVC



ENGLISH

РУССКИЙ

## CASSETTE RECEIVER РЕСИВЕР С КАССЕТНЫМ ПРОИГРЫВАТЕЛЕМ

# KS-FX945R

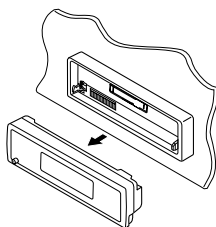
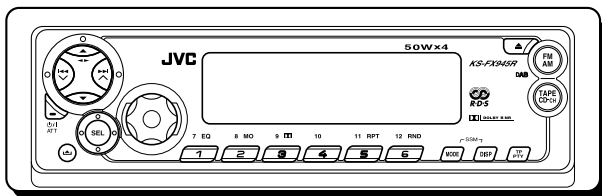

For installation and connections, refer to the separate manual.

Указания по установке и выполнению соединений приводятся в отдельной инструкции.

В соответствии с Законом Российской Федерации "О защите прав потребителей" срок службы (годности) данного товара "по истечении которого он может представлять опасность для жизни, здоровья потребителя, причинять вред его имуществу или окружающей среде" составляет семь (7) лет со дня производства. Этот срок является временем, в течение которого потребитель данного товара может безопасно им пользоваться при условии соблюдения инструкции по эксплуатации данного товара, проводя необходимое обслуживание, включающее замену расходных материалов и/или соответствующее ремонтное обеспечение в специализированном сервисном центре.

Дополнительные косметические материалы к данному товару, поставляемые вместе с ним, могут храниться в течение двух (2) лет со дня его производства.

Срок службы (годности), кроме срока хранения дополнительных косметических материалов, упомянутых в предыдущих двух пунктах, не затрагивает никаких других прав потребителя, в частности, гарантийного свидетельства JVC, которое он может получить в соответствии с законом о правах потребителя или других законов, связанных с ним.

## INSTRUCTIONS ИНСТРУКЦИИ ПО ЭКСПЛУАТАЦИИ



GET0122-001A  
[EE]

## How to reset your unit

After detaching the control panel, press the reset button on the panel holder using a ball-point pen or a similar tool.

This will reset the built-in microcomputer.

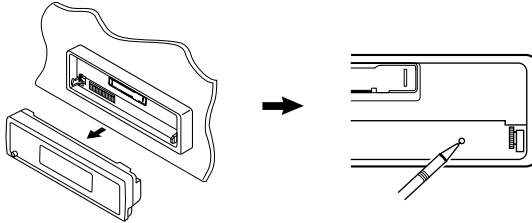

### Note:

*Your preset adjustments—such as preset channels or sound adjustments—will also be erased.*

## How to use the MODE button

If you press MODE, the unit goes into functions mode (“MODE” flashes on the upper part of the display). While in functions mode, the number buttons work as different function buttons.

- When connecting a JVC MP3-compatible CD changer: The ▲/▼ buttons will also work as +10/–10 buttons after pressing MODE.

Ex.: When number button 2 works as MO (monaural) button.

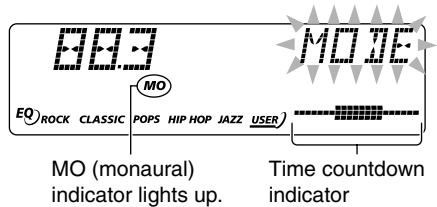
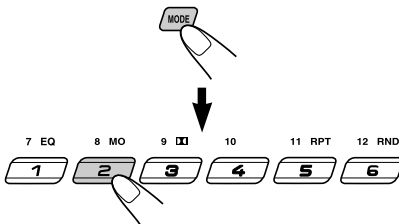

**To use these buttons for original functions again after pressing MODE,** wait for 5 seconds without pressing any of these buttons until the functions mode is cleared (“MODE” disappears from the display).

- Pressing MODE again also clears the functions mode.

Thank you for purchasing a JVC product. Please read all instructions carefully before operation, to ensure your complete understanding and to obtain the best possible performance from the unit.

# CONTENTS

How to reset your unit .....	2	<b>OTHER MAIN FUNCTIONS .....</b>	<b>25</b>
How to use the MODE button .....	2	Changing the general settings (PSM) .....	25
<b>LOCATION OF THE BUTTONS .....</b>	<b>4</b>	Detaching the control panel .....	29
Control panel .....	4	<b>CD CHANGER OPERATIONS .....</b>	<b>30</b>
Remote controller .....	5	About MP3 discs .....	30
Preparing the remote controller .....	6	Playing discs .....	30
<b>BASIC OPERATIONS .....</b>	<b>7</b>	Selecting the playback modes .....	34
Turning on the power .....	7	<b>EXTERNAL COMPONENT OPERATIONS ...</b>	<b>35</b>
Setting the clock .....	8	Playing an external component .....	35
<b>RADIO OPERATIONS .....</b>	<b>9</b>	<b>DAB TUNER OPERATIONS .....</b>	<b>36</b>
Listening to the radio .....	9	Tuning in to an ensemble and one of the	
Storing stations in memory .....	10	services .....	36
Tuning in to a preset station .....	11	Storing DAB services in memory .....	37
<b>RDS OPERATIONS .....</b>	<b>12</b>	Tuning in to a preset DAB service .....	38
What you can do with RDS .....	12	What you can do more with DAB .....	39
Other convenient RDS functions and		<b>TROUBLESHOOTING .....</b>	<b>40</b>
adjustments .....	16	<b>MAINTENANCE .....</b>	<b>42</b>
<b>TAPE OPERATIONS .....</b>	<b>19</b>	<b>SPECIFICATIONS .....</b>	<b>43</b>
Listening to a cassette .....	19		
Finding the beginning of a tune .....	20		
Other convenient tape functions .....	21		
Prohibiting cassette ejection .....	22		
<b>SOUND ADJUSTMENTS .....</b>	<b>23</b>		
Selecting preset sound modes			
(C-EQ: custom equalizer) .....	23		
Adjusting the sound .....	24		

## BEFORE USE

### \*For safety....

- Do not raise the volume level too much, as this will block outside sounds, making driving dangerous.
- Stop the car before performing any complicated operations.

### \*Temperature inside the car....

If you have parked the car for a long time in hot or cold weather, wait until the temperature in the car becomes normal before operating the unit.



# LOCATION OF THE BUTTONS

## Control panel

ENGLISH

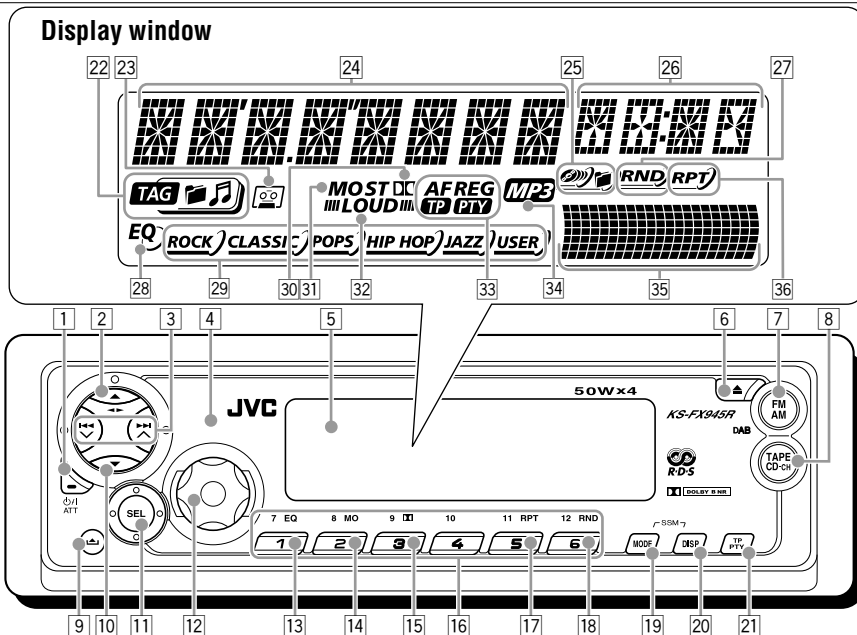

- 1  $\Phi$ /I ATT (standby/on/attenuator) button
- 2  $\blacktriangle$  (up) button
- 3  $\blacktriangleleft$  (tape direction) button
- 4  $\blacktriangleleft$   $\blacktriangleright$   $\blacktriangleright$   $\blacktriangle$  buttons
- 5 Remote sensor
- 6 Display window
- 7  $\blacktriangle$  (eject) button
- 8 FM AM (DAB) button
- 9 TAPE CD-CH (CD changer) button
- 10  $\blacktriangle$  (control panel release) button
- 11  $\blacktriangledown$  (down) button
- 12 SEL (select) button
- 13 Control dial
- 14 EQ (equalizer) button
- 15 MO (monaural) button
- 16  $\square$  (Dolby B) button
- 17 Number buttons
- 18 RPT (repeat) button
- 19 RND (random) button
- 20 MODE button
- 21 Also functions as SSM buttons when pressed together with DISP (display) button.
- 22 DISP (display) button
- 23 Also functions as SSM buttons when pressed together with MODE button.
- 24 TP PTY (traffic programme/programme type) button

## Display window

- 22 Disc information indicators  
TAG (ID3 Tag),  $\square$  (folder),  $\mathbb{M}$  (track/file)  
• Lights up only when playing an MP3 disc or a CD Text on a JVC MP3-compatible CD changer.
- 23 Tape-in indicator
- 24 Main display
- 25 Playback item indicators  
 $\mathbb{M}$  (disc)  
• Lights up only when connecting to a CD changer.  
 $\square$  (folder)  
• Lights up only when playing an MP3 disc on a JVC MP3-compatible CD changer.
- 26 Source/clock display
- 27 RND (random) indicator  
• Lights up only when connecting to a CD changer.
- 28 EQ (equalizer) indicator
- 29 Sound mode (C-EQ: custom equalizer) indicators  
ROCK, CLASSIC, POPS, HIP HOP, JAZZ, USER
- 30  $\square$  (Dolby B) indicator
- 31 Tuner reception indicators  
MO (monaural), ST (stereo)
- 32 LOUD (loudness) indicator
- 33 RDS indicator  
AF, REG, TP, PTY
- 34 MP3 indicator  
• Lights up only when playing an MP3 disc on a JVC MP3-compatible CD changer.
- 35 Volume (or audio) level indicator  
Equalizer pattern indicator
- 36 RPT (repeat) indicator



# Remote controller

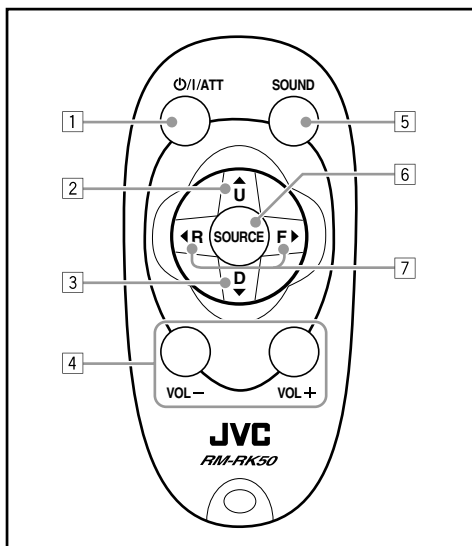

- 1 • Turns on the unit if pressed when the unit is turned off.
  - Turns off the unit if pressed and held until “SEE YOU” appears on the display.
  - Drops the volume level in a moment if pressed briefly.  
Press again to resume the volume.
- 2 • Selects the band while listening to the radio (or the DAB tuner).  
Each time you press the button, the band changes.
  - Changes the tape direction while listening to a cassette.  
Each time you press the button, the tape direction changes alternately.
  - While playing an MP3 disc on an MP3-compatible CD changer;
    - Skips to the next disc if pressed briefly.
    - Skips to the next folder if pressed and held.

**Note:** While playing a CD on a CD changer, this always skips to the next disc.
- 3 • Selects the preset stations while listening to the radio (or the DAB tuner).  
Each time you press the button, the preset station (or service) number increases, and the selected station (or service) is tuned in.
  - While playing an MP3 disc on an MP3-compatible CD changer;
    - Skips to the previous disc if pressed briefly.
    - Skips to the previous folder if pressed and held.

**Note:** While playing a CD on a CD changer, this always skips to the previous disc.
- 4 Functions the same as the control dial on the main unit.

**Note:** These buttons do not function for the preferred setting mode adjustment.
- 5 Selects the sound mode (C-EQ: custom equalizer).  
Each time you press the button, the sound mode (C-EQ) changes.
- 6 Selects the source.  
Each time you press the button, the source changes.
- 7 • Searches for stations while listening to the radio.
  - Selects services while listening to the DAB tuner if pressed briefly.
  - Searches for ensembles while listening to the DAB tuner if pressed for more than one second.
  - Functions as the fast-forward or rewind buttons if pressed and held while listening to a cassette.  
To release this operation, press button 2 to resume playback.
  - Functions as Multi Music Scan buttons if pressed while listening to a cassette.  
To release this operation, press button 2 to resume playback.
  - Fast-forwards or reverses the track/file if pressed and held while listening to the CD changer.
  - Skips to the beginning of the next track/file or goes back to the beginning of the current (or previous) tracks/files if pressed briefly while listening to the CD changer.

# Preparing the remote controller

Before using the remote controller:

- Aim the remote controller directly at the remote sensor on the main unit. Make sure there is no obstacle in between.

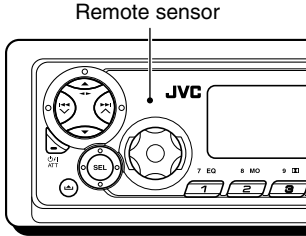

- Do not expose the remote sensor to strong light (direct sunlight or artificial lighting).

## Installing the battery

When the controllable range or effectiveness of the remote controller decreases, replace the battery.

### 1. Remove the battery holder.

- 1) Push out the battery holder in the direction indicated by the arrow using a ball-point pen or a similar tool.
- 2) Remove the battery holder.

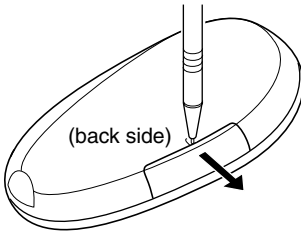

### 2. Place the battery.

Slide the battery into the holder with the + side facing upwards so that the battery is fixed in the holder.

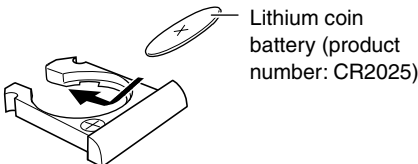

### 3. Return the battery holder.

Insert again the battery holder by pushing it until you hear a clicking sound.

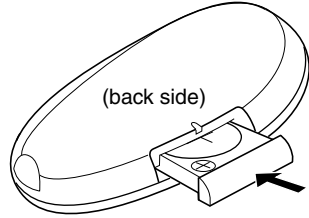

#### WARNING:

- Store the battery in a place where children cannot reach.  
*If a child accidentally swallows the battery, consult a doctor immediately.*
- Do not recharge, short, disassemble, or heat the battery or dispose of it in a fire.  
*Doing any of these things may cause the battery to give off heat, crack, or start a fire.*
- Do not leave the battery with other metallic materials.  
*Doing this may cause the battery to give off heat, crack, or start a fire.*
- When throwing away or saving the battery, wrap it in tape and insulate; otherwise, the battery may start to give off heat, crack, or start a fire.
- Do not poke the battery with tweezers or similar tools.  
*Doing this may cause the battery to give off heat, crack, or start a fire.*

#### CAUTION:

*DO NOT* leave the remote controller in a place (such as dashboards) exposed to direct sunlight for a long time. Otherwise, it may be damaged.

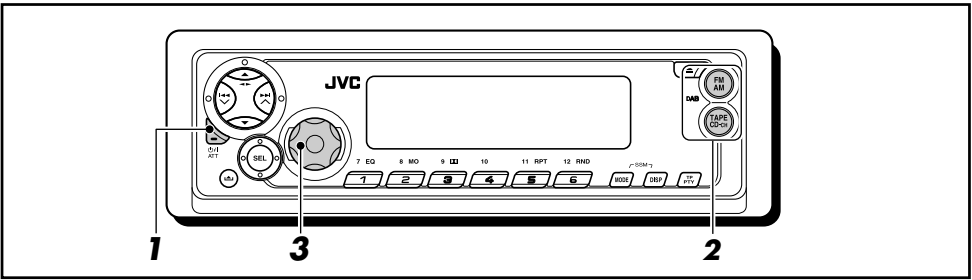

## Turning on the power

### 1 Turn on the power.



#### Note on One-Touch Operation:

When you select a source in step 2 below, the power automatically comes on. You do not have to press this button to turn on the power.

### 2 Select the source.

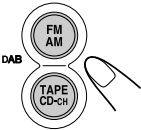

To operate the tuner (FM or AM),  
see pages 9 – 18.

To play a tape,  
see pages 19 – 22.

To operate the CD changer,  
see pages 30 – 34.

To operate the external component  
(LINE IN), see page 35.

To operate the DAB tuner,  
see pages 36 – 39.

### 3 Adjust the volume.

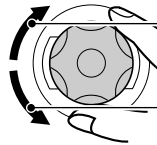

To increase the volume

To decrease the volume

Volume level appears.

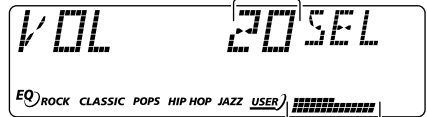

Volume (or audio) level indicator  
(see page 27)

### 4 Adjust the sound as you want. (See pages 23 and 24.)

#### To drop the volume in a moment

Press **⏻/ATT** briefly while listening to any source. "ATT" starts flashing on the display, and the volume level will drop in a moment. To resume the previous volume level, press the button briefly again.

- If you turn the control dial, you can also restore the sound.

#### To turn off the power

Press and hold **⏻/ATT** for more than one second.

"SEE YOU" appears, then the unit turns off.

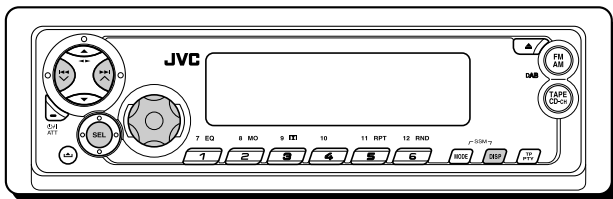

## Setting the clock

You can also set the clock system to either 24 hours or 12 hours.

- 1 Press and hold SEL (select) for more than 2 seconds so that one of the PSM items appears on the display.** (PSM: see page 26.)

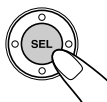

- 2 Set the hour.**

- 1 Select "CLOCK H" (hour) if not shown on the display.
- 2 Adjust the hour.

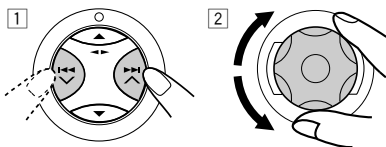

- 3 Set the minute.**

- 1 Select "CLOCK M" (minute).
- 2 Adjust the minute.

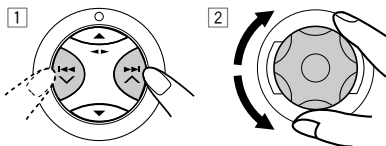

- 4 Set the clock system.**

- 1 Select "24H/12H."
- 2 Select "24H" or "12H."

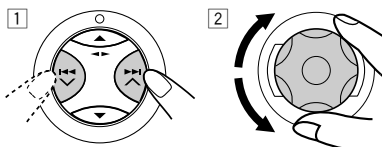

- 5 Finish the setting.**



**Note:**

To show the clock time on the display, see page 27.

To check other information during play, press DISP (display).



Each time you press the button, the other information will be shown on the upper part of the display. (See page 27 for details.)

- Pressing DISP (display) with the unit turned off will show the clock time for about 5 seconds.



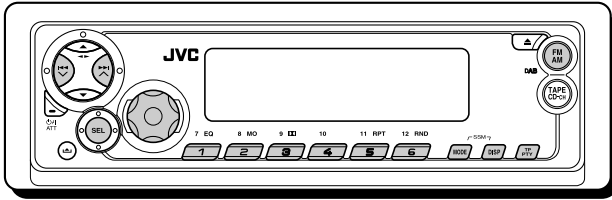

## Listening to the radio

You can use either automatic searching or manual searching to tune in to a particular station.

### Searching a station automatically: Auto search

#### 1 Select the band (FM1 – 3, AM).



Each time you press the button, the band changes as follows:

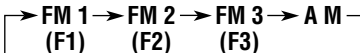

Selected band appears\*.

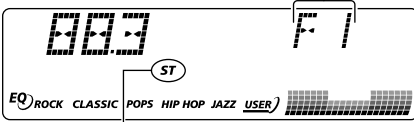

Lights up when receiving an FM stereo broadcast with sufficient signal strength.

\* When "CLOCK" is set to "ON" (see page 27), the current indication will soon change to the clock time.

#### Note:

This receiver has three FM bands (FM1, FM2, FM3).

- FM1/FM2: 87.5 MHz to 108.0 MHz
- FM3: 65.00 MHz to 74.00 MHz

#### 2 Start searching a station.

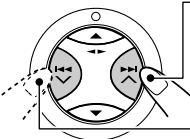

To search stations of higher frequencies

To search stations of lower frequencies

When a station is received, searching stops.

To stop searching before a station is received, press the same button you have pressed for searching.

### Searching a station manually: Manual search

#### 1 Select the band (FM1 – 3, AM).



Each time you press the button, the band changes as follows:

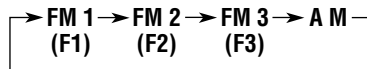

#### Note:

This receiver has three FM bands (FM1, FM2, FM3).

- FM1/FM2: 87.5 MHz to 108.0 MHz
- FM3: 65.00 MHz to 74.00 MHz

#### 2 Press and hold >>> ^ or <<< v until "MANU" (manual) starts flashing on the display.

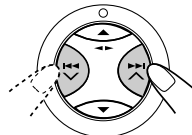

CONTINUED ON THE NEXT PAGE



### 3 Tune in to a station you want while “MANU” (manual) is flashing.

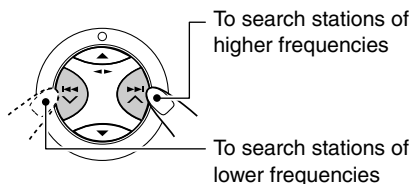

- If you release your finger from the button, the manual mode automatically turns off after 5 seconds.
- If you hold down the button, the frequency keeps changing—in 50 kHz intervals (87.5 MHz – 108.0 MHz for FM 1 and FM 2), in 30 kHz intervals (65.00 MHz – 74.00 MHz for FM 3) and 9 kHz for AM —MW/LW until you release the button.

### When an FM stereo broadcast is hard to receive:



- 1 Press MODE to enter the functions mode while listening to an FM stereo broadcast. “MODE” flashes on the upper part of the display.

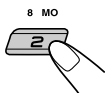

- 2 Press MO (monaural), while “MODE” is still flashing on the display, so that the MO indicator lights up on the display. Each time you press the button, the MO indicator lights up and goes off alternately.



MO (monaural) indicator

When the MO indicator is lit on the display, the sound you hear becomes monaural but the reception will be improved.

## Storing stations in memory

You can use one of the following two methods to store broadcasting stations in memory.

- Automatic preset of FM stations: SSM (Strong-station Sequential Memory)
- Manual preset of both FM and AM stations

### FM station automatic preset: SSM

You can preset 6 local FM stations in each FM band (FM1, FM2, and FM3).

#### 1 Select the FM band (FM1 – 3) you want to store FM stations into.



Each time you press the button, the band changes as follows:

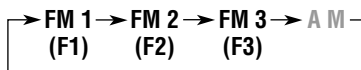

#### 2 Press and hold both buttons for more than 2 seconds.

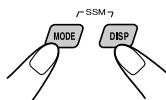

“-SSM-” appears, then disappears when automatic preset is over.

Local FM stations with the strongest signals are searched and stored automatically in the band number you have selected (FM1, FM2, or FM3). These stations are preset in the number buttons —No.1 (lowest frequency) to No.6 (highest frequency).

When automatic preset is over, the station stored in number button 1 will be automatically tuned in.

## Manual preset

You can preset up to 6 stations in each band (FM1, FM2, FM3, and AM) manually.

Ex.: Storing FM station of 92.5 MHz into the preset number 1 of the FM1 band.

### 1 Select the band (FM1 – 3, AM) you want to store stations into (in this example, FM1).



Each time you press the button, the band changes as follows:

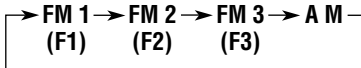

### 2 Tune in to a station (in this example, of 92.5 MHz).

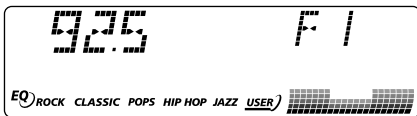
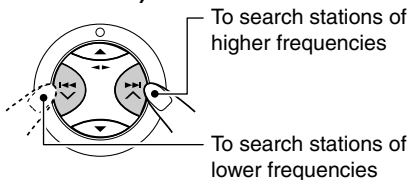

### 3 Press and hold the number button (in this example, 1) for more than 2 seconds.

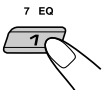

Selected band/preset number and “MEMO” (memory) appear alternately for a while.

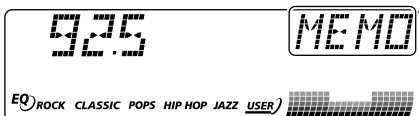

### 4 Repeat the above procedure to store other stations into other preset numbers.

#### Notes:

- A previously preset station is erased when a new station is stored in the same preset number.
- Preset stations are erased when the power supply to the memory circuit is interrupted (for example, during battery replacement). If this occurs, preset the stations again.

## Tuning in to a preset station

You can easily tune in to a preset station. Remember that you must store stations first. If you have not stored them yet, see “Storing stations in memory” on pages 10 and 11.

### 1 Select the band (FM1 – 3, AM).



Each time you press the button, the band changes as follows:

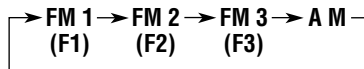

### 2 Select the number (1 – 6) for the preset station you want.

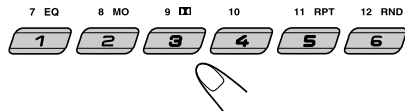



## What you can do with RDS

RDS (Radio Data System) allows FM stations to send an additional signal along with their regular programme signals. For example, the stations send their station names, as well as information about what type of programme they broadcast, such as sports or music, etc.

Another advantage of RDS function is called "Enhanced Other Networks." By using the Enhanced Other Networks data sent from a station, you can tune in to a different station of a different network broadcasting your favorite programme or traffic announcement while listening to another programme or to another source such as tape.

By receiving the RDS data, this unit can do the following:

- Tracing the same programme automatically (Network-Tracking Reception)
- Standby Reception of TA (Traffic Announcement) or your favorite programme
- PTY (Programme Type) search
- Programme search
- And some other functions

### Tracing the same programme automatically (Network-Tracking Reception)

When driving in an area where FM reception is not good, the tuner built in this unit automatically tunes in to another RDS station, broadcasting the same programme with stronger signals. So, you can continue to listen to the same programme in its finest reception, no matter where you drive. (See the illustration on page 18.)

Two types of the RDS data are used to make Network-Tracking Reception work correctly —PI (Programme Identification) and AF (Alternative Frequency).

Without receiving these data correctly from the RDS station you are listening to, Network-Tracking Reception will not operate.

## To use Network-Tracking Reception

You can select the different modes of network-tracking reception to continue listening to the same programme in its finest reception. When shipped from the factory, "AF" is selected.

- **AF:** Network-Tracking Reception is activated with Regionalization set to "off." With this setting, the unit switches to another station within the same network when the receiving signals from the current station become weak. (In this mode, the programme may differ from the one currently received.) The AF indicator lights up but the REG indicator does not.
- **AF REG:** Network-Tracking Reception is activated with Regionalization set to "on." With this setting, the unit switches to another station, within the same network, broadcasting the same programme when the receiving signals from the current station become weak. Both the AF indicator and the REG indicator light up.
- **OFF:** Network-Tracking Reception is deactivated. Neither the AF indicator nor the REG indicator lights up.

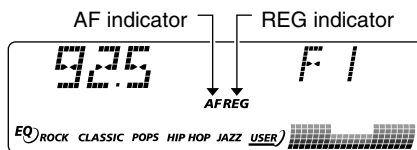

### Note:

If a DAB tuner is connected and Alternative Reception (for DAB services) is activated, Network-Tracking Reception ("AF") is also activated automatically. On the other hand, Network-Tracking Reception cannot be deactivated without deactivating Alternative Reception. (See page 39.)



- 1 Press and hold SEL (select) for more than 2 seconds so that one of the PSM items appears on the display. (PSM: see page 26.)**

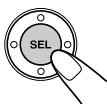

- 2 Select “AF-REG” (alternative frequency/regionalization reception) if not shown on the display.**

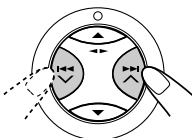

- 3 Select the desired mode—“AF,” “AF REG,” or “OFF.”**

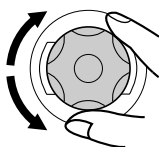

- 4 Finish the setting.**



## Using TA Standby Reception

TA Standby Reception allows the unit to switch temporarily to Traffic Announcement (TA) from the current source (another FM station, tape, or other connected components).

- *TA Standby Reception will not work if you are listening to an AM station.*

Press TP PTY to activate TA Standby Reception.



- **When the current source is FM**, the TP indicator either lights up or flashes.

- If the TP indicator lights up, TA Standby Reception is activated.

If a station starts broadcasting a traffic announcement, “TRAFFIC” appears on the display, and this unit automatically tunes in to the station. The volume changes to the preset TA volume level (see page 17) and the traffic announcement can be heard.

- If the TP indicator flashes, TA Standby Reception is not yet activated since the station being received does not provide the signals used for TA Standby Reception.

To activate TA Standby Reception, you need to tune in to another station providing these signals. Press ►► ▲ or ◀◀ ▼ to search for such a station.

When a station providing these signals is tuned in, the TP indicator stops flashing and remains lit. Now TA Standby Reception is activated.

- **When the current source is other than FM**, the TP indicator lights up.

If a station starts broadcasting a traffic announcement, “TRAFFIC” appears on the display, and this unit automatically changes the source and tunes in to the station.

**To deactivate the TA Standby Reception**, press TP PTY again. The TP indicator goes off.



## Using PTY Standby Reception

PTY Standby Reception allows the unit to switch temporarily to your favorite programme (PTY: Programme Type) from the current source (another FM station, tape, or other connected components).

- *PTY Standby Reception will not work if you are listening to an AM station.*

You can select your favorite programme type for PTY Standby Reception.

When shipped from the factory, PTY Standby Reception is turned off. ("OFF" is selected for PTY Standby Reception.)

- 1 Press and hold SEL (select) for more than 2 seconds so that one of the PSM items appears on the display. (PSM: see page 26.)**



- 2 Select "PTY STBY" (standby) if not shown on the display.**

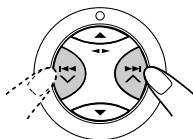

- 3 Select one of the twenty-nine PTY codes. (See page 18.)**

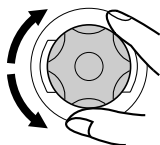

Selected code name appears on the display and is stored into memory.

- 4 Finish the setting.**



- **When the current source is FM,** the PTY indicator either lights up or flashes.

- **If the PTY indicator lights up,** PTY Standby Reception is activated.

If a station starts broadcasting the selected PTY programme, this unit automatically tunes in to the station.

- **If the PTY indicator flashes,** PTY Standby Reception is not yet activated since the station being received does not provide the signals used for PTY Standby Reception. To activate PTY Standby Reception, you need to tune in to another station providing these signals. Press ►► ▲ or ◀◀ ▼ to search for such a station.

When a station providing these signals is tuned in, the PTY indicator stops flashing and remains lit. Now PTY Standby Reception is activated.

- **When the current source is other than FM,** the PTY indicator lights up.

If a station starts broadcasting the selected PTY programme, this unit automatically changes the source and tunes in to the station.

**To deactivate the PTY Standby Reception,** select "OFF" in step 3 on the left column. The PTY indicator goes off.



## Searching your favorite programme

You can search any one of the PTY codes. In addition, you can store your 6 favorite programme types in the number buttons. When shipped from the factory, the following 6 programme types have been stored in the number buttons (1 to 6).

To store your favorite programme types, see below.

To search your favorite programme type, see page 16.

1	2	3
POP M	ROCK M	EASY M
4	5	6
CLASSICS	AFFAIRS	VARIED

## To store your favorite programme types

- 1 Press and hold TP PTY for more than 2 seconds while listening to an FM station.



The last selected PTY code appears.

- 2 Select one of the twenty-nine PTY codes. (See page 18.)

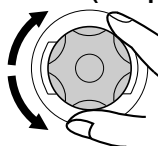

Selected code name appears on the display.

- 3 Press and hold the number button for more than 2 seconds to store the PTY code selected into the preset number you want.

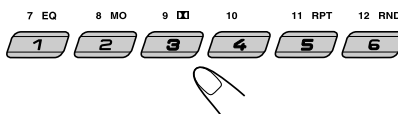

Selected preset number and "MEMO" (memory) appear alternately.

- 4 Press and hold TP PTY for more than 2 seconds to exit from this mode.





## To search your favorite programme type

- 1 Press and hold TP PTY for more than 2 seconds while listening to an FM station.



The last selected PTY code appears.

- 2 To select one of your favorite programme type

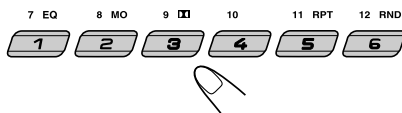

or

To select any one of the twenty-nine PTY codes

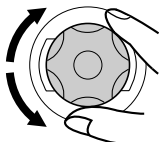

Preset number appears only if you select a PTY code using the number buttons.



Ex.: When "ROCK M" is selected

- 3 Press **▶▶** **▲** or **◀◀** **▼** to start PTY search for your favorite programme.

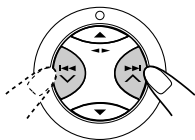

- If there is a station broadcasting a programme of the same PTY code as you selected, that station is tuned in.
- If there is no station broadcasting a programme of the same PTY code as you selected, the station will not change.

### Note:

In some areas, the PTY search will not work correctly.

## Other convenient RDS functions and adjustments

### Automatic selection of the station when using the number buttons

Usually when you press the number button, the preset station is tuned in. However, when the preset station is an RDS station, something different will happen. If the signals from that preset station are not sufficient for good reception, this unit, using the AF data, tunes in to another frequency broadcasting the same programme as the original preset station is broadcasting. (Programme search)

- The unit takes some time to tune in to another station using programme search.

To activate programme search, follow the procedure below.

- See also "Changing the general settings (PSM)" on page 25.

- 1 Press and hold SEL (select) for more than 2 seconds so that one of the PSM items appears on the display.
- 2 Press **▶▶** **▲** or **◀◀** **▼** to select "P(Programme)-SEARCH."
- 3 Turn the control dial clockwise to select "ON." Now programme search is activated.
- 4 Press SEL (select) to finish the setting.

To cancel programme search, repeat the same procedure and select "OFF" in step 3 by turning the control dial counterclockwise.





## Changing the display mode while listening to an FM station

You can change the initial indication on the display to station name (PS NAME) or station frequency (FREQ) while listening to an FM RDS station.

- See also “Changing the general settings (PSM)” on page 25.
- 1 Press and hold SEL (select) for more than 2 seconds so that one of the PSM items appears on the display.
  - 2 Press ►►| ▲ or |◄◄ ▼ to select “TU DISP” (tuner display).
  - 3 Turn the control dial to set to the desired indication (“PS NAME” or “FREQ”).
  - 4 Press SEL (select) to finish the setting.

### Note:

By pressing DISP (display), you can change the display while listening to an FM RDS station. Each time you press the button, the following information appears on the main display:

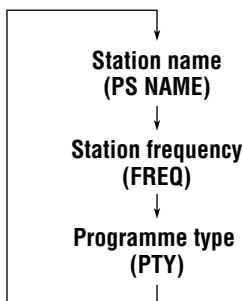

- Then, the display goes back to the original indication in several seconds.
- For more details, see “To set the clock display —CLOCK” on page 27.

## Setting the TA volume level

You can preset the volume level for TA Standby Reception. When a traffic programme is received, the volume level automatically changes to the preset level.

- See also “Changing the general settings (PSM)” on page 25.
- 1 Press and hold SEL (select) for more than 2 seconds so that one of the PSM items appears on the display.
  - 2 Press ►►| ▲ or |◄◄ ▼ to select “TA VOL” (TA volume).
  - 3 Turn the control dial to set to the desired volume.  
You can set it from “VOL 00” to “VOL 50.”
  - 4 Press SEL (select) to finish the setting.

## Automatic clock adjustment

When shipped from the factory, the clock built in this unit is set to be readjusted automatically using the CT (Clock Time) data in the RDS signal.

If you do not want to use automatic clock adjustment, follow the procedure below.

- See also “Changing the general settings (PSM)” on page 25.
- 1 Press and hold SEL (select) for more than 2 seconds so that one of the PSM items appears on the display.
  - 2 Press ►►| ▲ or |◄◄ ▼ to select “AUTO ADJ” (adjustment).
  - 3 Turn the control dial counterclockwise to select “OFF”.  
Now automatic clock adjustment is canceled.
  - 4 Press SEL (select) to finish the setting.

**To reactivate clock adjustment,** repeat the same procedure and select “ON” in step 3 by turning the control dial clockwise.

### Note:

You must stay tuned to the same station for more than 2 minutes after setting “AUTO ADJ” to “ON.” Otherwise, the clock time will not be adjusted. (This is because the unit takes up to 2 minutes to capture the CT data in the RDS signal.)



### PTY codes

NEWS:	News	SOCIAL:	Programmes on social activities
AFFAIRS:	Topical programmes expanding on current news or affairs	RELIGION:	Programmes dealing with any aspect of belief or faith, or the nature of existence or ethics
INFO:	Programmes which impart advice on a wide variety of topics	PHONE IN:	Programmes where people can express their views either by phone or in a public forum
SPORT:	Sport events	TRAVEL:	Programmes about travel destinations, package tours, and travel ideas and opportunities
EDUCATE:	Educational programmes	LEISURE:	Programmes concerned with recreational activities such as gardening, cooking, fishing, etc.
DRAMA:	Radio plays	JAZZ:	Jazz music
CULTURE:	Programmes on national or regional culture	COUNTRY:	Country music
SCIENCE:	Programmes on natural science and technology	NATION M:	Current popular music from another nation or region, in that country's language
VARIED:	Other programmes like comedies or ceremonies	OLDIES:	Classic pop music
POP M:	Pop music	FOLK M:	Folk music
ROCK M:	Rock music	DOCUMENT:	Programmes dealing with factual matters, presented in an investigative style
EASY M:	Easy-listening music		
LIGHT M:	Light music		
CLASSICS:	Classical music		
OTHER M:	Other music		
WEATHER:	Weather information		
FINANCE:	Reports on commerce, trading, the Stock Market, etc.		
CHILDREN:	Entertainment programmes for children		

### The same programme can be received on different frequencies.

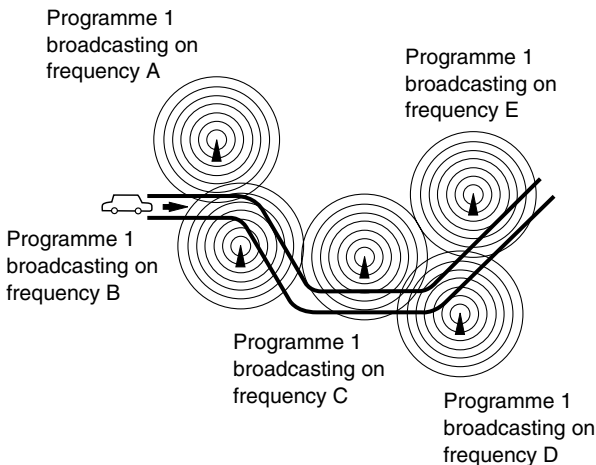

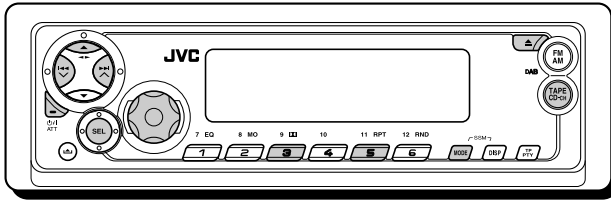

## Listening to a cassette

You can play back type I (normal) tapes.

### 1 Open the control panel.

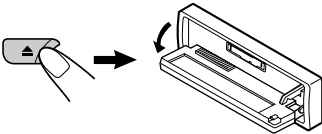

#### Note on One-Touch Operation:

When a cassette is already in the cassette compartment, pressing TAPE CD-CH turns on the unit and starts tape play automatically.

### 2 Insert a cassette into the cassette compartment.

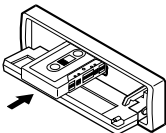

The unit turns on and tape play starts automatically.

### 3 Close the control panel by hand.

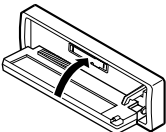

### 4 Select the tape direction.

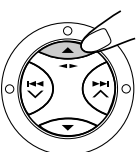

Each time you press ◀▶, the tape direction changes alternately between forward (TAPE >>>) and reverse (TAPE <<<).

## To stop play and eject the cassette

Press ▲.

Tape play stops, the control panel flips down. The cassette automatically ejects from the cassette compartment. The source changes to the previously selected one.

If you change the source, tape play also stops (without ejecting the cassette this time).

- You can also eject the cassette by pressing ▲ while the unit is turned off.

## To fast-forward and rewind a tape

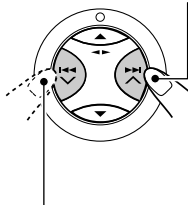

Press and hold ▶▶▶ ▲ for more than one second to fast-forward the tape.

When the tape reaches its end, the tape is reversed and playback starts from the beginning of the other side.

Press and hold ◀◀◀ ▼ for more than one second to rewind the tape.

When the tape reaches its end, playback of the same side starts.

## To stop fast-forward and rewind at any position on the tape, press ◀▶.

Tape play starts from that position on the tape.

#### Notes:

- When one side of the tape reaches its end during play, the other side of the tape automatically starts playing. (Auto Reverse)
- When the tape reaches its end while fast-forwarding, the tape direction will be changed automatically.



## To play back tapes recorded with the Dolby B NR\*

- 1 Press MODE to enter the functions mode while listening to a tape. "MODE" flashes on the upper part of the display.
- 2 Press **□□** (Dolby B), while "MODE" is still flashing on the display so that the **□□** (Dolby B) indicator lights up. "DOLBY B" also appears on the display for several seconds.

**To cancel the Dolby B NR**, repeat steps 1 and 2 again so that the **□□** (Dolby B) indicator goes off.

\* Manufactured under license from Dolby Laboratories.  
"Dolby" and the double-D symbol are trademarks of Dolby Laboratories.

## Finding the beginning of a tune

Multi Music Scan (MMS) allows you to automatically start playback from the beginning of a specified tune. You can specify up to 9 tunes ahead of or before the current tune.

### During playback

**Specify the tune you want to locate (how many tunes ahead of or before the current tune).**

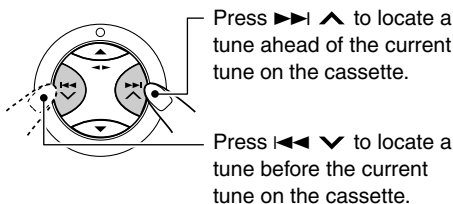

Ex.: When you locate three tunes ahead of the current tune

Each time you press the buttons, the number changes up to ±9. When the beginning of the specified tune is located, playback starts automatically.

### Notes:

- While locating a specified tune:
  - If the tape is rewound to its beginning, playback starts from the beginning of that side.
  - If the tape is fast-forwarded to the end, it is reversed and played from the beginning of the other side.
- In the following cases, the Multi Music Scan function may not operate correctly:
  - Tapes with tunes having long pianissimo passages (very quiet parts) or non-recorded portions between tunes.
  - Tapes with short non-recorded sections.
  - Tapes with high level of noise or humming between tunes.
  - Tapes with tunes recorded at low recording levels.
  - The Dolby NR setting does not match. For example, if Dolby B NR is on and the tape was recorded with no Dolby NR.



## Other convenient tape functions

### Skipping the blank portions on the tape

You can skip blank portions between the tunes (Blank Skip).

When this function is turned on, the unit fast-forwards (skipping blank portions of 15 seconds or more), to the next tune and starts playback.

- See also “Changing the general settings (PSM)” on page 25.

- 1 Press and hold SEL (select) for more than 2 seconds so that one of the PSM items appears on the display. (PSM: see page 26.)**



- 2 Press >>>| ^ or |<<< v to select “B.SKIP” (blank skip).**

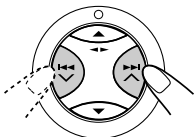

- 3 Turn the control dial clockwise to select “ON.”**

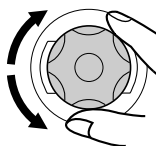

Now Blank Skip is activated.

- 4 Finish the setting.**



To cancel Blank Skip, repeat the same procedure and select “OFF” in step 3 by turning the control dial counterclockwise.

## Playing the current tune repeatedly

You can play the current tune repeatedly (Repeat Play).



- 1 Press MODE to enter the functions mode while playing a tune you want to hear over again on a cassette. "MODE" flashes on the upper part of the display.

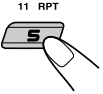

- 2 Press RPT (repeat), while "MODE" is still on the display, so that "REPEAT" appears on the display.



Lights up when Repeat Play is turned on.

When the tune has been played, the tape is automatically rewound to the beginning of that tune and the same tune will be played again.

**To cancel Repeat Play**, repeat steps 1 and 2 again so that the RPT indicator goes off.

### Note:

In the following cases, Blank Skip and Repeat Play may not operate correctly:

- Tapes with tunes having long pianissimo passages (very quiet parts) or non-recorded portions during tunes.
- Tapes with short non-recorded sections.
- Tapes with high level noise or humming between tunes.
- Tapes with tunes recorded at low recording levels.
- The Dolby NR setting does not match. For example, if Dolby B NR is on and the tape was recorded with no Dolby NR.

## Prohibiting cassette ejection

You can prohibit cassette ejection and lock a cassette in the cassette compartment.

**While pressing TAPE CD-CH, press and hold  $\phi$ /I ATT for more than 2 seconds.**



"NO EJECT" flashes on the display for about 5 seconds, and the cassette is locked and cannot be ejected.



**To cancel the prohibition and unlock the cassette**

While pressing TAPE CD-CH, press and hold  $\phi$ /I ATT again for more than 2 seconds. "EJECT OK" flashes on the display for about 5 seconds, and the cassette is unlocked.



### Note:

If you press  $\blacktriangle$  while cassette ejection is prohibited, the control panel flips down, but the cassette continues to play and cannot be ejected.



## Selecting preset sound modes (C-EQ: custom equalizer)

You can select a preset sound mode (C-EQ: custom equalizer) suitable to the music genre.

- There is a time limit in doing the following procedure. If the setting is canceled before you finish, start from step 1 again.

### 1 Press MODE to enter the functions mode.



“MODE” flashes on the upper part of the display.

### 2 Press EQ (equalizer) while “MODE” is still flashing on the display.

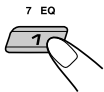

The last selected sound mode is recalled and applied to the current source.



Sound mode indicator flashes.

Ex.: If you have selected “USER” previously

### 3 Select the sound mode you want.

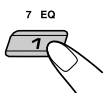

Each time you press the button, the sound modes change as follows:



Sound mode indicator flashes.

Ex.: When you select “ROCK”

Indication	For:	Preset values		
		BAS	TRE	LOUD
USER	(Flat sound)	00	00	OFF
ROCK	Rock or disco music	+03	+01	ON
CLASSIC	Classical music	+01	-02	OFF
POPS	Light music	+04	+01	OFF
HIP HOP	Funk or rap music	+02	00	ON
JAZZ	Jazz music	+02	+03	OFF

#### Note:

You can adjust each sound mode to your preference. Once you make an adjustment, it is automatically stored for the currently selected sound mode. See “Adjusting the sound” on page 24.



## Adjusting the sound

You can adjust the sound characteristics to your preference.

### 1 Select the item you want to adjust.



Each time you press the button, the adjustable items change as follows:

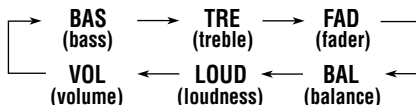

Indication	To do:	Range
BAS* <sup>1</sup>	Adjust the bass.	-06 (min.)   +06 (max.)
TRE* <sup>1</sup>	Adjust the treble.	-06 (min.)   +06 (max.)
FAD* <sup>2</sup>	Adjust the front and rear speaker balance.	R06 (Rear only)   F06 (Front only)
BAL	Adjust the left and right speaker balance.	L06 (Left only)   R06 (Right only)
LOUD* <sup>1</sup>	Boost low and high frequencies to produce a well-balanced sound at low volume level.	LOUD ON   LOUD OFF
VOL* <sup>3</sup>	Adjust the volume.	00 (min.)   50 (max.)

\*<sup>1</sup> When you adjust the bass, treble, or loudness, the adjustment you have made is stored for the currently selected sound mode (C-EQ) including "USER."

\*<sup>2</sup> If you are using a two-speaker system, set the fader level to "00."

\*<sup>3</sup> Normally the control dial works as the volume control. So you do not have to select "VOL" to adjust the volume level.

### 2 Adjust the setting.

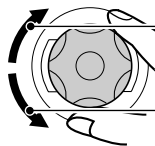

To increase the level or turn on the loudness

To decrease the level or turn off the loudness

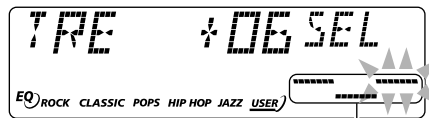

Equalization pattern changes as you adjust the bass or treble.

Ex. 1: When you adjust "TRE" (treble)



Ex. 2: When you turn on the loudness

### 3 Repeat steps 1 and 2 to adjust the other items.

To reset each sound mode to the factory settings, repeat the same procedure and reassign the preset values listed in the table on page 23.





## Changing the general settings (PSM)

You can change the items listed on the next page by using the PSM (Preferred Setting Mode) control.

### Basic Procedure

- 1** Press and hold SEL (select) for more than 2 seconds so that one of the PSM items appears on the display. (See page 26.)



- 2** Select the PSM item you want to adjust.

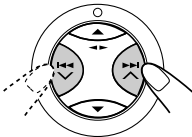

Ex.: When you select "LEVEL"

- 3** Adjust the PSM item selected.

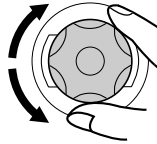

Ex.: When you select "AUDIO 2"

- 4** Repeat steps 2 and 3 to adjust the other PSM items if necessary.

- 5** Finish the setting.





## Preferred Setting Mode (PSM) items

- For detailed operations of each PSM items, refer to the pages listed in the table.

Indications		Selectable values/items		Factory-preset settings	See page
<b>CLOCK H</b>	Hour adjustment	0 – 23 (1 – 12)		0 (0:00)	8
<b>CLOCK M</b>	Minute adjustment	00 – 59		00 (0:00)	8
<b>24H/12H</b>	24/12-hour time display	12H	24H	24H	8
<b>AUTO ADJ</b>	Automatic clock setting	OFF	ON	ON	17
<b>CLOCK</b>	Clock display	OFF	ON	ON	27
<b>TU DISP</b>	Tuner display	PS NAME ↔ FREQ		PS NAME	17
<b>AF-REG</b>	Alternative frequency/ Regionalization reception	AF ↑ ↘	↔ AF REG OFF*1 ↙ ↗	AF	12, 13
<b>PTY STBY</b>	PTY standby	OFF → 29 programme types (see page 18) ↑		OFF	14
<b>TA VOL</b>	Traffic announcement volume	VOL 00 – VOL 50		VOL 20	17
<b>P-SEARCH</b>	Programme search	OFF	ON	OFF	16
<b>DAB AF*2</b>	Alternative frequency search	AF OFF	AF ON	AF ON	39
<b>DAB VOL*2</b>	DAB volume adjustment	VOL –12	VOL 12	VOL 00	39
<b>LEVEL</b>	Level display	AUDIO 1 ↑ ↘	↔ AUDIO 2 OFF ↙ ↗	AUDIO 2	27
<b>DIMMER</b>	Dimmer mode	AUTO ↑ ↘	↔ OFF ON ↙ ↗	AUTO	27
<b>TEL</b>	Telephone muting	OFF ↑ ↘	↔ MUTING 1 MUTING 2 ↙ ↗	OFF	27
<b>BEEP</b>	Key-touch tone	OFF	ON	ON	28
<b>SCROLL</b>	Scroll mode	ONCE ↑ ↘	↔ AUTO OFF ↙ ↗	ONCE	28
<b>B.SKIP</b>	Blank skip	OFF	ON	OFF	21
<b>EXT IN*3</b>	External component	CHANGER	LINE IN	CHANGER	28
<b>TAG DISP</b>	Tag display	TAG OFF	TAG ON	TAG ON	28

\*1 Displayed only when the "DAB AF" is set to "AF OFF."

\*2 Displayed only when the DAB tuner is connected.

\*3 Displayed only when one of the following sources is selected—FM, AM, and TAPE.



### To set the clock display—CLOCK

You can set the clock to be shown on the display when the unit is turned on.

When shipped from the factory, the clock is set to be shown on the display.

- ON: Clock display is turned on.
- OFF: Clock display is turned off. When "OFF" is selected, the other information (see table below) appears instead of the clock display (except when "LINE IN" is selected as the source).

#### When CLOCK is set to OFF:

Source	Initial indication	Pressing DISP (display)
Tuner (FM/AM/DAB)	Band	Clock appears for about 5 seconds.
TAPE or CD-CH	"TAPE" or disc number	

#### When CLOCK is set to ON:

Source	Initial indication	Pressing DISP (display)
Tuner (FM/AM/DAB)	Clock	Band appears for about 5 seconds.
TAPE	Clock	"TAPE" appears for about 5 seconds.
CD-CH	Clock	Disc number and track/file number appear alternately each time you press the button.

### To select the level meter—LEVEL

You can select the level meter display according to your preference.

When shipped from the factory, "AUDIO 2" is selected.

- AUDIO 1: Shows the audio level indicator.
- AUDIO 2: Alternates "AUDIO 1" setting and illumination display.
- OFF: Erases the audio level indicator.

### To select the dimmer mode—DIMMER

When you turn on the car headlights, the display automatically dims (Auto Dimmer).

When shipped from the factory, Auto Dimmer mode is activated.

- AUTO: Activates Auto Dimmer.
- OFF: Cancels Auto Dimmer.
- ON: Always dims the display.

**Note:**

*Auto Dimmer equipped with this unit may not work correctly on some vehicles, particularly on those having a control dial for dimming.*

*In this case, set the dimmer mode to "ON" or "OFF."*

### To select the telephone muting—TEL

This mode is used when a cellular phone system is connected. Depending on the phone system used, select either "MUTING 1" or "MUTING 2," whichever mutes the sounds from this unit. When shipped from the factory, this mode is deactivated.

- MUTING 1: Selects this if this setting can mute the sounds while using the cellular phone.
- MUTING 2: Selects this if this setting can mute the sounds while using the cellular phone.
- OFF: Cancels the telephone muting.



### To turn on/off the key-touch tone—BEEP

You can deactivate the key-touch tone if you do not want it to beep each time you press a button. When shipped from the factory, the key-touch tone is activated.

- ON: Activates the key-touch tone.
- OFF: Deactivates the key-touch tone.

### To select the scroll mode—SCROLL

You can select the scroll mode for the disc information (when the entire text cannot be shown at once).

When shipped from the factory, scroll mode is set to “ONCE.”

- ONCE: Scrolls only once.
- AUTO: Repeats the scroll (5-second intervals in between).
- OFF: Cancels scroll mode.

**Note:**

Even if the scroll mode is set to “OFF,” you can scroll the display by pressing **DISP** (display) for more than one second.

### To select the external component to use—EXT IN

You can connect the external component to the CD changer jack on the rear using the Line Input Adapter KS-U57 (not supplied).

To use the external component as the playback source through this unit, you need to select which component—CD changer or external component—to use.

When shipped from the factory, CD changer is selected as the external component.

- CHANGER: To use the CD changer.
- LINE IN: To use the external component other than CD changer.

**Note:**

For connecting the Line Input Adapter KS-U57 and the external component, refer to the *Installation/Connection Manual* (separate volume).

### To turn the tag display on or off—TAG DISP

**This function takes effect only when JVC MP3-compatible CD changer is connected.**

An MP3 file can contain file information called “ID3 Tag” where its album name, performer, track title, etc. are recorded.

There are two versions—ID3v1 (ID3 Tag version 1) and ID3v2 (ID3 Tag version 2). Only ID3v1 can be shown.

When shipped from the factory, “TAG ON” is selected.

- TAG ON: Turns on the ID3 tag display while playing MP3 files.
  - If an MP3 file does not have ID3 tags, folder name and file name appear.

**Note:**

If you change the setting from “TAG OFF” to “TAG ON” while playing an MP3 file, the tag display will be activated when the next file starts playing.

- TAG OFF: Turns off the ID3 tag display while playing MP3 files. (Only the folder name and file name can be shown.)



## Detaching the control panel

You can detach the control panel when leaving the car.  
When detaching or attaching the control panel, be careful not to damage the connectors on the back of the control panel and on the panel holder.

### Detaching the control panel

Before detaching the control panel, be sure to turn off the power.

#### **1** Unlock the control panel.

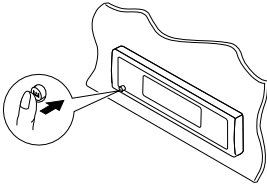

#### **2** Pull the control panel out of the unit.

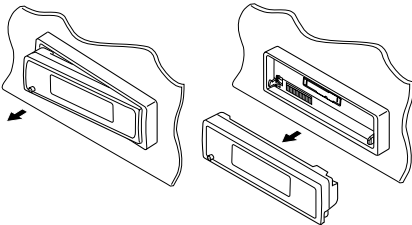

#### **3** Put the detached control panel into the provided case.

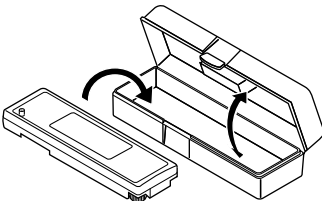

## Attaching the control panel

#### **1** Insert the right side of the control panel into the groove on the panel holder.

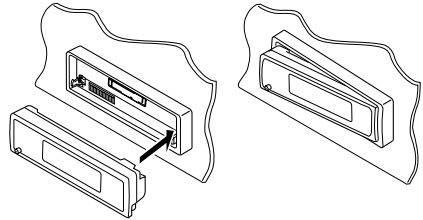

#### **2** Press the left side of the control panel to fix it to the panel holder.

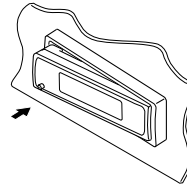

#### **Note on cleaning the connectors:**

*If you frequently detach the control panel, the connectors will deteriorate.*

*To minimize this possibility, periodically wipe the connectors with a cotton swab or cloth moistened with alcohol, being careful not to damage the connectors.*

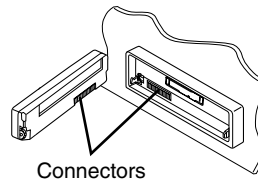



# CD CHANGER OPERATIONS

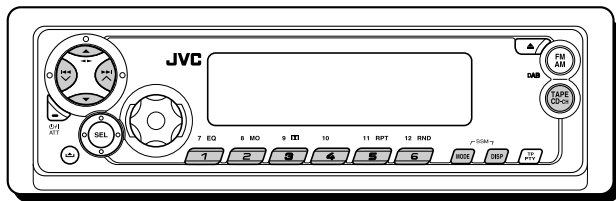

We recommend that you use the JVC MP3-compatible CD changer with your unit.

By using this CD changer, you can play back your original CD-Rs (Recordable) and CD-RWs (Rewritable) recorded either in audio CD format or in MP3 format.

- You can also connect other CH-X series CD changers (except CH-X99 and CH-X100). However, they are not compatible with MP3 discs, so you cannot play back MP3 discs.
- You cannot use the KD-MK series CD changers with this unit.

Before operating your CD changer:

- Refer also to the Instructions supplied with your CD changer.
- If no discs are in the magazine of the CD changer or the discs are inserted upside down, "NO DISC" will appear on the display. If this happens, remove the magazine and set the discs correctly.
- If no magazine is loaded in the CD changer, "NO MAG" appears on the display. If this happens, insert the magazine in the CD changer.
- If "RESET 1" – "RESET 8" appears on the display, something is wrong with the connection between this unit and the CD changer. If this happens, check the connection and make sure the cords are connected firmly. Then, press the reset button of the CD changer.

## About MP3 discs

MP3 "files (tracks)" can be recorded in "folders"—in PC terminology.

During recording, the files and folders can be arranged in a way similar to arranging files and folders of computer data.

"Root" is similar to the root of a tree. Every file and folder can be linked to and be accessed from the root.

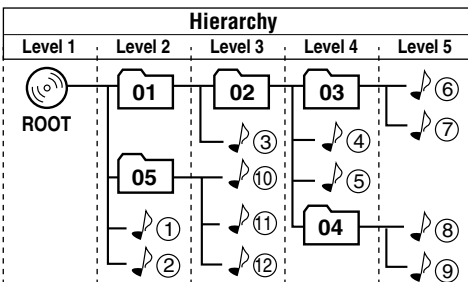

**01** : Folders and their playback order

① : MP3 files and their playback order

## Playing discs

Select the CD changer (CD).



\*1 If you have changed the "EXT IN" setting to "LINE IN" (see page 28), you cannot select the CD changer.

**When the current disc is an MP3 disc:**

Playback starts from the first folder of the current disc once file check is completed.

Selected disc number\*2

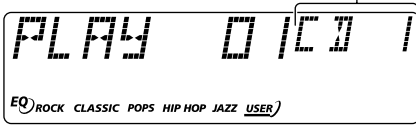

Folder or album name\*3

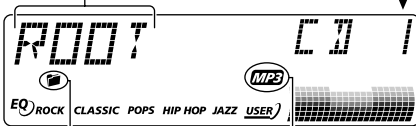

■ (folder) indicator      MP3 indicator

\*2 When "CLOCK" is set to "ON" (see page 27), the current indication will soon change to the clock time.

\*3 If some MP3 files are recorded without being included in a folder, they are played back first and "ROOT" appears as the folder name.

**When the current disc is a CD:**

Playback starts from the first track of the current disc.

Selected disc number\*4



Current track

Elapsed playing time

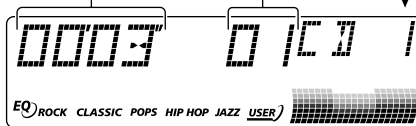

\*4 When "CLOCK" is set to "ON" (see page 27), the current indication will soon change to the clock time.

**Notes:**

- When you press TAPE CD-CH, the power automatically comes on. You do not have to press **⏻/1 ATT** to turn on the power.
- If you change the source, CD changer play also stops. Next time you select the CD changer as the source, CD changer play starts from where playback has been stopped previously.
- When you start playing back a CD Text or an MP3 disc, disc information will automatically appear on the display. (See the explanation that follows.)

**To change the display information**

While playing back an MP3 file or CD Text, you can change the disc information shown on the display.



Each time you press DISP (display), the display changes to show the following:

**For MP3 discs**

- When "TAG DISP" is set to "TAG ON" (initial setting: see page 28)

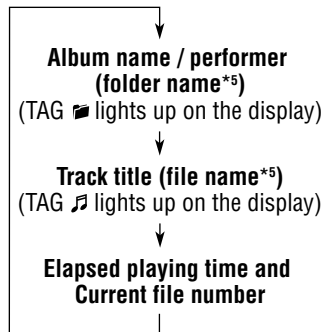

\*5 If an MP3 file does not have ID3 tags, folder name and file name appear. In this case, the TAG indicator will not light up on the display.

- When "TAG DISP" is set to "TAG OFF"

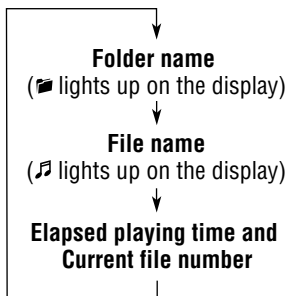

**For CD Text discs**



Each time you press the button, the display changes as follows:

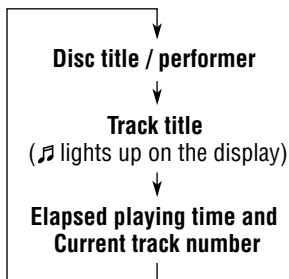

**Notes:**

- The display shows up to 8 characters at one time and scrolls if there are more than 8 characters.  
See also "To select the scroll mode—SCROLL" on page 28.  
Some characters or symbols will not be shown (and be blanked) on the display.  
(Ex. "ABC&#167;d#" ⇔ "ABCA D ")
- When you press DISP (display) while playing an audio CD, "NO NAME" appears for the disc title/performer and the track title.

**To go to a particular disc directly**

Press the number button corresponding to the disc number to start its playback (while the CD changer is playing).

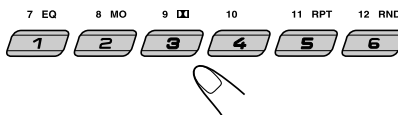

- To select a disc number from 1 – 6: Press 1 (7) – 6 (12) briefly.
- To select a disc number from 7 – 12: Press and hold 1 (7) – 6 (12) for more than one second.

**To fast-forward or reverse the track/file**

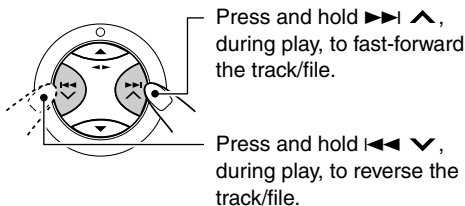

Press and hold **▶▶|▲**, during play, to fast-forward the track/file.

Press and hold **◀◀|▼**, during play, to reverse the track/file.

**Note:**

During this operation on an MP3 disc, you can only hear intermittent sounds. (The elapsed playing time also changes intermittently on the display.)

**To go to the next or previous tracks/files**

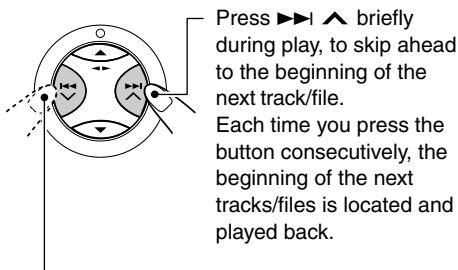

Press **▶▶|▲** briefly during play, to skip ahead to the beginning of the next track/file. Each time you press the button consecutively, the beginning of the next tracks/files is located and played back.

Press **◀◀|▼** briefly during play, to skip back to the beginning of the current track/file. Each time you press the button consecutively, the beginning of the previous tracks/files is located and played back.



**This operation is only possible when using JVC MP3-compatible CD changer (CH-X1500).**

### To go to a track/file quickly

**1** Press MODE to enter the functions mode while playing a disc.



"MODE" flashes on the upper part of the display.

**2** Press ▲ (up) or ▼ (down) while still in the functions mode.

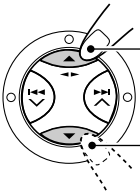

To skip 10 tracks/files\* forwards to the last track/file

To skip 10 tracks/files\* backwards to the first track/file

- \* The first time you press ▲ (up) or ▼ (down) button, the track/file skips to the nearest higher or lower track/file with a track/file number of multiple ten (ex. 10th, 20th, 30th). Then each time you press the button, you can skip 10 tracks/files (see "How to go to the desired track/file quickly" on the right column).
- After the last track/file, the first track/file will be selected, and vice versa.

**Note:**

*If the current playing disc is an MP3 disc, files are skipped within the same folder.*

### How to go to the desired track/file quickly

• Ex. 1: To select track/file number 32 while playing track/file number 6

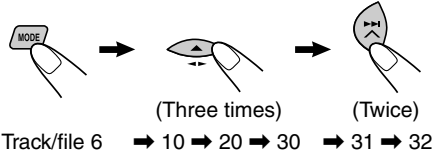

• Ex. 2: To select track/file number 8 while playing track/file number 36

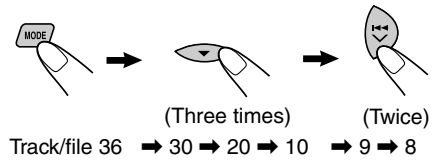

### To skip to the next or previous folder (only for MP3 discs)

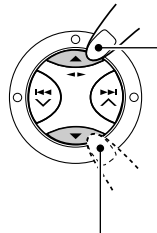

Press ▲ (up) while playing an MP3 disc, to go to the next folder.

Each time you press the button consecutively, the next folder is located, and the first file in the folder starts playback.

Press ▼ (down) while playing an MP3 disc, to go to the previous folder.

Each time you press the button consecutively, the previous folder is located, and the first file in the folder starts playback.

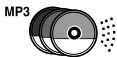

# Selecting the playback modes

## To play back tracks/files at random (Folder Random/Disc Random/Magazine Random Play)



1 Press MODE to enter the functions mode during play. "MODE" flashes on the upper part of the display.

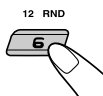

2 Press RND (random), while "MODE" is still flashing on the display. Each time you press the button, the random play mode changes as follows:

For MP3 discs:

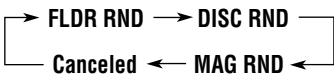

For CDs:

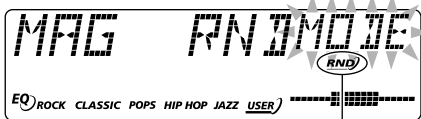
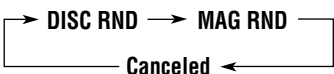

RND indicator

Ex.: When you select "MAG RND"

**Note:**

The MP3 indicator also lights up if the current playing disc is an MP3 disc.

Mode	Active indicator	Plays at random
FLDR RND*	and RND indicators light up.	All files of the current folder, then files of the next folder and so on.
DISC RND	and RND indicators light up.	All tracks/files of the current (or specified) disc.
MAG RND	RND indicator lights up.	All tracks/files of the inserted discs.

\* "FLDR RND" is only applicable for MP3 discs.

## To play back tracks/files repeatedly (Track Repeat/Folder Repeat/Disc Repeat Play)



1 Press MODE to enter the functions mode during play. "MODE" flashes on the upper part of the display.

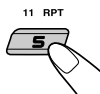

2 Press RPT (repeat), while "MODE" is still flashing on the display. Each time you press the button, the repeat play mode changes as follows:

For MP3 discs:

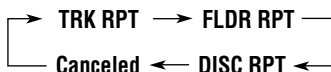

For CDs:



(disc) and RPT indicators

Ex.: When you select "DISC RPT"

**Note:**

The MP3 indicator also lights up if the current playing disc is an MP3 disc.

Mode	Active indicator	Plays repeatedly
TRK RPT	RPT indicator lights up.	The current (or specified) track/file.
FLDR RPT*	and RPT indicators light up.	All files of the current (or specified) folder of the current disc.
DISC RPT	and RPT indicators light up.	All tracks/files of the current (or specified) disc.

\* "FLDR RPT" is only applicable for MP3 discs.

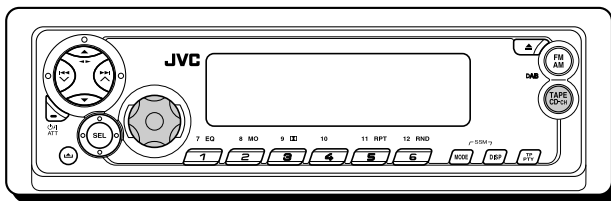

## Playing an external component

You can connect the external component to the CD changer jack on the rear using the Line Input Adapter KS-U57 (not supplied).

### Preparations:

- For connecting the Line Input Adapter KS-U57 and the external component, refer to the Installation/ Connection Manual (separate volume).
- Before operating the external component using the following procedure, select the external input correctly. See "To select the external component to use—EXT IN" on page 28.

### 1 Select the external component (LINE IN).

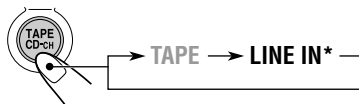

- If "LINE IN\*" does not appear on the display, see page 28 and select the external input ("LINE IN").

\* Displayed only when one of the following sources is selected—FM, AM, and TAPE.

### Note on One-Touch Operation:

When you press TAPE CD-CH, the power automatically comes on. You do not have to press ATT to turn on the power.

### 2 Turn on the connected component and start playing the source.

### 3 Adjust the volume.

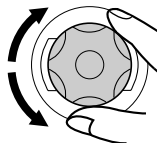

### 4 Adjust the sound characteristics as you want. (See pages 23 and 24.)

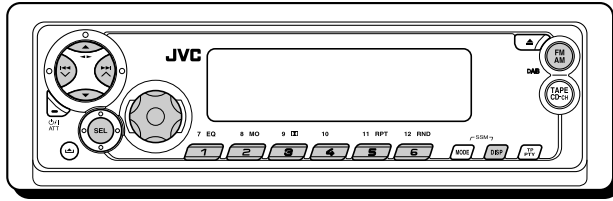

We recommend that you use DAB (Digital Audio Broadcasting) tuner KT-DB1500 or KT-DB1000 with your unit.

If you have another DAB tuner, consult your JVC IN-CAR ENTERTAINMENT dealer.

- Refer also to the Instructions supplied with your DAB tuner.

## What is DAB system?

DAB is one of the digital radio broadcasting systems available today. It can deliver CD quality sound without any annoying interference and signal distortion.

Furthermore, it can carry text, pictures, and data.

In contrast to FM broadcast, where each programme is transmitted on its own frequency, DAB combines several programmes (called “services”) to form one “ensemble.”

In addition, each “service”—called “primary service”—can also be divided into its components (called “secondary service”).

With the DAB tuner connected with this unit, you can enjoy these DAB services.

### Note:

When reception switches between DAB and FM, the listening volume level may increase or decrease inconveniently. This change in the volume level results from unequal audio injection levels at broadcaster site, but not from the malfunction of this unit.

To prevent this inconvenience, you can adjust the DAB volume level. (See “To adjust the DAB volume level” on page 39.)

## Tuning in to an ensemble and one of the services

A typical ensemble has 6 or more programmes (services) broadcast at the same time. After tuning in to an ensemble, you can select a service you want to listen to.

### Before you start...

Press FM AM (DAB) briefly if tape, CD changer, or external component is the current source.

### 1 Select the DAB tuner.



Each time you press and hold the button, the DAB tuner and the FM/AM tuner are alternately selected.

**DAB ↔ FM/AM**

### 2 Select the DAB band (DAB1, DAB2, or DAB3).



Each time you press the button, the DAB band changes as follows:

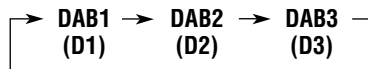

### Note:

This receiver has three DAB bands (DAB1, DAB2, DAB3). You can use any of them to tune in to an ensemble.

### 3 Start searching for an ensemble.

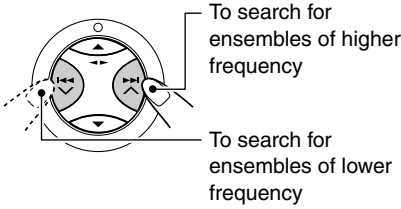

When an ensemble is received, searching stops.

**To stop searching before an ensemble is received,** press the same button you have pressed for searching.

### 4 Select a service (either primary or secondary) you want to listen to.

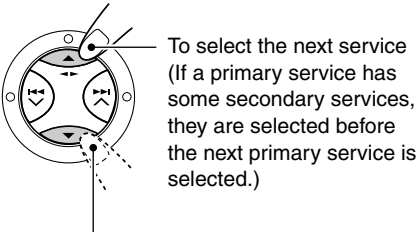

To select the previous service (either primary or secondary)

### To change the display information while tuning in to an ensemble

Normally service name is shown on the display. If you want to check the ensemble name or its frequency, press DISP (display).



Each time you press the button, the following information appears for a while in the main display.

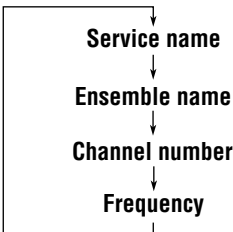

### To tune in to a particular ensemble without searching

#### Before you start...

Press FM AM (DAB) briefly if tape, CD changer, or external component is the current source.

- 1 Press and hold FM AM (DAB) to select DAB tuner as the source.
- 2 Press FM AM (DAB) repeatedly to select the DAB band (DAB1, DAB2, or DAB3).
- 3 Press and hold  $\blacktriangleright$   $\blacktriangle$  or  $\blacktriangleleft$   $\blacktriangledown$  for more than one second. "MANU" (manual) appears on the display.
- 4 Press  $\blacktriangleright$   $\blacktriangle$  or  $\blacktriangleleft$   $\blacktriangledown$  repeatedly until the ensemble you want is reached.
  - If you hold down the button, the frequency keeps changing until you release the button.
- 5 Press  $\blacktriangle$  (up) or  $\blacktriangledown$  (down) to select a service (either primary or secondary) you want to listen to.

### To restore the FM/AM tuner

Press and hold FM AM (DAB) again.

## Storing DAB services in memory

You can preset up to 6 DAB services in each DAB band (DAB1, DAB2, and DAB3) manually.

#### Before you start....

Press FM AM (DAB) briefly if tape, CD changer, or external component is the current source.

### 1 Select the DAB tuner.



Each time you press and hold the button, the DAB tuner and the FM/AM tuner are alternately selected.

**DAB  $\leftrightarrow$  FM/AM**

### 2 Select the DAB band (DAB1, DAB2, or DAB3) you want.



Each time you press the button, the DAB band changes as follows:

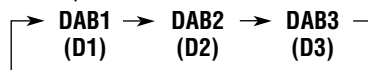

**3** Tune in to an ensemble you want.

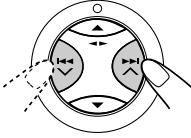

**4** Select a service of the ensemble you want to listen to.

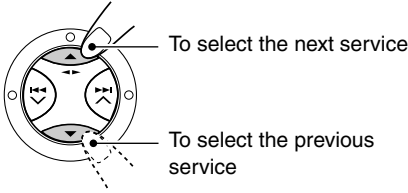

**5** Press and hold the number button (in this example, 1) you want to store the selected service into for more than 2 seconds.

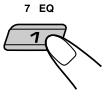

Selected band/preset number and "MEMO" (memory) appear alternately for a while.

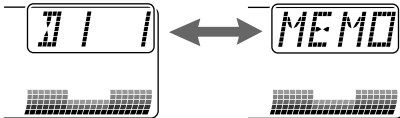

**6** Repeat the above procedure to store other DAB services into other preset numbers.

**Notes:**

- You can only preset primary DAB services. If you store a secondary service, its primary service will be stored instead.
- A previously preset DAB service is erased when a new DAB service is stored in the same preset number.
- Preset DAB services are erased when the power supply to the memory circuit is interrupted (for example, during battery replacement). If this occurs, preset the DAB services again.

**Tuning in to a preset DAB service**

You can easily tune in to a preset DAB service. Remember that you must store services first. If you have not stored them yet, "Storing DAB services in memory" on pages 37 and 38.

**Before you start....**

Press FM AM (DAB) briefly if tape, CD changer, or external component is the current source.

**1** Select the DAB tuner.



Each time you press and hold the button, the DAB tuner and the FM/AM tuner are alternately selected.

DAB ↔ FM/AM

**2** Select the DAB band (DAB1, DAB2, or DAB3) you want.



Each time you press the button, the DAB band changes as follows:

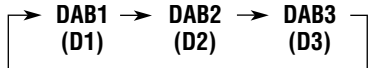

**3** Select the number (1 – 6) for the preset DAB service (primary) you want.

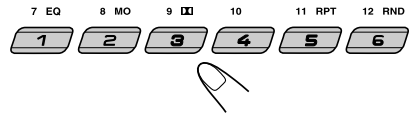

**Note:**

If the selected primary service has some secondary services, pressing the same number button repeatedly will tune in to the secondary services.

# What you can do more with DAB

## Tracing the same program automatically (Alternative Reception)

You can keep listening to the same program.

- **While receiving a DAB service:**  
When driving in an area where a service cannot be received, this unit automatically tunes in to another ensemble or FM RDS station, broadcasting the same program.
- **While receiving an FM RDS station:**  
When driving in an area where a DAB service is broadcasting the same program as the FM RDS station is broadcasting, this unit automatically tunes in to the DAB service.

### Note:

*When reception switches between DAB and FM, the listening volume level may increase or decrease inconveniently. This change in the volume level results from unequal audio injection levels at broadcaster site, but not from the malfunction of this unit. To prevent this inconvenience, you can adjust the DAB volume level (see the right column).*

## To use Alternative Reception

When shipped from the factory, Alternative Reception is activated.

- See also “Changing the general settings (PSM)” on page 25.
- 1 Press and hold SEL (select) for more than 2 seconds so that one of the PSM items appears on the display.
  - 2 Press ►►| ^ or |◄◄ ▼ to select “DAB AF” (alternative frequency).
  - 3 Turn the control dial to select the desired mode.
    - AF ON: Traces the program among DAB services and FM RDS stations —Alternative Reception. The AF indicator lights up on the display (see page 12).
    - AF OFF: Alternative Reception is deactivated.
  - 4 Press SEL (select) to finish the setting.

### Note:

*When Alternative Reception (for DAB services) is activated, Network-Tracking Reception (for RDS stations: see page 12) is also activated automatically. On the other hand, Network-Tracking Reception cannot be deactivated without deactivating Alternative Reception.*

## To adjust the DAB volume level

You can adjust the volume level of DAB tuner and store it in memory. By adjusting the volume level properly to match it to the FM sound level, you will not need to adjust the volume level each time you change the source.

When shipped from the factory, DAB volume level is set at “00.”

- See also “Changing the general settings (PSM)” on page 25.
- 1 Press and hold SEL (select) for more than 2 seconds so that one of the PSM items appears on the display.
  - 2 Press ►►| ^ or |◄◄ ▼ to select “DAB VOL” (DAB volume).
  - 3 Turn the control dial to set to the desired volume.  
You can set it from “VOL -12” to “VOL 12.”
  - 4 Press SEL (select) to finish the setting.



# TROUBLESHOOTING

What appears to be trouble is not always serious. Check the following points before calling a service center.

	Symptoms	Causes	Remedies
General	<ul style="list-style-type: none"> <li>• Sound cannot be heard from the speakers.</li> </ul>	<p>The volume level is set to the minimum level.</p> <p>Connections are incorrect.</p>	<p>Adjust it to the optimum level.</p> <p>Check the cords and connections.</p>
	<ul style="list-style-type: none"> <li>• This unit does not work at all.</li> </ul>	<p>The built-in microcomputer may have functioned incorrectly due to noise, etc.</p>	<p>Press the reset button on the panel holder after detaching the control panel. (The clock setting and preset stations stored in memory are erased.) (See page 2.)</p>
FM/AM	<ul style="list-style-type: none"> <li>• SSM (Strong-station Sequential Memory) automatic preset does not work.</li> </ul>	<p>Signals are too weak.</p>	<p>Store stations manually.</p>
	<ul style="list-style-type: none"> <li>• Static noise while listening to the radio.</li> </ul>	<p>The aerial is not connected firmly.</p>	<p>Connect the aerial firmly.</p>
Tape Playback	<ul style="list-style-type: none"> <li>• A cassette tape cannot be ejected.</li> </ul>	<p>Cassette is locked.</p>	<p>Unlock the cassette. (See page 22.)</p>
	<ul style="list-style-type: none"> <li>• A cassette tape cannot be inserted.</li> </ul>	<p>You have tried to insert a cassette in the wrong way.</p>	<p>Insert the cassette with the exposed tape facing right.</p>
	<ul style="list-style-type: none"> <li>• Cassette tapes become hot.</li> </ul>	<p>This is not a malfunction.</p>	<p>_____</p>
	<ul style="list-style-type: none"> <li>• Tape sound is at very low level and sound quality is degraded.</li> </ul>	<p>The tape head is dirty.</p>	<p>Clean it with a head cleaning tape.</p>





Symptoms	Causes	Remedies
<ul style="list-style-type: none"> <li>• “NO DISC” appears on the display.</li> </ul>	No disc is in the magazine.	Insert discs into the magazine.
	Discs are inserted upside down.	Insert discs correctly.
	Discs are unplayable.	Insert playable discs.
<ul style="list-style-type: none"> <li>• “NO MAG” appears on the display.</li> </ul>	No magazine is loaded in the CD changer.	Insert the magazine.
<ul style="list-style-type: none"> <li>• “NO FILES” appears on the display.</li> </ul>	The current disc does not contain any MP3 files.	Insert a disc that contains MP3 files.
<ul style="list-style-type: none"> <li>• MP3 disc is skipped or cannot be played back.</li> </ul>	MP3 files do not have the extension code—mp3 in their file names.	Add the extension code —mp3 to their file names.
	MP3 files are not recorded in the format compliant with ISO 9660 Level 1, Level 2, or Joliet.	Change the disc. (Record MP3 files using a compliant application.)
<ul style="list-style-type: none"> <li>• Noise is generated while playing an MP3 disc.</li> </ul>	The file played back is not an MP3 file (although it has the extension code—mp3).	Skip to another file or change the disc. (Do not add the extension code—mp3 to non-MP3 files.)
<ul style="list-style-type: none"> <li>• A longer readout time is required for an MP3 disc (“CHECK” keeps flashing on the display).</li> </ul>	Readout time varies due to the complexity of the folder/file configuration.	Do not use too many hierarchies and folders. Also, do not record any other types of audio tracks together with MP3 files.
<ul style="list-style-type: none"> <li>• MP3 files cannot be played back as you have intended them to play.</li> </ul>	Playback order is determined when the files are recorded.	_____
<ul style="list-style-type: none"> <li>• Elapsed playing time is not correct for an MP3 disc.</li> </ul>	This sometimes occurs during play. This is caused by how the files are recorded on the disc.	_____
<ul style="list-style-type: none"> <li>• “RESET 8” appears on the display.</li> </ul>	This unit is not connected to the CD changer correctly.	Connect this unit and the CD changer correctly and press the reset button of the CD changer.
<ul style="list-style-type: none"> <li>• “RESET 1” – “RESET 7” appears on the display.</li> </ul>	_____	Press the reset button of the CD changer.
<ul style="list-style-type: none"> <li>• The CD changer does not work at all.</li> </ul>	The built-in microcomputer may have function incorrectly due to noise, etc.	Press the reset button on the panel holder after detaching the control panel. (The clock setting and preset stations stored in memory are erased.) (See page 2.)



# MAINTENANCE

This unit requires very little attention, but you will be able to extend the life of the unit if you follow the instructions below.

## To clean the head

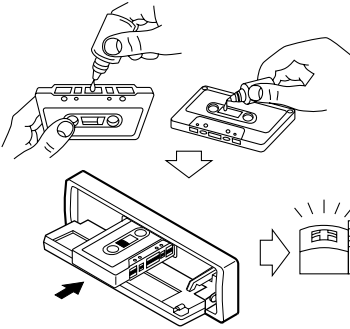

- Clean the heads after every 10 hours of use using a wet-type head cleaning tape (available at an audio store).  
When the head becomes dirty, you may realize the following symptoms:
  - Sound quality is reduced.
  - Sound level decreases.
  - Sound drops out.
- Do not play dirty or dusty tapes.
- Do not touch the highly-polished head with any metallic or magnetic tools.

## To keep the tape clean

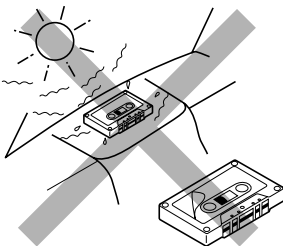

- Always store the cassettes in their storage cases after use.
- Do not store cassettes in the following places:
  - Subject to direct sunlight
  - With high humidity
  - At extremely hot temperatures

## CAUTION:

- Do not play the cassettes with peeling labels; otherwise, they can damage the unit.
- Tighten tapes to remove slack since loose tape may become entangled with the mechanism.
- Do not leave a cassette in the cassette compartment after use, as the tape may become slack.

The function below is also provided to ensure the longer life of this unit.

## Ignition key-off release/Ignition key-on play

- Turning off the ignition key with a cassette in the compartment automatically releases the tape from the unit's tapehead.
- Turning on the ignition key with a cassette in the compartment starts playback automatically if you turned off the ignition during tape play.

## **AUDIO AMPLIFIER SECTION**

Maximum Power Output:

Front: 50 W per channel

Rear: 50 W per channel

Continuous Power Output (RMS):

Front: 19 W per channel into 4  $\Omega$ , 40 Hz to 20 000 Hz at no more than 0.8% total harmonic distortion.

Rear: 19 W per channel into 4  $\Omega$ , 40 Hz to 20 000 Hz at no more than 0.8% total harmonic distortion.

Load Impedance: 4  $\Omega$  (4  $\Omega$  to 8  $\Omega$  allowance)

Tone Control Range:

Bass:  $\pm 10$  dB at 100 Hz

Treble:  $\pm 10$  dB at 10 kHz

Frequency Response: 40 Hz to 20 000 Hz

Signal-to-Noise Ratio: 70 dB

Line-Out Level/Impedance:

2.0 V/20 k $\Omega$  load (250 nWb/m)

Output Impedance: 1 k $\Omega$

## **TUNER SECTION**

Frequency Range:

FM1/FM2: 87.5 MHz to 108.0 MHz

FM3: 65.00 MHz to 74.00 MHz

AM: (MW) 522 kHz to 1 620 kHz

(LW) 144 kHz to 279 kHz

### **[FM Tuner]**

Usable Sensitivity:

11.3 dBf (1.0  $\mu$ V/75  $\Omega$ )

50 dB Quieting Sensitivity:

16.3 dBf (1.8  $\mu$ V/75  $\Omega$ )

Alternate Channel Selectivity (400 kHz):

65 dB

Frequency Response: 40 Hz to 15 000 Hz

Stereo Separation: 30 dB

Capture Ratio: 1.5 dB

### **[MW Tuner]**

Sensitivity: 20  $\mu$ V

Selectivity: 35 dB

### **[LW Tuner]**

Sensitivity: 50  $\mu$ V

## **CASSETTE DECK SECTION**

Wow & Flutter: 0.11% (WRMS)

Fast-Wind Time: 100 sec. (C-60)

Frequency Response (Dolby B NR OFF):

30 Hz to 16 000 Hz (Normal tape)

Signal-to-Noise Ratio: 56 dB (Normal tape)

(Dolby B NR ON): 65 dB

(Dolby B NR OFF): 56 dB

Stereo Separation: 40 dB

## **GENERAL**

Power Requirement:

Operating Voltage: DC 14.4 V

(11 V to 16 V allowance)

Grounding System: Negative ground

Allowable Operating Temperature: 0°C to +40°C

Dimensions (W  $\times$  H  $\times$  D):

Installation Size (approx.):

182 mm  $\times$  52 mm  $\times$  150 mm

Panel Size (approx.):

188 mm  $\times$  58 mm  $\times$  12 mm

Mass (approx.):

1.5 kg (excluding accessories)

*Design and specifications are subject to change without notice.*



**Having TROUBLE with operation?  
Please reset your unit**

Refer to page of How to reset your unit

**Затруднения при эксплуатации?  
Пожалуйста, перезагрузите Ваше  
устройство**

Для получения информации о перезагрузке Вашего устройства обратитесь на соответствующую страницу

**JVC**

VICTOR COMPANY OF JAPAN, LIMITED



EN, RU

© 2003 VICTOR COMPANY OF JAPAN, LIMITED



0403KKSMdTJEIN

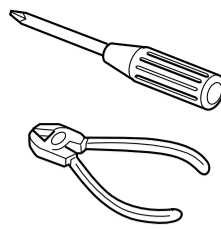

#### ENGLISH

- This unit is designed to operate on 12 V DC, NEGATIVE ground electrical systems.

## INSTALLATION (IN-DASH MOUNTING)

- The following illustration shows a typical installation. However, you should make adjustments corresponding to your specific car. If you have any questions or require information regarding installation kits, consult your JVC IN-CAR ENTERTAINMENT dealer or a company supplying kits.

**1 Before mounting:** Press (control panel release button) to detach the control panel if already attached.

\* When shipped from the factory, the control panel is packed in the hard case.

**2** Remove the trim plate.

**3** Remove the sleeve after disengaging the sleeve locks.

① Stand the unit.

**Note:** When you stand the unit, be careful not to damage the fuse on the rear.

② Insert the 2 handles between the unit and the sleeve, as illustrated, to disengage the sleeve locks.

③ Remove the sleeve.

**Note:** Be sure to keep the handles for future use after installing the unit.

**4** Install the sleeve into the dashboard.

\* After the sleeve is correctly installed into the dashboard, bend the appropriate tabs to hold the sleeve firmly in place, as illustrated.

**5** Fix the mounting bolt to the rear of the unit's body and place the rubber cushion over the end of the bolt.

**6** Do the required electrical connections.

**7** Slide the unit into the sleeve until it is locked.

**8** Attach the trim plate.

**Note:** Ensure the recessed part is at the bottom. If not, the control panel will not open completely.

**9** Attach the control panel.

#### РУССКИЙ

- Это устройство разработано для эксплуатации на 12 В постоянного напряжения с минусом на массу.

## УСТАНОВКА (УСТАНОВКА В ПРИБОРНУЮ ПАНЕЛЬ)

- На следующих иллюстрациях показана типовая установка. Тем не менее, Вы должны сделать поправки в соответствии с типом Вашего автомобиля. Если у Вас есть какие-либо вопросы, касающиеся установки, обратитесь к Вашему дилеру JVC IN-CAR ENTERTAINMENT или в компанию, поставляющую соответствующие принадлежности.

**1 Перед установкой:** Нажмите кнопку (кнопка освобождения панели управления) для отсоединения панели управления, если она уже прикреплена.

\* При отправке с завода панель управления упакована в твердую коробку.

**2** Удалите декоративную панель.

**3** Удалите муфту после освобождения запоров муфты.

① Установите устройство.

**Примечание:** Устанавливайте устройство таким образом, чтобы не повредить предохранитель, расположенный сзади.

② Вставьте два рычага между устройством и муфтой, как показано на рисунке, для освобождения запоров муфты.

③ Удалите муфту.

**Примечание:** После установки устройства сохраните рычаги для использования в будущем.

**4** Установите муфту в приборную панель.

\* После установки муфты в приборную панель согните соответствующие зубцы для фиксации муфты, как показано на рисунке.

**5** Затяните Крепежный болт на задней части корпуса устройства и наденьте резиновый чехол на конец болта.

**6** Выполните необходимые подключения контактов, как показано на обратной стороне этой инструкции.

**7** Задвиньте устройство в муфту до упора.

**8** Установите декоративную панель.

**Примечание:** Обеспечьте, чтобы часть с выемкой была внизу. Если это не так, то панель управления полностью не откроется.

**9** Прикрепите панель управления.

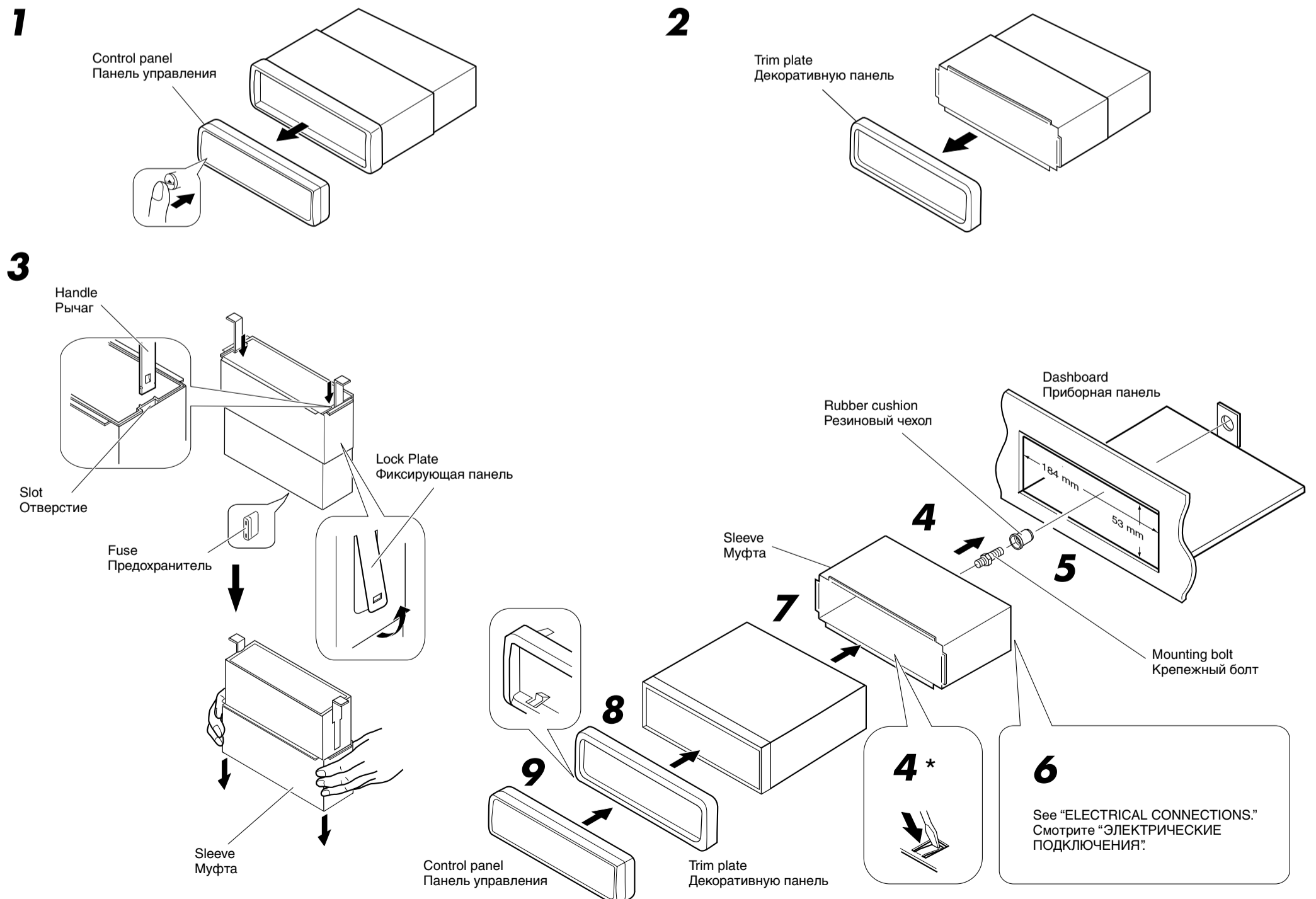

- **When using the optional stay**
- **При использовании дополнительной стойки**

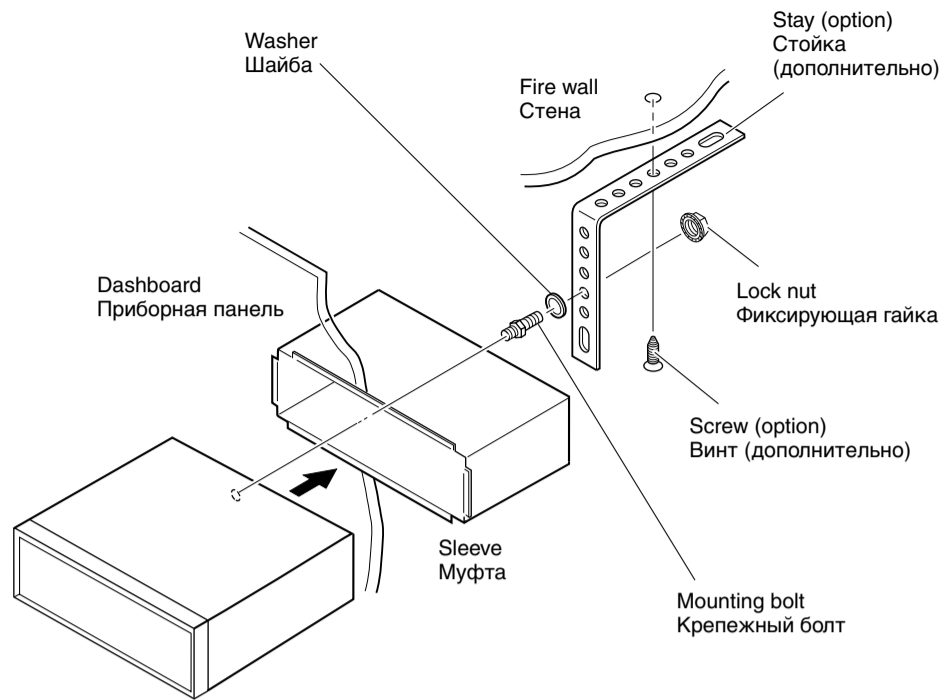

Less than 30°  
Менее 30°

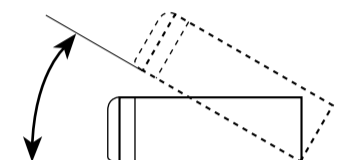

Install the unit at an angle of less than 30°.  
Установите устройство под углом менее 30°.

- **When installing the unit without using the sleeve**
- **При установке устройства без использования муфты**

In a Toyota for example, first remove the car radio and install the unit in its place.  
В автомобилях "Toyota", например, сначала удалите автомобильную магнитола, затем установите на ее место это устройство.

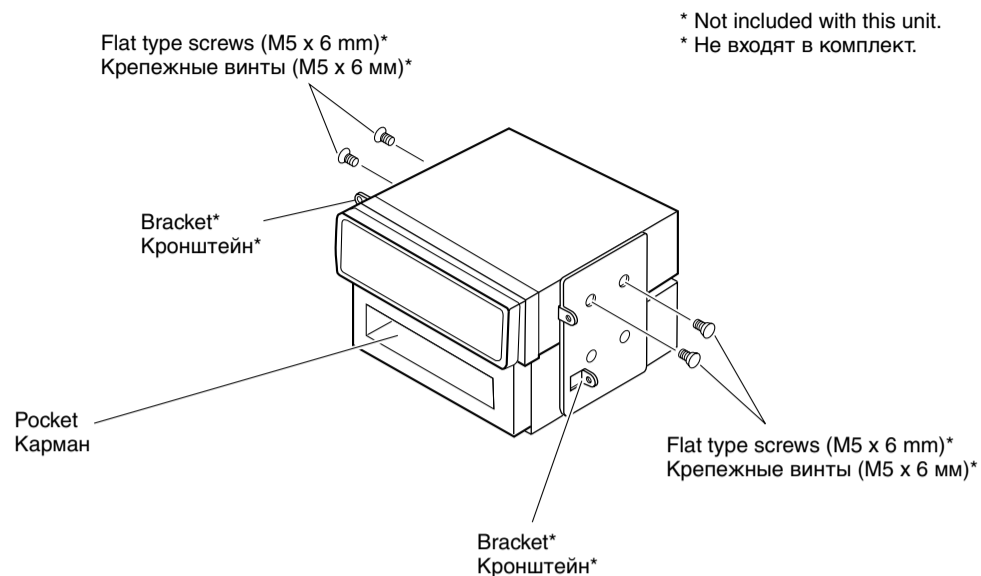

\* Not included with this unit.  
\* Не входят в комплект.

**Note** : When installing the unit on the mounting bracket, make sure to use the 6 mm-long screws. If longer screws are used, they could damage the unit.  
**Примечание** : При установке устройства на крепежный кронштейн, используйте только винты длиной 6 мм. При использовании более длинных винтов можно повредить устройство.

### Removing the unit

- Before removing the unit, release the rear section.
- 1** Remove the control panel.
- 2** Remove the trim plate.
- 3** Insert the 2 handles into the slots, as shown. Then, while gently pulling the handles away from each other, slide out the unit. (**Be sure to keep the handles after installing it.**)

### Удаление устройства

- Перед удалением устройства освободите заднюю часть.
- 1** Удалите панель управления.
- 2** Удалите декоративную панель.
- 3** Вставьте 2 рычага в отверстия, как показано на иллюстрации. Затем, плавно раздвигая рычаги в стороны, выньте устройство. (**После установки сохраните рычаги.**)

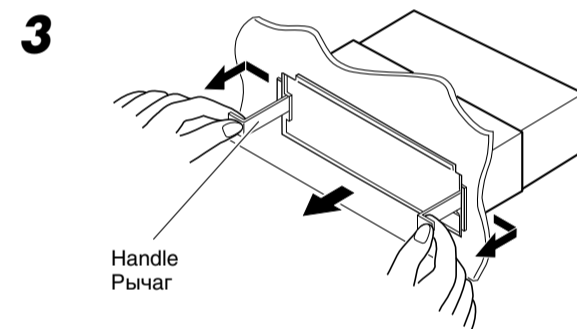
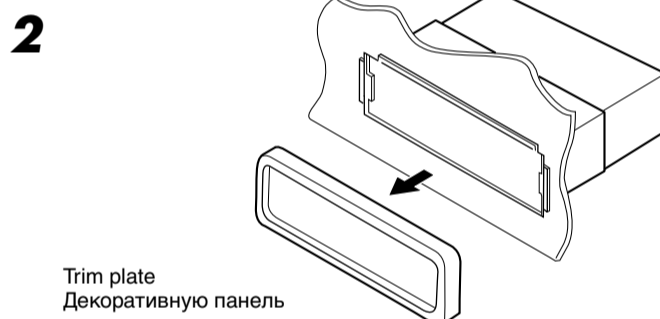
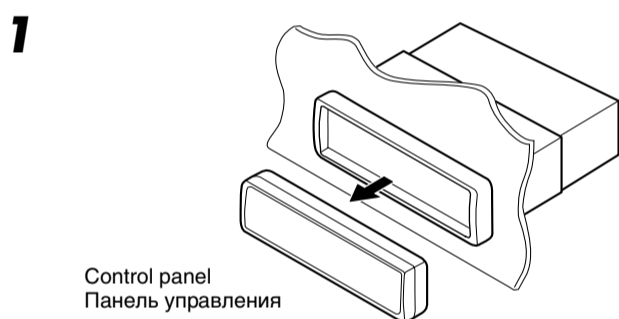

### Parts list for installation and connection

The following parts are provided with this unit.  
After checking them, please set them correctly.

### Список деталей для установки и подключения

Следующие детали поставлены в комплекте с устройством.  
После проверки комплектации, пожалуйста, установите их правильно.

Hard case/Control panel  
Жесткий футляр/панель управления

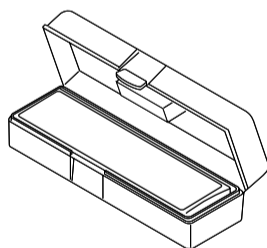

Sleeve  
Муфта

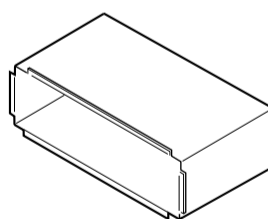

Trim plate  
Декоративную панель

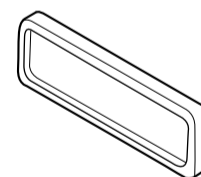

Power cord  
Кабель питания

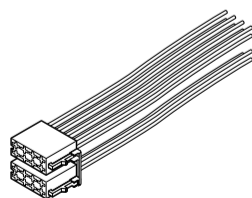

Handles  
Рычаги

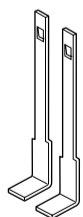

Washer (ø5)  
Шайба (ø5)



Lock nut (M5)  
Фиксирующая гайка (M5)



Mounting bolt (M5 x 20 mm)  
Крепежный болт (M5 x 20 мм)



Rubber cushion  
Резиновый чехол



Battery  
Батарейка



Remote controller  
Устройство дистанционного управления

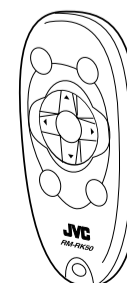

# ELECTRICAL CONNECTIONS

To prevent short circuits, we recommend that you disconnect the battery's negative terminal and make all electrical connections before installing the unit. If you are not sure how to install this unit correctly, have it installed by a qualified technician.

**Note:** This unit is designed to operate on **12 V DC, NEGATIVE ground electrical systems**. If your vehicle does not have this system, a voltage inverter is required, which can be purchased at JVC IN-CAR ENTERTAINMENT dealers.

- Replace the fuse with one of the specified rating. If the fuse blows frequently, consult your JVC IN-CAR ENTERTAINMENT dealer.
- If noise is a problem...  
This unit incorporates a noise filter in the power circuit. However, with some vehicles, clicking or other unwanted noise may occur. If this happens, connect the unit's **rear ground terminal** (see connection diagram) to the car's chassis using shorter and thicker cords, such as copper braiding or gauge wire. If noise still persists, consult your JVC IN-CAR ENTERTAINMENT dealer.
- Maximum input of the speakers should be more than 50 W at the rear and 50 W at the front, with an impedance of **4 Ω to 8 Ω**.
- **Be sure to ground this unit to the car's chassis.**
- The heat sink becomes very hot after use. Be careful not to touch it when removing this unit.

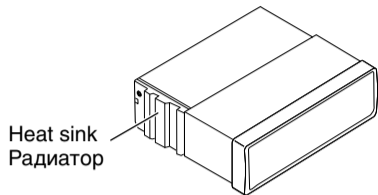

## Typical Connections / Типичные подключения

**Before connecting:** Check the wiring in the vehicle carefully. Incorrect connection may cause serious damage to this unit.

The leads of the power cord and those of the connector from the car body may be different in color.

**1** Connect the colored leads of the power cord to the car battery, speakers and power aerial (if any) in the following sequence.

- ① Black: ground
- ② Yellow: to car battery (constant 12 V)
- ③ Red: to an accessory terminal
- ④ Blue with white stripe: to remote lead of other equipment or power aerial if any (200 mA max.)
- ⑤ Orange with white stripe: to car light control switch
- ⑥ Brown: to cellular phone system (For details, refer to the instructions of the cellular phone.)
- ⑦ Others: to speakers

**2** Connect the aerial cord.

**3** Finally connect the wiring harness to the unit.

**Note:** If your vehicle does not have any accessory terminal, move the fuse from the fuse position 1 (initial position) to fuse position 2, and connect the red lead (A7) to the positive (+) battery terminal.

- The yellow lead (A4) is not used in this case.

# ЭЛЕКТРИЧЕСКИЕ ПОДКЛЮЧЕНИЯ

Для предотвращения коротких замыканий мы рекомендуем Вам отсоединить отрицательный разъем аккумулятора и осуществить все подключения перед установкой устройства. Если Вы не знаете точно, как следует устанавливать это устройство, обратитесь к квалифицированному специалисту.

**Примечание:**

Это устройство разработано для эксплуатации на **12 В постоянного напряжения с минусом на массе**. Если Ваш автомобиль не имеет этой системы, требуется инвертор напряжения, который может быть приобретен у дилера JVC IN-CAR ENTERTAINMENT.

- Заменяйте предохранитель другим предохранителем указанного класса. Если предохранитель сгорает слишком часто, обратитесь к дилеру JVC IN-CAR ENTERTAINMENT.
- При появлении сильных помех...

Это устройство оснащено фильтром помех в цепи питания. Однако в некоторых случаях возможно появление щелчков и других нежелательных помех. В этом случае подключите **задний разъем заземления** этого устройства (см. схему подключения ниже) к шасси автомобиля при помощи более коротких и толстых проводов. Если помехи не исчезают, обратитесь к дилеру JVC IN-CAR ENTERTAINMENT.

- Максимальная входная мощность громкоговорителей должна быть больше 50 Вт сзади и 50 Вт впереди при полном сопротивлении от **4 Ω до 8 Ω**.
- **Не забудьте заземлить устройство на шасси автомобиля.**
- Радиатор во время использования сильно нагревается. Старайтесь его не трогать во время удаления устройства.

**Перед началом подключений:** Тщательно проверьте проводку в автомобиле. Неправильное подключение может привести к серьезному повреждению устройства.

Жилы силового кабеля и жилы соединителя от кузова автомобиля могут быть разного цвета.

**1** Подключите цветные провода кабеля питания к аккумулятору, громкоговорителям и автономной антенне (если есть) в следующем порядке:

- ① Черный: земля
- ② Желтый: к аккумулятору (постоянный 12 В)
- ③ Красный: к вспомогательному разъему
- ④ Синий с белой полосой: к удаленному проводу другого оборудования или антенны (макс. 200 мА).
- ⑤ Оранжевый с белой полосой: к управляющему переключателю фонаря автомобиля
- ⑥ Коричневый: к системе сотового телефона (Детали смотрите в инструкции сотового телефона.)
- ⑦ Другие: к громкоговорителям

**2** Подключите кабель антенны.

**3** В последнюю очередь подключите электропроводку к устройству.

**Примечание:** Если в Вашем автомобиле никакого вспомогательного разъема не имеется, переставьте предохранитель из положения 1 предохранителя (первоначальное положение) в положение 2 предохранителя и подключите красный провод (A7) к положительному (+) полюсу аккумулятора.

- Желтый провод (A4) в этом случае не используется.

JVC CD changer/DAB tuner or another external component  
Проигрыватель-автомат компакт-дисков JVC/Тюнер DAB или другой внешний компонент

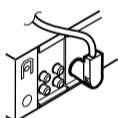

We recommend you to connect the JVC MP3-compatible CD changer. You can also connect other CH-X series CD changers (except CH-X99 and CH-X100).

- You cannot use the KD-MK series CD changers with this unit.
- You can also use an external component such as a portable MD player by connecting the Line Input Adapter KS-U57 (not supplied). (See diagram B.)
- Рекомендуем подключать совместимое с MP3 устройство автоматической смены компакт-дисков компании JVC. Кроме того, можно подключать одно из устройств автоматической смены компакт-дисков серии CH-X (кроме CH-X99 и CH-X100).
- С данным устройством нельзя использовать устройства автоматической смены компакт-дисков серии KD-MK.
- Вы можете также использовать внешний компонент, такой как портативный проигрыватель минидисков, подсоединив адаптер входной линии KS-U57 (не поставляется). (См. схему B.)

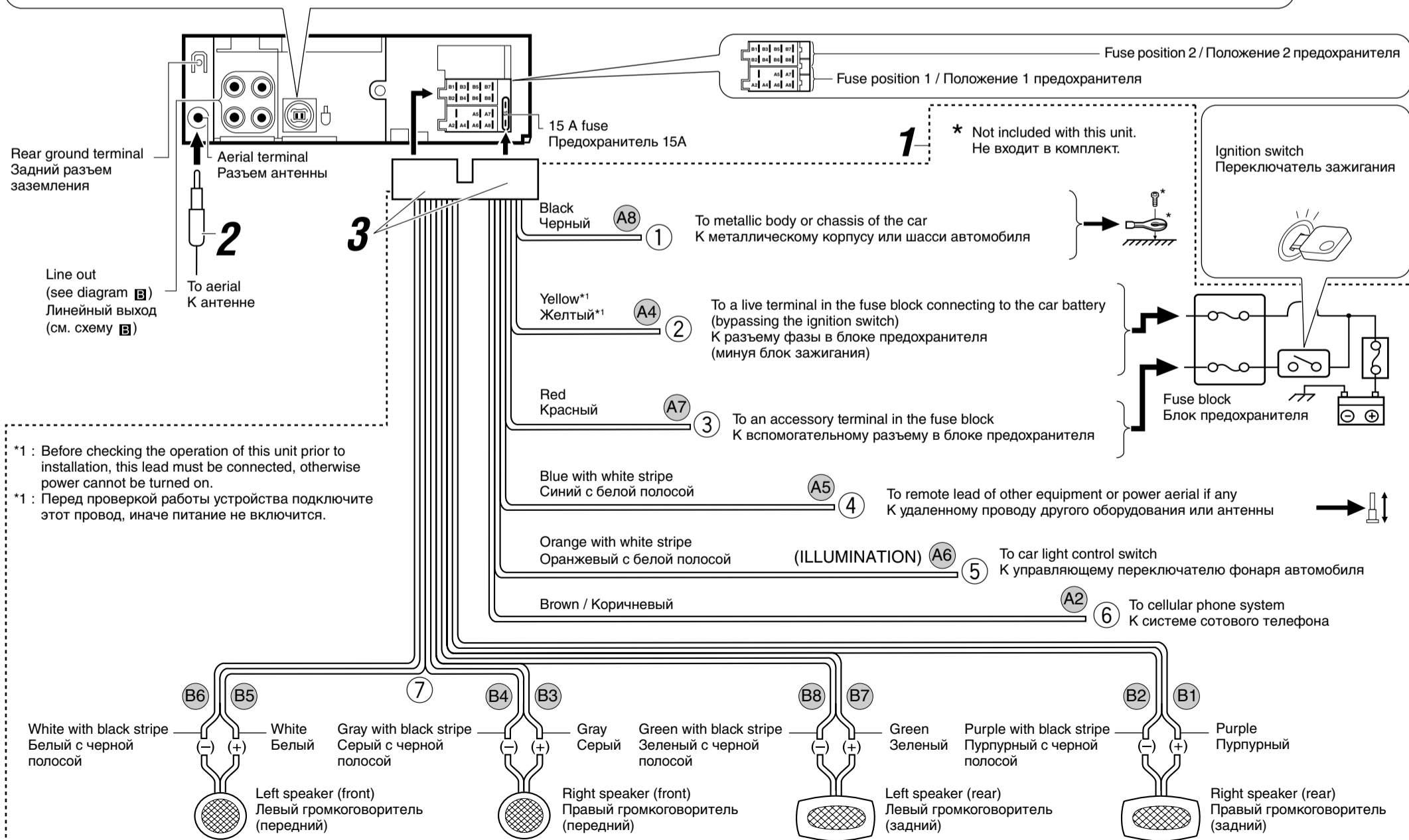

\*1 : Before checking the operation of this unit prior to installation, this lead must be connected, otherwise power cannot be turned on.  
\*1 : Перед проверкой работы устройства подключите этот провод, иначе питание не включится.

## PRECAUTIONS on power supply and speaker connections:

- **DO NOT** connect the speaker leads of the power cord to the car battery; otherwise, the unit will be seriously damaged.
- Connect the black lead (ground), yellow lead (to car battery, constant 12 V), and red lead (to an accessory terminal) correctly.
- **BEFORE** connecting the speaker leads of the power cord to the speakers, check the speaker wiring in your car.
  - If the speaker wiring in your car is as illustrated in Fig. 1 and Fig. 2 below, **DO NOT** connect the unit using that original speaker wiring. If you do, the unit will be seriously damaged. Redo the speaker wiring so that you can connect the unit to the speakers as illustrated in Fig. 3.
  - If the speaker wiring in your car is as illustrated in Fig. 3, you can connect the unit using the original speaker wiring in your car.
  - If you are not sure of the speaker wiring of your car, consult your car dealer.

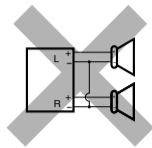

Fig. 1

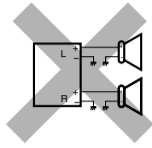

Fig. 2



Fig. 3

## ПРЕДОСТЕРЕЖЕНИЯ по питанию и подключению громкоговорителей:

- **НЕ** подключайте провода громкоговорителей к аккумулятору автомобиля, иначе устройство будет повреждено.
- Правильно подключите черный провод (земля), желтый провод (в аккумулятор, постоянный ток 12 В) и красный провод (в вспомогательный разъем).
- **ПЕРЕД** подключением проводов громкоговорителей к кабелю питания громкоговорителя проверьте схему соединений громкоговорителей в Вашем автомобиле.
  - Если проводка громкоговорителей в Вашем автомобиле такая, как показано на приводимых ниже Fig. 1 и Fig. 2, **НЕ** подключайте устройство с помощью первоначальной проводки громкоговорителей. Если Вы это сделаете, устройство будет серьезно повреждено. Переделайте проводку громкоговорителей так, чтобы Вы могли подключить устройство к громкоговорителям, как это показано на Fig. 3.
  - Если проводка громкоговорителей в Вашем автомобиле такая, как показано на Fig. 3, Вы можете подключить устройство с помощью первоначальной проводки громкоговорителей в Вашем автомобиле.
  - Если Вы не знаете соединения громкоговорителей в Вашем автомобиле, обратитесь к Вашему автомобильному дилеру.

## Connecting the leads / Подключение контактов

Twist the core wires when connecting.  
Закрутите концы проводов при соединении.

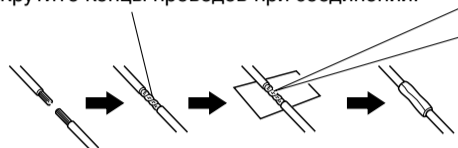

Solder the core wires to connect them securely.  
Спаяйте провода для надежного соединения.



## CAUTION / ПРЕДОСТЕРЕЖЕНИЕ:

- To prevent short-circuit, cover the terminals of the UNUSED leads with insulating tape.
- Для предотвращения короткого замыкания заклейте НЕИСПОЛЬЗУЕМЫЕ концы изолирующей лентой.

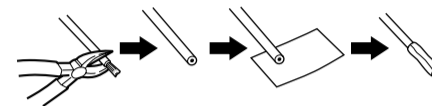

## Connections Adding Other Equipment / Подключение других устройств

You can connect an amplifier to upgrade your car stereo system.

- Connect the remote lead (blue with white stripe) to the remote lead of the other equipment so that it can be controlled through this unit.
- For amplifier only:
  - Connect this unit's line-out terminals to the amplifier's line-in terminals.
  - **Disconnect the speakers from this unit, connect them to the amplifier. Leave the speaker leads of this unit unused.** (Cover the terminals of these unused leads with insulating tape, as illustrated above.)

Для обновления автомобильной стереосистемы Вы можете подключить усилитель.

- Подсоедините провод внешнего устройства (синий с белой полосой) к проводу внешнего устройства другого оборудования так, чтобы им можно было управлять с этого устройства.
- Только для усилителя:
  - Подключите выходные клеммы данного устройства к входным клеммам усилителя.
  - **Отсоедините громкоговорители от данного устройства, подключите их к усилителю. Оставьте провода громкоговорителей данного устройства неиспользованными.** (Замотайте клеммы этих неиспользованных проводов изоляционной лентой, как показано выше.)

## Amplifier / Усилитель

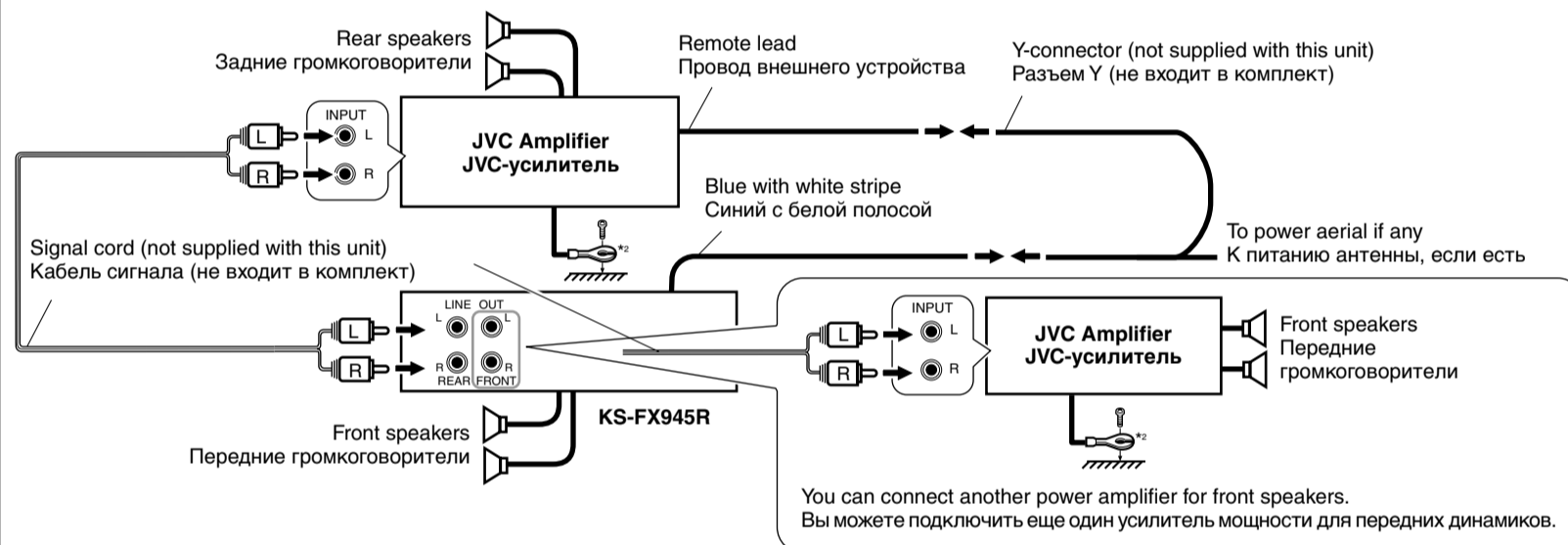

\*2 : Firmly attach the ground wire to the metallic body or to the chassis of the car—to the place not coated with paint (if coated with paint, remove the paint before attaching the wire). Failure to do so may cause damage to the unit.

\*2 : Плотно прикрепите заземляющий провод к металлическому кузову или шасси автомобиля—в месте, не покрытом краской (если оно покрыто краской, удалите краску перед тем, как прикреплять провод). Невыполнение этого требования может привести к повреждению данного устройства.

## CD Changer and DAB Tuner / Проигрыватель-автомат компакт-дисков и тюнер DAB

You can connect a JVC CD changer and/or a JVC DAB (Digital Audio Broadcasting) tuner.

- For their connections, refer to the Instructions supplied with them.

Connecting cord supplied with your DAB tuner  
Соединительный шнур входит в комплект поставки приобретенного Вами тюнера DAB

Connecting cord supplied with your CD changer  
Соединительный кабель, поставляемый с Вашим проигрывателем-автоматом компакт-дисков

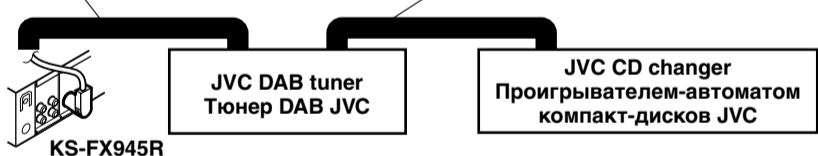

- You can connect both components in series as illustrated above.
- Вы можете подключить оба компонента параллельно, как проиллюстрировано выше.

Вы можете подключить проигрыватель-автомат компакт-дисков JVC и/или тюнер DAB (цифровое радиовещание) JVC.

- Порядок их подключения смотрите в прилагаемых к ним инструкциях.

Connecting cord supplied with your DAB tuner or CD changer  
Соединительный кабель, поставляемый с Вашим тюнером DAB или проигрывателем-автоматом компакт-дисков

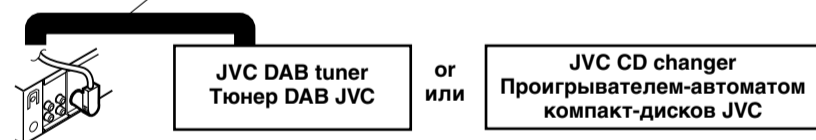

## CAUTION / ПРЕДУПРЕЖДЕНИЕ:

- Before connecting the CD changer and/or the DAB tuner, make sure that the unit is turned off.
- Перед подключением проигрывателя-автомата компакт-дисков и/или тюнера DAB убедитесь, что данное устройство выключено.

## External Component / Внешний компонент

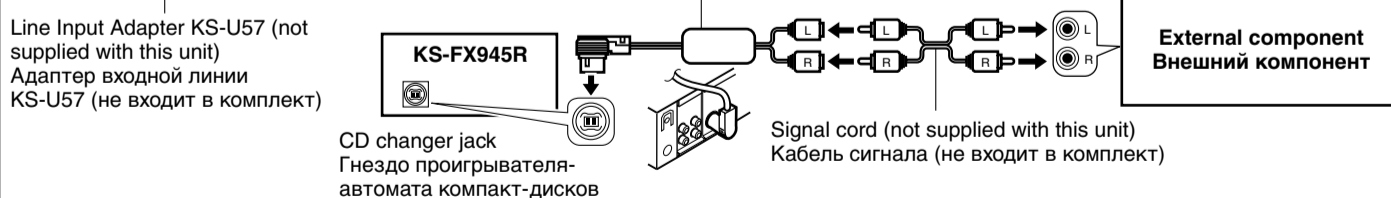

See the INSTRUCTIONS (separate volume) for how to use the external component with this unit.  
Для получения информации об использовании внешнего устройства см. ИНСТРУКЦИИ ПО ЭКСПЛУАТАЦИИ (в отдельном издании).

## TROUBLESHOOTING

- **The fuse blows.**
  - \* Are the red and black leads connected correctly?
- **Power cannot be turned on.**
  - \* Is the yellow lead connected?
- **No sound from the speakers.**
  - \* Is the speaker output lead short-circuited?
- **Sound is distorted.**
  - \* Is the speaker output lead grounded?
  - \* Are the “-” terminals of L and R speakers grounded in common?
- **Unit becomes hot.**
  - \* Is the speaker output lead grounded?
  - \* Are the “-” terminals of L and R speakers grounded in common?

## ВЫЯВЛЕНИЕ НЕИСПРАВНОСТЕЙ

- **Сработал предохранитель.**
  - \* Правильно ли подключены черный и красный провода?
- **Питание не включается.**
  - \* Подключен ли желтый провод?
- **Звук не выводится через громкоговорители.**
  - \* Нет ли короткого замыкания на кабеле выхода громкоговорителей?
- **Звук искажен.**
  - \* Заземлен ли провод выхода громкоговорителей?
  - \* Заземлены ли разъемы “-” правого (R) и левого (L) громкоговорителей?
- **Устройство нагревается.**
  - \* Заземлен ли провод выхода громкоговорителей?
  - \* Заземлены ли разъемы “-” правого (R) и левого (L) громкоговорителей?



## Free Manuals Download Website

<http://myh66.com>

<http://usermanuals.us>

<http://www.somanuals.com>

<http://www.4manuals.cc>

<http://www.manual-lib.com>

<http://www.404manual.com>

<http://www.luxmanual.com>

<http://aubethermostatmanual.com>

Golf course search by state

<http://golfingnear.com>

Email search by domain

<http://emailbydomain.com>

Auto manuals search

<http://auto.somanuals.com>

TV manuals search

<http://tv.somanuals.com>