

JVC



ENGLISH

РУССКИЙ

CD RECEIVER РЕСИВЕР С ПРОИГРЫВАТЕЛЕМ КОМПАКТ-ДИСКОВ

KD-S847

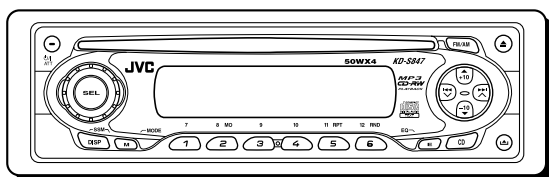
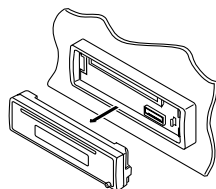

**MP3
CD-RW
PLAYBACK**

For installation and connections, refer to the separate manual.

Указания по установке и выполнению соединений приводятся в отдельной инструкции.

В соответствии с Законом Российской Федерации “О защите прав потребителей” срок службы (годности) данного товара “по истечении которого он может представлять опасность для жизни, здоровья потребителя, причинять вред его имуществу или окружающей среде” составляет семь (7) лет со дня производства. Этот срок является временем, в течение которого потребитель данного товара может безопасно им пользоваться при условии соблюдения инструкции по эксплуатации данного товара, проводя необходимое обслуживание, включающее замену расходных материалов и/или соответствующее ремонтное обеспечение в специализированном сервисном центре.

Дополнительные косметические материалы к данному товару, поставляемые вместе с ним, могут храниться в течение двух (2) лет со дня его производства.

Срок службы (годности), кроме срока хранения дополнительных косметических материалов, упомянутых в предыдущих двух пунктах, не затрагивает никаких других прав потребителя, в частности, гарантийного свидетельства JVC, которое он может получить в соответствии с законом о правах потребителя или других законов, связанных с ним.

INSTRUCTIONS ИНСТРУКЦИИ ПО ЭКСПЛУАТАЦИИ



GET0137-001A
[EE]

Position And Reproduction Of Labels

Bottom panel of the main unit

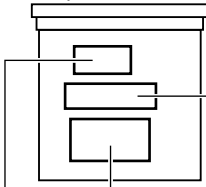

Name/Rating plate



CAUTION: Invisible laser radiation when open and interlock failed or defeated. AVOID DIRECT EXPOSURE TO BEAM. (e)	ADVARSEL: Usynlig laserstråling ved åbning, når sikkerhedsafbrydere er ude af funktion. Undgåudsætelse for stråling. (d)	VARNING: Osynlig laserstråling når denna del är öppnad och spärren är urkopplad. Betrakta ej strålen. (s)	VARO: Avattaessa ja suojalukitus ohitettaessa olet alttiina näkymättömälle lasersäteilylle. Älä katso säteeseen. (f)
--	---	--	---

IMPORTANT FOR LASER PRODUCTS

Precautions:

1. CLASS 1 LASER PRODUCT
2. **CAUTION:** Invisible laser radiation when open and interlock failed or defeated. Avoid direct exposure to beam.
3. **CAUTION:** Do not open the top cover. There are no user-serviceable parts inside. Leave all servicing to qualified service personnel.
4. **CAUTION:** This CD player uses invisible laser radiation and is equipped with safety switches to prevent radiation emission when unloading CDs. It is dangerous to defeat the safety switches.
5. **CAUTION:** Use of controls, adjustments or performance of procedures other than those specified herein may result in hazardous radiation exposure.

Caution:

This product contains a laser component of higher laser class than Class 1.

How to reset your unit

While holding SEL (select), press ϕ /I/ATT (standby/on/attenuator) for more than 2 seconds. This will reset the built-in microcomputer.

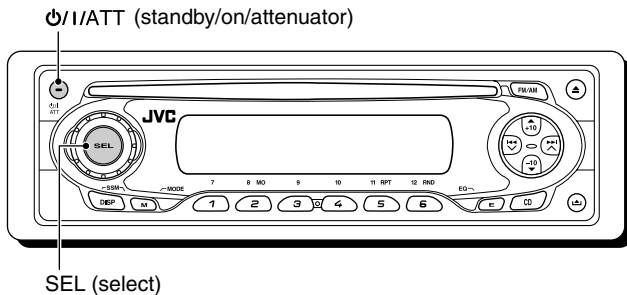

Notes:

- Your preset adjustments—such as preset channels or sound adjustments—will also be erased.
- If a disc is in the unit, it will eject when you reset the unit. Be careful not to drop the disc.

BEFORE USE

*For safety...

- Do not raise the volume level too much, as this will block outside sounds, making driving dangerous.
- Stop the car before performing any complicated operations.

*Temperature inside the car...

If you have parked the car for a long time in hot or cold weather, wait until the temperature in the car becomes normal before operating the unit.

Thank you for purchasing a JVC product. Please read all instructions carefully before operation, to ensure your complete understanding and to obtain the best possible performance from the unit.

CONTENTS

How to reset your unit	2	MP3 OPERATIONS	16
How to use the M (MODE) button	3	Playing an MP3 disc	16
LOCATION OF THE BUTTONS	4	Locating a file or a particular portion on an MP3 disc	18
Control panel	4	Selecting MP3 playback modes	20
BASIC OPERATIONS	5	SOUND ADJUSTMENTS	21
Turning on the power	5	Selecting preset sound modes (C-EQ: custom equalizer)	21
Setting the clock	6	Adjusting the sound	22
RADIO OPERATIONS	7	OTHER MAIN FUNCTIONS	23
Listening to the radio	7	Changing the general settings (PSM)	23
Storing stations in memory	8	Detaching the control panel	25
Tuning in to a preset station	9	TROUBLESHOOTING	26
CD OPERATIONS	10	MAINTENANCE	28
Playing a CD	10	Handling discs	28
Locating a track or a particular portion on a CD	11	SPECIFICATIONS	29
Selecting CD playback modes	12		
Playing a CD Text	13		
Prohibiting disc ejection	13		
MP3 INTRODUCTION	14		
What is MP3?	14		
How are MP3 files recorded and played back?	14		

How to use the M (MODE) button

If you press M (MODE), the unit goes into functions mode, then the number buttons and ▲/▼ buttons work as different function buttons.

Ex.: When number button 2 works as MO (monaural) button.

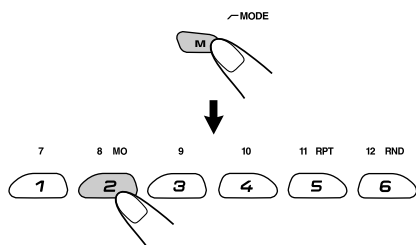

To use these buttons for original functions again after pressing M (MODE), wait for 5 seconds without pressing any of these buttons until the functions mode is cleared.

- Pressing M (MODE) again also clears the functions mode.



LOCATION OF THE BUTTONS

Control panel

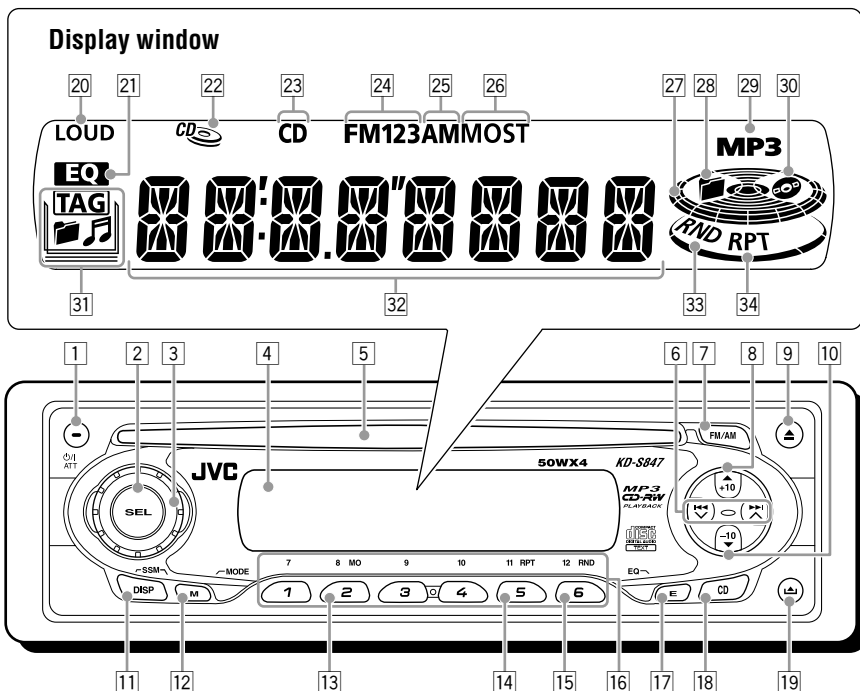

- 1 Φ /I/ATT (standby/on/attenuator) button
- 2 SEL (select) button
- 3 Control dial
- 4 Display window
- 5 Loading slot
- 6 \ll ∇ \triangleright \gg buttons
- 7 FM/AM button
- 8 \blacktriangle (up) button
+10 button
- 9 \blacktriangle (eject) button
- 10 \blacktriangledown (down) button
-10 button
- 11 DISP (display) button
 - Also functions as SSM buttons when pressed together with M (MODE) button.
- 12 M (MODE) button
 - Also functions as SSM buttons when pressed together with DISP (display) button.
- 13 MO (monaural) button
- 14 RPT (repeat) button
- 15 RND (random) button
- 16 Number buttons

- 17 E (EQ: equalizer) button
- 18 CD button
- 19 \blacktriangle (control panel release) button

Display window

- 20 LOUD (loudness) indicator
- 21 EQ (equalizer) indicator
- 22 CD-in indicator
- 23 CD indicator
- 24 FM band indicators (FM1, FM2, FM3)
- 25 AM band indicator
- 26 Tuner reception indicators
MO (monaural), ST (stereo)
- 27 Volume (or audio) level indicator
- 28 ∇ (folder) indicator
- 29 MP3 indicator
- 30 CD (disc) indicator
- 31 Disc information indicators
TAG (ID3 tag), ∇ (folder), M (track/file)
- 32 Main display
- 33 RND (random) indicator
- 34 RPT (repeat) indicator

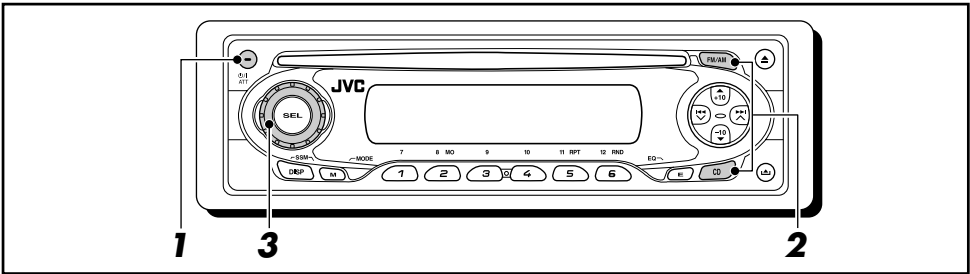

Turning on the power

1 Turn on the power.



Note on One-Touch Operation:

When you select a source in step 2 below, the power automatically comes on. You do not have to press this button to turn on the power.

2 Select the source.

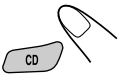

To operate the tuner (FM or AM), see pages 7 – 9.

To play a CD, see pages 10 – 13.

To play an MP3 disc, see pages 16 – 20.

3 Adjust the volume.

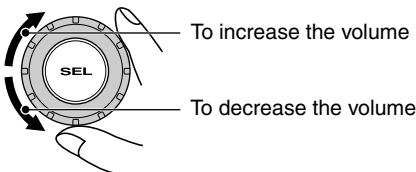

Volume (or audio) level indicator (see page 24)



Volume level appears.

4 Adjust the sound as you want. (See pages 21 and 22.)

To drop the volume in a moment

Press ϕ /I/ATT briefly while listening to any source. “ATT” starts flashing on the display, and the volume level will drop in a moment.

To resume the previous volume level, press the button briefly again.

- If you turn the control dial, you can also restore the sound.

To turn off the power

Press and hold ϕ /I/ATT for more than one second.

“SEE YOU” appears, then the unit turns off.

- **If you turn off the power while listening to a disc**, disc play will start from where playback has been stopped previously, next time you turn on the power.

CAUTION on Volume Setting:

Discs produce very little noise compared with other sources. If the volume level is adjusted for the tuner, for example, the speakers may be damaged by the sudden increase in the output level. Therefore, lower the volume before playing a disc and adjust it as required during playback.

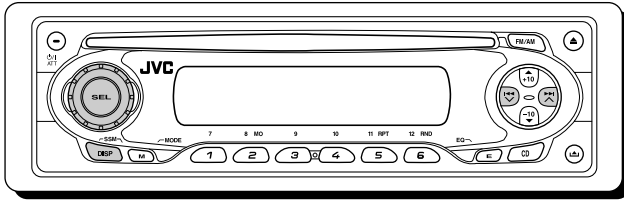

Setting the clock

- 1** Press and hold SEL (select) for more than 2 seconds so that one of the PSM items appears on the display. (PSM: see page 23.)



- 2** Set the hour.

- 1 Select "CLOCK H" (hour) if not shown on the display.
- 2 Adjust the hour.

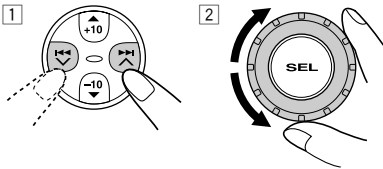

- 3** Set the minute.

- 1 Select "CLOCK M" (minute).
- 2 Adjust the minute.

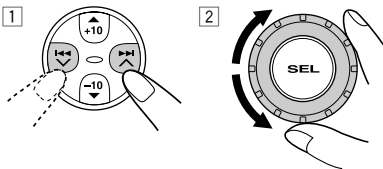

- 4** Finish the setting.



To check the current clock time or change the display mode

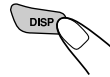

Press DISP (display) repeatedly. Each time you press the button, the display changes as follows:

- During tuner operation:

Frequency ↔ Clock

- During disc operation:

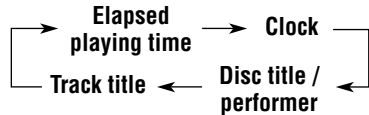

Notes:

- While playing a conventional CD, "NO NAME" appears for the disc title/performer and the track title.
- For indication change while playing a CD Text or an MP3 disc, see pages 13 and 17.
- During power off:
 - The power turns on and the clock time is shown for 5 seconds, then the power turns off.

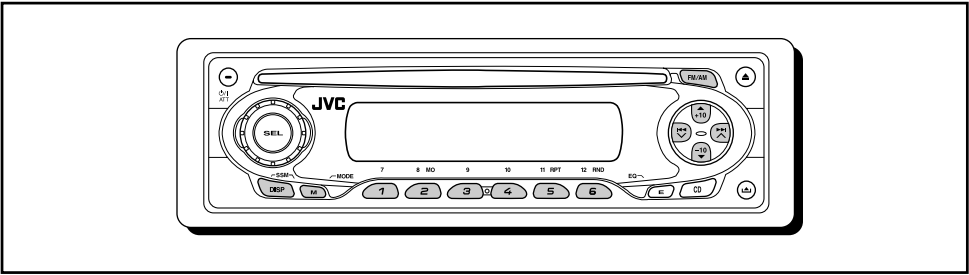

Listening to the radio

You can use either automatic searching or manual searching to tune in to a particular station.

Searching a station automatically: Auto search

1 Select the band (FM 1 – 3, AM).



Each time you press the button, the band changes as follows:

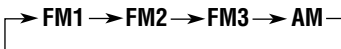

Selected band appears.

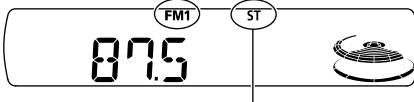

Lights up when receiving an FM stereo broadcast with sufficient signal strength.

Note:

This receiver has three FM bands (FM1, FM2, FM3).

- FM1/FM2: 87.5 MHz to 108.0 MHz
- FM3: 65.00 MHz to 74.00 MHz

2 Start searching a station.

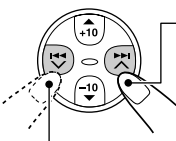

To search stations of higher frequencies

To search stations of lower frequencies

When a station is received, searching stops.

To stop searching before a station is received, press the same button you have pressed for searching.

Searching a station manually: Manual search

1 Select the band (FM 1 – 3, AM).

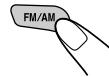

Each time you press the button, the band changes as follows:

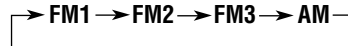

Note:

This receiver has three FM bands (FM1, FM2, FM3).

- FM1/FM2: 87.5 MHz to 108.0 MHz
- FM3: 65.00 MHz to 74.00 MHz

2 Press and hold **▶▶** **▲** or **◀◀** **▼** until "M" (manual) starts flashing on the display.

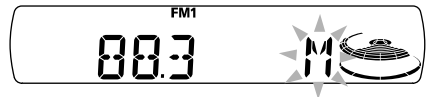
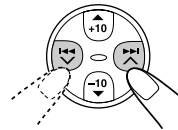



3 Tune in to a station you want while “M” (manual) is flashing.

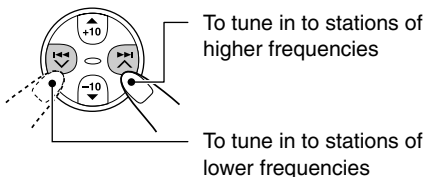

- If you release your finger from the button, the manual mode will automatically turn off after 5 seconds.
- If you hold down the button, the frequency keeps changing—in 50 kHz intervals (87.5 MHz – 108.0 MHz for FM 1 and FM 2), in 30 kHz intervals (65.00 MHz – 74.00 MHz for FM 3) and 9 kHz for AM—MW/LW until you release the button.

When an FM stereo broadcast is hard to receive:

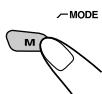

1 Press M (MODE) to enter the functions mode while listening to an FM stereo broadcast.

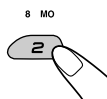

2 Press MO (monaural), while still in the functions mode, so that the MO indicator lights up on the display. Each time you press the button, the MO indicator lights up and goes off alternately.

MO (monaural) indicator

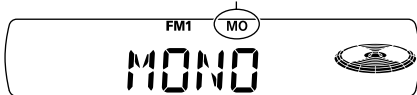

When the MO indicator is lit on the display, the sound you hear becomes monaural but the reception will be improved.

Storing stations in memory

You can use one of the following two methods to store broadcasting stations in memory.

- Automatic preset of FM stations: SSM (Strong-station Sequential Memory)
- Manual preset of both FM and AM stations

FM station automatic preset: SSM

You can preset 6 local FM stations in each FM band (FM1, FM2, and FM3).

1 Select the FM band (FM1 – 3) you want to store FM stations into.

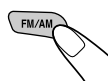

Each time you press the button, the band changes as follows:

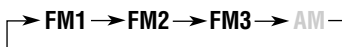

2 Press and hold both buttons for more than 2 seconds.

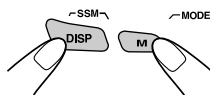

“-SSM-” appears, then disappears when automatic preset is over.

Local FM stations with the strongest signals are searched and stored automatically in the band number you have selected (FM1, FM2, or FM3). These stations are preset in the number buttons—No.1 (lowest frequency) to No.6 (highest frequency).

When automatic preset is over, the station stored in number button 1 will be automatically tuned in.

Manual preset

You can preset up to 6 stations in each band (FM1, FM2, FM3, and AM) manually.

Ex.: Storing FM station of 88.3 MHz into the preset number 1 of the FM1 band.

1 Select the band (FM1 – 3, AM) you want to store stations into (in this example, FM1).

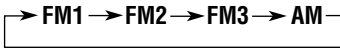
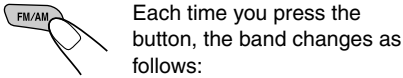

2 Tune in to a station (in this example, of 88.3 MHz).

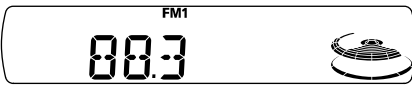
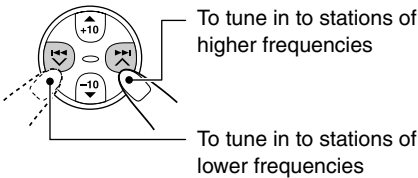

3 Press and hold the number button (in this example, 1) for more than 2 seconds.

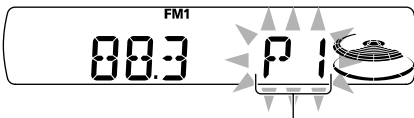
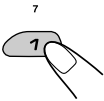

"P1" flashes for a few seconds.

4 Repeat the above procedure to store other stations into other preset numbers.

Notes:

- A previously preset station is erased when a new station is stored in the same preset number.
- Preset stations are erased when the power supply to the memory circuit is interrupted (for example, during battery replacement). If this occurs, preset the stations again.

Tuning in to a preset station

You can easily tune in to a preset station. Remember that you must store stations first. If you have not stored them yet, see "Storing stations in memory" on pages 8 and 9.

1 Select the band (FM1 – 3, AM).

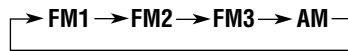
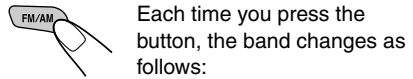

2 Select the number (1 – 6) for the preset station you want.

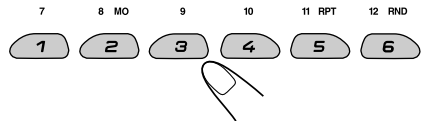

Note:

You can also use the ▲ (up) or ▼ (down) button on the unit to select the next or previous preset stations. Each time you press the ▲ (up) or ▼ (down) button, the next or previous preset station is tuned in.



CD OPERATIONS

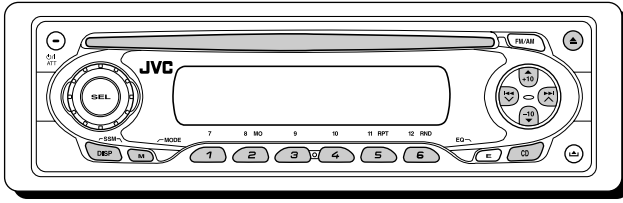

Refer to "MP3 OPERATIONS" on pages 16 to 20 for operating MP3 discs.

All tracks will be played repeatedly until you stop playback.

Playing a CD

Insert a CD into the loading slot.

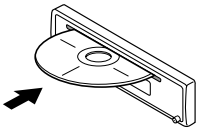

The unit turns on, draws the CD and starts playback automatically.

Note on One-Touch Operation:

When a CD is already in the loading slot, pressing CD turns on the unit and starts playback automatically.

The CD-in indicator flashes.



The CD-in indicator lights up.

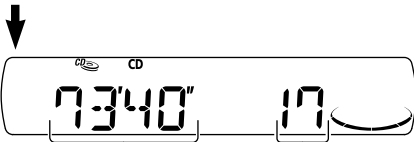

Total playing time of the inserted disc Total track number of the inserted disc



Elapsed playing time Current track

Note:

When a CD is inserted upside down, "EJECT" and the CD-in indicator flash on the display and the CD automatically ejects.

To stop play and eject the CD

Press ▲.

CD play stops and the CD automatically ejects from the loading slot. The source changes to the tuner (you will hear the last received station.)

- If you change the source, CD play also stops (without ejecting the CD).

Next time you select "CD" as the source, CD play starts from where playback has been stopped previously.

Notes:

- If the ejected disc is not removed for about 15 seconds, the disc is automatically inserted again into the loading slot to protect it from dust. (Disc play will not start this time.)
- You can eject the disc even when the unit is turned off.
- If the disc is a CD Text, disc title/performer and then track title will automatically appear.



Locating a track or a particular portion on a CD

To fast-forward or reverse the track

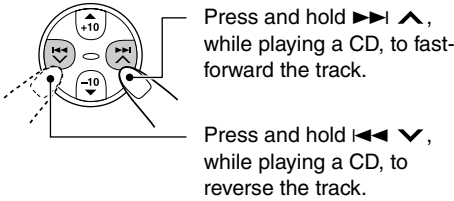

To go to the next or previous tracks

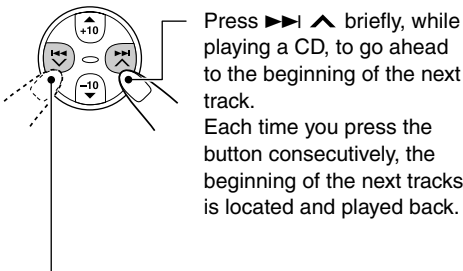

To go to a track quickly (+10 and -10 buttons)

- 1 Press M (MODE) to enter the functions mode while playing a CD.



- 2 Press +10 or -10.

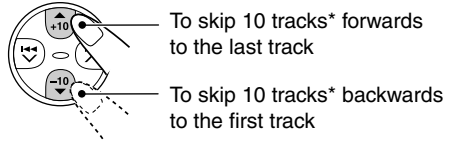

- * The first time you press +10 or -10 button, the track skips to the nearest higher or lower track with a track number of multiple ten (ex. 10th, 20th, 30th). Then each time you press the button, you can skip 10 tracks (see "How to use the +10 and -10 buttons" below).
- After the last track, the first track will be selected, and vice versa.

How to use the +10 and -10 buttons

- Ex. 1: To select track number 32 while playing track number 6

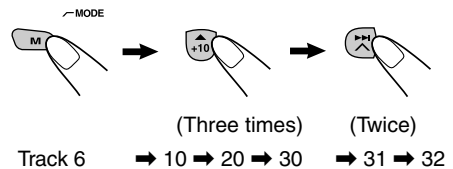

- Ex. 2: To select track number 8 while playing track number 36

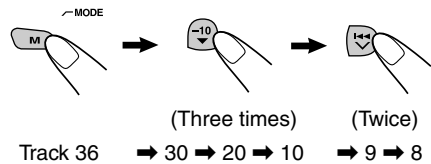

To go to a particular track directly

Press the number button corresponding to the track number to start its playback.

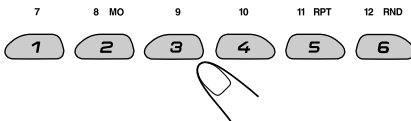

- To select a track number from 1 – 6: Press 1 (7) – 6 (12) briefly.
- To select a track number from 7 – 12: Press and hold 1 (7) – 6 (12) for more than one second.



Selecting CD playback modes

To play back tracks at random (Disc Random Play)

You can play back all tracks on the CD at random.

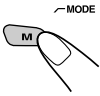

1 Press M (MODE) to enter the functions mode while playing a CD.

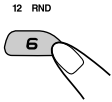

2 Press RND (random), while still in the functions mode, so that "DISC RND" appears on the display. Each time you press the button, disc random play mode turns on and off alternately.

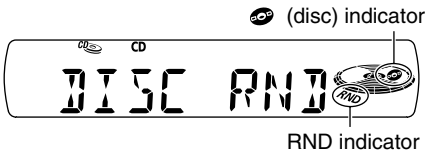

When disc random play is turned on, the and RND indicators light up on the display. A track randomly selected starts playing.

To play back tracks repeatedly (Track Repeat Play)

You can play back the current track repeatedly.

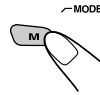

1 Press M (MODE) to enter the functions mode while playing a CD.

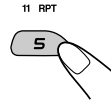

2 Press RPT (repeat), while still in the functions mode, so that "TRK RPT" appears on the display. Each time you press the button, track repeat play mode turns on and off alternately.

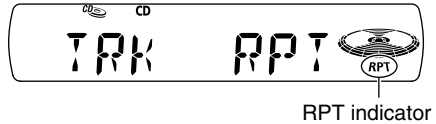

When track repeat play is turned on, the RPT indicator lights up on the display. The current track starts playing repeatedly.



Playing a CD Text

In a CD Text, some information about the disc (its disc title, performer, and track title) is recorded. This CD Text information will be shown automatically when you play a CD Text.

To change the CD Text information manually, select text display mode while playing a CD Text.

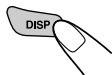

Each time you press the button, the display changes as follows:

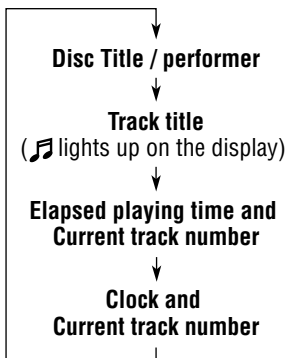

Notes:

- The display shows up to 8 characters at a time and scrolls if there are more than 8 characters. See also "To select the scroll mode—SCROLL" on page 24. Some characters or symbols will not be shown (and be blanked) on the display. (Ex. "ABC&'d#" ⇒ "ABCA D ")
- When you press DISP (display) while playing a conventional CD, "NO NAME" appears for the disc title/performer and the track title.

Prohibiting disc ejection

You can prohibit disc ejection and can lock a disc in the loading slot.

While pressing CD, press and hold ▲ for more than 2 seconds.

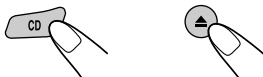

"EJECT" flashes on the display for about 5 seconds, and the disc is locked and cannot be ejected.



To cancel the prohibition and unlock the disc

While pressing CD, press and hold ▲ again for more than 2 seconds. "EJECT" and the CD-in indicator flash on the display, and the disc ejects from the loading slot.

The CD-in indicator flashes.





MP3 INTRODUCTION

What is MP3?

MP3 is an abbreviation of Motion Picture Experts Group (or MPEG) Audio Layer 3. MP3 is simply a file format with a data compression ratio of 1:10 (128 Kbps*). That means, by using MP3 format, one CD-R or CD-RW can contain 10 times as much data volume as a regular CD can.

* Bit rate is the average number of bits that one second of audio data will consume. The unit used is Kbps (1024 bits/second). To get a better audio quality, choose a higher bit rate. The most popular bit rate for encoding is 128 Kbps.

This unit is incorporated with an MP3 decoder. You can play back MP3 files (tracks) recorded on CD-Rs, CD-RWs, and CD-ROMs.

Compatible with ID3v1 (Version 1)

Extra information data such as album title, performer name, song title, recording year, music genre and a brief comment can be stored within an MP3 file.

This unit can show ID3v1 (Version 1) tags (album name, performer name, and song title) on the display. (See page 17.)

- Some characters cannot be shown correctly.
- This unit is not compatible with ID3v2 (Version 2).

Other main features in this unit:

- Maximum number of folders/files: 289 (Total)
- Available characters for folder/file names: A–Z, 0–9, _ (underscore)
- Maximum number of characters for file name (ISO 9660 Level 1): 12 (inclusive of separation mark—“.” and extension code —“mp3”)
- (ISO 9660 Level 2): 31 (inclusive of separation mark—“.” and extension code —“mp3”)
- (Joliet): 64 (inclusive of separation mark—“.” and extension code —“mp3”)
- Maximum number of characters for folder name: 64

Precautions when recording MP3 files on a CD-R or CD-RW

This unit can only read MP3 files that are recorded in the format that is compliant with ISO 9660 Level 1, Level 2, or Joliet.

How are MP3 files recorded and played back?

MP3 “files (tracks)” can be recorded in “folders”—in PC terminology.

During recording, the files and folders can be arranged in a way similar to arranging files and folders of computer data.

“Root” is similar to the root of a tree. Every file and folder can be linked to and be accessed from the root.

Playback order, file search order, and folder search order of the MP3 files recorded on a disc are determined by the writing (or encoding) application; therefore, playback order may be different from the one you have intended while recording the folders and the files.

The illustration on the next page shows an example of how MP3 files are recorded on a CD-R or CD-RW, how they are played back, and how they are searched for on this unit.



Notes:

- The unit can read a CD-ROM containing MP3 files. However, if non-MP3 files are recorded together with MP3 files, this unit will take a longer time to scan the disc. It may also cause the unit to malfunction.
- The unit cannot read or play an MP3 file without the extension code—mp3.
- This player is not compatible with the data encoded with Layer 1 and Layer 2 formats.
- The unit is not compatible with Playlist**.

** A playlist is a simple text file, used on a PC, which enables users to make their own playback order without physically rearranging the files.

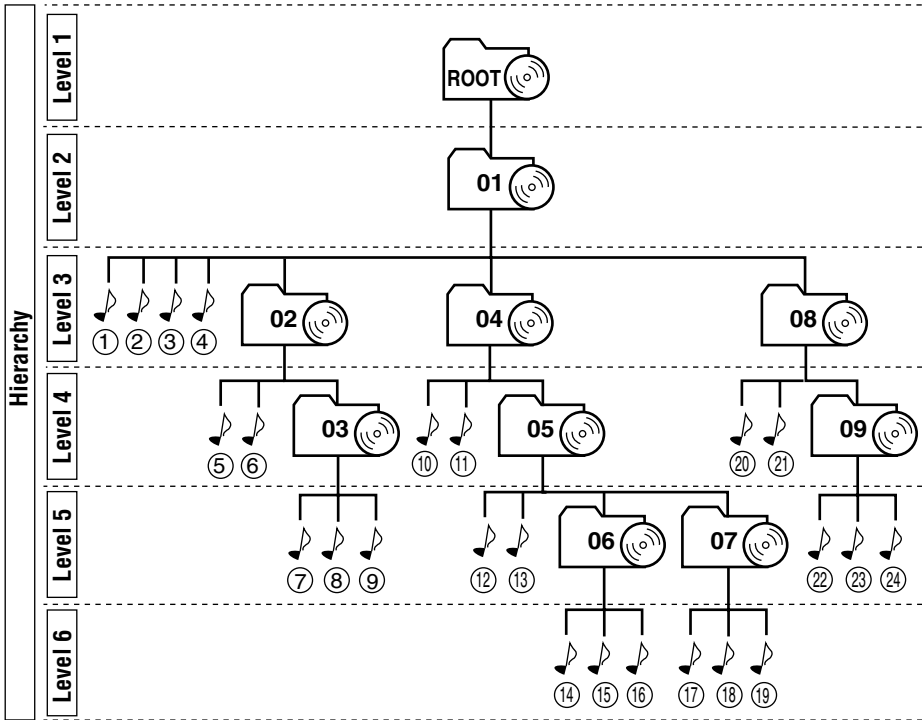
MP3 folder/file configuration



	: Root
	: Folders
	: MP3 files

Note:

There is no limit on the number of the hierarchy levels (nested folders). However, up to 8 hierarchy levels is recommended for stable operations.

MP3 playback/search order

- The numbers in circles below the MP3 files (🎵) indicate the playback order and search order of the MP3 files. Normally this unit plays back MP3 files in the recorded order.
- The numbers inside the folders indicate the playback order and search order of the folders on an MP3 disc. Normally this unit plays back MP3 files in the folders in the recorded order.

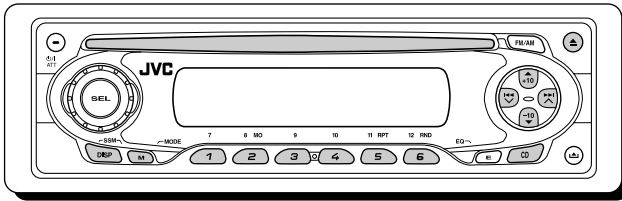

Refer also to "CD OPERATIONS" on pages 10 to 13.

Playing an MP3 disc

Insert an MP3 disc into the loading slot.

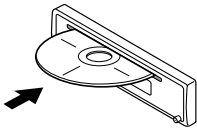

The unit turns on, draws the MP3 disc and starts playback automatically.

Note on One-Touch Operation:

When a disc is already in the loading slot, pressing CD turns on the unit and starts playback automatically.

All files will be played repeatedly until you stop playback.

Notes:

- MP3 discs require a longer readout time. (It differs due to the complexity of the folder/file configuration.)
- When playback starts, folder and file names (or ID3 tags) will automatically appears. (See also page 17.)
- If you change the source or turn the power off, disc playback stops (without ejecting the disc). Next time you select the CD player as the source or turn the power on, disc playback starts from where playback has been stopped previously.

The CD-in indicator flashes.



↓ The CD-in indicator lights up.



↓



↓

MP3 indicator lights up.

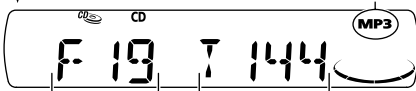

Total folder number Total file number

Ex.: When the disc contains 19 folders and 144 MP3 files

To stop play and eject the disc

Press ▲.

Playback stops and the disc automatically ejects from the loading slot.

To change the display information

While playing back an MP3 file, you can change the MP3 disc information shown on the display.

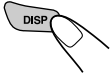

Each time you press DISP (display), the display changes to show the following:

- When “TAG DISP” is set to “TAG ON” (initial setting: see page 24)

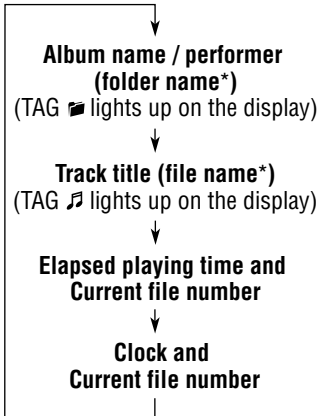

- When “TAG DISP” is set to “TAG OFF”

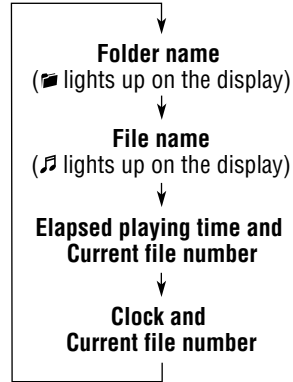

Note:

The display shows up to 8 characters at a time and scrolls if there are more than 8 characters. See also “To select the scroll mode—SCROLL” on page 24.

* If an MP3 file does not have ID3 tags, folder name and file name appear. In this case, the TAG indicator will not light up on the display.

Locating a file or a particular portion on an MP3 disc

For "MP3 playback/search order" see page 15.

To fast-forward or reverse the file

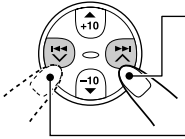

Press and hold **▶▶|▲** while playing an MP3 disc, to fast-forward the file.

Press and hold **◀◀|▼** while playing an MP3 disc, to reverse the file.

To skip to the next or previous files

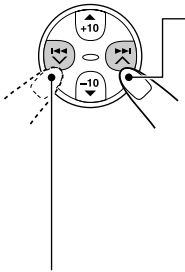

Press **▶▶|▲** briefly while playing, to skip ahead to the beginning of the next file.

Each time you press the button consecutively, the beginning of the next files is located and played back.

Press **◀◀|▼** briefly, while playing, to skip back to the beginning of the current file.

Each time you press the button consecutively, the beginning of the previous files is located and played back.

To go to a particular file quickly within the current folder (+10 and -10 buttons)

- 1 Press M (MODE) to enter the functions mode while playing an MP3 disc.



- 2 Press +10 or -10.

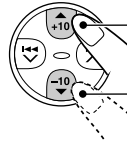

To skip 10 files* forwards to the last file

To skip 10 files* backwards to the first file

* The first time you press +10 or -10 button, the file skips to the nearest higher or lower file with a file number of multiple ten (ex. 10th, 20th, 30th).

Then each time you press the button, you can skip 10 files (see "How to use the +10 and -10 buttons" below).

- After the last file, the first file will be selected, and vice versa.

How to use the +10 and -10 buttons

- Ex. 1: To select file number 32 while playing file number 6

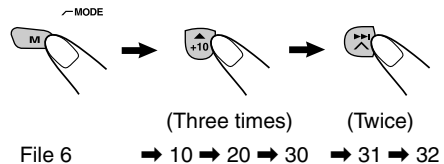

- Ex. 2: To select file number 8 while playing file number 36

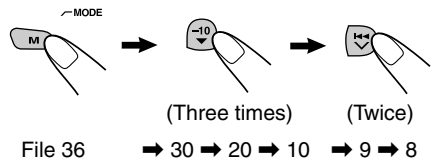

To go to a particular folder directly

IMPORTANT:

To directly select the folders using the number button(s), it is required that folders are assigned 2 digit numbers at the beginning of their folder names. (This can only be done during the recording of CD-Rs or CD-RWs.)

Ex.: If folder name is "01 ABC"

→ Press 1 to go to Folder 01 ABC.

If folder name is "1 ABC," pressing 1 does not work.

If folder name is "12 ABC"

→ Press and hold 6 (12) to go to Folder 12 ABC.

Press the number button corresponding to the folder number to start playing the first file in the selected folder.

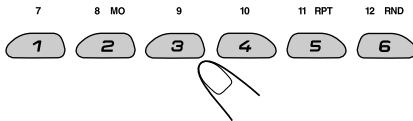

- To select a folder number from 01 – 06:
Press 1 (7) – 6 (12) briefly.
- To select a folder number from 07 – 12:
Press and hold 1 (7) – 6 (12) for more than one second.

Notes:

- If "MP3" flashes on the display after you have selected a folder, it means that the folder does not contain any MP3 files.
- You cannot directly select a folder with a number greater than 12.

To select a particular file in a folder, press ►► ▲ or ◀◀ ▼ after selecting the folder.

To skip to the next or previous folder

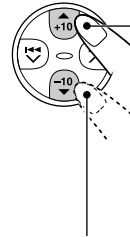

Press ▲ (up) while playing an MP3 disc to skip to the next folder.

Each time you press the button consecutively, the next folder is located (and the first file in the folder starts playing, if recorded).

Press ▼ (down) while playing an MP3 disc to skip back to the previous folder.

Each time you press the button consecutively, the previous folder is located (and the first file in the folder starts playing, if recorded).

Note:

If the folder does not contain any MP3 files, it is skipped.

Selecting MP3 playback modes

To play back files at random (Folder Random/Disc Random Play)

You can play back all files of the current folder or all files on the MP3 disc at random.

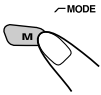

1 Press M (MODE) to enter the functions mode while playing an MP3 disc.

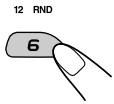

2 Press RND (random), while still in the functions mode, so that "FLDR RND" or "DISC RND" appears on the display. Each time you press the button, the random play mode changes as follows:

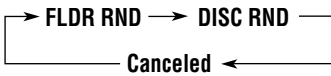

(folder) and RND indicators

Ex.: When you select "FLDR RND"

Mode	Active indicator	Plays at random
FLDR RND	(folder) and RND indicators light up.	All files of the current folder, then files of the next folder and so on.
DISC RND	(disc) and RND indicators light up.	All files on the disc.

To play back files repeatedly (Track Repeat/Folder Repeat Play)

You can play back the current file or all the files in the current folder repeatedly.

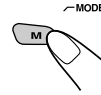

1 Press M (MODE) to enter the functions mode while playing an MP3 disc.

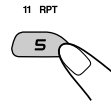

2 Press RPT (repeat), while still in the functions mode, so that "TRK RPT" or "FLDR RPT" appears on the display. Each time you press the button, the repeat play mode changes as follows:



RPT indicator

Ex.: When you select "TRK RPT"

Mode	Active indicator	Plays repeatedly
TRK RPT	RPT indicator lights up.	The current (or specified) file.
FLDR RPT	(folder) and RPT indicators light up.	All files of the current (or specified) folder.



Selecting preset sound modes (C-EQ: custom equalizer)

You can select a preset sound mode (C-EQ: custom equalizer) suitable to the music genre.

Select the sound mode you want.

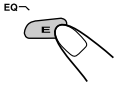

When you press the button once, the last selected sound mode is recalled and applied to the current source.



Ex.: If you have selected "USER" previously

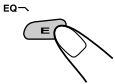

Then, each time you press the button, the sound modes change as follows:



The EQ indicator lights up when any sound mode other than "USER" is selected.

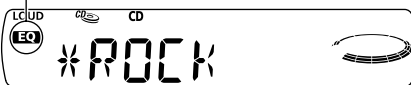

Ex.: When you select "ROCK"

Indication	For:	Preset values		
		BAS	TRE	LOUD
USER	(Flat sound)	00	00	OFF
ROCK	Rock or disco music	+03	+01	ON
CLASSIC	Classical music	+01	-02	OFF
POPS	Light music	+04	+01	OFF
HIP HOP	Funk or rap music	+02	00	ON
JAZZ	Jazz music	+02	+03	OFF

Note:

You can adjust each sound mode to your preference. Once you make an adjustment, it is automatically stored for the currently selected sound mode. See "Adjusting the sound" on page 22.



Adjusting the sound

You can adjust the sound characteristics to your preference.

1 Select the item you want to adjust.



Each time you press the button, the adjustable items change as follows:

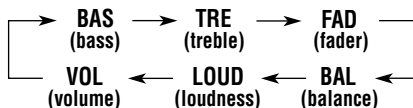

Indication	To do:	Range
BAS* ¹	Adjust the bass.	-06 (min.) +06 (max.)
TRE* ¹	Adjust the treble.	-06 (min.) +06 (max.)
FAD* ²	Adjust the front and rear speaker balance.	R06 (Rear only) F06 (Front only)
BAL	Adjust the left and right speaker balance.	L06 (Left only) R06 (Right only)
LOUD* ¹	Boost low and high frequencies to produce a well-balanced sound at low volume level.	LOUD ON LOUD OFF
VOL* ³	Adjust the volume.	00 (min.) 50 (max.)

*¹ When you adjust the bass, treble, or loudness, the adjustment you have made is stored for the currently selected sound mode (C-EQ) including "USER."

*² If you are using a two-speaker system, set the fader level to "00."

*³ Normally the control dial works as the volume control. So you do not have to select "VOL" to adjust the volume level.

2 Adjust the setting.

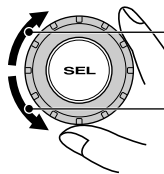

To increase the level or turn on the loudness

To decrease the level or turn off the loudness

Equalization pattern changes as you adjust the bass or treble.

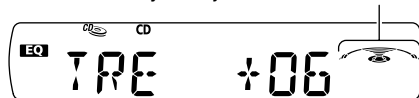

Ex. 1: When you adjust "TRE" (treble)



Ex. 2: When you turn on the loudness

3 Repeat steps 1 and 2 to adjust the other items.

To reset each sound mode to the factory settings, repeat the same procedure and reassign the preset values listed in the table on page 21.

OTHER MAIN FUNCTIONS



Changing the general settings (PSM)

You can change the items listed in the table below by using the PSM (Preferred Setting Mode) control.

Basic Procedure

1 Press and hold SEL (select) for more than 2 seconds so that one of the PSM items appears on the display. (See the table below.)



2 Select the PSM item you want to adjust. (See the table below.)

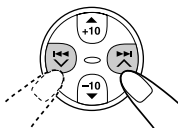

3 Adjust the PSM item selected.

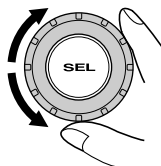

4 Repeat steps 2 and 3 to adjust the other PSM items if necessary.

5 Finish the setting.



Preferred Setting Mode (PSM) items

• For detailed operations of each PSM items, refer to the pages listed in the table.

Indications		Selectable values/items		Factory-preset settings	See page
CLOCK H	Hour adjustment	Back	Advance	0:00	6
	CLOCK M	Minute adjustment	Back		
LEVEL	Level display	AUDIO 1 ↙ ↘	AUDIO 2 ↔ OFF ↔	AUDIO 2	24
TEL	Telephone muting	MUTING 1 ↙ ↘	MUTING 2 ↔ OFF ↔	OFF	24
SCROLL	Scroll mode	ONCE ↙ ↘	AUTO ↔ OFF ↔	ONCE	24
TAG DISP	Tag display	TAG ON	TAG OFF	TAG ON	24



To select the level meter—LEVEL

You can select the level display according to your preference.

When shipped from the factory, “AUDIO 2” is selected.

- AUDIO 1: Shows the audio level indicator.
- AUDIO 2: Alternates “AUDIO 1” setting and illumination display.
- OFF: Erases the audio level indicator.

To select the telephone muting—TEL

This mode is used when a cellular phone system is connected. Depending on the phone system used, select either “MUTING 1” or “MUTING 2” whichever mutes the sounds from this unit.

When shipped from the factory, this mode is deactivated.

- MUTING 1: Select this if this setting can mute the sounds.
- MUTING 2: Select this if this setting can mute the sounds.
- OFF: Cancels the telephone muting.

To select the scroll mode—SCROLL

You can select the scroll mode for the disc information (when the entire text cannot be shown all at once).

When shipped from the factory, scroll mode is set to “ONCE.”

- ONCE: Scrolls only once.
- AUTO: Repeats the scroll (5-second intervals in between).
- OFF: Cancels scroll mode.

Note:

Even if the scroll mode is set to “OFF,” you can scroll the display by pressing DISP (display) for more than one second.

To turn the tag display on or off—TAG DISP

An MP3 file can contain file information called “ID3 Tag” where its album name, performer, track title, etc. are recorded.

There are two versions—ID3v1 (ID3 Tag version 1) and ID3v2 (ID3 Tag version 2). This unit is compatible only with ID3v1.

When shipped from the factory, “TAG ON” is selected.

- TAG ON: Turns on the ID3 tag display while playing MP3 files.
 - If an MP3 file does not have ID3 tags, folder name and file name appear.
- TAG OFF: Turns off the ID3 tag display while playing MP3 files. (Only the folder name and file name can be shown.)



Detaching the control panel

You can detach the control panel when leaving the car.
When detaching or attaching the control panel, be careful not to damage the connectors on the back of the control panel and on the panel holder.

Detaching the control panel

Before detaching the control panel, be sure to turn off the power.

1 Unlock the control panel.

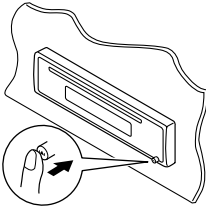

2 Lift and pull the control panel out of the unit.

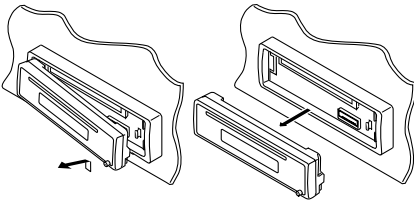

3 Put the detached control panel into the provided case.

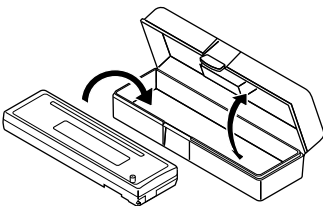

Attaching the control panel

1 Insert the left side of the control panel into the groove on the panel holder.

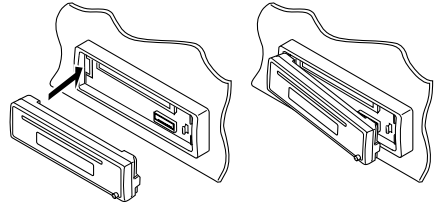

2 Press the right side of the control panel to fix it to the panel holder.

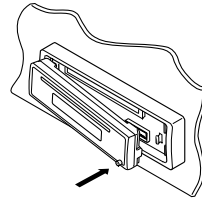

Note on cleaning the connectors:

If you frequently detach the control panel, the connectors will deteriorate.

To minimize this possibility, periodically wipe the connectors with a cotton swab or cloth moistened with alcohol, being careful not to damage the connectors.

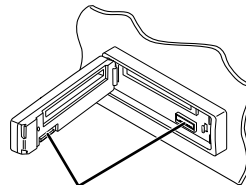

Connectors



TROUBLESHOOTING

What appears to be trouble is not always serious. Check the following points before calling a service center.

	Symptoms	Causes	Remedies
General	<ul style="list-style-type: none"> Sound cannot be heard from the speakers. 	The volume level is set to the minimum level.	Adjust it to the optimum level.
		Connections are incorrect.	Check the cords and connections.
	<ul style="list-style-type: none"> This unit does not work at all. 	The built-in microcomputer may have functioned incorrectly due to noise, etc.	While holding SEL (select), press ⏻/ATT (standby/on/attenuator) for more than 2 seconds to reset the unit. (The clock setting and preset stations stored in memory are erased.) (See page 2.)
FM/AM	<ul style="list-style-type: none"> SSM (Strong-station Sequential Memory) automatic preset does not work. 	Signals are too weak.	Store stations manually.
	<ul style="list-style-type: none"> Static noise while listening to the radio. 	The aerial is not connected firmly.	Connect the aerial firmly.
Disc Playback	<ul style="list-style-type: none"> Disc automatically ejects. 	Disc is inserted upside down.	Insert the disc correctly.
	<ul style="list-style-type: none"> CD-R/CD-RW cannot be played back. Tracks on the CD-R/CD-RW cannot be skipped. 	CD-R/CD-RW is not finalized.	<ul style="list-style-type: none"> Insert a finalized CD-R/CD-RW. Finalize the CD-R/CD-RW with the component which you used for recording.
		<ul style="list-style-type: none"> Disc can be neither played back nor ejected. 	Disc is locked.
	The CD player may function incorrectly.		While holding ⏻/ATT (standby/on/attenuator), press ▲ (eject) for more than 2 seconds. Be careful not to drop the disc when it is ejected.
	<ul style="list-style-type: none"> Disc sound is sometimes interrupted. 	You are driving on rough roads.	Stop playback while driving on rough roads.
		Disc is scratched.	Change the disc.
		Connections are incorrect.	Check the cords and connections.
	<ul style="list-style-type: none"> "NO DISC" appears on the display. 	No disc in the loading slot.	Insert a disc into the loading slot.
Disc is inserted incorrectly.		Insert the disc correctly.	



Symptoms	Causes	Remedies
<ul style="list-style-type: none"> Disc cannot be played back. 	No MP3 files are recorded on the disc.	Change the disc.
	MP3 files do not have the extension code—mp3 in their file names.	Add the extension code—mp3 to their file names.
	MP3 files are not recorded in the format compliant with ISO 9660 Level 1, Level 2, or Joliet.	Change the disc. (Record MP3 files using a compliant application.)
<ul style="list-style-type: none"> Noise is generated. 	The file played back is not an MP3 file (although it has the extension code—mp3).	Skip to another file or change the disc. (Do not add the extension code—mp3 to non-MP3 files.)
<ul style="list-style-type: none"> A longer readout time is required (“CHECK” keeps flashing on the display). 	Readout time varies due to the complexity of the folder/file configuration.	Do not use too many hierarchies and folders. Also, do not record any other types of audio tracks together with MP3 files.
<ul style="list-style-type: none"> Files cannot be played back as you have intended them to play. 	Playback order is determined when the files are recorded.	_____
<ul style="list-style-type: none"> Elapsed playing time is not correct. 	This sometimes occurs during play. This is caused by how the files are recorded on the disc.	_____
<ul style="list-style-type: none"> “MP3” flashes on the display. 	The current folder does not contain any MP3 file.	Select another folder.
<ul style="list-style-type: none"> “NO FILES” appears on the display, then the disc ejects from the loading slot. 	The current disc does not contain any MP3 file.	Insert a disc that contains MP3 files.
<ul style="list-style-type: none"> Correct characters are not displayed (e.g. album name). 	This unit can only display alphabets (capital: A–Z), numbers, and a limited number of symbols.	_____

MP3 Playback

About mistracking:

Mistracking may result from driving on extremely rough roads. This does not damage the unit and the disc, but will be annoying.

We recommend that you stop disc play while driving on such rough roads.



MAINTENANCE

Handling discs

This unit has been designed to reproduce CDs, CD-Rs (Recordable), CD-RWs (Rewritable), and CD Texts.

• **This unit is also compatible with MP3 discs.**

How to handle discs

When removing a disc from its case, press down the center holder of the case and lift the disc out, holding it by the edges.

Center holder



• Always hold the disc by the edges. Do not touch its recording surface.

When storing a disc into its case, gently insert the disc around the center holder (with the printed surface facing up).

• Make sure to store discs into the cases after use.

To keep discs clean

A dirty disc may not play correctly. If a disc does become dirty, wipe it with a soft cloth in a straight line from center to edge.



To play new discs

New discs may have some rough spots around the inner and outer edges. If such a disc is used, this unit may reject the disc.



To remove these rough spots, rub the edges with a pencil or ball-point pen, etc.

Moisture condensation

Moisture may condense on the lens inside the CD player in the following cases:

- After starting the heater in the car.
- If it becomes very humid inside the car.

Should this occur, the CD player may malfunction. In this case, eject the disc and leave the unit turned on for a few hours until the moisture evaporates.

When playing a CD-R or CD-RW

Before playing back CD-Rs or CD-RWs, read their instructions or cautions carefully.

- Use only “finalized” CD-Rs or CD-RWs.
- Some CD-Rs or CD-RWs may not play back on this unit because of their disc characteristics, and for the following reasons:
 - Discs are dirty or scratched.
 - Moisture condensation on the lens inside the unit.
 - The pickup lens inside the unit is dirty.
- CD-RWs may require a longer readout time since the reflectance of CD-RWs is lower than that of regular CDs.
- CD-Rs or CD-RWs are susceptible to high temperatures or high humidity, so do not leave them inside your car.
- Do not use following CD-Rs or CD-RWs:
 - Discs with stickers, labels, or protective seal stuck to the surface.
 - Discs on which labels can be directly printed by an ink jet printer.

Using these discs under high temperatures or high humidity may cause malfunctions or damage to discs. For example,

- Stickers or labels may shrink and warp a disc.
- Stickers or labels may peel off so discs cannot be ejected.
- Print on discs may get sticky.

Read instructions or cautions about labels and printable discs carefully.

CAUTIONS:

- Do not insert 8 cm discs (single CDs) into the loading slot. (Such discs cannot be ejected.)
- Do not insert any disc of unusual shape—like a heart or flower; otherwise, it will cause a malfunction.
- Do not expose discs to direct sunlight or any heat source or place them in a place subject to high temperature and humidity. Do not leave them in a car.
- Do not use any solvent (for example, conventional record cleaner, spray, thinner, benzene, etc.) to clean discs.

Warped disc



Sticker



Sticker residue

Disc



Stick-on label

AUDIO AMPLIFIER SECTION

Maximum Power Output:

Front: 50 W per channel

Rear: 50 W per channel

Continuous Power Output (RMS):

Front: 19 W per channel into 4 Ω , 40 Hz to 20 000 Hz at no more than 0.8% total harmonic distortion.

Rear: 19 W per channel into 4 Ω , 40 Hz to 20 000 Hz at no more than 0.8% total harmonic distortion.

Load Impedance: 4 Ω (4 Ω to 8 Ω allowance)

Tone Control Range:

Bass: ± 10 dB at 100 Hz

Treble: ± 10 dB at 10 kHz

Frequency Response: 40 Hz to 20 000 Hz

Signal-to-Noise Ratio: 70 dB

Line-Out Level/Impedance:

2.0 V/20 k Ω load (full scale)

Output Impedance: 1 k Ω

TUNER SECTION

Frequency Range:

FM1/FM2: 87.5 MHz to 108.0 MHz

FM3: 65.00 MHz to 74.00 MHz

AM: (MW) 522 kHz to 1 620 kHz

(LW) 144 kHz to 279 kHz

[FM Tuner]

Usable Sensitivity:

11.3 dBf (1.0 μ V/75 Ω)

50 dB Quieting Sensitivity:

16.3 dBf (1.8 μ V/75 Ω)

Alternate Channel Selectivity (400 kHz):

65 dB

Frequency Response: 40 Hz to 15 000 Hz

Stereo Separation: 30 dB

Capture Ratio: 1.5 dB

[MW Tuner]

Sensitivity: 20 μ V

Selectivity: 35 dB

[LW Tuner]

Sensitivity: 50 μ V

CD PLAYER SECTION

Type: Compact disc player

Signal Detection System: Non-contact optical pickup (semiconductor laser)

Number of channels: 2 channels (stereo)

Frequency Response: 5 Hz to 20 000 Hz

Dynamic Range: 96 dB

Signal-to-Noise Ratio: 98 dB

Wow and Flutter: Less than measurable limit

MP3 decoding format:

MPEG1/2 Audio Layer 3

Max. Bit Rate: 320 Kbps

GENERAL

Power Requirement:

Operating Voltage: DC 14.4 V

(11 V to 16 V allowance)

Grounding System: Negative ground

Allowable Operating Temperature:

0°C to +40°C

Dimensions (W \times H \times D):

Installation Size (approx.):

182 mm \times 52 mm \times 150 mm

Panel Size (approx.):

188 mm \times 58 mm \times 11 mm

Mass (approx.):

1.3 kg (excluding accessories)

Design and specifications are subject to change without notice.



**Having TROUBLE with operation?
Please reset your unit**

Refer to page of How to reset your unit

**Затруднения при эксплуатации?
Пожалуйста, перезагрузите Ваше
устройство**

Для получения информации о перезагрузке Вашего устройства обратитесь на соответствующую страницу

JVC

VICTOR COMPANY OF JAPAN, LIMITED



EN, RU

© 2003 VICTOR COMPANY OF JAPAN, LIMITED



0203KKSMJTJEIN

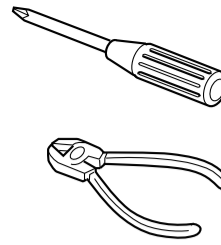

ENGLISH

- This unit is designed to operate on 12 V DC, NEGATIVE ground electrical systems.

INSTALLATION (IN-DASH MOUNTING)

- The following illustration shows a typical installation. However, you should make adjustments corresponding to your specific car. If you have any questions or require information regarding installation kits, consult your JVC IN-CAR ENTERTAINMENT dealer or a company supplying kits.

1 Before mounting: Press (control panel release button) to detach the control panel if already attached.

* When shipped from the factory, the control panel is packed in the hard case.

2 Remove the trim plate.

3 Remove the sleeve after disengaging the sleeve locks.

① Stand the unit.

Note: When you stand the unit, be careful not to damage the fuse on the rear.

② Insert the 2 handles between the unit and the sleeve, as illustrated, to disengage the sleeve locks.

③ Remove the sleeve.

Note: Be sure to keep the handles for future use after installing the unit.

4 Install the sleeve into the dashboard.

* After the sleeve is correctly installed into the dashboard, bend the appropriate tabs to hold the sleeve firmly in place, as illustrated.

5 Fix the mounting bolt to the rear of the unit's body and place the rubber cushion over the end of the bolt.

6 Do the required electrical connections.

7 Slide the unit into the sleeve until it is locked.

8 Attach the trim plate.

9 Attach the control panel.

РУССКИЙ

- Это устройство разработано для эксплуатации на 12 В постоянного напряжения с минусом на массе.

УСТАНОВКА (УСТАНОВКА В ПРИБОРНУЮ ПАНЕЛЬ)

- На следующих иллюстрациях показана типовая установка. Тем не менее, Вы должны сделать поправки в соответствии с типом Вашего автомобиля. Если у Вас есть какие-либо вопросы, касающиеся установки, обратитесь к Вашему дилеру JVC IN-CAR ENTERTAINMENT или в компанию, поставляющую соответствующие принадлежности.

1 Перед установкой: Нажмите кнопку (кнопка освобождения панели управления) для отсоединения панели управления, если она уже прикреплена.

* При отправке с завода панель управления упакована в твердую коробку.

2 Удалите декоративную панель.

3 Удалите муфту после освобождения запоров муфты.

① Установите устройство.

Примечание: Устанавливайте устройство таким образом, чтобы не повредить предохранитель, расположенный сзади.

② Вставьте два рычага между устройством и муфтой, как показано на рисунке, для освобождения запоров муфты.

③ Удалите муфту.

Примечание: После установки устройства сохраните рычаги для использования в будущем.

4 Установите муфту в приборную панель.

* После установки муфты в приборную панель согните соответствующие зубцы для фиксации муфты, как показано на рисунке.

5 Затяните Крепежный болт на задней части корпуса устройства и наденьте резиновый чехол на конец болта.

6 Выполните необходимые подключения контактов, как показано на обратной стороне этой инструкции.

7 Задвиньте устройство в муфту до упора.

8 Установите декоративную панель.

9 Прикрепите панель управления.

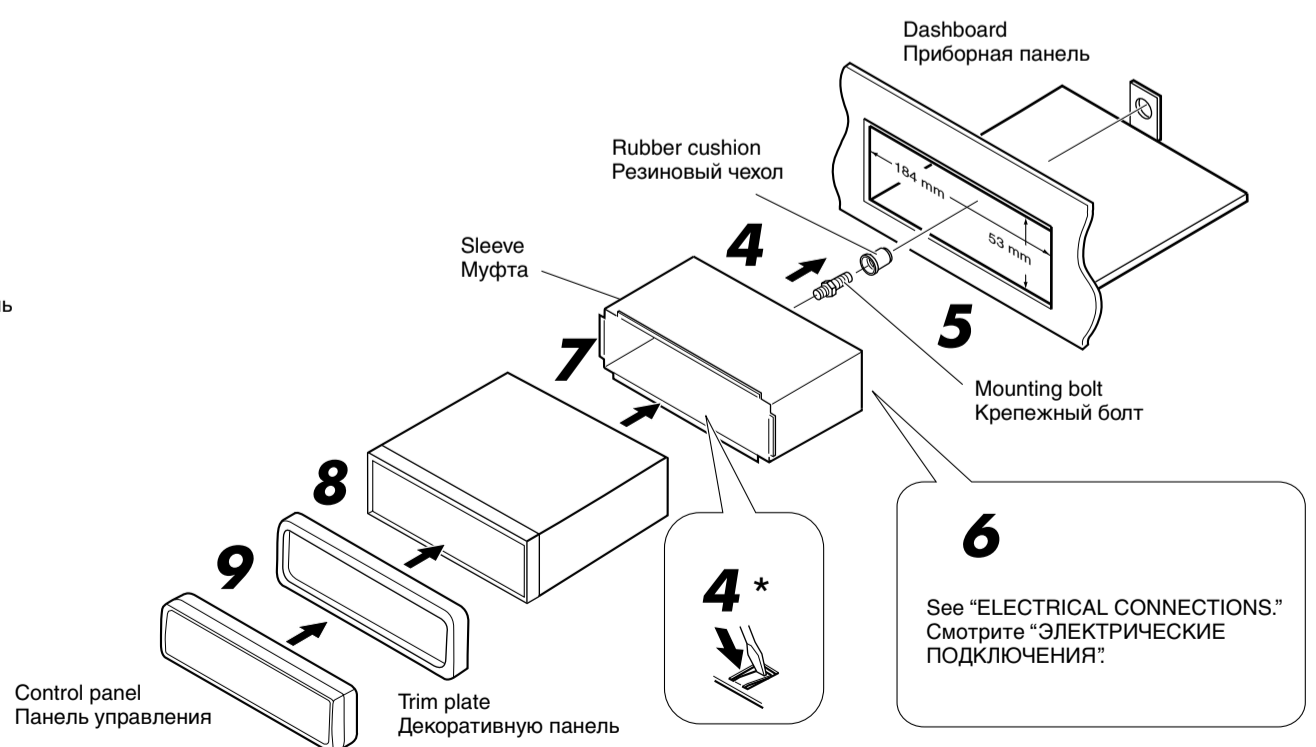
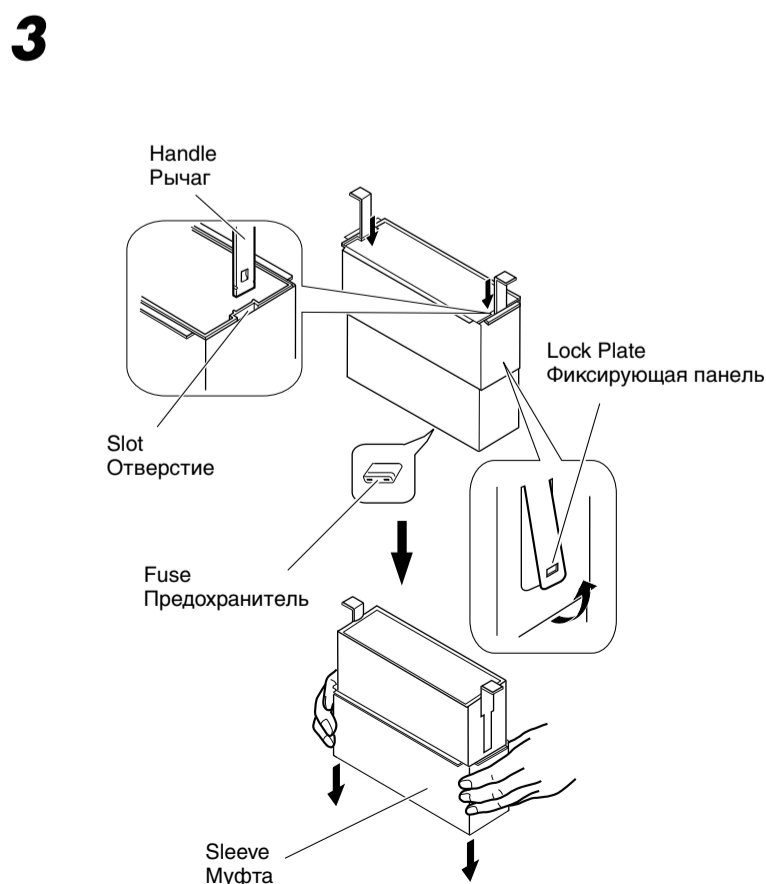
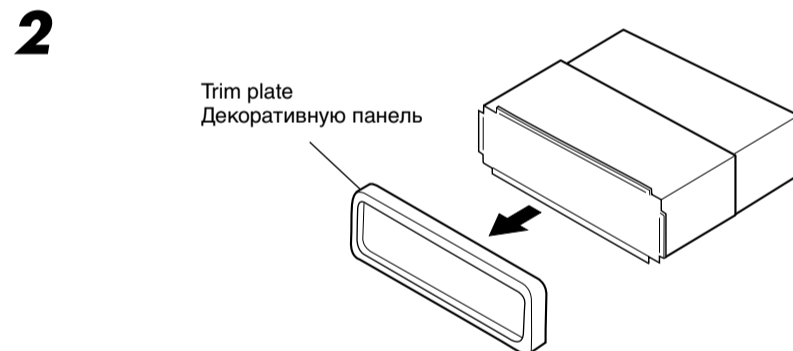
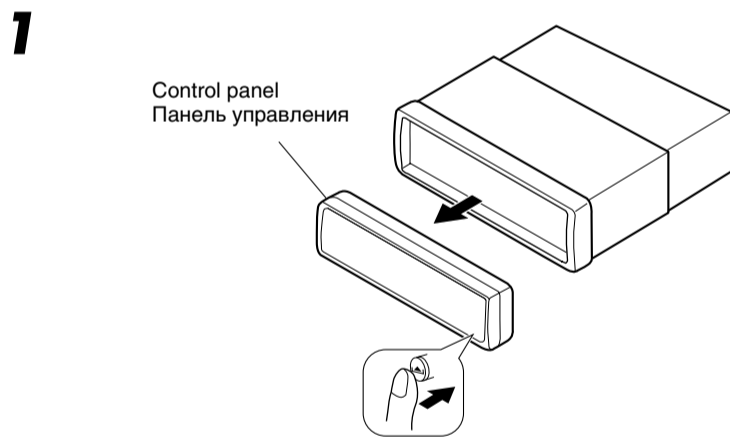

- **When using the optional stay**
- **При использовании дополнительной стойки**

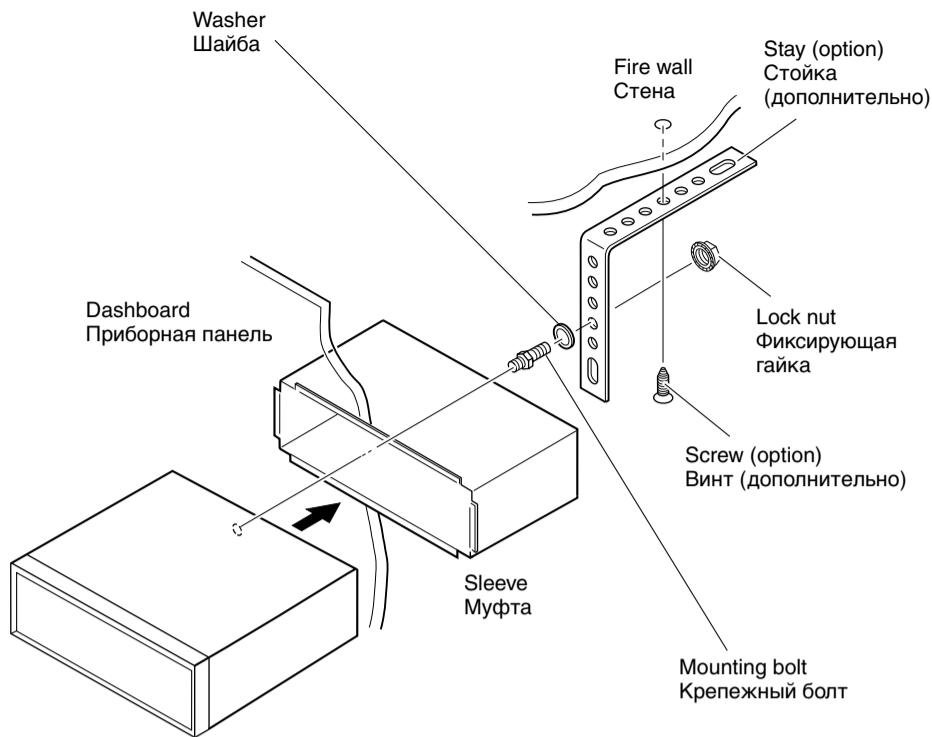

- **When installing the unit without using the sleeve**
- **При установке устройства без использования муфты**

In a Toyota for example, first remove the car radio and install the unit in its place.
В автомобилях "Toyota", например, сначала удалите автомобильную магнитолу, затем установите на ее место это устройство.

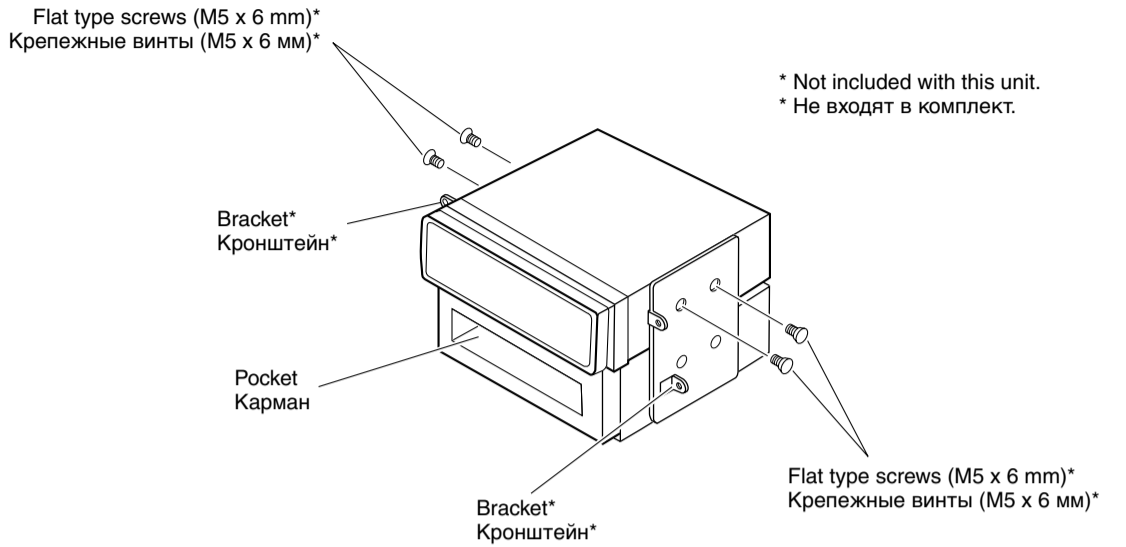

* Not included with this unit.
* Не входят в комплект.

Note : When installing the unit on the mounting bracket, make sure to use the 6 mm-long screws. If longer screws are used, they could damage the unit.
Примечание : При установке устройства на крепежный кронштейн, используйте только винты длиной 6 мм. При использовании более длинных винтов можно повредить устройство.

Removing the unit

- Before removing the unit, release the rear section.
- 1** Remove the control panel.
- 2** Remove the trim plate.
- 3** Insert the 2 handles into the slots, as shown. Then, while gently pulling the handles away from each other, slide out the unit. (**Be sure to keep the handles after installing it.**)

Удаление устройства

- Перед удалением устройства освободите заднюю часть.
- 1** Удалите панель управления.
- 2** Удалите декоративную панель.
- 3** Вставьте 2 рычага в отверстия, как показано на иллюстрации. Затем, плавно раздвигая рычаги в стороны, выньте устройство. (**После установки сохраните рычаги.**)

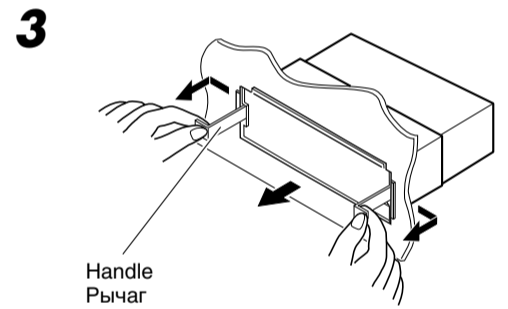
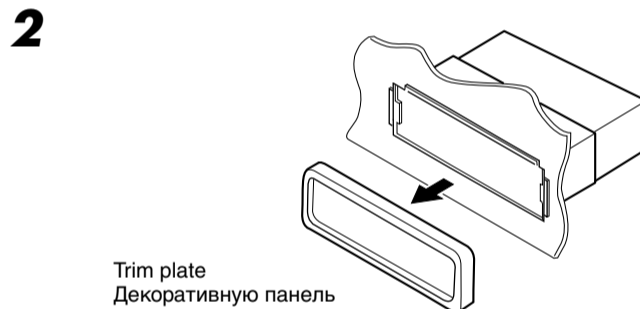
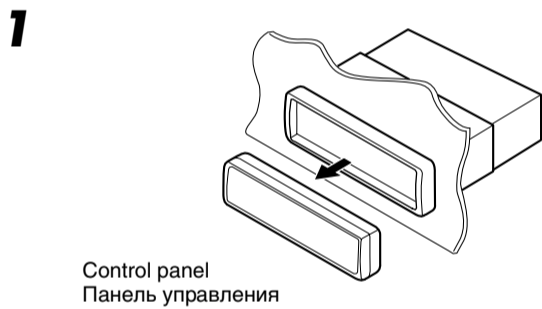

Parts list for installation and connection

The following parts are provided with this unit.
After checking them, please set them correctly.

Hard case/Control panel
Жесткий футляр/панель управления

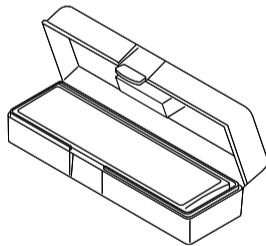

Sleeve
Муфта

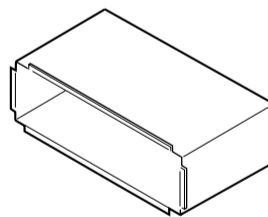

Trim plate
Декоративную панель

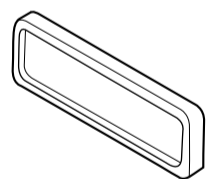

Power cord
Кабель питания

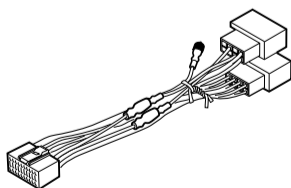

Handles
Рычаги

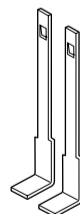

Washer (ø5)
Шайба (н5)



Lock nut (M5)
Фиксирующая гайка (M5)



Mounting bolt (M5 x 20 mm)
Крепежный болт (M5 x 20 мм)



Rubber cushion
Резиновый чехол



ELECTRICAL CONNECTIONS

To prevent short circuits, we recommend that you disconnect the battery's negative terminal and make all electrical connections before installing the unit. If you are not sure how to install this unit correctly, have it installed by a qualified technician.

Note: This unit is designed to operate on **12 V DC, NEGATIVE ground electrical systems**. If your vehicle does not have this system, a voltage inverter is required, which can be purchased at JVC IN-CAR ENTERTAINMENT dealers.

- Replace the fuse with one of the specified rating. If the fuse blows frequently, consult your JVC IN-CAR ENTERTAINMENT dealer.
- If noise is a problem...
This unit incorporates a noise filter in the power circuit. However, with some vehicles, clicking or other unwanted noise may occur. If this happens, connect the unit's **rear ground terminal** (see connection diagram) to the car's chassis using shorter and thicker cords, such as copper braiding or gauge wire. If noise still persists, consult your JVC IN-CAR ENTERTAINMENT dealer.
- Maximum input of the speakers should be more than 50 W at the rear and 50 W at the front, with an impedance of **4 Ω to 8 Ω**.
- **Be sure to ground this unit to the car's chassis.**
- The heat sink becomes very hot after use. Be careful not to touch it when removing this unit.

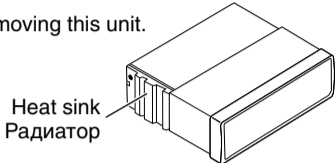

ЭЛЕКТРИЧЕСКИЕ ПОДКЛЮЧЕНИЯ

Для предотвращения коротких замыканий мы рекомендуем Вам отсоединить отрицательный разъем аккумулятора и осуществить все подключения перед установкой устройства. Если Вы не знаете точно, как следует устанавливать это устройство, обратитесь к квалифицированному специалисту.

Примечание: Это устройство разработано для эксплуатации на **12 В постоянного напряжения с минусом на массе**. Если Ваш автомобиль не имеет этой системы, требуется инвертор напряжения, который может быть приобретен у дилера JVC IN-CAR ENTERTAINMENT.

- Заменяйте предохранитель другим предохранителем указанного класса. Если предохранитель сгорает слишком часто, обратитесь к дилеру JVC IN-CAR ENTERTAINMENT.
- При появлении сильных помех...
Это устройство оснащено фильтром помех в цепи питания. Однако в некоторых случаях возможно появление щелчков и других нежелательных помех. В этом случае подключите **задний разъем заземления** этого устройства (см. схему подключения ниже) к шасси автомобиля при помощи более коротких и толстых проводов. Если помехи не исчезают, обратитесь к дилеру JVC IN-CAR ENTERTAINMENT.
- Максимальная входная мощность громкоговорителей должна быть больше 50 Вт сзади и 50 Вт впереди при полном сопротивлении от **4 Ω до 8 Ω**.
- **Не забудьте заземлить устройство на шасси автомобиля.**
- Радиатор во время использования сильно нагревается. Старайтесь его не трогать во время удаления устройства.

⚠ If your car is equipped with the ISO connector Если Ваш автомобиль оборудован разъемами ISO

- Connect the ISO connectors as illustrated.
- Подключите разъемы ISO, как показано на иллюстрации.

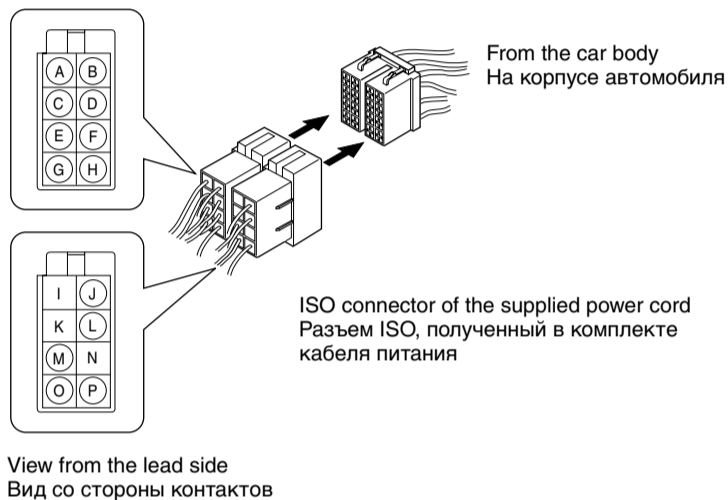

For some VW/Audi or Opel (Vauxhall) automobile Для некоторых автомобилей VW/Audi или Opel (Vauxhall)

- You may need to modify the wiring of the supplied power cord as illustrated.
- Contact your authorized car dealer before installing this unit.
 - Вам может потребоваться изменение соединений полученного в комплекте кабеля питания, как показано на иллюстрации.
 - Перед установкой устройства обратитесь к Вашему официальному дилеру автомобиля.

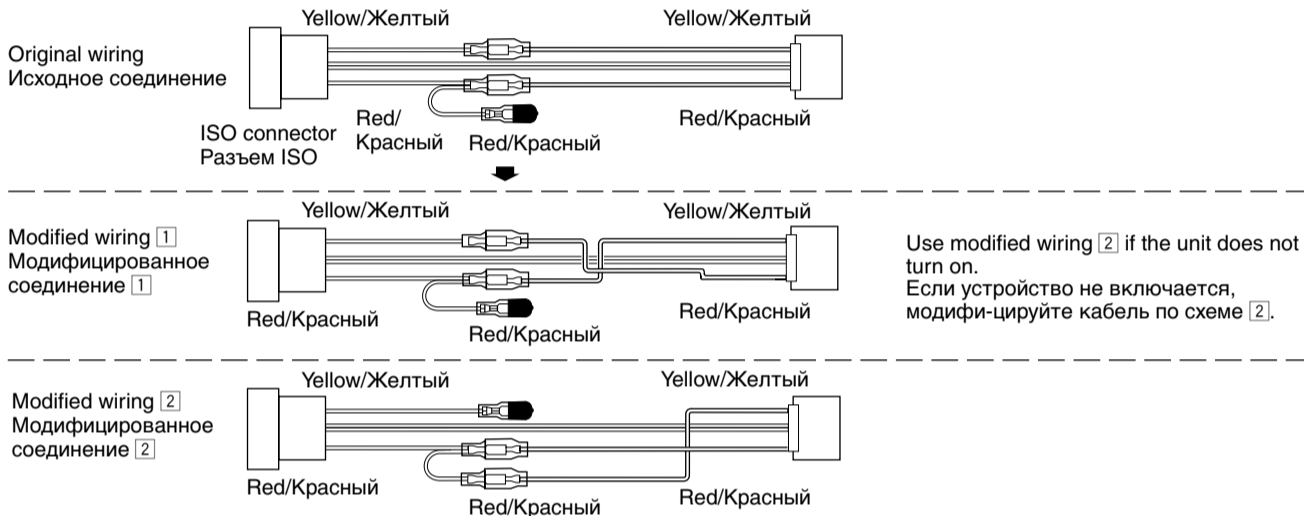

⚠ Connections without using the ISO connectors / Подключение без использования разъемов ISO

Before connecting: Check the wiring in the vehicle carefully. Incorrect connection may cause serious damage to this unit.
The leads of the power cord and those of the connector from the car body may be different in color.

- 1 Cut the ISO connector.
- 2 Connect the colored leads of the power cord to the car battery, speakers and power aerial (if any) in the following sequence:
 - 1 Black: ground
 - 2 Yellow: to car battery (constant 12 V)
 - 3 Red: to an accessory terminal
 - 4 Blue with white stripe: to remote lead of other equipment or power aerial if any (200 mA max.)
 - 5 Brown: to cellular phone system (For details, refer to the instructions of the cellular phone.)
 - 6 Others: to speakers
- 3 Connect the aerial cord.
- 4 Finally connect the wiring harness to the unit.

Перед началом подключений: Тщательно проверьте проводку в автомобиле. Неправильное подключение может привести к серьезному повреждению устройства.
Жилы силового кабеля и жилы соединителя от кузова автомобиля могут быть разного цвета.

- 1 Отрежьте разъем ISO.
- 2 Подключите цветные провода кабеля питания к аккумулятору, громкоговорителям и автономной антенне (если есть) в следующем порядке:
 - 1 Черный: земля
 - 2 Желтый: к аккумулятору (постоянный 12 В)
 - 3 Красный: к вспомогательному разъему
 - 4 Синий с белой полосой: к удаленному проводу другого оборудования или антенны (макс. 200 мА).
 - 5 Коричневый: к системе сотового телефона (Детали смотрите в инструкции сотового телефона.)
 - 6 Другие: к громкоговорителям
- 3 Подключите кабель антенны.
- 4 В последнюю очередь подключите электропроводку к устройству.

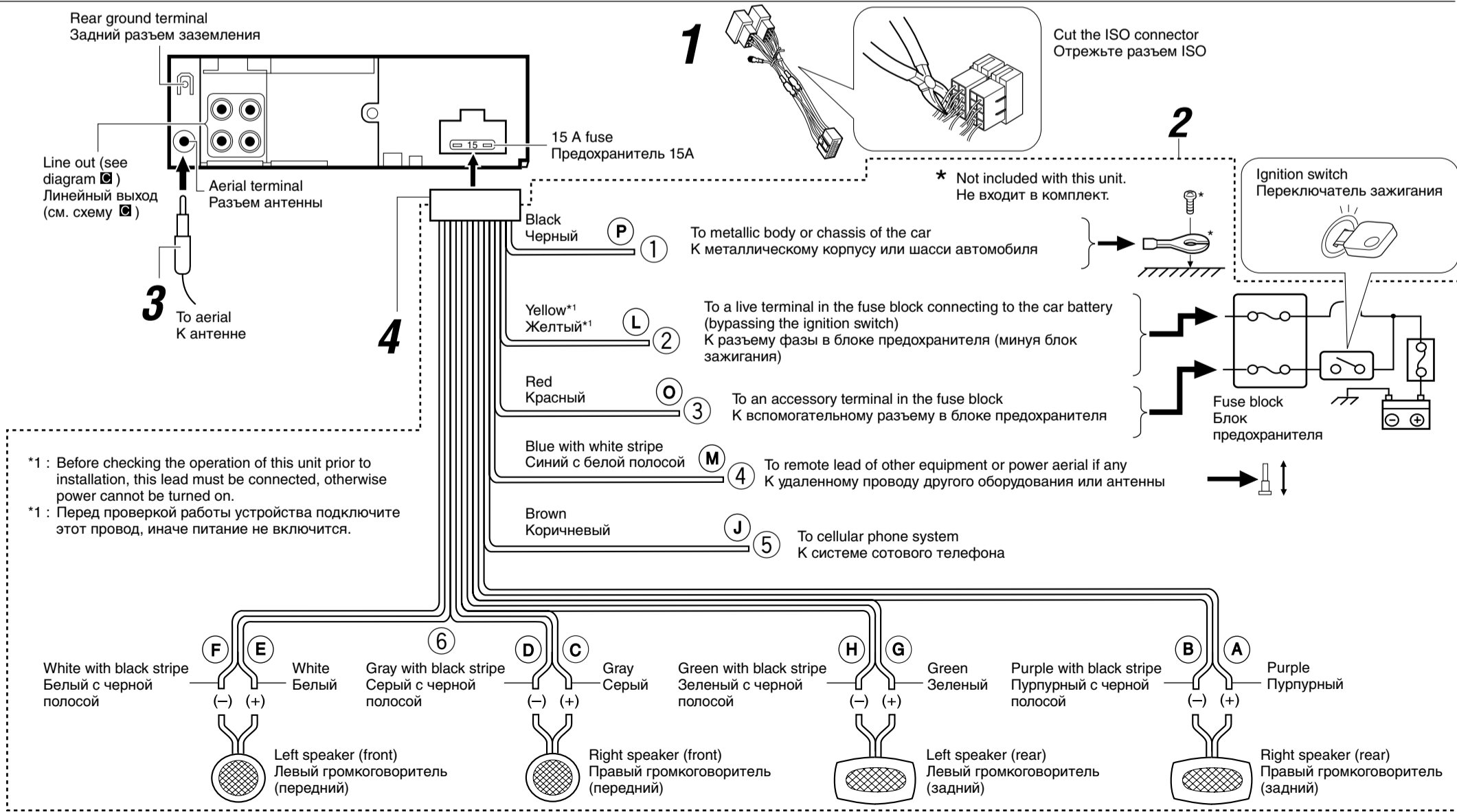

*1: Before checking the operation of this unit prior to installation, this lead must be connected, otherwise power cannot be turned on.
*1: Перед проверкой работы устройства подключите этот провод, иначе питание не включится.

PRECAUTIONS on power supply and speaker connections:

- **DO NOT** connect the speaker leads of the power cord to the car battery; otherwise, the unit will be seriously damaged.
- Connect the black lead (ground), yellow lead (to car battery, constant 12 V), and red lead (to an accessory terminal) correctly.
- **BEFORE** connecting the speaker leads of the power cord to the speakers, check the speaker wiring in your car.
 - If the speaker wiring in your car is as illustrated in Fig. 1 and Fig. 2 below, DO NOT connect the unit using that original speaker wiring. If you do, the unit will be seriously damaged. Redo the speaker wiring so that you can connect the unit to the speakers as illustrated in Fig. 3.
 - If the speaker wiring in your car is as illustrated in Fig. 3, you can connect the unit using the original speaker wiring in your car.
 - If you are not sure of the speaker wiring of your car, consult your car dealer.

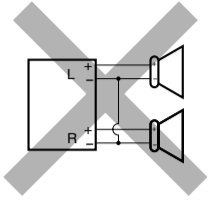

Fig. 1

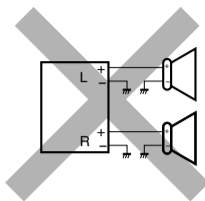

Fig. 2

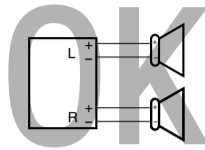

Fig. 3

ПРЕДОСТЕРЕЖЕНИЯ по питанию и подключению громкоговорителей:

- **НЕ** подключайте провода громкоговорителей к аккумулятору автомобиля, иначе устройство будет повреждено.
- Правильно подключите черный провод (земля), желтый провод (в аккумулятор, постоянный ток 12 В) и красный провод (в вспомогательный разъем).
- **ПЕРЕД** подключением проводов громкоговорителей к кабелю питания громкоговорителя проверьте схему соединений громкоговорителей в Вашем автомобиле.
 - Если проводка громкоговорителей в Вашем автомобиле такая, как показано на приводимых ниже Fig. 1 и Fig. 2, НЕ подключайте устройство с помощью первоначальной проводки громкоговорителей. Если Вы это сделаете, устройство будет серьезно повреждено. Переделайте проводку громкоговорителей так, чтобы Вы могли подключить устройство к громкоговорителям, как это показано на рис. 3.
 - Если проводка громкоговорителей в Вашем автомобиле такая, как показано на Fig. 3, Вы можете подключить устройство с помощью первоначальной проводки громкоговорителей в Вашем автомобиле.
 - Если Вы не знаете соединения громкоговорителей в Вашем автомобиле, обратитесь к Вашему автомобильному дилеру.

Connecting the leads / Подключение контактов

Twist the core wires when connecting.
Закрутите концы проводов при соединении.

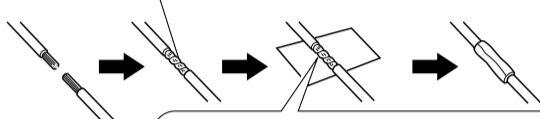

Solder the core wires to connect them securely.
Спаяйте провода для надежного соединения.

CAUTION / ПРЕДОСТЕРЕЖЕНИЕ:

- To prevent short-circuit, cover the terminals of the UNUSED leads with insulating tape.
- Для предотвращения короткого замыкания заклейте НЕИСПОЛЬЗУЕМЫЕ концы изолирующей лентой.

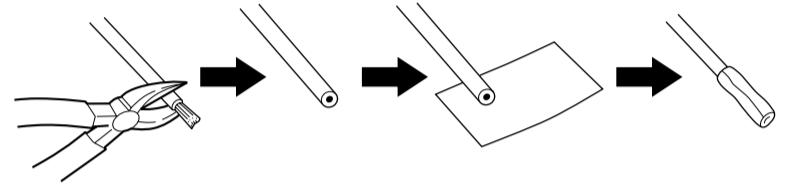

Connections Adding Other Equipment / Подключение других устройств

- You can connect an amplifier to upgrade your car stereo system.
- Connect the remote lead (blue with white stripe) to the remote lead of the other equipment so that it can be controlled through this unit.
 - Connect this unit's line-out terminals to the amplifier's line-in terminals.
 - **Disconnect the speakers from this unit, connect them to the amplifier. Leave the speaker leads of this unit unused.** (Cover the terminals of these unused leads with insulating tape, as illustrated above.)

- Для обновления автомобильной стереосистемы Вы можете подключить усилитель.
- Подсоедините провод внешнего устройства (синий с белой полосой) к проводу внешнего устройства другого оборудования так, чтобы им можно было управлять с этого устройства.
 - Подключите выходные клеммы данного устройства к входным клеммам усилителя.
 - **Отсоедините громкоговорители от данного устройства, подключите их к усилителю. Оставьте провода громкоговорителей данного устройства неиспользованными.** (Замотайте клеммы этих неиспользованных проводов изоляционной лентой, как показано выше.)

Amplifier / Усилитель

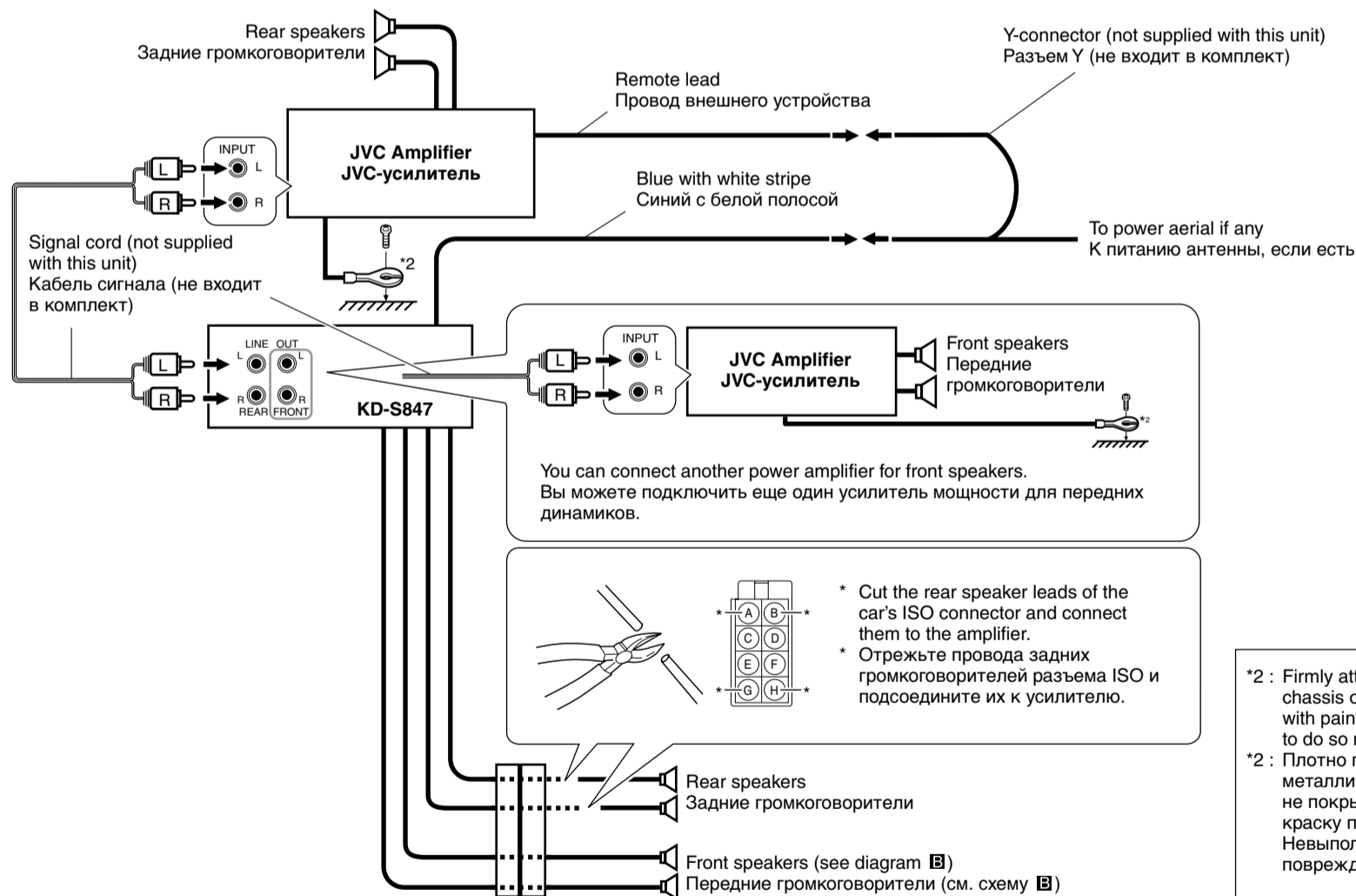

TROUBLESHOOTING

- **The fuse blows.**
 - * Are the red and black leads connected correctly?
- **Power cannot be turned on.**
 - * Is the yellow lead connected?
- **No sound from the speakers.**
 - * Is the speaker output lead short-circuited?
- **Sound is distorted.**
 - * Is the speaker output lead grounded?
 - * Are the "–" terminals of L and R speakers grounded in common?
- **Unit becomes hot.**
 - * Is the speaker output lead grounded?
 - * Are the "–" terminals of L and R speakers grounded in common?

ВЫЯВЛЕНИЕ НЕИСПРАВНОСТЕЙ

- **Сработал предохранитель.**
 - * Правильно ли подключены черный и красный провода?
- **Питание не включается.**
 - * Подключен ли желтый провод?
- **Звук не выводится через громкоговорители.**
 - * Нет ли короткого замыкания на кабеле выхода громкоговорителей?
- **Звук искажен.**
 - * Заземлен ли провод выхода громкоговорителей?
 - * Заземлены ли разъемы "–" правого (R) и левого (L) громкоговорителей?
- **Устройство нагревается.**
 - * Заземлен ли провод выхода громкоговорителей?
 - * Заземлены ли разъемы "–" правого (R) и левого (L) громкоговорителей?

Free Manuals Download Website

<http://myh66.com>

<http://usermanuals.us>

<http://www.somanuals.com>

<http://www.4manuals.cc>

<http://www.manual-lib.com>

<http://www.404manual.com>

<http://www.luxmanual.com>

<http://aubethermostatmanual.com>

Golf course search by state

<http://golfingnear.com>

Email search by domain

<http://emailbydomain.com>

Auto manuals search

<http://auto.somanuals.com>

TV manuals search

<http://tv.somanuals.com>