

# JVC



## CASSETTE RECEIVER

## KS-FX771

ENGLISH

## 卡座收音組合機

## KS-FX771

中文

## วิทยุเครื่องเล่นเทป

## KS-FX771

ไทย

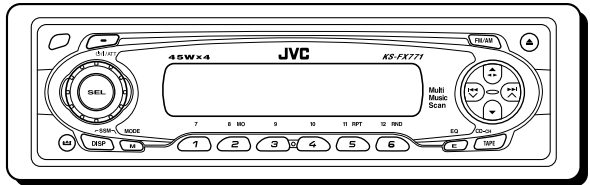
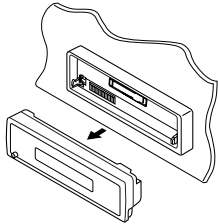

For installation and connections, refer to the separate manual.

有關安裝和連接方法，分別參閱操作手冊。

กรุณาดูคู่มือที่แยกต่างหาก ในการติดตั้งและการเชื่อมต่อ

## INSTRUCTIONS

### 使用說明書 คำแนะนำ

GET0139-001A

[U]

## How to reset your unit

After detaching the control panel, press the reset button on the panel holder using a ball-point pen or a similar tool.

This will reset the built-in microcomputer.

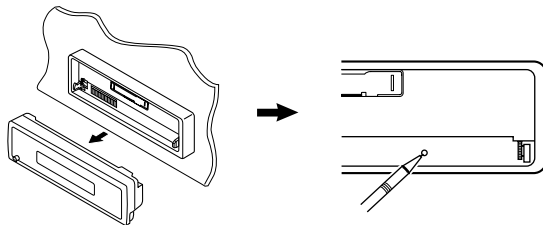

### Note:

Your preset adjustments—such as preset channels or sound adjustments—will also be erased.

## How to use the M (MODE) button

If you press M (MODE), the unit goes into functions mode, then the number buttons work as different function buttons.

- When connecting a JVC MP3-compatible CD changer: The ▲/▼ buttons will also work as +10/–10 buttons after pressing M (MODE).

Ex.: When number button 2 works as MO (monaural) button.

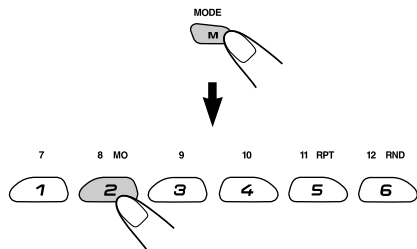

To use these buttons for original functions again after pressing M (MODE), wait for 5 seconds without pressing any of these buttons until the functions mode is cleared.

- Pressing M (MODE) again also clears the functions mode.

Thank you for purchasing a JVC product. Please read all instructions carefully before operation, to ensure your complete understanding and to obtain the best possible performance from the unit.

# CONTENTS

How to reset your unit .....	2	<b>SOUND ADJUSTMENTS .....</b>	<b>16</b>
How to use the M (MODE) button .....	2	Selecting preset sound modes	
<b>LOCATION OF THE BUTTONS .....</b>	<b>4</b>	(C-EQ: custom equalizer) .....	16
Control panel .....	4	Adjusting the sound .....	17
Remote controller .....	5	<b>OTHER MAIN FUNCTIONS .....</b>	<b>18</b>
Preparing the remote controller .....	6	Changing the general settings (PSM) .....	18
<b>BASIC OPERATIONS .....</b>	<b>7</b>	Detaching the control panel .....	20
Turning on the power .....	7	<b>CD CHANGER OPERATIONS .....</b>	<b>21</b>
Setting the clock .....	8	Playing discs .....	21
<b>RADIO OPERATIONS .....</b>	<b>9</b>	Selecting the playback modes .....	24
Listening to the radio .....	9	<b>EXTERNAL COMPONENT OPERATIONS ...</b>	<b>25</b>
Storing stations in memory .....	11	Playing an external component .....	25
Tuning in to a preset station .....	12	<b>TROUBLESHOOTING .....</b>	<b>26</b>
<b>TAPE OPERATIONS .....</b>	<b>13</b>	<b>MAINTENANCE .....</b>	<b>28</b>
Listening to a cassette .....	13	<b>SPECIFICATIONS .....</b>	<b>29</b>
Finding the beginning of a tune .....	14		
Other convenient tape functions .....	14		

**BEFORE USE**

**\*For safety...**

- Do not raise the volume level too much, as this will block outside sounds, making driving dangerous.
- Stop the car before performing any complicated operations.

**\*Temperature inside the car...**

If you have parked the car for a long time in hot or cold weather, wait until the temperature in the car becomes normal before operating the unit.



# LOCATION OF THE BUTTONS

ENGLISH

## Control panel

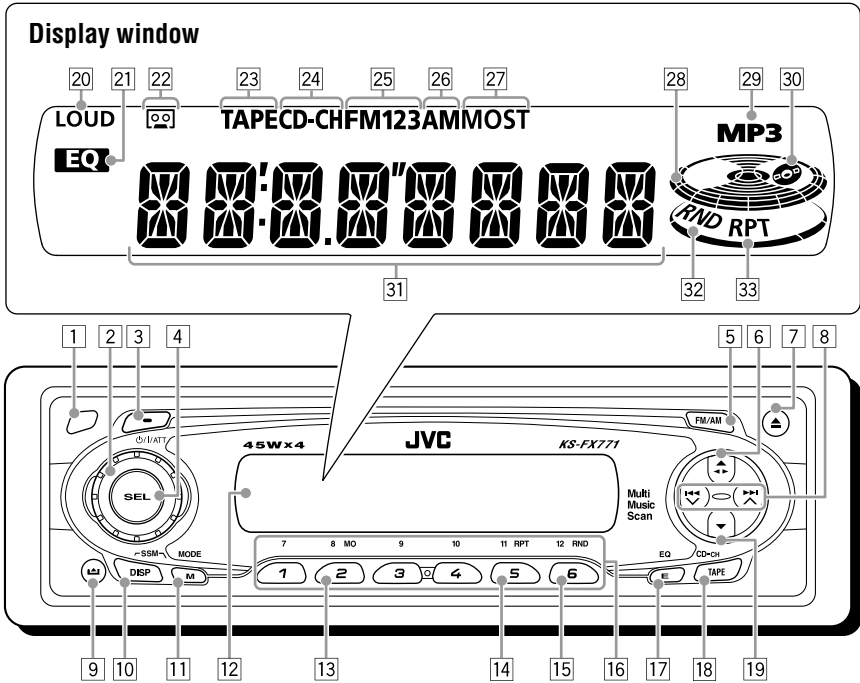

- 1 Remote sensor
- 2 Control dial
- 3  $\phi$ /I/ATT (standby/on/attenuator) button
- 4 SEL (select) button
- 5 FM/AM button
- 6  $\blacktriangle$  (up) button
- 7  $\blacktriangleleft$  (tape direction) button
- 8  $\blacktriangle$  (eject) button
- 9  $\blacktriangleleft$   $\blacktriangleright$  (control panel release) button
- 10 DISP (display) button
  - Also functions as SSM buttons when pressed together with M (MODE) button.
- 11 M (MODE) button
  - Also functions as SSM buttons when pressed together with DISP (display) button.
- 12 Display window
- 13 MO (monaural) button
- 14 RPT (repeat) button
- 15 RND (random) button
- 16 Number buttons
- 17 E (EQ: equalizer) button
- 18 TAPE (CD-CH: CD changer) button

- 19  $\blacktriangledown$  (down) button

### Display window

- 20 LOUD (loudness) indicator
- 21 EQ (equalizer) indicator
- 22  $\square$  (tape-in) indicator
- 23 TAPE indicator
- 24 CD-CH (CD changer) indicator
- 25 FM band indicators (FM1, FM2, FM3)
- 26 AM band indicator
- 27 Tuner reception indicators  
MO (monaural), ST (stereo)
- 28 Volume (or audio) level indicator
- 29 MP3 indicator
  - Lights up only when playing an MP3 disc on a JVC MP3-compatible CD changer.
- 30  $\text{CD}$  (disc) indicator
  - Lights up only when connecting to a CD changer.
- 31 Main display
- 32 RND (random) indicator
  - Lights up only when a disc is randomly played on a CD changer.
- 33 RPT (repeat) indicator



## Remote controller

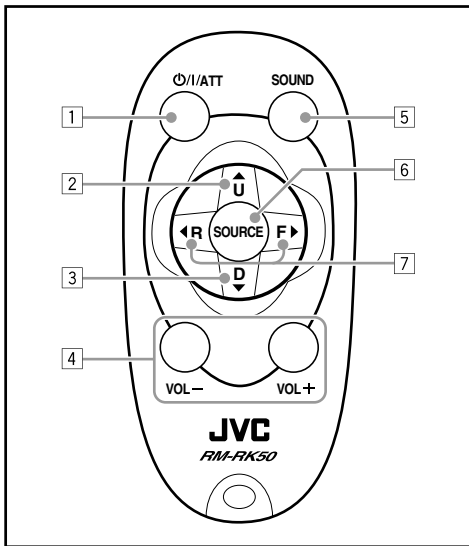

- 1 • Turns on the unit if pressed when the unit is turned off.

  - Turns off the unit if pressed and held until “SEE YOU” appears on the display.
  - Drops the volume level in a moment if pressed briefly.  
Press again to resume the volume.
- 2 • Selects the band while listening to the radio. Each time you press the button, the band changes.

  - Changes the tape direction while listening to a cassette.  
Each time you press the button, the tape direction changes alternately.
  - While playing an MP3 disc on an MP3-compatible CD changer;
    - Skips to the next disc if pressed briefly.
    - Skips to the next folder if pressed and held.

**Note:** While playing a CD on a CD changer; this always skips to the next disc.
- 3 • Selects the preset stations while listening to the radio.  
Each time you press the button, the preset station number increases, and the selected station is tuned in.

  - While playing an MP3 disc on an MP3-compatible CD changer;
    - Skips to the previous disc if pressed briefly.
    - Skips to the previous folder if pressed and held.

**Note:** While playing a CD on a CD changer; this always skips to the previous disc.
- 4 Functions the same as the control dial on the main unit.

**Note:** These buttons do not function for the preferred setting mode adjustment.
- 5 Selects the sound mode (C-EQ: custom equalizer).  
Each time you press the button, the sound mode (C-EQ) changes.
- 6 Selects the source.  
Each time you press the button, the source changes.
- 7 • Searches for stations while listening to the radio.

  - Functions as the fast-forward or rewind buttons if pressed and held while listening to a cassette.  
To release this operation, press button 2 to resume playback.
  - Functions as Multi Music Scan buttons if pressed while listening to a cassette.  
To release this operation, press button 2 to resume playback.
  - Fast-forwards or reverses the track/file if pressed and held while listening to the CD changer.
  - Skips to the beginning of the next track/file or goes back to the beginning of the current (or previous) tracks/files if pressed briefly while listening to the CD changer.

## Preparing the remote controller

Before using the remote controller:

- Aim the remote controller directly at the remote sensor on the main unit. Make sure there is no obstacle in between.

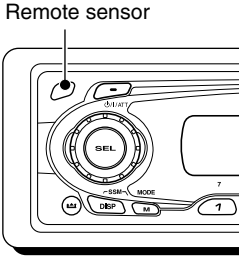

- Do not expose the remote sensor to strong light (direct sunlight or artificial lighting).

### Installing the battery

When the controllable range or effectiveness of the remote controller decreases, replace the battery.

#### 1. Remove the battery holder.

- 1) Push out the battery holder in the direction indicated by the arrow using a ball-point pen or a similar tool.
- 2) Remove the battery holder.

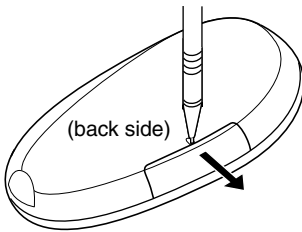

#### 2. Place the battery.

Slide the battery into the holder with the + side facing upwards so that the battery is fixed in the holder.

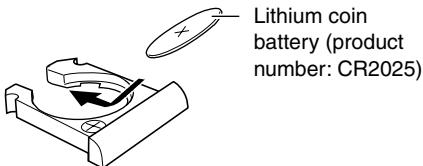

#### 3. Return the battery holder.

Insert again the battery holder by pushing it until you hear a clicking sound.

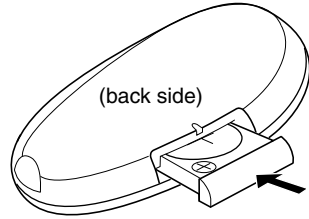

#### WARNING:

- Store the battery in a place where children cannot reach.  
*If a child accidentally swallows the battery, consult a doctor immediately.*
- Do not recharge, short, disassemble, or heat the battery or dispose of it in a fire.  
*Doing any of these things may cause the battery to give off heat, crack, or start a fire.*
- Do not leave the battery with other metallic materials.  
*Doing this may cause the battery to give off heat, crack, or start a fire.*
- When throwing away or saving the battery, wrap it in tape and insulate; otherwise, the battery may start to give off heat, crack, or start a fire.
- Do not poke the battery with tweezers or similar tools.  
*Doing this may cause the battery to give off heat, crack, or start a fire.*

#### CAUTION:

*DO NOT leave the remote controller in a place (such as dashboards) exposed to direct sunlight for a long time. Otherwise, it may be damaged.*

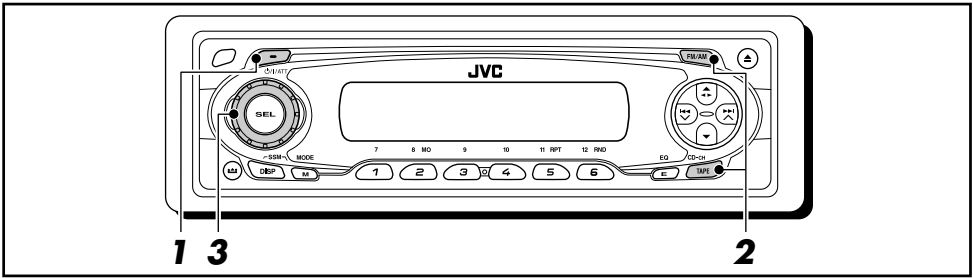

## Turning on the power

### 1 Turn on the power.



#### Note on One-Touch Operation:

When you select a source in step 2 below, the power automatically comes on. You do not have to press this button to turn on the power.

### 2 Select the source.



To operate the tuner (FM or AM), see pages 9 – 12.

To play a tape, see pages 13 – 15.

To operate the CD changer, see pages 21 – 24.

To operate the external component (LINE IN), see page 25.

### 3 Adjust the volume.

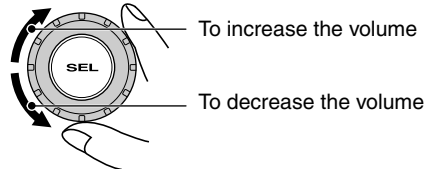

Volume (or audio) level indicator (see page 19)

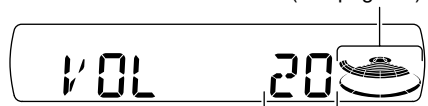

Volume level appears.

### 4 Adjust the sound as you want. (See pages 16 and 17.)

#### To drop the volume in a moment

Press  $\phi$ /I/ATT briefly while listening to any source. "ATT" starts flashing on the display, and the volume level will drop in a moment. To resume the previous volume level, press the button briefly again.

- If you turn the control dial, you can also restore the sound.

#### To turn off the power

Press and hold  $\phi$ /I/ATT for more than one second.

"SEE YOU" appears, then the unit turns off.

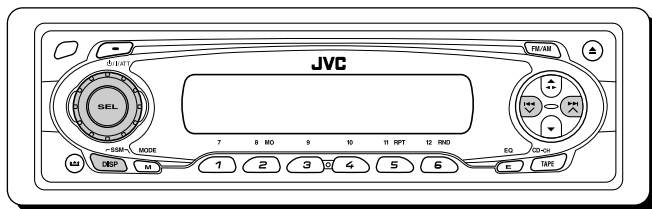

## Setting the clock

- 1** Press and hold SEL (select) for more than 2 seconds so that one of the PSM items appears on the display. (PSM: see page 19.)



- 2** Set the hour.

- 1 Select "CLOCK H" (hour) if not shown on the display.
- 2 Adjust the hour.

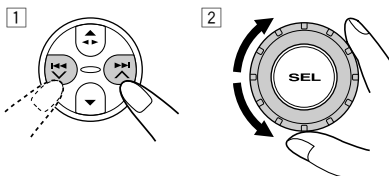

- 3** Set the minute.

- 1 Select "CLOCK M" (minute).
- 2 Adjust the minute.

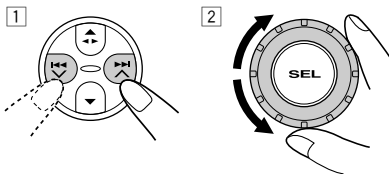

- 4** Finish the setting.



To check the current clock time or change the display mode

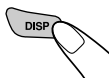

Press DISP (display) repeatedly. Each time you press the button, the display mode changes as follows:

- During tuner operation:

Frequency ↔ Clock

- During tape operation:

Play mode (TAPE) ↔ Clock

- During CD changer operation:



- During power off:

The power turns on and the clock time is shown for about 5 seconds, then the power turns off.



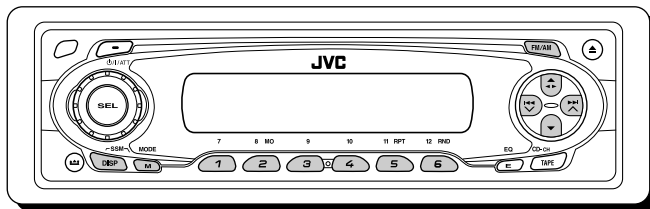

## Listening to the radio

You can use either automatic searching or manual searching to tune in to a particular station.

### Searching a station automatically: Auto search

#### 1 Select the band (FM1 – 3, AM).



Each time you press the button, the band changes as follows:

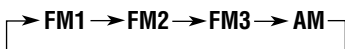

Selected band appears.

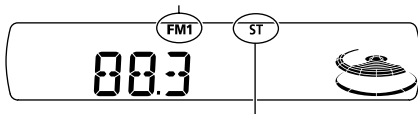

Lights up when receiving an FM stereo broadcast with sufficient signal strength.

**Note:**

*This receiver has three FM bands (FM1, FM2, FM3). You can use any one of them to listen to an FM broadcast.*

#### 2 Start searching a station.

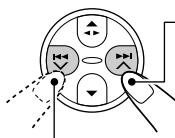

To search stations of higher frequencies

To search stations of lower frequencies

When a station is received, searching stops.

**To stop searching before a station is received,** press the same button you have pressed for searching.



## Searching a station manually: Manual search

### 1 Select the band (FM1 – 3, AM).

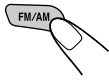

Each time you press the button, the band changes as follows:

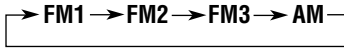

**Note:**

This receiver has three FM bands (FM1, FM2, FM3). You can use any one of them to listen to an FM broadcast.

### 2 Press and hold ►► | ▲ or ◀◀ | ▼ until “M” (manual) starts flashing on the display.

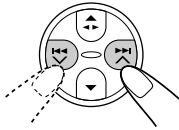

### 3 Tune in to a station you want while “M” (manual) is flashing.

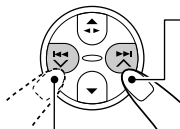

To tune in to stations of higher frequencies

To tune in to stations of lower frequencies

- If you release your finger from the button, the manual mode will automatically turns off after 5 seconds.
- If you hold down the button, the frequency keeps changing (in 50 kHz intervals for FM and 9 kHz intervals for AM) until you release the button.

## When an FM stereo broadcast is hard to receive:

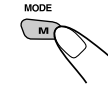

1 Press M (MODE) to enter the functions mode while listening to an FM stereo broadcast.

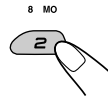

2 Press MO (monaural), while still in the functions mode, so that the MO indicator lights up on the display.

Each time you press the button, the MO indicator lights up and goes off alternately.

MO (monaural) indicator



When the MO indicator is lit on the display, the sound you hear becomes monaural but the reception will be improved.

## Storing stations in memory

You can use one of the following two methods to store broadcasting stations in memory.

- Automatic preset of FM stations: SSM (Strong-station Sequential Memory)
- Manual preset of both FM and AM stations

### FM station automatic preset: SSM

You can preset 6 local FM stations in each FM band (FM1, FM2, and FM3).

#### 1 Select the FM band (FM1 – 3) you want to store FM stations into.



Each time you press the button, the band changes as follows:

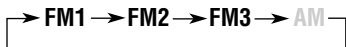

#### 2 Press and hold both buttons for more than 2 seconds.

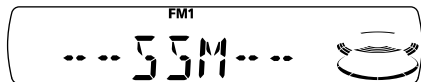
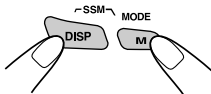

"- SSM -" appears, then disappears when automatic preset is over.

Local FM stations with the strongest signals are searched and stored automatically in the band number you have selected (FM1, FM2, or FM3). These stations are preset in the number buttons—No.1 (lowest frequency) to No.6 (highest frequency).

When automatic preset is over, the station stored in number button 1 will be automatically tuned in.

## Manual preset

You can preset up to 6 stations in each band (FM1, FM2, FM3, and AM) manually.

Ex.: Storing FM station of 92.5 MHz into the preset number 1 of the FM1 band.

#### 1 Select the band (FM1 – 3, AM) you want to store stations into (in this example, FM1).



Each time you press the button, the band changes as follows:

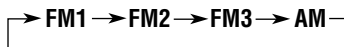

#### 2 Tune in to a station (in this example, of 92.5 MHz).

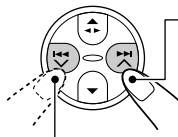

To tune in to stations of higher frequencies

To tune in to stations of lower frequencies

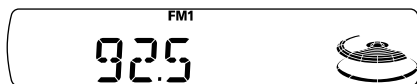



- 3** Press and hold the number button (in this example, 1) for more than 2 seconds.

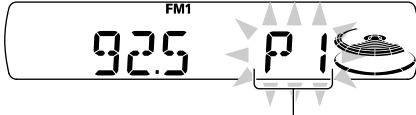
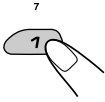

"P1" flashes for a few seconds.

- 4** Repeat the above procedure to store other stations into other preset numbers.

**Notes:**

- A previously preset station is erased when a new station is stored in the same preset number.
- Preset stations are erased when the power supply to the memory circuit is interrupted (for example, during battery replacement). If this occurs, preset the stations again.

## Tuning in to a preset station

You can easily tune in to a preset station. Remember that you must store stations first. If you have not stored them yet, see "Storing stations in memory" on pages 11 and 12.

- 1** Select the band (FM1 – 3, AM).

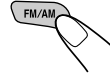

Each time you press the button, the band changes as follows:

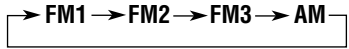

- 2** Select the number (1 – 6) for the preset station you want.

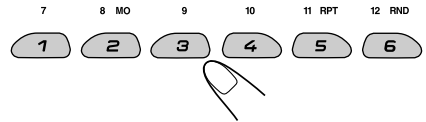

**Note:**

You can also use the ▲ (up) or ▼ (down) button on the unit to select the next or previous preset stations. Each time you press the ▲ (up) or ▼ (down) button, the next or previous preset station is tuned in.

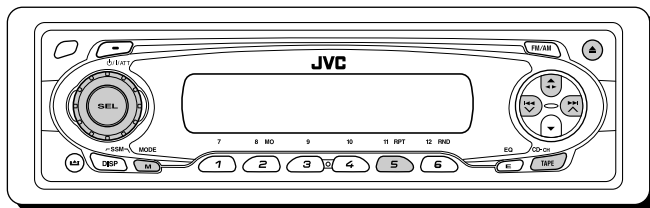

## Listening to a cassette

You can play back type I (normal) tapes.

### 1 Open the control panel.

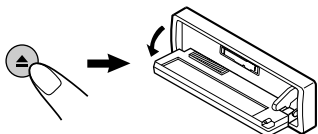

#### Note on One-Touch Operation:

When a cassette is already in the cassette compartment, pressing TAPE (CD-CH) turns on the unit and starts tape play automatically.

### 2 Insert a cassette into the cassette compartment.

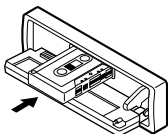

The unit turns on and tape play starts automatically.

### 3 Close the control panel by hand.

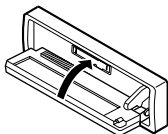

### 4 Select the tape direction.

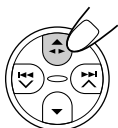

Each time you press ◀▶, the tape direction alternates between forward (TAPE ▶▶▶) and reverse (TAPE ◀◀◀).

### To stop play and eject the cassette

Press ▲.

Tape play stops, the control panel flips down. The cassette automatically ejects from the cassette compartment. The source changes to the previously selected one.

If you change the source, tape play also stops (without ejecting the cassette this time).

- You can also eject the cassette by pressing ▲ while the unit is turned off.

### To fast-forward and rewind a tape

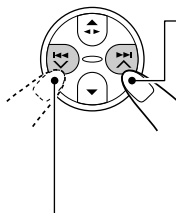

Press and hold ▶▶▶ ▲ for more than one second to fast-forward the tape.

When the tape reaches its end, the tape is reversed and playback starts from the beginning of the other side.

Press and hold ◀◀◀ ▼ for more than one second to rewind the tape.

When the tape reaches its end, playback of the same side starts.

### To stop fast-forward and rewind at any position on the tape, press ◀▶.

Tape play starts from that position on the tape.

#### Notes:

- When one side of the tape reaches its end during play, the other side of the tape automatically starts playing. (Auto Reverse)
- When the tape reaches its end while fast-forwarding, the tape direction will be changed automatically.

## Finding the beginning of a tune

Multi Music Scan (MMS) allows you to automatically start playback from the beginning of a specified tune. You can specify up to 9 tunes ahead of or before the current tune.

### During playback

**Specify the tune you want to locate (how many tunes ahead of or before the current tune).**

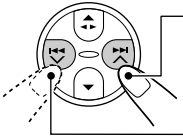

Press ►► ▲ to locate a tune ahead of the current tune on the cassette.

Press ◀◀ ▼ to locate a tune before the current tune on the cassette.



Ex.: When you locate three tunes ahead of the current tune

Each time you press the buttons, the number changes up to  $\pm 9$ .

When the beginning of the specified tune is located, playback starts automatically.

### Notes:

- While locating a specified tune:
  - If the tape is rewound to its beginning, playback starts from the beginning of that side.
  - If the tape is fast-forwarded to the end, it is reversed and played from the beginning of the other side.
- In the following cases, the Multi Music Scan function may not operate correctly:
  - Tapes with tunes having long pianissimo passages (very quiet parts) or non-recorded portions between tunes.
  - Tapes with short non-recorded sections.
  - Tapes with high level of noise or humming between tunes.
  - Tapes with tunes recorded at low recording levels.

## Other convenient tape functions

### Skipping the blank portions on the tape

You can skip blank portions between the tunes (Blank Skip).

When this function is turned on, the unit fast-forwards (skipping blank portions of 15 seconds or more), to the next tune and starts playback.

- See also “Changing the general settings (PSM)” on page 18.

- 1 Press and hold SEL (select) for more than 2 seconds so that one of the PSM items appears on the display. (PSM: see page 19.)**



- 2 Press ►► ▲ or ◀◀ ▼ to select “B.SKIP” (blank skip).**

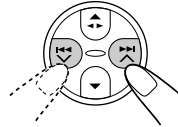

- 3 Turn the control dial clockwise to select “ON.”**

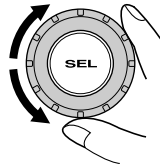

Now Blank Skip is activated.

- 4 Finish the setting.**



**To cancel Blank Skip,** repeat the same procedure and select “OFF” in step **3** by turning the control dial counterclockwise.



## Playing the current tune repeatedly

You can play the current tune repeatedly (Repeat Play).



**1** Press M (MODE) to enter the functions mode while playing a tune you want to hear over again on a cassette.

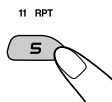

**2** Press RPT (repeat), while still in the functions mode, so that "REPEAT" appears on the display.

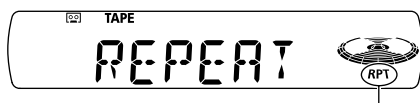

Lights up when Repeat Play is turned on.

When the tune has been played, the tape is automatically rewound to the beginning of that tune and the same tune will be played again.

To cancel Repeat Play, repeat steps 1 and 2 again so that the RPT indicator goes off.

### Note:

In the following cases, Blank Skip and Repeat Play may not operate correctly:

- Tapes with tunes having long pianissimo passages (very quiet parts) or non-recorded portions during tunes.
- Tapes with short non-recorded sections.
- Tapes with high level noise or humming between tunes.
- Tapes with tunes recorded at low recording levels.

## Prohibiting cassette ejection

You can prohibit cassette ejection and lock a cassette in the cassette compartment.

While pressing TAPE (CD-CH), press and hold for more than 2 seconds.

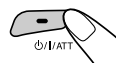
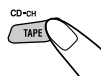

"NO EJECT" flashes on the display for about 5 seconds, and the cassette is locked and cannot be ejected.



To cancel the prohibition and unlock the cassette

While pressing TAPE (CD-CH), press and hold again for more than 2 seconds. "EJECT OK" flashes on the display for about 5 seconds, and the cassette is unlocked.



### Note:

If you press while cassette ejection is prohibited, the control panel flips down, but the cassette continues to play and cannot be ejected.



# SOUND ADJUSTMENTS

## Selecting preset sound modes (C-EQ: custom equalizer)

You can select a preset sound mode (C-EQ: custom equalizer) suitable to the music genre.

### Select the sound mode you want.



When you press the button once, the last selected sound mode is recalled and applied to the current source.



Ex.: If you have selected "USER" previously



Then, each time you press the button, the sound modes change as follows:



The EQ indicator lights up when any sound mode other than "USER" is selected.

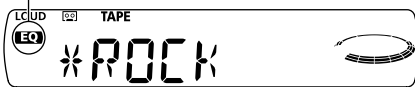

Ex.: When you select "ROCK"

Indication	For:	Preset values		
		BAS	TRE	LOUD
USER	(Flat sound)	00	00	OFF
ROCK	Rock or disco music	+03	+01	ON
CLASSIC	Classical music	+01	-02	OFF
POPS	Light music	+04	+01	OFF
HIP HOP	Funk or rap music	+02	00	ON
JAZZ	Jazz music	+02	+03	OFF

### Note:

You can adjust each sound mode to your preference. Once you make an adjustment, it is automatically stored for the currently selected sound mode. See "Adjusting the sound" on page 17.





# Adjusting the sound

You can adjust the sound characteristics to your preference.

## 1 Select the item you want to adjust.



Each time you press the button, the adjustable items change as follows:

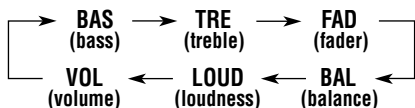

## 2 Adjust the setting.

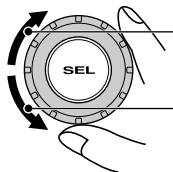

To increase the level or turn on the loudness

To decrease the level or turn off the loudness

Equalization pattern changes as you adjust the bass or treble.

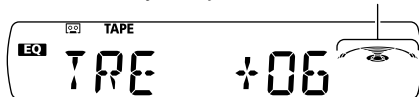

Ex. 1: When you adjust "TRE" (treble)



Ex. 2: When you turn on the loudness

## 3 Repeat steps 1 and 2 to adjust the other items.

To reset each sound mode to the factory settings, repeat the same procedure and reassign the preset values listed in the table on page 16.

Indication	To do:	Range
BAS* <sup>1</sup>	Adjust the bass.	-06 (min.)   +06 (max.)
TRE* <sup>1</sup>	Adjust the treble.	-06 (min.)   +06 (max.)
FAD* <sup>2</sup>	Adjust the front and rear speaker balance.	R06 (Rear only)   F06 (Front only)
BAL	Adjust the left and right speaker balance.	L06 (Left only)   R06 (Right only)
LOUD* <sup>1</sup>	Boost low and high frequencies to produce a well-balanced sound at low volume level.	LOUD ON   LOUD OFF
VOL* <sup>3</sup>	Adjust the volume.	00 (min.)   50 (max.)

\*<sup>1</sup> When you adjust the bass, treble, or loudness, the adjustment you have made is stored for the currently selected sound mode (C-EQ) including "USER."

\*<sup>2</sup> If you are using a two-speaker system, set the fader level to "00."

\*<sup>3</sup> Normally the control dial works as the volume control. So you do not have to select "VOL" to adjust the volume level.



# OTHER MAIN FUNCTIONS

## Changing the general settings (PSM)

You can change the items listed in the table on page 19 by using the PSM (Preferred Setting Mode) control.

### Basic Procedure

- 1** Press and hold SEL (select) for more than 2 seconds so that one of the PSM items appears on the display. (See page 19.)



Ex.: If you have selected "CLOCK H" previously

- 2** Select the PSM item you want to adjust. (See page 19.)



Ex.: When you select "LEVEL"

- 3** Adjust the PSM item selected.

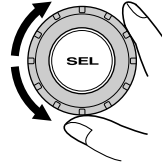

Ex.: When you select "AUDIO 2"

- 4** Repeat steps 2 and 3 to adjust the other PSM items if necessary.

- 5** Finish the setting.





## Preferred Setting Mode (PSM) items

- For detailed operations of each PSM items, refer to the pages listed in the table.

Indications		Selectable values/items		Factory-preset settings	See page
<b>CLOCK H</b>	Hour adjustment	1 – 12		1 (1:00)	8
<b>CLOCK M</b>	Minute adjustment	00 – 59		00 (1:00)	
<b>LEVEL</b>	Level meter	AUDIO 1 ↔ AUDIO 2 ↕                      ↕ OFF		AUDIO 2	19
<b>B.SKIP</b>	Blank skip	OFF	ON	OFF	14
<b>EXT IN*</b>	External component	CHANGER	LINE IN	CHANGER	19

\* Displayed only when one of the following sources is selected—FM, AM, and TAPE.

### To select the level meter—LEVEL

You can select the level meter display according to your preference.

When shipped from the factory, “AUDIO 2” is selected.

- **AUDIO 1:** Shows the audio level indicator.
- **AUDIO 2:** Alternates “AUDIO 1” setting and illumination display.
- **OFF:** Erases the audio level indicator.

### To select the external component to use —EXT IN

You can connect the external component to the CD changer jack on the rear using the Line Input Adapter KS-U57 (not supplied).

To use the external component as the playback source through this unit, you need to select which component—CD changer or external component—to use.

When shipped from the factory, CD changer is selected as the external component.

- **CHANGER:** To use the CD changer.
- **LINE IN:** To use the external component other than CD changer.

#### **Note:**

*For connecting the Line Input Adapter KS-U57 and the external component, refer to the Installation/Connection Manual (separate volume).*



## Detaching the control panel

You can detach the control panel when leaving the car.

When detaching or attaching the control panel, be careful not to damage the connectors on the back of the control panel and on the panel holder.

### Detaching the control panel

Before detaching the control panel, be sure to turn off the power.

#### 1 Unlock the control panel.

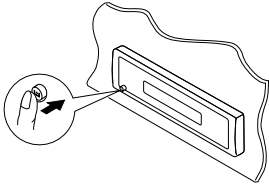

#### 2 Pull the control panel out of the unit.

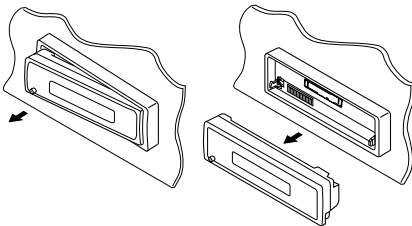

#### 3 Put the detached control panel into the provided case.

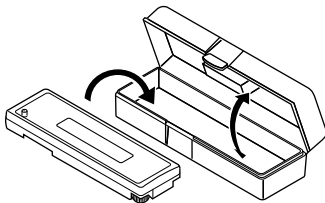

## Attaching the control panel

#### 1 Insert the right side of the control panel into the groove on the panel holder.

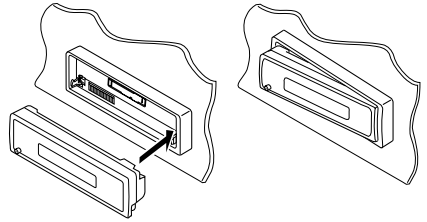

#### 2 Press the left side of the control panel to fix it to the panel holder.

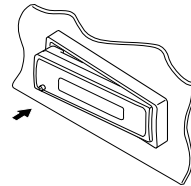

#### Note on cleaning the connectors:

If you frequently detach the control panel, the connectors will deteriorate.

To minimize this possibility, periodically wipe the connectors with a cotton swab or cloth moistened with alcohol, being careful not to damage the connectors.

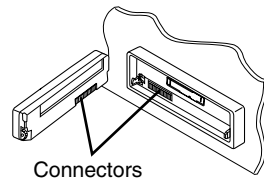

# CD CHANGER OPERATIONS

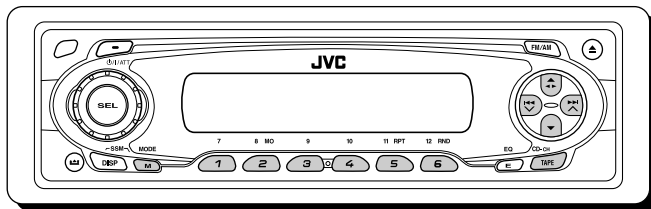

We recommend that you use the JVC MP3-compatible CD changer with your unit.

By using this CD changer, you can play back your original CD-Rs (Recordable) and CD-RWs (Rewritable) recorded either in audio CD format or in MP3 format.

- You can also connect other CH-X series CD changers (except CH-X99 and CH-X100). However, they are not compatible with MP3 discs, so you cannot play back MP3 discs.
- You cannot use the KD-MK series CD changers with this unit.

Before operating your CD changer:

- Refer also to the Instructions supplied with your CD changer.
- If no discs are in the magazine of the CD changer or the discs are inserted upside down, "NO CD" will appear on the display. If this happens, remove the magazine and set the discs correctly.
- If no magazine is loaded in the CD changer, "NO MAG" appears on the display. If this happens, insert the magazine in the CD changer.
- If "RESET 1" – "RESET 8" appears on the display, something is wrong with the connection between this unit and the CD changer. If this happens, check the connection and make sure the cords are connected firmly. Then, press the reset button of the CD changer.

## Playing discs

Select the CD changer (CD-CH).



- \* If you have not connected a CD changer, or if you have changed the "EXT IN" setting to "LINE IN" (see page 19), you cannot select the CD changer.

• **When the current disc is an MP3 disc:**

Playback starts from the first folder of the current disc once file check is completed.

MP3 indicator lights up.

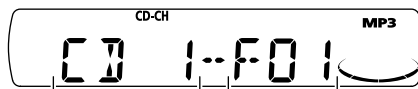
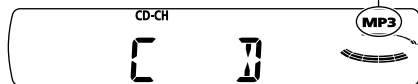

Disc number      Folder number

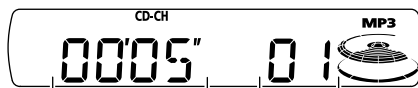

Elapsed playing time      File number

- **When the current disc is a CD:**  
Playback starts from the first track of the current disc.

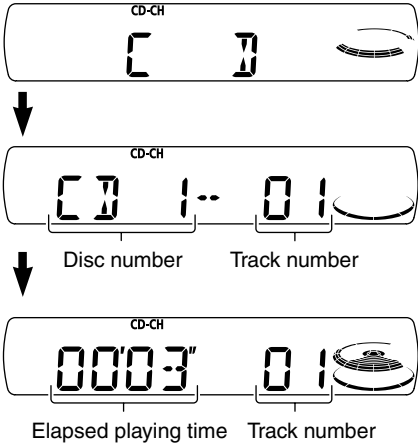

**Notes:**

- When you press TAPE (CD-CH), the power automatically comes on. You do not have to press  $\text{P}$ /ATT to turn on the power.
- If you change the source, CD changer play also stops. Next time you select the CD changer as the source, CD changer play starts from where playback has been stopped previously.

**To fast-forward or reverse the track/file**

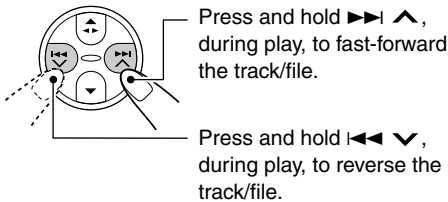

**To go to the next or previous tracks/files**

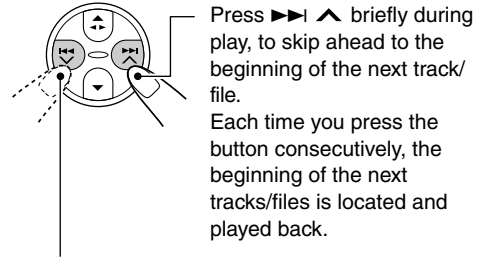

Press  $\text{RR}$   $\text{v}$  briefly during play, to skip back to the beginning of the current track/file. Each time you press the button consecutively, the beginning of the previous tracks/files is located and played back.

**To go to a particular disc directly**

Press the number button corresponding to the disc number to start its playback (while the CD changer is playing).

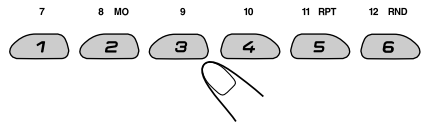

- To select a disc number from 1 – 6:  
Press 1 (7) – 6 (12) briefly.
- To select a disc number from 7 – 12:  
Press and hold 1 (7) – 6 (12) for more than one second.

**This operation is only possible when using JVC MP3-compatible CD changer (CH-X1500).**

## To go to a track/file quickly

**1** Press M (MODE) to enter the functions mode while playing a disc.



**2** Press ▲ (up) or ▼ (down).

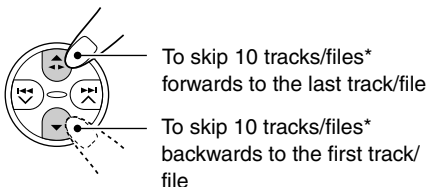

\* The first time you press ▲ or ▼ button, the track/file skips to the nearest higher or lower track with a track/file number of multiple ten (ex. 10th, 20th, 30th).

Then each time you press the button, you can skip 10 tracks/files (see "How to go to the desired track/file quickly" on the right column).

- After the last track/file, the first track/file will be selected, and vice versa.

### Note:

*If the current playing disc is an MP3 disc, files are skipped within the same folder.*

## How to go to the desired track/file quickly

- Ex. 1: To select track/file number 32 while playing track/file number 6

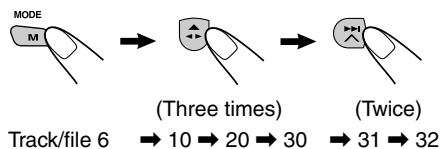

- Ex. 2: To select track/file number 8 while playing track/file number 36

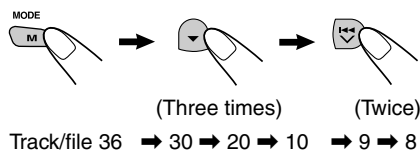

## To skip to the next or previous folder (only for MP3 discs)

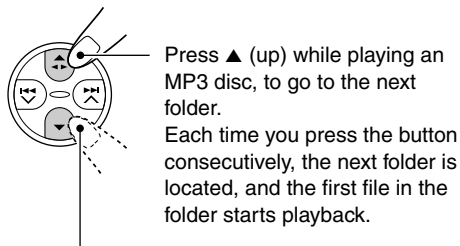

Press ▼ (down) while playing an MP3 disc, to go to the previous folder.

Each time you press the button consecutively, the previous folder is located, and the first file in the folder starts playback.



# Selecting the playback modes

## To play back tracks/files at random (Disc Random/Magazine Random Play)

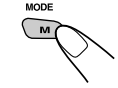

1 Press M (MODE) to enter the functions mode during play.

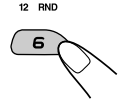

2 Press RND (random), while still in the functions mode, so that "DISC RND" or "MAG RND" appears on the display. Each time you press the button, the random play mode changes as follows:

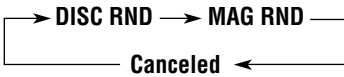

and RND indicators light up.

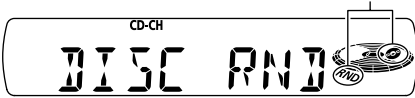

Ex.: When you select "DISC RND"

**Note:**

MP3 indicator also lights up if the current playing disc is an MP3 disc.

Mode	Active indicator	Plays at random
DISC RND	MP3 and RND indicators light up.	All tracks/files of the current (or specified) disc.
MAG RND	RND indicator lights up.	All tracks/files of the inserted discs.

## To play back tracks/files repeatedly (Track Repeat/Disc Repeat Play)

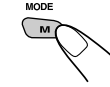

1 Press M (MODE) to enter the functions mode during play.

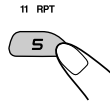

2 Press RPT (repeat), while still in the functions mode, so that "TRK RPT" or "DISC RPT" appears on the display. Each time you press the button, the repeat play mode changes as follows:

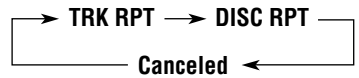

RPT indicator lights up.



Ex.: When you select "TRK RPT"

**Note:**

MP3 indicator also lights up if the current playing disc is an MP3 disc.

Mode	Active indicator	Plays repeatedly
TRK RPT	RPT indicator lights up.	The current (or specified) track/file.
DISC RPT	MP3 and RPT indicators light up.	All tracks/files of the current (or specified) disc.



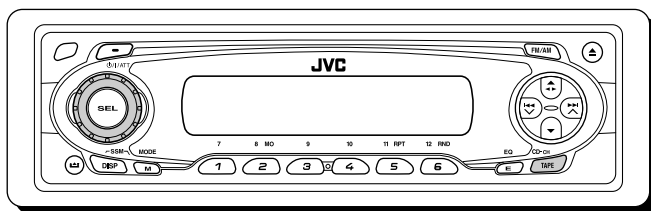

## Playing an external component

You can connect the external component to the CD changer jack on the rear using the Line Input Adapter KS-U57 (not supplied).

### Preparations:

- For connecting the Line Input Adapter KS-U57 and the external component, refer to the Installation/ Connection Manual (separate volume).
- Before operating the external component using the following procedure, select the external input correctly. See "To select the external component to use—EXT IN" on page 19.

**2** Turn on the connected component and start playing the source.

**3** Adjust the volume.

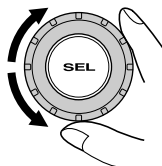

**4** Adjust the sound characteristics you want. (See pages 16 and 17.)

**1** Select the external component (LINE IN).

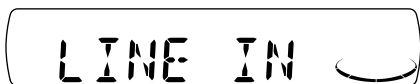

- If "LINE IN"\* does not appear on the display, see page 19 and select the external input ("LINE IN").

\* Displayed only when one of the following sources is selected—FM, AM, and TAPE.

### Note on One-Touch Operation:

When you press TAPE (CD-CH), the power automatically comes on. You do not have to press /ATT to turn on the power.



# TROUBLESHOOTING

What appears to be trouble is not always serious. Check the following points before calling a service center.

	Symptoms	Causes	Remedies
General	<ul style="list-style-type: none"> <li>• Sound cannot be heard from the speakers.</li> </ul>	The volume level is set to the minimum level.	Adjust it to the optimum level.
		Connections are incorrect.	Check the cords and connections.
	<ul style="list-style-type: none"> <li>• This unit does not work at all.</li> </ul>	The built-in microcomputer may have functioned incorrectly due to noise, etc.	Press the reset button on the panel holder after detaching the control panel. (The clock setting and preset stations stored in memory are erased.) (See page 2.)
FM/AM	<ul style="list-style-type: none"> <li>• SSM (Strong-station Sequential Memory) automatic preset does not work.</li> </ul>	Signals are too weak.	Store stations manually.
	<ul style="list-style-type: none"> <li>• Static noise while listening to the radio.</li> </ul>	The antenna is not connected firmly.	Connect the antenna firmly.
Tape Playback	<ul style="list-style-type: none"> <li>• A cassette tape cannot be ejected.</li> </ul>	Cassette is locked.	Unlock the cassette. (See page 15.)
	<ul style="list-style-type: none"> <li>• A cassette tape cannot be inserted.</li> </ul>	You have tried to insert a cassette in the wrong way.	Insert the cassette with the exposed tape facing right.
	<ul style="list-style-type: none"> <li>• Cassette tapes become hot.</li> </ul>	This is not a malfunction.	_____
	<ul style="list-style-type: none"> <li>• Tape sound is at very low level and sound quality is degraded.</li> </ul>	The tape head is dirty.	Clean it with a head cleaning tape.



Symptoms	Causes	Remedies
<ul style="list-style-type: none"> <li>• “NO CD” appears on the display.</li> </ul>	No disc is in the magazine.	Insert discs into the magazine.
	Discs are inserted upside down.	Insert discs correctly.
	Discs are unplayable.	Insert playable discs.
	The current disc does not contain any MP3 files.	Insert a disc that contains MP3 files.
<ul style="list-style-type: none"> <li>• “NO MAG” appears on the display.</li> </ul>	No magazine is loaded in the CD changer.	Insert the magazine.
<ul style="list-style-type: none"> <li>• MP3 disc is skipped or cannot be played back.</li> </ul>	MP3 files do not have the extension code—mp3 in their file names.	Add the extension code —mp3 to their file names.
	MP3 files are not recorded in the format compliant with ISO 9660 Level 1, Level 2, or Joliet.	Change the disc. (Record MP3 files using a compliant application.)
<ul style="list-style-type: none"> <li>• Noise is generated while playing an MP3 disc.</li> </ul>	The file played back is not an MP3 file (although it has the extension code—mp3).	Skip to another file or change the disc. (Do not add the extension code—mp3 to non-MP3 files.)
<ul style="list-style-type: none"> <li>• A longer readout time is required for an MP3 disc.</li> </ul>	Readout time varies due to the complexity of the folder/file configuration.	Do not use too many hierarchies and folders. Also, do not record any other types of audio tracks together with MP3 files.
<ul style="list-style-type: none"> <li>• MP3 files cannot be played back as you have intended them to play.</li> </ul>	Playback order is determined when the files are recorded.	_____
<ul style="list-style-type: none"> <li>• Elapsed playing time is not correct for an MP3 disc.</li> </ul>	This sometimes occurs during play. This is caused by how the files are recorded on the disc.	_____
<ul style="list-style-type: none"> <li>• “RESET 8” appears on the display.</li> </ul>	This unit is not connected to the CD changer correctly.	Connect this unit and the CD changer correctly and press the reset button of the CD changer.
<ul style="list-style-type: none"> <li>• “RESET 1” – “RESET 7” appears on the display.</li> </ul>	_____	Press the reset button of the CD changer.
<ul style="list-style-type: none"> <li>• The CD changer does not work at all.</li> </ul>	The built-in microcomputer may have function incorrectly due to noise, etc.	Press the reset button on the panel holder after detaching the control panel. (The clock setting and preset stations stored in memory are erased.) (See page 2.)

CD Changer



# MAINTENANCE

This unit requires very little attention, but you will be able to extend the life of the unit if you follow the instructions below.

## To clean the head

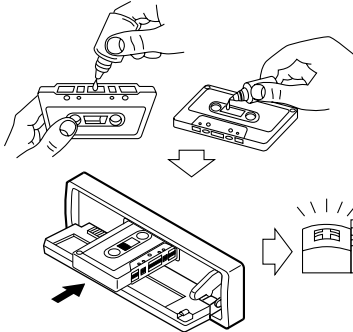

- Clean the heads after every 10 hours of use using a wet-type head cleaning tape (available at an audio store).  
When the head becomes dirty, you may realize the following symptoms:
  - Sound quality is reduced.
  - Sound level decreases.
  - Sound drops out.
- Do not play dirty or dusty tapes.
- Do not touch the highly-polished head with any metallic or magnetic tools.

## To keep the tape clean

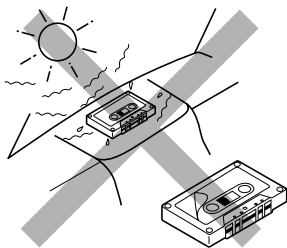

- Always store the cassettes in their storage cases after use.
- Do not store cassettes in the following places:
  - Subject to direct sunlight
  - With high humidity
  - At extremely hot temperatures

## CAUTION:

- Do not play the cassettes with peeling labels; otherwise, they can damage the unit.
- Tighten tapes to remove slack since loose tape may become entangled with the mechanism.
- Do not leave a cassette in the cassette compartment after use, as the tape may become slack.

The function below is also provided to ensure the longer life of this unit.

## Ignition key-off release/Ignition key-on play

- Turning off the ignition key with a cassette in the compartment automatically releases the tape from the unit's tapehead.
- Turning on the ignition key with a cassette in the compartment starts playback automatically if you turned off the ignition during tape play.

## AUDIO AMPLIFIER SECTION

Maximum Power Output:

Front: 45 W per channel

Rear: 45 W per channel

Continuous Power Output (RMS):

Front: 17 W per channel into 4  $\Omega$ , 40 Hz  
to 20 000 Hz at no more than  
0.8% total harmonic distortion.

Rear: 17 W per channel into 4  $\Omega$ , 40 Hz  
to 20 000 Hz at no more than  
0.8% total harmonic distortion.

Load Impedance: 4  $\Omega$  (4  $\Omega$  to 8  $\Omega$  allowance)

Tone Control Range:

Bass:  $\pm 10$  dB at 100 Hz

Treble:  $\pm 10$  dB at 10 kHz

Frequency Response: 40 Hz to 20 000 Hz

Signal-to-Noise Ratio: 70 dB

Line-Out Level/Impedance:

2.0 V/20 k $\Omega$  load (250 nWb/m)

## TUNER SECTION

Frequency Range:

FM: 87.5 MHz to 108.0 MHz

AM: 531 kHz to 1 602 kHz

### **[FM Tuner]**

Usable Sensitivity:

11.3 dBf (1.0  $\mu$ V/75  $\Omega$ )

50 dB Quieting Sensitivity:

16.3 dBf (1.8  $\mu$ V/75  $\Omega$ )

Alternate Channel Selectivity (400 kHz):

65 dB

Frequency Response: 40 Hz to 15 000 Hz

Stereo Separation: 35 dB

Capture Ratio: 1.5 dB

### **[AM Tuner]**

Sensitivity: 20  $\mu$ V

Selectivity: 35 dB

## CASSETTE DECK SECTION

Wow & Flutter: 0.11% (WRMS)

Fast-Wind Time: 100 sec. (C-60)

Frequency Response: 30 Hz to 16 000 Hz  
(Normal tape)

Signal-to-Noise Ratio: 56 dB

Stereo Separation: 40 dB

## GENERAL

Power Requirement:

Operating Voltage: DC 14.4 V

(11 V to 16 V allowance)

Grounding System: Negative ground

Allowable Operating Temperature: 0°C to +40°C

Dimensions (W  $\times$  H  $\times$  D):

Installation Size (approx.):

182 mm  $\times$  52 mm  $\times$  150 mm

Panel Size (approx.):

188 mm  $\times$  58 mm  $\times$  12 mm

Mass (approx.):

1.3 kg (excluding accessories)

*Design and specifications are subject to change  
without notice.*

**Having TROUBLE with operation?  
Please reset your unit  
Refer to page of How to reset your unit**

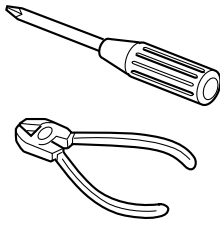

#### ENGLISH

- This unit is designed to operate only on 12 V DC, NEGATIVE ground electrical systems.

## INSTALLATION (IN-DASH MOUNTING)

- The following illustration shows a typical installation. However, you should make adjustments corresponding to your specific car. If you have any questions or require information regarding installation kits, consult your JVC car audio dealer or a company supplying kits.

#### 中文

- 本機僅可使用直流 12V、負極接地的電源系統。

## 安裝 (裝設、固定在儀表板內)

- 下面的圖解表示了典型的安裝程序。然而，您應當做些適當的調整，以便適應您自己的汽車。如果您有問題，或需要有關配套元件的資料，請向 JVC 汽車音響分銷商或配套元件供應公司詢問。

#### ไทย

- ชุดประกอบนี้ได้รับการออกแบบมาเพื่อใช้งานกับระบบ กระแสไฟฟ้าสายดินขั้วลบกระแสตรง 12 โวลท์ หากรถยนต์ของคุณไม่ได้ใช้ระบบนี้ ต้องใช้เครื่องแปลงกระแสไฟฟ้าย

## การติดตั้ง (การประกอบแผงหน้าปัทม์เข้า)

- ภาพตัวอย่างต่อไปนี้แสดงถึงการติดตั้งแบบทั่วไป อย่างไรก็ตาม คุณควรวัดรับแต่งให้เหมาะสมกับรถของคุณเอง หากคุณมีปัญหาคือหรือต้องการข้อมูลเพิ่มเติมเกี่ยวกับชุดติดตั้ง กรุณาปรึกษาตัวแทนผู้ขายเครื่องเสียงรถยนต์ JVC ของท่านหรือบริษัทที่จำหน่ายชุดติดตั้งนี้ที่จำหน่ายชุดติดตั้งนี้

#### عربي

- لقد صمم هذا الجهاز ليعمل فقط بواسطة تيار كهربائي مباشر DC، ١٢ فولت، انظمة كهربائية تاريخي سالب.

## تركيب الجهاز ( داخل - تابلو السيارة )

- يبين الرسم التوضيحي التالي طريقة التركيب المثالية. مع ذلك، يجب عليك عمل تعديلات تطابق نوع السيارة التي تمتلكها. اذا كان هناك استفسارات او حاجة لمعلومات بخصوص ادوات التركيب، يرجى استشارة موزع الاجهزة الصوتية للسيارات ماركة JVC او الشركة الموزعة لهذه الادوات.

- Before mounting:** Press (control panel release button) to detach the control panel if already attached.
  - When shipped from the factory, the control panel is packed in the hard case.
- Remove the trim plate.
- Remove the sleeve after disengaging the sleeve locks.
  - Stand the unit.
    - Note:** When you stand the unit, be careful not to damage the fuse on the rear.
  - Insert the 2 handles between the unit and the sleeve, as illustrated, to disengage the sleeve locks.
  - Remove the sleeve.
    - Note:** Be sure to keep the handles for future use after installing the unit.
- Install the sleeve into the dashboard.
  - After the sleeve is correctly installed into the dashboard, bend the appropriate tabs to hold the sleeve firmly in place, as illustrated.
- Fix the mounting bolt to the rear of the unit's body and place the rubber cushion over the end of the bolt.
- Do the required electrical connections.
- Slide the unit into the sleeve until it is locked.
- Attach the trim plate.
  - Note:** Ensure the recessed part is at the bottom. If not, the control panel will not open completely.
- Attach the control panel.

- 裝設之前：如果控制面板已經裝上，按下 (控制面板解脫按鈕)，拆脫控制面板。
  - 當控制面板從工廠裝運時，它是包裝在硬盒中的。
- 取下裝飾框。
- 解開扣板，取下本機的外套機殼。
  - 將本機豎起。
    - 注意：您豎起本機時，小心不要損壞底部的保險絲。
  - 按圖所示，在本機和外套機殼之間插入兩片板條型的把手，解開外套機殼扣板。
  - 取下外套機殼。
    - 注意：安裝本機後，務必保存好兩片把手，以備將來使用。
- 將外套機殼裝入儀表板內。
  - 在外套機殼準確地裝入儀表板之後，按圖所示，彎曲機殼的突舌，把外套機殼牢固在儀表板內。
- 將緊固螺栓旋緊在本機機體上，並將橡膠防震墊套在緊固螺栓的尾部。
- 進行所需的電路連接。
- 將本機滑入外套機殼，直到扣板鎖住為止。
- 裝上裝飾框。
  - 注意：確保凹入部分已在底部。如果不在底部，控制面板將不被完整打開。
- 裝上控制面板。

- ก่อนประกอบ กดปุ่ม (ปลดแผงควบคุม) เพื่อออกจากแผงควบคุม
  - เมื่อผลิตภัณฑ์ถูกส่งออกมาจากโรงงาน แผงหน้าปัดจะบรรจุไว้ในกล่องแข็ง
- ถอดแผ่นโลหะขอบแต่งออก
- ถอดปลอกหุ้มออกหลังจากปลดที่ล็อกปลอกหุ้มออกแล้ว
  - จับชุดประกอบตั้งขึ้น
    - หมายเหตุ :** เมื่อคุณตั้งชุดประกอบขึ้น ระวังอย่าทำให้อุปกรณ์ส่วนท้ายเสียหาย
  - ใส่คั่นกับ 2 อันระหว่างชุดประกอบกับปลอกหุ้ม (ดังภาพ) เพื่อปลดที่ล็อกปลอกหุ้มออกจากกัน
  - ปลดปลอกหุ้มออก
    - หมายเหตุ :** ระวังให้คั่นกับคั่นสามารถใช้งานได้ต่อไปหลังจากติดตั้งชุดประกอบแล้ว
- ติดตั้งปลอกหุ้มลงในแผงหน้าปัทม์
  - หลังจากติดตั้งปลอกหุ้มลงในแผงหน้าปัทม์อย่างถูกต้องแล้ว ตัดร่องให้โค้งพอดีที่ปลอกหุ้มจะพอดีต่อไว้อย่างแนบหนา (ดังภาพ)
- ติดตั้งสกรูประกอบบริเวณด้านหลังโครงของชุดประกอบและวางสายกันกระแทกไว้บนส่วนปลายของสลัก
- ต่อสายไฟตามที่กำหนดไว้ทั้งหมด
- เลื่อนชุดประกอบลงในปลอกหุ้มจนเข้ากันได้พอดี
- ต่อแผ่นโลหะขอบแต่ง
  - หมายเหตุ :** เวลาใส่ต้องแน่ใจว่า ตัวล็อกอยู่ทางด้านล่าง มิฉะนั้นแล้ว จะเปิดแผงควบคุมออกไม่ได้ทั้งหมด
- ต่อเข้ากับแผงควบคุม

- قبل بدء التركيب: اضغط الرمز (زر تحرير لوحة التحكم) من أجل فصل لوحة التحكم. عند الشحن من المصنع، تم وضع لوحة التحكم داخل الصندوق.
- انزع لوحة الزينة.
- انزع الهيكل الواقي بعد فصل مثبتات الهيكل الواقي.
  - اوقف الجهاز بشكل عمودي.
    - ملاحظة:** عند توقيف الجهاز، تأكد من عدم تضرر او اتلاف الفيوز الموجود في الجهة الخلفية من الجهاز.
  - ادخل المساكين بين الجهاز والهيكل الواقي، كما هو مبين في الشكل، لفصل مثبتات الهيكل الواقي.
  - انزع الهيكل الواقي.
- ملاحظة: يرجى المحافظة على المساكات من اجل الاستعمال لاحقا بعد تركيب الجهاز. ركب الهيكل الواقي داخل تابلو السيارة.
  - بعد تركيب الهيكل الواقي كليا داخل تابلو السيارة بشكل صحيح، اثني الألسنة بشكل مناسب لتثبيت الهيكل الواقي بشكل محكم في المكان الصحيح، كما هو مبين في الشكل.
- ثبت مسمار التركيب بالجهة الخلفية من هيكل الجهاز وبعد ذلك ضع الحشوة المطاطية فوق نهاية المسمار.
- اعمل التوصيلات الكهربائية المطلوبة كما هو مشروح خلف هذه التعليمات.
- ادخل الجهاز داخل الهيكل الواقي حتى يثبت بشكل صحيح.
- ركب لوحة الزينة.
- ملاحظة: تأكد من ان القسم المجوف في الاسفل. بخلاف ذلك، سوف لا تفتح لوحة التحكم بصورة كاملة.
- ركب لوحة التحكم.

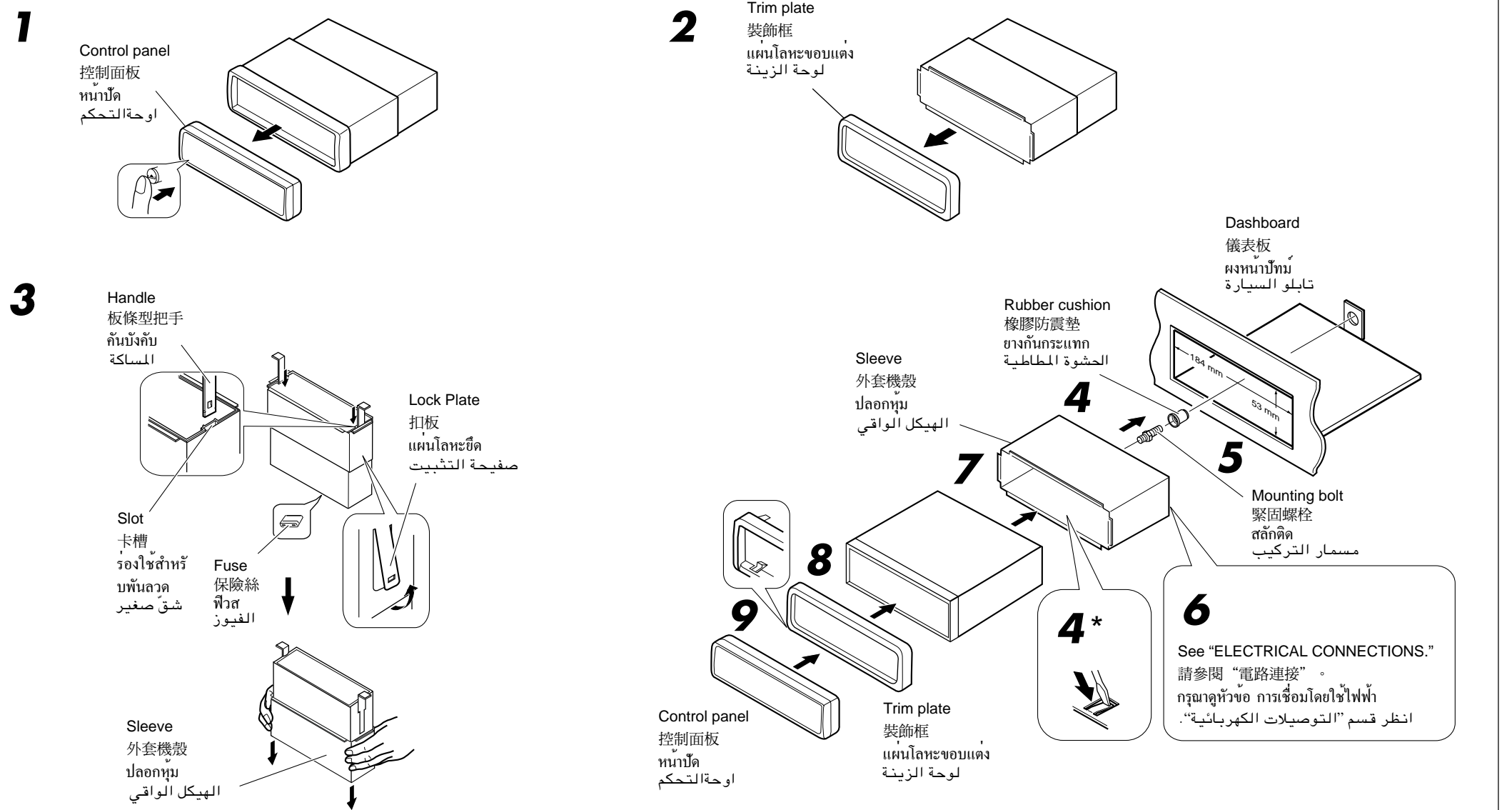

- **When using the optional stay**
- 若選用支撐架
- เมื่อใช้ตัวยึดแบบเลือกได้ (สามารถเลือกเปิดค้างไว้ได้)
- عند استخدام مسند اضافي للتثبيت

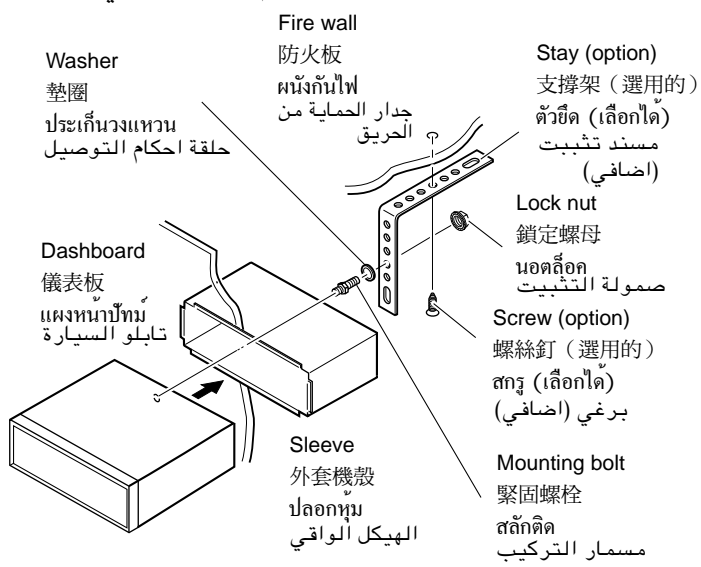

- **When installing the unit without using the sleeve**
- 若不使用外套機殼安裝本機
- เมื่อติดตั้งชุดประกอบโดยไม่มีปลอกหุ้ม
- عندما تركيب الجهاز بدون استخدام الهيكل الواقي

In a Toyota for example, first remove the car radio and install the unit in its place.  
以豐田牌 (TOYOTA) 汽車為例：首先取出汽車收音機，然後將本機裝入其空出的位置。  
ตัวอย่างเช่น ในรถยนต์โตโยตา ให้ถอดวิทยุติดรถยนต์ออกก่อนและติดตั้งชุดประกอบนี้เข้าไปแทน  
على سبيل المثال، في سيارات نوع تويوتا، انزع راديو السيارة أولا بعد ذلك ركب الجهاز في مكانه.

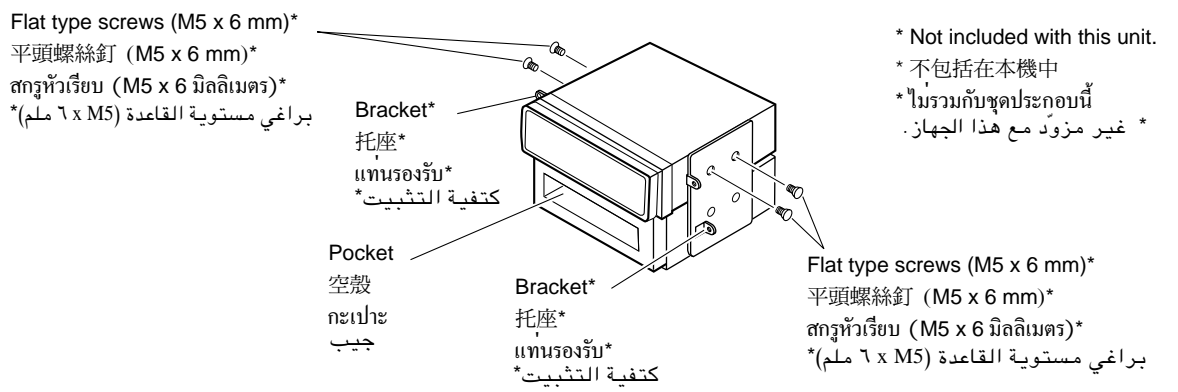

**Note:** When installing the unit on the mounting brackets, make sure to use the 6 mm-long screws. If longer screws are used, they could damage the unit.

注意：把本機安裝在托座上時，務必使用 6 mm 長的螺絲釘。如使用過長的螺絲釘，會損壞本機。

หมายเหตุ : เมื่อติดตั้งชุดประกอบลงในแทนรองรับไว้ให้ใช้สกรูยาวขนาด 6 มิลลิเมตร ถ้าใช้สกรูยาวกว่านี้อาจทำให้ชุดประกอบเสียหายได้

ملاحظة: عند تركيب الجهاز على كتفية التثبيت، تأكد من استخدام براغي طول 6 ملم. في حالة استخدام براغي اطول من 6 ملم، فان ذلك يمكن ان يسبب تلف او ضرر للجهاز.

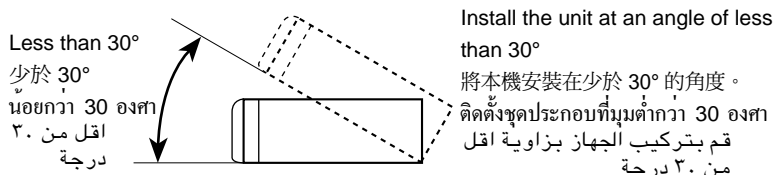

### Removing the unit

- Before removing the unit, release the rear section.

- 1 Remove the control panel.
- 2 Remove the trim plate.
- 3 Insert the 2 handles into the slots, as shown. Then, while gently pulling the handles away from each other, slide out the unit. (Be sure to keep the handles after installing it.)

### 拆卸本機

- 在拆卸本機前，應將本機後部的固定和連接部分鬆開。

- 1 拆下控制面板。
- 2 取下裝飾框。
- 3 按圖所示，將兩片板條型把手插入卡槽，然後輕輕地從兩側向外拉兩片把手，本機隨之拉出。（安裝本機後，務必保存好兩片把手。）

### การถอดชุดประกอบ

- ก่อนจะถอดชุดประกอบ ให้ปลดหน้าตัดส่วนท้ายก่อน

- 1 ถอดแผงควบคุม
- 2 ถอดแผ่นโลหะขอบแต่ง
- 3 ใส่ที่จับกับ 2 อันลงในร่องสำหรับใช้พื้นลวด ดังภาพ จากนั้นให้เลื่อนชุดประกอบออก ในขณะที่ค่อย ๆ ดึงกันจับกับทั้งสองอันออกจากกัน (ดูให้ตัวจับกับทั้งสองอันอยู่ในตำแหน่งที่เหมาะสมหลังจากติดตั้งแล้ว)

### نزع الجهاز من تابلو السيارة

- قبل نزع الجهاز، حرر الجزء الخلفي.

- 1 انزع لوحة التحكم.
- 2 انزع لوحة الزينة.
- 3 ادخل المساكين داخل الشقوق، كما هو مبين في الشكل. بعد ذلك، اثناء سحب المساكين بلطافة بعيدا الواحدة عن الاخرى، اسحب الجهاز الى الخارج. (تأكد من احتفاظك بالمساكين بعد تركيب الجهاز.)

1

Control panel  
控制面板  
หน้าปัด  
اوحة التحكم

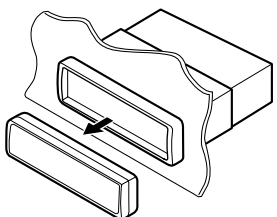

2

Trim plate  
裝飾框  
แผ่นโลหะขอบแต่ง  
لوحة الزينة

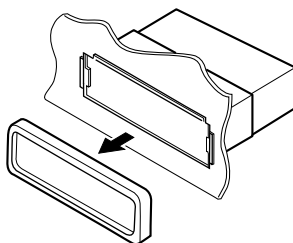

3

Handle  
板條型把手  
กันจับกับ  
المساکة

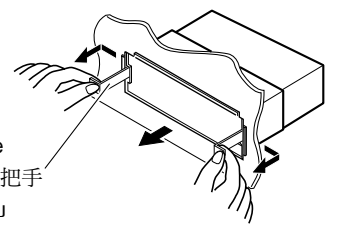

### Parts list for installation and connection

The following parts are provided with this unit. After checking them, please set them correctly.

### 用於安裝和連接的零件裏

下列零件是隨本機提供的。  
清點以後，正確的將其裝配。

### รายการส่วนประกอบสำหรับติดตั้งและเชื่อมต่อกัน

ส่วนประกอบต่อไปนี้ใหม่กับชุดประกอบนี้ หลัง  
จากตรวจสอบแล้ว ปรับตั้งเครื่องให้ถูกต้อง

### قائمة اجزاء التركيب والتوصيل

الاجزاء التالية مزودة مع الجهاز.  
بعد فحص هذه الاجزاء، يرجى تركيبهم بشكل صحيح.

Hard case/Control panel  
硬盒 / 控制面板  
กล่องบรรจุ/หน้าปัด  
صندوق صلب/اوحة التحكم

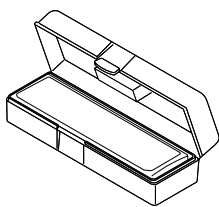

Sleeve  
外套機殼  
ปลอกหุ้ม  
الهيكال الواقي

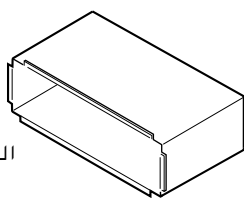

Trim plate  
裝飾框  
แผ่นโลหะขอบแต่ง  
لوحة الزينة

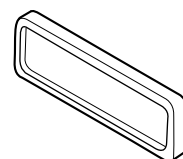

Remote controller  
遙控器  
รีโมทคอนโทรล  
وحدة التحكم عن بعد

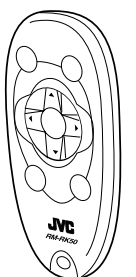

Power cord  
電路連接用的配線束  
สายเคเบิลกำลัง  
سلك الطاقة الكهربائية

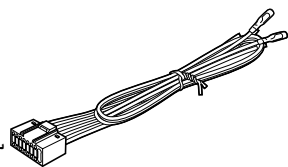

Handles  
板條型把手  
กันจับกับ  
المساکات

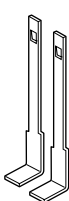

Mounting bolt (M5 x 20 mm)  
緊固螺栓 (M5 x 20 mm)  
สลักติด (M5 x 20 มิลลิเมตร)  
سمار التركيب (M5 x 20 ملم)



Rubber cushion  
橡膠防震墊  
ยางกันกระแทก  
الحشية المطاطية



Washer (ø5)  
墊圈 (ø5)  
ประเก็นวงแหวน (ø5)  
حلقة احكام التوصيل (قطر 5°)



Lock nut (M5)  
鎖定螺母 (M5)  
นอตล็อก (M5)  
صمولة التثبيت (M5)



Battery  
電池  
แบตเตอรี่  
البطاريات



## TROUBLESHOOTING

- **The fuse blows.**
- Are the red and black leads connected correctly?
- **Power cannot be turned on.**
- Is the yellow lead connected?
- **No sound from the speakers.**
- Is the speaker output lead short-circuited?
- **Sound is distorted.**
- Is the speaker output lead grounded?
- Are the “-” terminals of L and R speakers grounded in common?
- **Unit becomes hot.**
- Is the speaker output lead grounded?
- Are the “-” terminals of L and R speakers grounded in common?

## 故障排除

- 保險絲燒斷。
- 檢查紅色導線接頭和黑色導線接頭是否連接正確？
- 電源不能接通。
- 檢查黃色導線接頭是否接上？
- 揚聲器沒有聲音。
- 檢查揚聲器輸出導線接頭是否短路？
- 聲音失真。
- 檢查揚聲器輸出端子是否接地？
- 檢查揚聲器的左 (L)、右 (R) 端子的負極 (-) 是否共同接地？
- 本機發熱。
- 檢查揚聲器輸出端子是否接地？
- 檢查揚聲器的左 (L)、右 (R) 端子的負極 (-) 是否共同接地？

## การตรวจสอบปัญหาขัดข้อง

- ฟิวส์ขาด
- มีการเชื่อมสายตะกั่วสีดำและสีแดงอย่างถูกต้องหรือไม่
- ไม่สามารถเปิดเครื่องได้
- มีการเชื่อมสายตะกั่วสีเหลืองหรือไม่
- ไม่มีเสียงออกจากลำโพง
- สายตะกั่วส่วนที่ออกทางลำโพงเกิดไฟฟ้ลัดวงจรหรือไม่
- เสียงเพี้ยน
- สายตะกั่วส่วนที่ออกทางลำโพงต่อลงดินหรือไม่
- สายขั้วลบ ของลำโพงด้านซ้ายและขวาต่อลงดินตามปกติหรือไม่
- ชุดประกอบร้อนขึ้น
- สายตะกั่วส่วนที่ออกทางลำโพงต่อลงดินหรือไม่
- สายขั้วลบ ของลำโพงด้านซ้ายและขวาต่อลงดินตามปกติหรือไม่

## البحث عن الاعطال والاصلاح

- يحترق الفيوز.
- هل السلك الاحمر والاسود موصولة بشكل صحيح؟
- لا يمكن توصيل الطاقة الكهربائية.
- هل السلك الاصفر موصولاً؟
- لا يصدر صوت من السماعات.
- هل هناك تقصير في دائرة سلك خرج السماعة؟
- الصوت مشوه.
- هل سلك خرج السماعة موصولاً بالأرض؟
- هل الاطراف السالبة “-” للسماعة اليسرى L واليمنى R موصولة بالأرض مع بعض؟
- يسخن الجهاز.
- هل سلك خرج السماعة موصولاً بالأرض؟
- هل الاطراف السالبة “-” للسماعة اليسرى L واليمنى R موصولة بالأرض مع بعض؟



# ELECTRICAL CONNECTIONS

To prevent short circuits, we recommend that you disconnect the battery's negative terminal and make all electrical connections before installing the unit. If you are not sure how to install this unit correctly, have it installed by a qualified technician.

**Note:**  
This unit is designed to operate only on 12 V DC, **NEGATIVE ground electrical systems.** If your vehicle does not have this system, a voltage inverter is required, which can be purchased at JVC car audio dealers.

- Replace the fuse with one of the specified rating. If the fuse blows frequently, consult your JVC car audio dealer.
- If noise is a problem... This unit incorporates a noise filter in the power circuit. However, with some vehicles, clicking or other unwanted noise may occur. If this happens, connect the unit's **rear ground terminal** (see connection diagram) to the car's chassis using shorter and thicker cords, such as copper braiding or gauge wire. If noise still persists, consult your JVC car audio dealer.
- Maximum input of the speakers should be more than 45 W at the rear and 45 W at the front, with an impedance of 4 Ω to 8 Ω.
- **Be sure to ground this unit to the car's chassis.**
- The heat sink becomes very hot after use. Be careful not to touch it when removing this unit.

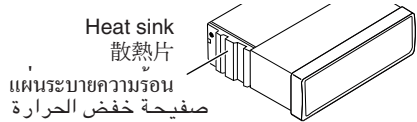

# 電路連接

為防止短路，建議在安裝本機之前，斷開電池的負極，並把所有電路都連接好。如果您不能確定如何正確地安裝本機，應請合格的技術人員來安裝。

**注意：**  
本機僅可使用直流 12V、負極接地的電源系統。如果您的車輛沒有這一電源系統，則需要一個電壓變換器，可以在 JVC 汽車音響分銷商處買到。

- 把保險絲更換為額定負荷值的保險絲。如果保險絲經常燒壞，請向 JVC 汽車音響分銷商詢問。
- 若出現噪音問題... 本機在電源回路帶有一個噪音濾波器。但是，在某些車輛上，會出現咯咯聲或其它噪音。如果發生這類情況，將本機後面的接地端子用短而粗的導線，如編織銅線或標準電纜，連接到汽車底盤上（參閱電路接線圖）。如果噪音仍然持續存在，請向 JVC 汽車音響分銷商詢問。
- 後置和前置揚聲器的最大輸入功率應大於 45 W 其阻抗為 4 Ω - 8 Ω。
- 務必將本機的地線連接到汽車底盤上。
- 本機使用後，散熱片會很熱。因此，在移出本機時，小心不要觸摸散熱片。

# การเชื่อมต่อโดยไฟฟ้า

เพื่อป้องกันไฟลัดวงจรเราขอแนะนำให้ถอดขั้วลบแบตเตอรี่ออกก่อนและทำการเชื่อมต่อไฟฟ้ทั้งหมดก่อนที่จะติดตั้งชุดประกอบถ้าคุณไม่แน่ใจว่าติดตั้งชุดประกอบนี้ถูกต้องหรือไม่ให้หาช่างผู้เชี่ยวชาญเป็นผู้ติดตั้ง

**หมายเหตุ:**  
ชุดประกอบนี้ได้รับการออกแบบมาเพื่อใช้งานกับระบบกระแสไฟฟ้สายดินขั้วลบกระแสตรง 12 โวลท์

- หากรถยนต์ของคุณไม่ได้ใช้ระบบนี้  
**ต้องใช้เครื่องแปลงกระแสไฟฟ้**  
ซึ่งสามารถหาซื้อได้จากกรมขายเครื่องเสียงรถยนต์ JVC
- ใช้ฟิวส์เฉพาะเท่านั้น หากฟิวส์ขาดบ่อยให้ปรึกษาร้านขายเครื่องเสียงรถยนต์ JVC
- หากเสียงมีปัญหา... ชุดประกอบชุดนี้มีเครื่องกรองเสียงในวงจรกำลัง อย่างไรก็ตาม บางครั้งก็อาจเกิดเสียงที่ไม่พึงปรารถนาขึ้นได้ หากปัญหานี้เกิดขึ้น ให้**ต่อขั้วสายดินด้านหลังของชุดประกอบ** (ดูแผนภูมิการต่อเชื่อมด้าน) เข้ากับแชสซีของรถยนต์โดยใช้สายเคเบิลที่สั้นและหนากว่า เช่น สายไฟเครื่องวัดหรือสายประจําทองแดง เป็นต้น หากยังมีเสียงอยู่ก็ให้ปรึกษาร้านขายเครื่องเสียงรถยนต์ JVC
- ระดับอินพุตที่สูงสุดของลำโพงควรคิ่งเกินกว่า 45 วัตต์ และ 45 วัตต์ที่ลำโพงหลังและลำโพงหน้า โดยมีอิมพีแดนซ์ในระดับ 4 Ω - 8 Ω
- **ตรวจสอบให้แน่ใจว่าได้ต่อชุดประกอบชุดนี้ลงไปในแชสซีของรถยนต์แล้ว**
- แผนระบายความร้อนจะร้อนมากหลังจากใช้ ระยะเวลาขั้วอย่าไปสัมผัสเมื่อถอดชุดประกอบนี้

# التوصيلات الكهربائية

لمنع حدوث تقصير في الدوائر الكهربائية، نوصي بفصل طرف البطارية السالب ثم عمل التوصيلات الكهربائية قبل تركيب الجهاز. في حالة عدم معرفتك بكيفية تركيب الجهاز بشكل صحيح، يرجى ترك عملية تركيب الجهاز لشخص مختص ومؤهل لتركيب مثل هذه الأجهزة.

**ملاحظة:**  
لقد صمم هذا الجهاز ليعمل فقط بواسطة تيار كهربائي مباشر DC، ١٢ فولت، أنظمة كهربائية تأريض سالب. في حالة عدم وجود مثل هذا النظام في سيارتك، يجب استخدام محول فولتاج، ويمكن شراء هذا المحول من وكلاء الأجهزة الصوتية للسيارات ماركة JVC.

- استبدل الفيوز بأخر يحمل نفس القياسات الموصوفة. إذا تكرر احتراق الفيوز، يرجى استشارة وكلاء الأجهزة الصوتية للسيارات ماركة JVC.
- إذا كان الضجيج هو المشكلة... يستخدم هذا الجهاز فلتر ضجيج داخل دائرة الطاقة الكهربائية. مع ذلك، في بعض السيارات، يمكن أن يحدث نوع من الطقطقة أو الضجيج غير المرغوب. في حالة حدوث مثل ذلك، اوصل طرف التأسيس الموجود في خلفية الجهاز (انظر رسم التوصيل في الأسفل) مع هيكل السيارة بواسطة استخدام اسلاك اقصر واسمك، مثل سلك النحاس المجلول أو سلك مقياسي. في حالة عدم توقف الطقطقة أو الضجيج، يرجى استشارة وكلاء الأجهزة الصوتية للسيارات ماركة JVC.
- يجب أن يكون دخل صوت السماعات الاقصى أكثر من ٤٥ واط و ٤٥ واط لكلا من الخلف والامام، مع ممانعة ٤ اوم الى ٨ اوم.
- **تأكد من تأريض الجهاز مع هيكل السيارة.**
- تصبح صفيحة خفض الحرارة ساخنة جدا بعد الاستخدام. تأكد من عدم ملامستها عند نزع الجهاز.

## Typical Connections / 典型的接線方法 / การเชื่อมต่อแบบปกติ / التوصيلات النموذجية

**Before connecting:** Check the wiring in the vehicle carefully. Incorrect connection may cause serious damage to this unit.

The leads of the power cord and those of the connector from the car body may be different in color.

- 1 Connect the colored leads of the power cord to the car battery, speakers and automatic power antenna (if any) in the following sequence.
  - ① Black: ground
  - ② Yellow: to car battery (constant 12 V)
  - ③ Red: to an accessory terminal
  - ④ Blue with white stripe: to remote lead of other equipment (200 mA max.)
  - ⑤ Blue: to automatic antenna if any (250 mA max.)
  - ⑥ Others: to speakers
- 2 Connect the antenna cord.
- 3 Finally connect the wiring harness to the unit.

**接線前：**仔細檢查汽車內的線路。不正確的接線會導致本機嚴重損壞。

電力線的引線和車身的連接器引線在顏色上可能有所不同。

- 1 按下順序將配線束各個不同色標的導線接頭分別接至電池、揚聲器和自動電源升降天線（如有裝設）：
  - ① 黑色：接地
  - ② 黃色：接至車裝電池（恆定 12V）
  - ③ 紅色：接至保險絲單元內的附屬端子
  - ④ 藍色帶有白色條紋：接至其他音響設備（最大 200 mA）
  - ⑤ 藍色：接至自動升降天線（最大 250 mA）
  - ⑥ 其他：接至揚聲器
- 2 將天線的電線連接起來。
- 3 最後，把配線束的插頭插在本機上。

**ถอดท่าภาคเชื่อมต่อ:** ตรวจสอบสายไฟที่ติดอยู่กับชุดประกอบอย่างระมัดระวังเพื่อหลีกเลี่ยงการเกิดไฟลัดวงจรที่อาจก่อให้เกิดความเสียหายร้ายแรงต่อชุดประกอบ

สายไฟของสายไฟและสายไฟที่เชื่อมต่อกับตัวถังรถอาจมีสีต่างกัน

- 1 ต่อสายต่อสีของสายไฟเข้ากับแบตเตอรี่รถยนต์ ลำโพง และเสาอากาศพาวเวอร์แอนเทนนา (ถ้ามี) ตามลำดับต่อไปนี้
  - ① สีดำ: สายดิน
  - ② สีเหลือง: ต่อกับแบตเตอรี่รถยนต์ (12 โวลท์คงที่)
  - ③ สีแดง: ต่อกับขั้วส่วนประกอบ
  - ④ สายสีฟ้าที่มีแถบขาว: ต่อเข้ากับอุปกรณ์อื่น (ขนาดสูงสุด 200 mA)
  - ⑤ สีฟ้า: ต่อเข้ากับเสาอากาศอัตโนมัติ (ขนาดสูงสุด 250 mA)
  - ⑥ สีอื่น ๆ: ต่อกับลำโพง
- 2 เชื่อมต่อสายอากาศ
- 3 สุดท้าย ต่อสายควบคุมการเดินสายไฟเข้ากับชุดประกอบชุดนี้

**قبل البدء بالتوصيل:** تأكد من شبكة الاسلاك في السيارة بدقة حتى لا يحدث خطأ في عملية توصيل الجهاز. يمكن ان يسبب التوصيل الخاطيء الى حصول عطل حقيقي للجهاز.

يمكن ان يختلف لون سلك الطاقة الكهربائية وسلك الموصل عن لون هيكل السيارة.

- 1 اوصل الاسلاك الملونة لسلك تزويد الطاقة الكهربائية مع بطارية السيارة، السماعات والهوائي الاوتوماتيكي (ان وجد) حسب التسلسل التالي.
  - ① السلك الاسود: مع الارض
  - ② السلك الاصفر: مع بطارية السيارة (ثابت ١٢ فولت)
  - ③ السلك الاحمر: مع الطرف الاضافي
  - ④ السلك الازرق المخطط بالابيض: مع الاجهزة الاخرى (الحد الاقصى ٢٠٠ ميلي امبير)
  - ⑤ السلك الازرق: مع الهوائي الاوتوماتيكي (الحد الاقصى ٢٥٠ ميلي امبير)
  - ⑥ الاسلاك الاخرى: مع السماعات
- 2 اوصل سلك الهوائي.
- 3 اخيرا، اوصل حامل الاسلاك مع الجهاز.

- Before connecting the CD changer, make sure that the unit is turned off.
- 連接 CD 換碟器之前，應先將本機關閉。
- ก่อนจะเชื่อมต่อเครื่องเล่นซีดี กรุณาตรวจสอบให้แน่ใจว่าเครื่องเล่นซีดีนั้นปิดอยู่
- قبل توصيل مبدل الاسطوانة المدمجة CD، تأكد من إيقاف تشغيل الجهاز.

**JVC CD changer jack**  
หัวเสียบของเครื่องเล่นซีดี JVC  
مقبس اسطوانة المدمجة JVC ماركة CD

We recommend you to connect the JVC MP3-compatible CD changer. You can also connect other CH-X series CD changers (except CH-X99 and CH-X100).  
• You cannot use the KD-MK series CD changers with this unit. You can also use an external component such as a portable MD player by connecting the Line Input Adapter KS-U57 (not supplied). (See diagram B.)

我們建議您連接 JVC MP3 兼容的 CD 換碟器。您也可連接其它 CH-X 系列的 CD 換碟器 (CH-X99 和 CH-X100 除外)。  
• 本機無法讓您與 KD-MK 系列的 CD 換碟器共同使用。您可以通過連接線輸入適配器 KS-U57 (未提供) 來使用外接部件，如手提式 MD 播放機等。(參閱圖表 B)

ขอแนะนำให้นำที่ต่อซีดีเจเนอเรชั่นที่สามารถทำงานร่วมกับ JVC MP3 กับเครื่องเล่นของคุณ คุณสามารถต่อซีดีเจเนอเรชั่น CH-X อื่นๆ ได้ (ยกเว้นรุ่น CH-X99 และ CH-X100)  
• คุณไม่สามารถใช้ซีดีเจเนอเรชั่น KD-MK กับเครื่องเล่นนี้  
คุณสามารถใช้อุปกรณ์ภายนอกเช่น เครื่องเล่นเอ็มดีแบบพกพาได้ โดยนำมาเชื่อมต่อกับแอดปเตอร์สายสัญญาณ KS-U57 (ไม่ได้ให้มาด้วย) (ดูแผนภูมิ B)

ننصح بتوصيل مبدل اسطوانات مدمجة CD متوافق مع اسطوانات MP3 مع صناعة JVC مع هذا الجهاز. يمكنك ايضا توصيل مبدلات الاسطوانات المدمجة CD من سلسلة CH-X الاخرى (باستثناء CH-X99 و CH-X100).  
• لا يمكنك استعمال مبدلات الاسطوانات المدمجة CD من سلسلة KD-MK مع هذا الجهاز.  
يمكنك ايضا استعمال جهاز كمبونات خارجي مثل مبدل اسطوانة MD الميني ديسك وذلك بتوصيل بهايه، دخل الخط KS-U57 (غير مزود مع هذا الجهاز) (انظر المخطط B)

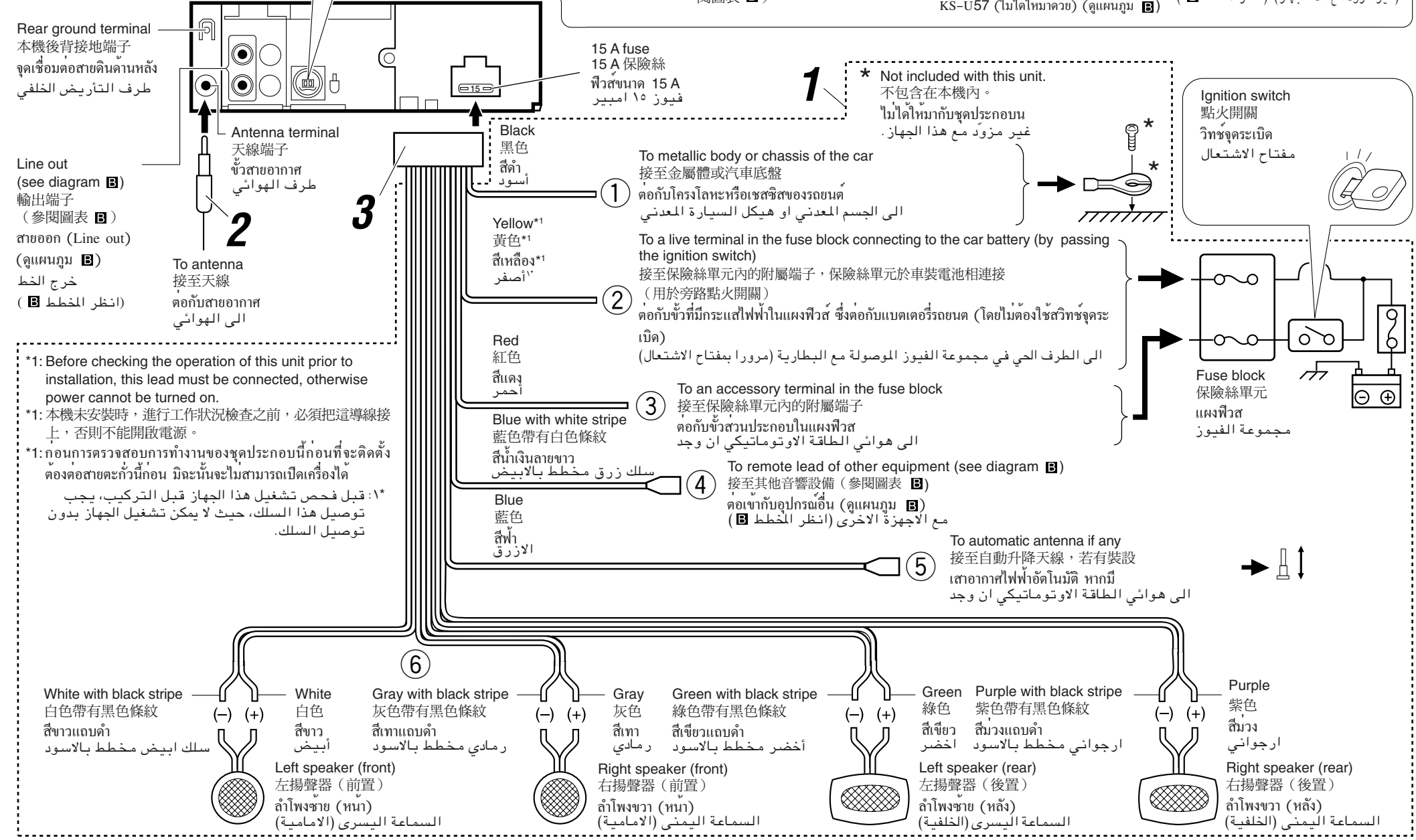



## Connecting the leads / 導線接頭的連接 / ต่อสายตะกั่ว / توصيل الاسلاك

Twist the core wires when connecting.

連接時扭轉線芯。

บิดเส้นลวดแกนเพื่อเชื่อมต่อ  
ابرهم الاسلاك بشكل صحيح قبل التوصيل.

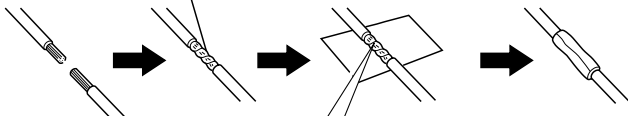

Solder the core wires to connect them securely.

將線芯牢固地焊接在一起。

เชื่อมบัดกรีเส้นลวดแกนทั้งหมดเข้าด้วยกัน เพื่อความปลอดภัยในการทำงาน  
หุ้ม الاسلاك بشكل صحيح ومحکم بعد التوصيل.

## CAUTION / 注意 / ข้อควรระวัง / تنبيه

- To prevent short-circuit, cover the terminals of the UNUSED leads with insulating tape.
- 为防止电源短路，請用絕緣帶包住未使用電線的端子。
- การป้องกันการลัดวงจร จะต้องพันขั้วสายตะกั่วที่ไม่ใช้แล้วด้วยเทปพันสายไฟ
- من أجل منع التقصير في الدوائر - الكهربائية، ضع شريط عازل ولاصق على اطراف الاسلاك غير المستعملة.

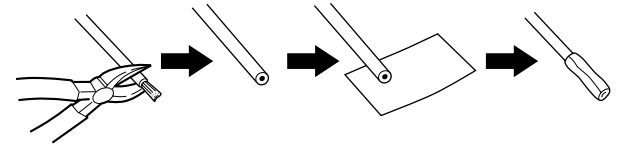

## PRECAUTIONS on power supply and speaker connections:

DO NOT connect the speaker leads of the power cord to the car battery; otherwise, the unit will be seriously damaged.

Connect the black lead (ground), yellow lead (to car battery, constant 12 V), and red lead (to an accessory terminal) correctly.

BEFORE connecting the speaker leads of the power cord to the speakers, check the speaker wiring in your car.

If the speaker wiring in your car is as illustrated in Fig. 1 and Fig. 2 below, DO NOT connect the unit using that original speaker wiring. If you do, the unit will be seriously damaged.

Redo the speaker wiring so that you can connect the unit to the speakers as illustrated in Fig. 3.

If the speaker wiring in your car is as illustrated in Fig. 3, you can connect the unit using the original speaker wiring in your car.

If you are not sure of the speaker wiring of your car, consult your car dealer.

## 電源和揚聲器接線注意事項：

切勿把揚聲器導線接頭接至電池，否則本機將會嚴重損壞。

正確地連接黑色導線接頭（接地）、黃色導線接頭（接車裝電池，恆定 12V）和紅色導線接頭（接至保險絲單元的附屬端子）。

在把揚聲器導線接頭接至揚聲器之前，檢查您汽車上的揚聲器線路：

- 如果汽車上揚聲器線路像圖 1 和圖 2 所示，不要使用原裝的揚聲器線路。如果使用，本機將嚴重損壞。
- 要重新連接揚聲器線路，可按圖 3 所示，把本機與揚聲器相連接。
- 如果您汽車上揚聲器線路像圖 3 所示，可使用原裝的揚聲器線路與本機相連接。
- 如果您不能確定您汽車上揚聲器線路，請向您的汽車分銷商詢問。

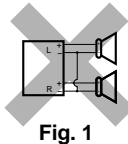

Fig. 1



Fig. 2

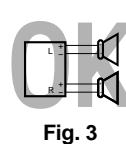

Fig. 3

## ข้อควรระวังสำหรับการต่อแหล่งจ่ายกำลังและลำโพง:

อย่าต่อสายตะกั่วเส้นลวดของลำโพงเข้ากับแบตเตอรี่รถยนต์ มิฉะนั้น ชุดประกอบจะได้รับความเสียหายมาก

ต่อสายตะกั่วแต่ละสีให้ถูกต้อง : สีดำ (สายดิน), สีเหลือง (เข้ากับแบตเตอรี่รถยนต์ที่มีกำลังถึง 12 โวลท์) และสีแดง (เข้ากับขั้วส่วนประกอบ)

ก่อนที่จะต่อสายตะกั่วเส้นลวดของลำโพงเข้ากับลำโพง ให้ตรวจสอบการเดินสายไฟลำโพงในรถของคุณให้เรียบร้อยเสียก่อน

- หากการเดินสายไฟลำโพงในรถของคุณเป็นเหมือนในรูปภาพที่ 1 และรูปภาพที่ 2 ดังข้างล่างนี้ อย่าต่อชุดประกอบที่ใช้การเดินสายไฟลำโพงแบบดั้งเดิมนั้น มิฉะนั้น ชุดประกอบจะได้รับความเสียหายมาก ให้จัดการเดินสายไฟลำโพงใหม่ เพื่อที่คุณจะสามารถต่อ ชุดประกอบเข้ากับลำโพงตามรูปภาพที่ 3 ได้
- หากการเดินสายไฟลำโพงในรถของคุณเป็นเหมือนในรูปภาพที่ 3 คุณสามารถต่อชุดประกอบที่ใช้การเดินสายไฟลำโพงแบบดั้งเดิมในรถของคุณได้เลย
- หากคุณไม่แน่ใจว่าการเดินสายไฟลำโพงในรถของคุณเป็นแบบใด ให้ปรึกษาผู้เชี่ยวชาญรถยนต์ของคุณ

## تنبيهات حول تزويد الطاقة الكهربائية وتوصيل السماعات:

لا توصل اسلاك تزويد طاقة السماعات مع بطارية السيارة، لأن ذلك يؤدي الى حصول ضرر للسماعات.

اوصل السلك الاسود (الأرضي)، والسلك الاصفر (مع بطارية السيارة، ثابت ١٢ فولت)، والسلك الاحمر (مع الطرف الاضافي) بشكل صحيح.

قبل توصيل اسلاك تزويد طاقة السماعات مع السماعات، افحص شبكة اسلاك السماعات داخل سيارتك.

إذا كانت شبكة اسلاك السماعات داخل سيارتك كما هي مبينة في الشكل ١ والشكل ٢ الموجودة في الأسفل، لا توصل الجهاز بواسطة استخدام شبكة اسلاك السماعات الاصلية. إذا تم توصيل الجهاز بهذه الطريقة، سيؤدي ذلك الى حصول ضرر. أعد عمل شبكة اسلاك السماعات بحيث يمكنك توصيل الجهاز مع السماعات كما هو مبين في الشكل ٣.

إذا كانت شبكة اسلاك السماعات داخل سيارتك كما هي مبينة في الشكل ٣، يمكنك توصيل الجهاز بواسطة استخدام شبكة اسلاك السماعات الاصلية داخل سيارتك.

في حالة عدم معرفتك بشبكة اسلاك السماعات داخل سيارتك، استشر الوكيل أو ذوي الخبرة بهذا الخصوص.

## Connections Adding Other Equipment / 連接附加的其他音響設備 / การต่อเพิ่มเติมเข้ากับอุปกรณ์อื่น ๆ / توصيل الاجهزة الاخرى الاضافية

You can connect an amplifier and other equipment to upgrade your car stereo system.

Connect the remote lead (blue with white stripe) to the remote lead of the other equipment so that it can be controlled through this unit.

For amplifier only:

Connect this unit's line-out terminals to the amplifier's line-in terminals.

Disconnect the speakers from this unit, connect them to the amplifier. Leave the speaker leads of this unit unused. (Cover the terminals of these unused leads with insulating tape, as illustrated.)

你可以連接放大器和其裝置以加強你的汽車音響系統功能。

將遙控線（藍色帶有白色條紋）和其他裝置上的遙控線連接起來，以便可以通過本機進行遙控。

僅適用於放大器：

將本機的輸出終端和放大器輸入終端連接起來。

將揚聲器和本機斷開，再接上放大器。將本機的揚聲器接線放置不用。（按照上面所示的方式，用絕緣膠把不用的線端包起來。）

คุณสามารถต่อเครื่องขยายและอุปกรณ์อื่น ๆ เพื่ออัพเกรดระบบเครื่องเสียงในรถยนต์ของคุณได้

ต่อสายตะกั่วระยะไกล (สีน้ำเงินลายขาว) เข้ากับสายตะกั่วระยะไกลของอุปกรณ์อื่น ๆ เพื่อจะสามารถควบคุมโดยชุดประกอบนี้ได้

สำหรับเครื่องขยายเท่านั้น :

เชื่อมต่อขั้วสายออก ของชุดประกอบนี้เข้ากับขั้วสายเข้าของเครื่องขยาย

ถอดลำโพงออกจากชุดประกอบนี้ แล้วต่อเข้ากับเครื่องขยาย ทั้งสายตะกั่วลำโพงของชุดประกอบนี้ไว้ (พันขั้วของสายตะกั่วที่ไม่ได้ใช้เหล่านี้ให้รอบด้วยเทปพันสายไฟที่จั่วอย่างข้างต้น)

يمكنك توصيل مضخم صوت وجهاز اخر لتحسين اداء جهاز ستيريو السيارة.

اوصل سلك التحكم عن بعد (الازرق المخطط بالابيض) مع سلك التحكم عن بعد للجهاز الاخر بحيث يتم التحكم بالجهاز من خلال هذا الجهاز.

فقط لمضخم الصوت:

اوصل اطراف خرج - الخط لهذا الجهاز مع اطراف دخل - الخط لمضخم الصوت.

افصل السماعات من هذا الجهاز، اوصلهم مع مضخم الصوت. اترك اسلاك سماعات هذا الجهاز بدون استعمال. (غطي اطراف هذه الاسلاك غير المستعملة بشريط عازل، كما هو موضح في الاعلى.)

## Amplifier / 功率放大器 / เครื่องขยาย / مضخم الصوت

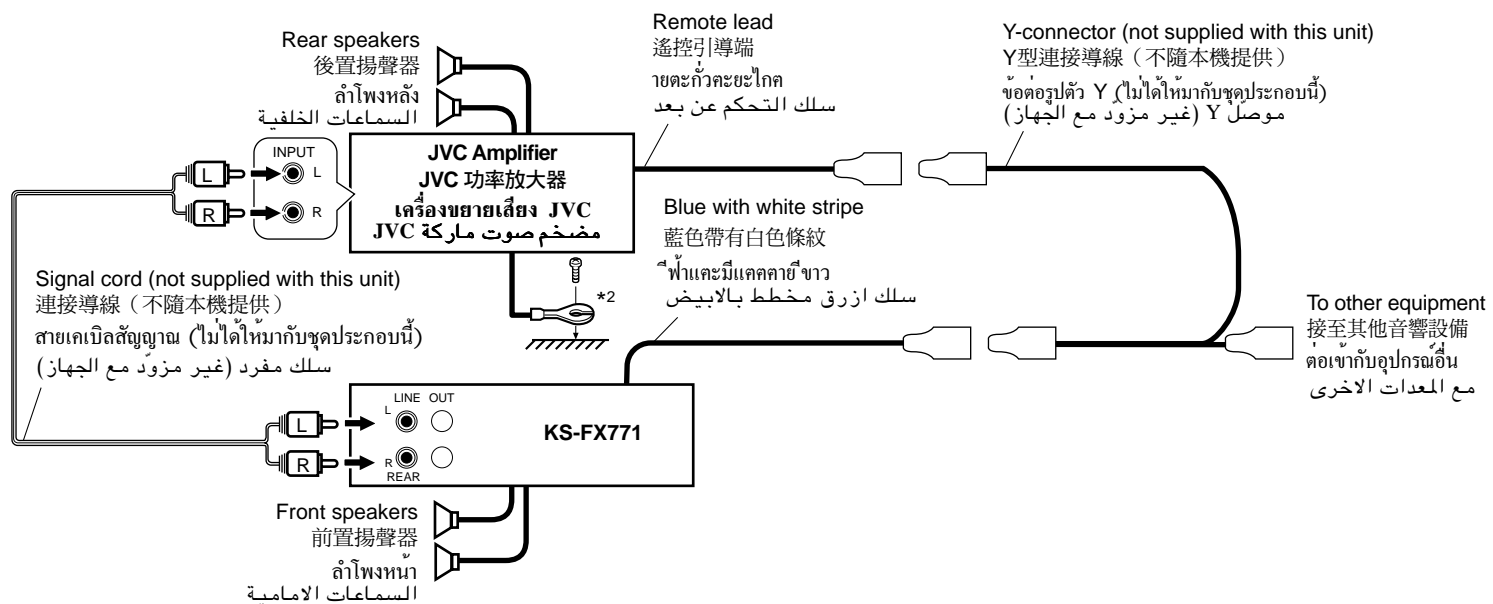

\*2: Firmly attach the ground wire to the metallic body or to the chassis of the car—to the place not coated with paint (if coated with paint, remove the paint before attaching the wire). Failure to do so may cause damage to this unit.

\*2: 將地線與金屬車體或者汽車底盤緊密連接，連接處應該沒有被油漆覆蓋（如果已塗上油漆，在連接電線前，將油漆刮去）。如果不這樣做，可能會損壞本機。

\*2: ต่อลวดสายดินให้แน่นเข้ากับตัวถังเหล็ก หรือตัวถังรถ - ตรงส่วน ที่ไม่มีสีเคลือบ (หากมีสีเคลือบอยู่ ให้ขูดสีออกก่อน ต่อลวดสายดิน) หากไม่ปฏิบัติตามคำแนะนำนี้ เครื่องอาจชำรุดหรือเสียหายได้

\*2: اوصل السلك الارضي بشكل محکم مع هيكل او جسم السيارة المعدني - مع الموضع غير المطلي بالدهان (إذا كان الموضع مطلي بالدهان، ازل الدهان قبل توصيل السلك). في حالة توصيل السلك مع الهيكل دون ازالة الدهان يمكن ان يسبب ذلك ضرر لهذا الجهاز.

## External component / 外接部件 / อุปกรณ์ภายนอก / جهاز الكمبيوتر الخارجي

Line Input Adapter KS-U57 (not supplied with this unit)

線輸入適配器KS-U57（不隨本機提供）

อแดปเตอร์สายสัญญาณเข้า KS-U57 (ไม่ได้ให้มาพร้อมกับชุดประกอบนี้)   
 เม้าهى، دخل الخط KS-U57 (غير مزود مع عذا لجهاز)

Signal cord (not supplied with this unit)

連接導線（不隨本機提供）

สายเคเบิลสัญญาณ (ไม่ได้ให้มาพร้อมกับชุดประกอบนี้)   
 سلك مفرد (غير مزود مع الجهاز)

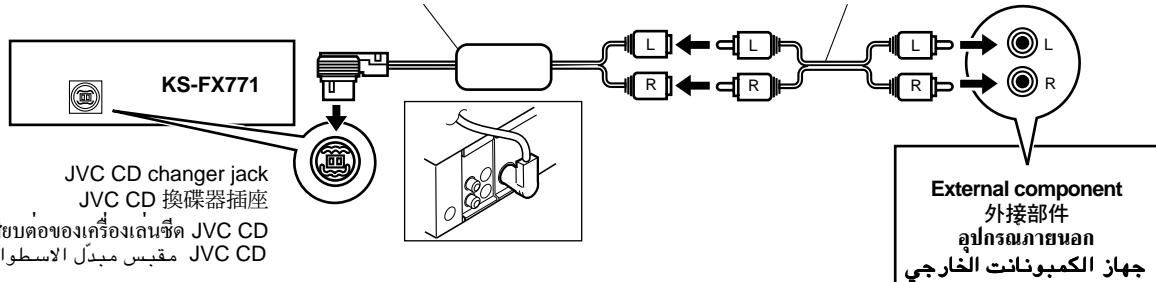

See page 25 in the INSTRUCTIONS (separate volume).

請參閱 25 頁使用說明書（另一冊）

ดูหน้า 25 ของคู่มือการใช้ (ถนนเล่ม)

انظر صفحة ٢٥ من كتيب تعليمات التشغيل (كتاب منفصل)

## Free Manuals Download Website

<http://myh66.com>

<http://usermanuals.us>

<http://www.somanuals.com>

<http://www.4manuals.cc>

<http://www.manual-lib.com>

<http://www.404manual.com>

<http://www.luxmanual.com>

<http://aubethermostatmanual.com>

Golf course search by state

<http://golfingnear.com>

Email search by domain

<http://emailbydomain.com>

Auto manuals search

<http://auto.somanuals.com>

TV manuals search

<http://tv.somanuals.com>