

# JVC



ENGLISH

中文

ไทย

CD RECEIVER

KD-S845

CD 收音組合機

KD-S845

เครื่องเล่น CD

KD-S845

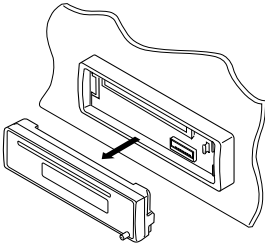
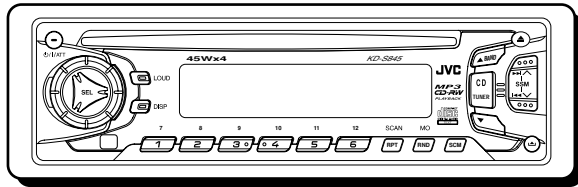

**MP3  
CD-RW  
PLAYBACK**

**COMPACT  
disc  
DIGITAL AUDIO  
TEXT**

For installation and connections, refer to the separate manual.

有關安裝和連接方法，分別參閱操作手冊。

กรุณาดูคู่มือที่แยกต่างหาก ในการติดตั้งและการเชื่อมต่อ

## INSTRUCTIONS 使用說明書 คำแนะนำ

GET0163-001A

[U]

## IMPORTANT FOR LASER PRODUCTS

### Precautions:

1. CLASS 1 LASER PRODUCT
2. **CAUTION:** Invisible laser radiation when open and interlock failed or defeated. Avoid direct exposure to beam.
3. **CAUTION:** Do not open the top cover. There are no user-serviceable parts inside. Leave all servicing to qualified service personnel.
4. **CAUTION:** This CD player uses invisible laser radiation and is equipped with safety switches to prevent radiation emission when unloading CDs. It is dangerous to defeat the safety switches.
5. **CAUTION:** Use of controls, adjustments or performance of procedures other than those specified herein may result in hazardous radiation exposure.

### How to reset your unit

While holding SEL (select), press  $\odot$ /I/ATT (standby/on/attenuator) for more than 2 seconds. This will reset the built-in microcomputer.

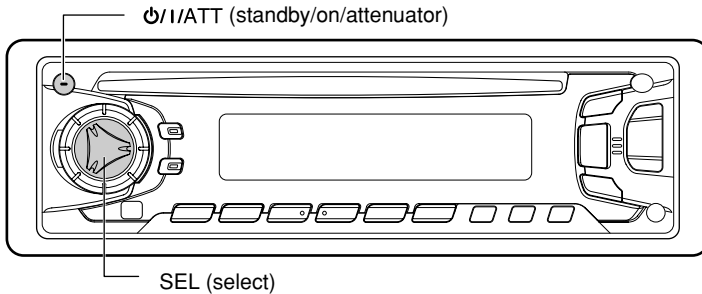

### Notes:

- Your preset adjustments – such as preset channels or sound adjustments – will also be erased.
- If a CD is in the unit, it will eject when you reset the unit. Be careful not to drop the CD.

Thank you for purchasing a JVC product. Please read all instructions carefully before operation, to ensure your complete understanding and to obtain the best possible performance from the unit.

# CONTENTS

How to reset your unit .....	2	<b>MP3 OPERATIONS .....</b>	<b>17</b>
<b>LOCATION OF THE BUTTONS .....</b>	<b>4</b>	Playing an MP3 disc .....	17
Control panel .....	4	Locating a file or particular portion on an MP3 disc .....	18
Remote controller .....	5	Selecting MP3 playback modes .....	19
Preparing the remote controller .....	6	<b>SOUND ADJUSTMENTS .....</b>	<b>21</b>
<b>BASIC OPERATIONS .....</b>	<b>7</b>	Adjusting the sound .....	21
Turning on the power .....	7	Turning on/off the loudness function .....	21
<b>RADIO OPERATIONS .....</b>	<b>8</b>	Using the sound control memory (SCM) ...	22
Listening to the radio .....	8	Storing your own sound adjustments .....	23
Storing stations in memory .....	10	<b>OTHER MAIN FUNCTIONS .....</b>	<b>24</b>
Tuning in to a preset station .....	11	Setting the clock .....	24
Other convenient tuner functions .....	11	Canceling Advanced SCM—SCM LINK ....	25
<b>CD OPERATIONS .....</b>	<b>12</b>	Selecting the level display—LEVEL .....	25
Playing a CD .....	12	Selecting the scroll mode—SCROLL .....	26
Locating a track or a particular portion on a CD .....	13	To turn the tag display on or off— TAG DISP .....	26
Selecting CD playback modes .....	13	Detaching the control panel .....	27
Playing a CD Text .....	14	<b>MAINTENANCE .....</b>	<b>28</b>
Prohibiting CD ejection .....	14	Handling discs .....	28
<b>MP3 INTRODUCTION .....</b>	<b>15</b>	<b>TROUBLESHOOTING .....</b>	<b>29</b>
What is MP3? .....	15	<b>SPECIFICATIONS .....</b>	<b>31</b>
How are MP3 files recorded and played back? .....	15		

## BEFORE USE

### \*For safety....

- Do not raise the volume level too much, as this will block outside sounds, making driving dangerous.
- Stop the car before performing any complicated operations.

### \*Temperature inside the car....

If you have parked the car for a long time in hot or cold weather, wait until the temperature in the car becomes normal before operating the unit.



# LOCATION OF THE BUTTONS

## Control panel

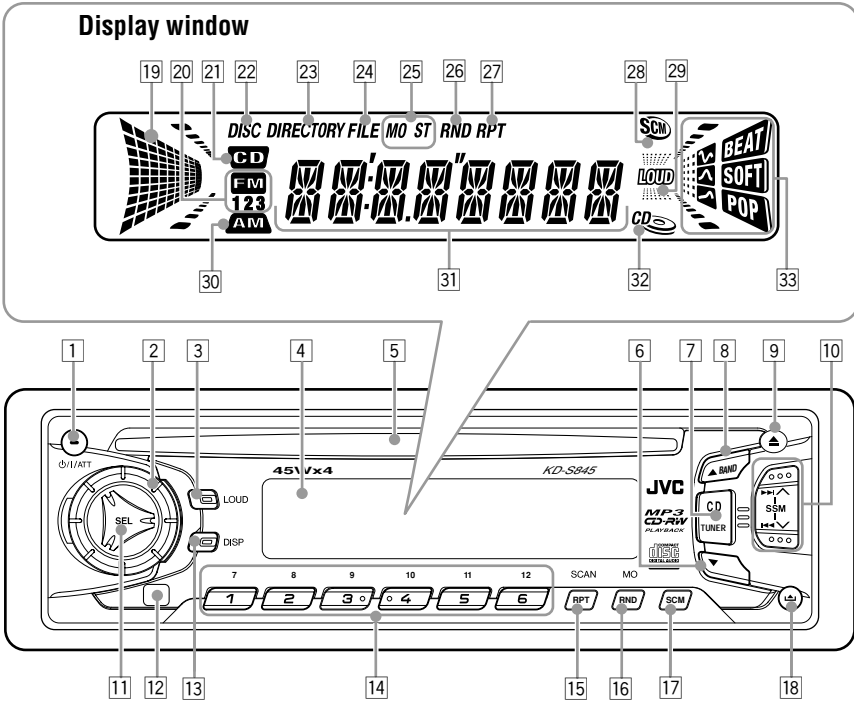

- 1  $\phi$ /I/ATT (standby/on/attenuator) button
- 2 Control dial
- 3 LOUD button
- 4 Display window
- 5 Loading slot
- 6 ▼ (down) button
- 7 CD TUNER button
- 8 ▲ (up) BAND button
- 9 ▲ (eject) button
- 10 ►► / ◀◀ / ◀▼ / ▼ buttons
  - Also functions as SSM buttons when pressed together.
- 11 SEL (select) button
- 12 Remote sensor
- 13 DISP (display) button
- 14 Number buttons
- 15 SCAN
- 16 RPT (repeat) button
- 17 MO (monaural) RND (random) button
- 18 SCM (sound control memory) button
- 19 ▲ (control panel release) button

### Display window

- 19 Volume (or audio) level indicator
- 20 Equalization pattern indicator
- 21 FM band indicator (FM1, FM2, FM3)
- 22 CD source indicator
- 23 DISC indicator
- 24 DIRECTORY indicator
- 25 FILE indicator
- 26 Tuner reception indicators  
MO (monaural), ST (stereo) indicator
- 27 RND (random) indicator
- 28 RPT (repeat) indicator
- 29 SCM (sound control memory) indicator
- 30 LOUD (loudness) indicator
- 31 AM indicator
- 32 Main display
- 33 CD-in indicator
- 34 Sound mode indicators  
BEAT, SOFT, POP



## Remote controller

This unit can be remotely controlled as instructed here (with an **optionally purchased remote controller**). We recommend that you use remote controller RM-RK50 with your unit.

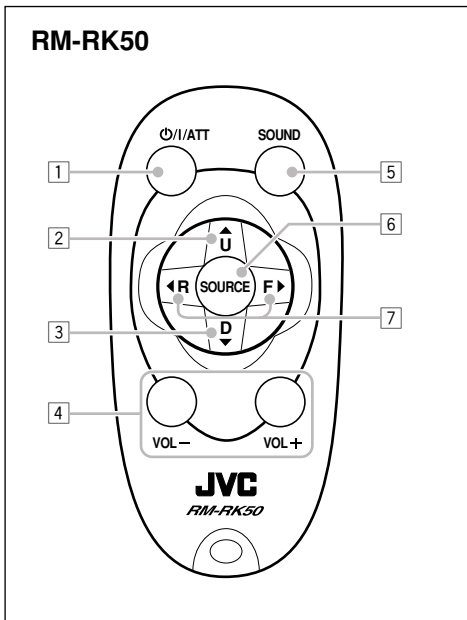

- 1 • Turns on the unit if pressed when the unit is turned off.
  - Turns off the unit if pressed and held until “SEE YOU” appears on the display.
  - Drops the volume level in a moment if pressed briefly.  
Press again to resume the volume.
- 2 • Selects the band while listening to the radio. Each time you press the button, the band changes.
  - Skips to the first file of the next directory while listening to an MP3 disc. Each time you press the button, you can move to the next directory and start playing the first file.
- 3 • Selects the preset stations while listening to the radio.  
Each time you press the button, the preset station number increases, and the selected station is tuned in.
  - Skips to the first file of the previous directory while listening to an MP3 disc. Each time you press the button, you can move to the previous directory and start playing the first file.
- 4 Functions the same as the control dial on the main unit.  
**NOTE:** These buttons cannot be used for the CLOCK H, CLOCK M, SCM LINK, LEVEL, SCROLL and TAG DISP adjustments. (See page 24 – 26).
- 5 Selects the sound mode.  
Each time you press the button, the sound mode changes.
- 6 Selects the source.  
Each time you press the button, the source changes.
- 7 • Searches stations while listening to the radio.
  - Fast-forwards or reverses the track/file if pressed and held while listening to a disc.
  - Skips to the beginning of the next track/file or goes back to the beginning of the current (or previous) tracks/files if pressed briefly while listening to a disc.



## Preparing the remote controller

Before using the remote controller:

- Aim the remote controller directly at the remote sensor on the main unit. Make sure there is no obstacle in between.

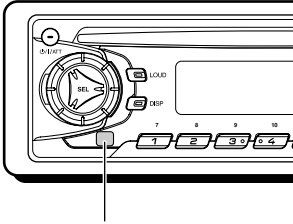

Remote sensor

- Do not expose the remote sensor to strong light (direct sunlight or artificial lighting).

### Installing the battery

When the controllable range or effectiveness of the remote controller decreases, replace the battery.

#### 1. Remove the battery holder.

- 1) Push out the battery holder in the direction indicated by the arrow using a ball-point pen or a similar tool.
- 2) Remove the battery holder.

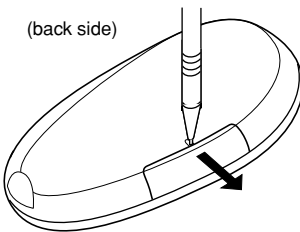

(back side)

#### 2. Place the battery.

Slide the battery into the holder with the + side facing upwards so that the battery is fixed in the holder.

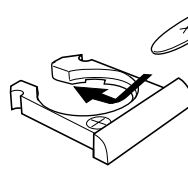

Lithium coin battery  
(product number:  
CR2025)

#### 3. Return the battery holder.

Insert again the battery holder pushing it until you hear a clicking sound.

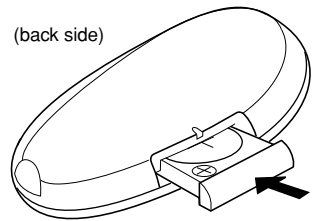

(back side)

#### WARNING:

- Store the battery in a place where children cannot reach.  
If a child accidentally swallows the battery, consult a doctor immediately.
- Do not recharge, short, disassemble or heat the battery or dispose it in a fire.  
Doing any of these things may cause the battery to give off heat, crack or start a fire.
- Do not leave the battery with other metallic materials.  
Doing this may cause the battery to give off heat, crack or start a fire.
- When throwing away or saving the battery, wrap it in tape and insulate; otherwise, the battery may start to give off heat, crack or start a fire.
- Do not poke the battery with tweezers or similar tools.  
Doing this may cause the battery to give off heat, crack or start a fire.

#### CAUTION:

DO NOT leave the remote controller in a place (such as dashboards) exposed to direct sunlight for a long time. Otherwise it may be damaged.

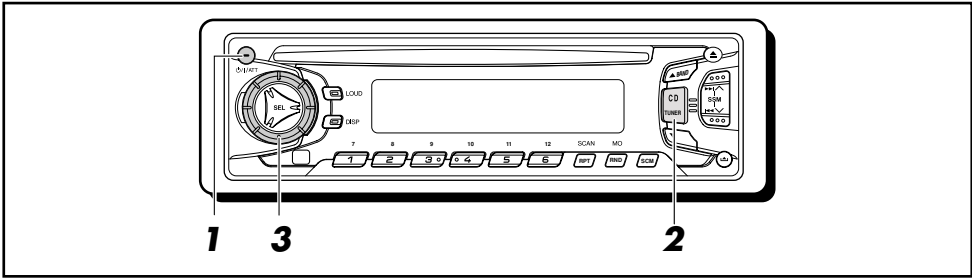

## Turning on the power

### 1 Turn on the power.



**Note on One-Touch Operation:**

When you select a source in step 2 below, the power automatically comes on. You do not have to press this button to turn on the power.

### 2 Select the source.



- To operate the tuner (FM or AM), see pages 8 – 11.
- To play a CD, see pages 12 – 14.
- To play an MP3 disc, see pages 17 – 20.

### 3 Adjust the volume.

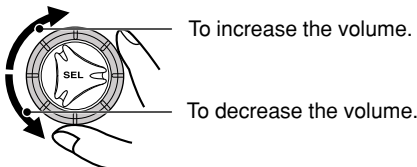

Volume or audio level indicator (See page 25.)



Volume level appears.

### 4 Adjust the sound as you want. (See pages 21 – 23.)

#### To drop the volume in a moment

Press  $\text{⏻}$ /ATT briefly while listening to any source. "ATT" starts flashing on the display, and the volume level will drop in a moment. To resume the previous volume level, press the button briefly again.

- If you turn the control dial clockwise, you can also restore the sound.

#### To turn off the power

Press and hold  $\text{⏻}$ /ATT for more than one second.

**Note:**

When you use this unit for the first time, set the built-in clock correctly, see page 24.

**CAUTION on Volume Setting:**

Discs produce very little noise compared with other sources. If the volume level is adjusted for the tuner, for example, the speakers may be damaged by the sudden increase in the output level. Therefore, lower the volume before playing a disc and adjust it as required during playback.

**About mistracking:**

Mistracking may result from driving on extremely rough roads. This does not damage the unit and the disc, but will be annoying. We recommend that you stop disc playback while driving on such rough roads.



# RADIO OPERATIONS

ENGLISH

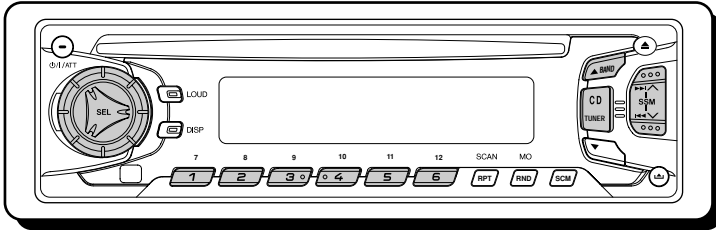

## Listening to the radio

You can use either automatic searching or manual searching to tune in to a particular station.

### Searching a station automatically: Auto search

#### 1 Select the tuner as the source.



- The last selected station is tuned in.

The last selected band appears.

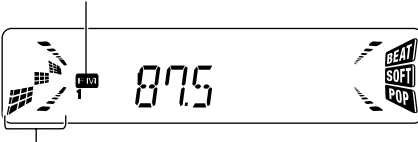

Audio (see page 25) or volume level indicator

#### 2 Select the band (FM1 – 3, AM) if necessary.



#### Note:

This receiver has three FM bands (FM1, FM2, FM3). You can use any one of them to listen to an FM broadcast.

#### 3 Start searching a station.

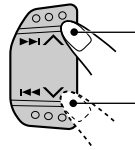

To search stations of higher frequencies.

To search stations of lower frequencies.

When a station is received, searching stops.

To stop searching before a station is received, press the same button you have pressed for searching.



## Searching a station manually: Manual search

### 1 Select the tuner as the source.



- The last selected station is tuned in.

### 2 Select the band (FM1 - 3, AM) if necessary.

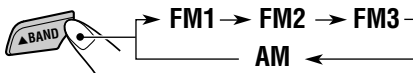

**Note:**

This receiver has three FM bands (FM1, FM2, FM3). You can use any one of them to listen to an FM broadcast.

### 3 Press and hold ►►► ▲ or ◀◀◀ ▼ until “M (manual)” starts flashing on the display.

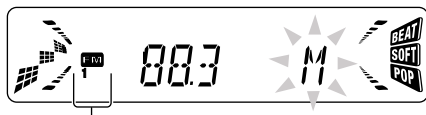
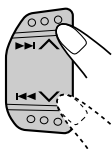

Selected band appears.

### 4 Tune in to a station you want while “M” is flashing.

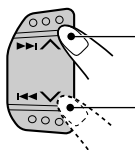

To tune in to stations of higher frequencies.

To tune in to stations of lower frequencies.

- If you release your finger from the button, the manual mode will automatically turn off after 5 seconds.
- If you hold down the button, the frequency keeps changing (in 50 kHz intervals for FM and 9 kHz intervals for AM) until you release the button.

### When an FM stereo broadcast is hard to receive:

Press MO RND (monaural/random) while listening to an FM stereo broadcast.

- Each time you press the button, the MO indicator lights up and goes off alternately.

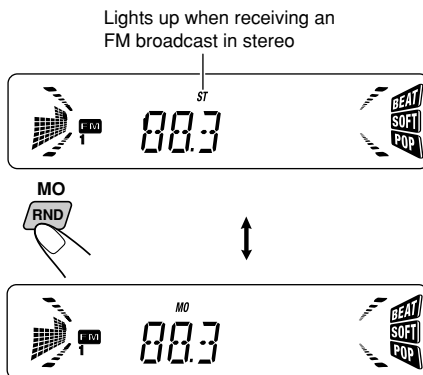

When the MO indicator is lit on the display, the sound you hear becomes monaural but the reception will be improved (the ST indicator goes off).

To restore the stereo effect, press the same button again.



# Storing stations in memory

You can use one of the following two methods to store broadcasting stations in memory.

- Automatic preset of FM stations: SSM (Strong-station Sequential Memory)
- Manual preset of both FM and AM stations

## FM station automatic preset: SSM

You can preset 6 local FM stations in each FM band (FM1, FM2 and FM3).

### 1 Select the tuner as the source.



- The last selected station is tuned in.

### 2 Select the FM band (FM1 - 3) you want to store FM stations into.

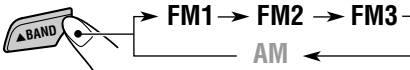

### 3 Press and hold both buttons for more than 2 seconds.

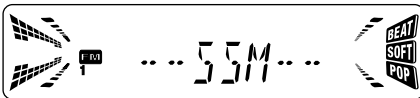

"SSM" appears, then disappears when automatic preset is over.

Local FM stations with the strongest signals are searched and stored automatically in the band number you have selected (FM1, FM2 or FM3). These stations are preset in the number buttons — No.1 (lowest frequency) to No.6 (highest frequency). When automatic preset is over, the station stored in number button 1 will be automatically tuned in.

## Manual preset

You can preset up to 6 stations in each band (FM1, FM2, FM3 and AM) manually.

Ex.: Storing an FM station of 88.3 MHz into the preset number 1 of the FM1 band

### 1 Select the tuner as the source.



- The last selected station is tuned in.

### 2 Select the band (FM1 - 3, AM) you want to store stations into (in this example, FM1).



### 3 Tune in to a station (in this example, of 88.3 MHz).

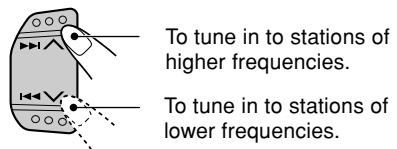

- 4** Press and hold the number button (in this example, 1) for more than 2 seconds.



"P1" flashes for a few seconds.

- 5** Repeat the above procedure to store other stations into other preset numbers.

**Notes:**

- A previously preset station is erased when a new station is stored in the same preset number.
- Preset stations are erased when the power supply to the memory circuit is interrupted (for example, during battery replacement). If this occurs, preset the stations again.

## Tuning in to a preset station

You can easily tune in to a preset station. Remember that you must store stations first. If you have not stored them yet, see "Storing stations in memory" on page 10 and 11.

- 1** Select the tuner as the source.

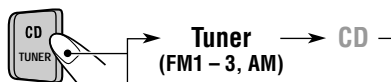

- The last selected station is tuned in.

- 2** Select the band (FM1 – 3, AM) if necessary.

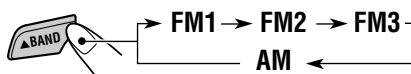

- 3** Select the number (1 – 6) for the preset station you want.

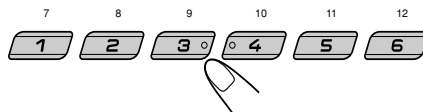

## Other convenient tuner functions

### Scanning broadcast stations



When you press SCAN RPT while listening to the radio, station scanning starts. Each time a broadcast is tuned in, scanning stops for about 5 seconds (tuned frequency number flashes on the display), and you can check what program is now being broadcast.

If you want to listen to that program, press the same button again to stop scanning.



# CD OPERATIONS

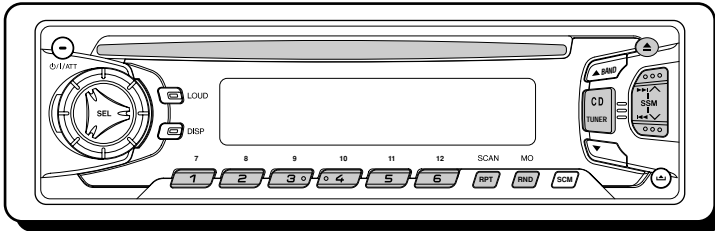

## Playing a CD

### 1 Insert a disc into the loading slot.

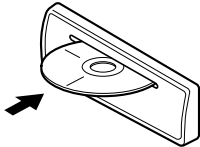

The unit turns on, draws the CD and starts playback automatically.

#### Note on One-Touch Operation:

When a CD is already in the loading slot, pressing the CD TUNER button turns on the unit and starts playback automatically.



Total playing time of the inserted disc      Total track number of the inserted disc

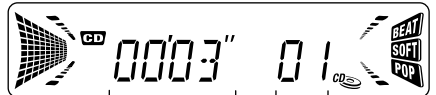

Elapsed playing time      Current track

#### Notes:

- When a CD is inserted upside down, the CD automatically ejects.
- When you play a CD text, the disc title and performer appear on the display. Then the current track and elapsed playing time appears on the display. See also "Playing a CD text" (page 14) and "Selecting the scroll mode—SCROLL" (page 26). If a CD Text includes much text information, some may not appear on the display.

SCM indicator flashes.



The CD-in indicator flashes.

SCM indicator flashes.

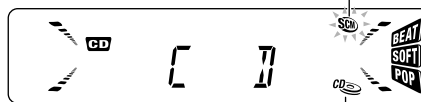

The CD-in indicator lights up.

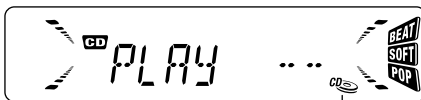

The CD-in indicator lights up.

## To stop play and eject the CD

Press ▲.

CD play stops and the CD automatically ejects from the loading slot.

If you change the source to FM or AM, the CD play also stops (without ejecting the CD this time).

#### Notes:

- If the ejected disc is not removed for about 15 seconds, the disc is automatically inserted again into the loading slot to protect it from dust. (CD play will not start this time.)
- You can eject the CD even when the unit is turned off.



## Locating a track or a particular portion on a CD

### To fast-forward or reverse the track

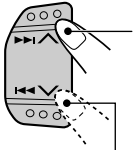

Press and hold **▶▶** **▲**, while playing a CD, to fast-forward the track.

Press and hold **◀◀** **▼**, while playing a CD, to reverse the track.

### To go to the next tracks or the previous tracks

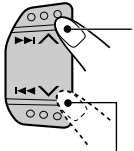

Press **▶▶** **▲** briefly, while playing a CD, to go ahead to the beginning of the next track. Each time you press the button consecutively, the beginning of the next tracks is located and played back.

Press **◀◀** **▼** briefly, while playing a CD, to go back to the beginning of the current track. Each time you press the button consecutively, the beginning of the previous tracks is located and played back.

### To go to a particular track directly

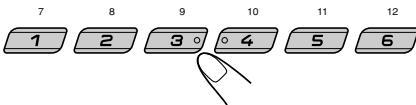

Press the number button corresponding to the track number to start its playback.

- To select a track number from 1 – 6:  
Press 1 (7) – 6 (12) briefly.
- To select a track number from 7 – 12:  
Press and hold 1 (7) – 6 (12) for more than 1 second.

## Selecting CD playback modes

### To play back tracks at random (Random Play)

You can play back all tracks on the CD at random.



Each time you press **MO RND** (monaural/random) while playing a CD, CD random play mode turns on and off alternately.

The RND indicator

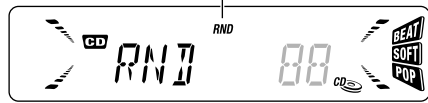

When the random mode is turned on, the RND indicator lights up on the display and a track randomly selected starts playing.

### To play back tracks repeatedly (Repeat Play)

You can play back the current track repeatedly.



Each time you press **SCAN RPT** (scan/repeat) while playing a CD, CD repeat play mode turns on and off alternately.

The RPT indicator

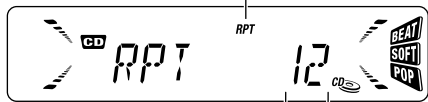

Track number of the currently playing track

When the repeat mode is turned on, the RPT indicator lights up on the display.



## Playing a CD Text

In a CD Text, some information about the disc (its disc title, performer and track title) is recorded. You can show these disc information on the display.

### Select text display mode while playing a CD Text.



Each time you press the button, the display changes as follows:



#### Notes:

- The display shows up to 8 characters at one time and scrolls if there are more than 8 characters. See also "Selecting the scroll mode—SCROLL" on page 26. Some characters or symbols will not be shown (and appear as blanks) on the display. (Ex. "ABC&!d#" ⇒ "ABCA D ")
- When you press DISP (display) while playing a conventional CD, "NO NAME" appears for the disc title/performer and the track title.

## Prohibiting CD ejection

You can prohibit CD ejection and can lock a CD in the loading slot.

### While pressing CD TUNER, press and hold ▲ for more than 2 seconds.



"EJECT" flashes on the display for about 5 seconds, and the CD is locked and cannot be ejected.

To cancel the prohibition and unlock the CD, press ▲ again for more than 2 seconds, while pressing CD TUNER.

"EJECT" appears on the display, and the CD ejects from the loading slot.



## What is MP3?

MP3 is an abbreviation of Motion Picture Experts Group (or MPEG) Audio Layer 3\*. MP3 is simply a file format with a data compression ratio of 1:10 (128 Kbps\*\*). That means, by using MP3 format, one CD-R or CD-RW can contain 10 times as much data volume as a regular CD can.

\* This player is not compatible with the data encoded with Layer 1 and 2 formats.

\*\* Bit rate is the average number of bits that one second of audio data will consume. The unit used is Kbps (1024 bits/second). To get a better audio quality, choose a higher bit rate. The most popular bit rate for encoding is 128 Kbps.

This unit is incorporated with an MP3 decoder. You can play back MP3 files (tracks) recorded on CD-Rs, CD-RWs, and CD-ROMs.

## Compatible with ID3v1

Extra information data such as album title, performer name, song title, recording year, music genre and a brief comment can be stored within an MP3 file.

This unit can show ID3v1 tags (album name, performer name and song title) on the display.

- Some characters cannot be shown correctly.
- This unit is not compatible with ID3v2.

### Other Main Features in this unit:

- Maximum number of directories/files: 289 (Total)
- Available characters: A–Z, 0–9, \_ (underscore)
- Maximum number of characters for file name (ISO 9660 Level 1): 12 (inclusive of separation mark—“.” and extension code—“mp3”)
- (ISO 9660 Level 2): 31 (inclusive of separation mark—“.” and extension code—“mp3”)
- (Joliet): 64 (inclusive of separation mark—“.” and extension code—“mp3”)
- Maximum number of characters for directory name: 64

## Precautions when recording MP3 files on a CD-R or CD-RW

This unit can only read MP3 files that are recorded in the format that is compliant with ISO 9660 Level 1, Level 2 or Joliet.

## How are MP3 files recorded and played back?

MP3 “files (tracks)” can be recorded in “directories (folders)” —in PC terminology. During recording, the files and directories can be arranged in a way similar to arranging files and directories/folders of computer data. “Root” is similar to the root of a tree. Every file and directory can be linked to and be accessed from the root.

Playback order, file search order, and directory search order of the MP3 files recorded on a disc are determined by the writing (or encoding) application; therefore, playback order may be different from the one you have intended while recording the directories and the files.

The illustration on the next page shows an example of how MP3 files are recorded on a CD-R or CD-RW, how they are played back, and how they are searched on this unit.



### Notes:

- *The unit can read a CD-ROM containing MP3 files. However, if non-MP3 files are recorded together with MP3 files, this unit will take a longer time to scan the disc. It may also cause the unit to malfunction.*
- *The unit cannot read or play an MP3 file without the extension code—mp3.*
- *The unit is not compatible with Playlist\*.*

\* A playlist is a simple text file, used on a PC, which enables users to make their own playback order without physically rearranging the files.

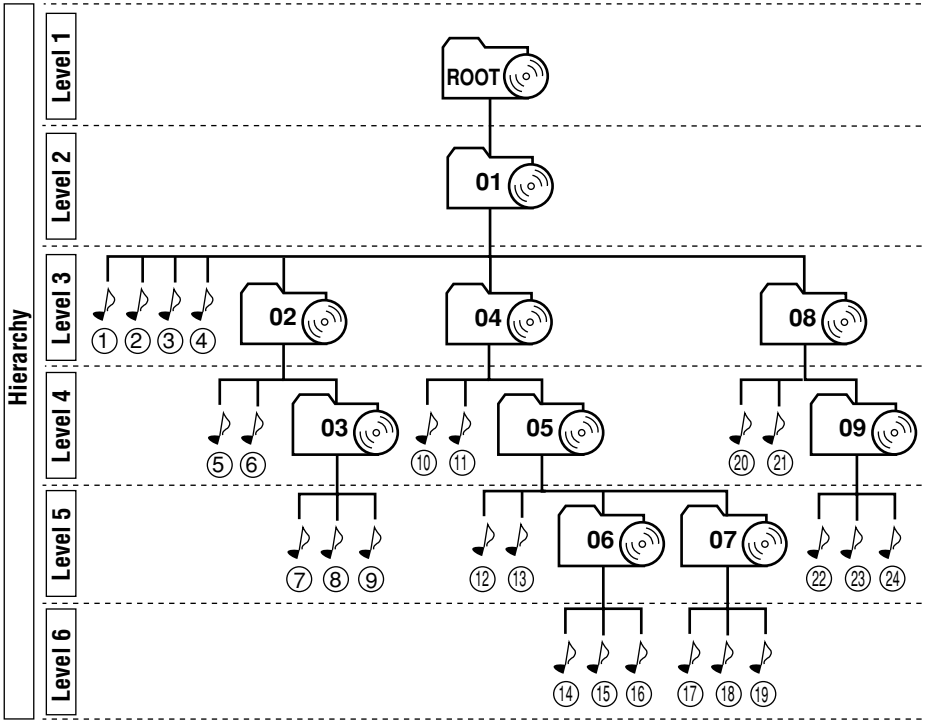
## MP3 directory/file configuration



	: Root
	: Directories
	: MP3 files

**Note:**

There is no limit on the number of the hierarchy levels (nested directories). However up to 8 hierarchy levels is recommended for stable operation.

## MP3 playback/search order (page 18)

- The numbers in circles below the MP3 files (🎵) indicate the playback order and search order of the MP3 files. Normally this unit plays back MP3 files in the recorded order.
- The numbers inside the directories indicate the playback order and search order of the directories on an MP3 disc. Normally this unit plays back MP3 files in the directories in the recorded order.



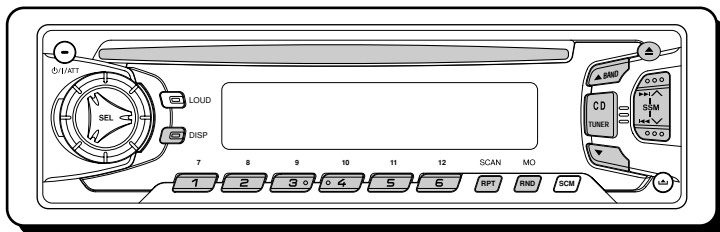

Refer also to "CD OPERATIONS" on pages 12 to 14.

Playback starts automatically from the first file of the first directory once disc check is completed.

## Playing an MP3 disc

### 1 Insert an MP3 disc into the loading slot.

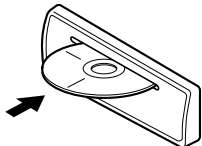

The unit turns on, draws the MP3 disc and starts playback automatically.

#### Note on One-Touch Operation:

When a CD is already in the loading slot, pressing the CD TUNER button turns on the unit and starts playback automatically.

SCM indicator flashes.

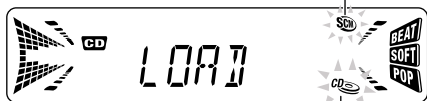

The CD-in indicator flashes.  
SCM indicator flashes.

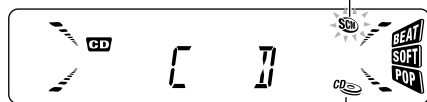

The CD-in indicator lights up.



The CD-in indicator lights up.

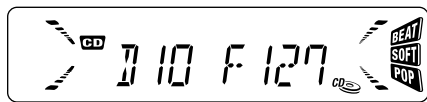

Ex.: When the disc contains 10 directories and 127 MP3 files.

#### Notes:

- All the files on the disc will be played repeatedly until you stop playback—All File Repeat Play.
- MP3 discs require a longer readout time. (It differs due to the complexity of the directory/file configuration.)

### To change the display information



While playing back an MP3 file, you can change the file information shown on the display. Each time you press DISP (display), the display changes to show the following:

- When "TAG DISP" is set to "TAG ON" (initial setting: see page 26)

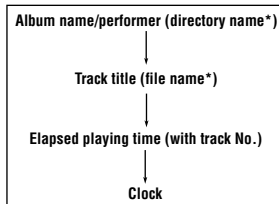

\* If an MP3 file does not have ID3 tags, directory name and file name appear.

- When "TAG DISP" is set to "TAG OFF"

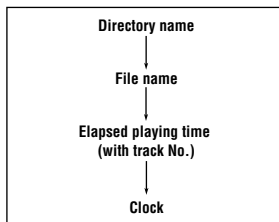

#### Note:

The display shows up to 8 characters at one time and scrolls if there are more than 8 characters. See also "Selecting the scroll mode - SCROLL" on page 26.

## To stop play and eject the disc

Press **▲**.  
 Playback stops and the disc automatically ejects from the loading slot.  
 If you change the source to FM or AM, the playback also stops (without ejecting the disc this time).

## Locating a file or particular portion on an MP3 disc

### To fast-forward or reverse the file

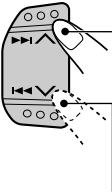

Press and hold **▶▶▶ ▲** while playing an MP3 disc, to fast-forward the file.

Press and hold **◀◀◀ ▼** while playing an MP3 disc, to reverse the file.

### To skip to the next file or the previous files

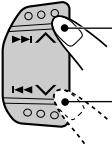

Press **▶▶▶ ▲** briefly while playing, to skip ahead to the beginning of the next file. Each time you press the button consecutively, the beginning of the next file is located and played back. (See "MP3 playback/search order" on page 16.)

Press **◀◀◀ ▼** briefly, while playing, to skip back to the beginning of the current file. Each time you press the button consecutively, the beginning of the previous files is located and played back. (See "MP3 playback/search order" on page 16.)

## To go to a particular directory directly

### IMPORTANT:

To directly select the directories using the number button(s), it is required that directories are assigned 2 digit numbers at the beginning of their directory names. (This can only be done during the recording of CD-Rs or CD-RWs.)

Ex.: If directory name is "01 ABC"

→ press 1 to go to directory 01 ABC

If directory name is "1 ABC,"

pressing 1 does not work

If directory name is "12 ABC"

→ press and hold 6 (12) to go to directory 12 ABC

Press the number button corresponding to the directory number to start playing the first file in the selected directory.

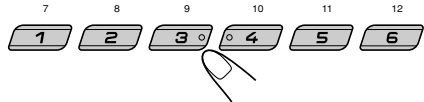

- To select a directory number from 01 – 06: Press 1 (7) – 6 (12) briefly.
- To select a directory number from 07 – 12: Press and hold 1 (7) – 6 (12) for more than 1 second.

### Notes:

- If CD source indicator flashes on the display after you have selected a directory, it means that the directory does not contain any MP3 files.
- You cannot directly select a directory with a number greater than 12.

**To select a particular file in a directory, press** **▶▶▶ ▲** or **◀◀◀ ▼** after selecting the directory.

## To skip to the next directory



Press ▲ (up) briefly while playing an MP3 disc. Each time you press the button consecutively, the next directory is located (and the first file in the directory starts playing, if recorded).

Ex.1: While playing an MP3 file in Directory 01 (see the illustration on page 16)

Ex.2: While playing an MP3 file in Directory 04 (see the illustration on page 16)

**Note:**

If the directory does not contain any MP3 files, it is skipped.

## To skip to the previous directory



Press ▼ (down) briefly while playing an MP3 disc. Each time you press the button consecutively, the previous directory is located (and the first file in the directory starts playing, if recorded).

Ex.1: While playing an MP3 file in Directory 03 (see the illustration on page 16)

Ex.2: While playing an MP3 file in Directory 05 (see the illustration on page 16)

- If you reach the root, playback will not begin.

**Note:**

If the directory does not contain any MP3 files, it is skipped.

## Selecting MP3 playback modes

### To play back files at random (Random Play)

You can playback all tracks on MP3 disc at random.



Each time you press MO RND (monaural/random) while playing an MP3 disc, the random play mode changes as follows.

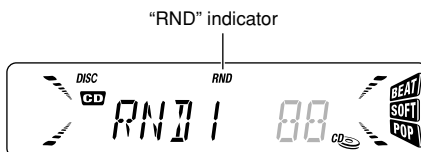

Ex.: When you select "RND1."

Mode	RND Indicator	Plays at random
RND1	Lights	All files of the current directory.
RND2	Flashes	All files on the disc.

## To play back files repeatedly (Repeat Play)

You can play back the current file or all the files in the current directory repeatedly.

SCAN

RPT



Each time you press SCAN RPT (scan/repeat) while playing an MP3 disc, the repeat play mode changes as follows:



"RPT" indicator

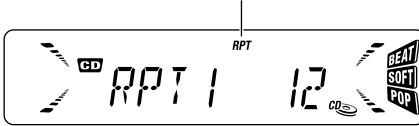

Ex.: When you select "RPT 1."

Mode	RPT Indicator	Plays repeatedly
RPT 1	Lights	The current file (or specified file).
RPT 2	Flashes	All files of the current directory (or specified directory).



## Adjusting the sound

You can adjust the sound characteristics to your preference.

### 1 Select the item you want to adjust.



Each time you press the button, the adjustable items change as follows:

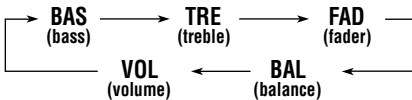

### 2 Adjust the level.

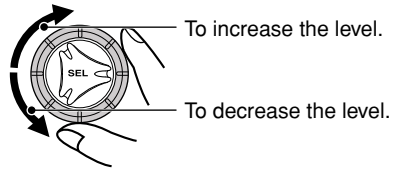

Equalization pattern changes as you adjust the bass or treble.

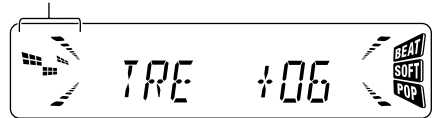

Indication	To do:	Range
BAS	Adjust the bass.	-06 (min.)   +06 (max.)
TRE	Adjust the treble.	-06 (min.)   +06 (max.)
FAD*	Adjust the front and rear speaker balance.	R06 (Rear only)   F06 (Front only)
BAL	Adjust the left and right speaker balance.	L06 (Left only)   R06 (Right only)
VOL	Adjust the volume.	00 (min.)   50 (max.)

\* If you are using a two-speaker system, set the fader level to "00."

#### Note:

Normally, the control dial works as the volume control. So you do not have to select "VOL" to adjust the volume level.

## Turning on/off the loudness function

The human ear is less sensitive to low and high frequencies at low volumes.

The loudness function can boost these frequencies to produce a well-balanced sound at low volume levels.

Each time you press LOUD (loudness), the loudness function turns on and off alternately.

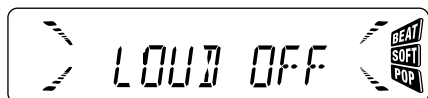
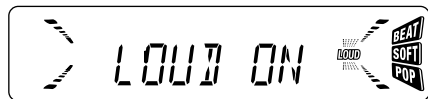



# Using the sound control memory (SCM)

You can select and store a preset sound adjustment suitable for each playback source (Advanced SCM).

## Selecting and storing the sound modes

Once you select a sound mode, it is stored in memory. It will be recalled every time you select the same source and will be shown on the display. A sound mode can be stored for each of the following sources — FM1, FM2, FM3, AM, and CD.

- If you do not want to store the sound mode separately for each playback source, but want to use the same sound mode for all the sources, see “Canceling Advanced SCM—SCM LINK” on page 25.

### Select the sound mode you want.

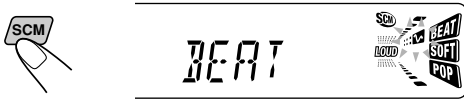

Ex.: When you select “BEAT.”

Each time you press the button, the sound mode changes as follows:



- When “SCM LINK” is set to “LINK ON,” the selected sound mode can be stored in memory for the current source and the effect applies only to the current source.
- When “SCM LINK” is set to “LINK OFF,” the selected sound mode effect applies to any source.

Indication	For:	Preset values		
		BAS	TRE	LOUD
SCM OFF	(Flat sound)	00	00	ON
BEAT	Rock or disco music	+02	00	ON
SOFT	Quiet background music	+01	-03	OFF
POP	Light music	+04	+01	OFF

## Recalling the sound modes

When “SCM LINK” is set to “LINK ON,” select the source.



Each time you change the playback source, the SCM indicator flashes on the display.

The sound mode stored in memory for the selected source is recalled.

### Notes:

- You can adjust each sound mode to your preference, and store it in memory. If you want to adjust and store your original sound mode, see “Storing your own sound adjustments” on page 23.
- To adjust the bass and treble reinforcement levels or to turn on/off the loudness function temporarily, see page 21. (Your adjustments will be canceled if another source is selected.)

## Storing your own sound adjustments

You can adjust the sound modes (BEAT, SOFT, POP) to your preference and store your own adjustments in memory.

- There is a time limit in doing the following procedure. If the setting is canceled before you finish, start from step 1 again.

### 1 Call up the sound mode you want to adjust.

- See "Using the sound control memory (SCM)" on page 22 for details.

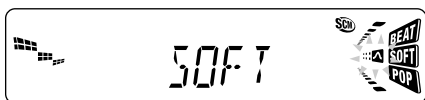

Ex.: When you select "SOFT."

### 2 Select "BAS (Bass)" or "TRE (Treble)".

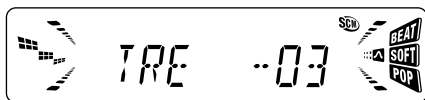

Ex.: When you adjust "TRE (treble)."

### 3 Adjust the bass or treble level.

- See page 21 for details.

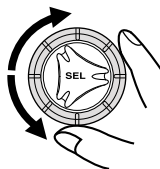

Equalization pattern changes as you adjust the bass or treble.

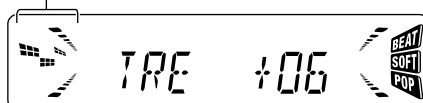

### 4 To turn on or off the loudness function.

- See page 21 for details.



### 5 Press and hold SCM until the sound mode you have selected in step 1 flashes on the display.



Your adjustment made for the selected sound mode is stored in memory.

### 6 Repeat the same procedure to store other sound modes.

### To reset to the factory settings

Repeat the same procedure and reassign the preset values listed in the table on page 22.

## Setting the clock

**1** Press and hold SEL (select) for more than 2 seconds.

“CLOCK H,” “CLOCK M,” “SCM LINK,” “LEVEL,” “SCROLL” or “TAG DISP” appears on the display.



**2** Set the hour.

1 Select “CLOCK H (hour)” if not shown on the display.

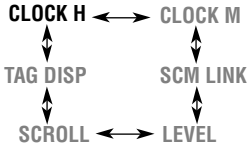
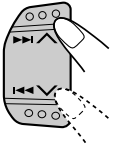

2 Adjust the hour.

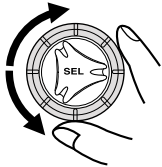

**3** Set the minute.

1 Select “CLOCK M (minute).”

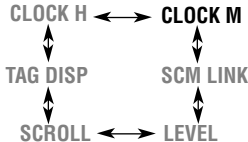
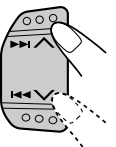

2 Adjust the minute.

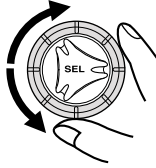

**4** Finish the setting.



**To check the current clock time or change the display mode**



Press DISP (display) repeatedly. Each time you press the button, the display mode changes as follows:

**During tuner operation:**

Frequency ↔ Clock

**During (conventional) CD operation:**

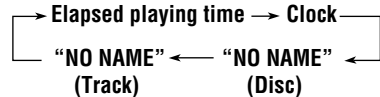

**During CD Text operation:**

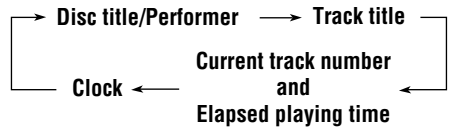

**During MP3 operation:**



**During power off:**

The power turns on and the clock time is shown for 5 seconds. Then, the power turns off.



# Canceling Advanced SCM —SCM LINK

You can cancel the Advanced SCM (Sound Control Memory), and unlink the sound modes and the playback sources.

When shipped from the factory, a different sound mode can be stored in memory for each source so that you can change the sound modes simply by changing the sources.

- LINK ON: Advanced SCM (different sound modes for different sources.)
- LINK OFF: Conventional SCM (one sound mode for all sources.)

## 1 Press and hold SEL (select) for more than 2 seconds.

“CLOCK H,” “CLOCK M,” “SCM LINK,” “LEVEL,” “SCROLL” or “TAG DISP” appears on the display.



## 2 Select “SCM LINK” if not shown on the display.

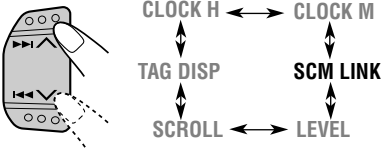

## 3 Select the desired mode—“LINK ON” or “LINK OFF.”

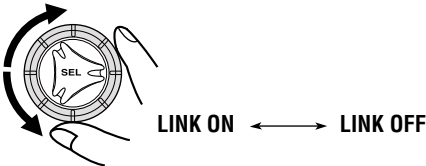

## 4 Finish the setting.



# Selecting the level display —LEVEL

You can select the level display according to your preference.

When shipped from the factory, “AUDIO 2” is selected.

- AUDIO 1: Level meter illuminates from bottom to top.
- AUDIO 2: Alternates level meter (moves from bottom to top) and illumination display.
- OFF: Erases the audio level indicator.

## 1 Press and hold SEL (select) for more than 2 seconds.

“CLOCK H,” “CLOCK M,” “SCM LINK,” “LEVEL,” “SCROLL” or “TAG DISP” appears on the display.



## 2 Select “LEVEL” if not shown on the display.

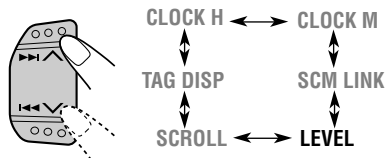

**3** Select the desired mode—"AUDIO 1," "AUDIO 2" or "OFF."

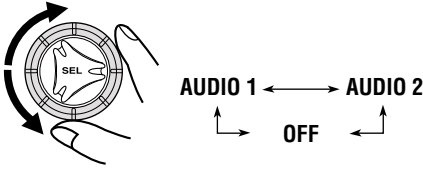

**4** Finish the setting.



**2** Select "SCROLL" if not shown on the display.

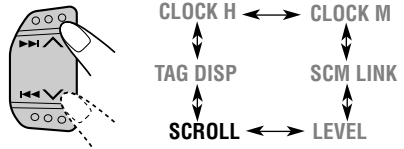

**3** Select the desired mode—"ONCE," "AUTO" or "OFF."

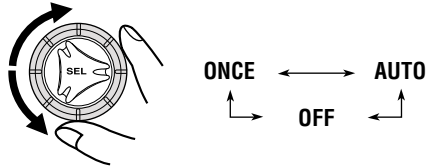

**4** Finish the setting.



## Selecting the scroll mode —SCROLL

You can select the scroll mode for the disc information if it consists of more than 8 characters. When shipped from the factory, Scroll mode is set to "ONCE."

- ONCE: Scrolls only once.
- AUTO: Repeats the scroll (in 5-second intervals).
- OFF: Cancels Scroll mode.

**1** Press and hold SEL (select) for more than 2 seconds.

"CLOCK H," "CLOCK M," "SCM LINK," "LEVEL," "SCROLL" or "TAG DISP" appears on the display.



## To turn the tag display on or off —TAG DISP

An MP3 file can contain file information called "ID3 Tag" where its album name, performer, track title, etc. are recorded.

There are two versions—ID3v1 (ID3 Tag version 1) and ID3v2 (ID3 Tag version 2). This unit is compatible only with ID3v1.

When shipped from the factory, "TAG ON" is selected.

- TAG ON: Turns on the ID3 tag display while playing MP3 files.  
\* If an MP3 file does not have ID3 tags, directory name and file name appear.

**Note:**

*If you change the setting from "TAG OFF" to "TAG ON" while playing an MP3 file, the tag display will be activated when the next file starts playing.*

- TAG OFF: Turns off the ID3 tag display while playing MP3 files. (Only the directory name and file name can be shown.)

## Detaching the control panel

You can detach the control panel when leaving the car.

When detaching or attaching the control panel, be careful not to damage the connectors on the back of the control panel and on the panel holder.

### Detaching the control panel

Before detaching the control panel, be sure to turn off the power.

#### 1 Unlock the control panel.

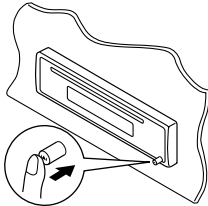

#### 2 Lift and pull the control panel out of the unit.

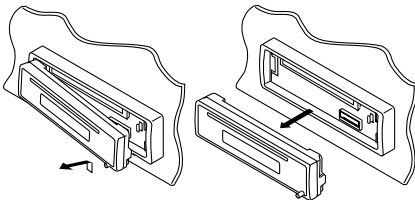

#### 3 Put the detached control panel into the provided case.

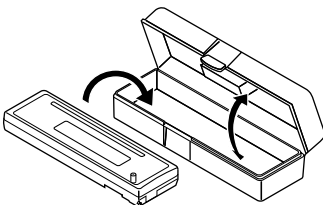

## Attaching the control panel

#### 1 Insert the left side of the control panel into the groove on the panel holder.

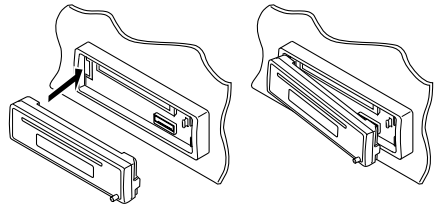

#### 2 Press the right side of the control panel to fix it to the panel holder.

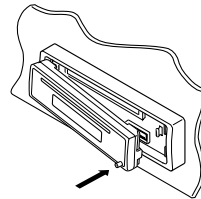

#### Note on cleaning the connectors:

If you frequently detach the control panel, the connectors will deteriorate.

To minimize this possibility, periodically wipe the connectors with a cotton swab or cloth moistened with alcohol, being careful not to damage the connectors.

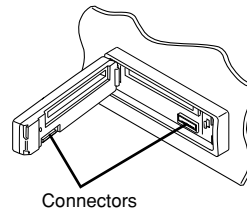



# MAINTENANCE

## Handling discs

This unit has been designed to reproduce CDs, CD-Rs (Recordable), and CD-RWs (Rewritable), and CD Texts.

- This unit is also compatible with MP3 discs.

### How to handle discs

**When removing a disc from its case**, press down the center holder of the case and lift the disc out, holding it by the edges.

- Always hold the disc by the edges. Do not touch its recording surface.

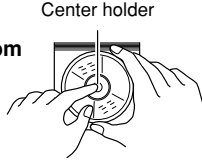

**When storing a disc into its case**, gently insert the disc around the center holder (with the printed surface facing up).

- Make sure to store discs into the cases after use.

### To keep discs clean

A dirty disc may not play correctly. If a disc does become dirty, wipe it with a soft cloth in a straight line from center to edge.

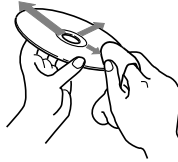

### To play new discs

New discs may have some rough spots around the inner and outer edges. If such a disc is used, this unit may reject the disc.

To remove these rough spots, rub the edges with a pencil or ball-point pen, etc.

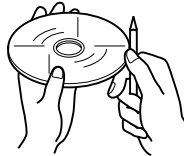

### Moisture condensation

Moisture may condense on the lens inside the unit in the following cases:

- After starting the heater in the car.
- If it becomes very humid inside the car.

Should this occur, the unit may malfunction. In this case, eject the disc and leave the unit turned on for a few hours until the moisture evaporates.

## When playing a CD-R or CD-RW

Before playing back CD-Rs or CD-RWs, read their instructions or cautions carefully.

- Use only "finalized" CD-Rs or CD-RWs.
- Some CD-Rs or CD-RWs may not play back on this unit because of their disc characteristics, and for the following reasons:
  - Discs are dirty or scratched.
  - Moisture condensation on the lens inside the unit.
  - The pickup lens inside the unit is dirty.
- CD-RWs may require a longer readout time since the reflectance of CD-RWs is lower than that of regular CDs.
- CD-Rs or CD-RWs are susceptible to high temperatures or high humidity, so do not leave them inside your car.
- Do not use following CD-Rs or CD-RWs:
  - Discs with stickers, labels, or protective seal stuck to the surface.
  - Discs on which labels can be directly printed by an ink jet printer.

Using these discs under high temperatures or high humidity may cause malfunctions or damage to discs. For example,

- Stickers or labels may shrink and warp a disc.
- Stickers or labels may peel off so discs cannot be ejected.
- Print on discs may get sticky.

Read instructions or cautions about labels and printable discs carefully.

### CAUTIONS:

- Do not insert 8 cm discs (single CDs) into the loading slot. (Such discs cannot be ejected.)
- Do not insert any disc of unusual shape — like a heart or flower; otherwise, it will cause a malfunction.
- Do not expose discs to direct sunlight or any heat source or place them in a place subject to high temperature and humidity. Do not leave them in a car.
- Do not use any solvent (for example, conventional record cleaner, spray, thinner, benzene, etc.) to clean discs.



# TROUBLESHOOTING



What appears to be trouble is not always serious. Check the following points before calling a service center.

	Symptoms	Causes	Remedies
General Playback	<ul style="list-style-type: none"> <li>Disc cannot be played back.</li> </ul>	Disc is inserted upside down.	Insert the disc correctly.
	<ul style="list-style-type: none"> <li>Sound is sometimes interrupted.</li> </ul>	You are driving on rough roads.	Stop playback while driving on rough roads.
		Disc is scratched.	Change the disc.
		Connections are incorrect.	Check the cords and connections.
	<ul style="list-style-type: none"> <li>CD-R/CD-RW cannot be played back.</li> <li>Tracks on the CD-R/CD-RW cannot be skipped.</li> </ul>	CD-R/CD-RW is not finalized.	<ul style="list-style-type: none"> <li>Insert a finalized CD-R/CD-RW.</li> <li>Finalized the CD-R/CD-RW with the component which you used for recording.</li> </ul>
	<ul style="list-style-type: none"> <li>Sound cannot be heard from the speakers.</li> </ul>	The volume level is set to the minimum level.	Adjust it to the optimum level.
		Connections are incorrect.	Check the cords and connections.
	<ul style="list-style-type: none"> <li>"NO DISC" appears on the display .</li> </ul>	No disc in the loading slot.	Insert a disc into the loading slot.
		Disc is inserted incorrectly.	Insert disc correctly.
	<ul style="list-style-type: none"> <li>Disc cannot be ejected.</li> </ul>	Disc is locked.	Unlock the disc (See page 14.)
<ul style="list-style-type: none"> <li>This unit does not work at all.</li> </ul>	The built-in microcomputer may function incorrectly due to noise, etc.	While holding SEL (select), press <b>⏻/ATT</b> for more than 2 seconds to reset the unit. (The clock setting and preset stations stored in memory are erased.) (See page 2.)	
FM/AM	<ul style="list-style-type: none"> <li>SSM (Strong-station Sequential Memory) automatic preset does not work.</li> </ul>	Signals are too weak.	Store stations manually.
	<ul style="list-style-type: none"> <li>Static noise while listening to the radio.</li> </ul>	The antenna is not connected firmly.	Connect the antenna firmly.



Symptoms	Causes	Remedies
<ul style="list-style-type: none"> <li>Disc cannot be played back.</li> </ul>	No MP3 files are recorded on the disc.	Change the disc.
	MP3 files do not have the extension code—mp3 in their file names.	Add the extension code—mp3 to their file names.
	MP3 files are not recorded in the format compliant with ISO 9660 Level 1, 2 or Joliet.	Change the disc. (Record MP3 files using a compliant application.)
<ul style="list-style-type: none"> <li>Files skip, or 00'00" appears and the playback stops.</li> </ul>	Files are encoded in Layer 1 or Layer 2 format.	Insert a disc that contains files encoded in Layer 3 format.
<ul style="list-style-type: none"> <li>Noise is generated.</li> </ul>	The file played back is not an MP3 file (although it has the extension code—mp3).	Skip to another file or change the disc. (Do not add the extension code—mp3 to non-MP3 files.)
<ul style="list-style-type: none"> <li>A longer readout time is required ("CHECK" keeps flashing on the display).</li> </ul>	Readout time varies due to the complexity of the directory/file configuration.	Do not use too many hierarchies and directories. Also, do not record any other types of audio tracks together with MP3 files.
<ul style="list-style-type: none"> <li>Files cannot be played back as you have intended them to play.</li> </ul>	Playback order is determined when the files are recorded.	_____
<ul style="list-style-type: none"> <li>Elapsed playing time is not correct.</li> </ul>	This sometimes occurs during play. This is caused by how the files are recorded on the disc.	_____
<ul style="list-style-type: none"> <li>CD source indicator flashes on the display.</li> </ul>	The current directory does not contain any MP3 files.	Select another directory.
<ul style="list-style-type: none"> <li>"NO FILES" appears on the display for a while, then the disc ejects automatically.</li> </ul>	There are no MP3 files in this disc.	Insert a disc that contains MP3 files.
<ul style="list-style-type: none"> <li>Correct characters are not displayed. (Tag Display, e.g. album name)</li> </ul>	This unit can only display alphabets (capital: A–Z), numbers and a limited number of symbols.	_____

MP3 Playback

## AUDIO AMPLIFIER SECTION

Maximum Power Output:

Front: 45 W per channel

Rear: 45 W per channel

Continuous Power Output (RMS):

Front: 17 W per channel into 4  $\Omega$ , 40 Hz  
to 20 000 Hz at no more than  
0.8% total harmonic distortion.

Rear: 17 W per channel into 4  $\Omega$ , 40 Hz  
to 20 000 Hz at no more than  
0.8% total harmonic distortion.

Load Impedance: 4  $\Omega$  (4  $\Omega$  to 8  $\Omega$  allowance)

Tone Control Range:

Bass:  $\pm 10$  dB at 100 Hz

Treble:  $\pm 10$  dB at 10 kHz

Frequency Response: 40 Hz to 20 000 Hz

Signal-to-Noise Ratio: 70 dB

Line-Out Level/Impedance:

2.0 V/20 k $\Omega$  load (full scale)

Output Impedance: 1 k $\Omega$

## TUNER SECTION

Frequency Range:

FM: 87.5 MHz to 108.0 MHz

AM: 531 kHz to 1 602 kHz

### [FM Tuner]

Usable Sensitivity: 11.3 dBf (1.0  $\mu$ V/75  $\Omega$ )

50 dB Quieting Sensitivity:

16.3 dBf (1.8  $\mu$ V/75  $\Omega$ )

Alternate Channel Selectivity (400 kHz):

65 dB

Frequency Response: 40 Hz to 15 000 Hz

Stereo Separation: 35 dB

Capture Ratio: 1.5 dB

### [AM Tuner]

Sensitivity: 20  $\mu$ V

Selectivity: 35 dB

## CD PLAYER SECTION

Type: Compact disc player

Signal Detection System: Non-contact optical  
pickup (semiconductor laser)

Number of channels: 2 channels (stereo)

Frequency Response: 5 Hz to 20 000 Hz

Dynamic Range: 96 dB

Signal-to-Noise Ratio: 98 dB

Wow and Flutter: Less than measurable limit

MP3 recording format: MPEG 1/2 Audio Layer 3

Max. Bit rate: 320 Kbps

## GENERAL

Power Requirement:

Operating Voltage: DC 14.4 V

(11 V to 16 V allowance)

Grounding System: Negative ground

Allowable Operating Temperature: 0°C to +40°C

Dimensions (W  $\times$  H  $\times$  D):

Installation Size: 182 mm  $\times$  52 mm  $\times$  150 mm

Panel Size: 188 mm  $\times$  58 mm  $\times$  11 mm

Mass: 1.3 kg (excluding accessories)

*Design and specifications are subject to change  
without notice.*

**Having TROUBLE with operation?  
Please reset your unit  
Refer to page of How to reset your unit**

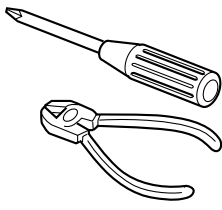

**ENGLISH**      **中文**      **ไทย**      **عربي**

• This unit is designed to operate on 12 V DC, NEGATIVE ground electrical systems.      • 本機僅可使用直流 12V、負極接地的電源系統。  
 • ชุดประกอบชุดนี้ได้รับการออกแบบมาเพื่อใช้งานกับระบบกระแสไฟฟ้าสายดินขั้วลบกระแสตรง 12 โวลต์      • لقدصمم هذا الجهاز ليعمل بواسطة تيار كهربائي مباشر DC، ١٢ فولت، انظمة كهربائية تأريض سالب.

## INSTALLATION (IN-DASH MOUNTING)

## 安裝 (裝設、固定在儀表板內)

## การติดตั้ง (การประกอบแผงหน้าปัทม์เข้า)

## تركيب الجهاز (داخل-تابلو السيارة)

• The following illustration shows a typical installation. However, you should make adjustments corresponding to your specific car. If you have any questions or require information regarding installation kits, consult your JVC car audio dealer or a company supplying kits.      • 下面的圖解表示了典型的安裝程序。然而，您應當做些適當的調整，以便適應您自己的汽車。如果您有問題，或需要有關配套元件的資料，請向 JVC 汽車音響分銷商或配套元件供應公司詢問。  
 • ภาพตัวอย่างต่อไปนี้แสดงถึงการติดตั้งแบบทั่วไป อย่างไรก็ตาม คุณควรปรับแต่งให้เหมาะสมกับรถของคุณเอง หากคุณมีปัญหาคือต้องการข้อมูลเพิ่มเติมเกี่ยวกับชุดติดตั้ง กรุณาปรึกษากับผู้เชี่ยวชาญหรือช่างรถยนต์ JVC ของท่านหรือบริษัทที่จำหน่ายชุดติดตั้งนี้      • يبين الرسم التوضيحي التالي طريقة التركيب المثالية. مع ذلك، يجب عليك عمل تعديلات تطابق نوع السيارة التي تمتلكها. اذا كان هناك استفسارات او حاجة لمعلومات بخصوص ادوات التركيب، يرجى استشارة موزع الاجهزة الصوتية للسيارات ماركة JVC او الشركة الموزعة لهذه الادوات.

- 1 Before mounting:** Press **▲** (Control Panel Release button) to detach the control panel if already attached.  
 \* When shipped from the factory, the control panel is packed in the hard case.  
**2** Remove the trim plate.  
**3** Remove the sleeve after disengaging the sleeve locks.  
 ① Stand the unit.  
**Note:** When you stand the unit, be careful not to damage the fuse on the rear.  
 ② Insert the 2 handles between the unit and the sleeve, as illustrated, to disengage the sleeve locks.  
 ③ Remove the sleeve.  
**Note:** Be sure to keep the handles for future use after installing the unit.  
**4** Install the sleeve into the dashboard.  
 \* After the sleeve is correctly installed into the dashboard, bend the appropriate tabs to hold the sleeve firmly in place, as illustrated.  
**5** Fix the mounting bolt to the rear of the unit's body and place the rubber cushion over the end of the bolt.  
**6** Do the required electrical connections.  
**7** Slide the unit into the sleeve until it is locked.  
**8** Attach the trim plate so that the projection on the trim plate is fixed to the left side of the unit.  
**9** Attach the control panel.
- 1 裝設之前：**如果控制面板已經裝上，按下 **▲** (控制面板解脫按鈕)，拆脫控制面板。  
 \* 當控制面板從工廠裝運時，它是包裝在硬盒中的。  
**2** 取下裝飾框。  
**3** 解開扣板，取下本機的外套機殼。  
 ① 將本機豎起。  
**注意：**您豎起本機時，小心不要損壞底部的保險絲。  
 ② 按圖所示，在本機和外套機殼之間插入兩片板條型的把手，解開外套機殼扣板。  
 ③ 取下外套機殼。  
**注意：**安裝本機後，務必保存好兩片把手，以備將來使用。  
**4** 將外套機殼裝入儀表板內。  
 \* 在外套機殼準確地裝入儀表板之後，按圖所示，彎曲機殼的突舌，把外套機殼牢固在儀表板內。  
**5** 將緊固螺栓旋緊在本機機體上，並將橡膠防震墊套在緊固螺栓的尾部。  
**6** 進行所需的電路連接。  
**7** 將本機滑入外套機殼，直到扣板鎖住為止。  
**8** 將裝飾板接上，並使得裝飾板上的凸塊和本機左邊固定住。  
**9** 裝上控制面板。
- 1 ก่อนประกอบ** กดปุ่ม **▲** (ปลดแผงควบคุม) เพื่อออกจากแผงควบคุม  
 \* เมื่อผลิตภัณฑ์ถูกส่งออกมาจากโรงงาน แผงหน้าปัดจะบรรจุไว้ในกล่องแข็ง  
**2** ถอดแผ่นโลหะขอบแต่งออก  
**3** ถอดปลอกหุ้มออกหลังจากปลดที่ล็อกปลอกหุ้มออกแล้ว  
 ① จับชุดประกอบตั้งขึ้น  
**หมายเหตุ :** เมื่อคุณตั้งชุดประกอบขึ้น ระวังอย่าทำให้ฟิวส์บริเวณส่วนท้ายเสียหาย  
 ② ใส่ที่จับทั้ง 2 อันระหว่างชุดประกอบกับปลอกหุ้ม (ดังภาพ) เพื่อปลดที่ล็อกปลอกหุ้มออกจากกัน  
 ③ ปลดปลอกหุ้มออก  
**หมายเหตุ :** ระวังอย่าให้ที่จับกับตัวสามารถใช้งานได้ต่อไปหลังจากติดตั้งชุดประกอบแล้ว  
**4** ติดตั้งปลอกหุ้มลงในแผงหน้าปัทม์  
 \* หลังจากติดตั้งปลอกหุ้มลงในแผงหน้าปัทม์อย่างถูกต้องแล้ว ดัดร่องให้โค้งพอดีที่ปลอกหุ้มจะถูกล็อกไว้อย่างแน่นหนา (ดังภาพ)  
**5** ติดสลักประกอบบริเวณด้านหลังโครงของชุดประกอบและวางยางกันกระแทกไว้บนส่วนปลายของสลัก  
**6** ต่อสายไฟตามที่กำหนดไว้ทั้งหมด  
**7** เลื่อนชุดประกอบลงในปลอกหุ้มจนเข้ากันได้พอดี  
**8** ใส่แผ่นประดับ โดยให้ขอบของแผ่นประดับยึดติดแน่นกับด้านซ้ายของผลิตภัณฑ์  
**9** ต่อเข้ากับแผงควบคุม
- ١ قبل التركيب:** اضغط الزر **▲** (زر تحرير لوحة التحكم) لفصل لوحة التحكم اذا كانت موصولة سابقا.  
 \* عند الشحن من المصنع، تم وضع لوحة التحكم داخل الصندوق.  
**٢** انزع لوحة الزينة.  
**٣** انزع الهيكل الواقي بعد فصل مثبتات الهيكل الواقي.  
 ① اوقف الجهاز بشكل عمودي.  
**ملاحظة:** عند توقيف الجهاز، تأكد من عدم تضرر او اتلاف الفيزوز الموجود في الجهة الخلفية من الجهاز.  
 ② ادخل المساكيتين بين الجهاز والهيكل الواقي، كما هو مبين في الشكل، لفصل مثبتات الهيكل الواقي.  
 ③ انزع الهيكل الواقي.  
**ملاحظة:** يرجى المحافظة على المساكات من اجل الاستعمال لاحقا بعد تركيب الجهاز.  
**٤** ركب الهيكل الواقي داخل تابلو السيارة.  
 \* بعد تركيب الهيكل الواقي كليا داخل تابلو السيارة بشكل صحيح، انثني الألسنة بشكل مناسب لتثبيت الهيكل الواقي بشكل محكم في المكان الصحيح، كما هو مبين في الشكل.  
**٥** ثبت مسمار التركيب بالجهة الخلفية من هيكل الجهاز وبعد ذلك ضع الحشوة المطاطية فوق نهاية المسمار.  
**٦** اعمل التوصيلات المطلوبة.  
**٧** ادخل الجهاز داخل الهيكل الواقي حتى يثبت بشكل صحيح.  
**٨** ركب لوحة الزينة بحيث يتم تثبيت النتوء الموجود على لوحة الزينة على الجانب الايسر للجهاز.  
**٩** ركب لوحة التحكم.

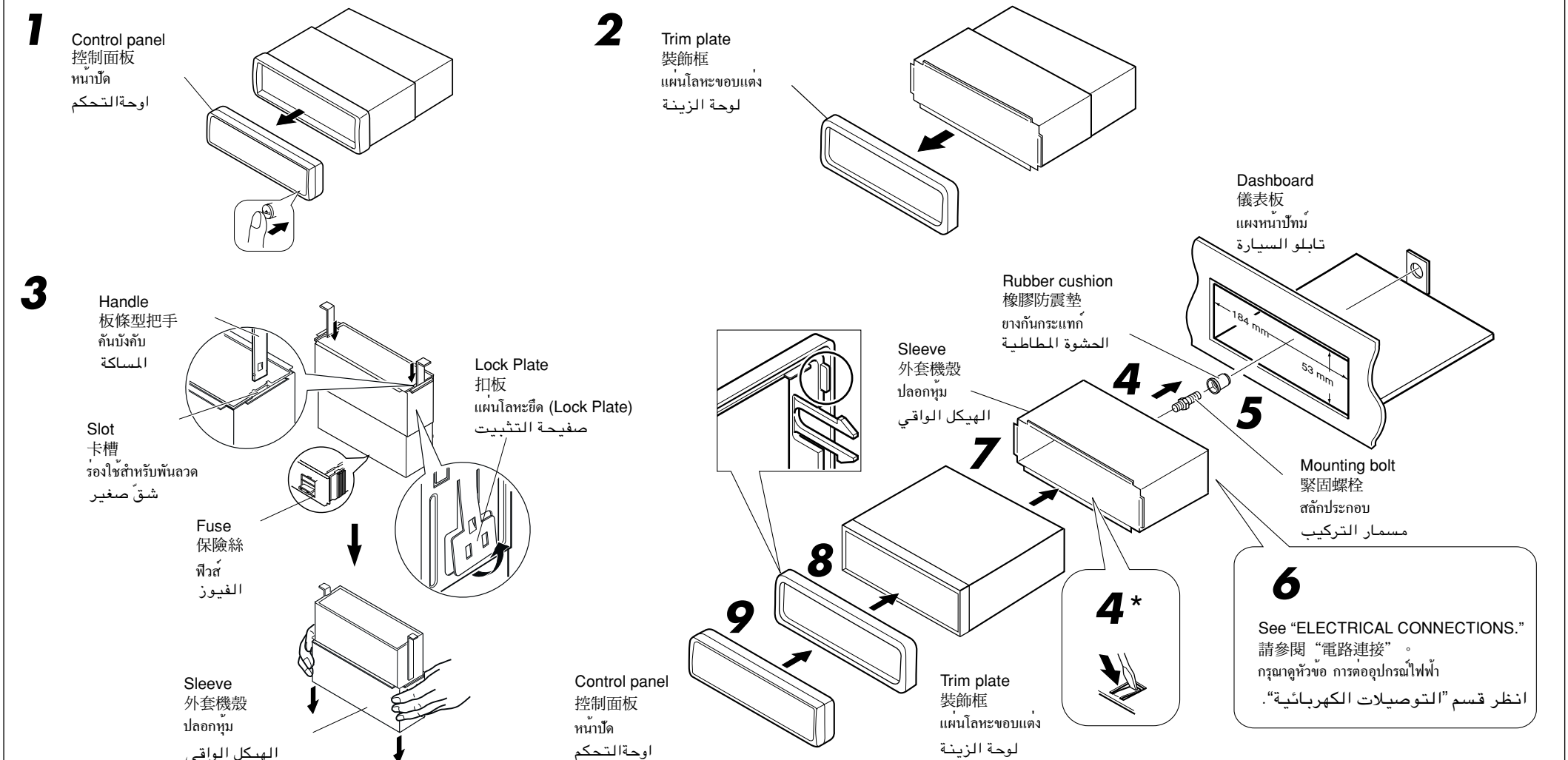



- When using the optional stay
- 若選用支撐架
- เมื่อใช้ตัวยึดแบบเลือกได้ (สามารถเลือกเปิดค้างไว้ได้)
- عند استخدام مسند اضافي للتثبيت

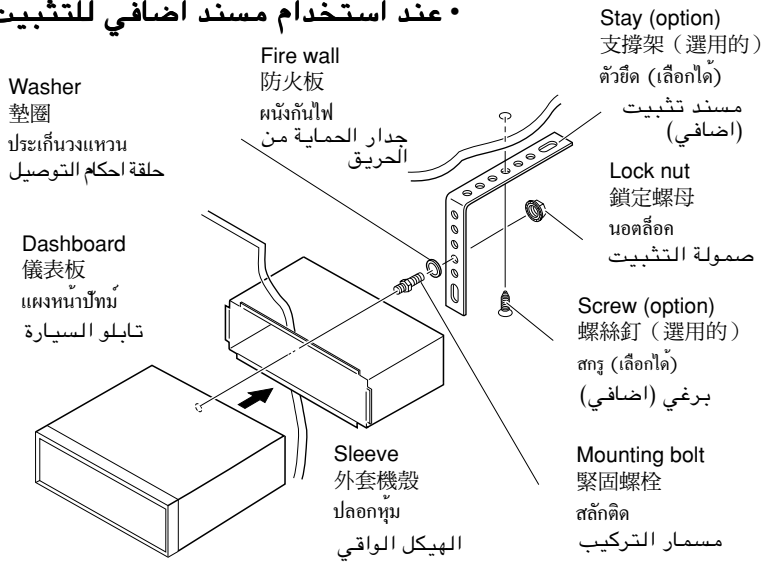

Less than 30°  
少於 30 度  
น้อยกว่า 30 องศา  
اقل من ٣٠ درجة

Install the unit at an angle of less than 30°  
安裝本機時其角度應少於 30 度  
ติดตั้งชุดประกอบ ที่มุมน้อยกว่า 30 องศา  
ركب الجهاز بزاوية اقل من ٣٠ درجة

- When installing the unit without using the sleeve
- 若不使用外套機殼安裝本機
- เมื่อติดตั้งชุดประกอบโดยไม่ใช้ปลอกหุ้ม
- عندما تركيب الجهاز بدون استخدام الهيكل الواقي

In a Toyota for example, first remove the car radio and install the unit in its place.  
以豐田牌 (TOYOTA) 汽車為例：首先取出汽車收音機，然後將本機裝入其空出的位置。  
ตัวอย่างเช่น ในรถยนต์โตโยต้า ให้ถอดวิทยุติดรถยนต์ออกก่อนและติดตั้งชุดประกอบนี้เข้าไปแทน  
على سبيل المثال، في سيارات نوع تويوتا، انزع راديو السيارة اولا بعد ذلك ركب الجهاز في مكانه.

Flat type screws (M5 x 6 mm)\*  
平頭螺絲釘 (M5 x 6 mm)\*  
สกรูหัวเรียบ (M5 x 6 มิลลิเมตร)\*  
براغي مستوية القاعدة (م ٦ x M5)

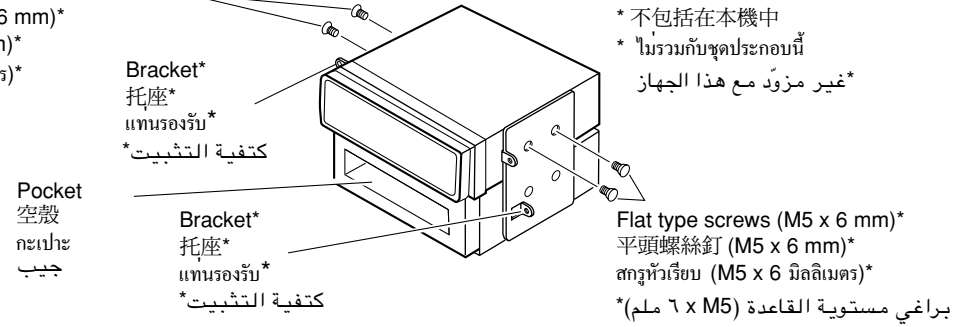

**Note:** When installing the unit on the mounting bracket, make sure to use the 6 mm-long screws. If longer screws are used, they could damage the unit.  
**注意：**把本機安裝在托座上時，務必使用 6mm 長的螺絲釘。如使用過長的螺絲釘，會損壞本機。  
**หมายเหตุ :** เมื่อติดตั้งชุดประกอบลงในแท่นรองรับไว้ ให้ใช้สกรูยาวขนาด 6 มิลลิเมตร ถ้าใช้สกรูยาวกว่านี้อาจทำให้ชุดประกอบเสียหายได้  
**ملاحظة:** عند تركيب الجهاز على كنفية التثبيت، تأكد من استخدام براغي طول ٦ ملم. في حالة استخدام براغي اطول من ٦ ملم، فان ذلك يمكن ان يسبب تلف أو ضرر للجهاز.

### Removing the unit

- Before removing the unit, release the rear section.
- 1 Remove the control panel.
- 2 Remove the trim plate.
- 3 Insert the 2 handles into the slots, as shown. Then, while gently pulling the handles away from each other, slide out the unit. **(Be sure to keep the handles after installing it.)**

### 拆卸本機

- 在拆卸本機前，應將本機後部的固定和連接部分鬆開。
- 1 拆下控制面板。
- 2 取下裝飾框。
- 3 按圖所示，將兩片板條型把手插入卡槽，然後輕穩地從兩側向外拉兩片把手，本機隨之拉出。**(安裝本機後，務必保存好兩片把手)**

### การถอดชุดประกอบ

- ก่อนจะถอดชุดประกอบ ให้ปลดหน้าตัดส่วนท้ายก่อน
- 1 ถอดหน้าปัด
- 2 ถอดแผ่นโลหะขอบแต่ง
- 3 ใส่คั่นบังคับ 2 อันลงในร่องสำหรับใส่พื้นลวด ดังภาพ จากนั้นให้เลื่อนชุดประกอบออก ในขณะที่ค่อย ๆ ดึงคั่นบังคับทั้งสองอันออกจากกัน **(ดูให้คั่นบังคับทั้งสองอันอยู่ในตำแหน่งที่เหมาะสมหลังจากติดตั้งแล้ว)**

### نزع الجهاز من تابلو السيارة

- قبل نزع الجهاز، حرر الجزء الخلفي.
- 1 انزع لوحة التحكم.
- 2 انزع لوحة الزينة.
- 3 ادخل المساكين داخل الشقوق، كما هو مبين في الشكل. بعد ذلك، اثناء سحب المساكين بلطفة بعيدا الواحدة عن الاخرى، اسحب الجهاز الى الخارج. **(تأكد من احتفاظك بالمساكين بعد تركيب الجهاز)**

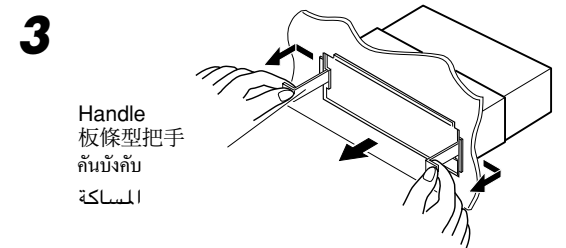
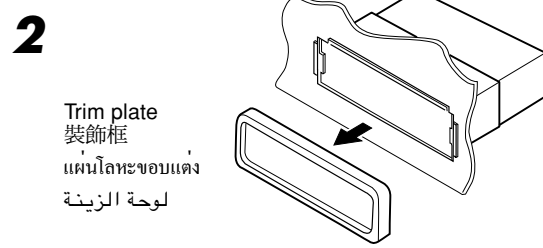
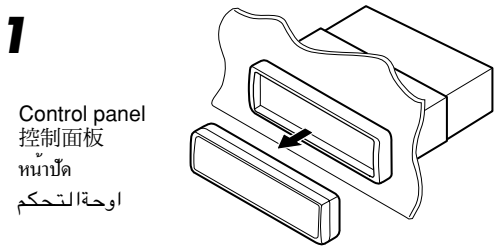

### Parts list for installation and connection

The following parts are provided with this unit. After checking them, please set them correctly.

### 用於安裝和連接的零件裏

下列零件是隨本機提供的。清點以後，正確的將其裝配。

### รายการส่วนประกอบสำหรับติดตั้งและเชื่อมต่อกัน

ส่วนประกอบต่อไปนี้ให้มาพร้อมกับชุดประกอบนี้ หลังจากตรวจสอบแล้ว ปรับตั้งเครื่องให้ถูกต้อง

### قائمة اجزاء التركيب والتوصيل

الاجزاء التالية مزودة مع الجهاز. بعد فحص هذه الاجزاء، يرجى تركيبهم بشكل صحيح.

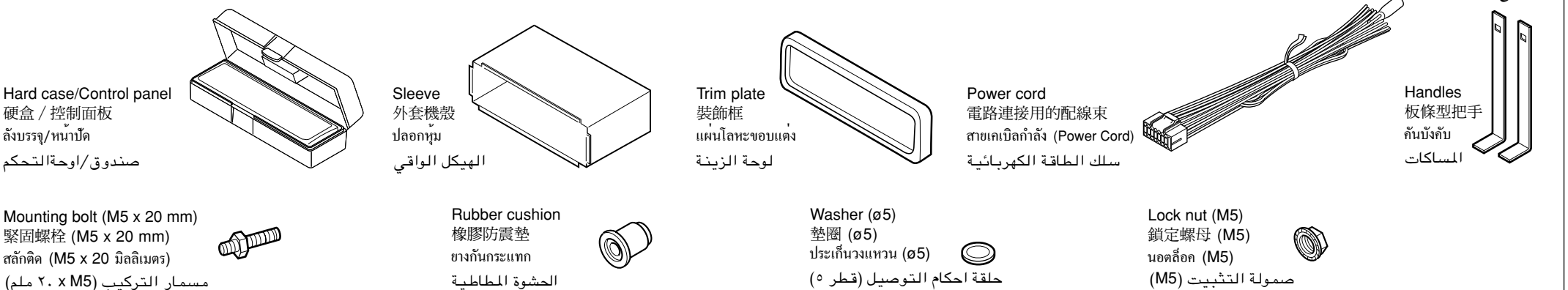

## ELECTRICAL CONNECTIONS

## 電路連接

## การเชื่อมโดยไฟฟ้า

## التوصيلات الكهربائية

To prevent short circuits, we recommend that you disconnect the battery's negative terminal and make all electrical connections before installing the unit. If you are not sure how to install this unit correctly, have it installed by a qualified technician.

為防止短路，建議在安裝本機之前，斷開電池的負極，並把所有電路都連接好。如果您不能確定如何正確地安裝本機，應請合格的技術人員來安裝。

เพื่อป้องกันไฟฟ้าลัดวงจร เราขอแนะนำให้ถอดเอาขั้วลบแบตเตอรี่ออกก่อนและทำการเชื่อมโดยไฟฟ้าทุกจุดก่อนที่จะติดตั้งชุดประกอบ ถ้าคุณไม่แน่ใจว่าติดตั้งชุดประกอบนี้ถูกต้องหรือไม่ให้หาช่างผู้เชี่ยวชาญเป็นผู้ติดตั้ง

لمنع حدوث تقصير في الدوائر الكهربائية، نوصي بفصل طرف البطارية السالب ثم عمل التوصيلات الكهربائية قبل تركيب الجهاز. في حالة عدم معرفتك بكيفية تركيب الجهاز بشكل صحيح، يرجى ترك عملية تركيب الجهاز لشخص مختص ومؤهّل لتركيب مثل هذه الأجهزة.

- Note:**  
This unit is designed to operate on 12 V DC, **NEGATIVE ground electrical systems**. If your vehicle does not have this system, a voltage inverter is required, which can be purchased at JVC car audio dealers.
- Replace the fuse with one of the specified rating. If the fuse blows frequently, consult your JVC car audio dealer.
  - If noise is a problem... This unit incorporates a noise filter in the power circuit. However, with some vehicles, clicking or other unwanted noise may occur. If this happens, connect the unit's **rear ground terminal** (see connection diagram) to the car's chassis using shorter and thicker cords, such as copper braiding or gauge wire. If noise still persists, consult your JVC car audio dealer.
  - Maximum input of the speakers should be more than 45 W at the rear and 45 W at the front, with an impedance of 4 Ω to 8 Ω.
  - **Be sure to ground this unit to the car's chassis.**
  - The heat sink becomes very hot after use. Be careful not to touch it when removing this unit.

- 注意：**  
本機僅可使用直流 12V、負極接地的電源系統。如果您的車輛沒有這一電源系統，則需要一個電壓變換器，可以在 JVC 汽車音響分銷商處買到。
- 把保險絲更換為額定負荷值的保險絲。如果保險絲經常燒壞，請向 JVC 汽車音響分銷商詢問。
  - 若出現噪音問題  
本機在電源回路帶有一個噪音濾波器。但是，在某些車輛上，會出現咯咯聲或其它噪音。如果發生這類情況，將本機後面的接地端子用短而粗的導線，如編織銅線或標準電纜，連接到汽車底盤上（參閱電路接線圖）。如果噪音仍然持續存在，請向 JVC 汽車音響分銷商詢問。
  - 後置揚聲器的最大輸入功率應大於 45 瓦，前置揚聲器的最大功率 45 瓦，其阻抗的為 4 - 8 歐姆。
  - **務必將本機接到汽車底盤上。**
  - 本機使用後，散熱片會很熱。因此，在移出本機時，小心不要觸摸散熱片。

- หมายเหตุ :**  
ชุดประกอบนี้ได้รับการออกแบบมาเพื่อใช้งานกับระบบกระแสไฟฟ้าที่สายดินขั้วลบกระแสตรง 12 โวลท์  
หากรถยนต์ของคุณไม่ได้ใช้ระบบนี้ ต้องใช้เครื่องแปลงกระแสไฟฟ้า ซึ่งสามารถหาซื้อได้จากจากร้านขายเครื่องเสียงรถยนต์ JVC
- ใช้ฟิวส์เฉพาะแทนฟิวส์ หากฟิวส์ขาดบ่อย ให้ปรึกษาจากร้านขายเครื่องเสียงรถยนต์ JVC
  - หากเสียงมีปัญห... ชุดประกอบชุดนี้มีเครื่องกรองเสียงในวงจรกำลัง (Power Circuit) อย่างไรก็ตาม ในบางกรณีอาจเกิดเสียงที่ไม่พึงปรารถนาขึ้นได้ หากปัญหานี้เกิดขึ้น ให้ถอดขั้วสายดินด้านหลังของชุดประกอบ (ดูแผนภูมิการต่อเชื่อม) ออก
  - บัสเชสของรถยนต์โดยสายเคเบิลที่สั้นและหนากว่า เช่น สายไฟเครื่องวัดหรือสายประสานทองแดง เป็นต้น หากยังมีเสียงอยู่ก็ให้ปรึกษาจากร้านขายเครื่องเสียงรถยนต์ JVC
  - กระแสไฟฟ้ากำลังสูงสุดบริเวณส่วนหลังควรเกินกว่า 45 วัตต์และบริเวณส่วนหน้า 45 วัตต์ และมีค่าความหน่วง 4 - 8 โอห์ม
  - **ตรวจสอบให้แน่ใจว่าได้ต่อชุดประกอบชุดนี้ลงในเชสซีรถยนต์แล้ว**
  - แผ่นระบายความร้อนจะร้อนมากหลังจากใช้ ระวังอย่าไปสัมผัสเมื่อถอดชุดประกอบนี้

- ملاحظة:**  
لقد صمم هذا الجهاز ليعمل بواسطة تيار كهربائي مباشر DC، ١٢ فولت، انظمة كهربائية تاريز سالب. في حالة عدم وجود مثل هذا النظام في سيارتك، يجب استخدام محول فولتاج، ويمكن شراء هذا المحول من وكلاء الاجهزة الصوتية للسيارات ماركة JVC.
- استبدال الفيوز بأخر يحمل نفس القياسات الموصوفة. اذا تكرر احتراق الفيوز، يرجى استشارة وكلاء الاجهزة الصوتية للسيارات ماركة JVC. اذا كان الضجيج هو المشكلة...
  - يستخدم هذا الجهاز فلتر ضجيج داخل دائرة الطاقة الكهربائية. مع ذلك، في بعض السيارات، يمكن ان يحدث نوع من الطقطقة أو الضجيج غير المرغوب. في حالة حدوث مثل ذلك، اوصل طرف التاريز الموجود في خلفية الجهاز (انظر رسم التوصيل) مع هيكل السيارة بواسطة استخدام اسلاك اقصر واسمك، مثل سلك النحاس المجلول أو سلك مقياسي. في حالة عدم توقف الطقطقة أو الضجيج، يرجى استشارة وكلاء الاجهزة الصوتية للسيارات ماركة JVC.
  - يجب ان يكون الحد الاقصى لدخل السماعات اكثر من ٤٥ واط للسماعات الخلفية و ٤٥ واط للسماعات الامامية، مع ممانعة بين ٤ الى ٨ اوم.
  - **تأكد من تاريز الجهاز مع هيكل السيارة.**
  - تصبح صفيحة خفض الحرارة ساخنة جدا بعد الاستخدام. تأكد من عدم ملامستها عند نزع الجهاز.

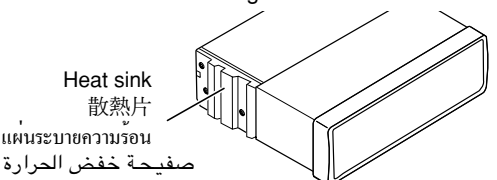

A Typical Connections / 典型的接線方法 / การเชื่อมต่อแบบปกติ / التوصيلات النموذجي

Before connecting: Check the wiring in the vehicle carefully. Incorrect connection may cause serious damage to this unit. The leads of the power cord and those of the connector from the car body may be different in colour.

接線前：仔細檢查汽車內的線路。不正確的接線會導致本機嚴重損壞。電力線的引線和車身的連接器引線在顏色上可能有所不同。

- 1 Connect the colored leads of the power cord to the car battery, speakers and automatic antenna (if any) in the following sequence:
1 Black: ground
2 Yellow: to car battery (constant 12 V)
3 Red: to an accessory terminal
4 Blue: to automatic antenna (250 mA max.)
5 Blue with white stripe: to remote lead of other equipment or automatic antenna if any (200 mA max.)
6 Others: to speakers

- 1 按下述順序將配線束各個不同色標的導線接頭分別接至電池、揚聲器和自動升降天線（如有裝設）：
1 黑色：接地
2 黃色：接至車裝電池（恆定 12V）
3 紅色：接至保險絲單元內的附屬端子
4 藍色：接至自動升降天線（最大 250 毫安）
5 藍色帶有白色條紋：如有其他裝置，和其裝置上的遙控線或自動升降天線連接起來（最大 200 毫安）
6 其他：接至揚聲器

ก่อนทำการเชื่อมต่อ : ตรวจสอบการเดินสายไฟในรถยนต์อย่างระมัดระวัง อย่าให้ผิดพลาดในการเชื่อมต่อชุดประจอบชุดนี้ การเชื่อมต่อผิดพลาดอาจทำให้เกิดความเสียหายร้ายแรงกับชุดประกอบนี้ได้

- 1 เชื่อมต่อสายเคเบิลสีต่าง ๆ ของสายเคเบิลกำลัง (Power Cord) เข้ากับแบตเตอรี่ ลำโพง และสายอากาศ อัตโนมัติในรถยนต์ (ถ้ามี) ตามลำดับต่อไปนี้
1 สีดำ : สายดิน
2 สีเหลือง : ต่อกับแบตเตอรี่รถยนต์ (12 โวลท์คงที่)
3 สีแดง : ต่อกับขั้วส่วนประกอบ
4 สีฟ้า : ต่อเข้ากับเสาอากาศอัตโนมัติ (ขนาดสูงสุด 250 mA)
5 สีน้ำเงินลายขาว : สีน้ำเงินลายขาว ต่อกับสายเคเบิลรีโมทของอุปกรณ์อื่น ๆ หรือ ถ้ามีสายอากาศอัตโนมัติ (ขนาดสูงสุด 200 mA)
6 สีอื่น ๆ : ต่อกับลำโพง

قبل البدء بالتوصيل: تأكد من شبكة الاسلاك في السيارة بدقة حتى لا يحدث خطأ في عملية توصيل الجهاز. يمكن ان يسبب التوصيل الخاطئ الى حصول عطل حقيقي للجهاز.

- يمكن ان يختلف لون سلك الطاقة الكهربائية وسلك الموصل عن لون هيكل السيارة.
1 اوصل الاسلاك الملونة لسلك تزويد الطاقة الكهربائية بطارية السيارة، السماعات والهوائي الاوتوماتيكي (ان وجد) حسب التسلسل التالي.
2 السلك الاسود: مع الارض (مع هيكل السيارة)
3 السلك الاصفر: مع بطارية السيارة (ثابت 12 فولت)
4 السلك الاحمر: مع الطرف الاضافي
5 السلك الازرق المخطط بالابيض: مع سلك التحكم عن بعد للجهاز الاخر او الهوائي الاوتوماتيكي ان وجد (الحد الاقصى 250 ميلي امبير)
6 السلك الازرق المخطط بالابيض: مع المعدات الاخرى: يستعمل ايضا عندما يتطلب تشغيل الهوائي الاوتوماتيكي طاقة اكثر من 200 ميلي امبير.
7 الاسلاك الاخرى: مع السماعات
8 اوصل سلك الهوائي.
9 اخيرا، اوصل حامل الاسلاك مع الجهاز.

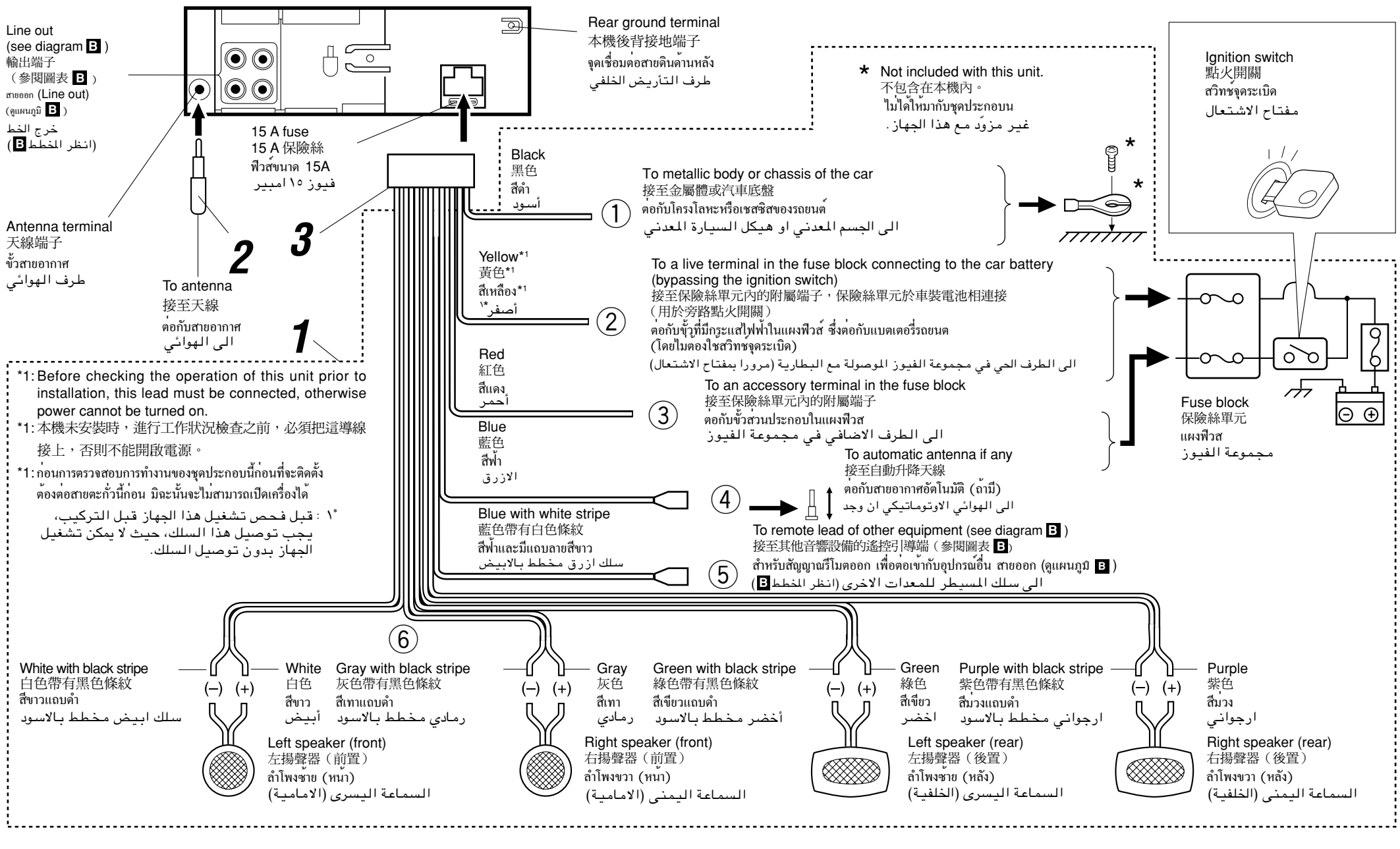

PRECAUTIONS on power supply and speaker connections:

電源和揚聲器接線注意事項：

- DO NOT connect the speaker leads of the power cord to the car battery; otherwise, the unit will be seriously damaged.
Connect the black lead (ground), yellow lead (to car battery, constant 12 V), and red lead (to an accessory terminal) correctly.
BEFORE connecting the speaker leads of the power cord to the speakers, check the speaker wiring in your car.
- If the speaker wiring in your car is as illustrated in Fig. 1 and Fig. 2 below, DO NOT connect the unit using that original speaker wiring.
- If the speaker wiring in your car is as illustrated in Fig. 3, you can connect the unit using the original speaker wiring in your car.

- 切勿把揚聲器導線接頭接至電池，否則本機將會嚴重損壞。
正確地連接黑色導線接頭（接地）、黃色導線接頭（接車裝電池，恆定12V）和紅色導線接頭（接至保險絲單元的附屬端子）。
在把揚聲器導線接頭接至揚聲器之前，檢查您汽車上的揚聲器線路：
- 如果您汽車上揚聲器線路象圖1和圖2所示，不要使用原裝的揚聲器線路。
- 如果您汽車上揚聲器線路象圖3所示，可使用原裝的揚聲器線路與本機相連接。
- 如果您不能確定您汽車上揚聲器線路，請向您的汽車分銷商詢問。

ข้อควรระวังสำหรับการต่อแหล่งจ่ายกำลังและลำโพง:

- อย่าต่อสายเคเบิลกำลังของลำโพงเข้ากับแบตเตอรี่รถยนต์ มิฉะนั้นชุดประกอบจะได้รับความเสียหายมาก
ตรวจสอบสายเคเบิลสีให้ถูกต้อง: สีดำ (สายดิน), สีเหลือง (เข้ากับแบตเตอรี่รถยนต์ที่มีกำลังคงที่ 12 โวลท์) และสีแดง (เข้ากับขั้วส่วนประกอบ)
ก่อนที่จะต่อสายเคเบิลกำลังของลำโพงเข้ากับลำโพง ให้ตรวจสอบการเดินสายไฟในรถยนต์ของคุณให้เรียบร้อยเสียก่อน
- หากการเดินสายไฟในรถยนต์ของคุณเป็นเหมือนในรูปภาพที่ 1 และรูปภาพที่ 2 ดังข้างล่างนี้ อย่าต่อชุดประกอบที่ให้การเดินสายไฟในรถยนต์แบบดั้งเดิม นั้น ชุดประกอบจะได้รับความเสียหายมาก ให้จัดการเดินสายไฟใหม่ เพื่อที่จะสามารถต่อชุดประกอบเข้ากับลำโพงตามรูปภาพที่ 3 ได้
- หากการเดินสายไฟในรถยนต์ของคุณเป็นเหมือนในรูปภาพที่ 3 คุณสามารถต่อชุดประกอบที่ให้การเดินสายไฟในรถยนต์ของคุณได้เลย
- หากคุณไม่แน่ใจว่าการเดินสายไฟในรถยนต์ของคุณเป็นแบบใด ให้ปรึกษาคู่มือขายรถยนต์ของคุณ

تنبيهات حول تزويد الطاقة الكهربائية وتوصيل السماعات:

- لا توصل اسلاك تزويد طاقة السماعات مع بطارية السيارة، لان ذلك يؤدي الى حصول ضرر للسماعات.
1 اوصل السلك الاسود (الارضى)، والسلك الاصفر (مع بطارية السيارة، ثابت 12 فولت)، والسلك الاحمر (مع الطرف الاضافي) بشكل صحيح.
2 قبل توصيل اسلاك تزويد طاقة السماعات مع السماعات، افحص شبكة اسلاك السماعات داخل سيارتك.
3 اذا كانت شبكة اسلاك السماعات داخل سيارتك كما هي مبينة في الشكل 1 والشكل 2 الموجودة في الاسفل، لا توصل الجهاز بواسطة استخدام شبكة اسلاك السماعات الاصلية. اذا تم توصيل الجهاز بهذه الطريقة، سيؤدي ذلك الى حصول ضرر. اعد عمل شبكة اسلاك السماعات بحيث يمكنك توصيل الجهاز مع السماعات كما هو مبيين في الشكل 3.
4 اذا كانت شبكة اسلاك السماعات داخل سيارتك كما هي مبينة في الشكل 3، يمكنك توصيل الجهاز بواسطة استخدام شبكة اسلاك السماعات الاصلية داخل سيارتك.
5 في حالة عدم معرفتك بشبكة اسلاك السماعات داخل سيارتك، استشر الوكيل او ذوي الخبرة بهذا الخصوص.

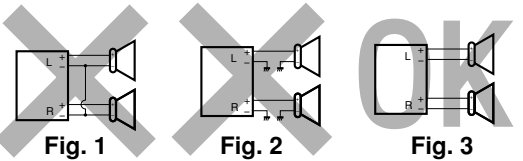



## Free Manuals Download Website

<http://myh66.com>

<http://usermanuals.us>

<http://www.somanuals.com>

<http://www.4manuals.cc>

<http://www.manual-lib.com>

<http://www.404manual.com>

<http://www.luxmanual.com>

<http://aubethermostatmanual.com>

Golf course search by state

<http://golfingnear.com>

Email search by domain

<http://emailbydomain.com>

Auto manuals search

<http://auto.somanuals.com>

TV manuals search

<http://tv.somanuals.com>