

JVC



ENGLISH

FRANÇAIS

CD RECEIVER RECEPTEUR CD

KD-G612/KD-G611/KD-G511



MP3

WMA



**COMPACT
disc
DIGITAL AUDIO
TEXT**

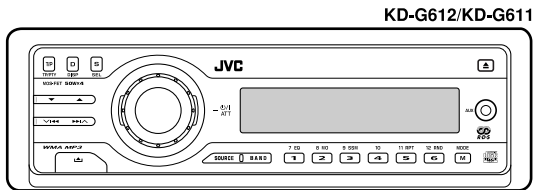
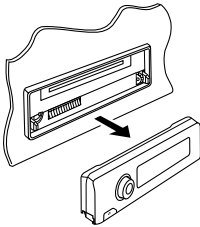

KD-G511

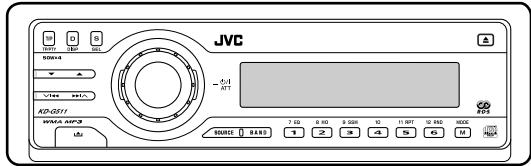

For canceling the display demonstration, see page 8.
Pour annuler la démonstration des affichages, référez-vous à la page 8.

For installation and connections, refer to the separate manual.
Pour l'installation et les raccordements, se référer au manuel séparé.

INSTRUCTIONS MANUEL D'INSTRUCTIONS

GET0266-003A
[EX/EU]

Thank you for purchasing a JVC product.

Please read all instructions carefully before operation, to ensure your complete understanding and to obtain the best possible performance from the unit.

IMPORTANT FOR LASER PRODUCTS

1. CLASS 1 LASER PRODUCT
2. **CAUTION:** Do not open the top cover. There are no user serviceable parts inside the unit; leave all servicing to qualified service personnel.
3. **CAUTION:** Visible and invisible laser radiation when open and interlock failed or defeated. Avoid direct exposure to beam.
4. REPRODUCTION OF LABEL: CAUTION LABEL, PLACED OUTSIDE THE UNIT.

CAUTION : Visible and invisible laser radiation when open and interlock failed or defeated. AVOID DIRECT EXPOSURE TO BEAM.	ADVARSEL : Synlig og usynlig laserstråling når maskinen er åben eller interlocken fejler. Undgå direkte eksponering til stråling. (e)	VARNING : Synlig och osynlig laserstråling när den öppnas och spärren är urkopplad. Beträkta ej strålen. (s)	VARO : Avattassa ja suojalukitus ohitettuna tai viallisena olet alitilina näkyvälle ja näkymättömälle lasersäteilylle. Valita säteen kohdistumista suoraan itseesi. (f)
---	--	---	--

Warning:

If you need to operate the receiver while driving, be sure to look ahead carefully or you may be involved in a traffic accident.

How to reset your unit

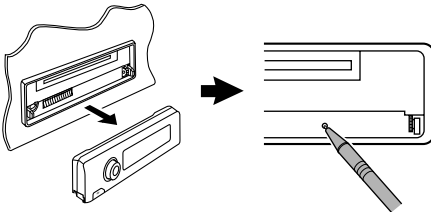

This will reset the microcomputer. Your preset adjustments will also be erased.

How to forcibly eject a disc

If a disc cannot be recognized by the receiver or cannot be ejected, ejects the disc as follows.



“PLEASE” and “EJECT” appear alternately on the display.

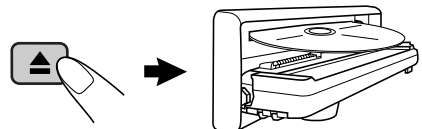

- If this does not work, try to reset your receiver.
- Be careful not to drop the disc when it ejects.

Note: Only for [EX] model users in UK and European countries

For security reasons, a numbered ID card is provided with this receiver, and the same ID number is imprinted on the receiver's chassis. Keep the card in a safe place, as it will help the authorities to identify your receiver if stolen.

Contents

How to reset your unit	2	Sound adjustments	20
How to forcibly eject a disc	2	Selecting preset sound modes	
How to read this manual	4	(C-EQ: custom equalizer)	20
How to use the M MODE button.....	4	Adjusting the sound	21
Control panel		General settings — PSM	22
— KD-G612/KD-G611/KD-G511....	5	Basic procedure	22
Parts identification	5	Other main functions	25
Remote controller — RM-RK50 ...	6	Assigning titles to the sources	25
Main elements and features	6	Detaching the control panel.....	26
Getting started.....	7	External component operations... 27	
Basic operations.....	7	Playing an external component	27
Canceling the display demonstrations ...	8	DAB tuner operations	28
Setting the clock	8	Listening to the DAB tuner	28
Radio operations	9	Storing DAB services in memory.....	29
Listening to the radio.....	9	Tuning in to a preset DAB service	29
Storing stations in memory	10	Tracing the same programme	
Listening to a preset station	10	—Alternative Reception	29
FM RDS operations	11	Maintenance	30
Searching for your favorite FM RDS		More about this receiver	31
programme	11	Troubleshooting	34
Storing your favorite programmes.....	12	Specifications	37
Using the standby receptions.....	12		
Tracking the same programme			
—Network-Tracking Reception	13		
Disc operations	14		
Playing a disc in the receiver	14		
Playing discs in the CD changer	15		
Other main functions	17		
Changing the display information	18		
Selecting the playback modes.....	19		

The receiver is equipped with the steering wheel remote control function.

- See the Installation/Connection Manual (separate volume) for connection.

*For safety....

- Do not raise the volume level too much, as this will block outside sounds, making driving dangerous.
- Stop the car before performing any complicated operations.

*Temperature inside the car....

If you have parked the car for a long time in hot or cold weather, wait until the temperature in the car becomes normal before operating the unit.

How to read this manual

The following methods are used to make the explanations simple and easy-to-understand:

- Some related tips and notes are explained in “More about this receiver” (see pages 31 – 33).
- Button operations are mainly explained with the illustrations as follows:

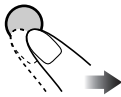
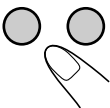
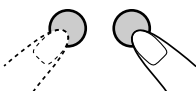
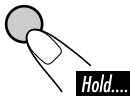
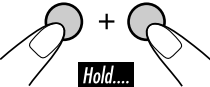
	Press briefly.
	Press repeatedly.
	Press either one.
	
	Press and hold until your desired response begins.
	Press and hold both buttons at the same time.

The following marks are used to indicate...



: Built-in CD player operations.



: External CD changer operations.

How to use the M MODE button

If you press M MODE, the receiver goes into functions mode, then the number buttons and ▲/▼ buttons work as different function buttons.

Ex.: When number button 2 works as MO (monaural) button.

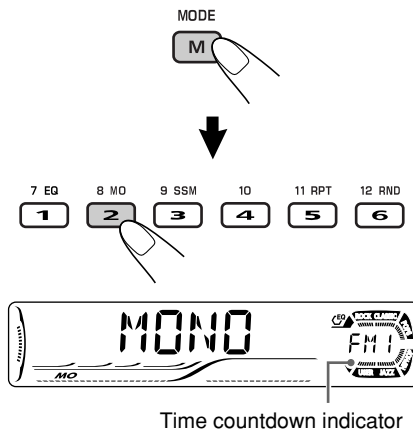

To use these buttons for original functions again after pressing M MODE, wait for 5 seconds without pressing any of these buttons until the functions mode is cleared.

- Pressing M MODE again also clears the functions mode.

Caution on volume setting:

Discs produce very little noise compared with other sources. Lower the volume before playing a disc to avoid damaging the speakers by the sudden increase of the output level.

Parts identification

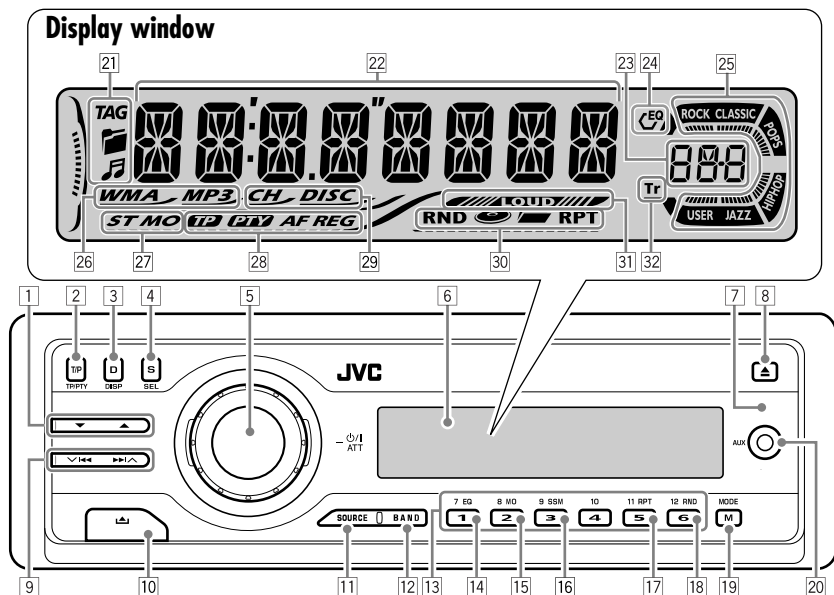

- 1 ▲ (up) / ▼ (down) buttons
- 2 T/P TP/PTY (traffic programme/programme type) button
- 3 D DISP (display) button
- 4 S SEL (select) button
- 5
 - Control dial
 - ϕ /I ATT (standby/on attenuator) button
- 6 Display window
- 7 Remote sensor
 - *DO NOT* expose the remote sensor to strong light (direct sunlight or artificial lighting).
- 8 ▲ (eject) button
- 9 ▼ ◀▶▶▶ ▲ buttons
- 10 \blacktriangle (control panel release) button
- 11 SOURCE button
- 12 BAND button
- 13 Number buttons
- 14 EQ (equalizer) button
- 15 MO (monaural) button
- 16 SSM (Strong-station Sequential Memory) button
- 17 RPT (repeat) button
- 18 RND (random) button
- 19 M MODE button
- 20 AUX (auxiliary) input jack
 - *Only for KD-G612/KD-G611.*
 - *NOT compatible with digital signals.*

Display window

- 21 Disc information indicators—TAG (ID3 Tag), \blacktriangle (folder), \blacktriangle (track/file)
- 22 Main display
- 23 Source display / Volume level indicator
- 24 EQ (equalizer) indicator
- 25 Sound mode (C-EQ: custom equalizer) indicators—ROCK, CLASSIC, POPS, HIP HOP, JAZZ, USER
 - ||||| also works as the time countdown indicator and level meter during play (see page 23).
- 26 Disc type indicators—WMA, MP3
- 27 Tuner reception indicators—ST (stereo), MO (monaural)
- 28 RDS indicators—TP, PTY, AF, REG
- 29 Playback source indicators—
 - CH: *Lights up only when CD-CH is selected as the playback source.*
 - DISC: *Lights up for the built-in CD player.*
- 30 Playback mode / item indicators—RND (random), ||||| (disc), \blacktriangle (folder), RPT (repeat)
- 31 LOUD (loudness) indicator
- 32 Tr (track) indicator

Remote controller — RM-RK50

- RM-RK50 is supplied for KD-G612/KD-G611.
- KD-G511 can be remotely controlled as instructed here (with an optionally purchased remote controller—recommended to use RM-RK50).

■ Installing the lithium coin battery (CR2025)

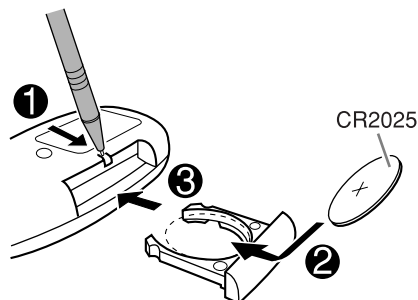

- When operating, aim the remote controller directly at the remote sensor on the receiver. Make sure there is no obstacle in between.

Warning:

- Store the battery in a place where children cannot reach to avoid risk of accident.
- To prevent the battery from over-heating, cracking, or starting a fire:
 - Do not recharge, short, disassemble, or heat the battery or dispose of it in a fire.
 - Do not leave the battery with other metallic materials.
 - Do not poke the battery with tweezers or similar tools.
 - Wrap the battery with tape and insulate when throwing away or saving it.

Caution:

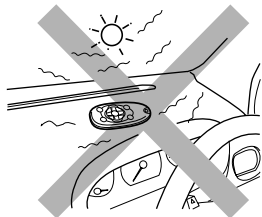

Main elements and features

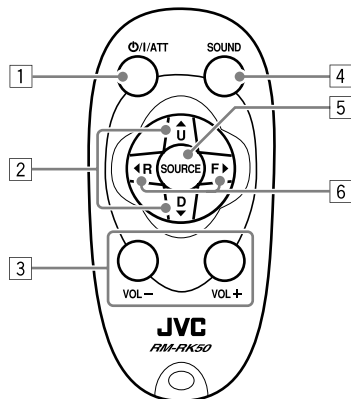

- 1 Φ /I/ATT (standby/on/attenuator) button
 - Turns on and off the power and also attenuates the sound.
- 2 \blacktriangle U (up) / D (down) \blacktriangledown buttons
 - \blacktriangle U: Changes the FM/AM/DAB bands.
 - D \blacktriangledown : Changes the preset stations (or services).
 - Changes the folder of the MP3/WMA discs.
 - While playing an MP3 disc on an MP3-compatible CD changer:
 - Changes the disc if pressed briefly.
 - Changes the folder if pressed and held.
- 3 VOL - / VOL + buttons
 - Adjusts the volume level.
- 4 SOUND button
 - Selects the sound mode (C-EQ: custom equalizer).
- 5 SOURCE button
 - Selects the source.
- 6 \blacktriangleleft R (reverse) / F (forward) \blacktriangleright buttons
 - Searches for stations (or services) if pressed briefly.
 - Searches for ensembles if pressed and held.
 - Fast-forwards or reverses the track if pressed and held.
 - Changes the tracks of the disc.

Basic operations

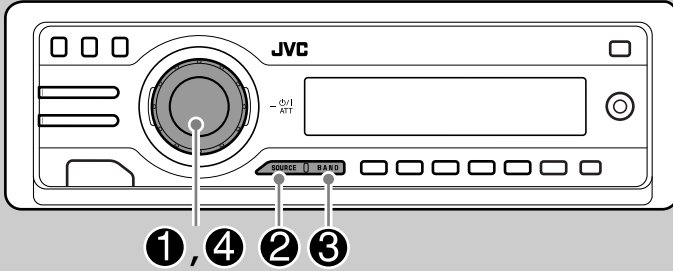

* The control panel illustrations used for explanation in this manual is KD-G612/ KD-G611.

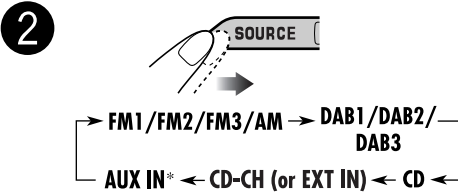
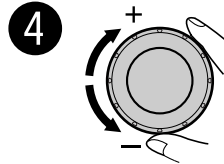
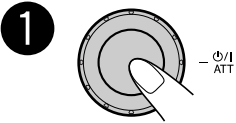

You cannot select some sources if they are not ready.

* Only for KD-G612/KD-G611.

3

- For FM/AM tuner only

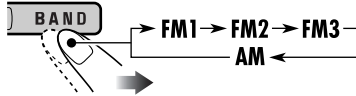

- For DAB tuner only

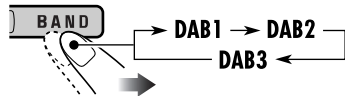

Volume level appears.

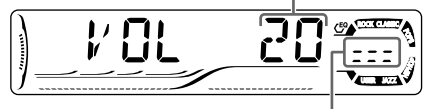

Volume level indicator

5 Adjust the sound as you want.
(See pages 20 and 21.)

To drop the volume in a moment (ATT)

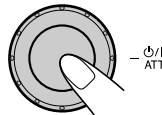

To restore the sound, press it again.

To turn off the power

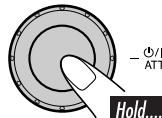

Canceling the display demonstrations

If no operations are done for about 20 seconds, display demonstration starts.

[Initial: DEMO ON]—see page 22.

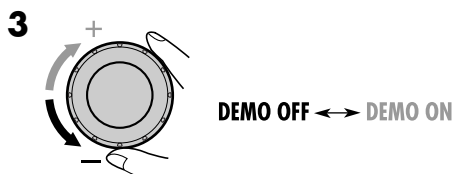
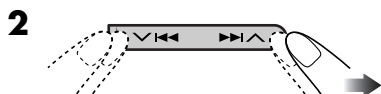

4 Finish the procedure.



To activate the display demonstration

In step 3 above...

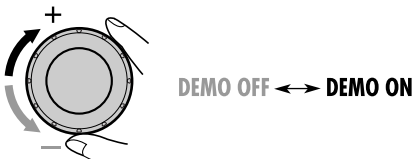

Setting the clock



2 Set the hour, minute, and clock system.

- 1 Select "CLOCK H" (hour), then adjust the hour.
- 2 Select "CLOCK M" (minute), then adjust the minute.
- 3 Select "24H/12H," then select "24H" (hour) or "12H" (hour).

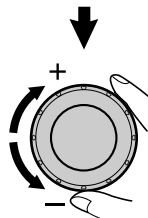
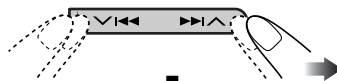

3 Finish the procedure.



To check the current clock time when the power is turned off



Listening to the radio

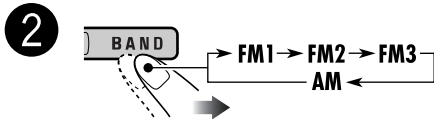
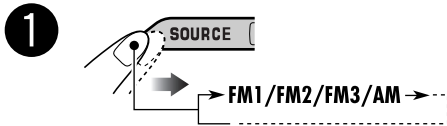
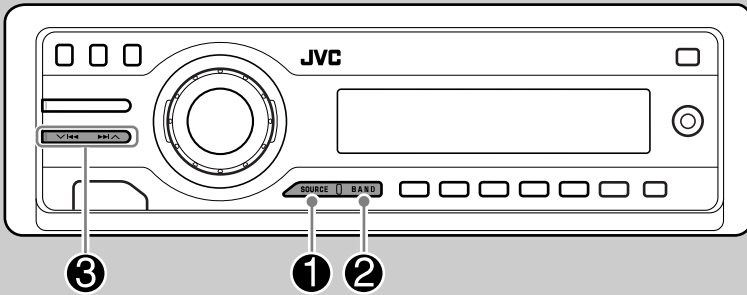

Selected band appears.

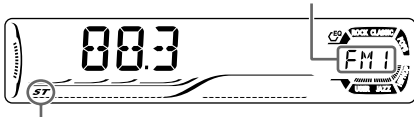

Lights up when receiving an FM stereo broadcast with sufficient signal strength.

3 Start searching for a station.



When a station is received, searching stops.

To stop searching, press the same button again.

To tune in to a station manually

In step 3 on the left...



2 Select the desired station frequencies.



When an FM stereo broadcast is hard to receive

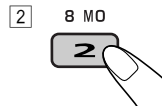
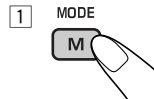

Lights up when monaural mode is activated.

Reception improves, but stereo effect will be lost.

To restore the stereo effect, repeat the same procedure. "MONO OFF" appears and the MO indicator goes off.

Storing stations in memory

You can preset six stations for each band.

FM station automatic presetting—SSM (Strong-station Sequential Memory)

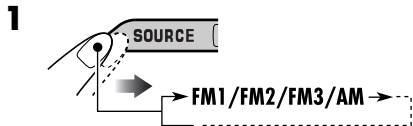

2 Select the FM band (FM1 – FM3) you want to store into.

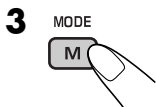

“SSM” flashes, then disappears when automatic presetting is over.

Local FM stations with the strongest signals are searched and stored automatically in the FM band.

Manual presetting

Ex.: Storing FM station of 92.5 MHz into the preset number 4 of the FM1 band.

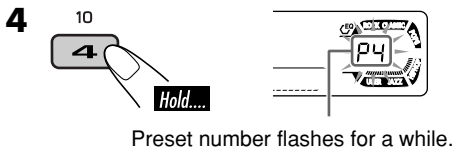
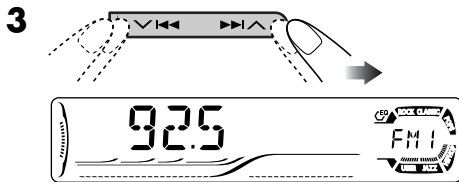
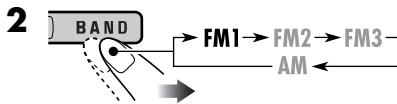
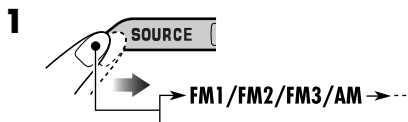

Listening to a preset station

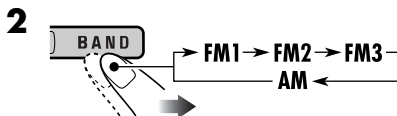
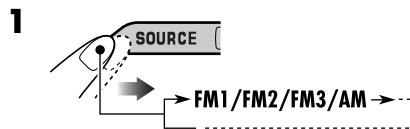

3 Select the preset station (1 – 6) you want.

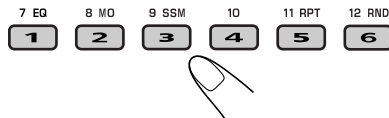

To check the current clock time while listening to an FM (non-RDS) or AM station

• For FM RDS stations, see page 13.

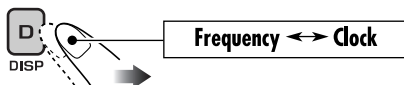

FM RDS operations

Searching for your favorite FM RDS programme

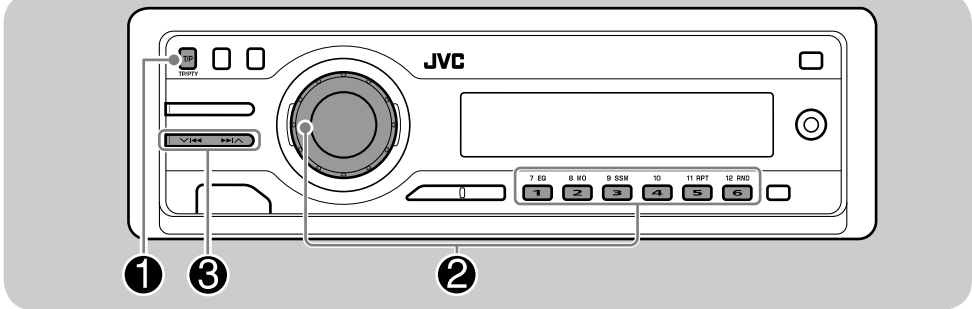

You can tune in to a station broadcasting your favorite programme by searching for a PTY code.

1

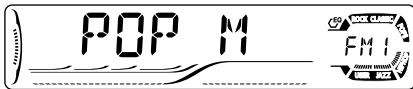

The last selected PTY code appears.

2

Select one of your favorite programme type.



or

Select one of the twenty-nine PTY codes.

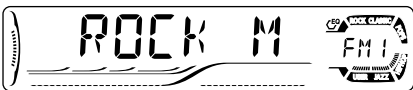
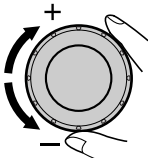

Ex.: When "ROCK M" is selected

3

Start searching for your favorite programme.



If there is a station broadcasting a programme of the same PTY code as you have selected, that station is tuned in.

PTY codes

NEWS, AFFAIRS, INFO, SPORT, EDUCATE, DRAMA, CULTURE, SCIENCE, VARIED, POP M (music), ROCK M (music), EASY M (music), LIGHT M (music), CLASSICS, OTHER M (music), WEATHER, FINANCE, CHILDREN, SOCIAL, RELIGION, PHONE IN, TRAVEL, LEISURE, JAZZ, COUNTRY, NATION M (music), OLDDIES, FOLK M (music), DOCUMENT

What you can do with RDS

RDS (Radio Data System) allows FM stations to send an additional signal along with their regular programme signals. By receiving the RDS data, this receiver can do the following:

- Programme Type (PTY) Search (see page 11)
- Standby Reception of Traffic Announcement—TA (see the following) or your favorite programme (PTY) (see pages 13 and 23)
- Tracing the same programme automatically—Network-Tracking Reception (see page 13)
- Programme Search (see page 23)

Storing your favorite programmes

You can store six favorite programme types.

Preset programme types in the number buttons (1 to 6):

1	2	3	4	5	6
POP M	ROCK M	EASY M	CLASSICS	AFFAIRS	VARIED

- 1 Select a PTY code (see page 11).
- 2 Select the preset number (1 – 6) you want to store into.



Ex.: When "ROCK M" is selected

- 3 Repeat steps 1 and 2 to store other PTY codes into other preset numbers.

- 4 Finish the procedure.



Using the standby receptions

TA Standby Reception

TA Standby Reception allows the receiver to switch temporarily to Traffic Announcement (TA) from any source other than AM. The volume changes to the preset TA volume level (see page 23).

To activate TA Standby Reception

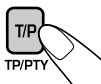

The TP indicator either lights up or flashes.

- If the TP indicator lights up, TA Standby Reception is activated.
 - If the TP indicator flashes, TA Standby Reception is not yet activated. (This occurs when you are listening to an FM station without the RDS signals required for TA Standby Reception.)
- To activate TA Standby Reception, tune in to another station providing these signals. The TP indicator will stop flashing and remain lit.

To deactivate the TA Standby Reception

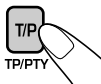

The TP indicator goes off.

PTY Standby Reception

PTY Standby Reception allows the receiver to switch temporarily to your favorite PTY programme from any source other than AM.

To activate and select your favorite PTY code for PTY Standby Reception, see page 23.

The PTY indicator either lights up or flashes.

- **If the PTY indicator lights up,** PTY Standby Reception is activated.
- **If the PTY indicator flashes,** PTY Standby Reception is not yet activated.

To activate PTY Standby Reception, tune in to another station providing these signals. The PTY indicator will stop flashing and remain lit.

To deactivate the PTY Standby Reception, select "OFF" for the PTY code (see page 23). The PTY indicator goes off.

Tracking the same programme— Network-Tracking Reception

When driving in an area where FM reception is not sufficient enough, this receiver automatically tunes in to another FM RDS station of the same network, possibly broadcasting the same programme with stronger signals (see the illustration below).

When shipped from the factory, Network-Tracking Reception is activated.

To change the Network-Tracking Reception setting, see "AF-REG" on page 23.

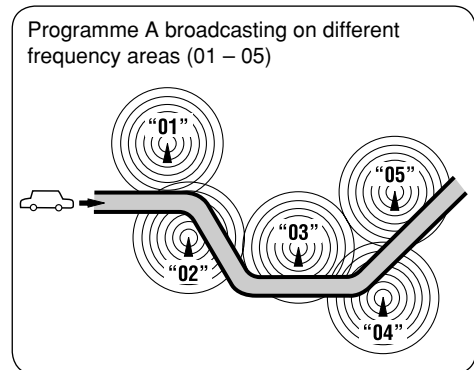

To check the current clock time while listening to an FM RDS station

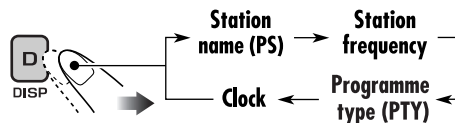

Disc operations

Playing a disc in the receiver

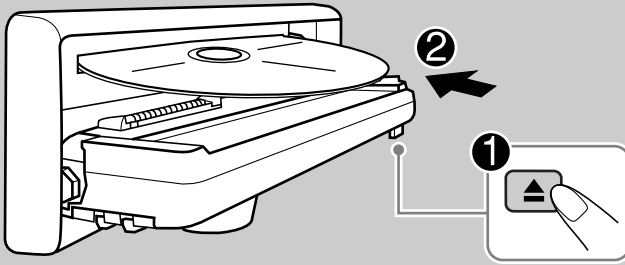

All tracks will be played repeatedly until you change the source or eject the disc.

About MP3 and WMA discs

MP3 and WMA (Windows Media® Audio) “tracks” (words “file” and “track” are used interchangeably) are recorded in “folders.”

- When inserting an MP3 or a WMA disc:



Total folder number Total track number



*

Disc information appears automatically (see page 18).

Elapsed playing time Current track number

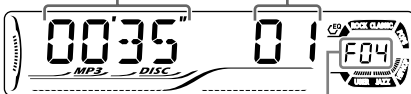

Selected folder number

* Either the MP3 or WMA indicator lights up depending on the detected file.

- When inserting an audio CD or a CD Text disc:

Total playing time of the inserted disc Total track number of the inserted disc



CD Text: Disc title/performer →
Track title appears automatically (see page 18).

Elapsed playing time Current track number



To stop play and eject the disc

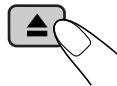

Playing discs in the CD changer

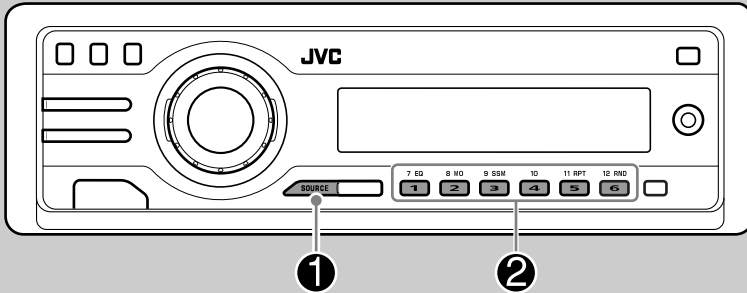

About the CD changer

It is recommended to use the JVC MP3-compatible CD changer with your receiver.

- You can also connect other CH-X series CD changers (except CH-X99 and CH-X100). However, they are not compatible with MP3 discs, so you cannot play back MP3 discs.
- You cannot use the KD-MK series CD changers with this receiver.
- Disc text information recorded in the CD Text can be displayed when a JVC CD Text compatible CD changer is connected.

Before operating your CD changer:

- Refer also to the Instructions supplied with your CD changer.
- You cannot control and play any WMA disc in the CD changer.

All tracks of the inserted discs in the magazine will be played repeatedly until you change the source or eject the magazine from the CD changer.

1

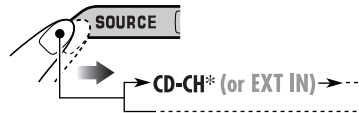

* If you have changed "EXT IN" setting to "EXT IN" (see page 24), you cannot select the CD changer.

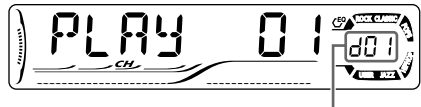

Selected disc number

2

Select a disc.

For disc number from 01 – 06:



For disc number from 07 – 12:



- When the current disc is an MP3 disc:

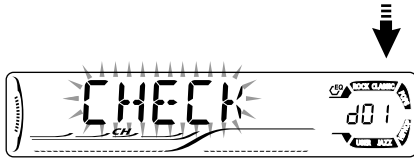

Folder name*



Selected folder number

Disc information appears automatically (see page 18).

Elapsed playing time Current track number



* "ROOT" appears if no folder is included in the disc.

- When the current disc is an audio CD or a CD Text disc:

CD Text: Disc title/performer →
Track title appears automatically
(see page 18).

Elapsed playing time Current track number



To fast-forward or reverse the track

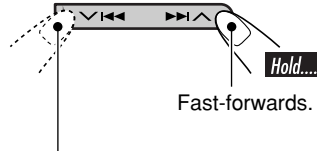

Reverses.

To go to the next or previous tracks

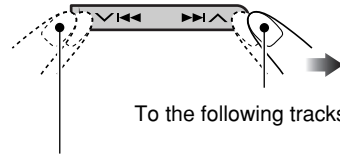

To the beginning of the current track, then the previous tracks.

To go to the next or previous folders (only for MP3 or WMA discs)

For MP3 discs:  

For WMA discs: 

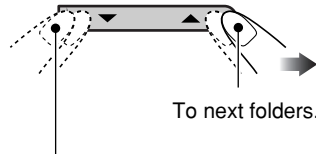

To previous folders.

To locate a particular track (for CD) or folder (for MP3 or WMA discs) directly



To select a number from 01 – 06:



To select a number from 07 – 12:



- To use folder search on MP3/WMA discs, it is required that folders are assigned with 2-digits number at the beginning of their folder names—01, 02, 03, and so on.

- To select a particular track in a folder (for MP3 or WMA disc) after selecting a folder:



Other main functions

■ Skipping a track quickly during play



- For MP3 or WMA disc, you can skip a track within the same folder.

Ex.: To select track 32 while playing track 6

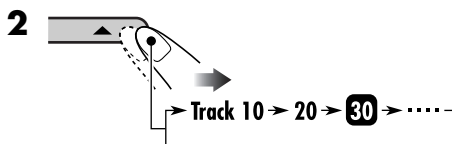
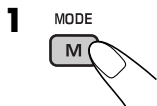

First time you press +10 or -10 button, the track skips to the nearest higher or lower track with a track number of multiple ten (ex. 10th, 20th, 30th).

Then each time you press the button, you can skip 10 tracks.

- After the last track, the first track will be selected and vice versa.

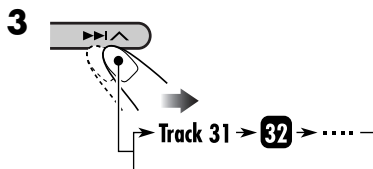

■ Prohibiting disc ejection



You can lock a disc in the loading slot.

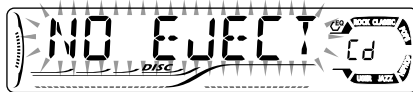
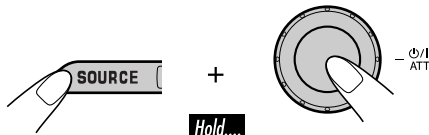

To cancel the prohibition, repeat the same procedure.

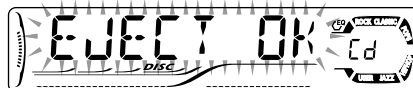

Changing the display information



■ While playing an audio CD or a CD Text (/)

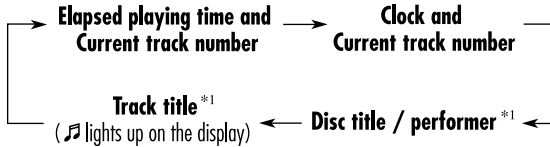

*1 For KD-G612/KD-G611: If no title is assigned to an audio CD, "NO NAME" appears.
 To assign a title to an audio CD, see page 25.
 For KD-G511: "NO NAME" appears.

■ While playing an MP3 (/) or WMA () disc

- When "TAG DISP" is set to "TAG ON" (see page 24)

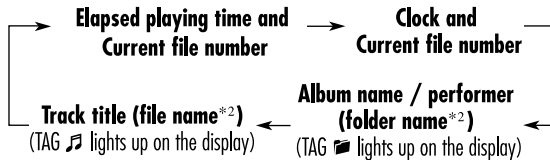

*2 If an MP3/WMA file does not have ID3 tags, folder name and file name appear. In this case, the TAG indicator will not light up.

- When "TAG DISP" is set to "TAG OFF"

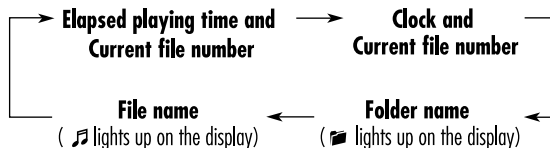

Selecting the playback modes

You can use only one of the following playback modes at a time.

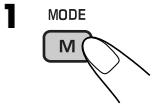

2 Select your desired playback mode.

Repeat play

11 RPT



Ex.: When "TRK RPT" is selected while playing an MP3 disc in the receiver

Mode	Plays repeatedly
TRK RPT:	The current track. • RPT lights up.
FLDR RPT*1:	All tracks of the current folder. • and RPT light up.
DISC RPT*2:	All tracks of the current disc. • and RPT light up.
RPT OFF:	Cancels.

Random play

12 RND



Ex.: When "DISC RND" is selected while playing an MP3 disc in the receiver

Mode	Plays at random
FLDR RND*1:	All tracks of the current folder, then tracks of the next folder and so on. • RND and light up.
DISC RND:	All tracks of the current disc. • RND and light up.
MAG RND*2:	All tracks of the inserted discs. • RND lights up.
RND OFF:	Cancels.

*1 Only while playing an MP3 (/) or WMA () disc.

*2 Only while playing discs in the CD changer ().

Sound adjustments

Selecting preset sound modes (C-EQ: custom equalizer)

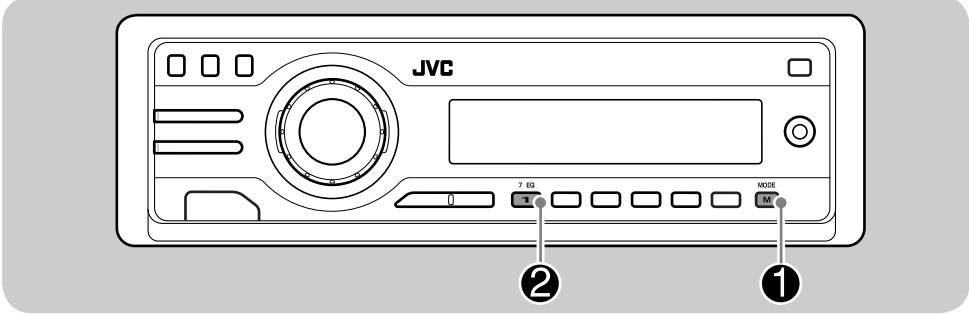

You can select a preset sound mode suitable to the music genre.

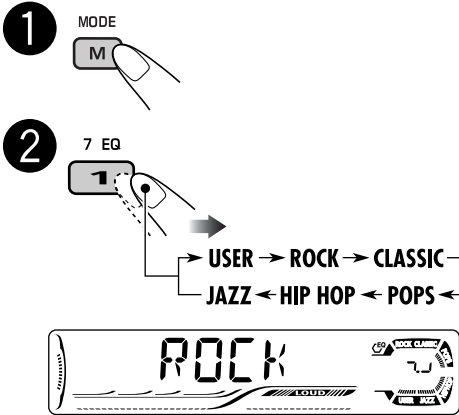

Ex.: When "ROCK" is selected

Indication	For:	Preset values		
		BAS* ¹	TRE* ²	LOUD* ³
USER	(Flat sound)	00	00	OFF
ROCK	Rock or disco music	+03	+01	ON
CLASSIC	Classical music	+01	-02	OFF
POPS	Light music	+04	+01	OFF
HIP HOP	Funk or rap music	+02	00	ON
JAZZ	Jazz music	+02	+03	OFF

*1 *BAS*: Bass
 *2 *TRE*: Treble
 *3 *LOUD*: Loudness

Indication pattern for each sound mode:

USER	ROCK
JAZZ	CLASSIC
HIP HOP	POPS

Adjusting the sound

You can adjust the sound characteristics to your preference.

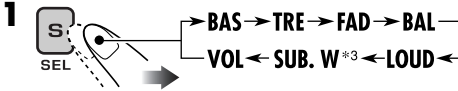

Ex.: When "TRE" is selected

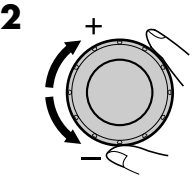

Indication pattern changes as you adjust the level.

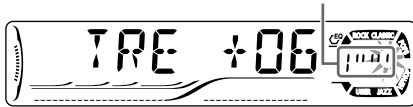

Indication	To do:	Range
BAS*1 (bass)	Adjust the bass.	-06 (min.) to +06 (max.)
TRE*1 (treble)	Adjust the treble.	-06 (min.) to +06 (max.)
FAD*2 (fader)	Adjust the front and rear speaker balance.	R06 (Rear only) to F06 (Front only)
BAL (balance)	Adjust the left and right speaker balance.	L06 (Left only) to R06 (Right only)
LOUD*1 (loudness)	Boost low and high frequencies to produce a well-balanced sound at low volume level.	LOUD ON ↓ LOUD OFF
SUB. W*3 (subwoofer)	Adjust the subwoofer output level.	00 (min.) to 08 (max.)
VOL*4 (volume)	Adjust the volume.	00 (min.) to 30 or 50 (max.)*5

*1 When you adjust the bass, treble, or loudness, the adjustment you have made is stored for the currently selected sound mode (C-EQ) including "USER."

*2 If you are using a two-speaker system, set the fader level to "00."

*3 Only for KD-G612/KD-G611: This takes effect only when a subwoofer is connected.

*4 Normally the control dial works as the volume control. So you do not have to select "VOL" to adjust the volume level.

*5 Depending on the amplifier gain control setting. (See page 24 for details.)

General settings — PSM

Basic procedure

You can change PSM (Preferred Setting Mode) items listed in the table that follows.



2 Select a PSM item.

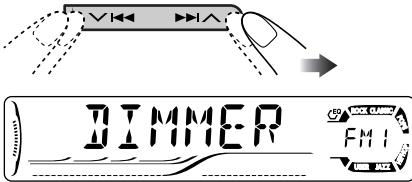

Ex.: When you select "DIMMER"

3 Adjust the PSM item selected.

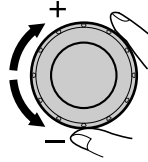

4 Repeat steps 2 and 3 to adjust the other PSM items if necessary.

5 Finish the procedure.



Indications	Selectable settings, [reference page]
DEMO Display demonstration	DEMO ON: [Initial]; Display demonstration will be activated automatically if no operation is done for about 20 seconds, [8]. DEMO OFF: Cancels.
CLOCK H Hour adjustment	0 – 23 (1 – 12), [8] [Initial: 0 (0:00)]
CLOCK M Minute adjustment	00 – 59, [8] [Initial: 00 (0:00)]
24H/12H 24 hours or 12 hours time display	12H ⇄ 24H, [8] [Initial: 24H]
CLK ADJ Clock adjustment	AUTO: [Initial]; The built-in clock is automatically adjusted using the CT (clock time) data in the RDS signal. OFF: Cancels.

Indications	Selectable settings, [reference page]
AF-REG Alternative frequency/ regionalization reception	When the received signals from the current station become weak... AF: [Initial]; Switches to another station (the programme may differ from the one currently received), [13]. • The AF indicator lights up. AF REG: Switches to another station broadcasting the same programme. • The AF and REG indicators light up. OFF: Cancels (not selectable when “DAB AF” is set to “AF ON”).
PTY-STBY PTY standby	Activates PTY Standby Reception with one of the 29 PTY codes, [13]. OFF [Initial] → 29 PTY codes, [11] → (back to the beginning)
TA VOL Traffic announcement volume	[Initial: VOL 20]; VOL 00 — VOL 30 or 50*1, [12]
P-SEARCH Programme search	ON: Using the AF data, the receiver tunes in to another frequency broadcasting the same programme as the original preset RDS station is if the preset station signals are not sufficient. OFF: [Initial]; Cancels.
DAB AF *2 Alternative frequency reception	AF ON: [Initial]; Traces the programme among DAB services and FM RDS stations, [29]. AF OFF: Cancels.
DAB VOL *2 DAB volume adjustment	You can adjust the volume level (VOL -12 — VOL +12) of DAB tuner to match the FM sound level and store it in memory. [Initial: VOL 00]
LEVEL Audio level meter	ON: [Initial]; Activates the audio level indicator. OFF: Cancels; sound mode indicator is shown, [20].
DIMMER Dimmer	AUTO: [Initial]; Dims the display when you turn on the headlights. ON: Activates dimmer. OFF: Cancels.

*1 Depends on the amplifier gain control.

*2 Displayed only when DAB tuner is connected.

To be continued...

Indications	Selectable settings, [reference page]
TEL Telephone muting	MUTING 1/MUTING 2: Select either one which mutes the sounds while using the cellular phone. OFF: [Initial]; Cancels.
SCROLL*1 Scroll	ONCE: [Initial]; Scrolls the disc information once. AUTO: Repeats scrolling (5-seconds interval in between). OFF: Cancels. <ul style="list-style-type: none"> Pressing D DISP for more than one second can scroll the display regardless of the setting.
WOOFER*2 Subwoofer cutoff frequency	LOW: Frequencies lower than 55 Hz are send to the subwoofer. MID: [Initial]; Frequencies lower than 85 Hz are send to the subwoofer. HIGH: Frequencies lower than 115 Hz are send to the subwoofer.
EXT IN*3 External input	CHANGER: [Initial]; To use a JVC CD changer, [15] or DAB tuner, [28]. EXT IN: To use another external component, [27].
AUX ADJ*2 Auxiliary input level adjustment	A.ADJ 00 – A.ADJ 05: Adjust the auxiliary input level accordingly, to avoid the sudden increase of the output level when changing the source from external component connected to the AUX input jack on the control panel. <i>[Initial: A.ADJ 00]</i>
TAG DISP Tag display	TAG ON: [Initial]; Shows the ID3 tag while playing MP3/WMA tracks, [18]. TAG OFF: Cancels.
AMP GAIN Amplifier gain control	You can change the maximum volume level of this receiver. LOW PWR: VOL 00 – VOL 30 (Select this if the maximum power of the speaker is less than 50 W to prevent them from damaging the speaker.) HIGH PWR: [Initial]; VOL 00 – VOL 50

*1 Some characters or symbols will not be shown (and will be blanked) on the display (Ex. "ABC&!d#" ⇒ "ABCA D ").

*2 Only for KD-G612/KD-G611.

*3 Displayed only when one of the following sources is selected—FM, AM, CD, or (AUX IN: only for KD-G612/KD-G611).

Other main functions

Assigning titles to the sources

This section is only for KD-G612/KD-G611.

You can assign titles to CDs (both in this receiver and in the CD changer).

Sources	Maximum number of characters
CDs/CD-CH	Up to 32 characters (up to 30 discs)

* You cannot assign a title to a CD Text or an MP3/WMA disc.

1 Select the sources.

- For a CD in this receiver: Insert a CD.
- For CDs in the CD changer: Select “CD-CH,” then select a disc number.

2 Enter the title assignment mode.



Ex.: When you select CD as the source

3 Assign a title.

1 Select a character.

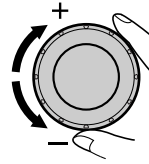

A	B	C	D	E	F	G	H	I	J	K	L	M	N
O	P	Q	R	S	T	U	V	W	X	Y	Z	0	1
2	3	4	5	6	7	8	9	-	/	<	>	space	

2 Move to the next (or previous) character position.



3 Repeat steps 1 and 2 until you finish entering the title.

4 Finish the procedure.



To erase the entire title

In step 2 on the left...



Detaching the control panel

When detaching or attaching the control panel, be careful not to damage the connectors on the back of the control panel and on the panel holder.

■ Detaching the control panel

Before detaching the control panel, be sure to turn off the power.

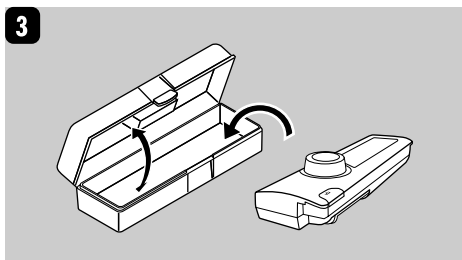
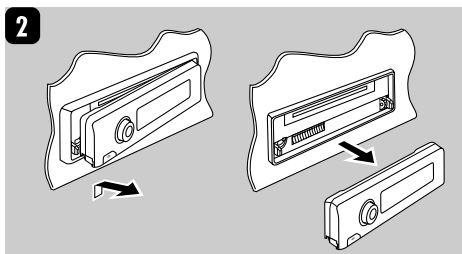
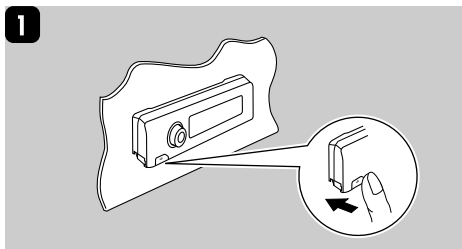

■ Attaching the control panel

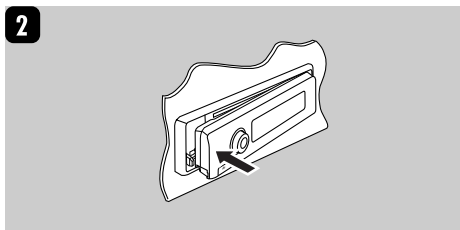
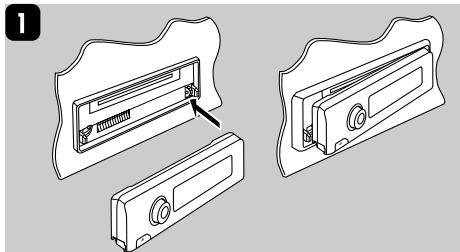

External component operations

Playing an external component

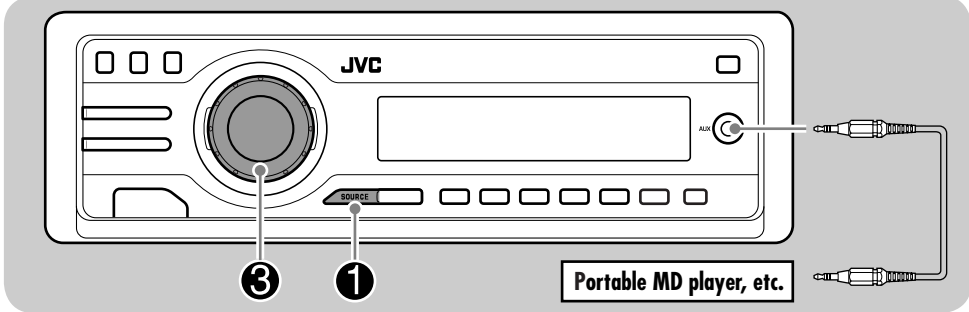

For KD-G612/KD-G611:

You can connect an external component to the CD changer jack on the rear using the Line Input Adapter KS-U57 (not supplied), and another to the AUX (auxiliary) input jack on the control panel.

For KD-G511:

You can connect an external component to the CD changer jack on the rear using the Line Input Adapter KS-U57 (not supplied).

- For connection, see Installation/Connection Manual (separate volume).

1 For KD-G612/KD-G611:

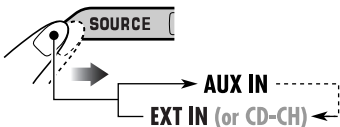

AUX IN: For selecting the external component connected to the AUX input jack.

EXT IN: For selecting the external component connected to the CD changer jack on the rear using KS-U57 (see page 24 for selecting the external input—EXT IN).

For KD-G511:

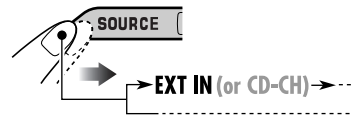

- If “EXT IN” does not appear, see page 24 and select the external input (EXT IN).

2 Turn on the connected component and start playing the source.

3 Adjust the volume.

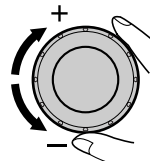

4 Adjust the sound as you want. (See pages 20 and 21.)

DAB tuner operations

Listening to the DAB tuner

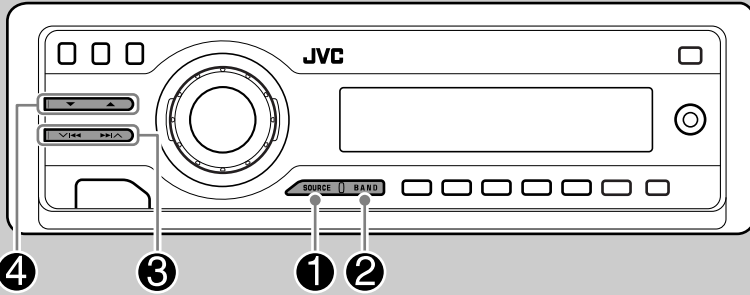

1

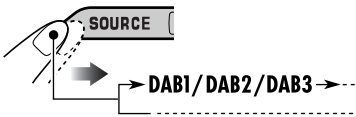

2 Select the desired ensemble frequencies.

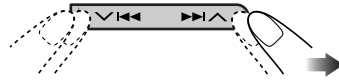

2



3

Start searching for an ensemble.



When an ensemble is received, searching stops.

To stop searching, press the same button again.

4

Select a service (either primary or secondary) to listen to.



To tune in to an ensemble manually

In step 3 above...

1



What is DAB system?

DAB can deliver CD quality sound without any annoying interference and signal distortion. Furthermore, it can carry text, pictures, and data. When transmitting, DAB combines several programmes (called “services”) to form one “ensemble.” In addition, each “service”—called “primary service”—can also be divided into its components (called “secondary service”). A typical ensemble has six or more programmes (services) broadcast at the same time.

By connecting the DAB tuner, this receiver can do the following:

- Tracing the same programme automatically —Alternative Reception (see “DAB AF” on page 23).

It is recommended to use DAB (Digital Audio Broadcasting) tuner KT-DB1000 with your receiver. If you have another DAB tuner, consult your JVC IN-CAR ENTERTAINMENT dealer.

- Refer also to the Instructions supplied for your DAB tuner.

Storing DAB services in memory

You can preset six DAB services (primary) for each band.

1 Perform steps ① to ④ on page 28, to select a service you want.

2 Select the preset number (1 – 6) you want to store into.



Preset number flashes for a while.

Tracing the same programme— Alternative Reception

You can keep listening to the same programme by activating the Alternative Reception.

- **While receiving a DAB service:**
When driving in an area where a service cannot be received, this receiver automatically tunes in to another ensemble or FM RDS station, broadcasting the same programme.
- **While receiving an FM RDS station:**
When driving in an area where a DAB service is broadcasting the same programme as the FM RDS station is broadcasting, this receiver automatically tunes in to the DAB service.

When shipped from the factory, Alternative Reception is activated.

To deactivate the Alternative Reception, see page 23.

Tuning in to a preset DAB service

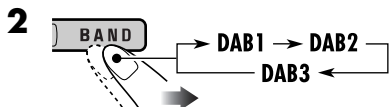
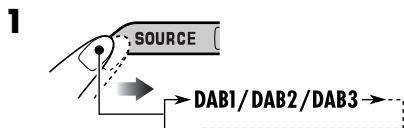

3 Select the preset DAB service (primary) number (1 – 6) you want.



If the selected primary service has some secondary services, press the same button again will tune in to the secondary services.

To change the display information while tuning in to an ensemble

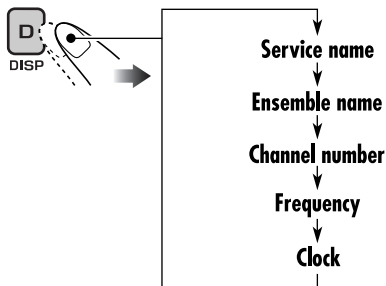

Maintenance

How to clean the connectors

Frequent detachment will deteriorate the connectors.

To minimize this possibility, periodically wipe the connectors with a cotton swab or cloth moistened with alcohol, being careful not to damage the connectors.

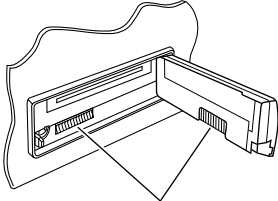

Connector

Moisture condensation

Moisture may condense on the lens inside the CD player in the following cases:

- After starting the heater in the car.
- If it becomes very humid inside the car.

Should this occur, the CD player may malfunction. In this case, eject the disc and leave the receiver turned on for a few hours until the moisture evaporates.

How to handle discs

When removing a disc from its case, press down the center holder of the case and lift the disc out, holding it by the edges.

Center holder



- Always hold the disc by the edges. Do not touch its recording surface.

When storing a disc into its case, gently insert the disc around the center holder (with the printed surface facing up).

- Make sure to store discs into the cases after use.

To keep discs clean

A dirty disc may not play correctly. If a disc does become dirty, wipe it with a soft cloth in a straight line from center to edge.



- Do not use any solvent (for example, conventional record cleaner, spray, thinner, benzine, etc.) to clean discs.

To play new discs

New discs may have some rough spots around the inner and outer edges. If such a disc is used, this receiver may reject the disc.



To remove these rough spots, rub the edges with a pencil or ball-point pen, etc.

Do not use the following discs:



More about this receiver

Basic operations

Turning on the power

- By pressing SOURCE on the receiver, you can also turn on the power.

Turning off the power

- If you turn off the power while listening to a disc, disc play will start from where playback has been stopped previously, next time you turn on the power.

Selecting the sources

- When no disc is loaded in the receiver, “CD” cannot be selected.
- Without connecting to the CD changer or DAB tuner, “CD-CH” or “DAB” cannot be selected.

Tuner operations

Storing stations in memory

- During SSM search...
 - All previously stored stations are erased and stations are stored newly.
 - Received stations are preset in No. 1 (lowest frequency) to No. 6 (highest frequency).
 - When SSM is over, the station stored in No. 1 will be automatically tuned in.
- When storing a station manually, a previously preset station is erased when a new station is stored in the same preset number.

FM RDS operations

- Network-Tracking Reception requires two types of RDS signals—PI (Programme Identification) and AF (Alternative Frequency) to work correctly. Without receiving these data correctly, Network-Tracking Reception will not operate.
- If a Traffic Announcement is received, the volume level (TA VOL) automatically changes to the preset level.
- If a DAB tuner is connected and Alternative Reception for DAB services (DAB AF) is activated, Network-Tracking Reception (AF-REG) is also activated automatically. On the other hand, Network-Tracking Reception cannot be deactivated without deactivating Alternative Reception. (See page 23.)

Disc operations

General

- This receiver has been designed to reproduce CDs/CD Texts, and CD-Rs (Recordable)/CD-RWs (Rewritable) in audio CD (CD-DA), MP3 and WMA format.
- When a disc has been loaded, selecting “CD” for the playback source starts disc play.

Inserting a disc

- When a disc is inserted upside down, “PLEASE” and “EJECT” appear alternately on the display. Press ▲ to eject the disc.
- Do not insert 8 cm discs (single CD) and unusual shape discs (heart, flower, etc.) into the loading slot.

Playing a disc

- While fast-forwarding or reversing on an MP3 or WMA disc, you can only hear intermittent sounds.

To be continued...

Playing a CD-R or CD-RW

- Use only “finalized” CD-Rs or CD-RWs.
- This receiver can play back only the files of the same type which is first detected if a disc includes both audio CD (CD-DA) files and MP3/WMA files.
- This receiver can play back multi-session discs; however, unclosed sessions will be skipped while playing.
- Some CD-Rs or CD-RWs may not play back on this receiver because of their disc characteristics, and for the following causes:
 - Discs are dirty or scratched.
 - Moisture condensation occurs on the lens inside the receiver.
 - The pickup lens inside the receiver is dirty.
 - CD-R/CD-RW on which the files are written with “Packet Write” method.
 - There are improper recording conditions (missing data, etc.) or media conditions (stain, scratch, warp, etc.).
- CD-RWs may require a longer readout time since the reflectance of CD-RWs is lower than that of regular CDs.
- Do not use the following CD-Rs or CD-RWs:
 - Discs with stickers, labels, or protective seal stuck to the surface.
 - Discs on which labels can be directly printed by an ink jet printer.
 Using these discs under high temperatures or high humidities may cause malfunctions or damages to discs.

Playing an MP3/WMA disc

- This receiver can play back MP3/WMA files with the extension code <.mp3> or <.wma> (regardless of the letter case—upper/lower).
 - This receiver can show the names of albums, artists (performer), and ID3 Tag (Version 1.0, 1.1, 2.2, 2.3, or 2.4) for MP3 files and for WMA files.
 - This receiver can display only one-byte characters. No other characters can be correctly displayed.
 - This receiver can play back MP3/WMA files meeting the conditions below:
 - Bit rate: 8 kbps — 320 kbps
 - Sampling frequency:
 - 48 kHz, 44.1 kHz, 32 kHz (for MPEG-1)
 - 24 kHz, 22.05 kHz, 16 kHz (for MPEG-2)
 - Disc format: ISO 9660 Level 1/ Level 2, Romeo, Joliet, Windows long file name
 - The maximum number of characters for file/folder names vary among the disc format used (includes 4 extension characters—<.mp3> or <.wma>).
 - ISO 9660 Level 1: up to 12 characters
 - ISO 9660 Level 2: up to 31 characters
 - Romeo*: up to 128 (72) characters
 - Joliet*: up to 64 (36) characters
 - Windows long file name*: up to 128 (72) characters
- * *The parenthetic figure is the maximum number of characters for file/folder names in case the total number of files and folders is 313 or more.*

- This receiver can recognize the total of 512 files, of 200 folders, and of 8 hierarchies.
- This receiver can play back the files recorded in VBR (variable bit rate).
The files recorded in VBR have a discrepancy in elapsed time display, and do not show the actual elapsed time. Especially, after performing the search function, this difference becomes noticeable.
- This receiver cannot play back the following files:
 - MP3 files encoded with MP3i and MP3 PRO format.
 - MP3 files encoded in an unappropriated format.
 - MP3 files encoded with Layer 1/2.
 - WMA files encoded with lossless, professional, and voice format.
 - WMA files which are not based upon Windows Media® Audio.
 - WMA files copy-protected with DRM.
 - Files which have the data such as WAVE, ATRAC3, etc.
- The search function works but search speed is not constant.

Changing the source

- If you change the source, playback also stops (without ejecting the disc).
Next time you select “CD” for the playback source, disc play starts from where it has been stopped previously.

Ejecting a disc

- If the ejected disc is not removed within 15 seconds, the disc is automatically inserted again into the loading slot to prevent it from dust. (Disc will not play this time.)

General settings—PSM

- If you change the “AMP GAIN” setting from “HIGH PWR” to “LOW PWR” while the volume level is set higher than “VOL 30,” the receiver automatically changes the volume level to “VOL 30.”

Other main functions (only for KD-G612/KD-G611)

- If you try to assign a title to a 31st disc, “NAMEFULL” flashes on the display. Delete unwanted titles before assignment.
- Titles assigned to discs in the CD changer can also be shown if you playback the disc from the receiver.

DAB tuner operations

- Only primary DAB services can be presetted even when you store a secondary service.
- A previously preset DAB service is erased when a new DAB service is stored in the same preset number.

Troubleshooting

What appears to be trouble is not always serious. Check the following points before calling a service center.

	Symptoms	Causes	Remedies
General	<ul style="list-style-type: none"> • Sound cannot be heard from the speakers. 	The volume level is set to the minimum level.	Adjust it to the optimum level.
		Connections are incorrect.	Check the cords and connections.
	<ul style="list-style-type: none"> • The receiver does not work at all. 	The built-in microcomputer may have functioned incorrectly due to noise, etc.	Reset the receiver (see page 2).
FM/AM	<ul style="list-style-type: none"> • SSM automatic presetting does not work. 	Signals are too weak.	Store stations manually.
	<ul style="list-style-type: none"> • Static noise while listening to the radio. 	The aerial is not connected firmly.	Connect the aerial firmly.
Disc playback	<ul style="list-style-type: none"> • Disc cannot be played back. 	Disc is inserted upside down.	Insert the disc correctly.
	<ul style="list-style-type: none"> • CD-R/CD-RW cannot be played back. • Tracks on the CD-R/CD-RW cannot be skipped. 	CD-R/CD-RW is not finalized.	<ul style="list-style-type: none"> • Insert a finalized CD-R/CD-RW. • Finalize the CD-R/CD-RW with the component which you used for recording.
		<ul style="list-style-type: none"> • Disc can be neither played back nor ejected. 	Disc is locked.
	The CD player may have functioned incorrectly.		Eject the disc forcibly (see page 2).
	<ul style="list-style-type: none"> • Disc sound is sometimes interrupted. 	You are driving on rough roads.	Stop playback while driving on rough roads.
		Disc is scratched.	Change the disc.
		Connections are incorrect.	Check the cords and connections.
<ul style="list-style-type: none"> • "NO DISC" appears on the display. 	Disc is inserted incorrectly.	Insert the disc correctly.	

	Symptoms	Causes	Remedies
MP3/WMA playback	<ul style="list-style-type: none"> Disc cannot be played back. 	No MP3/WMA tracks are recorded on the disc.	Change the disc.
		MP3/WMA tracks do not have the extension code <.mp3> or <.wma> in their file names.	Add the extension code <.mp3> or <.wma> to their file names.
		MP3/WMA tracks are not recorded in the format compliant with ISO 9660 Level 1, Level 2, Romeo, or Joliet.	Change the disc. (Record MP3/WMA tracks using a compliant application.)
	<ul style="list-style-type: none"> Noise is generated. 	The track played back is not an MP3/WMA file (although it has the extension code <.mp3> or <.wma>).	Skip to another track or change the disc. (Do not add the extension code <.mp3> or <.wma> to non-MP3 or WMA tracks.)
	<ul style="list-style-type: none"> A longer readout time is required (“CHECK” keeps flashing on the display). 	Readout time varies due to the complexity of the folder/file configuration.	Do not use too many hierarchies and folders.
	<ul style="list-style-type: none"> Tracks cannot be played back as you have intended them to play. 	Playback order is determined when the files are recorded.	_____
	<ul style="list-style-type: none"> Elapsed playing time is not correct. 	This sometimes occurs during play. This is caused by how the tracks are recorded on the disc.	_____
	<ul style="list-style-type: none"> “NO FILES” appears on the display. 	The current disc does not contain any MP3/WMA tracks.	Insert a disc that contains MP3/WMA tracks.
<ul style="list-style-type: none"> Correct characters are not displayed (e.g. album name). 	This receiver can only display alphabets (capital: A – Z), numbers, and a limited number of symbols.	_____	

To be continued...

	Symptoms	Causes	Remedies
CD changer	<ul style="list-style-type: none"> • “NO DISC” appears on the display. 	No disc is in the magazine.	Insert disc into the magazine.
		Disc is inserted upside down.	Insert disc correctly.
	<ul style="list-style-type: none"> • “NO MAG” appears on the display. 	No magazine is loaded in the CD changer.	Insert the magazine.
	<ul style="list-style-type: none"> • “RESET 8” appears on the display. 	This receiver is not connected to the CD changer correctly.	Connect this receiver and the CD changer correctly and press the reset button of the CD changer.
	<ul style="list-style-type: none"> • “RESET 1” – “RESET 7” appears on the display. 	_____	Press the reset button of the CD changer.
<ul style="list-style-type: none"> • The CD changer does not work at all. 	The built-in microcomputer may function incorrectly due to noise, etc.	Reset the receiver (see page 2).	

Specifications

AUDIO AMPLIFIER SECTION

Maximum Power Output:

Front: 50 W per channel

Rear: 50 W per channel

Continuous Power Output (RMS):

Front: 19 W per channel into 4 Ω , 40 Hz to 20 000 Hz at no more than 0.8% total harmonic distortion.

Rear: 19 W per channel into 4 Ω , 40 Hz to 20 000 Hz at no more than 0.8% total harmonic distortion.

Load Impedance: 4 Ω (4 Ω to 8 Ω allowance)

Tone Control Range:

Bass: ± 10 dB at 100 Hz

Treble: ± 10 dB at 10 kHz

Frequency Response: 40 Hz to 20 000 Hz

Signal-to-Noise Ratio: 70 dB

Line-Out Level/Impedance:

2.5 V/20 k Ω load (full scale)

Output Impedance: 1 k Ω

Subwoofer-Out Level/Impedance:

KD-G612/KD-G611:

2.0 V/20 k Ω load (full scale)

Other Terminals:

CD changer, SUBWOOFER (only for KD-G612/KD-G611), Steering wheel remote input

TUNER SECTION

Frequency Range:

FM: 87.5 MHz to 108.0 MHz

AM: (MW) 522 kHz to 1 620 kHz

(LW) 144 kHz to 279 kHz

[FM Tuner]

Usable Sensitivity: 11.3 dBf (1.0 μ V/75 Ω)

50 dB Quieting Sensitivity:

16.3 dBf (1.8 μ V/75 Ω)

Alternate Channel Selectivity (400 kHz): 65 dB

Frequency Response: 40 Hz to 15 000 Hz

Stereo Separation: 35 dB

Capture Ratio: 1.5 dB

[MW Tuner]

Sensitivity: 20 μ V

Selectivity: 35 dB

[LW Tuner]

Sensitivity: 50 μ V

- Microsoft and Windows Media are either registered trademarks or trademarks of Microsoft Corporation in the United States and/or other countries.

CD PLAYER SECTION

Type: Compact disc player

Signal Detection System: Non-contact optical pickup (semiconductor laser)

Number of Channels: 2 channels (stereo)

Frequency Response: 5 Hz to 20 000 Hz

Dynamic Range: 96 dB

Signal-to-Noise Ratio: 98 dB

Wow and Flutter: Less than measurable limit

MP3 Decoding Format:

MPEG1/2 Audio Layer 3

Max. Bit Rate: 320 kbps

WMA (Windows Media[®] Audio) Decoding Format:

Max. Bit Rate: 192 kbps

GENERAL

Power Requirement:

Operating Voltage:

DC 14.4 V (11 V to 16 V allowance)

Grounding System: Negative ground

Allowable Operating Temperature:

0°C to +40°C

Dimensions (W \times H \times D):

Installation Size (approx.):

182 mm \times 52 mm \times 150 mm

Panel Size (approx.):

188 mm \times 58 mm \times 11 mm

Mass (approx.):

1.5 kg (excluding accessories)

Design and specifications are subject to change without notice.



Having TROUBLE with operation?

Please reset your unit

Refer to page of How to reset your unit

Vous avez des PROBLÈMES de fonctionnement?

Réinitialisez votre appareil

Référez-vous à la page intitulée Comment réinitialiser votre appareil

JVC



EN, FR

© 2004 Victor Company of Japan, Limited

1104DTSMDTJEIN

JVC KD-G612/KD-G611/KD-G511

Installation/Connection Manual Manuel d'installation/raccordement

GET0266-010A
[EX/EU]

1104DTSMDTJEIN
EN, FR

ENGLISH

This receiver is designed to operate on **12 V DC, NEGATIVE ground electrical systems**. If your vehicle does not have this system, a voltage inverter is required, which can be purchased at JVC IN-CAR ENTERTAINMENT dealers.

FRANÇAIS

Cet appareil est conçu pour fonctionner sur des sources de **courant continu de 12 V à masse NEGATIVE**. Si votre véhicule n'offre pas ce type d'alimentation, il vous faut un convertisseur de tension, que vous pouvez acheter chez un revendeur d'autoradios JVC.

Parts list for installation and connection

The following parts are provided for this receiver.
After checking them, please set them correctly.

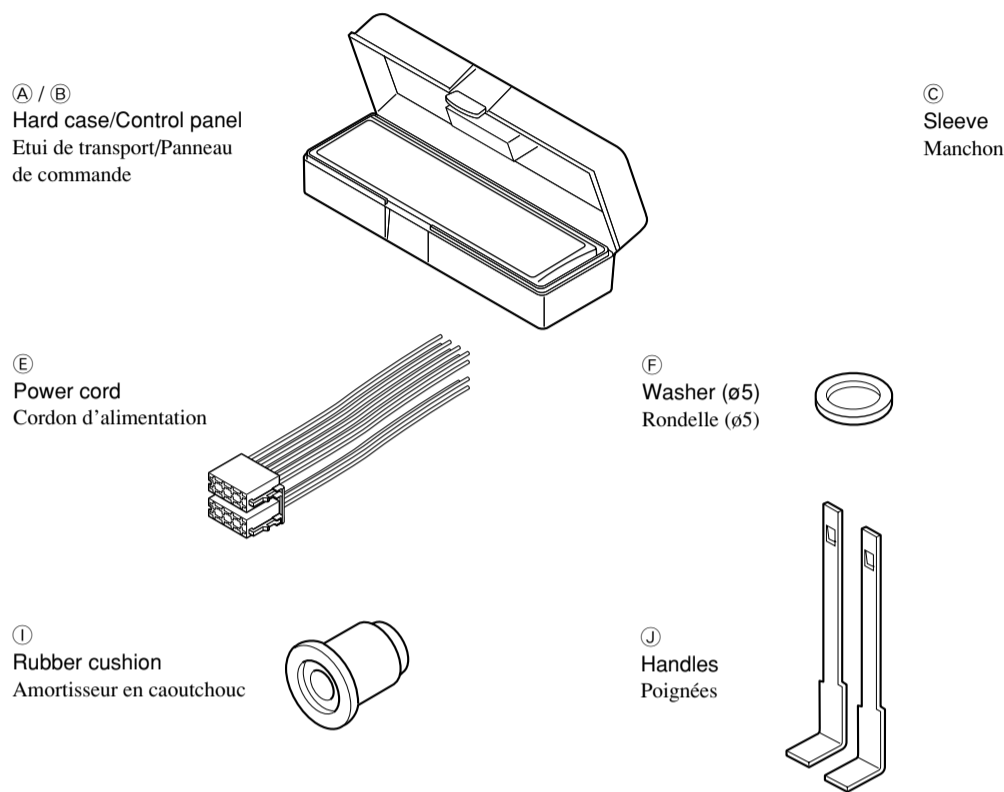

Liste des pièces pour l'installation et raccordement

Les pièces suivantes sont fournies avec cet appareil.
Après vérification, veuillez les placer correctement.

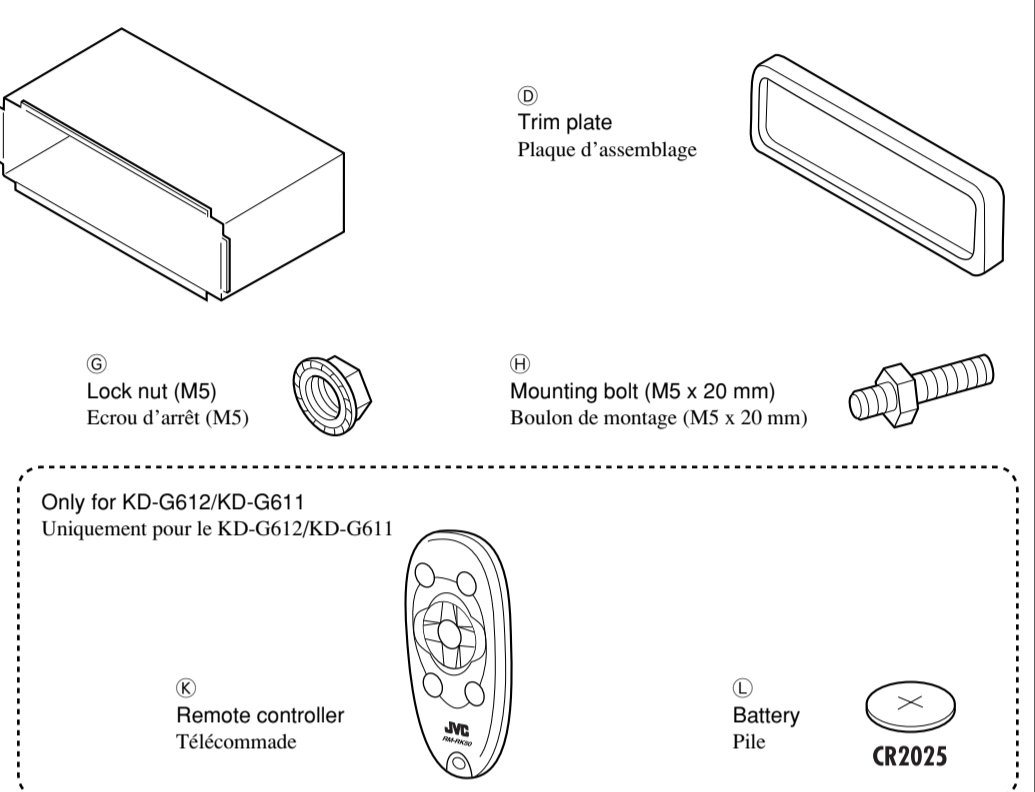

INSTALLATION (IN-DASH MOUNTING)

The following illustration shows a typical installation. If you have any questions or require information regarding installation kits, consult your JVC IN-CAR ENTERTAINMENT dealer or a company supplying kits.

- If you are not sure how to install this receiver correctly, have it installed by a qualified technician.

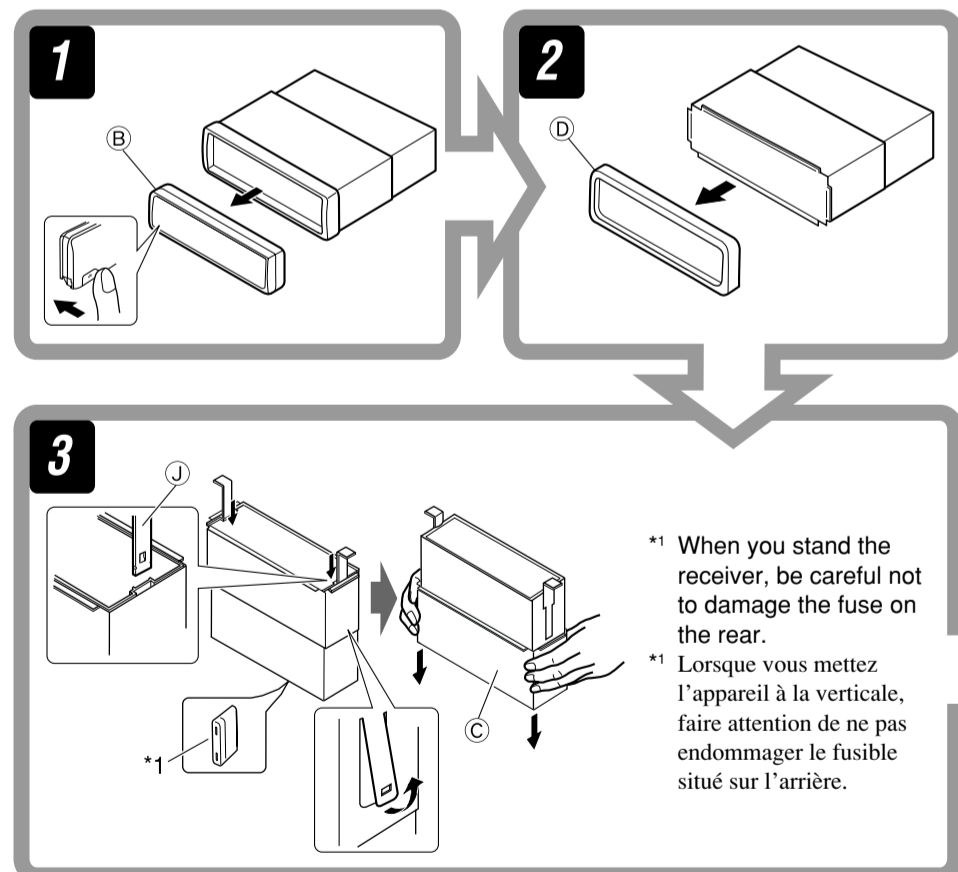

INSTALLATION (MONTAGE DANS LE TABLEAU DE BORD)

L'illustration suivante est un exemple d'installation typique. Si vous avez des questions ou avez besoin d'information sur des kits d'installation, consulter votre revendeur d'autoradios JVC ou une compagnie d'approvisionnement.

- Si l'on n'est pas sûr de pouvoir installer correctement cet appareil, le faire installer par un technicien qualifié.

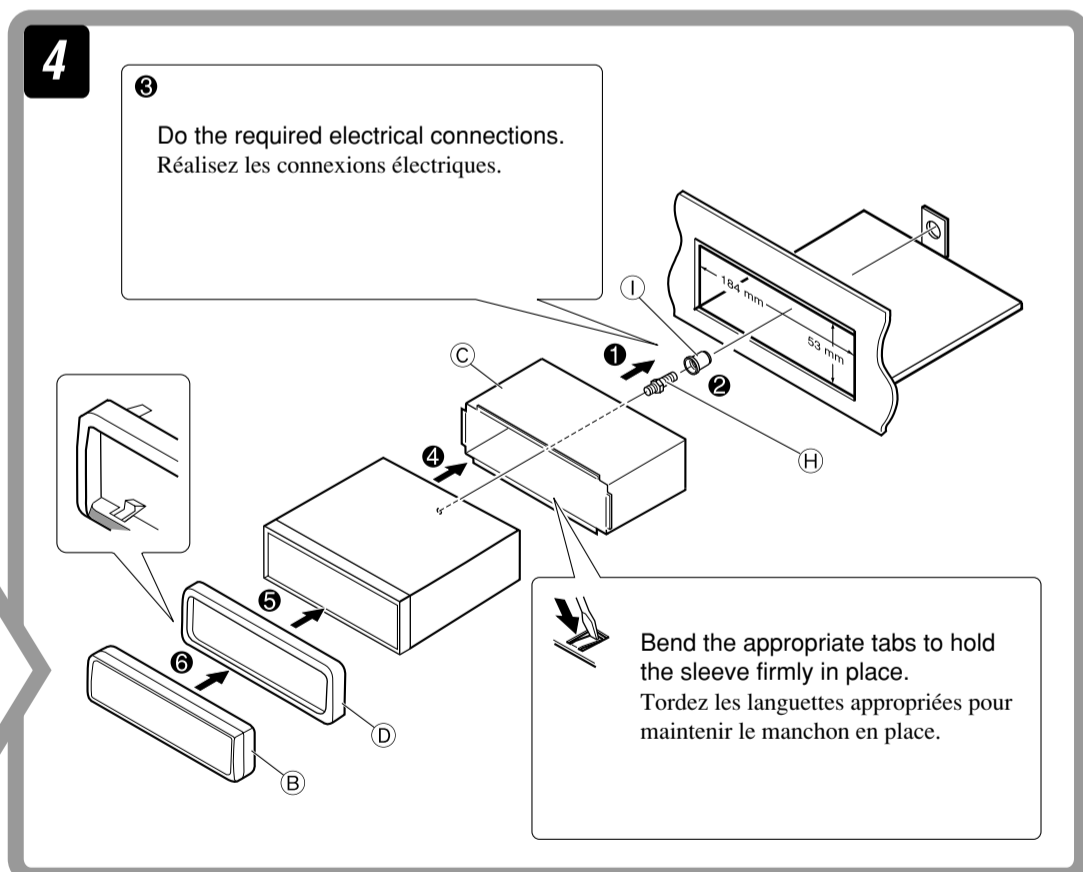

Removing the receiver

Before removing the receiver, release the rear section.

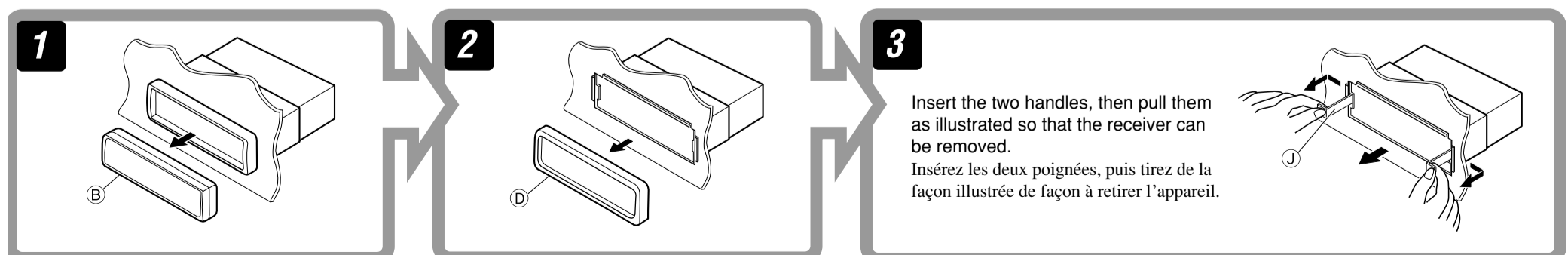

When using the optional stay / Lors de l'utilisation du hauban en option

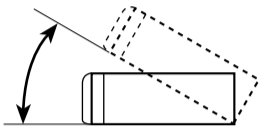
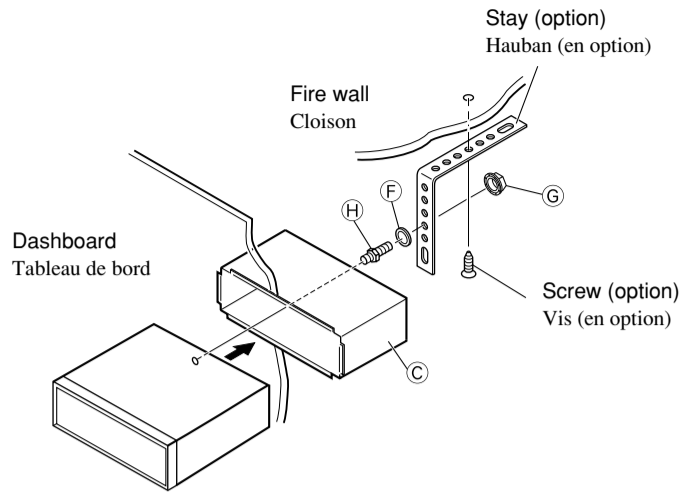

Install the receiver at an angle of less than 30°.
Installez l'appareil avec un angle de moins de 30°.

When installing the receiver without using the sleeve / Lors de l'installation de l'appareil sans utiliser de manchon

In a Toyota for example, first remove the car radio and install the receiver in its place.
Par exemple dans une Toyota, retirer d'abord l'autoradio et installer l'appareil à la place.

Flat type screws (M5 x 8 mm)*
Vis à tête plate (M5 x 8 mm)*

* Not included for this receiver.
* Non fourni avec cet autoradio.

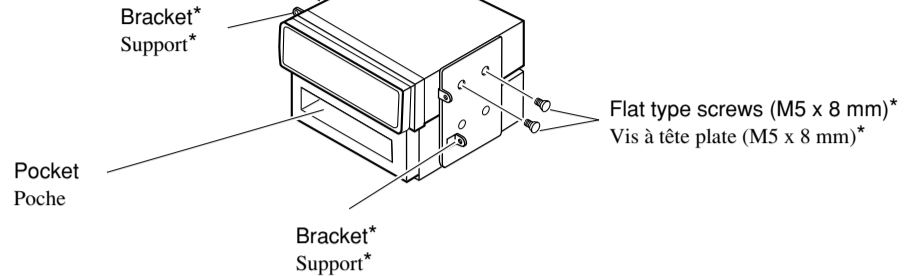

Note : When installing the receiver on the mounting bracket, make sure to use the 8 mm-long screws. If longer screws are used, they could damage the receiver.

Remarque : Lors de l'installation de l'appareil sur le support de montage, s'assurer d'utiliser des vis d'une longueur de 8 mm. Si des vis plus longues sont utilisées, elles peuvent endommager l'appareil.

ELECTRICAL CONNECTIONS

To prevent short circuits, we recommend that you disconnect the battery's negative terminal and make all electrical connections before installing the receiver.

• **Be sure to ground this receiver to the car's chassis again after installation.**

Notes:

- Replace the fuse with one of the specified rating. If the fuse blows frequently, consult your JVC IN-CAR ENTERTAINMENT dealer.
- It is recommended to connect to the speakers with maximum power of more than 50 W (both at the rear and at the front, with an impedance of **4 Ω to 8 Ω**). If the maximum power is less than 50 W, change "AMP GAIN" setting to prevent the speakers from being damaged (see page 24 of the INSTRUCTIONS).
- To prevent short-circuit, cover the terminals of the UNUSED leads with insulating tape.
- The heat sink becomes very hot after use. Be careful not to touch it when removing this receiver.

Heat sink
Dissipateur de chaleur

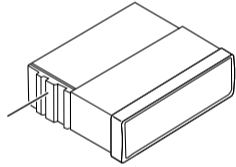

RACCORDEMENTS ELECTRIQUES

Pour éviter tout court-circuit, nous vous recommandons de débrancher la borne négative de la batterie et d'effectuer tous les raccordements électriques avant d'installer l'appareil.

• **Assurez-vous de raccorder de nouveau la mise à la masse de cet appareil au châssis de la voiture après l'installation.**

Remarques:

- Remplacer le fusible par un de la valeur précisée. Si le fusible saute souvent, consulter votre revendeur d'autoradios JVC.
- Il est recommandé de connecter des enceintes avec une puissance de plus de 50 W (les enceintes arrière et les enceintes avant, avec une impédance comprise entre **4 Ω et 8 Ω**). Si la puissance maximum est inférieure à 50 W, changez "AMP GAIN" pour éviter d'endommager vos enceintes (voir page 24 du MANUEL D'INSTRUCTIONS).
- Pour éviter les court-circuits, couvrir les bornes des fils qui ne sont PAS UTILISÉS avec de la bande isolante.
- Le dissipateur de chaleur devient très chaud après usage. Faire attention de ne pas le toucher en retirant cet appareil.

PRECAUTIONS on power supply and speaker connections:

- **DO NOT** connect the speaker leads of the power cord to the car battery; otherwise, the receiver will be seriously damaged.
- **BEFORE** connecting the speaker leads of the power cord to the speakers, check the speaker wiring in your car.

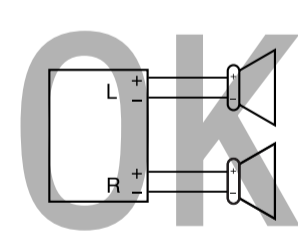
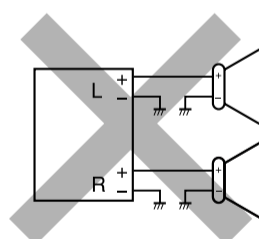
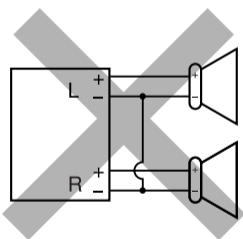

PRECAUTIONS sur l'alimentation et la connexion des enceintes:

- **NE CONNECTEZ PAS** les fils d'enceintes du cordon d'alimentation à la batterie; sinon, l'appareil serait sérieusement endommagé.
- **AVANT** de connecter les fils d'enceintes du cordon d'alimentation aux enceintes, vérifiez le câblage des enceintes de votre voiture.

TROUBLESHOOTING

- **The fuse blows.**
 - * Are the red and black leads connected correctly?
- **Power cannot be turned on.**
 - * Is the yellow lead connected?
- **No sound from the speakers.**
 - * Is the speaker output lead short-circuited?
- **Sound is distorted.**
 - * Is the speaker output lead grounded?
 - * Are the "-" terminals of L and R speakers grounded in common?
- **Noise interfere with sounds.**
 - * Is the rear ground terminal connected to the car's chassis using shorter and thicker cords?
- **Receiver becomes hot.**
 - * Is the speaker output lead grounded?
 - * Are the "-" terminals of L and R speakers grounded in common?
- **This receiver does not work at all.**
 - * Have you reset your receiver?

EN CAS DE DIFFICULTES

- **Le fusible saute.**
 - * Les fils rouge et noir sont-ils raccordés correctement?
- **L'appareil ne peut pas être mise sous tension.**
 - * Le fil jaune est-elle raccordée?
- **Pas de son des enceintes.**
 - * Le fil de sortie d'enceinte est-il court-circuité?
- **Le son est déformé.**
 - * Le fil de sortie d'enceinte est-il à la masse?
 - * Les bornes "-" des enceintes gauche et droit sont-elles mises ensemble à la masse?
- **Interférence avec les sons.**
 - * La prise arrière de mise à la terre est-elle connectée au châssis de la voiture avec un cordon court et épais?
- **L'appareil devient chaud.**
 - * Le fil de sortie d'enceinte est-il à la masse?
 - * Les bornes "-" des enceintes gauche et droit sont-elles mises ensemble à la masse?
- **Cet appareil ne fonctionne pas du tout.**
 - * Avez-vous réinitialisé votre appareil?

A Typical Connections / Raccordements typiques

Before connecting: Check the wiring in the vehicle carefully. Incorrect connection may cause serious damage to this receiver.

The leads of the power cord and those of the connector from the car body may be different in color.

- 1 Connect the colored leads of the power cord in the order specified in the illustration below.
- 2 Connect the aerial cord.
- 3 Finally connect the wiring harness to the receiver.

Note: If your vehicle does not have any accessory terminal, move the fuse from the fuse position 1 (initial position) to fuse position 2, and connect the red lead (A7) to the positive (+) battery terminal.

- The yellow lead (A4) is not used in this case.

Avant de commencer la connexion: Vérifiez attentivement le câblage du véhicule. Une connexion incorrecte peut endommager sérieusement l'appareil.

Le fil du cordon d'alimentation et ceux des connecteurs du châssis de la voiture peuvent être différents en couleur.

- 1 Connectez les fils colorés du cordon d'alimentation dans l'ordre spécifié sur l'illustration ci-dessous.
- 2 Connectez le cordon d'antenne.
- 3 Finalement, connectez le faisceau de fils à l'appareil.

Remarque: Si votre véhicule ne possède pas de borne accessoire, déplacez le fusible de la position de fusible 1 (position originale) à la position de fusible 2 et connectez le fil rouge (A7) à la borne positive (+) de la batterie.

- Le fil jaune (A4) n'est pas utilisé dans ce cas.

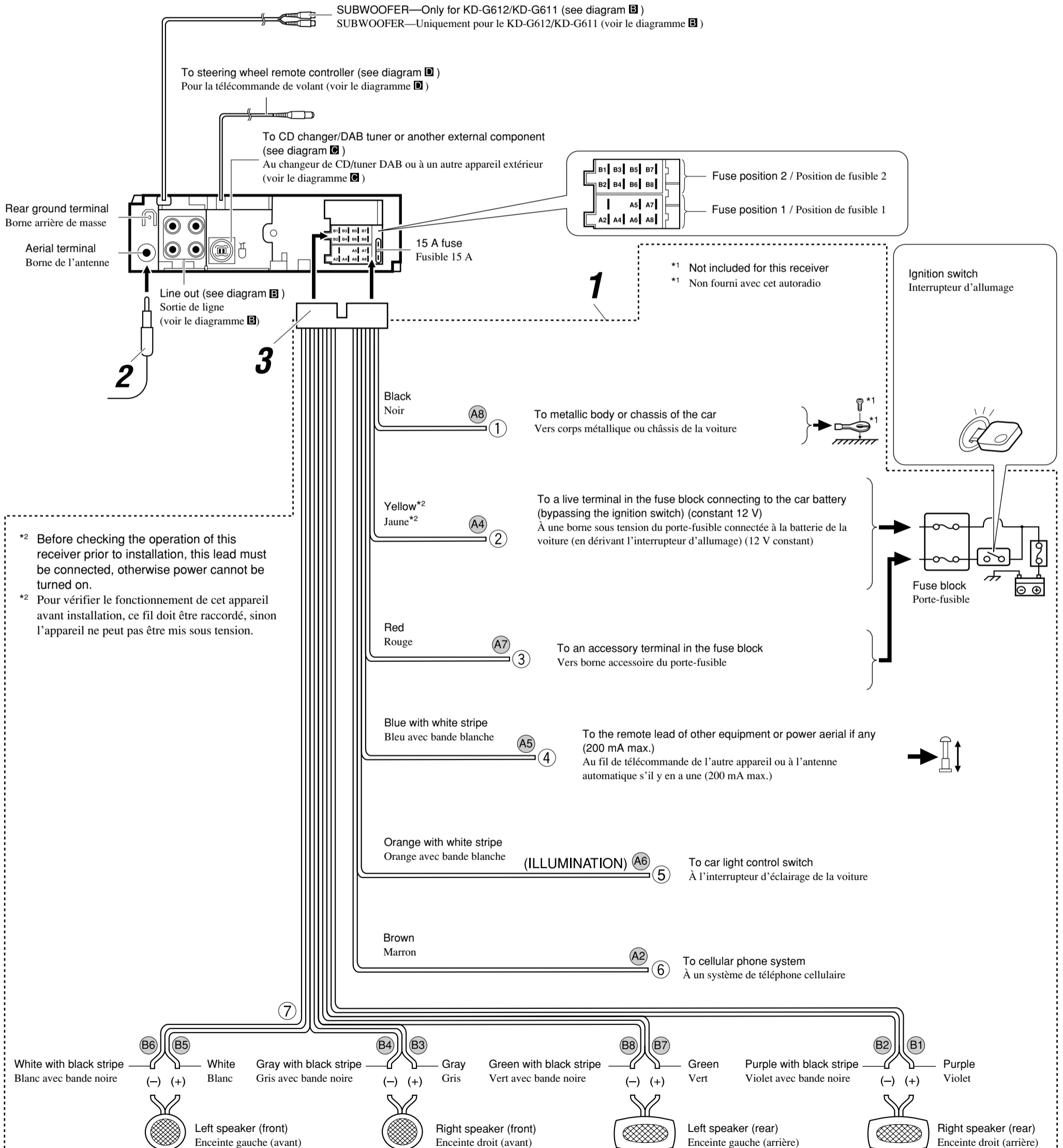

B Connecting the external amplifiers / Connexion d'amplificateurs extérieurs

You can connect amplifiers to upgrade your car stereo system.

- Connect the remote lead (blue with white stripe) to the remote lead of the other equipment so that it can be controlled through this receiver.
- **Disconnect the speakers from this receiver, connect them to the amplifier. Leave the speaker leads of this receiver unused.**

Vous pouvez connecter un amplificateur ou autre appareil pour améliorer votre système autoradio.

- Connectez le fil de commande à distance (bleu avec bande blanche) au fil de commande à distance de l'autre appareil de façon qu'il puisse être commandé via cet appareil.
- **Déconnectez les enceintes de cet appareil et connectez-les à l'amplificateur. Laissez les fils d'enceintes de cet appareil inutilisés.**

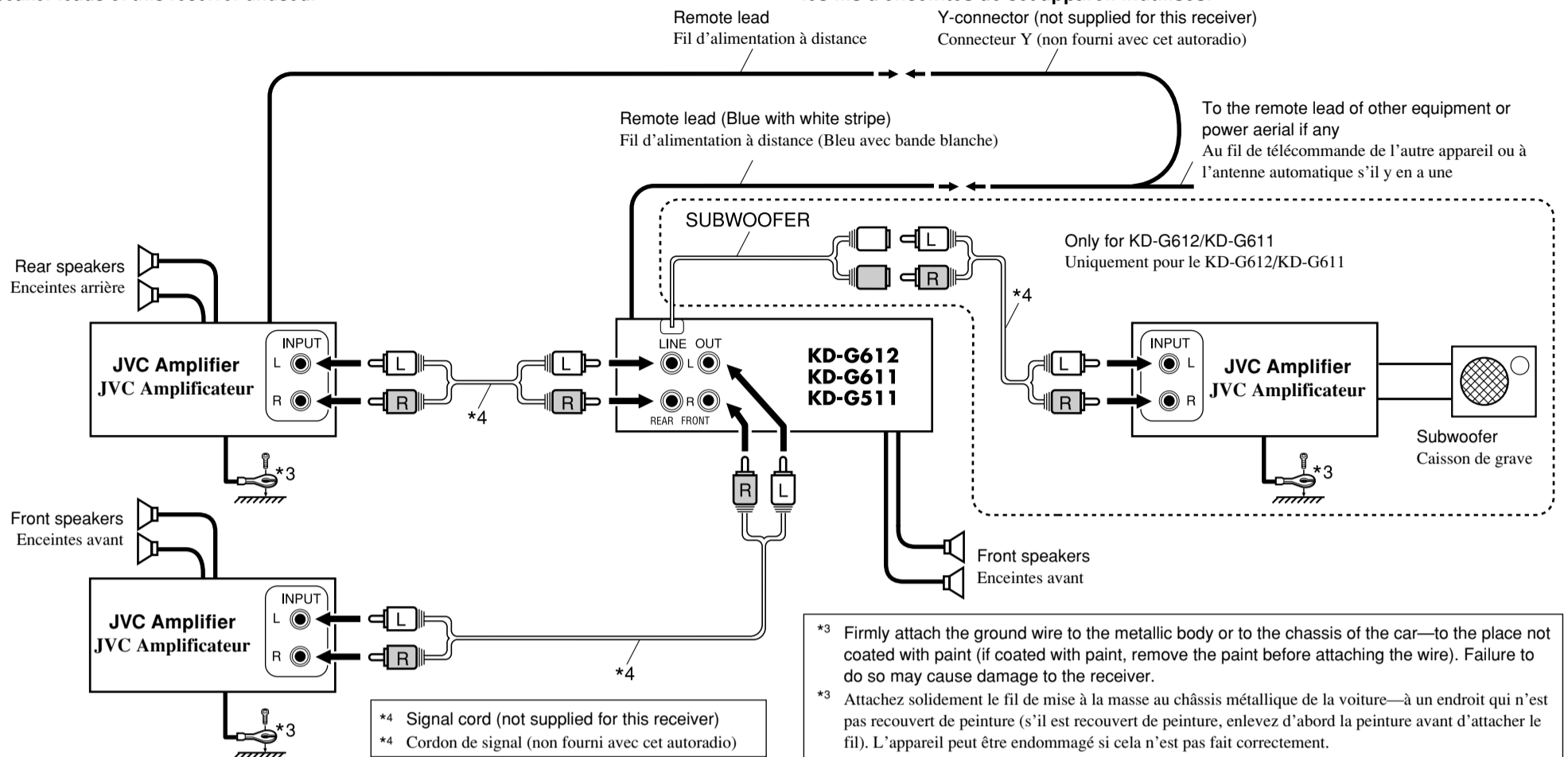

C Connecting the external components / Connexion d'un autre appareil extérieur

CD changer and DAB tuner / Changeur CD et tuner DAB

- Refer also to pages 15 and 28 of the INSTRUCTIONS.
- Référez-vous aussi à les pages 15 et 28 du MANUEL D'INSTRUCTIONS.
- You can connect both components in series as illustrated below.
- Vous pouvez connecter les deux appareils en série comme montré sur l'illustration.

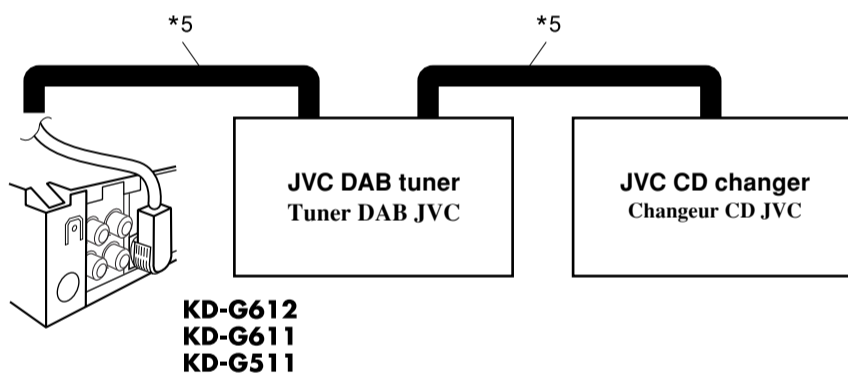

CAUTION / PRECAUTION:

- Before connecting the CD changer and/or DAB tuner, make sure that the receiver is turned off.
- Avant de connecter le changeur CD et/ou le tuner DAB, s'assurer que l'unité est éteinte.

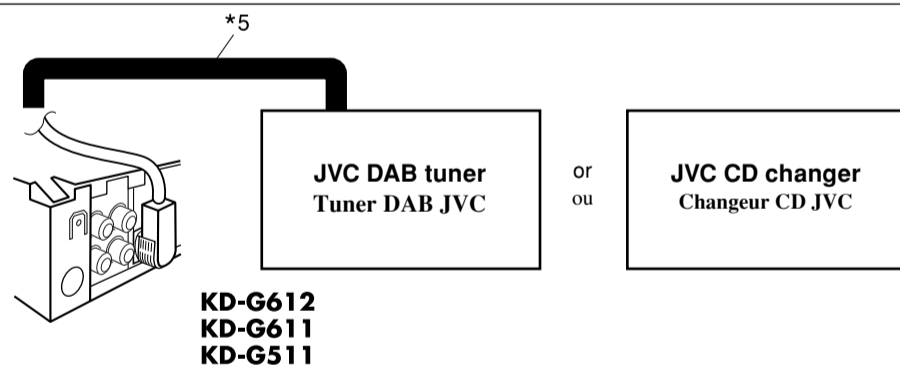

- *5 Connecting cord supplied for your CD changer or DAB tuner
- *5 Cordon de connexion fourni avec votre changeur CD ou tuner DAB

External Component / Appareil extérieur

- Set "EXT IN" for the external input setting (see page 24 of the INSTRUCTIONS.) / Choisissez "EXT IN" pour le réglage de l'entrée extérieure (référez-vous à la page 24 du MANUEL D'INSTRUCTIONS).

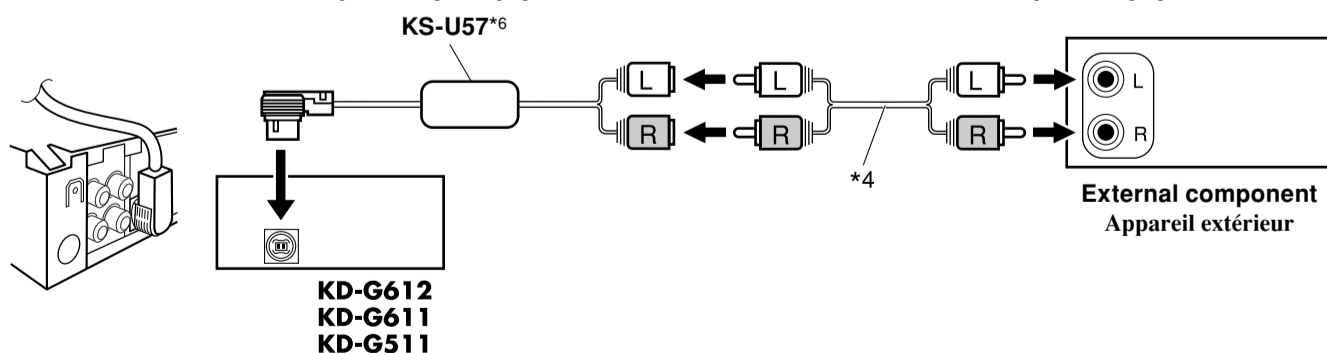

- *6 Line Input Adapter KS-U57 (not supplied for this receiver)
- *6 Adaptateur d'entrée de ligne KS-U57 (non fourni avec cet autoradio)

D Connecting to the steering wheel remote controller / Connexion de la télécommande de volant

If your car is equipped with the steering wheel remote controller, you can operate this receiver using the controller. To do it, a JVC's OE remote adapter (not supplied) which matches with your car is required. Consult your JVC IN-CAR ENTERTAINMENT dealer for details.

Si votre voiture est munie d'une télécommande de volant, vous pouvez commander cet autoradio en utilisant la télécommande. Pour le faire, un adaptateur pour télécommande au volant JVC (non fourni) correspondant à votre voiture est nécessaire. Consultez votre revendeur d'autoradio JVC pour les détails.

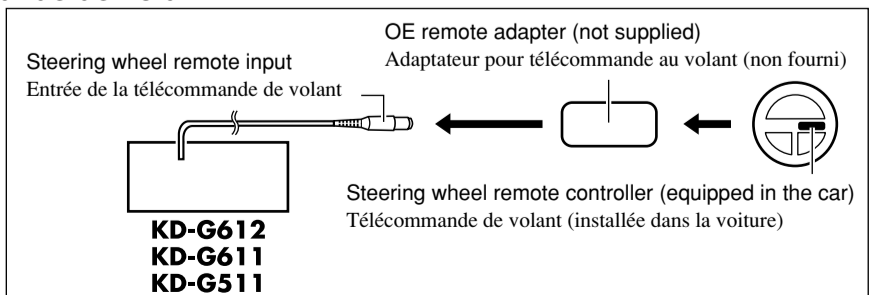

JVC

ENGLISH

РУССКИЙ

CD RECEIVER РЕСИВЕР С ПРОИГРЫВАТЕЛЕМ КОМПАКТ-ДИСКОВ

KD-G617

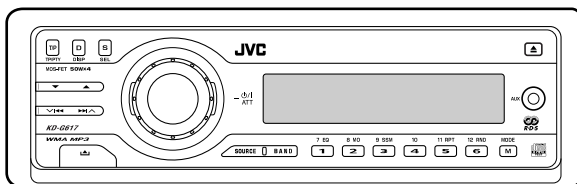
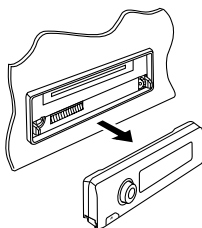

MP3 WMA

For installation and connections, refer to the separate manual.

Указания по установке и выполнению соединений приводятся в отдельной инструкции.

В соответствии с Законом Российской Федерации "О защите прав потребителей" срок службы (годности) данного товара "по истечении которого он может представлять опасность для жизни, здоровья потребителя, причинять вред его имуществу или окружающей среде" составляет семь (7) лет со дня производства. Этот срок является временем, в течение которого потребитель данного товара может безопасно им пользоваться при условии соблюдения инструкции по эксплуатации данного товара, проводя необходимое обслуживание, включающее замену расходных материалов и/или соответствующее ремонтное обеспечение в специализированном сервисном центре.

Дополнительные косметические материалы к данному товару, поставляемые вместе с ним, могут храниться в течение двух (2) лет со дня его производства.

Срок службы (годности), кроме срока хранения дополнительных косметических материалов, упомянутых в предыдущих двух пунктах, не затрагивает никаких других прав потребителя, в частности, гарантийного свидетельства JVC, которое он может получить в соответствии с законом о правах потребителя или других законов, связанных с ним.

For canceling the display demonstration, see page 8.

Информацию об отмене демонстрации функций дисплея см. на стр. 8.

INSTRUCTIONS ИНСТРУКЦИИ ПО ЭКСПЛУАТАЦИИ



GET0270-001A
[EE]

Thank you for purchasing a JVC product.

Please read all instructions carefully before operation, to ensure your complete understanding and to obtain the best possible performance from the unit.

IMPORTANT FOR LASER PRODUCTS

1. CLASS 1 LASER PRODUCT
2. **CAUTION:** Do not open the top cover. There are no user serviceable parts inside the unit; leave all servicing to qualified service personnel.
3. **CAUTION:** Visible and invisible laser radiation when open and interlock failed or defeated. Avoid direct exposure to beam.
4. REPRODUCTION OF LABEL: CAUTION LABEL, PLACED OUTSIDE THE UNIT.

CAUTION: Visible and invisible laser radiation when open and interlock failed or defeated. AVOID DIRECT EXPOSURE TO BEAM. (e)	ADVARSEL: Synlig og usynlig laserstråling når maskinen er åpen eller interlocken fejler. Undgå direkte eksponering til stråling. (e)	WARNING: Synlig och osynlig laserstråling när den öppnas och spärren är urkopplad. Beträkta strålen. (d)	VARO: Avatessa ja suojalukitus ohitettuna tai viallisena olet alttiina säteille ja säteilyille. Vältä säteeseen kohdistamista suoraan itseesi. (f)
--	---	---	---

Warning:

If you need to operate the receiver while driving, be sure to look ahead carefully or you may be involved in a traffic accident.

How to reset your unit

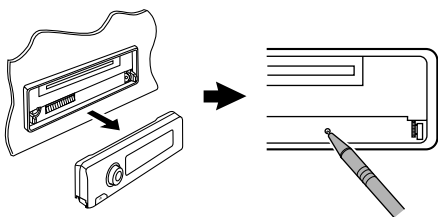

This will reset the microcomputer. Your preset adjustments will also be erased.

How to forcibly eject a disc

If a disc cannot be recognized by the receiver or cannot be ejected, ejects the disc as follows.

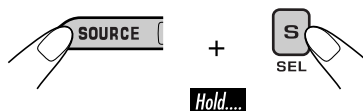

“PLEASE” and “EJECT” appear alternately on the display.

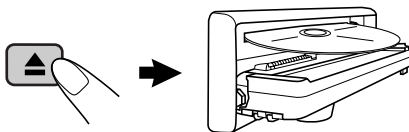

- If this does not work, reset your receiver.
- Be careful not to drop the disc when it ejects.

Contents

How to reset your unit	2	Sound adjustments	20
How to forcibly eject a disc	2	Selecting preset sound modes	
How to read this manual	4	(C-EQ: custom equalizer)	20
How to use the M MODE button	4	Adjusting the sound	21
Control panel — KD-G617	5	General settings — PSM	22
Parts identification	5	Basic procedure	22
Remote controller — RM-RK50 ...	6	Other main functions	25
Main elements and features	6	Assigning titles to the sources	25
Getting started	7	Detaching the control panel	26
Basic operations	7	External component operations... 27	
Canceling the display demonstrations ...	8	Playing an external component	27
Setting the clock	8	DAB tuner operations	28
Radio operations	9	Listening to the DAB tuner	28
Listening to the radio	9	Storing DAB services in memory	29
Storing stations in memory	10	Tuning in to a preset DAB service	29
Listening to a preset station	10	Tracing the same programme	
FM RDS operations	11	—Alternative Reception	29
Searching for your favorite FM RDS		Maintenance	30
programme	11	More about this receiver	31
Storing your favorite programmes	12	Troubleshooting	34
Using the standby receptions	12	Specifications	37
Tracking the same programme			
—Network-Tracking Reception	13		
Disc operations	14		
Playing a disc in the receiver	14		
Playing discs in the CD changer	15		
Other main functions	17		
Changing the display information	18		
Selecting the playback modes	19		

***For safety....**

- Do not raise the volume level too much, as this will block outside sounds, making driving dangerous.
- Stop the car before performing any complicated operations.

***Temperature inside the car....**

If you have parked the car for a long time in hot or cold weather, wait until the temperature in the car becomes normal before operating the unit.

How to read this manual

The following methods are used to make the explanations simple and easy-to-understand:

- Some related tips and notes are explained in “More about this receiver” (see pages 31 – 33).
- Button operations are mainly explained with the illustrations as follows:

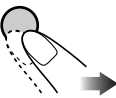
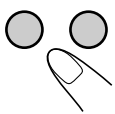
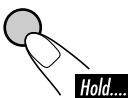
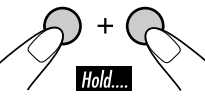
	Press briefly.
	Press repeatedly.
	Press either one.
	Press and hold until your desired response begins.
	Press and hold both buttons at the same time.

The following marks are used to indicate...



: Built-in CD player operations.



: External CD changer operations.

How to use the M MODE button

If you press M MODE, the receiver goes into functions mode, then the number buttons and ▲/▼ buttons work as different function buttons.

Ex.: When number button 2 works as MO (monaural) button.

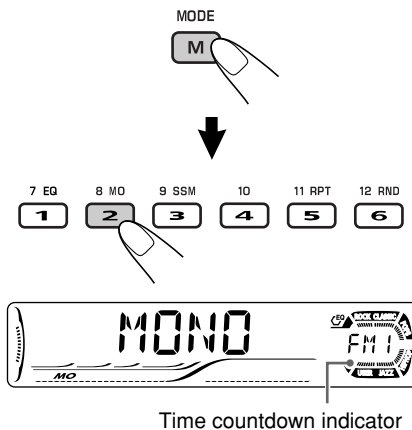

To use these buttons for original functions again after pressing M MODE, wait for 5 seconds without pressing any of these buttons until the functions mode is cleared.

- Pressing M MODE again also clears the functions mode.

Caution on volume setting:

Discs produce very little noise compared with other sources. Lower the volume before playing a disc to avoid damaging the speakers by the sudden increase of the output level.

Parts identification

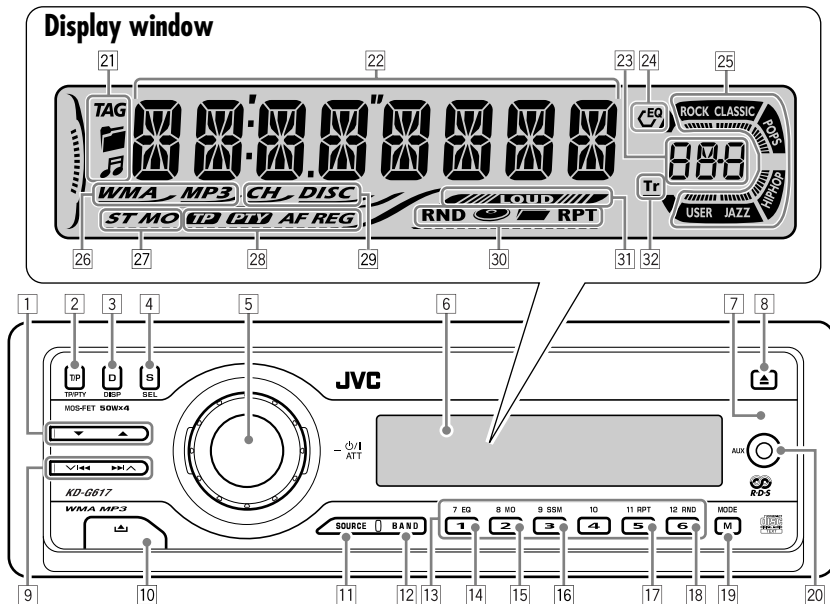

- 1 ▲ (up) / ▼ (down) buttons
- 2 T/P TP/PTY (traffic programme/programme type) button
- 3 D DISP (display) button
- 4 S SEL (select) button
- 5 • Control dial
 - ϕ /I ATT (standby/on attenuator) button
- 6 Display window
- 7 Remote sensor
 - *DO NOT* expose the remote sensor to strong light (direct sunlight or artificial lighting).
- 8 ▲ (eject) button
- 9 ▼ ◀▶▶▶ ▲ buttons
- 10 \square (control panel release) button
- 11 SOURCE button
- 12 BAND button
- 13 Number buttons
- 14 EQ (equalizer) button
- 15 MO (monaural) button
- 16 SSM (Strong-station Sequential Memory) button
- 17 RPT (repeat) button
- 18 RND (random) button
- 19 M MODE button
- 20 AUX (auxiliary) input jack
 - *NOT compatible with digital signals.*

Display window

- 21 Disc information indicators—TAG (ID3 Tag), \square (folder), \mathcal{M} (track/file)
- 22 Main display
- 23 Source display / Volume level indicator
- 24 EQ (equalizer) indicator
- 25 Sound mode (C-EQ: custom equalizer) indicators—ROCK, CLASSIC, POPS, HIP HOP, JAZZ, USER
 - ||||| also works as the time countdown indicator and level meter during play (see page 23).
- 26 Disc type indicators—WMA, MP3
- 27 Tuner reception indicators—ST (stereo), MO (monaural)
- 28 RDS indicators—TP, PTY, AF, REG
- 29 Playback source indicators—
 - CH: Lights up only when CD-CH is selected as the playback source.
 - DISC: Lights up for the built-in CD player.
- 30 Playback mode / item indicators—
 - RND (random), disc (disc), folder (folder), RPT (repeat)
- 31 LOUD (loudness) indicator
- 32 Tr (track) indicator

Installing the lithium coin battery (CR2025)

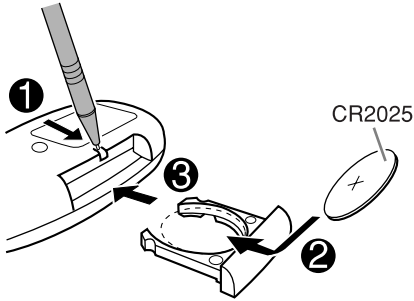

- When operating, aim the remote controller directly at the remote sensor on the receiver. Make sure there is no obstacle in between.

Warning:

- Store the battery in a place where children cannot reach to avoid risk of accident.
- To prevent the battery from over-heating, cracking, or starting a fire:
 - Do not recharge, short, disassemble, or heat the battery or dispose of it in a fire.
 - Do not leave the battery with other metallic materials.
 - Do not poke the battery with tweezers or similar tools.
 - Wrap the battery with tape and insulate when throwing away or saving it.

Caution:

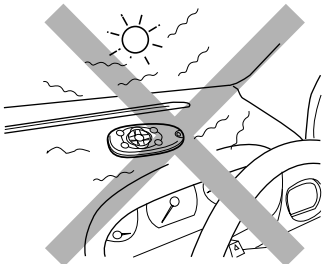

Main elements and features

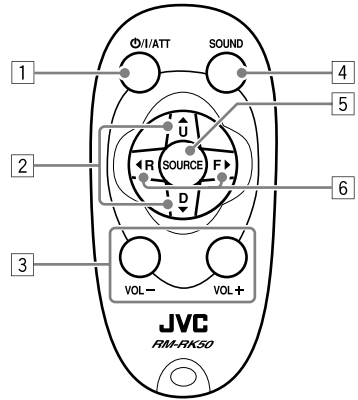

1. **⏻/ATT** (standby/on/attenuator) button
 - Turns on and off the power and also attenuates the sound.
2. **▲ U (up) / D (down) ▼** buttons
 - **▲ U**: Changes the FM/AM/DAB bands.
 - **D ▼**: Changes the preset stations (or services).
 - Changes the folder of the MP3/WMA discs.
 - While playing an MP3 disc on an MP3-compatible CD changer:
 - Changes the disc if pressed briefly.
 - Changes the folder if pressed and held.
3. **VOL - / VOL +** buttons
 - Adjusts the volume level.
4. **SOUND** button
 - Selects the sound mode (C-EQ: custom equalizer).
5. **SOURCE** button
 - Selects the source.
6. **◀ R (reverse) / F (forward) ▶** buttons
 - Searches for stations (or services) if pressed briefly.
 - Searches for ensembles if pressed and held.
 - Fast-forwards or reverses the track if pressed and held.
 - Changes the tracks of the disc.

Basic operations

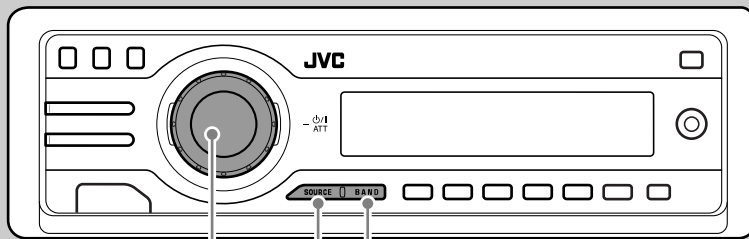

1

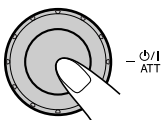

2

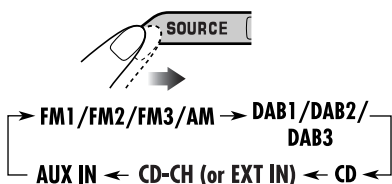

You cannot select some sources if they are not ready.

3

• For FM/AM tuner only

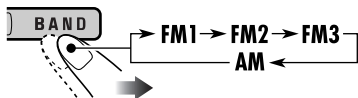

• For DAB tuner only



4

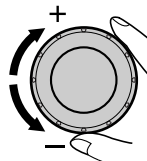

Volume level appears.



Volume level indicator

5

Adjust the sound as you want.
(See pages 20 and 21.)

To drop the volume in a moment (ATT)

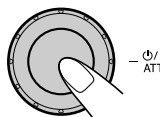

To restore the sound, press it again.

To turn off the power

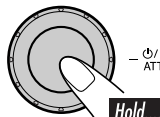

Canceling the display demonstrations

If no operations are done for about 20 seconds, display demonstration starts.

[Initial: DEMO ON]—see page 22.

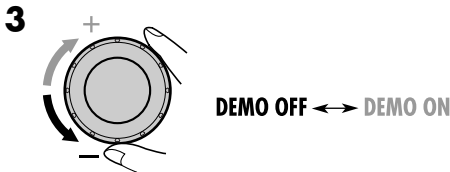
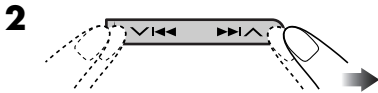

4 Finish the procedure.

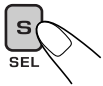

To activate the display demonstration

In step **3** above...

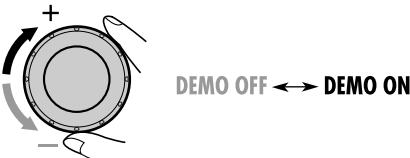

Setting the clock



2 Set the hour, minute, and clock system.

- 1 Select “CLOCK H” (hour), then adjust the hour.
- 2 Select “CLOCK M” (minute), then adjust the minute.
- 3 Select “24H/12H,” then select “24H” (hour) or “12H” (hour).

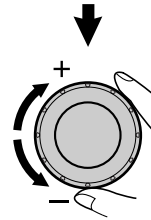
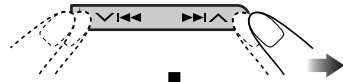

3 Finish the procedure.



To check the current clock time when the power is turned off



Listening to the radio

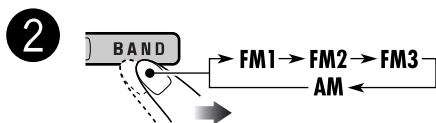
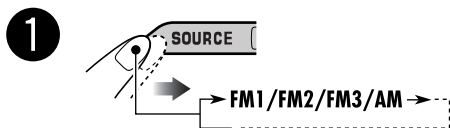
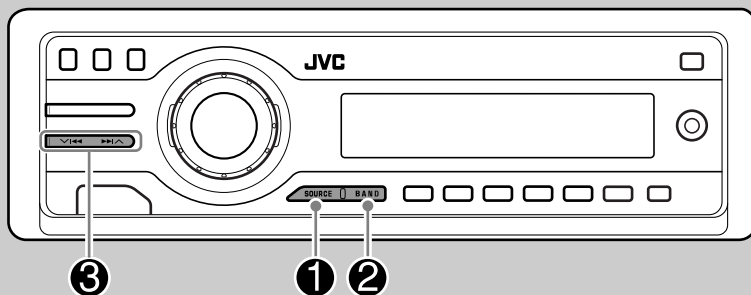

Selected band appears.

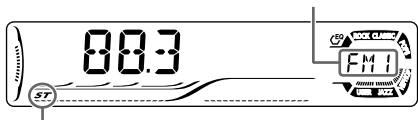

Lights up when receiving an FM stereo broadcast with sufficient signal strength.

3 Start searching for a station.

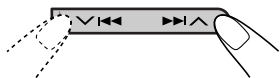

When a station is received, searching stops.

To stop searching, press the same button again.

Note:

FM1 and FM2: 87.5 MHz – 108.0 MHz

FM3: 65.00 MHz – 74.00 MHz

To tune in to a station manually

In step 3 on the left...

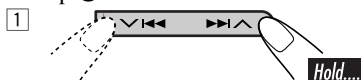

2 Select the desired station frequencies.



When an FM stereo broadcast is hard to receive

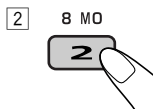
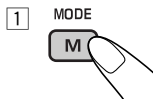

Lights up when monaural mode is activated.

Reception improves, but stereo effect will be lost.

To restore the stereo effect, repeat the same procedure. "MONO OFF" appears and the MO indicator goes off.

Storing stations in memory

You can preset six stations for each band.

FM station automatic presetting—SSM (Strong-station Sequential Memory)

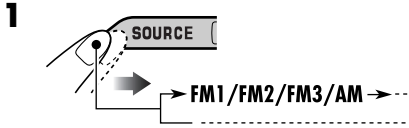

2 Select the FM band (FM1 – FM3) you want to store into.

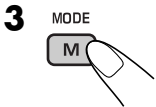

“SSM” flashes, then disappears when automatic presetting is over.

Local FM stations with the strongest signals are searched and stored automatically in the FM band.

Manual presetting

Ex.: Storing FM station of 92.5 MHz into the preset number 4 of the FM1 band.

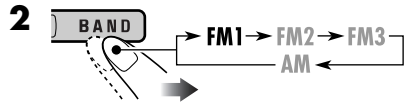
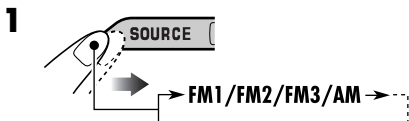

Preset number flashes for a while.

Listening to a preset station

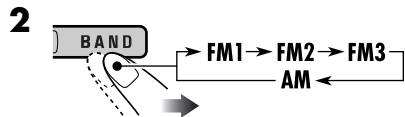
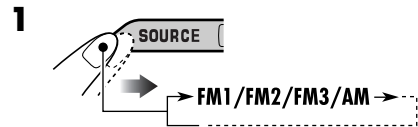

3 Select the preset station (1 – 6) you want.

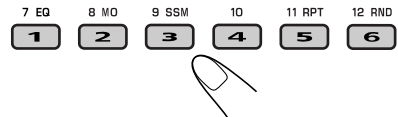

To check the current clock time while listening to an FM (non-RDS) or AM station

• For FM RDS stations, see page 13.

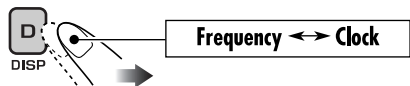

FM RDS operations

Searching for your favorite FM RDS programme

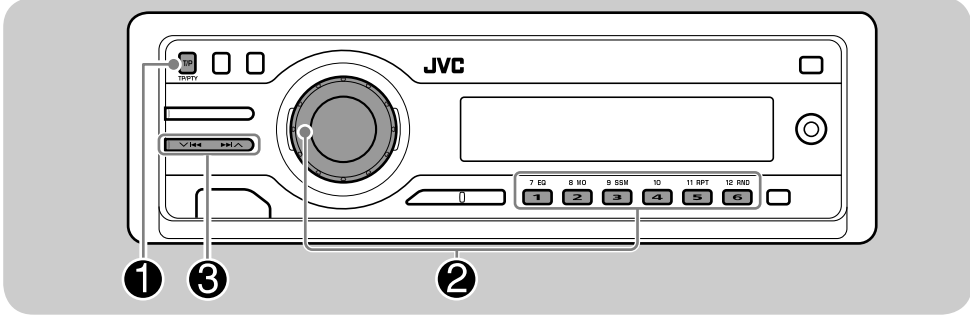

You can tune in to a station broadcasting your favorite programme by searching for a PTY code.

- To store your favorite programme, see page 12.

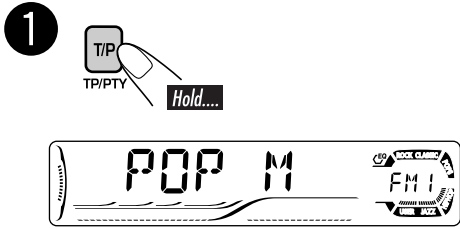

The last selected PTY code appears.

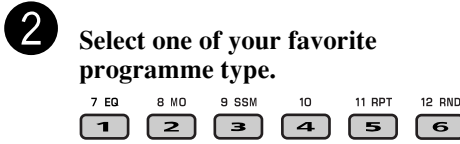

or

Select one of the twenty-nine PTY codes.

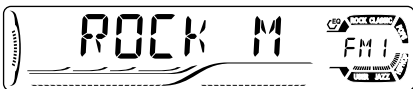
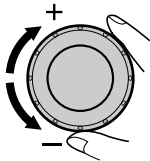

Ex.: When "ROCK M" is selected

3 Start searching for your favorite programme.

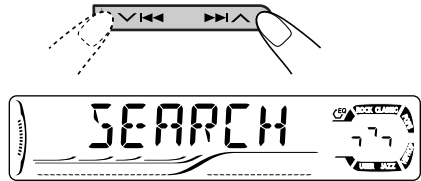

If there is a station broadcasting a programme of the same PTY code as you have selected, that station is tuned in.

PTY codes

NEWS, AFFAIRS, INFO, SPORT, EDUCATE, DRAMA, CULTURE, SCIENCE, VARIED, POP M (music), ROCK M (music), EASY M (music), LIGHT M (music), CLASSICS, OTHER M (music), WEATHER, FINANCE, CHILDREN, SOCIAL, RELIGION, PHONE IN, TRAVEL, LEISURE, JAZZ, COUNTRY, NATION M (music), OLDDIES, FOLK M (music), DOCUMENT

What you can do with RDS

RDS (Radio Data System) allows FM stations to send an additional signal along with their regular programme signals. By receiving the RDS data, this receiver can do the following:

- Programme Type (PTY) Search (see page 11)
- Temporarily switches to Traffic Announcement—TA Standby Reception. (See the right column.)
- Temporarily switches to your favorite programme—PTY Standby Reception. (See pages 13 and 23.)
- Tracing the same programme automatically—Network-Tracking Reception (see page 13)
- Programme Search (see page 23)

Storing your favorite programmes

You can store six favorite programme types.

Preset programme types in the number buttons (1 to 6):

1	2	3	4	5	6
POP M	ROCK M	EASY M	CLASSICS	AFFAIRS	VARIED

- 1 Select a PTY code (see page 11).
- 2 Select the preset number (1 – 6) you want to store into.

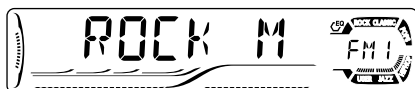

Ex.: When "ROCK M" is selected

- 3 Repeat steps 1 and 2 to store other PTY codes into other preset numbers.
- 4 Finish the procedure.



Using the standby receptions

TA Standby Reception

TA Standby Reception allows the receiver to switch temporarily to Traffic Announcement (TA) from any source other than AM.

- The volume changes to the preset TA volume level (see page 23).

To activate TA Standby Reception



The TP indicator either lights up or flashes.

- If the TP indicator lights up, TA Standby Reception is activated.
- If the TP indicator flashes, TA Standby Reception is not yet activated. (This occurs when you are listening to an FM station without the RDS signals required for TA Standby Reception.)

To activate TA Standby Reception, tune in to another station providing these signals. The TP indicator will stop flashing and remain lit.

To deactivate the TA Standby Reception



The TP indicator goes off.

PTY Standby Reception

PTY Standby Reception allows the receiver to switch temporarily to your favorite PTY programme from any source other than AM.

To activate and select your favorite PTY code for PTY Standby Reception, see page 23.

The PTY indicator either lights up or flashes.

- If the PTY indicator lights up, PTY Standby Reception is activated.
- If the PTY indicator flashes, PTY Standby Reception is not yet activated.
To activate PTY Standby Reception, tune in to another station providing these signals. The PTY indicator will stop flashing and remain lit.

To deactivate the PTY Standby Reception, select “OFF” for the PTY code (see page 23). The PTY indicator goes off.

Tracking the same programme— Network-Tracking Reception

When driving in an area where FM reception is not sufficient enough, this receiver automatically tunes in to another FM RDS station of the same network, possibly broadcasting the same programme with stronger signals (see the illustration below).

When shipped from the factory, Network-Tracking Reception is activated.

To change the Network-Tracking Reception setting, see “AF-REG” on page 23.

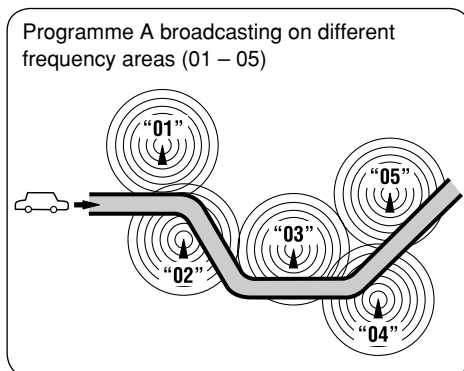

To check the current clock time while listening to an FM RDS station

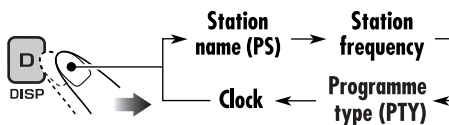

Disc operations

Playing a disc in the receiver

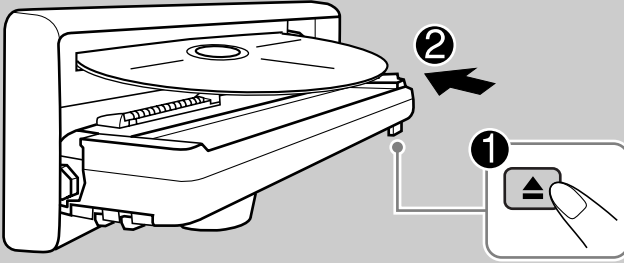

All tracks will be played repeatedly until you change the source or eject the disc.

About MP3 and WMA discs

MP3 and WMA (Windows Media® Audio) “tracks” (words “file” and “track” are used interchangeably) are recorded in “folders.”

- When inserting an MP3 or a WMA disc:



Total folder number Total track number



Disc information appears automatically (see page 18).

Elapsed playing time Current track number

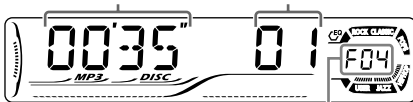

Selected folder number

* Either the MP3 or WMA indicator lights up depending on the detected file.

- When inserting an audio CD or a CD Text disc:

Total playing time of the inserted disc Total track number of the inserted disc



CD Text: Disc title/performer →
Track title appears automatically (see page 18).

Elapsed playing time Current track number



To stop play and eject the disc

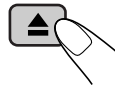

Playing discs in the CD changer

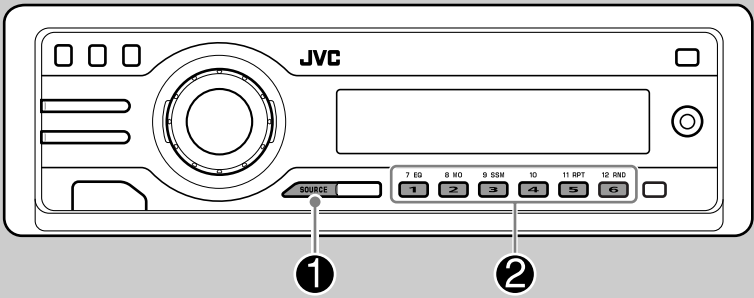

About the CD changer

It is recommended to use the JVC MP3-compatible CD changer with your receiver.

- You can also connect other CH-X series CD changers (except CH-X99 and CH-X100). However, they are not compatible with MP3 discs, so you cannot play back MP3 discs.
- You cannot use the KD-MK series CD changers with this receiver.
- Disc text information recorded in the CD Text can be displayed when a JVC CD Text compatible CD changer is connected.

Before operating your CD changer:

- Refer also to the Instructions supplied with your CD changer.
- You cannot control and play any WMA disc in the CD changer.

All tracks of the inserted discs in the magazine will be played repeatedly until you change the source or eject the magazine from the CD changer.

1

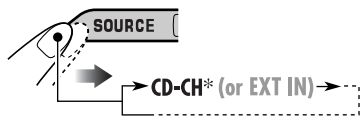

* If you have changed "EXT IN" setting to "EXT IN" (see page 24), you cannot select the CD changer.



Selected disc number

2

Select a disc.

For disc number from 01 – 06:



For disc number from 07 – 12:



- When the current disc is an MP3 disc:



Folder name*



Selected folder number

Disc information appears automatically (see page 18).

Elapsed playing time Current track number



* "ROOT" appears if no folder is included in the disc.

- When the current disc is an audio CD or a CD Text disc:

CD Text: Disc title/performer →
Track title appears automatically
(see page 18).

Elapsed playing time Current track number



To fast-forward or reverse the track

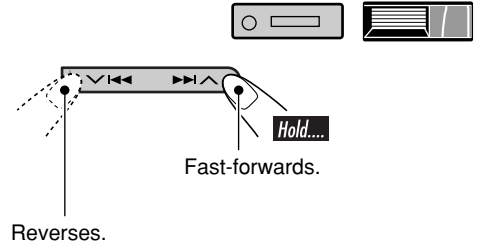

To go to the next or previous tracks

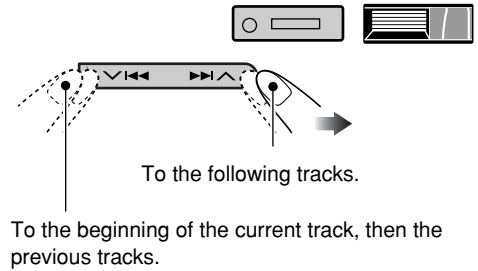

To go to the next or previous folders (only for MP3 or WMA discs)

For MP3 discs:

For WMA discs:

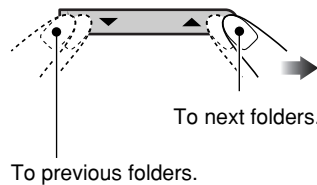

To locate a particular track (for CD) or folder (for MP3 or WMA discs) directly



To select a number from 01 – 06:



To select a number from 07 – 12:

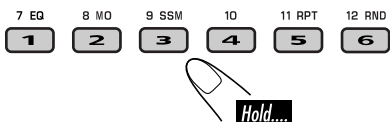

- To use folder search on MP3/WMA discs, it is required that folders are assigned with 2-digit numbers at the beginning of their folder names—01, 02, 03, and so on.

- To select a particular track in a folder (for MP3 or WMA disc) after selecting a folder:

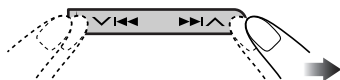

Other main functions

Skipping a track quickly during play



- For MP3 or WMA disc, you can skip a track within the same folder.

Ex.: To select track 32 while playing track 6

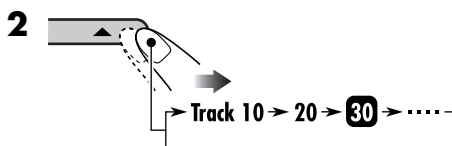
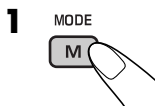

First time you press +10 or -10 button, the track skips to the nearest higher or lower track with a track number of multiple ten (ex. 10th, 20th, 30th). Then each time you press the button, you can skip 10 tracks.

- After the last track, the first track will be selected and vice versa.

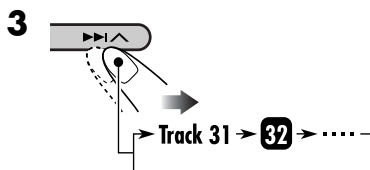

Prohibiting disc ejection



You can lock a disc in the loading slot.

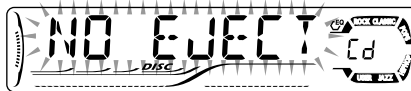
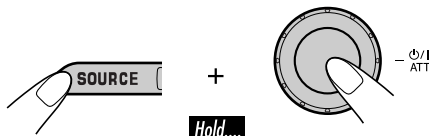

To cancel the prohibition, repeat the same procedure.



Changing the display information



■ While playing an audio CD or a CD Text (/)

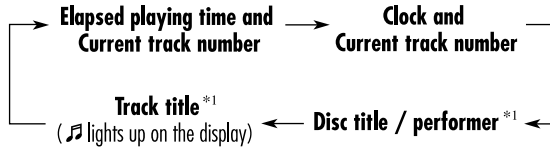

*1 If no title is assigned to an audio CD, "NO NAME" appears. To assign a title to an audio CD, see page 25.

■ While playing an MP3 (/) or WMA () disc

- When "TAG DISP" is set to "TAG ON" (see page 24)

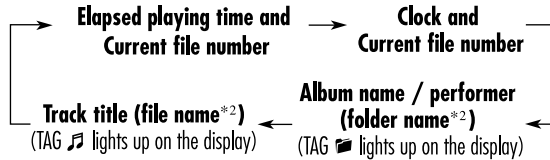

*2 If an MP3/WMA file does not have ID3 tags, folder name and file name appear. In this case, the TAG indicator will not light up.

- When "TAG DISP" is set to "TAG OFF"

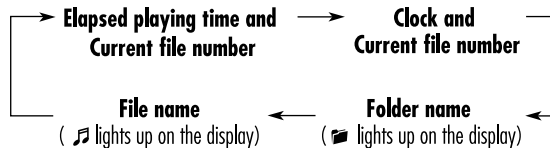

Selecting the playback modes

You can use only one of the following playback modes at a time.

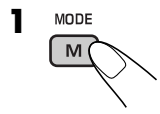

2 Select your desired playback mode.

Repeat play

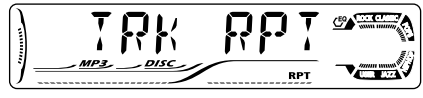
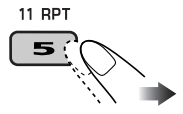

Ex.: When "TRK RPT" is selected while playing an MP3 disc in the receiver

Mode	Plays repeatedly
TRK RPT	: The current track. • RPT lights up.
FLDR RPT *1	: All tracks of the current folder. • and RPT light up.
DISC RPT *2	: All tracks of the current disc. • and RPT light up.
RPT OFF	: Cancels.

Random play

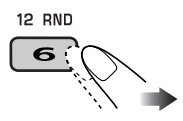

Ex.: When "DISC RND" is selected while playing an MP3 disc in the receiver

Mode	Plays at random
FLDR RND *1	: All tracks of the current folder, then tracks of the next folder and so on. • RND and light up.
DISC RND	: All tracks of the current disc. • RND and light up.
MAG RND *2	: All tracks of the inserted discs. • RND lights up.
RND OFF	: Cancels.

*1 Only while playing an MP3 (/) or WMA () disc.

*2 Only while playing discs in the CD changer ().

Sound adjustments

Selecting preset sound modes (C-EQ: custom equalizer)

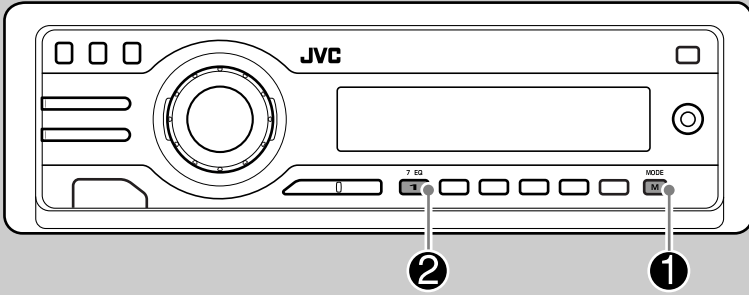

You can select a preset sound mode suitable to the music genre.

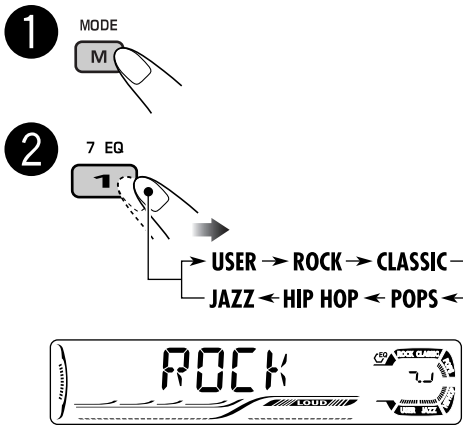

Ex.: When "ROCK" is selected

Indication	For:	Preset values		
		BAS* ¹	TRE* ²	LOUD* ³
USER	(Flat sound)	00	00	OFF
ROCK	Rock or disco music	+03	+01	ON
CLASSIC	Classical music	+01	-02	OFF
POPS	Light music	+04	+01	OFF
HIP HOP	Funk or rap music	+02	00	ON
JAZZ	Jazz music	+02	+03	OFF

*1 *BAS*: Bass

*2 *TRE*: Treble

*3 *LOUD*: Loudness

Indication pattern for each sound mode:

USER	ROCK
JAZZ	CLASSIC
HIP HOP	POPS

Adjusting the sound

You can adjust the sound characteristics to your preference.

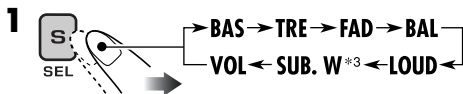

Ex.: When "TRE" is selected

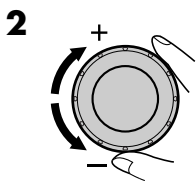

Indication pattern changes as you adjust the level.

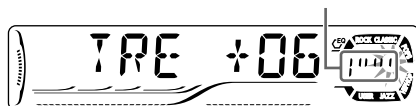

Indication	To do:	Range
BAS*1 (bass)	Adjust the bass.	-06 (min.) to +06 (max.)
TRE*1 (treble)	Adjust the treble.	-06 (min.) to +06 (max.)
FAD*2 (fader)	Adjust the front and rear speaker balance.	R06 (Rear only) to F06 (Front only)
BAL (balance)	Adjust the left and right speaker balance.	L06 (Left only) to R06 (Right only)
LOUD*1 (loudness)	Boost low and high frequencies to produce a well-balanced sound at low volume level.	LOUD ON ↓ LOUD OFF
SUB. W*3 (subwoofer)	Adjust the subwoofer output level.	00 (min.) to 08 (max.)
VOL*4 (volume)	Adjust the volume.	00 (min.) to 30 or 50 (max.)*5

*1 When you adjust the bass, treble, or loudness, the adjustment you have made is stored for the currently selected sound mode (C-EQ) including "USER."

*2 If you are using a two-speaker system, set the fader level to "00."

*3 This takes effect only when a subwoofer is connected.

*4 Normally the control dial works as the volume control. So you do not have to select "VOL" to adjust the volume level.

*5 Depending on the amplifier gain control setting. (See page 24 for details.)

General settings — PSM

Basic procedure

You can change PSM (Preferred Setting Mode) items listed in the table that follows.



2 Select a PSM item.

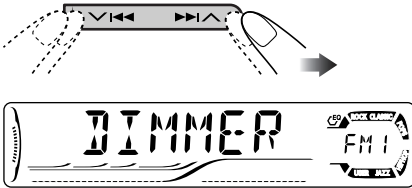

Ex.: When you select "DIMMER"

3 Adjust the PSM item selected.

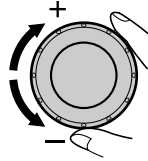

4 Repeat steps 2 and 3 to adjust the other PSM items if necessary.

5 Finish the procedure.



Indications	Selectable settings, [reference page]
DEMO Display demonstration	DEMO ON : [Initial]; Display demonstration will be activated automatically if no operation is done for about 20 seconds, [8]. DEMO OFF : Cancels.
CLOCK H Hour adjustment	0 – 23 (1 – 12), [8] [Initial: 0 (0:00)]
CLOCK M Minute adjustment	00 – 59, [8] [Initial: 00 (0:00)]
24H/12H 24 hours or 12 hours time display	12H ⇄ 24H, [8] [Initial: 24H]
CLK ADJ Clock adjustment	AUTO : [Initial]; The built-in clock is automatically adjusted using the CT (clock time) data in the RDS signal. OFF : Cancels.

Indications	Selectable settings, [reference page]
AF-REG Alternative frequency/ regionalization reception	When the received signals from the current station become weak... AF : [Initial]; Switches to another station (the programme may differ from the one currently received), [13]. • The AF indicator lights up. AF REG : Switches to another station broadcasting the same programme. • The AF and REG indicators light up. OFF : Cancels (not selectable when “DAB AF” is set to “AF ON”).
PTY-STBY PTY standby	Activates PTY Standby Reception with one of the 29 PTY codes, [13]. OFF [Initial] → 29 PTY codes, [11] → (back to the beginning)
TA VOL Traffic announcement volume	[Initial: VOL 20]; VOL 00 — VOL 30 or 50*1, [12]
P-SEARCH Programme search	ON : Using the AF data, the receiver tunes in to another frequency broadcasting the same programme as the original preset RDS station is if the preset station signals are not sufficient. OFF : [Initial]; Cancels.
DAB AF *2 Alternative frequency reception	AF ON : [Initial]; Traces the programme among DAB services and FM RDS stations, [29]. AF OFF : Cancels.
DAB VOL *2 DAB volume adjustment	You can adjust the volume level (VOL -12 — VOL +12) of DAB tuner to match the FM sound level and store it in memory. [Initial: VOL 00]
LEVEL Audio level meter	ON : [Initial]; Activates the audio level indicator. OFF : Cancels; sound mode indicator is shown, [20].
DIMMER Dimmer	AUTO : [Initial]; Dims the display when you turn on the headlights. ON : Activates dimmer. OFF : Cancels.

*1 Depends on the amplifier gain control.

*2 Displayed only when DAB tuner is connected.

To be continued...

Indications	Selectable settings, [reference page]
TEL Telephone muting	MUTING 1/MUTING 2: Select either one which mutes the sounds while using the cellular phone. OFF : [Initial]; Cancels.
SCROLL *1 Scroll	ONCE : [Initial]; Scrolls the disc information once. AUTO : Repeats scrolling (5-second intervals in between). OFF : Cancels. • Pressing D DISP for more than one second can scroll the display regardless of the setting.
WOOFER Subwoofer cutoff frequency	LOW : Frequencies lower than 55 Hz are send to the subwoofer. MID : [Initial]; Frequencies lower than 85 Hz are send to the subwoofer. HIGH : Frequencies lower than 115 Hz are send to the subwoofer.
EXT IN *2 External input	CHANGER : [Initial]; To use a JVC CD changer, [15] or DAB tuner, [28]. EXT IN : To use another external component, [27].
AUX ADJ Auxiliary input level adjustment	A.ADJ 00 – A.ADJ 05: Adjust the auxiliary input level accordingly, to avoid the sudden increase of the output level when changing the source from external component connected to the AUX input jack on the control panel. [Initial: A.ADJ 00]
TAG DISP Tag display	TAG ON : [Initial]; Shows the ID3 tag while playing MP3/WMA tracks, [18]. TAG OFF : Cancels.
AMP GAIN Amplifier gain control	You can change the maximum volume level of this receiver. LOW PWR : VOL 00 – VOL 30 (Select this if the maximum power of the speaker is less than 50 W to prevent them from damaging the speaker.) HIGH PWR : [Initial]; VOL 00 – VOL 50

*1 Some characters or symbols will not be shown (and will be blanked) on the display (Ex. "ABBÈ 6 !" ⇔ "АВВЕ Б ").

*2 Displayed only when one of the following sources is selected—FM, AM, CD, or AUX IN.

Other main functions

Assigning titles to the sources

You can assign titles to CDs (both in this receiver and in the CD changer).

Sources	Maximum number of characters
CDs/CD-CH	Up to 32 characters (up to 30 discs)

* You cannot assign a title to a CD Text or an MP3/WMA disc.

1 Select the sources.

- For a CD in this receiver: Insert a CD.
- For CDs in the CD changer: Select “CD-CH,” then select a disc number.

2 Enter the title assignment mode.



Ex.: When you select CD as the source

3 Assign a title.

1 Select a character.

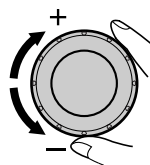

А	Б	В	Г	Д	Е	Ж	З	И	Й	К	Л	М	Н
О	П	Р	С	Т	У	Ф	Х	Ц	Ч	Ш	Щ	Ъ	Ы
Ь	Э	Ю	Я	Ё	А	В	С	Д	Е	Ф	Г	Н	И
Ж	К	Л	М	Н	О	Р	Q	R	S	T	U	V	W
X	Y	Z	0	1	2	3	4	5	6	7	8	9	-
/	<	>	space										

2 Move to the next (or previous) character position.

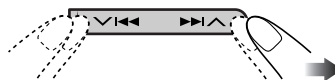

3 Repeat steps 1 and 2 until you finish entering the title.

4 Finish the procedure.



To erase the entire title

In step 2 on the left...



Detaching the control panel

When detaching or attaching the control panel, be careful not to damage the connectors on the back of the control panel and on the panel holder.

■ Detaching the control panel

Before detaching the control panel, be sure to turn off the power.

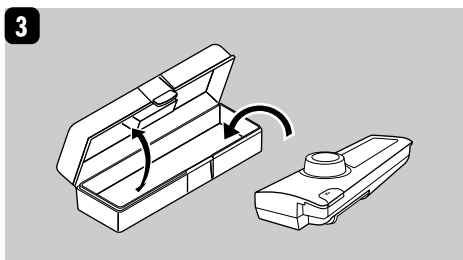
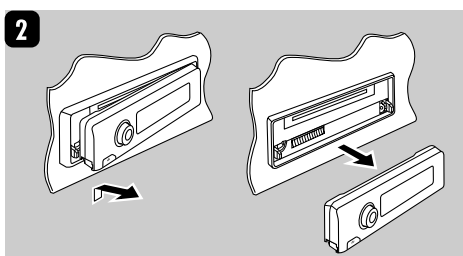
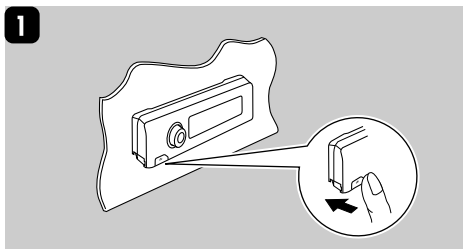

■ Attaching the control panel

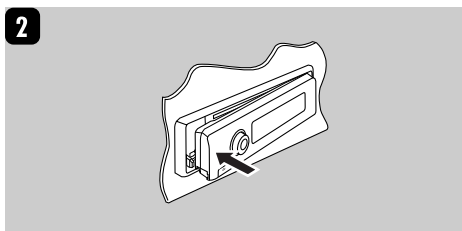
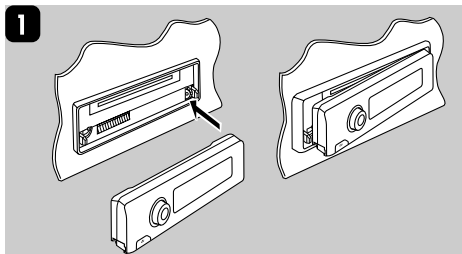

External component operations

Playing an external component

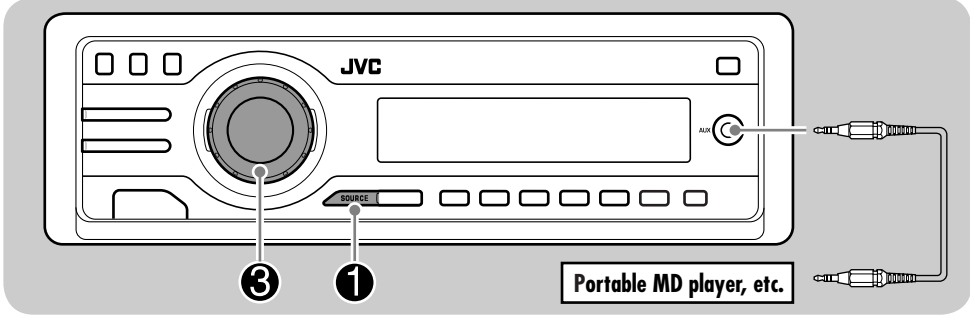

You can connect an external component to the CD changer jack on the rear using the Line Input Adapter KS-U57 (not supplied), and another to the AUX (auxiliary) input jack on the control panel.

- For connection, see Installation/Connection Manual (separate volume).

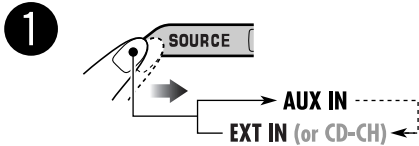

AUX IN : For selecting the external component connected to the AUX input jack.



EXT IN : For selecting the external component connected to the CD changer jack on the rear using KS-U57.



- If “EXT IN” does not appear, see page 24 and select the external input (EXT IN).

2 Turn on the connected component and start playing the source.

3 Adjust the volume.

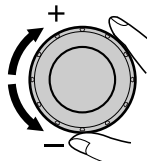

4 Adjust the sound as you want. (See pages 20 and 21.)

DAB tuner operations

Listening to the DAB tuner

ENGLISH

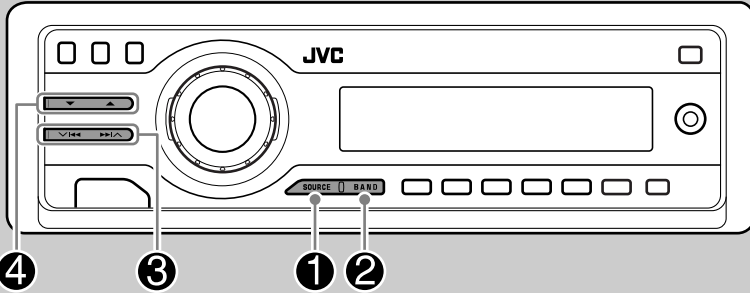

1

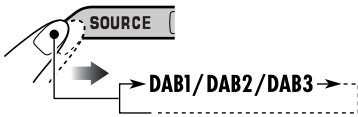

2 Select the desired ensemble frequencies.

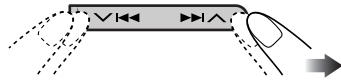

2



3

Start searching for an ensemble.

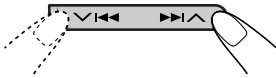

When an ensemble is received, searching stops.

To stop searching, press the same button again.

4

Select a service (either primary or secondary) to listen to.



To tune in to an ensemble manually

In step 3 above...

1



What is DAB system?

DAB can deliver CD quality sound without any annoying interference and signal distortion. Furthermore, it can carry text, pictures, and data. When transmitting, DAB combines several programmes (called “services”) to form one “ensemble.” In addition, each “service”—called “primary service”—can also be divided into its components (called “secondary service”). A typical ensemble has six or more programmes (services) broadcast at the same time.

By connecting the DAB tuner, this receiver can do the following:

- Tracing the same programme automatically —Alternative Reception (see “DAB AF” on page 23).

It is recommended to use DAB (Digital Audio Broadcasting) tuner KT-DB1000 with your receiver. If you have another DAB tuner, consult your JVC IN-CAR ENTERTAINMENT dealer.

- Refer also to the Instructions supplied for your DAB tuner.

Storing DAB services in memory

You can preset six DAB services (primary) for each band.

- 1 Perform steps 1 to 4 on page 28, to select a service you want.
- 2 Select the preset number (1 – 6) you want to store into.

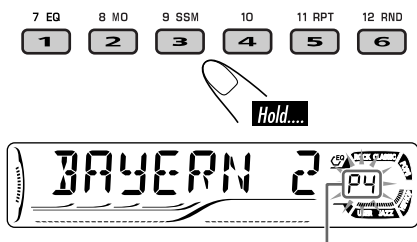

Preset number flashes for a while.

Tracing the same programme— Alternative Reception

You can keep listening to the same programme by activating the Alternative Reception.

- **While receiving a DAB service:**
When driving in an area where a service cannot be received, this receiver automatically tunes in to another ensemble or FM RDS station, broadcasting the same programme.
- **While receiving an FM RDS station:**
When driving in an area where a DAB service is broadcasting the same programme as the FM RDS station is broadcasting, this receiver automatically tunes in to the DAB service.

When shipped from the factory, Alternative Reception is activated.

To deactivate the Alternative Reception, see page 23.

Tuning in to a preset DAB service

- 1 SOURCE → DAB1/DAB2/DAB3
- 2 BAND → DAB1 → DAB2 → DAB3
- 3 Select the preset DAB service (primary) number (1 – 6) you want.

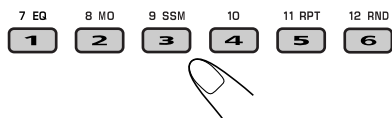

If the selected primary service has some secondary services, press the same button again will tune in to the secondary services.

To change the display information while tuning in to an ensemble

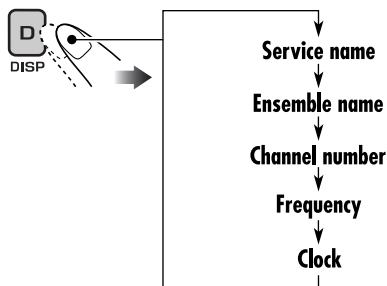

Maintenance

How to clean the connectors

Frequent detachment will deteriorate the connectors.

To minimize this possibility, periodically wipe the connectors with a cotton swab or cloth moistened with alcohol, being careful not to damage the connectors.

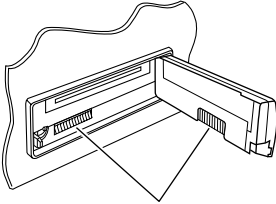

Connector

Moisture condensation

Moisture may condense on the lens inside the CD player in the following cases:

- After starting the heater in the car.
- If it becomes very humid inside the car.

Should this occur, the CD player may malfunction. In this case, eject the disc and leave the receiver turned on for a few hours until the moisture evaporates.

How to handle discs

When removing a disc from its case, press down the center holder of the case and lift the disc out, holding it by the edges.

Center holder



- Always hold the disc by the edges. Do not touch its recording surface.

When storing a disc into its case, gently insert the disc around the center holder (with the printed surface facing up).

- Make sure to store discs into the cases after use.

To keep discs clean

A dirty disc may not play correctly. If a disc does become dirty, wipe it with a soft cloth in a straight line from center to edge.



- Do not use any solvent (for example, conventional record cleaner, spray, thinner, benzene, etc.) to clean discs.

To play new discs

New discs may have some rough spots around the inner and outer edges. If such a disc is used, this receiver may reject the disc.



To remove these rough spots, rub the edges with a pencil or ball-point pen, etc.

Do not use the following discs:

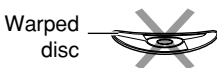

More about this receiver

Basic operations

Turning on the power

- By pressing SOURCE on the receiver, you can also turn on the power.

Selecting the sources

- When no disc is loaded in the receiver, “CD” cannot be selected.
- Without connecting to the CD changer or DAB tuner, “CD-CH” or “DAB” cannot be selected.

Turning off the power

- If you turn off the power while listening to a disc, disc play will start from where playback has been stopped previously, next time you turn on the power.

Tuner operations

Storing stations in memory

- During SSM search...
 - All previously stored stations are erased and stations are stored newly.
 - Received stations are preset in No. 1 (lowest frequency) to No. 6 (highest frequency).
 - When SSM is over, the station stored in No. 1 will be automatically tuned in.
- When storing a station manually, a previously preset station is erased when a new station is stored in the same preset number.

FM RDS operations

- Network-Tracking Reception requires two types of RDS signals—PI (Programme Identification) and AF (Alternative Frequency) to work correctly. Without receiving these data correctly, Network-Tracking Reception will not operate.

- If a Traffic Announcement is received, the volume level (TA VOL) automatically changes to the preset level.
- If a DAB tuner is connected and Alternative Reception for DAB services (DAB AF) is activated, Network-Tracking Reception (AF-REG) is also activated automatically. On the other hand, Network-Tracking Reception cannot be deactivated without deactivating Alternative Reception. (See page 23.)
- If you want to know more about RDS, visit <http://www.rds.org.uk>.

Disc operations

Caution for DualDisc playback

- The Non-DVD side of a “DualDisc” does not comply with the “Compact Disc Digital Audio” standard. Therefore, the use of Non-DVD side of a DualDisc on this product may not be recommended.

General

- This receiver has been designed to reproduce CDs/CD Texts, and CD-Rs (Recordable)/CD-RWs (Rewritable) in audio CD (CD-DA), MP3 and WMA format.
- When a disc has been loaded, selecting “CD” for the playback source starts disc play.

Inserting a disc

- When a disc is inserted upside down, “PLEASE” and “EJECT” appear alternately on the display. Press **▲** to eject the disc.
- Do not insert 8 cm discs (single CD) and unusual shape discs (heart, flower, etc.) into the loading slot.

Playing a disc

- While fast-forwarding or reversing on an MP3 or WMA disc, you can only hear intermittent sounds.

To be continued...

Playing a CD-R or CD-RW

- Use only “finalized” CD-Rs or CD-RWs.
- This receiver can play back only the files of the same type which is first detected if a disc includes both audio CD (CD-DA) files and MP3/WMA files.
- This receiver can play back multi-session discs; however, unclosed sessions will be skipped while playing.
- Some CD-Rs or CD-RWs may not play back on this receiver because of their disc characteristics, and for the following causes:
 - Discs are dirty or scratched.
 - Moisture condensation occurs on the lens inside the receiver.
 - The pickup lens inside the receiver is dirty.
 - CD-R/CD-RW on which the files are written with “Packet Write” method.
 - There are improper recording conditions (missing data, etc.) or media conditions (stain, scratch, warp, etc.).
- CD-RWs may require a longer readout time since the reflectance of CD-RWs is lower than that of regular CDs.
- Do not use the following CD-Rs or CD-RWs:
 - Discs with stickers, labels, or protective seal stuck to the surface.
 - Discs on which labels can be directly printed by an ink jet printer.

Using these discs under high temperatures or high humidities may cause malfunctions or damages to discs.

Playing an MP3/WMA disc

- This receiver can play back MP3/WMA files with the extension code <.mp3> or <.wma> (regardless of the letter case—upper/lower).
- This receiver can show the names of albums, artists (performer), and ID3 Tag (Version 1.0, 1.1, 2.2, 2.3, or 2.4) for MP3 files and for WMA files.
- This receiver can display only one-byte characters. No other characters can be correctly displayed.
- This receiver can play back MP3/WMA files meeting the conditions below:
 - Bit rate: 8 kbps — 320 kbps
 - Sampling frequency:
 - 48 kHz, 44.1 kHz, 32 kHz (for MPEG-1)
 - 24 kHz, 22.05 kHz, 16 kHz (for MPEG-2)
 - Disc format: ISO 9660 Level 1/ Level 2, Romeo, Joliet, Windows long file name
- The maximum number of characters for file/ folder names vary among the disc format used (includes 4 extension characters—<.mp3> or <.wma>).
 - ISO 9660 Level 1: up to 12 characters
 - ISO 9660 Level 2: up to 31 characters
 - Romeo*: up to 128 (72) characters
 - Joliet*: up to 64 (36) characters
 - Windows long file name*: up to 128 (72) characters

* *The parenthetic figure is the maximum number of characters for file/folder names in case the total number of files and folders is 313 or more.*

- This receiver can recognize the total of 512 files, of 200 folders, and of 8 hierarchies.
- This receiver can play back the files recorded in VBR (variable bit rate).
The files recorded in VBR have a discrepancy in elapsed time display, and do not show the actual elapsed time. Especially, after performing the search function, this difference becomes noticeable.
- This receiver cannot play back the following files:
 - MP3 files encoded with MP3i and MP3 PRO format.
 - MP3 files encoded in an unappropriated format.
 - MP3 files encoded with Layer 1/2.
 - WMA files encoded with lossless, professional, and voice format.
 - WMA files which are not based upon Windows Media® Audio.
 - WMA files copy-protected with DRM.
 - Files which have the data such as WAVE, ATRAC3, etc.
- The search function works but search speed is not constant.

Changing the source

- If you change the source, playback also stops (without ejecting the disc).
Next time you select “CD” for the playback source, disc play starts from where it has been stopped previously.

Ejecting a disc

- If the ejected disc is not removed within 15 seconds, the disc is automatically inserted again into the loading slot to prevent it from dust. (Disc will not play this time.)

General settings—PSM

- If you change the “AMP GAIN” setting from “HIGH PWR” to “LOW PWR” while the volume level is set higher than “VOL 30,” the receiver automatically changes the volume level to “VOL 30.”

Other main functions

- If you try to assign a title to a 31st disc, “NAMEFULL” flashes on the display. Delete unwanted titles before assignment.
- Titles assigned to discs in the CD changer can also be shown if you playback the disc from the receiver.

DAB tuner operations

- Only primary DAB services can be presetted even when you store a secondary service.
- A previously preset DAB service is erased when a new DAB service is stored in the same preset number.

Troubleshooting

What appears to be trouble is not always serious. Check the following points before calling a service center.

	Symptoms	Causes	Remedies
General	<ul style="list-style-type: none"> • Sound cannot be heard from the speakers. 	The volume level is set to the minimum level.	Adjust it to the optimum level.
		Connections are incorrect.	Check the cords and connections.
FM/AM	<ul style="list-style-type: none"> • The receiver does not work at all. 	The built-in microcomputer may have functioned incorrectly due to noise, etc.	Reset the receiver (see page 2).
	<ul style="list-style-type: none"> • SSM automatic presetting does not work. 	Signals are too weak.	Store stations manually.
Disc playback	<ul style="list-style-type: none"> • Static noise while listening to the radio. 	The aerial is not connected firmly.	Connect the aerial firmly.
	<ul style="list-style-type: none"> • Disc cannot be played back. 	Disc is inserted upside down.	Insert the disc correctly.
		<ul style="list-style-type: none"> • CD-R/CD-RW cannot be played back. • Tracks on the CD-R/CD-RW cannot be skipped. 	CD-R/CD-RW is not finalized.
	<ul style="list-style-type: none"> • Disc can be neither played back nor ejected. 	Disc is locked.	Unlock the disc (see page 17).
		The CD player may have functioned incorrectly.	Eject the disc forcibly (see page 2).
	<ul style="list-style-type: none"> • Disc sound is sometimes interrupted. 	You are driving on rough roads.	Stop playback while driving on rough roads.
		Disc is scratched.	Change the disc.
		Connections are incorrect.	Check the cords and connections.
<ul style="list-style-type: none"> • “NO DISC” appears on the display. 	Disc is inserted incorrectly.	Insert the disc correctly.	

Symptoms	Causes	Remedies
<ul style="list-style-type: none"> Disc cannot be played back. 	No MP3/WMA tracks are recorded on the disc.	Change the disc.
	MP3/WMA tracks do not have the extension code <.mp3> or <.wma> in their file names.	Add the extension code <.mp3> or <.wma> to their file names.
	MP3/WMA tracks are not recorded in the format compliant with ISO 9660 Level 1, Level 2, Romeo, or Joliet.	Change the disc. (Record MP3/WMA tracks using a compliant application.)
<ul style="list-style-type: none"> Noise is generated. 	The track played back is not an MP3/WMA file (although it has the extension code <.mp3> or <.wma>).	Skip to another track or change the disc. (Do not add the extension code <.mp3> or <.wma> to non-MP3 or WMA tracks.)
<ul style="list-style-type: none"> A longer readout time is required (“CHECK” keeps flashing on the display). 	Readout time varies due to the complexity of the folder/file configuration.	Do not use too many hierarchies and folders.
<ul style="list-style-type: none"> Tracks cannot be played back as you have intended them to play. 	Playback order is determined when the files are recorded.	_____
<ul style="list-style-type: none"> Elapsed playing time is not correct. 	This sometimes occurs during play. This is caused by how the tracks are recorded on the disc.	_____
<ul style="list-style-type: none"> “NO FILES” appears on the display. 	The current disc does not contain any MP3/WMA tracks.	Insert a disc that contains MP3/WMA tracks.
<ul style="list-style-type: none"> Correct characters are not displayed (e.g. album name). 	This receiver can display Roman alphabets (A – Z), Cyrillic alphabets, numbers, and a limited number of symbols (see page 25).	_____

MP3/WMA playback

To be continued...

	Symptoms	Causes	Remedies
CD changer	<ul style="list-style-type: none"> • “NO DISC” appears on the display. 	No disc is in the magazine.	Insert disc into the magazine.
		Disc is inserted upside down.	Insert disc correctly.
	<ul style="list-style-type: none"> • “NO MAG” appears on the display. 	No magazine is loaded in the CD changer.	Insert the magazine.
	<ul style="list-style-type: none"> • “RESET 8” appears on the display. 	This receiver is not connected to the CD changer correctly.	Connect this receiver and the CD changer correctly and press the reset button of the CD changer.
	<ul style="list-style-type: none"> • “RESET 1” – “RESET 7” appears on the display. 	_____	Press the reset button of the CD changer.
<ul style="list-style-type: none"> • The CD changer does not work at all. 	The built-in microcomputer may function incorrectly due to noise, etc.	Reset the receiver (see page 2).	

Specifications

AUDIO AMPLIFIER SECTION

Maximum Power Output:

Front: 50 W per channel

Rear: 50 W per channel

Continuous Power Output (RMS):

Front: 19 W per channel into 4 Ω , 40 Hz to 20 000 Hz at no more than 0.8% total harmonic distortion.

Rear: 19 W per channel into 4 Ω , 40 Hz to 20 000 Hz at no more than 0.8% total harmonic distortion.

Load Impedance: 4 Ω (4 Ω to 8 Ω allowance)

Tone Control Range:

Bass: ± 10 dB at 100 Hz

Treble: ± 10 dB at 10 kHz

Frequency Response: 40 Hz to 20 000 Hz

Signal-to-Noise Ratio: 70 dB

Line-Out Level/Impedance:

2.5 V/20 k Ω load (full scale)

Output Impedance: 1 k Ω

Subwoofer-Out Level/Impedance:

2.0 V/20 k Ω load (full scale)

Other Terminal: CD changer

TUNER SECTION

Frequency Range:

FM1/FM2: 87.5 MHz to 108.0 MHz

FM3: 65.00 MHz to 74.00 MHz

AM: (MW) 522 kHz to 1 620 kHz
(LW) 144 kHz to 279 kHz

[FM Tuner]

Usable Sensitivity: 11.3 dBf (1.0 μ V/75 Ω)

50 dB Quieting Sensitivity:

16.3 dBf (1.8 μ V/75 Ω)

Alternate Channel Selectivity (400 kHz): 65 dB

Frequency Response: 40 Hz to 15 000 Hz

Stereo Separation: 35 dB

Capture Ratio: 1.5 dB

[MW Tuner]

Sensitivity: 20 μ V

Selectivity: 35 dB

[LW Tuner]

Sensitivity: 50 μ V

CD PLAYER SECTION

Type: Compact disc player

Signal Detection System: Non-contact optical pickup (semiconductor laser)

Number of Channels: 2 channels (stereo)

Frequency Response: 5 Hz to 20 000 Hz

Dynamic Range: 96 dB

Signal-to-Noise Ratio: 98 dB

Wow and Flutter: Less than measurable limit

MP3 Decoding Format:

MPEG1/2 Audio Layer 3

Max. Bit Rate: 320 kbps

WMA (Windows Media® Audio) Decoding

Format:

Max. Bit Rate: 192 kbps

GENERAL

Power Requirement:

Operating Voltage:

DC 14.4 V (11 V to 16 V allowance)

Grounding System: Negative ground

Allowable Operating Temperature:

0°C to +40°C

Dimensions (W \times H \times D):

Installation Size (approx.):

182 mm \times 52 mm \times 150 mm

Panel Size (approx.):

188 mm \times 58 mm \times 11 mm

Mass (approx.):

1.5 kg (excluding accessories)

Design and specifications are subject to change without notice.

- Microsoft and Windows Media are either registered trademarks or trademarks of Microsoft Corporation in the United States and/or other countries.



Having TROUBLE with operation?

Please reset your unit

Refer to page of How to reset your unit

Затруднения при эксплуатации?

Пожалуйста, перезагрузите Ваше устройство

Для получения информации о перезагрузке Вашего устройства обратитесь на соответствующую страницу

JVC



EN, RU

© 2005 Victor Company of Japan, Limited

0105DTSMDTJEIN

ENGLISH

This receiver is designed to operate on **12 V DC, NEGATIVE ground electrical systems**. If your vehicle does not have this system, a voltage inverter is required, which can be purchased at JVC IN-CAR ENTERTAINMENT dealers.

Parts list for installation and connection

The following parts are provided for this receiver. After checking them, please set them correctly.

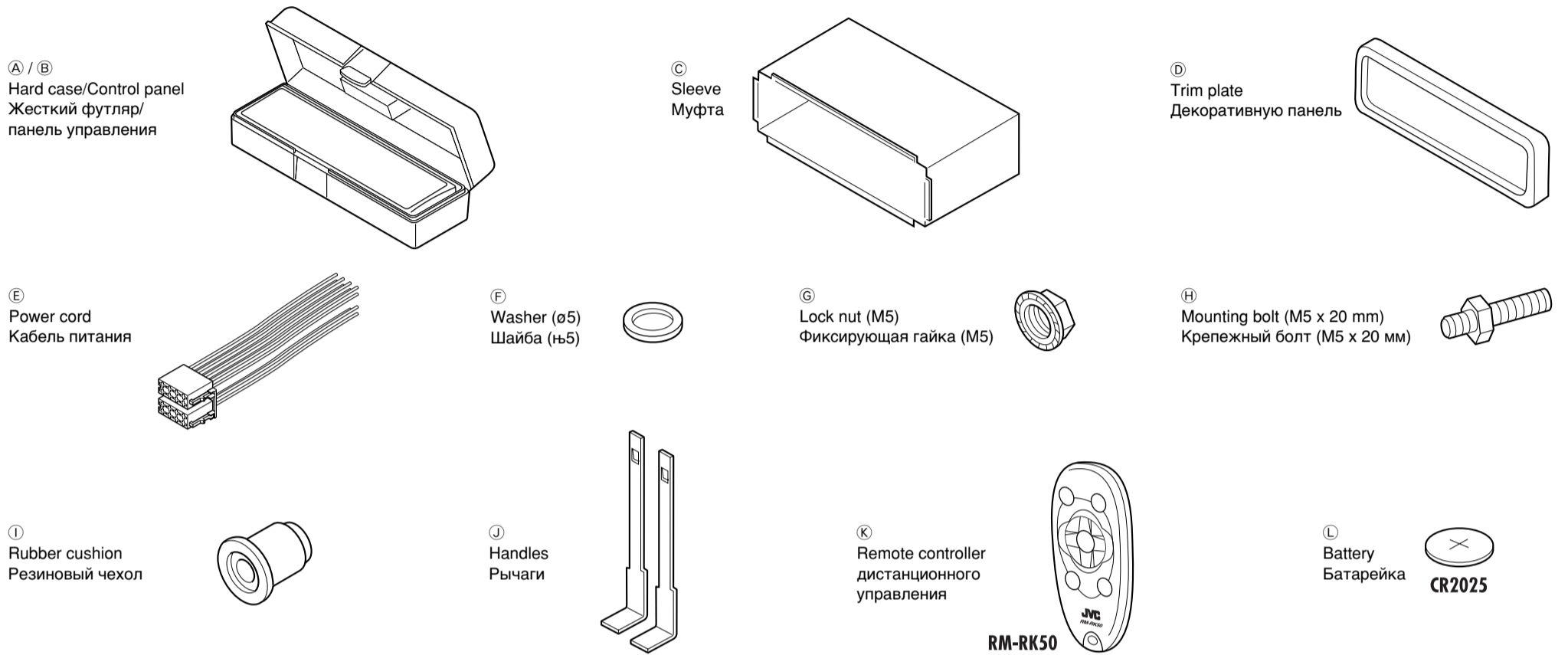

РУССКИЙ

Это устройство разработано для эксплуатации на **12 В постоянного напряжения с минусом на массе**. Если Ваш автомобиль не имеет этой системы, требуется инвертор напряжения, который может быть приобретен у дилера автомобильного специалиста JVC.

Список деталей для установки и подключения

Следующие детали поставлены в комплекте с устройством. После проверки комплектации, пожалуйста, установите их правильно.

INSTALLATION (IN-DASH MOUNTING)

The following illustration shows a typical installation. If you have any questions or require information regarding installation kits, consult your JVC IN-CAR ENTERTAINMENT dealer or a company supplying kits.

- If you are not sure how to install this receiver correctly, have it installed by a qualified technician.

УСТАНОВКА (УСТАНОВКА В ПРИБОРНУЮ ПАНЕЛЬ)

На следующих иллюстрациях показана типовая установка. Если у Вас есть какие-либо вопросы, касающиеся установки, обратитесь к Вашему дилеру автомобильного специалиста JVC или в компанию, поставляющую соответствующие принадлежности.

- Если Вы не знаете точно, как следует устанавливать это устройство, обратитесь к квалифицированному специалисту.

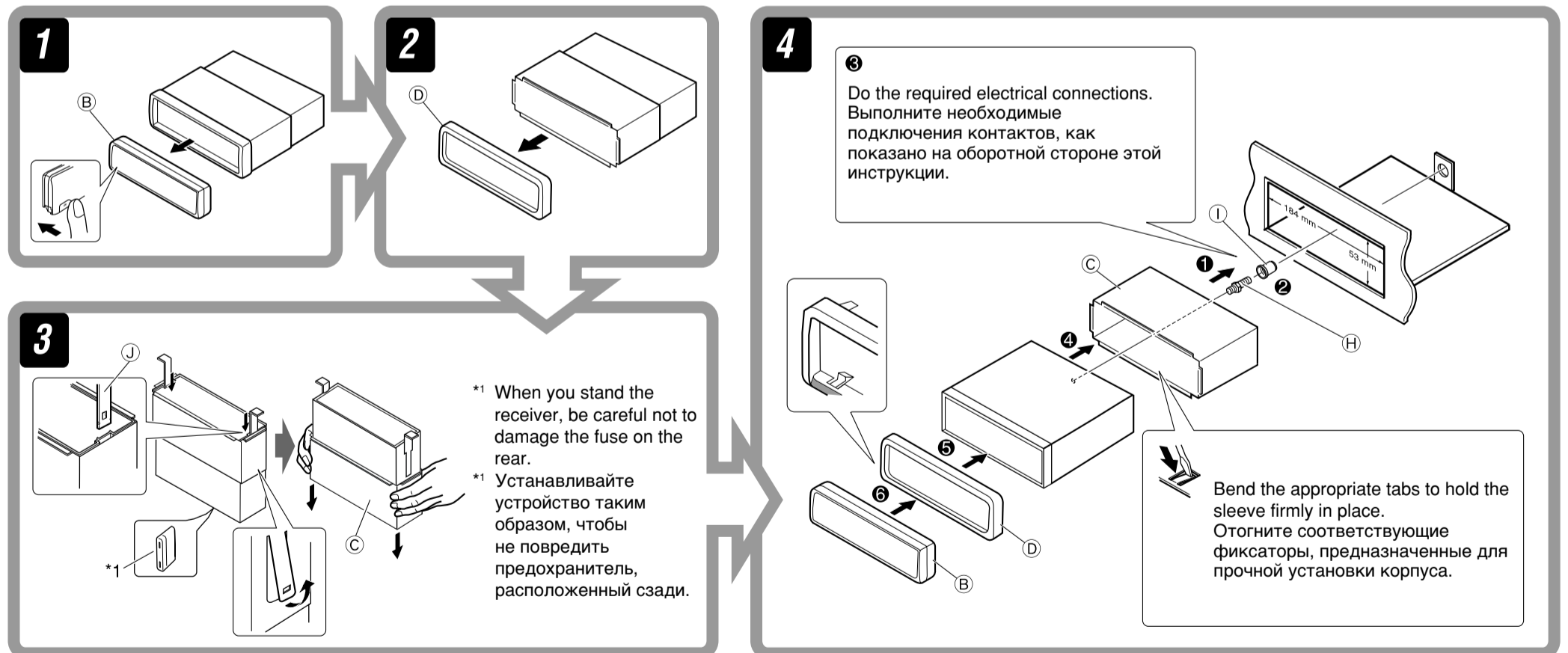

Removing the receiver

Before removing the receiver, release the rear section.

Удаление устройства

Перед удалением устройства освободите заднюю часть.

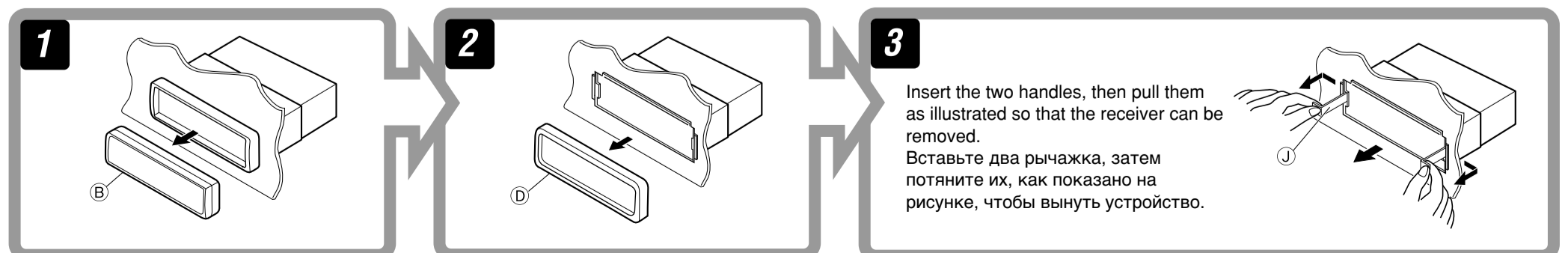

When using the optional stay / При использовании дополнительной стойки

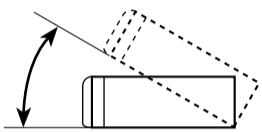
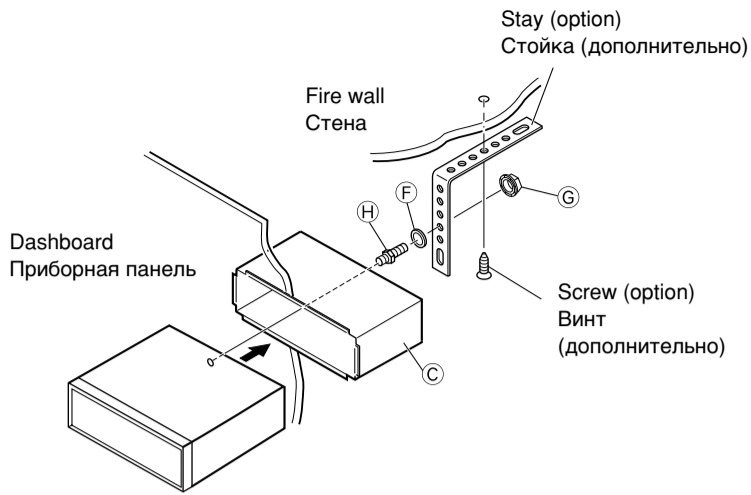

Install the receiver at an angle of less than 30°.
Установите устройство под углом менее 30°.

When installing the receiver without using the sleeve / При установке устройства без использования муфты

In a Toyota for example, first remove the car radio and install the receiver in its place.
В автомобилях "Toyota", например, сначала удалите автомобильную магнитолу, затем установите на ее место это устройство.

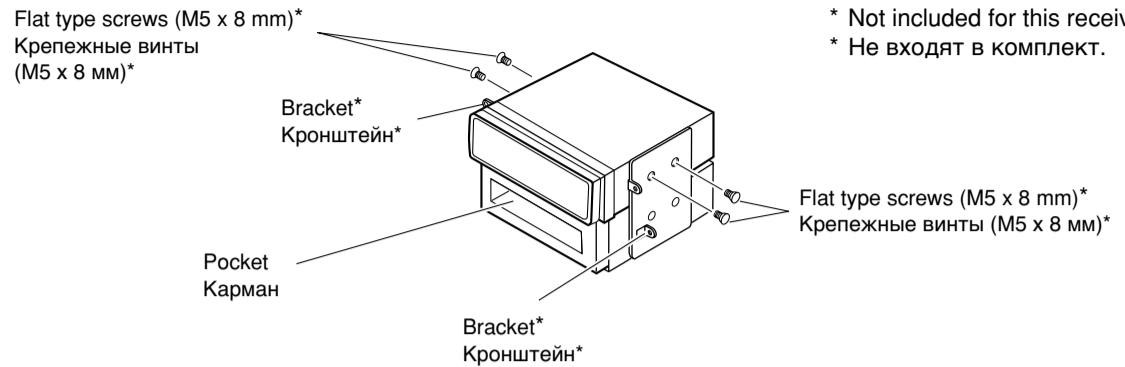

* Not included for this receiver.
* Не входят в комплект.

Note : When installing the receiver on the mounting bracket, make sure to use the 8 mm-long screws. If longer screws are used, they could damage the receiver.
Примечание : При установке устройства на крепежный кронштейн, используйте только винты длиной 8 мм. При использовании более длинных винтов можно повредить устройство.

ELECTRICAL CONNECTIONS

To prevent short circuits, we recommend that you disconnect the battery's negative terminal and make all electrical connections before installing the receiver.

• **Be sure to ground this receiver to the car's chassis again after installation.**

Notes:

- Replace the fuse with one of the specified rating. If the fuse blows frequently, consult your JVC IN-CAR ENTERTAINMENT dealer.
- It is recommended to connect to the speakers with maximum power of more than 50 W (both at the rear and at the front, with an impedance of **4 Ω to 8 Ω**). If the maximum power is less than 50 W, change "AMP GAIN" setting to prevent the speakers from being damaged (see page 24 of the INSTRUCTIONS).
- To prevent short-circuit, cover the terminals of the UNUSED leads with insulating tape.
- The heat sink becomes very hot after use. Be careful not to touch it when removing this receiver.

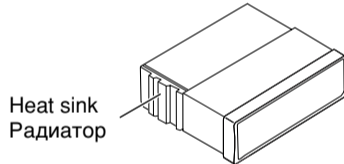

ЭЛЕКТРИЧЕСКИЕ ПОДКЛЮЧЕНИЯ

Для предотвращения коротких замыканий мы рекомендуем Вам отсоединить отрицательный разъем аккумулятора и осуществить все подключения перед установкой устройства.

• **После установки обязательно заземлите данное устройство на шасси автомобиля.**

Примечания:

- Заменяйте предохранитель другим предохранителем указанного класса. Если предохранитель сгорает слишком часто, обратитесь к дилеру автомобильного специалиста JVC.
- Рекомендуется подключать динамики с максимальной мощностью более 50 Вт (к задней и передней панели устройства, с полным сопротивлением от **4 Ω до 8 Ω**). Если максимальная мощность динамиков менее 50 Вт, перейдите в режим "AMP GAIN", чтобы предотвратить их повреждение (см. стр. 24 ИНСТРУКЦИЙ).
- Для предотвращения короткого замыкания заклейте НЕИСПОЛЬЗУЕМЫЕ концы изолирующей лентой.
- Радиатор во время использования сильно нагревается. Старайтесь его не трогать во время удаления устройства.

PRECAUTIONS on power supply and speaker connections:

- **DO NOT connect the speaker leads of the power cord to the car battery; otherwise, the receiver will be seriously damaged.**
- BEFORE connecting the speaker leads of the power cord to the speakers, check the speaker wiring in your car.

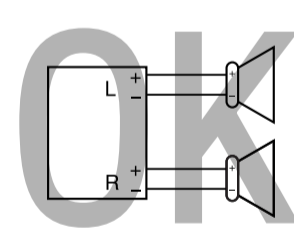
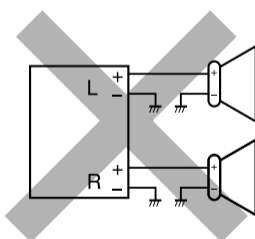
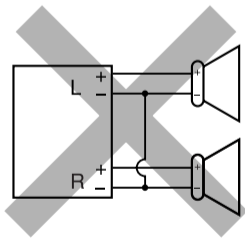

ПРЕДОСТЕРЕЖЕНИЯ по питанию и подключению громкоговорителей:

- **НЕ подключайте провода громкоговорителей к аккумулятору автомобиля, иначе устройство будет повреждено.**
- ПЕРЕД подключением проводов громкоговорителей к кабелю питания громкоговорителя проверьте схему соединений громкоговорителей в Вашем автомобиле.

TROUBLESHOOTING

- **The fuse blows.**
* Are the red and black leads connected correctly?
- **Power cannot be turned on.**
* Is the yellow lead connected?
- **No sound from the speakers.**
* Is the speaker output lead short-circuited?
- **Sound is distorted.**
* Is the speaker output lead grounded?
* Are the "-" terminals of L and R speakers grounded in common?
- **Noise interfere with sounds.**
* Is the rear ground terminal connected to the car's chassis using shorter and thicker cords?
- **Receiver becomes hot.**
* Is the speaker output lead grounded?
* Are the "-" terminals of L and R speakers grounded in common?
- **This receiver does not work at all.**
* Have you reset your receiver?

ВЫЯВЛЕНИЕ НЕИСПРАВНОСТЕЙ

- **Сработал предохранитель.**
* Правильно ли подключены черный и красный провода?
- **Питание не включается.**
* Подключен ли желтый провод?
- **Звук не выводится через громкоговорители.**
* Нет ли короткого замыкания на кабеле выхода громкоговорителей?
- **Звук искажен.**
* Заземлен ли провод выхода громкоговорителей?
* Заземлены ли разъемы "-" правого (R) и левого (L) громкоговорителей?
- **Шум мешает звучанию.**
* Соединен ли находящийся сзади зажим заземления с шасси автомобиля с помощью более короткого и тонкого шнуров?
- **Устройство нагревается.**
* Заземлен ли провод выхода громкоговорителей?
* Заземлены ли разъемы "-" правого (R) и левого (L) громкоговорителей?
- **Приемник не работает.**
* Выполнена ли перенастройка приемника?

A Typical Connections / Типичные подключения

Before connecting: Check the wiring in the vehicle carefully. Incorrect connection may cause serious damage to this receiver.

The leads of the power cord and those of the connector from the car body may be different in color.

- 1 Connect the colored leads of the power cord in the order specified in the illustration below.
- 2 Connect the aerial cord.
- 3 Finally connect the wiring harness to the receiver.

Note: If your vehicle does not have any accessory terminal, move the fuse from the fuse position 1 (initial position) to fuse position 2, and connect the red lead (A7) to the positive (+) battery terminal.

- The yellow lead (A4) is not used in this case.

Перед началом подключений: Тщательно проверьте проводку в автомобиле. Неправильное подключение может привести к серьезному повреждению устройства. Жилы силового кабеля и жилы соединителя от кузова автомобиля могут быть разного цвета.

- 1 Подсоедините цветные провода шнура питания в указанном ниже порядке.
- 2 Подключите кабель антенны.
- 3 В последнюю очередь подключите электропроводку к устройству.

Примечание: Если в Вашем автомобиле никакого вспомогательного разъема не имеется, переставьте предохранитель из положения 1 предохранителя (первоначальное положение) в положение 2 предохранителя и подключите красный провод (A7) к положительному (+) полюсу аккумулятора.

- Желтый провод (A4) в этом случае не используется.

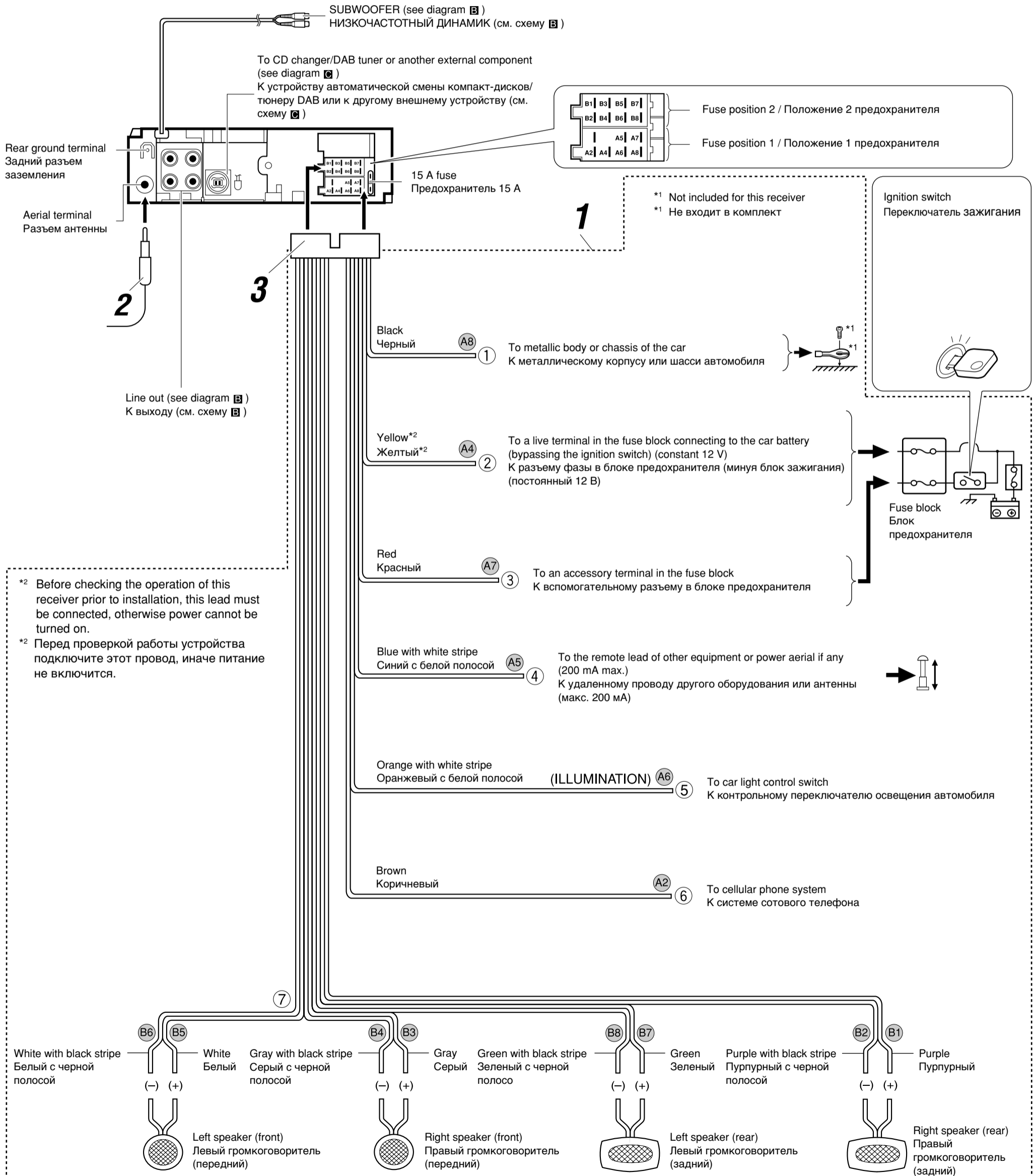

B Connecting the external amplifiers / Подключение внешних усилителей

You can connect amplifiers to upgrade your car stereo system.

- Connect the remote lead (blue with white stripe) to the remote lead of the other equipment so that it can be controlled through this receiver.
- **Disconnect the speakers from this receiver, connect them to the amplifier. Leave the speaker leads of this receiver unused.**

Можно подключить усилители для обновления автомобильной стереосистемы.

- Подсоедините провод внешнего устройства (синий с белой полосой) к проводу внешнего устройства другого оборудования так, чтобы им можно было управлять с этого устройства.
- **Отсоедините громкоговорители от данного устройства, подключите их к усилителю. Оставьте провода громкоговорителей данного устройства неиспользованными.**

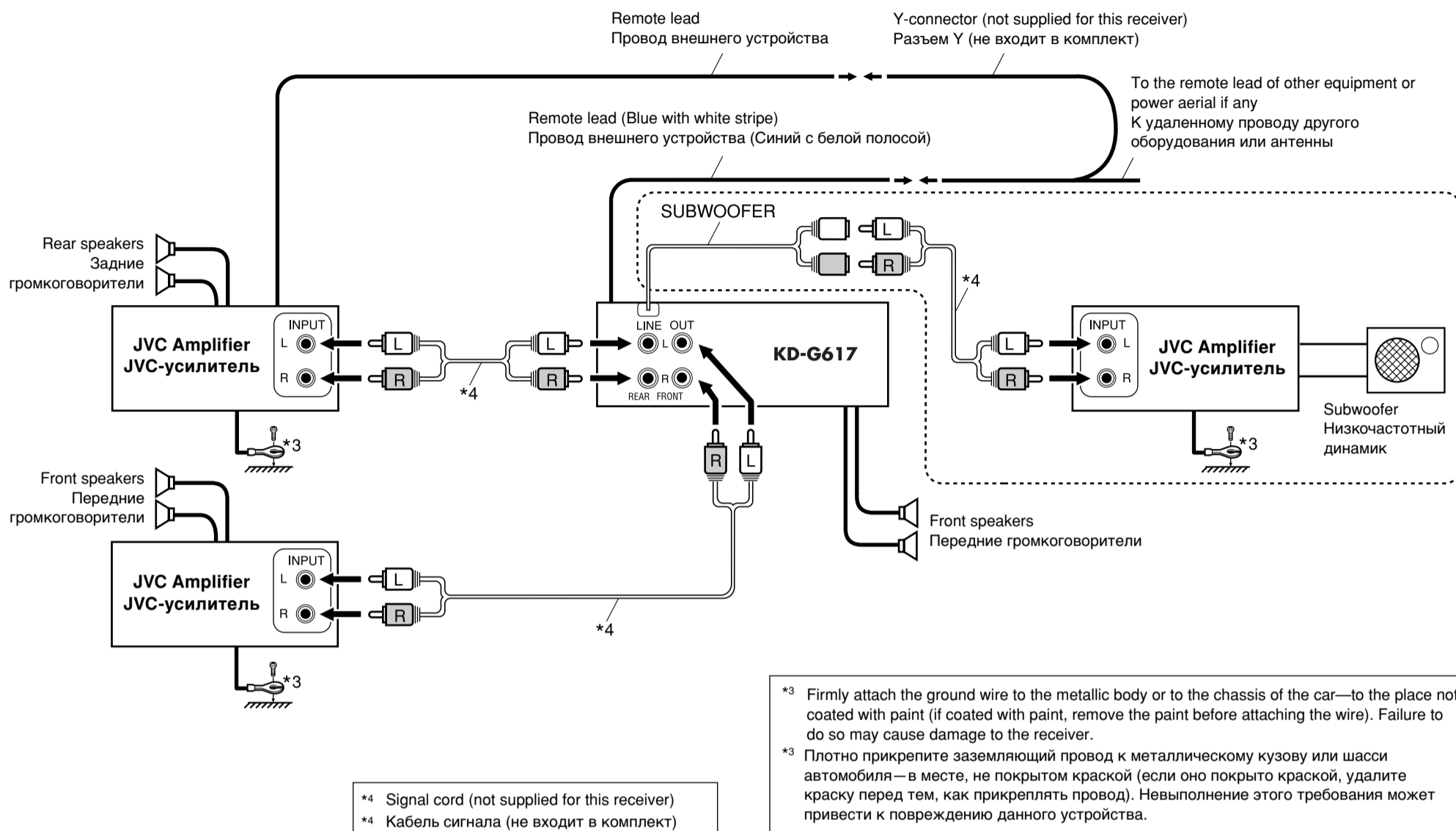

C Connecting the external components / Подключение внешних устройств

CD changer and DAB tuner / Проигрыватель нескольких компакт-дисков и тюнер DAB

- Refer also to pages 15 and 28 of the INSTRUCTIONS.
- Также см. ИНСТРУКЦИИ на стр. 15 и 28.
- You can connect both components in series as illustrated below.
- Внешние устройства можно подключать параллельно, как показано на рисунке.

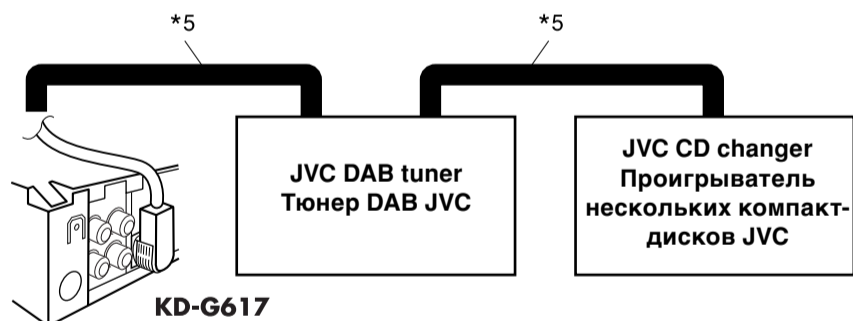

CAUTION / ПРЕДОСТЕРЕЖЕНИЕ:

- Before connecting the CD changer and/or DAB tuner, make sure that the receiver is turned off.
- Перед подключением устройства автоматической смены компакт-дисков и/или тюнера DAB убедитесь в том, что приемник отключен.

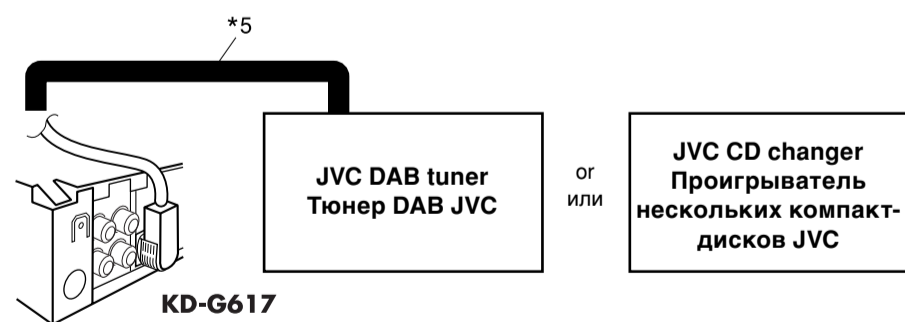

- *5 Connecting cord supplied for your CD changer or DAB tuner
*5 Подключение кабеля, входящего в комплект поставки устройства автоматической смены компакт-дисков или тюнера DAB

External Component / Внешнее устройство

- Set "EXT IN" for the external input setting (see page 24 of the INSTRUCTIONS). / Установите для внешнего входа значение "EXT IN" (см. стр. 24 ИНСТРУКЦИЙ).

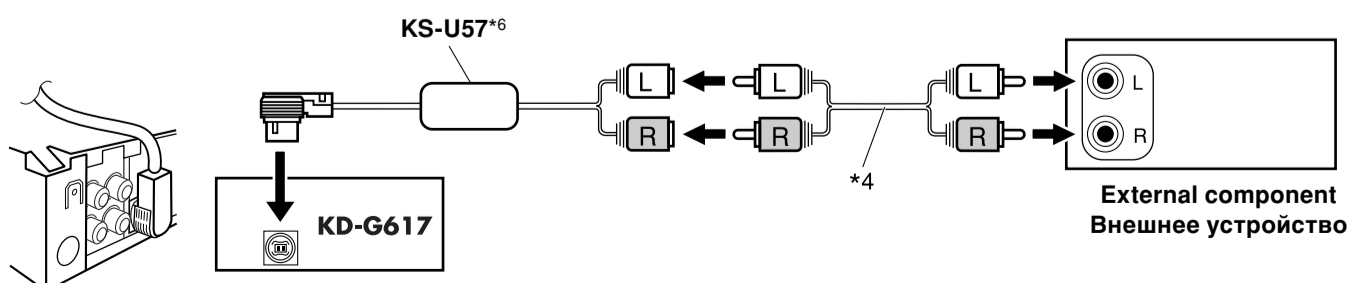

- *6 Line Input Adapter KS-U57 (not supplied for this receiver)
*6 Коммуникационный адаптер KS-U57 (не входит в комплект поставки)

Free Manuals Download Website

<http://myh66.com>

<http://usermanuals.us>

<http://www.somanuals.com>

<http://www.4manuals.cc>

<http://www.manual-lib.com>

<http://www.404manual.com>

<http://www.luxmanual.com>

<http://aubethermostatmanual.com>

Golf course search by state

<http://golfingnear.com>

Email search by domain

<http://emailbydomain.com>

Auto manuals search

<http://auto.somanuals.com>

TV manuals search

<http://tv.somanuals.com>