

JVC



ENGLISH

FRANÇAIS

CD RECEIVER RECEPTEUR CD

KD-S1501/KD-G152/KD-G151

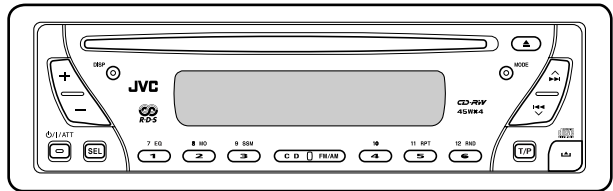
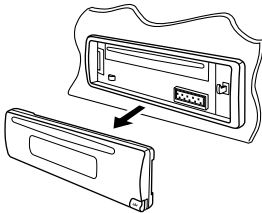

CD-RW

COMPACT
disc
DIGITAL AUDIO



For canceling the display demonstration, see page 7.
Pour annuler la démonstration des affichages, référez-vous à la page 7.

For installation and connections, refer to the separate manual.
Pour l'installation et les raccordements, se référer au manuel séparé.

INSTRUCTIONS MANUEL D'INSTRUCTIONS

GET0287-003A
[EX/EU]

Thank you for purchasing a JVC product.

Please read all instructions carefully before operation, to ensure your complete understanding and to obtain the best possible performance from the unit.

IMPORTANT FOR LASER PRODUCTS

1. CLASS 1 LASER PRODUCT
2. **CAUTION:** Do not open the top cover. There are no user serviceable parts inside the unit; leave all servicing to qualified service personnel.
3. **CAUTION:** Visible and invisible laser radiation when open and interlock failed or defeated. Avoid direct exposure to beam.
4. REPRODUCTION OF LABEL: CAUTION LABEL, PLACED OUTSIDE THE UNIT.

CAUTION: Visible and invisible laser radiation when open and interlock failed or defeated. AVOID DIRECT EXPOSURE TO BEAM. (e)	ADVARSEL: Synlig og usynlig laserstråling når maskinen er åpen eller interlocken fejler. Undgå direkte eksponering til strålingen. (d)	WARNING: Synlig och osynlig laserstråling när den öppnas och spärren är urkopplad. Beträkta ej strålen. (s)	VARO: Avdrätsa ja suojalukitus ohjellutuna tai viallisena olet alueille näkyväille ja näkymättömille laserstråleille. Vältä silmien kohdistamista suoraan lähteeseen. (f)
--	---	--	--

Warning:

If you need to operate the receiver while driving, be sure to look ahead carefully or you may be involved in a traffic accident.

How to reset your unit



- This will reset the microcomputer. Your preset adjustments will also be erased.
- If a disc is loaded, it will eject. Be careful not to drop the disc.

How to forcibly eject a disc

If a disc cannot be recognized by the receiver or cannot be ejected, ejects the disc as follows.

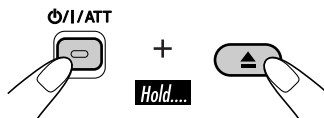

- If this does not work, try to reset your receiver.
- Be careful not to drop the disc when it ejects.

Note: Only for [EX] model users in UK and European countries

For security reasons, a numbered ID card is provided with this receiver, and the same ID number is imprinted on the receiver's chassis. Keep the card in a safe place, as it will help the authorities to identify your receiver if stolen.

Contents

How to reset your unit	2	Disc operations	13
How to forcibly eject a disc	2	Playing a disc	13
How to read this manual	4	Selecting the playback modes.....	14
How to use the MODE button	4	Sound adjustments	15
Control panel — KD-S1501/ KD-G152/KD-G151	5	Selecting preset sound modes	
Parts identification	5	(C-EQ: custom equalizer)	15
Getting started.....	6	Adjusting the sound	16
Basic operations	6	General settings — PSM	17
Canceling the display demonstrations ...	7	Basic procedure	17
Setting the clock	7	Detaching the control panel	19
Radio operations	8	Maintenance	20
Listening to the radio.....	8	More about this receiver	21
Storing stations in memory	9	Troubleshooting	22
Listening to a preset station	9	Specifications	23
FM RDS operations	10		
Searching for your favorite FM RDS programme	10		
Storing your favorite programmes.....	11		
Using the standby receptions	11		
Tracking the same programme —Network-Tracking Reception	12		

*For safety....

- Do not raise the volume level too much, as this will block outside sounds, making driving dangerous.
- Stop the car before performing any complicated operations.



*Temperature inside the car....

If you have parked the car for a long time in hot or cold weather, wait until the temperature in the car becomes normal before operating the unit.

How to read this manual

The following methods are used to make the explanations simple and easy-to-understand:

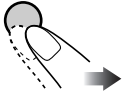
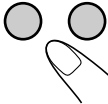
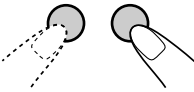
- Some related tips and notes are explained in “More about this receiver” (see page 21).
- Button operations are mainly explained with the illustrations as follows:

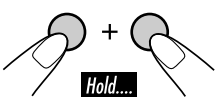
	Press briefly.
	Press repeatedly.
	Press either one.
	Press either one.
	Press and hold until your desired response begins.
	Press and hold both buttons at the same time.

How to use the MODE button

If you press MODE, the receiver goes into functions mode, then the number buttons work as different function buttons.

Ex.: When number button 2 works as MO (monaural) button.

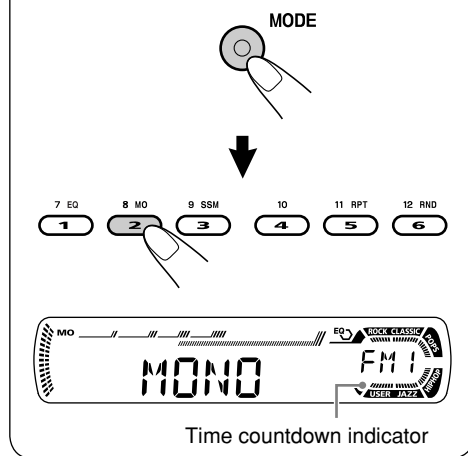

To use these buttons for original functions again after pressing MODE, wait for 5 seconds without pressing any of these buttons until the functions mode is cleared.

- Pressing MODE again also clears the functions mode.

Parts identification

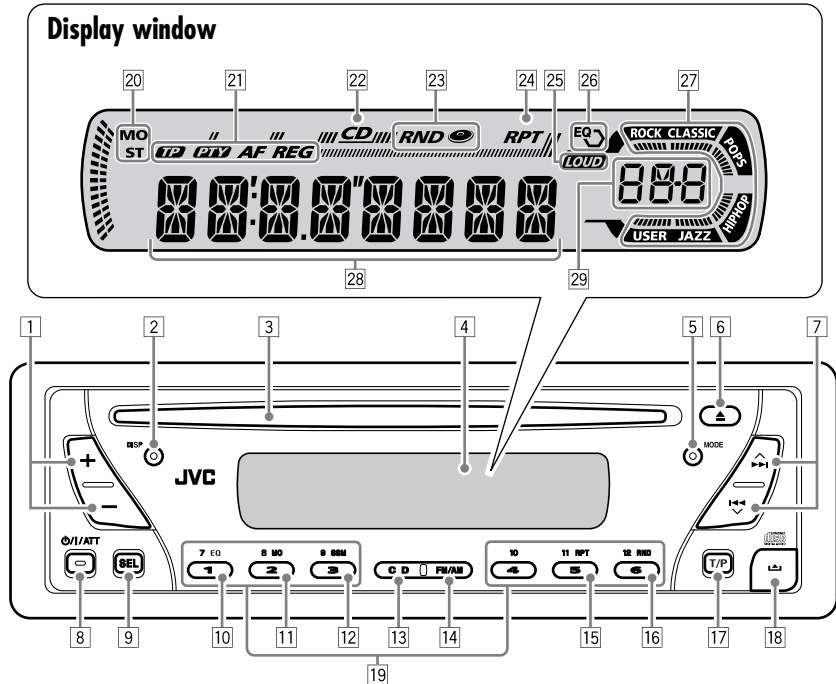

- 1 +/- buttons
- 2 DISP (display) button
- 3 Loading slot
- 4 Display window
- 5 MODE button
- 6 ▲ (eject) button
- 7 ▲▶▶/◀◀▼ buttons
- 8 O/I/ATT (standby/on/attenuator) button
- 9 SEL (select) button
- 10 EQ (equalizer) button
- 11 MO (monaural) button
- 12 SSM (Strong-station Sequential Memory) button
- 13 CD button
- 14 FM/AM button
- 15 RPT (repeat) button
- 16 RND (random) button
- 17 T/P (traffic programme/programme type) button
- 18 📵 (control panel release) button
- 19 Number buttons

Display window

- 20 Tuner reception indicators
MO (monaural), ST (stereo)
- 21 RDS indicators
TP, PTY, AF, REG
- 22 CD indicator
- 23 RND (disc random) indicator
- 24 RPT (repeat) indicator
- 25 LOUD (loudness) indicator
- 26 EQ (equalizer) indicator
- 27 Sound mode (C-EQ: custom equalizer) indicators
ROCK, CLASSIC, POPS, HIP HOP, JAZZ, USER
- also works as the time countdown indicator.
- 28 Main display
- 29 Source display
Volume level indicator

Basic operations

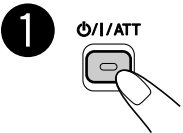
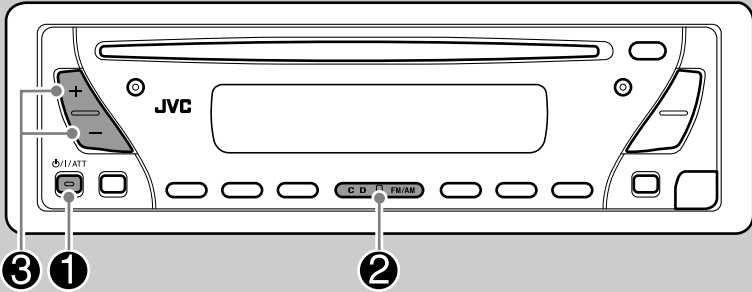

To drop the volume in a moment (ATT)



To restore the sound, press it again.

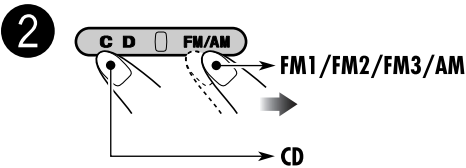

To turn off the power

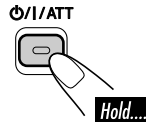

You cannot select "CD" as the playback source if there is no disc in the loading slot.

Caution on volume setting:

Discs produce very little noise compared with other sources. Lower the volume before playing a disc to avoid damaging the speakers by the sudden increase of the output level.

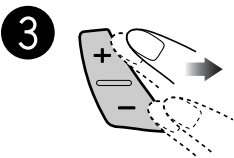

Volume level appears.

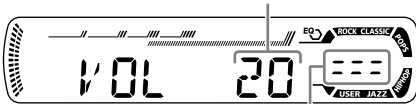

Volume level indicator

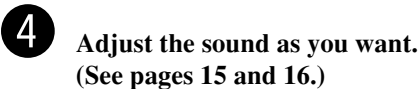

Canceling the display demonstrations

If no operations are done for about 20 seconds, display demonstration starts.

[Initial: DEMO ON]—see page 17.

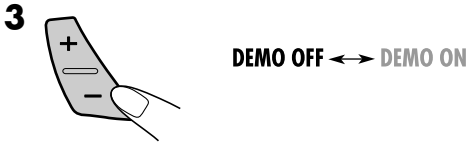
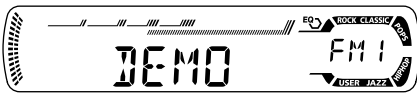
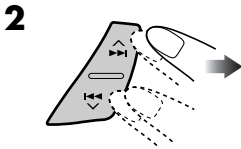

4 Finish the procedure.



To activate the display demonstration

In step **3** above...



Setting the clock



2 Set the hour, minute, and clock system.

- 1** Select “CLOCK H” (hour), then adjust the hour.
- 2** Select “CLOCK M” (minute), then adjust the minute.
- 3** Select “24H/12H,” then select “24H” (hour) or “12H” (hour).

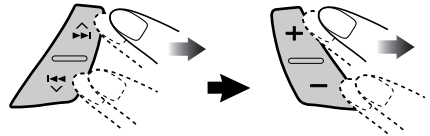

3 Finish the procedure.



To check the current clock time when the power is turned off



Radio operations

Listening to the radio

ENGLISH

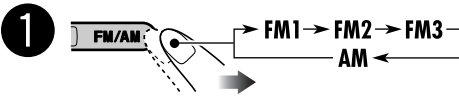
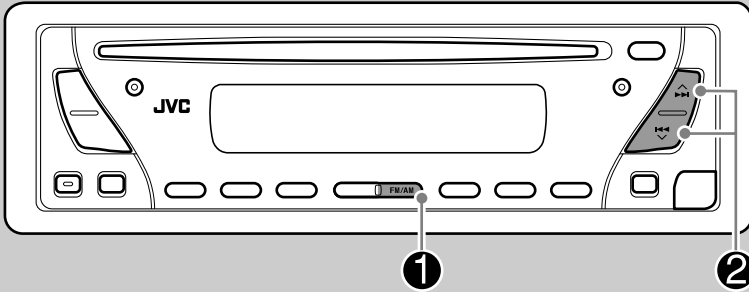

Lights up when receiving an FM stereo broadcast with sufficient signal strength.

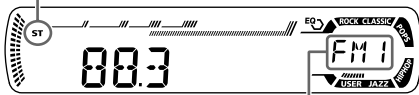

Selected band appears.

2 Start searching for a station.

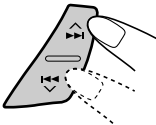

When a station is received, searching stops.

To stop searching, press the same button again.

To tune in to a station manually

In step 2 above...

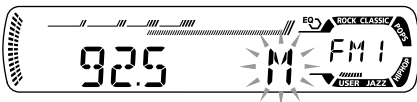
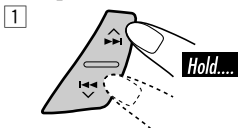

2 Select the desired station frequencies.

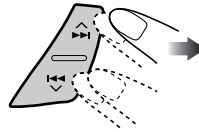

When an FM stereo broadcast is hard to receive

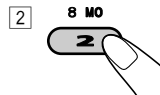
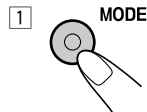

Lights up when monaural mode is activated.

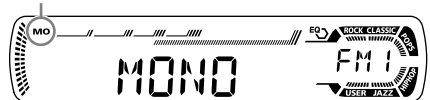

Reception improves, but stereo effect will be lost.

To restore the stereo effect, repeat the same procedure. "MONO OFF" appears and the MO indicator goes off.

Storing stations in memory

You can preset six stations for each band.

FM station automatic presetting—SSM (Strong-station Sequential Memory)

- 1 Select the FM band (FM1 – FM3) you want to store into.

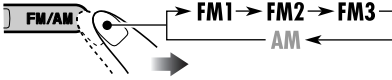

- 2 Press the MODE button.

- 3 Press and hold the 3 button.



“SSM” flashes, then disappears when automatic presetting is over.

Local FM stations with the strongest signals are searched and stored automatically in the FM band.

Manual presetting

Ex.: Storing FM station of 92.5 MHz into the preset number 4 of the FM1 band.

- 1 Select the FM band (FM1 – FM3) you want to store into.

- 2 Press the right arrow button.



- 3 Press and hold the 4 button.

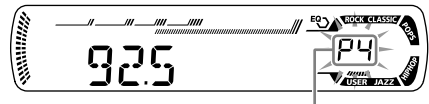

Preset number flashes for a while.

Listening to a preset station

- 1 Select the FM band (FM1 – FM3) you want to listen to.

- 2 Select the preset station (1 – 6) you want.

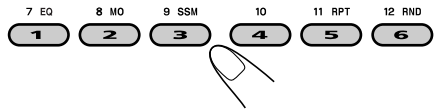

To check the current clock time while listening to an FM (non-RDS) or AM station

- For FM RDS stations, see page 12.

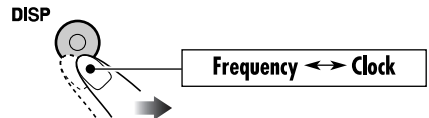

FM RDS operations

Searching for your favorite FM RDS programme

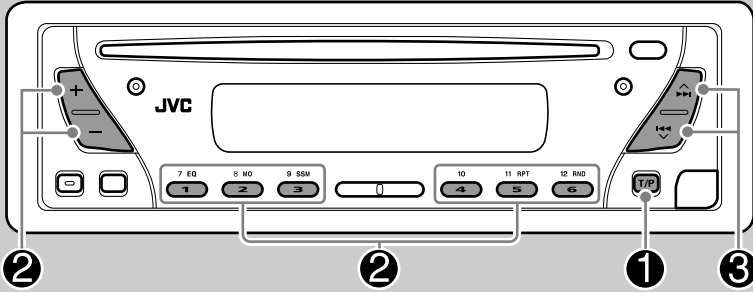

You can tune in to a station broadcasting your favorite programme by searching for a PTY code.

3 Start searching for your favorite programme.

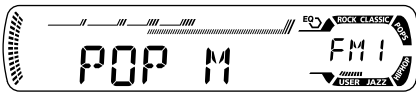
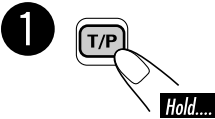

The last selected PTY code appears.

2 Select one of your favorite programme type.

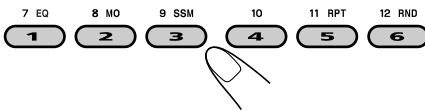

or

Select one of the twenty-nine PTY codes.

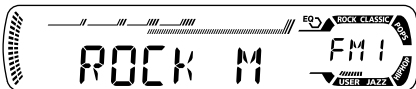
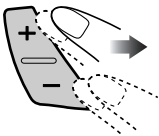

Ex.: When "ROCK M" is selected

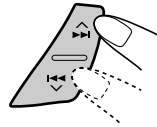

If there is a station broadcasting a programme of the same PTY code as you have selected, that station is tuned in.

PTY codes

NEWS, AFFAIRS, INFO, SPORT, EDUCATE, DRAMA, CULTURE, SCIENCE, VARIED, POP M (music), ROCK M (music), EASY M (music), LIGHT M (music), CLASSICS, OTHER M (music), WEATHER, FINANCE, CHILDREN, SOCIAL, RELIGION, PHONE IN, TRAVEL, LEISURE, JAZZ, COUNTRY, NATION M (music), OLDIES, FOLK M (music), DOCUMENT

What you can do with RDS

RDS (Radio Data System) allows FM stations to send an additional signal along with their regular programme signals. By receiving the RDS data, this receiver can do the following:

- Programme Type (PTY) Search (see page 10)
- Standby Reception of Traffic Announcement —TA (see the following) or your favorite programme (PTY) (see pages 12 and 18)
- Tracing the same programme automatically —Network-Tracking Reception (see page 12)
- Programme Search (see page 18)

Storing your favorite programmes

You can store six favorite programme types.

Preset programme types in the number buttons (1 – 6):

1	2	3	4	5	6
POP M	ROCK M	EASY M	CLASSICS	AFFAIRS	VARIED

- 1 Perform steps 1 and 2 on page 10 to select a PTY code.
- 2 Select the preset number (1 – 6) you want to store into.

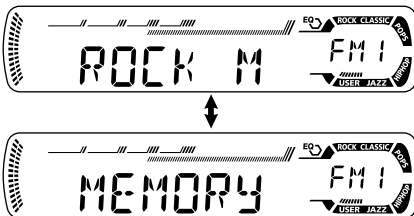
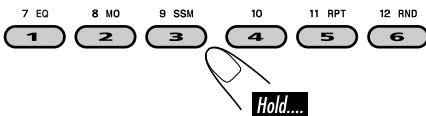

Ex.: When "ROCK M" is selected

- 3 Repeat steps 1 and 2 to store other PTY codes into other preset numbers.

- 4 Finish the procedure.

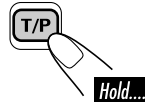

Using the standby receptions

TA Standby Reception

TA Standby Reception allows the receiver to switch temporarily to Traffic Announcement (TA) from any source other than AM. The volume changes to the preset TA volume level (see page 18).

To activate TA Standby Reception



The TP indicator either lights up or flashes.

- If the TP indicator lights up, TA Standby Reception is activated.
- If the TP indicator flashes, TA Standby Reception is not yet activated. (This occurs when you are listening to an FM station without the RDS signals required for TA Standby Reception.)

To activate TA Standby Reception, tune in to another station providing these signals. The TP indicator will stop flashing and remain lit.

To deactivate the TA Standby Reception



The TP indicator goes off.

PTY Standby Reception

PTY Standby Reception allows the receiver to switch temporarily to your favorite PTY programme from any source other than AM.

To activate and select your favorite PTY code for PTY Standby Reception, see page 18.

The PTY indicator either lights up or flashes.

- If the PTY indicator lights up, PTY Standby Reception is activated.
- If the PTY indicator flashes, PTY Standby Reception is not yet activated.

To activate PTY Standby Reception, tune in to another station providing these signals. The PTY indicator will stop flashing and remain lit.

To deactivate the PTY Standby Reception, select "OFF" for the PTY code (see page 18). The PTY indicator goes off.

Tracking the same programme— Network-Tracking Reception

When driving in an area where FM reception is not sufficient enough, this receiver automatically tunes in to another FM RDS station of the same network, possibly broadcasting the same programme with stronger signals (see the illustration below). When shipped from the factory, Network-Tracking Reception is activated.

To change the Network-Tracking Reception setting, see page 18.

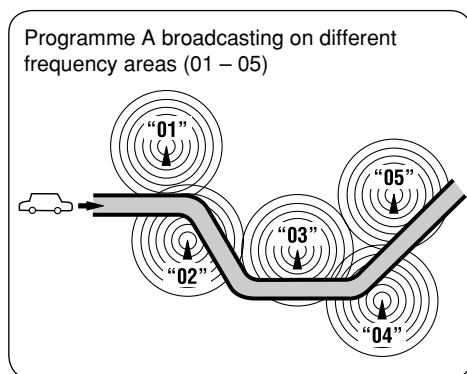

To check the current clock time while listening to an FM RDS station

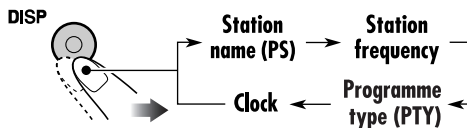

Disc operations

Playing a disc

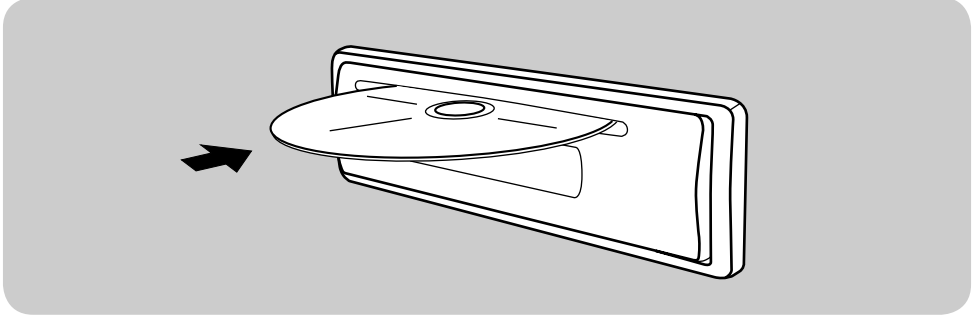

All tracks will be played repeatedly until you change the source or eject the disc.

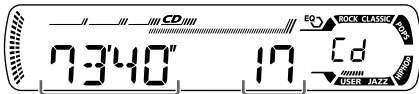
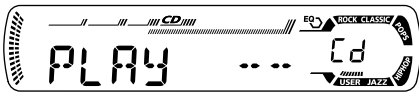

Total playing time of the inserted disc

Total track number of the inserted disc

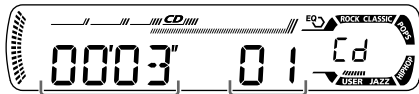

Elapsed playing time

Current track number

To stop play and eject the disc

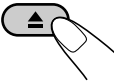

To fast-forward or reverse the track

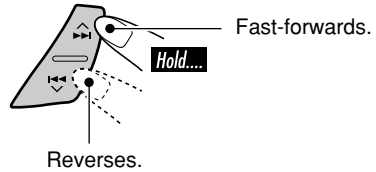

To go to the next or previous tracks

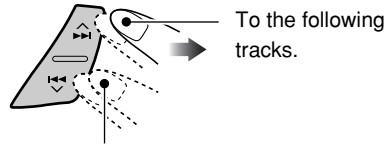

To the beginning of the current track, then the previous tracks.

To go to a particular track directly

To select a number from 01 – 06:

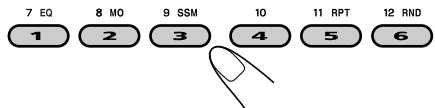

To select a number from 07 – 12:

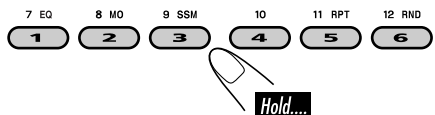

Prohibiting disc ejection

You can lock a disc in the loading slot.

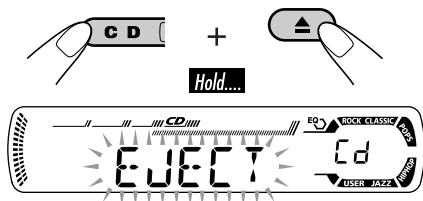

To cancel the prohibition, repeat the same procedure.

To check the current clock time while listening to a disc

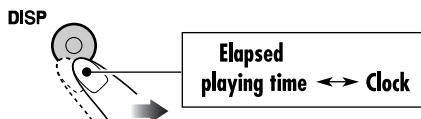

Selecting the playback modes

You can use only one of the following playback modes at a time.

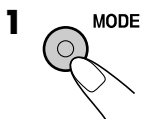

2 Select your desired playback mode.

Repeat play

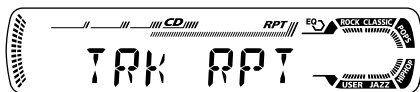
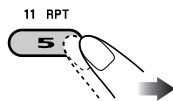

Ex.: When "TRK RPT" is selected

Mode

Plays repeatedly

- TRK RPT:** The current track.
 • RPT lights up.
- RPT OFF:** Cancels.

Random play

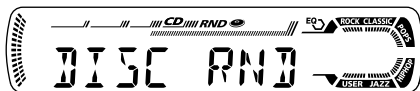
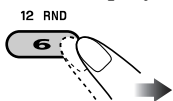

Ex.: When "DISC RND" is selected

Mode

Plays at random

- DISC RND:** All tracks of the current disc.
 • RND  lights up.
- RND OFF:** Cancels.

Sound adjustments

Selecting preset sound modes (C-EQ: custom equalizer)

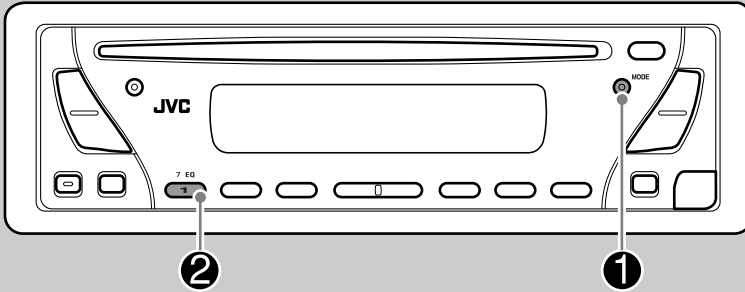

You can select a preset sound mode suitable to the music genre.

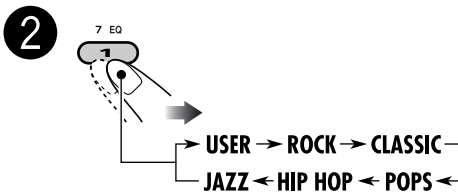
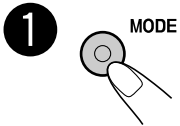

Ex.: When "ROCK" is selected

Indication	For:	Preset values		
		BAS* ¹	TRE* ²	LOUD* ³
USER	(Flat sound)	00	00	OFF
ROCK	Rock or disco music	+03	+01	ON
CLASSIC	Classical music	+01	-02	OFF
POPS	Light music	+04	+01	OFF
HIP HOP	Funk or rap music	+02	00	ON
JAZZ	Jazz music	+02	+03	OFF

*1 BAS: Bass

*2 TRE: Treble

*3 LOUD: Loudness

Indication pattern for each sound mode:

USER	ROCK	CLASSIC
JAZZ	HIP HOP	POPS

Adjusting the sound

You can adjust the sound characteristics to your preference.

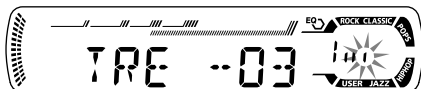
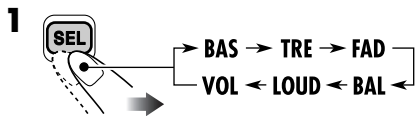

Ex.: When "TRE" is selected

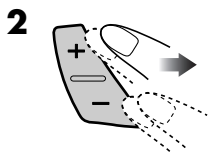

Indication pattern changes as you adjust the level.

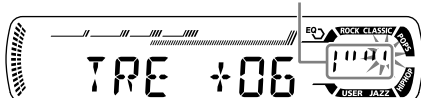

Indication	To do:	Range
BAS* ¹ (bass)	Adjust the bass.	-06 (min.) to +06 (max.)
TRE* ¹ (treble)	Adjust the treble.	-06 (min.) to +06 (max.)
FAD* ² (fader)	Adjust the front and rear speaker balance.	R06 (Rear only) to F06 (Front only)
BAL (balance)	Adjust the left and right speaker balance.	L06 (Left only) to R06 (Right only)
LOUD* ¹ (loudness)	Boost low and high frequencies to produce a well-balanced sound at low volume level.	LOUD ON ↕ LOUD OFF
VOL* ³ (volume)	Adjust the volume.	00 (min.) to 30 or 50 (max.)* ⁴

*¹ When you adjust the bass, treble, or loudness, the adjustment you have made is stored for the currently selected sound mode (C-EQ) including "USER."

*² If you are using a two-speaker system, set the fader level to "00."

*³ Normally the +/- buttons work as the volume control. So you do not have to select "VOL" to adjust the volume level.

*⁴ Depending on the amplifier gain control setting. (See page 18 for details.)

General settings — PSM

Basic procedure

You can change PSM (Preferred Setting Mode) items listed on the table that follows.

- 
- Select a PSM item.

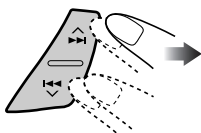

Ex.: When you select "AMP GAIN"

- Adjust the PSM item selected.

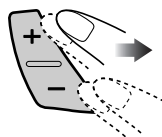

- Repeat steps 2 and 3 to adjust the other PSM items if necessary.
- Finish the procedure.



Indications	Selectable settings, [reference page]
DEMO Display demonstration	DEMO ON: [Initial]; Display demonstration will be activated automatically if no operation is done for about 20 seconds, [7]. DEMO OFF: Cancels.
CLOCK H Hour adjustment	0 – 23 (1 – 12), [7] [Initial: 0 (0:00)]
CLOCK M Minute adjustment	00 – 59, [7] [Initial: 00 (0:00)]
24H/12H 24 hours or 12 hours time display	12H ⇄ 24H, [7] [Initial: 24H]
CLK ADJ Automatic clock setting	AUTO: [Initial]; The built-in clock is automatically adjusted using the CT (clock time) data in the RDS signal. OFF: Cancels.

To be continued....

Indications	Selectable settings, [reference page]
AF-REG Alternative frequency/ regionalization reception	When the received signals from the current station become weak... AF: [Initial]; Switches to another station (the programme may differ from the one currently received), [12]. <ul style="list-style-type: none"> • The AF indicator lights up. AF REG: Switches to another station broadcasting the same programme. <ul style="list-style-type: none"> • The AF and REG indicators light up. OFF: Cancels.
PTY-STBY PTY standby	Activates PTY Standby Reception with one of the 29 PTY codes, [12]. OFF [Initial] → PTY codes, [10] → (back to the beginning)
TA VOL Traffic announcement volume	[Initial: VOL 20]; VOL 00 – VOL 30 or 50*1, [11]
P-SEARCH Programme search	ON: Using the AF data, the receiver tunes in to another frequency broadcasting the same programme as the original preset RDS station is if the preset station signals are not sufficient. OFF: [Initial]; Cancels.
ILL SW *2 Illumination switch	You can select the button illumination according to your preference. RED $\overline{\text{GREEN}}$ [Initial: RED]
TEL *2 Telephone muting	MUTING 1/MUTING 2: Select either one which mutes the sounds while using the cellular phone. OFF: [Initial]; Cancels.
AMP GAIN Amplifier gain control	You can change the maximum volume level of this receiver. LOW PWR: VOL 00 – VOL 30 (Select this if the maximum power of the speaker is less than 45 W to prevent them from damaging the speaker.) HIGH PWR: [Initial]; VOL 00 – VOL 50

*1 Depends on the amplifier gain control.

*2 Only for KD-S1501.

Detaching the control panel

When detaching or attaching the control panel, be careful not to damage the connectors on the back of the control panel and on the panel holder.

■ Detaching the control panel

Before detaching the control panel, be sure to turn off the power.

1

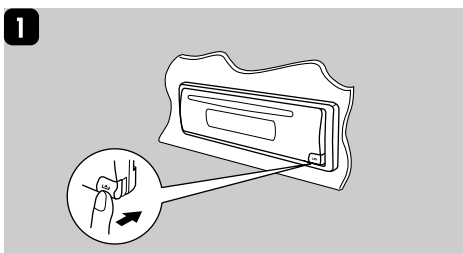

2

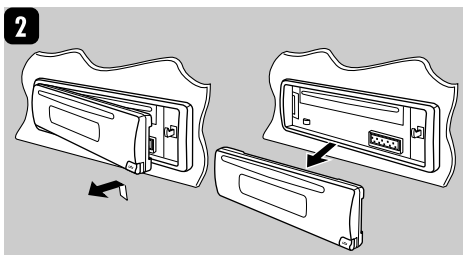

3

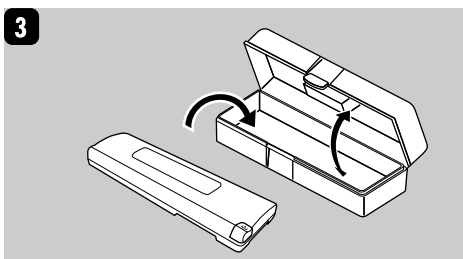

■ Attaching the control panel

1

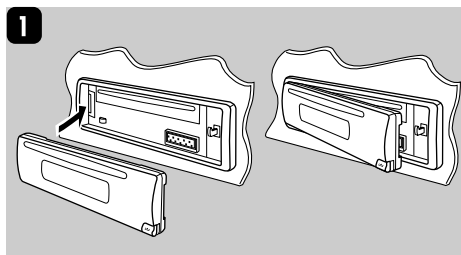

2

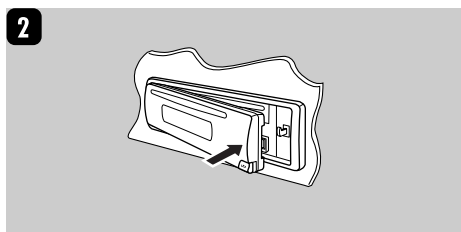

Maintenance

■ How to clean the connectors

Frequent detachment will deteriorate the connectors.

To minimize this possibility, periodically wipe the connectors with a cotton swab or cloth moistened with alcohol, being careful not to damage the connectors.

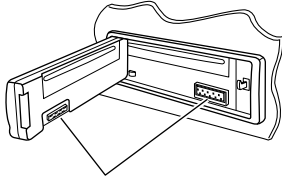

Connector

■ Moisture condensation

Moisture may condense on the lens inside the CD player in the following cases:

- After starting the heater in the car.
- If it becomes very humid inside the car.

Should this occur, the CD player may malfunction. In this case, eject the disc and leave the receiver turned on for a few hours until the moisture evaporates.

■ How to handle discs

When removing a disc from its case, press down the center holder of the case and lift the disc out, holding it by the edges.

Center holder



- Always hold the disc by the edges. Do not touch its recording surface.

When storing a disc into its case, gently insert the disc around the center holder (with the printed surface facing up).

- Make sure to store discs into the cases after use.

■ To keep discs clean

A dirty disc may not play correctly. If a disc does become dirty, wipe it with a soft cloth in a straight line from center to edge.



- Do not use any solvent (for example, conventional record cleaner, spray, thinner, benzene, etc.) to clean discs.

■ To play new discs

New discs may have some rough spots around the inner and outer edges. If such a disc is used, this receiver may reject the disc.



To remove these rough spots, rub the edges with a pencil or ball-point pen, etc.

Do not use the following discs:



More about this receiver

Basic operations

Turning off the power

- If you turn off the power while listening to a disc, disc play will start from where playback has been stopped previously, next time you turn on the power.

Tuner operations

Storing stations in memory

- During SSM search...
 - All previously stored stations are erased and stations are stored newly.
 - Received stations are preset in No. 1 (lowest frequency) to No. 6 (highest frequency).
 - When SSM is over, the station stored in No. 1 will be automatically tuned in.
- When storing a station manually, a previously preset station is erased when a new station is stored in the same preset number.

FM RDS operations

- Network-Tracking Reception requires two types of RDS signals—PI (Programme Identification) and AF (Alternative Frequency) to work correctly. Without receiving these data correctly, Network-Tracking Reception will not operate.
- If a Traffic Announcement is received, the volume level (TA Volume) automatically changes to the preset level.

Disc operations

General

- This receiver has been designed to reproduce CDs, and CD-Rs (Recordable)/CD-RWs (Rewritable) in audio CD (CD-DA) format.
- When a disc has been loaded, selecting “CD” for the playback source starts disc play.

Inserting a disc

- When a disc is inserted upside down, the disc automatically ejects.
- Do not insert 8 cm discs (single CD) and unusual shape discs (heart, flower, etc.) into the loading slot.

Playing a CD-R or CD-RW

- Use only “finalized” CD-Rs or CD-RWs.
- This receiver can play back multi-session discs; however, unclosed sessions will be skipped while playing.
- Some CD-Rs or CD-RWs may not play back on this receiver because of their disc characteristics, and for the following causes:
 - Discs are dirty or scratched.
 - Moisture condensation occurs on the lens inside the receiver.
 - The pickup lens inside the receiver is dirty.
 - CD-R or CD-RW on which the files are written with “Packet Write” method.
 - There are improper recording conditions (missing data, etc.) or media conditions (stain, scratch, warp, etc.).
- CD-RWs may require a longer readout time since the reflectance of CD-RWs is lower than that of regular CDs.
- Do not use the following CD-Rs or CD-RWs:
 - Discs with stickers, labels, or protective seal stuck to the surface.
 - Discs on which labels can be directly printed by an ink jet printer.Using these discs under high temperatures or high humidities may cause malfunctions or damages to discs.

Changing the source

- If you change the source, playback also stops (without ejecting the disc). Next time you select “CD” for the playback source, disc play starts from where it has been stopped previously.

Ejecting a disc

- If the ejected disc is not removed within 15 seconds, the disc is automatically inserted again into the loading slot to prevent it from dust. (Disc will not play this time.)

General settings—PSM

- If you change the “AMP GAIN” setting from “HIGH PWR” to “LOW PWR” while the volume level is set higher than “VOL 30,” the receiver automatically changes the volume level to “VOL 30.”

Troubleshooting

What appears to be trouble is not always serious. Check the following points before calling a service center.

	Symptoms	Causes	Remedies
General	<ul style="list-style-type: none"> Sound cannot be heard from the speakers. 	The volume level is set to the minimum level.	Adjust it to the optimum level.
		Connections are incorrect.	Check the cords and connections.
FM/AM	<ul style="list-style-type: none"> This receiver does not work at all. 	The built-in microcomputer may have functioned incorrectly due to noise, etc.	Reset the receiver (see page 2).
		<ul style="list-style-type: none"> SSM automatic presetting does not work. 	Signals are too weak.
Disc playback	<ul style="list-style-type: none"> Static noise while listening to the radio. 	The aerial is not connected firmly.	Connect the aerial firmly.
		<ul style="list-style-type: none"> Disc automatically ejects. 	Disc is inserted upside down.
	<ul style="list-style-type: none"> CD-R/CD-RW cannot be played back. Tracks on the CD-R/CD-RW cannot be skipped. 	CD-R/CD-RW is not finalized.	<ul style="list-style-type: none"> Insert a finalized CD-R/CD-RW. Finalize the CD-R/CD-RW with the component which you used for recording.
		<ul style="list-style-type: none"> Disc can be neither played back nor ejected. 	Disc is locked.
	The CD player may have functioned incorrectly.		Eject the disc forcibly (see page 2).
	<ul style="list-style-type: none"> Disc sound is sometimes interrupted. 	You are driving on rough roads.	Stop playback while driving on rough roads.
		Disc is scratched.	Change the disc.
		Connections are incorrect.	Check the cords and connections.
	<ul style="list-style-type: none"> "NO DISC" appears on the display. 	No disc is in the loading slot.	Insert a disc into the loading slot.
		Disc is inserted incorrectly.	Insert the disc correctly.

Specifications

AUDIO AMPLIFIER SECTION

Maximum Power Output:

Front: 45 W per channel

Rear: 45 W per channel

Continuous Power Output (RMS):

Front: 17 W per channel into 4 Ω , 40 Hz to 20 000 Hz at no more than 0.8% total harmonic distortion.

Rear: 17 W per channel into 4 Ω , 40 Hz to 20 000 Hz at no more than 0.8% total harmonic distortion.

Load Impedance: 4 Ω (4 Ω to 8 Ω allowance)

Tone Control Range:

Bass: ± 10 dB at 100 Hz

Treble: ± 10 dB at 10 kHz

Frequency Response: 40 Hz to 20 000 Hz

Signal-to-Noise Ratio: 70 dB

Line-Out Level/Impedance:

2.0 V/20 k Ω load (full scale)

Output Impedance: 1 k Ω

TUNER SECTION

Frequency Range:

FM: 87.5 MHz to 108.0 MHz

AM: (MW) 522 kHz to 1 620 kHz
(LW) 144 kHz to 279 kHz

[FM Tuner]

Usable Sensitivity: 11.3 dBf (1.0 μ V/75 Ω)

50 dB Quieting Sensitivity:

16.3 dBf (1.8 μ V/75 Ω)

Alternate Channel Selectivity (400 kHz): 65 dB

Frequency Response: 40 Hz to 15 000 Hz

Stereo Separation: 30 dB

Capture Ratio: 1.5 dB

[MW Tuner]

Sensitivity: 20 μ V

Selectivity: 35 dB

[LW Tuner]

Sensitivity: 50 μ V

CD PLAYER SECTION

Type: Compact disc player

Signal Detection System: Non-contact optical pickup (semiconductor laser)

Number of channels: 2 channels (stereo)

Frequency Response: 5 Hz to 20 000 Hz

Dynamic Range: 96 dB

Signal-to-Noise Ratio: 98 dB

Wow and Flutter: Less than measurable limit

GENERAL

Power Requirement:

Operating Voltage:

DC 14.4 V (11 V to 16 V allowance)

Grounding System: Negative ground

Allowable Operating Temperature:

0°C to +40°C

Dimensions (W \times H \times D):

Installation Size (approx.):

182 mm \times 52 mm \times 150 mm

Panel Size (approx.):

188 mm \times 58 mm \times 11 mm

Mass (approx.):

1.3 kg (excluding accessories)

Design and specifications are subject to change without notice.

ENGLISH

This receiver is designed to operate on **12 V DC, NEGATIVE ground electrical systems**. If your vehicle does not have this system, a voltage inverter is required, which can be purchased at JVC IN-CAR ENTERTAINMENT dealers.

FRANÇAIS

Cet appareil est conçu pour fonctionner sur des sources de **courant continu de 12 V à masse NEGATIVE**. Si votre véhicule n'offre pas ce type d'alimentation, il vous faut un convertisseur de tension, que vous pouvez acheter chez un revendeur d'autoradios JVC.

Parts list for installation and connection

The following parts are provided for this receiver. After checking them, please set them correctly.

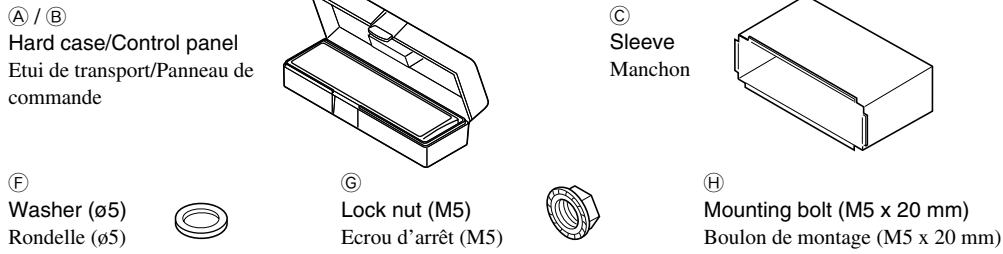

Liste des pièces pour l'installation et raccordement

Les pièces suivantes sont fournies avec cet appareil. Après vérification, veuillez les placer correctement.

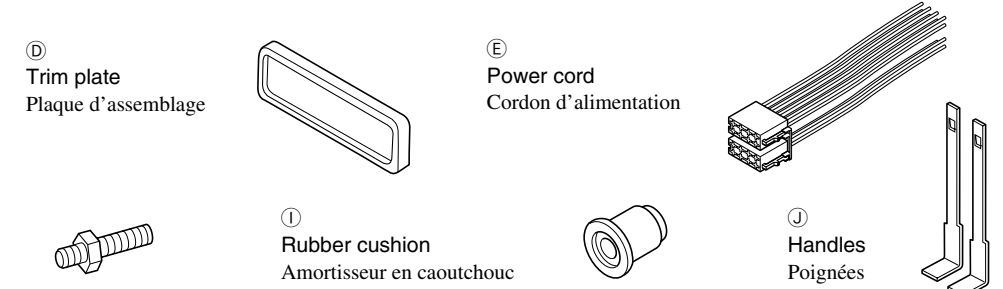

INSTALLATION (IN-DASH MOUNTING)

The following illustration shows a typical installation. If you have any questions or require information regarding installation kits, consult your JVC IN-CAR ENTERTAINMENT dealer or a company supplying kits.

- If you are not sure how to install this receiver correctly, have it installed by a qualified technician.

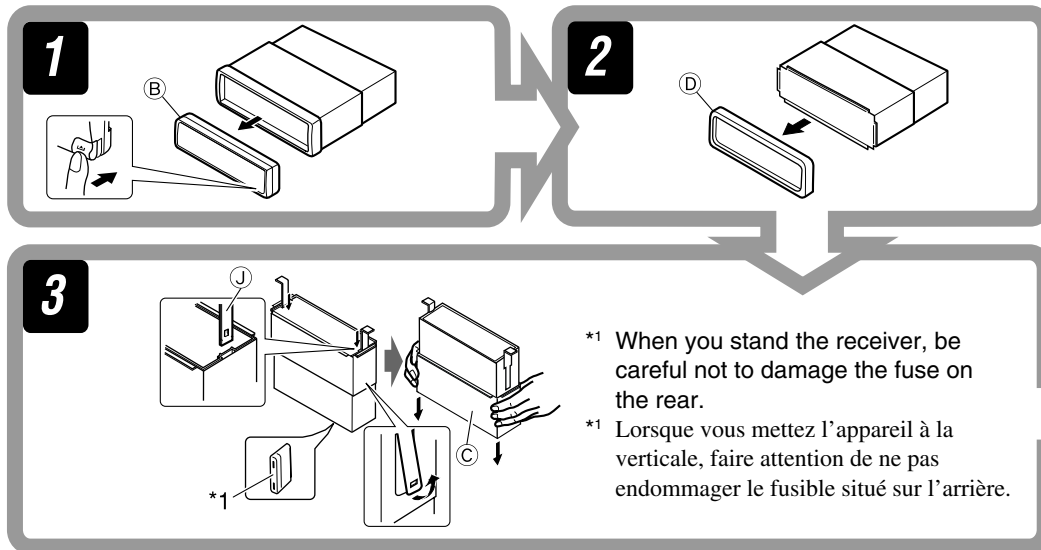

INSTALLATION (MONTAGE DANS LE TABLEAU DE BORD)

L'illustration suivante est un exemple d'installation typique. Si vous avez des questions ou avez besoin d'information sur des kits d'installation, consulter votre revendeur d'autoradios JVC ou une compagnie d'approvisionnement.

- Si l'on n'est pas sûr de pouvoir installer correctement cet appareil, le faire installer par un technicien qualifié.

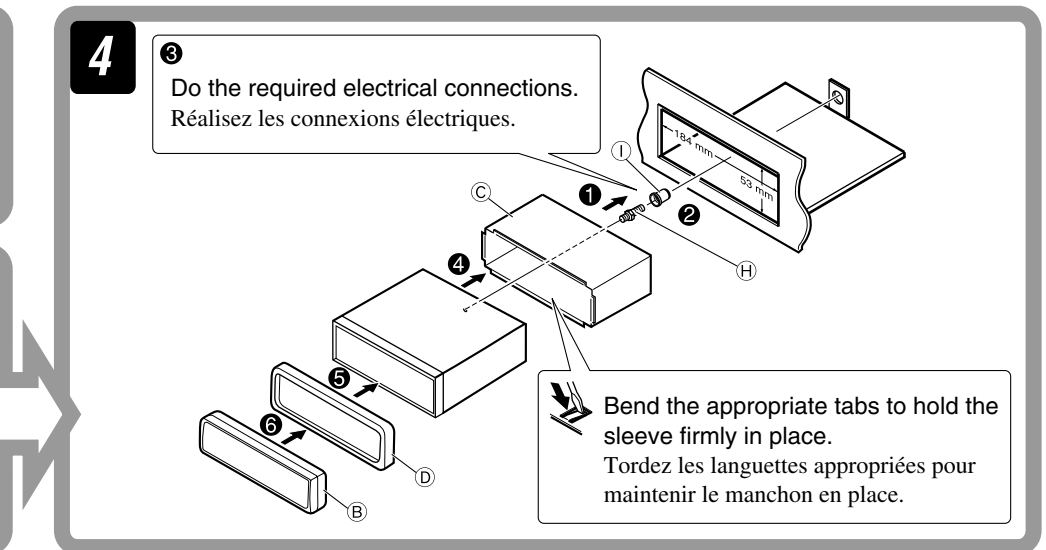

Removing the receiver / Retrait de l'appareil

Before removing the receiver, release the rear section.
Avant de retirer l'appareil, libérer la section arrière.

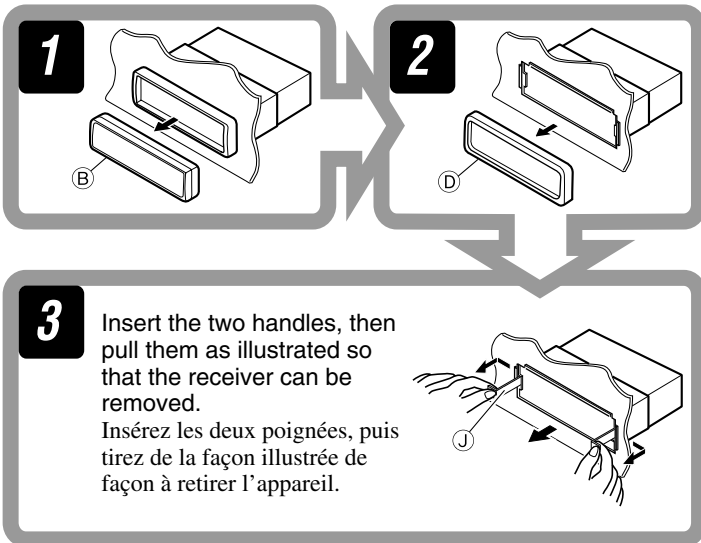

When using the optional stay / Lors de l'utilisation du hauban en option

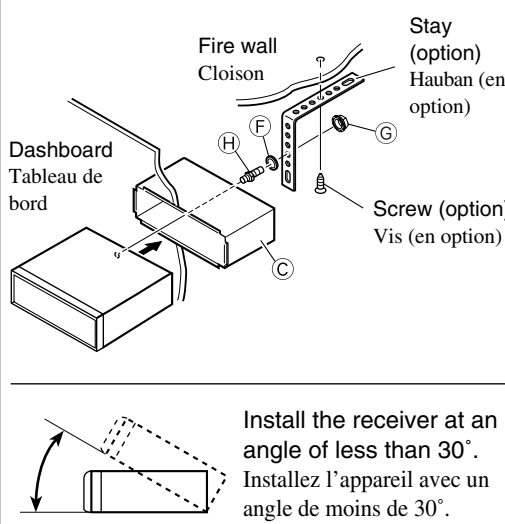

When installing the receiver without using the sleeve / Lors de l'installation de l'appareil sans utiliser de manchon

In a Toyota for example, first remove the car radio and install the receiver in its place.
Par exemple dans une Toyota, retirer d'abord l'autoradio et installer l'appareil à la place.

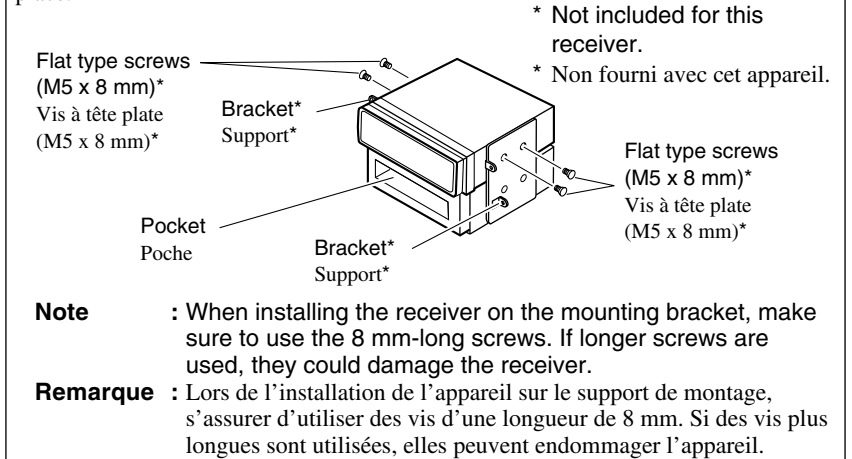

PRECAUTIONS on power supply and speaker connections:

- **DO NOT** connect the speaker leads of the power cord to the car battery; otherwise, the receiver will be seriously damaged.
- **BEFORE** connecting the speaker leads of the power cord to the speakers, check the speaker wiring in your car.

PRECAUTIONS sur l'alimentation et la connexion des enceintes:

- **NE CONNECTEZ PAS** les fils d'enceintes du cordon d'alimentation à la batterie; sinon, l'appareil serait sérieusement endommagé.
- **AVANT** de connecter les fils d'enceintes du cordon d'alimentation aux enceintes, vérifiez le câblage des enceintes de votre voiture.

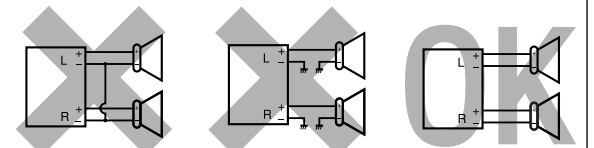

TROUBLESHOOTING

- **The fuse blows.**
* Are the red and black leads connected correctly?
- **Power cannot be turned on.**
* Is the yellow lead connected?
- **No sound from the speakers.**
* Is the speaker output lead short-circuited?
- **Sound is distorted.**
* Is the speaker output lead grounded?
* Are the "-" terminals of L and R speakers grounded in common?
- **Noise interfere with sounds.**
* Is the rear ground terminal connected to the car's chassis using shorter and thicker cords?
- **Receiver becomes hot.**
* Is the speaker output lead grounded?
* Are the "-" terminals of L and R speakers grounded in common?
- **This receiver does not work at all.**
* Have you reset your receiver?

EN CAS DE DIFFICULTES

- **Le fusible saute.**
* Les fils rouge et noir sont-ils raccordés correctement?
- **L'appareil ne peut pas être mise sous tension.**
* Le fil jaune est-elle raccordée?
- **Pas de son des enceintes.**
* Le fil de sortie d'enceinte est-il court-circuité?
- **Le son est déformé.**
* Le fil de sortie d'enceinte est-il à la masse?
* Les bornes "-" des enceintes gauche et droit sont-elles mises ensemble à la masse?
- **Interférence avec les sons.**
* La prise arrière de mise à la terre est-elle connectée au châssis de la voiture avec un cordon court et épais?
- **L'appareil devient chaud.**
* Le fil de sortie d'enceinte est-il à la masse?
* Les bornes "-" des enceintes gauche et droit sont-elles mises ensemble à la masse?
- **Cet appareil ne fonctionne pas du tout.**
* Avez-vous réinitialisé votre appareil?

ELECTRICAL CONNECTIONS

To prevent short circuits, we recommend that you disconnect the battery's negative terminal and make all electrical connections before installing the receiver.

• **Be sure to ground this receiver to the car's chassis again after installation.**

Notes:

- Replace the fuse with one of the specified rating. If the fuse blows frequently, consult your JVC IN-CAR ENTERTAINMENT dealer.
- It is recommended to connect to the speakers with maximum power of more than 45 W (both at the rear and at the front, with an impedance of **4 Ω to 8 Ω**). If the maximum power is less than 45 W, change "AMP GAIN" setting to prevent the speakers from being damaged (see page 18 of the INSTRUCTIONS).
- To prevent short-circuit, cover the terminals of the UNUSED leads with insulating tape.
- The heat sink becomes very hot after use. Be careful not to touch it when removing this receiver.

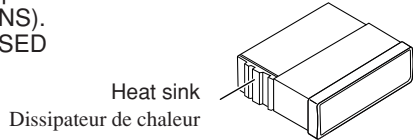

RACCORDEMENTS ELECTRIQUES

Pour éviter tout court-circuit, nous vous recommandons de débrancher la borne négative de la batterie et d'effectuer tous les raccordements électriques avant d'installer l'appareil.

• **Assurez-vous de raccorder de nouveau la mise à la masse de cet appareil au châssis de la voiture après l'installation.**

Remarques:

- Remplacer le fusible par un de la valeur précisée. Si le fusible saute souvent, consulter votre revendeur d'autoradios JVC.
- Il est recommandé de connecter des enceintes avec une puissance de plus de 45 W (les enceintes arrière et les enceintes avant, avec une impédance comprise entre **4 Ω et 8 Ω**). Si la puissance maximum est inférieure à 45 W, changez "AMP GAIN" pour éviter d'endommager vos enceintes (voir page 18 du MANUEL D'INSTRUCTIONS).
- Pour éviter les court-circuits, couvrir les bornes des fils qui ne sont PAS UTILISÉS avec de la bande isolante.
- Le dissipateur de chaleur devient très chaud après usage. Faire attention de ne pas le toucher en retirant cet appareil.

A Typical connections / Raccordements typiques

Before connecting: Check the wiring in the vehicle carefully. Incorrect connection may cause serious damage to this receiver. The leads of the power cord and those of the connector from the car body may be different in color.

- 1 Connect the colored leads of the power cord in the order specified in the illustration below.
- 2 Connect the aerial cord.
- 3 Finally connect the wiring harness to the receiver.

Note: If your vehicle does not have any accessory terminal, move the fuse from the fuse position 1 (initial position) to fuse position 2, and connect the red lead (A7) to the positive (+) battery terminal.

• The yellow lead (A4) is not used in this case.

Avant de commencer la connexion: Vérifiez attentivement le câblage du véhicule. Une connexion incorrecte peut endommager sérieusement l'appareil. Le fil du cordon d'alimentation et ceux des connecteurs du châssis de la voiture peuvent être différents en couleur.

- 1 Connectez les fils colorés du cordon d'alimentation dans l'ordre spécifié sur l'illustration ci-dessous.
- 2 Connectez le cordon d'antenne.
- 3 Finalement, connectez le faisceau de fils à l'appareil.

Remarque: Si votre véhicule ne possède pas de borne accessoire, déplacez le fusible de la position de fusible 1 (position originale) à la position de fusible 2 et connectez le fil rouge (A7) à la borne positive (+) de la batterie.

• Le fil jaune (A4) n'est pas utilisé dans ce cas.

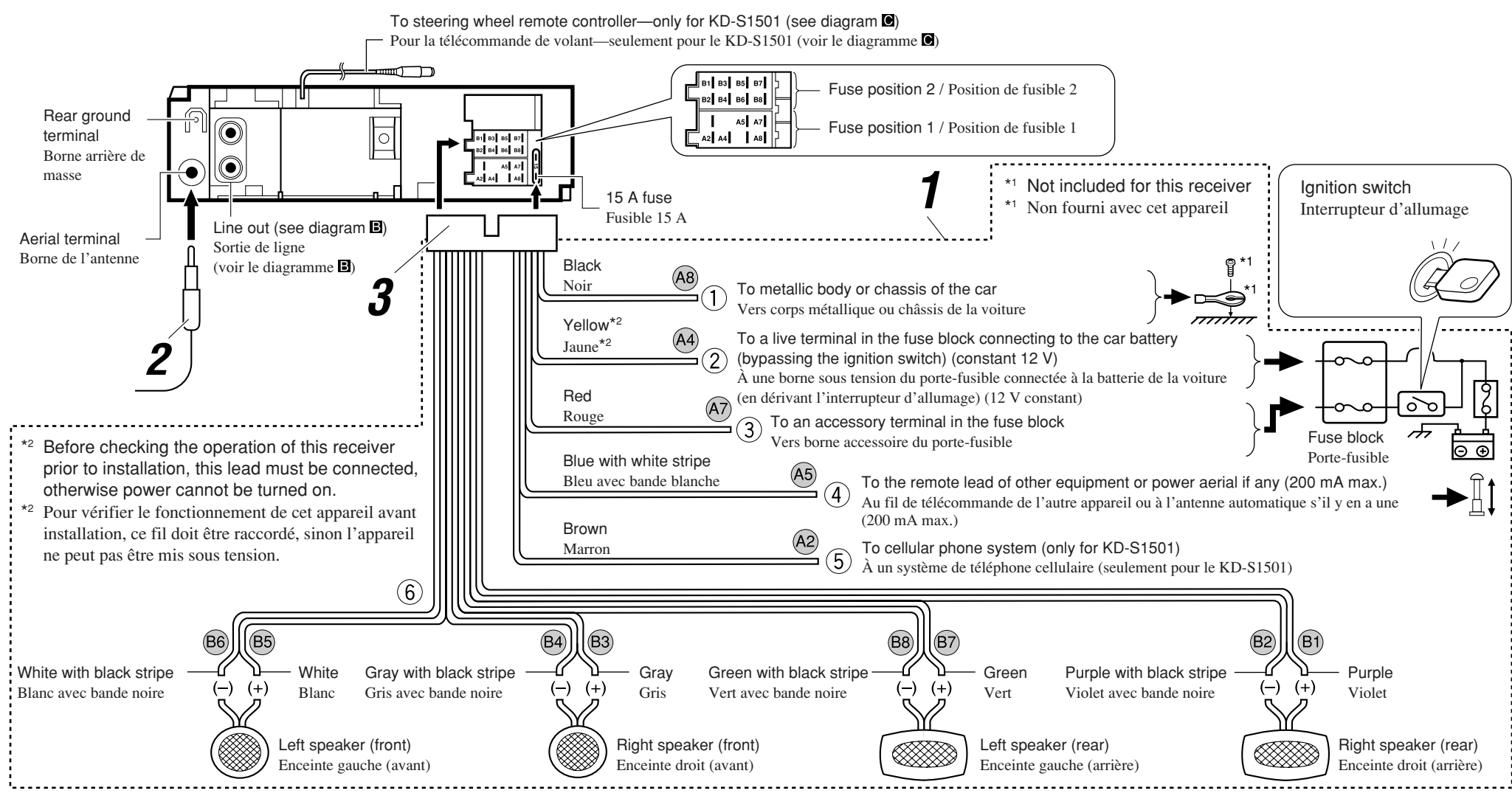

B Connecting the external amplifier / Connexion d'un amplificateur extérieur

You can connect an amplifier to upgrade your car stereo system.

- Connect the remote lead (blue with white stripe) to the remote lead of the other equipment so that it can be controlled through this receiver.
- **Disconnect the speakers from this receiver, connect them to the amplifier. Leave the speaker leads of this receiver unused.**

Vous pouvez connecter un amplificateur pour améliorer votre système autoradio.

- Connectez le fil de commande à distance (bleu avec bande blanche) au fil de commande à distance de l'autre appareil de façon qu'il puisse être commandé via cet appareil.
- **Déconnectez les enceintes de cet appareil et connectez-les à l'amplificateur. Laissez les fils d'enceintes de cet appareil inutilisés.**

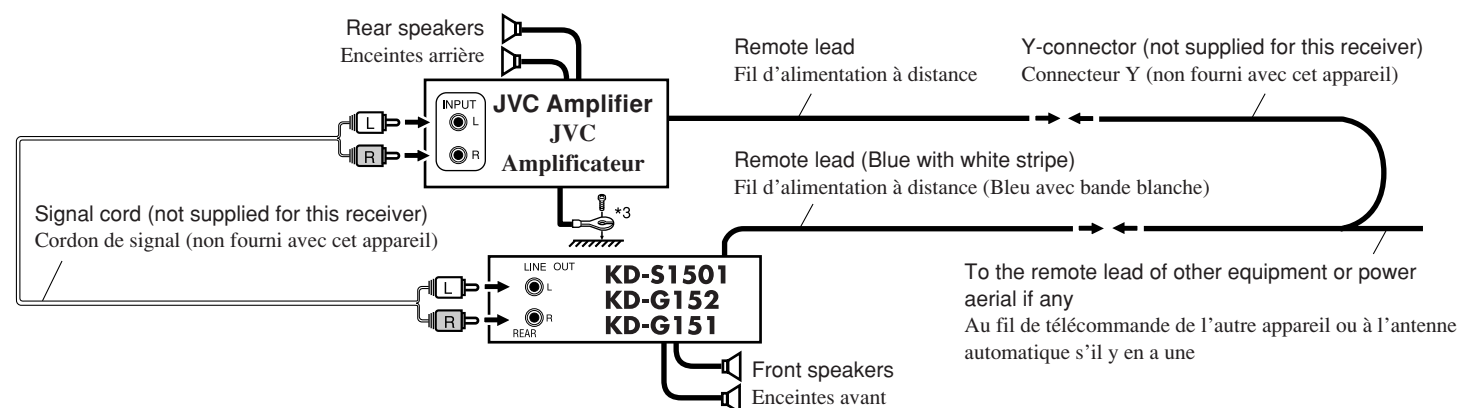

*3 Firmly attach the ground wire to the metallic body or to the chassis of the car—to the place not coated with paint (if coated with paint, remove the paint before attaching the wire). Failure to do so may cause damage to the receiver.
*3 Attachez solidement le fil de mise à la masse au châssis métallique de la voiture—à un endroit qui n'est pas recouvert de peinture (s'il est recouvert de peinture, enlevez d'abord la peinture avant d'attacher le fil). L'appareil peut être endommagé si cela n'est pas fait correctement.

C Connecting to the steering wheel remote controller / Connexion de la télécommande de volant

Only for KD-S1501 / Seulement pour le KD-S1501

If your car is equipped with the steering wheel remote controller, you can operate this receiver using the controller. To do it, a JVC's OE remote adapter (not supplied) which matches with your car is required. Consult your JVC IN-CAR ENTERTAINMENT dealer for details.

Si votre voiture est munie d'une télécommande de volant, vous pouvez commander cet autoradio en utilisant la télécommande. Pour le faire, un adaptateur pour télécommande au volant JVC (non fourni) correspondant à votre voiture est nécessaire. Consultez votre revendeur d'autoradio JVC pour les détails.

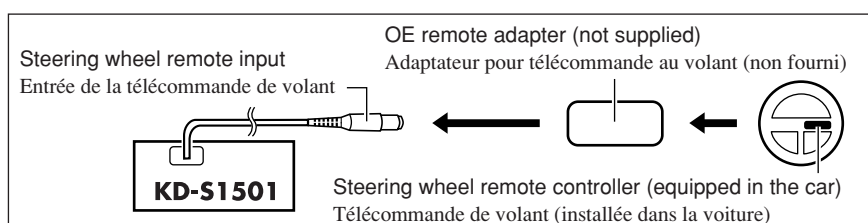



Having TROUBLE with operation?

Please reset your unit

Refer to page of How to reset your unit

Vous avez des PROBLÈMES de fonctionnement?

Réinitialisez votre appareil

Référez-vous à la page intitulée Comment réinitialiser votre appareil

JVC



EN, FR

© 2004 Victor Company of Japan, Limited

1004DTSMDTJEIN

Free Manuals Download Website

<http://myh66.com>

<http://usermanuals.us>

<http://www.somanuals.com>

<http://www.4manuals.cc>

<http://www.manual-lib.com>

<http://www.404manual.com>

<http://www.luxmanual.com>

<http://aubethermostatmanual.com>

Golf course search by state

<http://golfingnear.com>

Email search by domain

<http://emailbydomain.com>

Auto manuals search

<http://auto.somanuals.com>

TV manuals search

<http://tv.somanuals.com>