

# JVC



## CD RECEIVER

# KD-G614/KD-G514



**MP3**

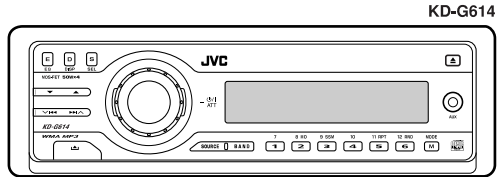

KD-G614

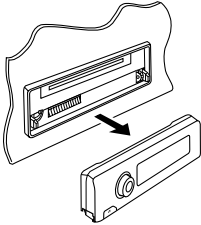

**WMA**

**COMPACT  
disc  
DIGITAL AUDIO  
TEXT**

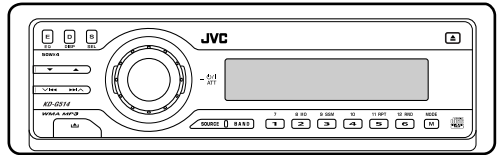

KD-G514

For canceling the display demonstration, see page 8.

For installation and connections, refer to the separate manual.

# INSTRUCTIONS

GET0305-001A  
[U]

Thank you for purchasing a JVC product.

Please read all instructions carefully before operation, to ensure your complete understanding and to obtain the best possible performance from the unit.

## IMPORTANT FOR LASER PRODUCTS

1. CLASS 1 LASER PRODUCT
2. **CAUTION:** Do not open the top cover. There are no user serviceable parts inside the unit; leave all servicing to qualified service personnel.
3. **CAUTION:** Visible and invisible laser radiation when open and interlock failed or defeated. Avoid direct exposure to beam.
4. REPRODUCTION OF LABEL: CAUTION LABEL, PLACED OUTSIDE THE UNIT.

|  |   |  |   |
|--|---|--|---|
| <b>CAUTION:</b> Visible and invisible laser radiation when open and interlock failed or defeated. AVOID DIRECT EXPOSURE TO BEAM. | <b>ADVARSEL:</b> Synlig og usynlig laserstråling når maskinen er åpen eller interlocken fejler. Undgå direkte eksponering til stråling. | <b>VARNING:</b> Synlig og usynlig laserstråling når den åpnes og spærren er urkoppodet. Betrakta ej strålen. | <b>VARO:</b> Avlåtessa ja suojaulkutus ohjelutuna tai viäläisena ollet antinna näkyväille ja näkymättömille lasersäteilylle. Vältä säteien kohdistumista suoraan itseesi. (f) |
|--|---|--|---|

### Warning:

If you need to operate the receiver while driving, be sure to look ahead carefully or you may be involved in a traffic accident.

### How to reset your unit

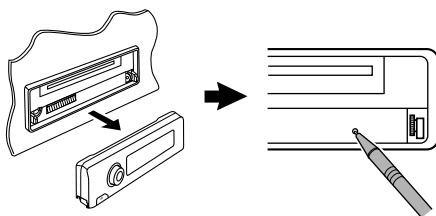

*This will reset the microcomputer. Your preset adjustments will also be erased.*

### How to forcibly eject a disc

If a disc cannot be recognized by the receiver or cannot be ejected, ejects the disc as follows.

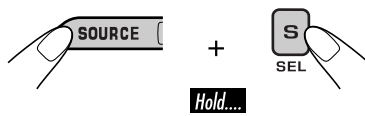

“PLEASE” and “EJECT” appear alternately on the display.

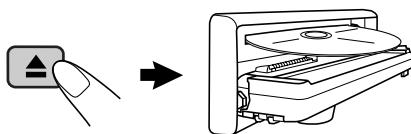

- If this does not work, reset your receiver.
- Be careful not to drop the disc when it ejects.

# Contents

|  |           |  |           |
|--|-----------|--|-----------|
| How to reset your unit .....                 | 2         | <b>Sound adjustments .....</b>             | <b>18</b> |
| How to forcibly eject a disc .....           | 2         | <b>Selecting preset sound modes</b>        |           |
| How to read this manual .....                | 4         | <b>(C-EQ: custom equalizer) .....</b>      | <b>18</b> |
| How to use the M MODE button.....            | 4         | Adjusting the sound .....                  | 19        |
| <b>Control panel</b>                         |           | <b>General settings — PSM .....</b>        | <b>20</b> |
| — <b>KD-G614/KD-G514 .....</b>               | <b>5</b>  | Basic procedure .....                      | 20        |
| Parts identification .....                   | 5         | <b>Other main functions .....</b>          | <b>22</b> |
| <b>Remote controller — RM-RK50 ...</b>       | <b>6</b>  | Assigning titles to the sources .....      | 22        |
| Main elements and features .....             | 6         | Detaching the control panel .....          | 23        |
| <b>Getting started.....</b>                  | <b>7</b>  | <b>External component operations... 24</b> |           |
| <b>Basic operations.....</b>                 | <b>7</b>  | Playing an external component .....        | 24        |
| Canceling the display demonstrations ...     | 8         | <b>Maintenance .....</b>                   | <b>25</b> |
| Setting the clock .....                      | 8         | <b>More about this receiver .....</b>      | <b>26</b> |
| <b>Radio operations .....</b>                | <b>9</b>  | <b>Troubleshooting .....</b>               | <b>28</b> |
| <b>Listening to the radio.....</b>           | <b>9</b>  | <b>Specifications .....</b>                | <b>31</b> |
| Storing stations in memory .....             | 10        |  |           |
| Listening to a preset station .....          | 11        |  |           |
| <b>Disc operations .....</b>                 | <b>12</b> |  |           |
| <b>Playing a disc in the receiver .....</b>  | <b>12</b> |  |           |
| <b>Playing discs in the CD changer .....</b> | <b>13</b> |  |           |
| Other main functions .....                   | 15        |  |           |
| Changing the display information .....       | 16        |  |           |
| Selecting the playback modes.....            | 17        |  |           |

## **\*For safety....**

- Do not raise the volume level too much, as this will block outside sounds, making driving dangerous.
- Stop the car before performing any complicated operations.



## **\*Temperature inside the car....**

If you have parked the car for a long time in hot or cold weather, wait until the temperature in the car becomes normal before operating the unit.

## How to read this manual

The following methods are used to make the explanations simple and easy-to-understand:

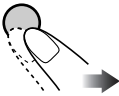
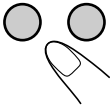
- Some related tips and notes are explained in “More about this receiver” (see pages 26 and 27).
- Button operations are mainly explained with the illustrations as follows:

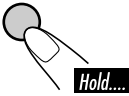
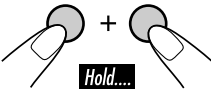
|  |  |
|--|--|
|   | Press briefly.                                     |
|   | Press repeatedly.                                  |
|   | Press either one.                                  |
|   |  |
|  | Press and hold until your desired response begins. |
|  | Press and hold both buttons at the same time.      |

The following marks are used to indicate...

 : Built-in CD player operations.

 : External CD changer operations.

## How to use the M MODE button

If you press M MODE, the receiver goes into functions mode, then the number buttons and ▲/▼ buttons work as different function buttons.

Ex.: When number button 2 works as MO (monaural) button.

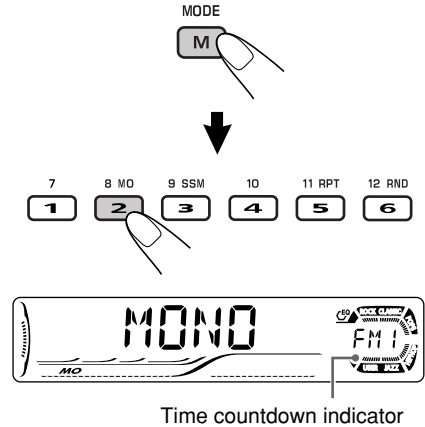

To use these buttons for original functions again after pressing M MODE, wait for 5 seconds without pressing any of these buttons until the functions mode is cleared.

- Pressing M MODE again also clears the functions mode.

### Caution on volume setting:

Discs produce very little noise compared with other sources. Lower the volume before playing a disc to avoid damaging the speakers by the sudden increase of the output level.

## Parts identification

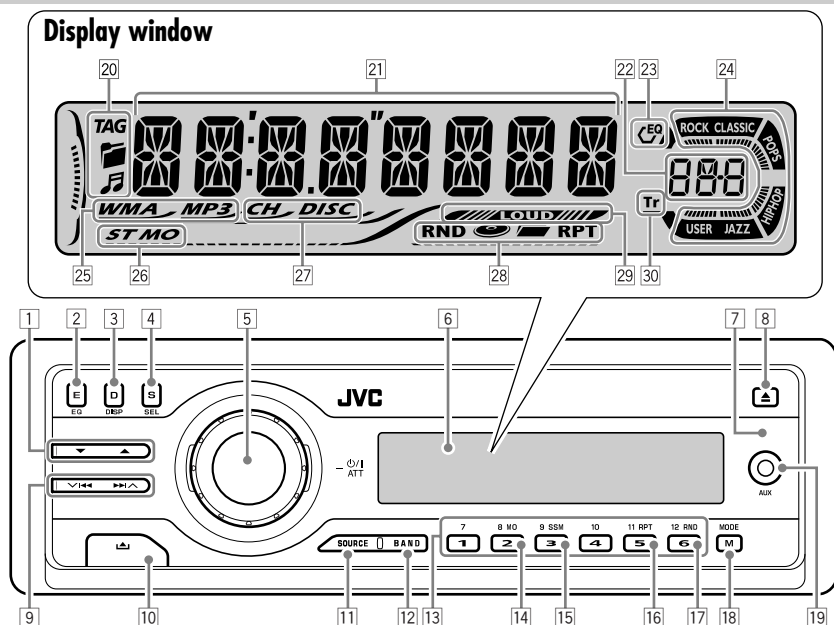

- 1 ▲ (up) / ▼ (down) buttons
- 2 E EQ (equalizer) button
- 3 D DISP (display) button
- 4 S SEL (select) button
- 5
  - Control dial
  - $\Phi$ /I ATT (standby/on attenuator) button
- 6 Display window
- 7 Remote sensor
  - *DO NOT expose the remote sensor to strong light (direct sunlight or artificial lighting).*
- 8 ▲ (eject) button
- 9 ▼ |◀▶▶| ▲ buttons
- 10  $\blacktriangle$  (control panel release) button
- 11 SOURCE button
- 12 BAND button
- 13 Number buttons
- 14 MO (monaural) button
- 15 SSM (Strong-station Sequential Memory) button
- 16 RPT (repeat) button
- 17 RND (random) button
- 18 M MODE button
- 19 AUX (auxiliary) input jack
  - *Only for KD-G614.*
  - *NOT compatible with digital signals.*

### Display window

- 20 Disc information indicators—TAG (ID3 Tag),  $\square$  (folder),  $\text{♪}$  (track/file)
- 21 Main display
- 22 Source display
- Volume level indicator
- 23 EQ (equalizer) indicator
- 24 Sound mode (C-EQ: custom equalizer) indicators—ROCK, CLASSIC, POPS, HIP HOP, JAZZ, USER
  - $\text{|||||}$  also works as the time countdown indicator and level meter during play (see page 20).
- 25 Disc type indicators—WMA, MP3
- 26 Tuner reception indicators—ST (stereo), MO (monaural)
- 27 Playback source indicators—
  - CH: *Lights up only when CD-CH is selected as the playback source.*
  - DISC: *Lights up for the built-in CD player.*
- 28 Playback mode / item indicators—
  - RND (random),  $\text{disc}$  (disc),  $\text{folder}$  (folder), RPT (repeat)
- 29 LOUD (loudness) indicator
- 30 Tr (track) indicator

# Remote controller — RM-RK50

## Installing the lithium coin battery (CR2025)

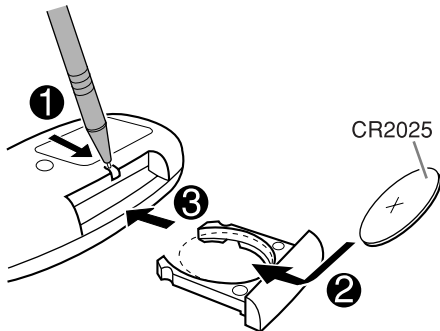

- When operating, aim the remote controller directly at the remote sensor on the receiver. Make sure there is no obstacle in between.

### Warning:

- Store the battery in a place where children cannot reach to avoid risk of accident.
- To prevent the battery from over-heating, cracking, or starting a fire:
  - Do not recharge, short, disassemble, or heat the battery or dispose of it in a fire.
  - Do not leave the battery with other metallic materials.
  - Do not poke the battery with tweezers or similar tools.
  - Wrap the battery with tape and insulate when throwing away or saving it.

### Caution:

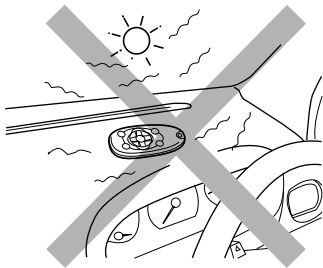

## Main elements and features

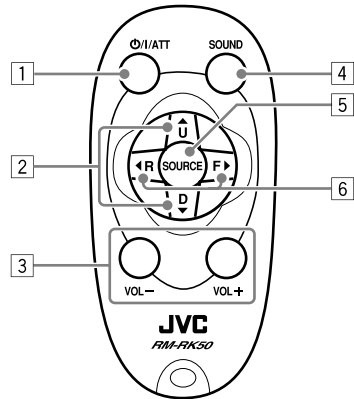

- 1 **⏻/I/ATT** (standby/on/attenuator) button
  - Turns on and off the power and also attenuates the sound.
- 2 **▲ U** (up) / **D** (down) **▼** buttons
  - **▲ U**: Changes the FM/AM bands.
  - **D ▼**: Changes the preset stations.
  - Changes the folder of the MP3/WMA discs.
  - While playing an MP3 disc on an MP3-compatible CD changer:
    - Changes the disc if pressed briefly.
    - Changes the folder if pressed and held.
- 3 **VOL -** / **VOL +** buttons
  - Adjusts the volume level.
- 4 **SOUND** button
  - Selects the sound mode (C-EQ: custom equalizer).
- 5 **SOURCE** button
  - Selects the source.
- 6 **◀ R** (reverse) / **F** (forward) **▶** buttons
  - Searches for stations if pressed briefly.
  - Fast-forwards or reverses the track if pressed and held.
  - Changes the tracks of the disc.

# Getting started

## Basic operations

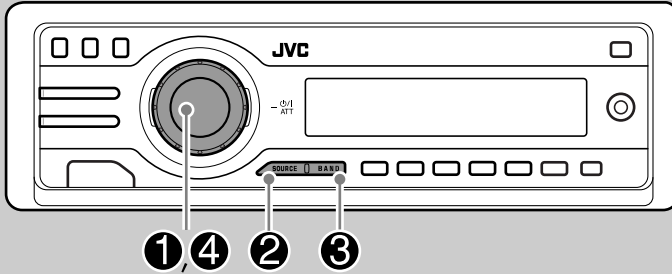

\* The control panel illustrations used for explanation in this manual is KD-G614.

1

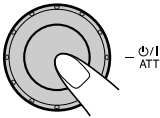

2

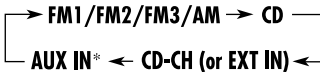
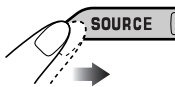

You cannot select some sources if they are not ready.

\* Only for KD-G614.

3

For FM/AM tuner only

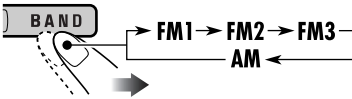

4

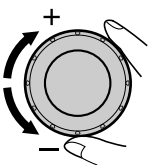

Volume level appears.

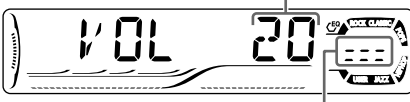

Volume level indicator

5

Adjust the sound as you want.  
(See pages 18 and 19.)

### To drop the volume in a moment (ATT)

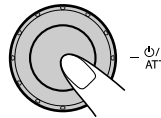

To restore the sound, press it again.

### To turn off the power

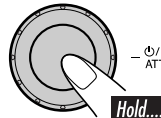

## Canceling the display demonstrations

If no operations are done for about 20 seconds, display demonstration starts.

[Initial: DEMO ON]—see page 20.

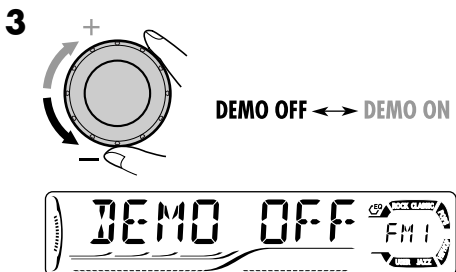
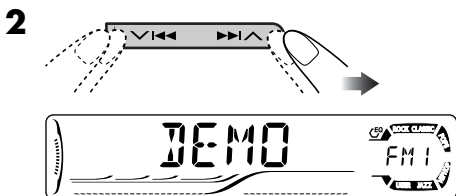

**4** Finish the procedure.



## To activate the display demonstration

In step **3** above...

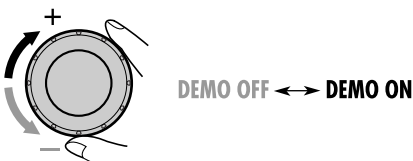

## Setting the clock



**2** Set the hour and minute.

**1** Select “CLOCK H” (hour), then adjust the hour.

**2** Select “CLOCK M” (minute), then adjust the minute.

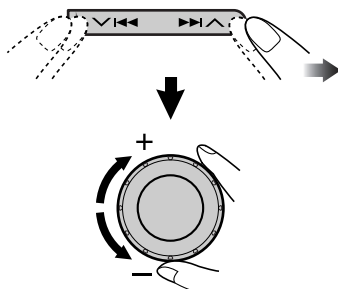

**3** Finish the procedure.



**To check the current clock time when the power is turned off**





# Radio operations

## Listening to the radio

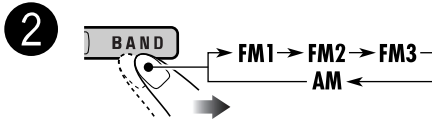
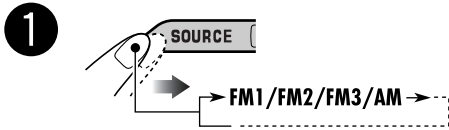
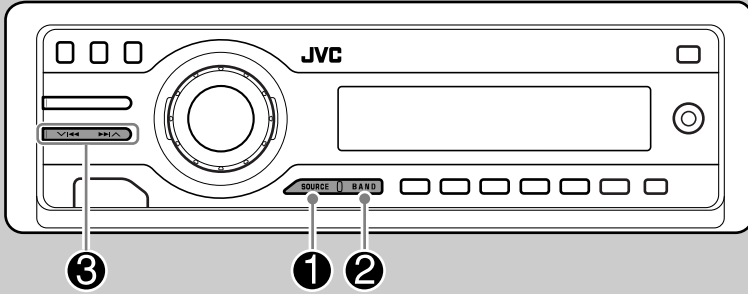

Selected band appears.

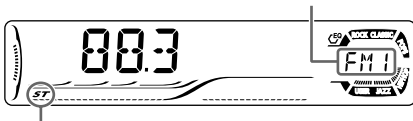

Lights up when receiving an FM stereo broadcast with sufficient signal strength.

**3** Start searching for a station.



When a station is received, searching stops.

**To stop searching**, press the same button again.

### To tune in to a station manually

In step **3** on the left...



**2** Select the desired station frequencies.

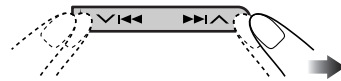

## When an FM stereo broadcast is hard to receive

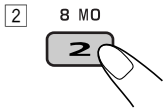
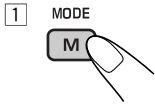

Lights up when monaural mode is activated.

Reception improves, but stereo effect will be lost.

To restore the stereo effect, repeat the same procedure. "MONO OFF" appears and the MO indicator goes off.

## Storing stations in memory

You can preset six stations for each band.

### ■ FM station automatic presetting—SSM (Strong-station Sequential Memory)

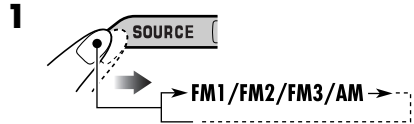

2 Select the FM band (FM1 – FM3) you want to store into.

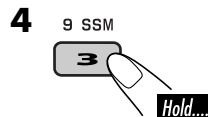
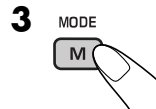
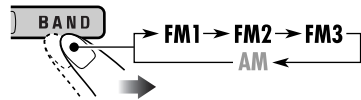

"SSM" flashes, then disappears when automatic presetting is over.

Local FM stations with the strongest signals are searched and stored automatically in the FM band.

## Manual presetting

Ex.: Storing FM station of 92.5 MHz into the preset number 4 of the FM1 band.

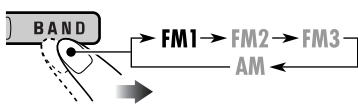
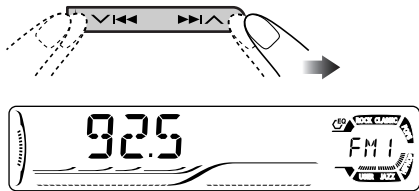
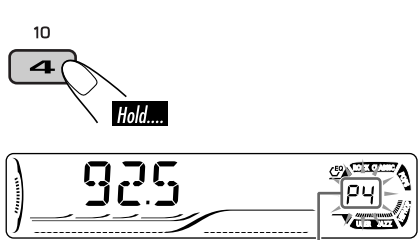
- 1 
  - 2 
  - 3 
  - 4 
- Preset number flashes for a while.

## Listening to a preset station

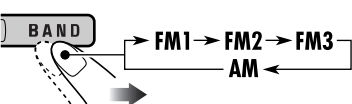
- 1 
- 2 
- 3 Select the preset station (1 – 6) you want.
 

|   |      |       |    |        |        |
|---|------|-------|----|--------|--------|
| 7 | 8 MO | 9 SSM | 10 | 11 RPT | 12 RND |
| 1 | 2    | 3     | 4  | 5      | 6      |

or



### To check the current clock time while listening to an FM or AM station

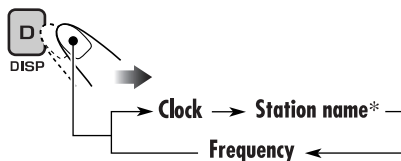

\* Only for KD-G614: If no title is assigned to a station, "NO NAME" appears. To assign a title to a station, see page 22.

# Disc operations

## Playing a disc in the receiver

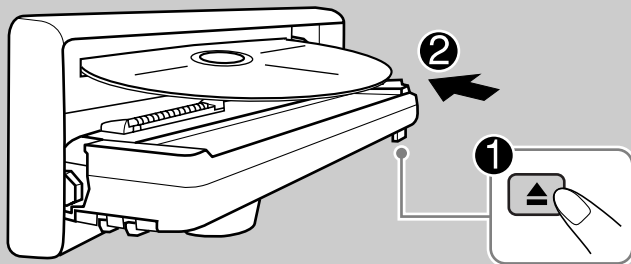

All tracks will be played repeatedly until you change the source or eject the disc.

### About MP3 and WMA discs

MP3 and WMA (Windows Media® Audio) “tracks” (words “file” and “track” are used interchangeably) are recorded in “folders.”

- When inserting an MP3 or a WMA disc:



Total folder number      Total track number



\*1

Disc information appears automatically (see page 16).

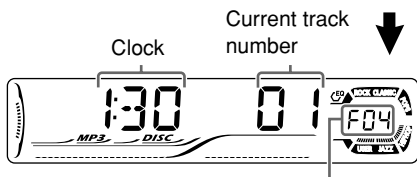

Selected folder number

\*1 Either the MP3 or WMA indicator lights up depending on the detected file.

- When inserting an audio CD or a CD Text disc:

Total playing time of the inserted disc      Total track number of the inserted disc



CD Text: Disc title/performer →  
Track title appears automatically (see page 16).

Clock\*2      Current track number

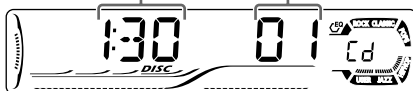

\*2 Elapsed playing time appears for a while if the current disc is an audio CD.

### To stop play and eject the disc



# Playing discs in the CD changer

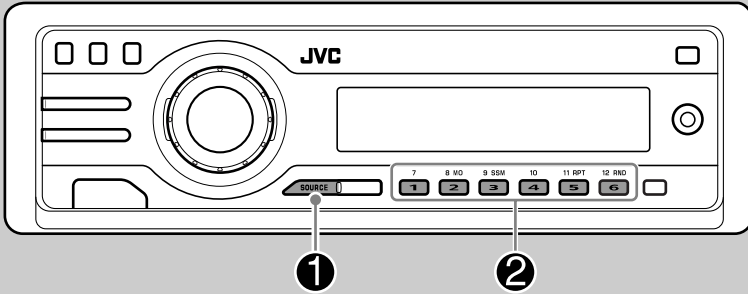

## About the CD changer

It is recommended to use the JVC MP3-compatible CD changer with your receiver.

- You can also connect other CH-X series CD changers (except CH-X99 and CH-X100). However, they are not compatible with MP3 discs, so you cannot play back MP3 discs.
- You cannot use the KD-MK series CD changers with this receiver.
- Disc text information recorded in the CD Text can be displayed when a JVC CD Text compatible CD changer is connected.

Before operating your CD changer:

- Refer also to the Instructions supplied with your CD changer.
- You cannot control and play any WMA disc in the CD changer.

1

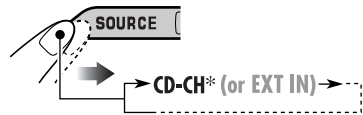

\* If you have changed "EXT IN" setting to "EXT IN" (see page 21), you cannot select the CD changer.

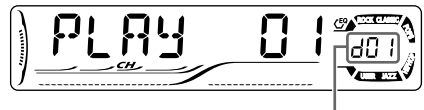

Selected disc number

2

## Select a disc.

For disc number from 01 – 06:



For disc number from 07 – 12:



All tracks of the inserted discs in the magazine will be played repeatedly until you change the source or eject the magazine from the CD changer.

- When the current disc is an MP3 disc:



Folder name\*1



Selected folder number

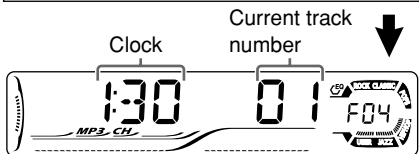
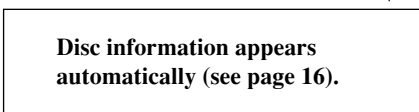

\*1 "ROOT" appears if no folder is included in the disc.

- When the current disc is an audio CD or a CD Text disc:

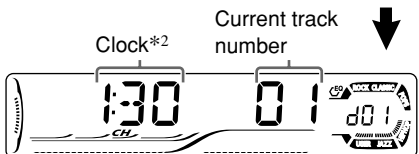
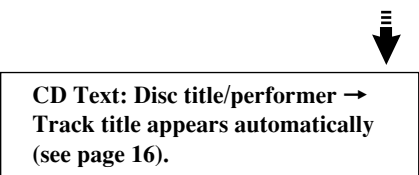

\*2 Elapsed playing time appears for a while if the current disc is an audio CD.

### To fast-forward or reverse the track

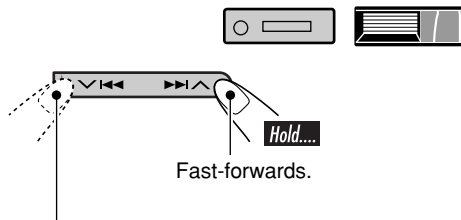

Reverses.

### To go to the next or previous tracks

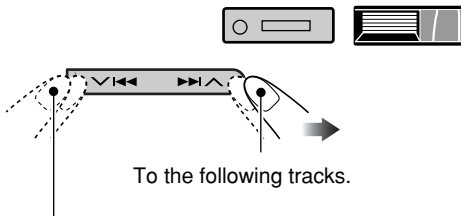

To the beginning of the current track, then the previous tracks.

### To go to the next or previous folders (only for MP3 or WMA discs)



For MP3 discs:

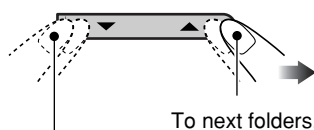

To previous folders.

## To locate a particular track (for CD) or folder (for MP3 or WMA discs) directly

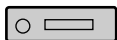

To select a number from 01 – 06:



To select a number from 07 – 12:



- To use folder search on MP3/WMA discs, it is required that folders are assigned with 2-digit numbers at the beginning of their folder names—01, 02, 03, and so on.

- To select a particular track in a folder (for MP3 or WMA disc) after selecting a folder:

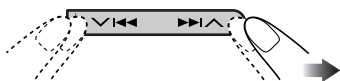

## Other main functions

### ■ Skipping a track quickly during play



- For MP3 or WMA disc, you can skip a track within the same folder.

Ex.: To select track 32 while playing track 6

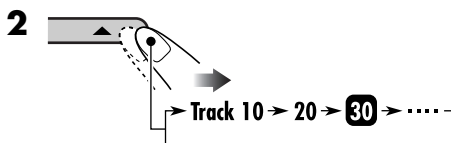
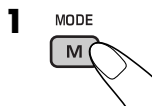

First time you press +10 or -10 button, the track skips to the nearest higher or lower track with a track number of multiple ten (ex. 10th, 20th, 30th).

Then each time you press the button, you can skip 10 tracks.

- After the last track, the first track will be selected and vice versa.

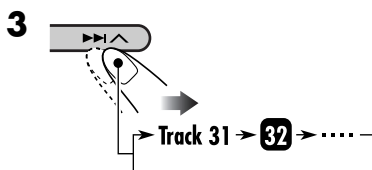

### ■ Prohibiting disc ejection

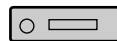

You can lock a disc in the loading slot.

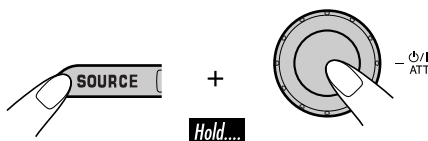

To cancel the prohibition, repeat the same procedure.

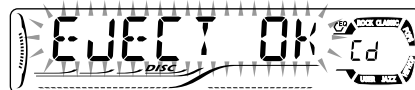

## Changing the display information



### ■ While playing an audio CD or a CD Text ( / )

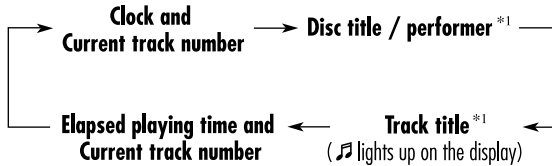

\*1 For KD-G614: If no title is assigned to an audio CD, "NO NAME" appears. To assign a title to an audio CD, see page 22.

For KD-G514: "NO NAME" appears.

### ■ While playing an MP3 ( / ) or WMA ( ) disc

- When "TAG DISP" is set to "TAG ON" (see page 21)

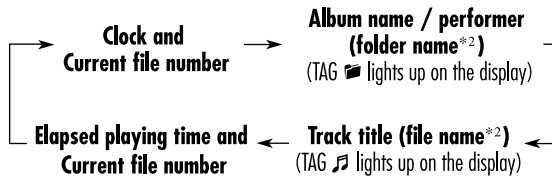

\*2 If an MP3/WMA file does not have ID3 tags, folder name and file name appear. In this case, the TAG indicator will not light up.

- When "TAG DISP" is set to "TAG OFF"

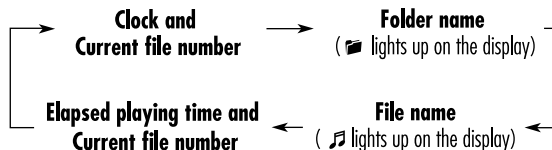



# Selecting the playback modes

You can use only one of the following playback modes at a time.

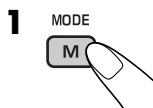

## 2 Select your desired playback mode.

### Repeat play

11 RPT



Ex.: When "TRK RPT" is selected while playing an MP3 disc in the receiver

### Mode

### Plays repeatedly

- TRK RPT** : The current track.
  - RPT lights up.
- FLDR RPT**\*1 : All tracks of the current folder.
  - and RPT light up.
- DISC RPT**\*2 : All tracks of the current disc.
  - and RPT light up.
- RPT OFF** : Cancels.

### Random play

12 RND



Ex.: When "DISC RND" is selected while playing an MP3 disc in the receiver

### Mode

### Plays at random

- FLDR RND**\*1 : All tracks of the current folder, then tracks of the next folder and so on.
  - RND and light up.
- DISC RND** : All tracks of the current disc.
  - RND and light up.
- MAG RND**\*2 : All tracks of the inserted discs.
  - RND lights up.
- RND OFF** : Cancels.

\*1 Only while playing an MP3 ( / ) or WMA ( ) disc.

\*2 Only while playing discs in the CD changer ( ).

# Sound adjustments

## Selecting preset sound modes (C-EQ: custom equalizer)

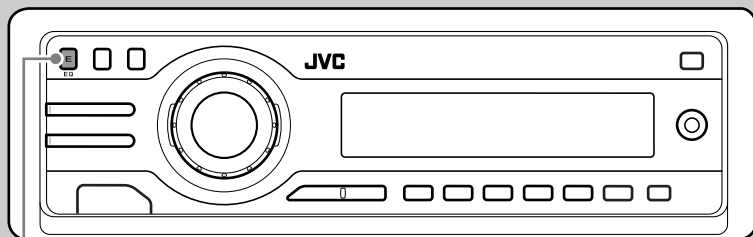

You can select a preset sound mode suitable to the music genre.

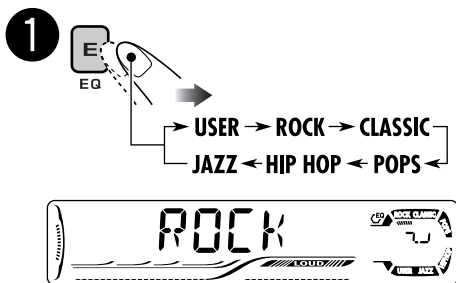

Ex.: When "ROCK" is selected

Indication pattern for each sound mode:

| USER    | ROCK    |
|---------|---------|
|         |         |
| JAZZ    | CLASSIC |
|         |         |
| HIP HOP | POPS    |
|         |         |

| Indication | For:                | Preset values     |                   |                    |
|------------|---------------------|-------------------|-------------------|--------------------|
|            |                     | BAS <sup>*1</sup> | TRE <sup>*2</sup> | LOUD <sup>*3</sup> |
| USER       | (Flat sound)        | 00                | 00                | OFF                |
| ROCK       | Rock or disco music | +03               | +01               | ON                 |
| CLASSIC    | Classical music     | +01               | -02               | OFF                |
| POPS       | Light music         | +04               | +01               | OFF                |
| HIP HOP    | Funk or rap music   | +02               | 00                | ON                 |
| JAZZ       | Jazz music          | +02               | +03               | OFF                |

\*1 BAS: Bass

\*2 TRE: Treble

\*3 LOUD: Loudness

## Adjusting the sound

You can adjust the sound characteristics to your preference.

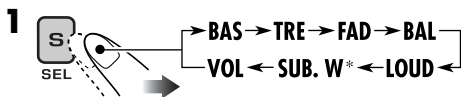

\* Only for KD-G614.



Ex.: When "TRE" is selected

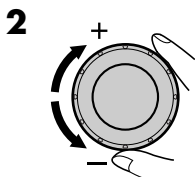

Indication pattern changes as you adjust the level.

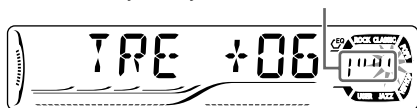

| Indication                          | To do:   | Range  |
|-------------------------------------|--|--|
| BAS* <sup>1</sup><br>(bass)         | Adjust the bass.   | -06 (min.)<br>to<br>+06 (max.)                   |
| TRE* <sup>1</sup><br>(treble)       | Adjust the treble.   | -06 (min.)<br>to<br>+06 (max.)                   |
| FAD* <sup>2</sup><br>(fader)        | Adjust the front and rear speaker balance.   | R06<br>(Rear only)<br>to<br>F06<br>(Front only)  |
| BAL<br>(balance)                    | Adjust the left and right speaker balance.   | L06<br>(Left only)<br>to<br>R06<br>(Right only)  |
| LOUD* <sup>1</sup><br>(loudness)    | Boost low and high frequencies to produce a well-balanced sound at low volume level. | LOUD ON<br>↓<br>LOUD OFF                         |
| SUB. W* <sup>3</sup><br>(subwoofer) | Adjust the subwoofer output level.   | 00 (min.) to<br>08 (max.)                        |
| VOL* <sup>4</sup><br>(volume)       | Adjust the volume.   | 00 (min.) to<br>30 or 50<br>(max.)* <sup>5</sup> |

\*<sup>1</sup> When you adjust the bass, treble, or loudness, the adjustment you have made is stored for the currently selected sound mode (C-EQ) including "USER."

\*<sup>2</sup> If you are using a two-speaker system, set the fader level to "00."

\*<sup>3</sup> Only for KD-G614: This takes effect only when a subwoofer is connected.

\*<sup>4</sup> Normally the control dial works as the volume control. So you do not have to select "VOL" to adjust the volume level.

\*<sup>5</sup> Depending on the amplifier gain control setting. (See page 21 for details.)

# General settings — PSM

## Basic procedure

You can change PSM (Preferred Setting Mode) items listed in the table that follows.



**2** Select a PSM item.

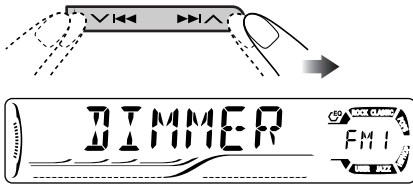

Ex.: When you select "DIMMER"

**3** Adjust the PSM item selected.

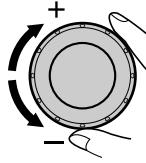

**4** Repeat steps 2 and 3 to adjust the other PSM items if necessary.

**5** Finish the procedure.



| Indications                          | Selectable settings, [reference page]  |
|--------------------------------------|--|
| <b>DEMO</b><br>Display demonstration | <b>DEMO ON</b> : [Initial]; Display demonstration will be activated automatically if no operation is done for about 20 seconds, [8].<br><b>DEMO OFF</b> : Cancels. |
| <b>CLOCK H</b><br>Hour adjustment    | 1 – 12, [8]<br>[Initial: 1 (1:00)]   |
| <b>CLOCK M</b><br>Minute adjustment  | 00 – 59, [8]<br>[Initial: 00 (1:00)]   |
| <b>LEVEL</b><br>Audio level meter    | <b>ON</b> : [Initial]; Activates the audio level indicator.<br><b>OFF</b> : Cancels; sound mode indicator is shown, [18].  |
| <b>DIMMER</b><br>Dimmer              | <b>AUTO</b> : [Initial]; Dims the display when you turn on the headlights.<br><b>ON</b> : Activates dimmer.<br><b>OFF</b> : Cancels.                               |

| Indications   | Selectable settings, [reference page]  |
|---|--|
| <b>TEL</b> *1<br>Telephone muting                     | <b>MUTING 1/MUTING 2</b> : Select either one which mutes the sounds while using the cellular phone.<br><b>OFF</b> : [Initial]; Cancels.  |
| <b>SCROLL</b> *2<br>Scroll                            | <b>ONCE</b> : [Initial]; Scrolls the disc information once.<br><b>AUTO</b> : Repeats scrolling (5-second intervals in between).<br><b>OFF</b> : Cancels.<br>• Pressing D DISP for more than one second can scroll the display regardless of the setting.     |
| <b>WOOFER</b> *1<br>Subwoofer cutoff frequency        | <b>LOW</b> : Frequencies lower than 55 Hz are send to the subwoofer.<br><b>MID</b> : [Initial]; Frequencies lower than 85 Hz are send to the subwoofer.<br><b>HIGH</b> : Frequencies lower than 115 Hz are send to the subwoofer.                            |
| <b>EXT IN</b> *3<br>External input                    | <b>CHANGER</b> : [Initial]; To use a JVC CD changer, [13].<br><b>EXT IN</b> : To use another external component, [24].   |
| <b>AUX ADJ</b> *1<br>Auxiliary input level adjustment | <b>A.ADJ 00 – A.ADJ 05</b> : Adjust the auxiliary input level accordingly, to avoid the sudden increase of the output level when changing the source from external component connected to the AUX input jack on the control panel.<br>[Initial: A.ADJ 00]    |
| <b>TAG DISP</b><br>Tag display                        | <b>TAG ON</b> : [Initial]; Shows the ID3 tag while playing MP3/WMA tracks, [16].<br><b>TAG OFF</b> : Cancels.  |
| <b>AMP GAIN</b><br>Amplifier gain control             | You can change the maximum volume level of this receiver.<br><b>LOW PWR</b> : VOL 00 – VOL 30 (Select this if the maximum power of the speaker is less than 50 W to prevent them from damaging the speaker.)<br><b>HIGH PWR</b> : [Initial]; VOL 00 – VOL 50 |

\*1 Only for KD-G614.

\*2 Some characters or symbols will not be shown (and will be blanked) or substituted on the display (Ex. "ABC&!d#" ⇒ "ABCA D ").

\*3 Displayed only when one of the following sources is selected—FM, AM, CD, or (AUX IN: only for KD-G614).

# Other main functions

## Assigning titles to the sources

This section is only for KD-G614.

You can assign titles to station frequencies and CDs (both in this receiver and in the CD changer).

| Sources     | Maximum number of characters   |
|-------------|--|
| FM/AM tuner | Up to 8 characters (up to 30 station frequencies including both FM and AM) |
| CDs/CD-CH   | Up to 32 characters (up to 30 discs)                                       |

\* You cannot assign a title to a CD Text or an MP3/WMA disc.

### 1 Select the sources.

- For FM/AM tuner: Tune in to a station.
- For a CD in this receiver: Insert a CD.
- For CDs in the CD changer: Select "CD-CH," then select a disc number.

### 2 Enter the title assignment mode.

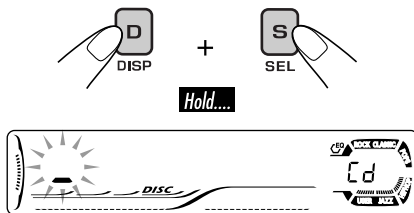

Ex.: When you select CD as the source

### 3 Assign a title.

- 1 Select a character.

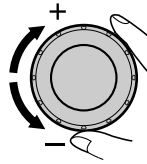

|   |   |   |   |   |   |   |   |   |   |   |   |       |   |
|---|---|---|---|---|---|---|---|---|---|---|---|-------|---|
| A | B | C | D | E | F | G | H | I | J | K | L | M     | N |
| O | P | Q | R | S | T | U | V | W | X | Y | Z | 0     | 1 |
| 2 | 3 | 4 | 5 | 6 | 7 | 8 | 9 | - | / | < | > | space |   |

- 2 Move to the next (or previous) character position.



- 3 Repeat steps 1 and 2 until you finish entering the title.

### 4 Finish the procedure.



### To erase the entire title

In step 2 on the left...

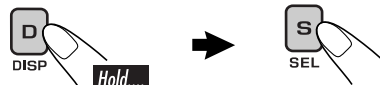

## Detaching the control panel

When detaching or attaching the control panel, be careful not to damage the connectors on the back of the control panel and on the panel holder.

### ■ Detaching the control panel

Before detaching the control panel, be sure to turn off the power.

1

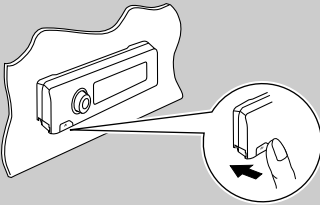

2

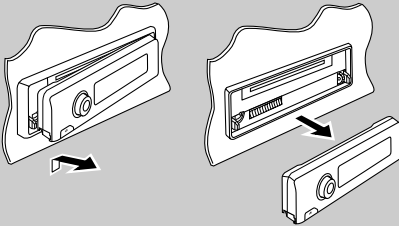

3

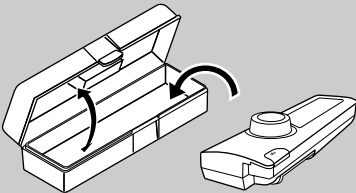

## ■ Attaching the control panel

1

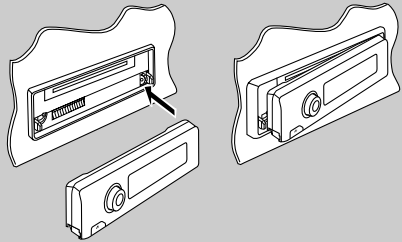

2

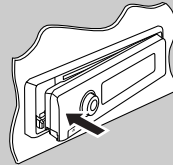

# External component operations

## Playing an external component

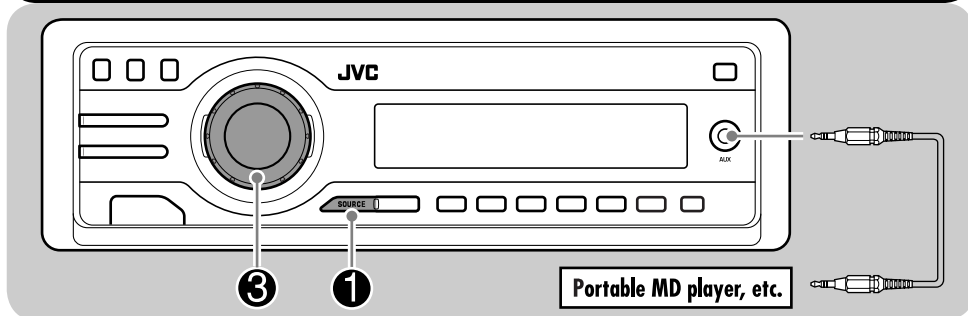

### **For KD-G614:**

You can connect an external component to the CD changer jack on the rear using the Line Input Adapter KS-U57 (not supplied), and another to the AUX (auxiliary) input jack on the control panel.

### **For KD-G514:**

You can connect an external component to the CD changer jack on the rear using the Line Input Adapter KS-U57 (not supplied).

- For connection, see Installation/Connection Manual (separate volume).

### **1 For KD-G614:**

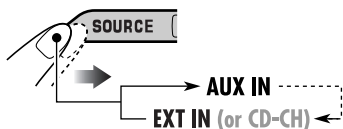

AUX IN : For selecting the external component connected to the AUX input jack.

EXT IN : For selecting the external component connected to the CD changer jack on the rear using KS-U57.

If “EXT IN” does not appear, see page 21 and select the external input (EXT IN).

### **For KD-G514:**

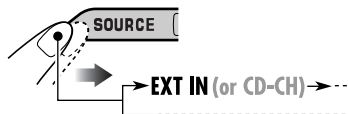

- If “EXT IN” does not appear, see page 21 and select the external input (EXT IN).

### **2 Turn on the connected component and start playing the source.**

### **3 Adjust the volume.**

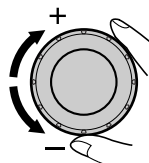

### **4 Adjust the sound as you want. (See pages 18 and 19.)**



# Maintenance

## How to clean the connectors

Frequent detachment will deteriorate the connectors.

To minimize this possibility, periodically wipe the connectors with a cotton swab or cloth moistened with alcohol, being careful not to damage the connectors.

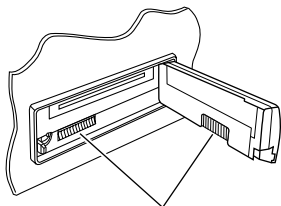

Connector

## Moisture condensation

Moisture may condense on the lens inside the CD player in the following cases:

- After starting the heater in the car.
- If it becomes very humid inside the car.

Should this occur, the CD player may malfunction. In this case, eject the disc and leave the receiver turned on for a few hours until the moisture evaporates.

## How to handle discs

**When removing a disc from its case,** press down the center holder of the case and lift the disc out, holding it by the edges.

Center holder



- Always hold the disc by the edges. Do not touch its recording surface.

**When storing a disc into its case,** gently insert the disc around the center holder (with the printed surface facing up).

- Make sure to store discs into the cases after use.

## To keep discs clean

A dirty disc may not play correctly.

If a disc does become dirty, wipe it with a soft cloth in a straight line from center to edge.



- Do not use any solvent (for example, conventional record cleaner, spray, thinner, benzene, etc.) to clean discs.

## To play new discs

New discs may have some rough spots around the inner and outer edges. If such a disc is used, this receiver may reject the disc.



To remove these rough spots, rub the edges with a pencil or ball-point pen, etc.

### Do not use the following discs:

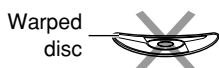

# More about this receiver

## Basic operations

### Turning on the power

- By pressing SOURCE on the receiver, you can also turn on the power.

### Turning off the power

- If you turn off the power while listening to a disc, disc play will start from where playback has been stopped previously, next time you turn on the power.

### Selecting the sources

- When no disc is loaded in the receiver, “CD” cannot be selected.
- Without connecting to the CD changer, “CD-CH” cannot be selected.

## Tuner operations

### Storing stations in memory

- During SSM search...
  - All previously stored stations are erased and stations are stored newly.
  - Received stations are preset in No. 1 (lowest frequency) to No. 6 (highest frequency).
  - When SSM is over, the station stored in No. 1 will be automatically tuned in.
- When storing a station manually, a previously preset station is erased when a new station is stored in the same preset number.

## Disc operations

### Caution for DualDisc playback

- The Non-DVD side of a “DualDisc” does not comply with the “Compact Disc Digital Audio” standard. Therefore, the use of Non-DVD side of a DualDisc on this product may not be recommended.

### General

- This receiver has been designed to reproduce CDs/CD Texts, and CD-Rs (Recordable)/CD-RWs (Rewritable) in audio CD (CD-DA), MP3 and WMA format.
- When a disc has been loaded, selecting “CD” for the playback source starts disc play.

## Inserting a disc

- When a disc is inserted upside down, “PLEASE” and “EJECT” appear alternately on the display. Press ▲ to eject the disc.
- Do not insert 8 cm discs (single CD) and unusual shape discs (heart, flower, etc.) into the loading slot.

## Playing a disc

- While fast-forwarding or reversing on an MP3 or WMA disc, you can only hear intermittent sounds.

## Playing a CD-R or CD-RW

- Use only “finalized” CD-Rs or CD-RWs.
- This receiver can play back only the files of the same type which is first detected if a disc includes both audio CD (CD-DA) files and MP3/WMA files.
- This receiver can play back multi-session discs; however, unclosed sessions will be skipped while playing.
- Some CD-Rs or CD-RWs may not play back on this receiver because of their disc characteristics, and for the following causes:
  - Discs are dirty or scratched.
  - Moisture condensation occurs on the lens inside the receiver.
  - The pickup lens inside the receiver is dirty.
  - CD-R/CD-RW on which the files are written with “Packet Write” method.
  - There are improper recording conditions (missing data, etc.) or media conditions (stain, scratch, warp, etc.).
- CD-RWs may require a longer readout time since the reflectance of CD-RWs is lower than that of regular CDs.
- Do not use the following CD-Rs or CD-RWs:
  - Discs with stickers, labels, or protective seal stuck to the surface.
  - Discs on which labels can be directly printed by an ink jet printer.Using these discs under high temperatures or high humidities may cause malfunctions or damages to discs.

## **Playing an MP3/WMA disc**

- This receiver can play back MP3/WMA files with the extension code <.mp3> or <.wma> (regardless of the letter case—upper/lower).
- This receiver can show the names of albums, artists (performer), and ID3 Tag (Version 1.0, 1.1, 2.2, 2.3, or 2.4) for MP3 files and for WMA files.
- This receiver can display only one-byte characters. No other characters can be correctly displayed.
- This receiver can play back MP3/WMA files meeting the conditions below:
  - Bit rate: 8 kbps — 320 kbps
  - Sampling frequency:
    - 48 kHz, 44.1 kHz, 32 kHz (for MPEG-1)
    - 24 kHz, 22.05 kHz, 16 kHz (for MPEG-2)
  - Disc format: ISO 9660 Level 1/ Level 2, Romeo, Joliet, Windows long file name
- The maximum number of characters for file/folder names vary among the disc format used (includes 4 extension characters—<.mp3> or <.wma>).
  - ISO 9660 Level 1: up to 12 characters
  - ISO 9660 Level 2: up to 31 characters
  - Romeo\*: up to 128 (72) characters
  - Joliet\*: up to 64 (36) characters
  - Windows long file name\*: up to 128 (72) characters

\* *The parenthetic figure is the maximum number of characters for file/folder names in case the total number of files and folders is 313 or more.*
- This receiver can recognize the total of 512 files, of 200 folders, and of 8 hierarchies.
- This receiver can play back the files recorded in VBR (variable bit rate).

The files recorded in VBR have a discrepancy in elapsed time display, and do not show the actual elapsed time. Especially, after performing the search function, this difference becomes noticeable.
- This receiver cannot play back the following files:
  - MP3 files encoded with MP3i and MP3 PRO format.

- MP3 files encoded in an unappropriated format.
  - MP3 files encoded with Layer 1/2.
  - WMA files encoded with lossless, professional, and voice format.
  - WMA files which are not based upon Windows Media® Audio.
  - WMA files copy-protected with DRM.
  - Files which have the data such as WAVE, ATRAC3, etc.
- The search function works but search speed is not constant.

## **Changing the source**

- If you change the source, playback also stops (without ejecting the disc).

Next time you select “CD” for the playback source, disc play starts from where it has been stopped previously.

## **Ejecting a disc**

- If the ejected disc is not removed within 15 seconds, the disc is automatically inserted again into the loading slot to prevent it from dust. (Disc will not play this time.)

## **General settings—PSM**

- If you change the “AMP GAIN” setting from “HIGH PWR” to “LOW PWR” while the volume level is set higher than “VOL 30,” the receiver automatically changes the volume level to “VOL 30.”

## **Other main functions (only for KD-G614)**

- If you try to assign a title to a 31st disc or to the 31st station frequency, “NAMEFULL” flashes on the display. Delete unwanted titles before assignment.
- Titles assigned to discs in the CD changer can also be shown if you playback the disc from the receiver.

# Troubleshooting

What appears to be trouble is not always serious. Check the following points before calling a service center.

|                                     | Symptoms   | Causes  | Remedies   |
|-------------------------------------|--|---|--|
| General                             | • Sound cannot be heard from the speakers.   | The volume level is set to the minimum level.                                 | Adjust it to the optimum level.  |
|                                     |  | Connections are incorrect.  | Check the cords and connections.   |
|                                     | • The receiver does not work at all.   | The built-in microcomputer may have functioned incorrectly due to noise, etc. | Reset the receiver (see page 2).   |
| FM/AM                               | • SSM automatic presetting does not work.  | Signals are too weak.   | Store stations manually.   |
|                                     | • Static noise while listening to the radio.   | The antenna is not connected firmly.  | Connect the antenna firmly.  |
| Disc playback                       | • Disc cannot be played back.  | Disc is inserted upside down.   | Insert the disc correctly.   |
|                                     | • CD-R/CD-RW cannot be played back.<br>• Tracks on the CD-R/CD-RW cannot be skipped. | CD-R/CD-RW is not finalized.  | • Insert a finalized CD-R/CD-RW.<br>• Finalize the CD-R/CD-RW with the component which you used for recording. |
|                                     | • Disc can be neither played back nor ejected.                                       | Disc is locked.   | Unlock the disc (see page 15).   |
|                                     |  | The CD player may have functioned incorrectly.                                | Eject the disc forcibly (see page 2).  |
|                                     | • Disc sound is sometimes interrupted.   | You are driving on rough roads.   | Stop playback while driving on rough roads.  |
|                                     |  | Disc is scratched.  | Change the disc.   |
|                                     |  | Connections are incorrect.  | Check the cords and connections.   |
| • “NO DISC” appears on the display. | Disc is inserted incorrectly.  | Insert the disc correctly.  |  |

|   | Symptoms   | Causes  | Remedies   |
|---|--|---|--|
| MP3/WMA playback  | <ul style="list-style-type: none"> <li>Disc cannot be played back.</li> </ul>  | No MP3/WMA tracks are recorded on the disc.   | Change the disc.   |
|   |  | MP3/WMA tracks do not have the extension code <.mp3> or <.wma> in their file names.                       | Add the extension code <.mp3> or <.wma> to their file names.   |
|   |  | MP3/WMA tracks are not recorded in the format compliant with ISO 9660 Level 1, Level 2, Romeo, or Joliet. | Change the disc. (Record MP3/WMA tracks using a compliant application.)  |
|   | <ul style="list-style-type: none"> <li>Noise is generated.</li> </ul>  | The track played back is not an MP3/WMA file (although it has the extension code <.mp3> or <.wma>).       | Skip to another track or change the disc. (Do not add the extension code <.mp3> or <.wma> to non-MP3 or WMA tracks.) |
|   | <ul style="list-style-type: none"> <li>A longer readout time is required (“CHECK” keeps flashing on the display).</li> </ul> | Readout time varies due to the complexity of the folder/file configuration.                               | Do not use too many hierarchies and folders.   |
|   | <ul style="list-style-type: none"> <li>Tracks cannot be played back as you have intended them to play.</li> </ul>            | Playback order is determined when the files are recorded.   | _____  |
|   | <ul style="list-style-type: none"> <li>Elapsed playing time is not correct.</li> </ul>                                       | This sometimes occurs during play. This is caused by how the tracks are recorded on the disc.             | _____  |
|   | <ul style="list-style-type: none"> <li>“NO FILES” appears on the display.</li> </ul>   | The current disc does not contain any MP3/WMA tracks.   | Insert a disc that contains MP3/WMA tracks.  |
| <ul style="list-style-type: none"> <li>Correct characters are not displayed (e.g. album name).</li> </ul> | This receiver can only display alphabets (capital: A – Z), numbers, and a limited number of symbols.                         | _____   |  |

|                   | Symptoms  | Causes  | Remedies  |
|-------------------|---|---|---|
| <b>CD changer</b> | <ul style="list-style-type: none"> <li>• “NO DISC” appears on the display.</li> </ul>             | <p>No disc is in the magazine.</p> <p>Disc is inserted upside down.</p>       | <p>Insert disc into the magazine.</p> <p>Insert disc correctly.</p>                                     |
|                   | <ul style="list-style-type: none"> <li>• “NO MAG” appears on the display.</li> </ul>              | <p>No magazine is loaded in the CD changer.</p>                               | <p>Insert the magazine.</p>   |
|                   | <ul style="list-style-type: none"> <li>• “RESET 8” appears on the display.</li> </ul>             | <p>This receiver is not connected to the CD changer correctly.</p>            | <p>Connect this receiver and the CD changer correctly and press the reset button of the CD changer.</p> |
|                   | <ul style="list-style-type: none"> <li>• “RESET 1” – “RESET 7” appears on the display.</li> </ul> | <p>_____</p>  | <p>Press the reset button of the CD changer.</p>  |
|                   | <ul style="list-style-type: none"> <li>• The CD changer does not work at all.</li> </ul>          | <p>The built-in microcomputer may function incorrectly due to noise, etc.</p> | <p>Reset the receiver (see page 2).</p>   |

# Specifications

## AUDIO AMPLIFIER SECTION

Maximum Power Output:

Front: 50 W per channel

Rear: 50 W per channel

Continuous Power Output (RMS):

Front: 19 W per channel into 4  $\Omega$ , 40 Hz to 20 000 Hz at no more than 0.8% total harmonic distortion.

Rear: 19 W per channel into 4  $\Omega$ , 40 Hz to 20 000 Hz at no more than 0.8% total harmonic distortion.

Load Impedance: 4  $\Omega$  (4  $\Omega$  to 8  $\Omega$  allowance)

Tone Control Range:

Bass:  $\pm 10$  dB at 100 Hz

Treble:  $\pm 10$  dB at 10 kHz

Frequency Response: 40 Hz to 20 000 Hz

Signal-to-Noise Ratio: 70 dB

Line-Out Level/Impedance:

2.5 V/20 k $\Omega$  load (full scale)

Output Impedance: 1 k $\Omega$

Subwoofer-Out Level/Impedance:

KD-G614:

2.0 V/20 k $\Omega$  load (full scale)

Other Terminals:

CD changer, SUBWOOFER (only for KD-G614)

## TUNER SECTION

Frequency Range:

FM: 87.5 MHz to 108.0 MHz

AM: 531 kHz to 1 602 kHz

### [FM Tuner]

Usable Sensitivity: 11.3 dBf (1.0  $\mu$ V/75  $\Omega$ )

50 dB Quieting Sensitivity:

16.3 dBf (1.8  $\mu$ V/75  $\Omega$ )

Alternate Channel Selectivity (400 kHz): 65 dB

Frequency Response: 40 Hz to 15 000 Hz

Stereo Separation: 35 dB

Capture Ratio: 1.5 dB

### [AM Tuner]

Sensitivity: 20  $\mu$ V

Selectivity: 35 dB

## CD PLAYER SECTION

Type: Compact disc player

Signal Detection System: Non-contact optical pickup (semiconductor laser)

Number of Channels: 2 channels (stereo)

Frequency Response: 5 Hz to 20 000 Hz

Dynamic Range: 96 dB

Signal-to-Noise Ratio: 98 dB

Wow and Flutter: Less than measurable limit

MP3 Decoding Format:

MPEG1/2 Audio Layer 3

Max. Bit Rate: 320 kbps

WMA (Windows Media<sup>®</sup> Audio) Decoding Format:

Max. Bit Rate: 192 kbps

## GENERAL

Power Requirement:

Operating Voltage:

DC 14.4 V (11 V to 16 V allowance)

Grounding System: Negative ground

Allowable Operating Temperature:

0°C to +40°C

Dimensions (W  $\times$  H  $\times$  D):

Installation Size (approx.):

182 mm  $\times$  52 mm  $\times$  150 mm

Panel Size (approx.):

188 mm  $\times$  58 mm  $\times$  11 mm

Mass (approx.):

1.5 kg (excluding accessories)

*Design and specifications are subject to change without notice.*

- Microsoft and Windows Media are either registered trademarks or trademarks of Microsoft Corporation in the United States and/or other countries.



**Having TROUBLE with operation?**

**Please reset your unit**

**Refer to page of How to reset your unit**

**JVC**





This receiver is designed to operate on 12 V DC, **NEGATIVE ground electrical systems**. If your vehicle does not have this system, a voltage inverter is required, which can be purchased at JVC car audio dealers.

### Parts list for installation and connection

The following parts are provided for this receiver. After checking them, please set them correctly.

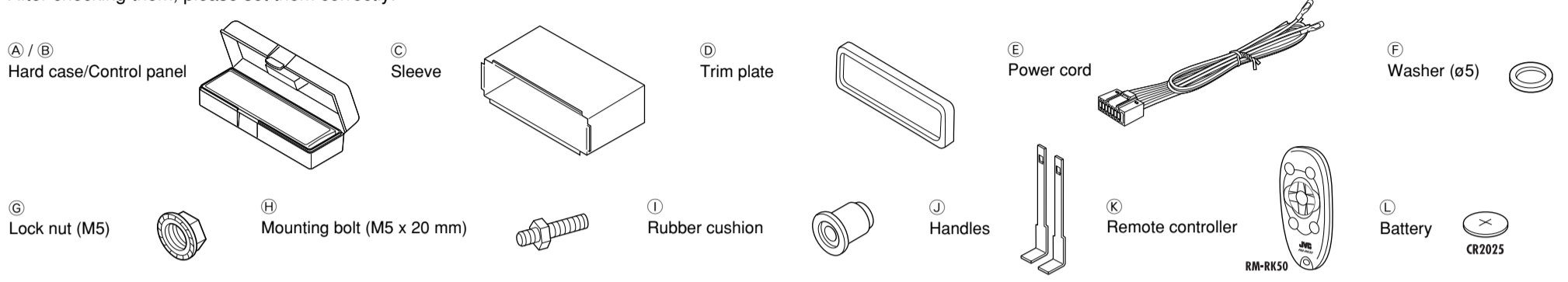

## INSTALLATION (IN-DASH MOUNTING)

The following illustration shows a typical installation. If you have any questions or require information regarding installation kits, consult your JVC car audio dealer or a company supplying kits.  
• If you are not sure how to install this receiver correctly, have it installed by a qualified technician.

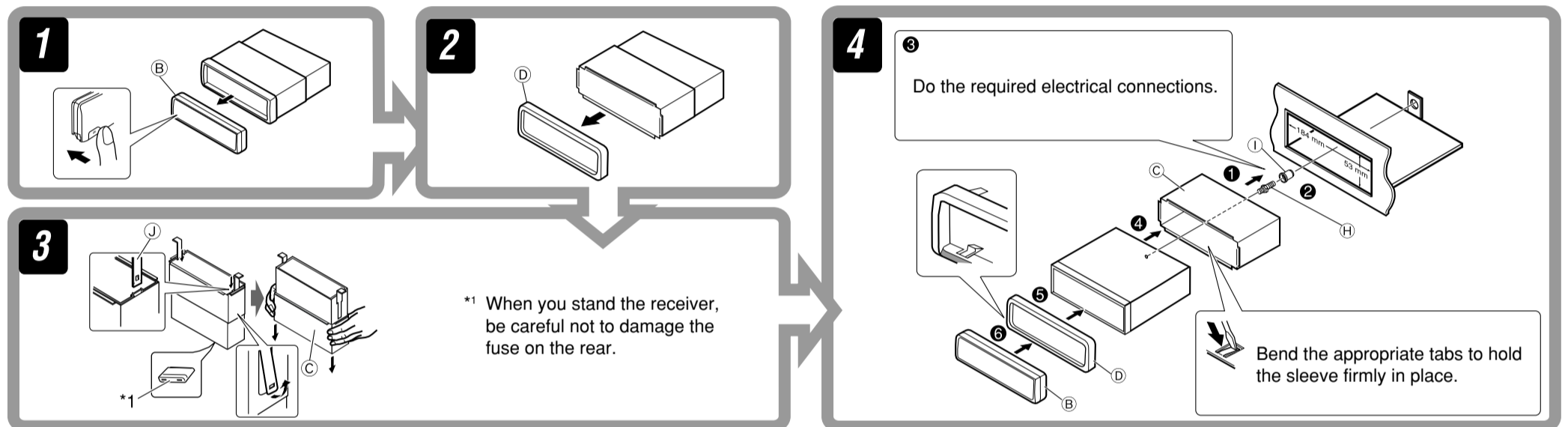

### Removing the receiver

Before removing the receiver, release the rear section.

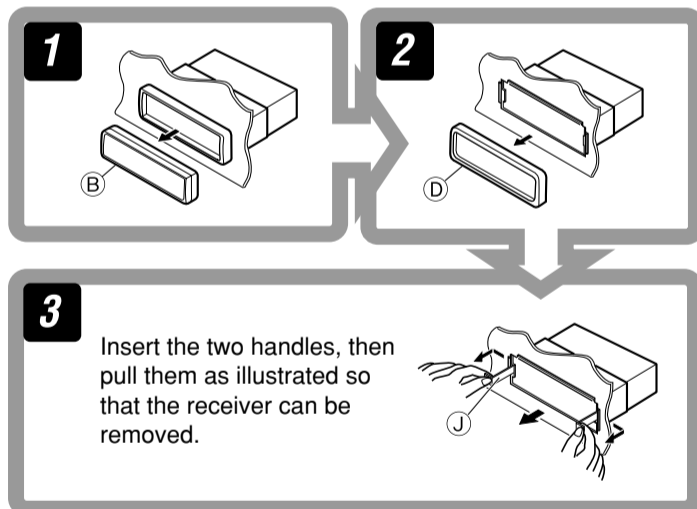

### When using the optional stay

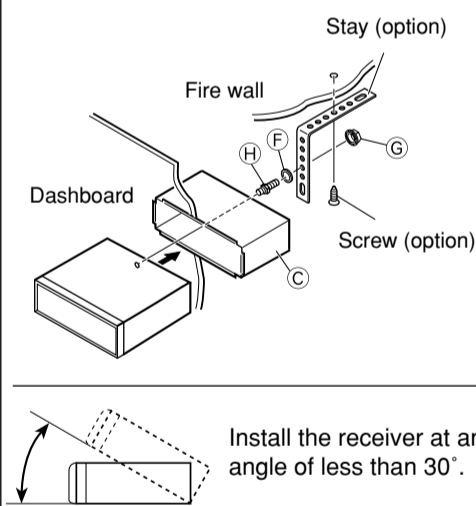

### When installing the receiver without using the sleeve

In a Toyota for example, first remove the car radio and install the receiver in its place.

\* Not included for this receiver.

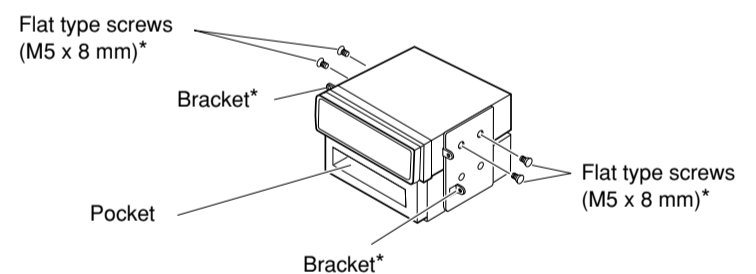

**Note** : When installing the receiver on the mounting bracket, make sure to use the 8 mm-long screws. If longer screws are used, they could damage the receiver.

### PRECAUTIONS on power supply and speaker connections:

- **DO NOT** connect the speaker leads of the power cord to the car battery; otherwise, the receiver will be seriously damaged.
- BEFORE connecting the speaker leads of the power cord to the speakers, check the speaker wiring in your car.

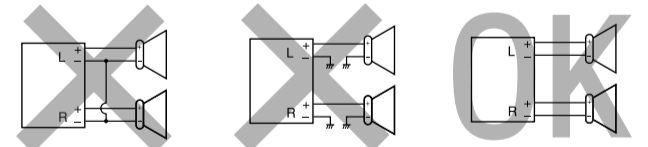

## TROUBLESHOOTING

- **The fuse blows.**  
\* Are the red and black leads connected correctly?
- **Power cannot be turned on.**  
\* Is the yellow lead connected?
- **No sound from the speakers.**  
\* Is the speaker output lead short-circuited?
- **Sound is distorted.**  
\* Is the speaker output lead grounded?  
\* Are the "-" terminals of L and R speakers grounded in common?
- **Noise interfere with sounds.**  
\* Is the rear ground terminal connected to the car's chassis using shorter and thicker cords?
- **Receiver becomes hot.**  
\* Is the speaker output lead grounded?  
\* Are the "-" terminals of L and R speakers grounded in common?
- **This receiver does not work at all.**  
\* Have you reset your receiver?

# ELECTRICAL CONNECTIONS

To prevent short circuits, we recommend that you disconnect the battery's negative terminal and make all electrical connections before installing the receiver.

- **Be sure to ground this receiver to the car's chassis again after installation.**

## Notes:

- Replace the fuse with one of the specified rating. If the fuse blows frequently, consult your JVC car audio dealer.
- It is recommended to connect to the speakers with maximum power of more than 50 W (both at the rear and at the front, with an impedance of **4 Ω to 8 Ω**). If the maximum power is less than 50 W, change "AMP GAIN" setting to prevent the speakers from being damaged (see page 21 of the INSTRUCTIONS).
- To prevent short-circuit, cover the terminals of the UNUSED leads with insulating tape.
- The heat sink becomes very hot after use. Be careful not to touch it when removing this receiver.

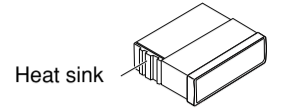

## A Typical Connections

**Before connecting:** Check the wiring in the vehicle carefully. Incorrect connection may cause serious damage to this receiver. The leads of the power cord and those of the connector from the car body may be different in color.

- 1 Connect the colored leads of the power cord in the order specified in the illustration below.
- 2 Connect the antenna cord.
- 3 Finally connect the wiring harness to the receiver.

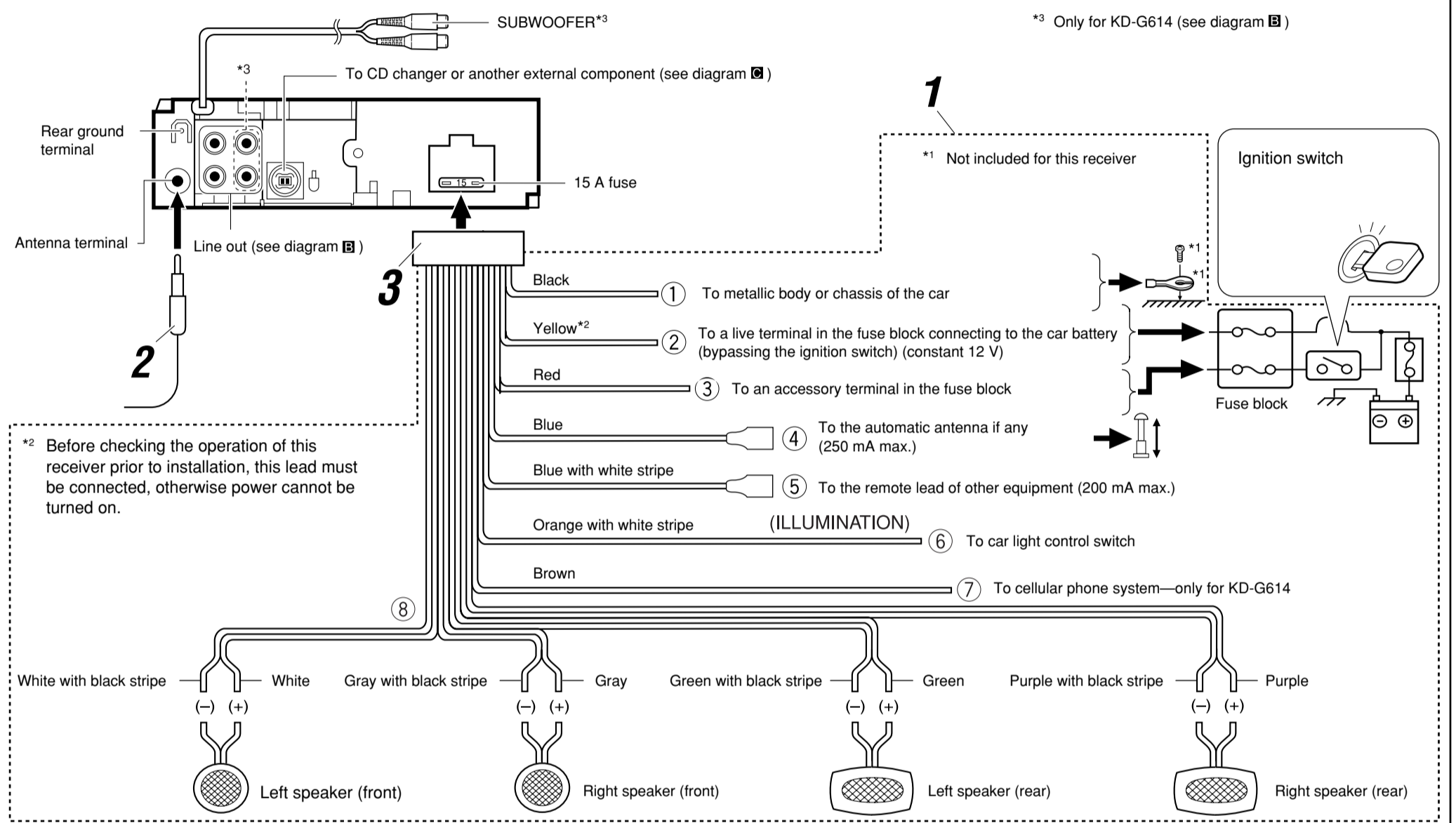

## B Connecting the external amplifiers

You can connect amplifiers to upgrade your car stereo system.

- Connect the remote lead (blue with white stripe) to the remote lead of the other equipment so that it can be controlled through this receiver.
- **Disconnect the speakers from this receiver, connect them to the amplifier. Leave the speaker leads of this receiver unused.**

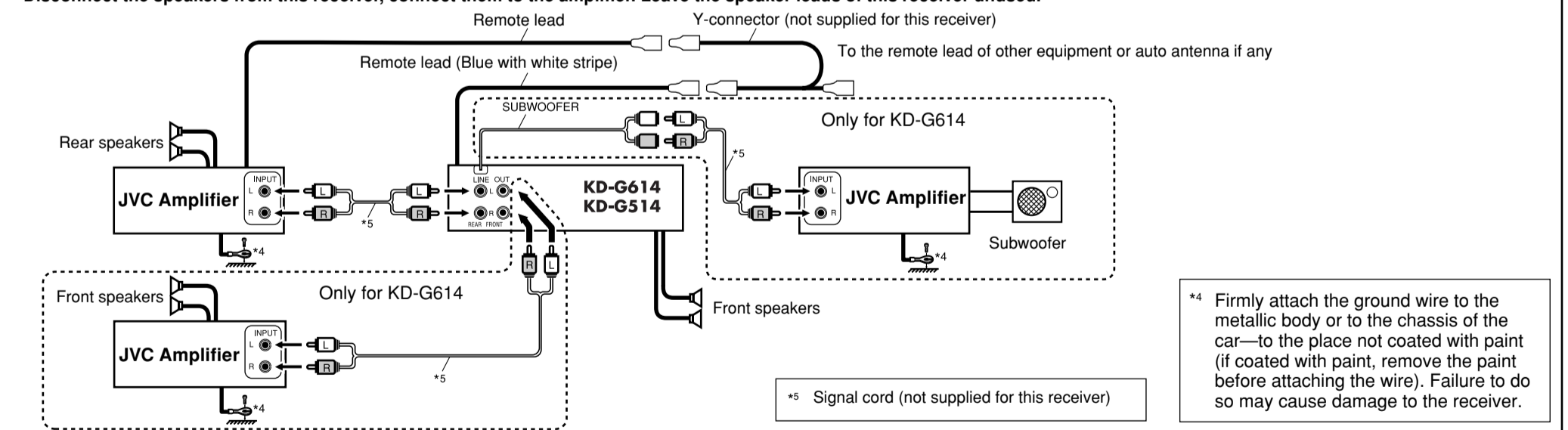

## C Connecting the external components

### CD changer

- Refer also to page 13 of the INSTRUCTIONS.

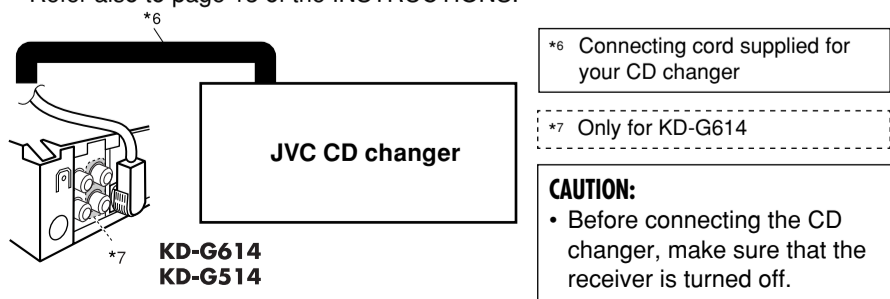

### External component

- Set "EXT IN" to "EXT IN" (See page 21 of the INSTRUCTIONS.)

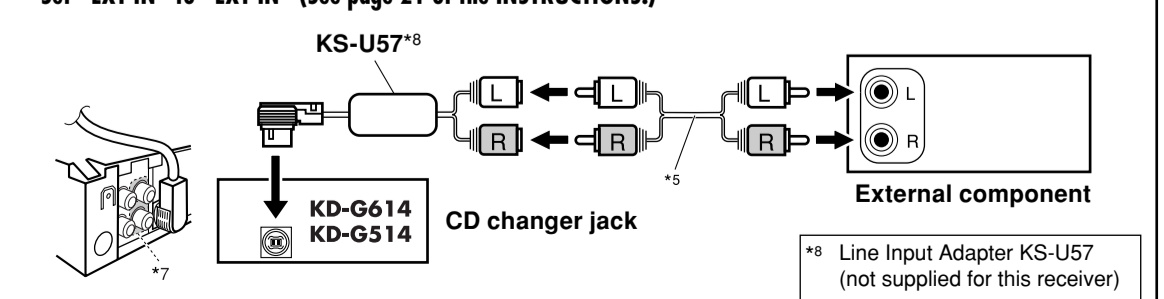

## Free Manuals Download Website

<http://myh66.com>

<http://usermanuals.us>

<http://www.somanuals.com>

<http://www.4manuals.cc>

<http://www.manual-lib.com>

<http://www.404manual.com>

<http://www.luxmanual.com>

<http://aubethermostatmanual.com>

Golf course search by state

<http://golfingnear.com>

Email search by domain

<http://emailbydomain.com>

Auto manuals search

<http://auto.somanuals.com>

TV manuals search

<http://tv.somanuals.com>