

# JVC

## KD-R418

### CD RECEIVER : INSTRUCTIONS/INSTALLATION



Thank you for purchasing a JVC product. Please read all instructions carefully before operation, to ensure your complete understanding and to obtain the best possible performance from the unit.

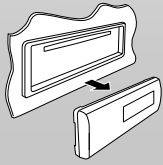

1009DTSMDTJEIN  
EN

© 2009 Victor Company of Japan, Limited

#### For customer Use:

Enter below the Model No. and Serial No. which are located on the top or bottom of the cabinet. Retain this information for future reference.

Model No. \_\_\_\_\_

Serial No. \_\_\_\_\_

GET0632-001A  
[J]

## Canceling the display demonstration

### 1 Turn on the power.



### 2 MENU [Hold]

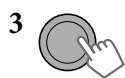

### 4 Select <DEMO OFF>.



### 6 Finish the procedure.



## Setting the clock

### 1 Turn on the power.



### 2 MENU [Hold]



### 3 Select <CLOCK>.



### 4 Select <CLOCK SET>.



### 5 Adjust the hour.



### 6 Adjust the minute.

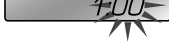

### 7 Finish the procedure.



## Preparations

### How to attach/detach the control panel

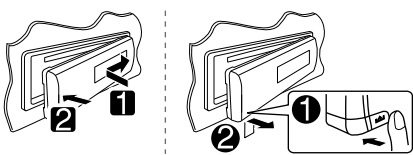

### How to reset your unit

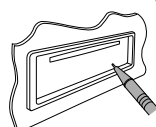

Reset the unit after installation is completed.  
• Your preset adjustments will also be erased.

If the effectiveness of the remote controller decreases, replace the battery.

### Replacing the lithium coin battery

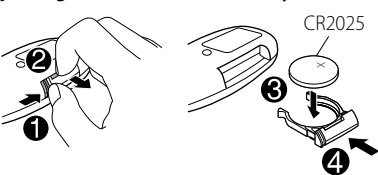

For USA-California Only:  
This product contains a CR Coin Cell Lithium Battery which contains Perchlorate Material—special handling may apply.  
See [www.dtsc.ca.gov/hazardouswaste/perchlorate](http://www.dtsc.ca.gov/hazardouswaste/perchlorate)

### Caution:

- Danger of explosion if battery is incorrectly replaced. Replace only with the same or equivalent type.
- Battery shall not be exposed to excessive heat such as sunshine, fire, or the like.

### Warning (about battery handling)

- To prevent accidents and damage:
- Do not install any battery other than CR2025 or its equivalent.
  - Store out of reach of children.
  - Do not recharge, short, or dismantle.
  - Do not dispose of in fire.
  - Do not carry around with other metallic materials.
  - Wrap the battery with tape and insulate when throwing away or saving it.

### Preparing the remote controller (RM-RK50)

When you use the remote controller for the first time, pull out the insulation sheet.

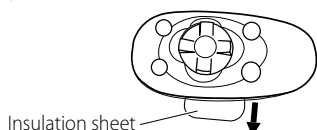

## INFORMATION (For U.S.A.)

This equipment has been tested and found to comply with the limits for a Class B digital device, pursuant to Part 15 of the FCC Rules. These limits are designed to provide reasonable protection against harmful interference in a residential installation. This equipment generates, uses, and can radiate radio frequency energy and, if not installed and used in accordance with the instructions, may cause harmful interference to radio communications. However, there is no guarantee that interference will not occur in a particular installation. If this equipment does cause harmful interference to radio or television reception, which can be determined by turning the equipment off and on, the user is encouraged to try to correct the interference by one or more of the following measures:

- Reorient or relocate the receiving antenna.
- Increase the separation between the equipment and receiver.
- Connect the equipment into an outlet on a circuit different from that to which the receiver is connected.
- Consult the dealer or an experienced radio/TV technician for help.

### Caution:

Changes or modifications not approved by JVC could void the user's authority to operate the equipment.

### IMPORTANT FOR LASER PRODUCTS

1. CLASS 1 LASER PRODUCT
2. **CAUTION:** Do not open the top cover. There are no user serviceable parts inside the unit; leave all servicing to qualified service personnel.
3. **CAUTION:** (For U.S.A.) Visible and/or invisible class II laser radiation when open. Do not stare into beam. (For Canada) Visible and/or invisible class 1M laser radiation when open. Do not view directly with optical instruments.
4. REPRODUCTION OF LABEL: CAUTION LABEL, PLACED OUTSIDE THE UNIT.

<b>CAUTION</b> VISIBLE AND/OR INVISIBLE CLASS 1M LASER RADIATION WHEN OPEN. DO NOT VIEW DIRECTLY WITH OPTICAL INSTRUMENTS. IEC00625-1:2001 (ENG)	<b>ATTENTION</b> RAYONNEMENT LASER VISIBLE ET/OU INVISIBLE DE CLASSE 1M UNE FOIS OUVERT NE PAS REGARDER DIRECTEMENT AVEC DES INSTRUMENTS OPTIQUES. (FRA)	<b>AVISO</b> RADIACION LASER DE CLASE 1M VISIBLE Y/O INVISIBLE CUANDO ESTA ABIERTO. NO MIRAR DIRECTAMENTE CON INSTRUMENTAL OPTICO. (SPA)	<b>VARNING</b> SYNLIG OCH/ELLER OSYNLIG LASERSTRÅLNING KLASS 1M, NÄR DENNA DEL ÄR ÖPPNAD. BETRAKTA EJ STRÅLEN MED OPTISKA INSTRUMENT. (SWE)	<b>注意</b> ここに警告と注意 及び安全上の事項 が記されています。 レーザー放射が 発生する 場合があります。 必ず、 直接見ないでください。 (JPN)	<b>CAUTION</b> VISIBLE AND/OR INVISIBLE CLASS II LASER RADIATION WHEN OPEN. DO NOT STARE INTO BEAM FDA 21 CFR (ENG)
--	--	--	--	--	---



[European Union only]

### For safety...

- Do not raise the volume level too much, as this will block outside sounds, making driving dangerous.
- Stop the car before performing any complicated operations.

### Warning:

If you need to operate the unit while driving, be sure to look around carefully or you may be involved in a traffic accident.

### Temperature inside the car...

If you have parked the car for a long time in hot or cold weather, wait until the temperature in the car becomes normal before operating the unit.

## Basic operations

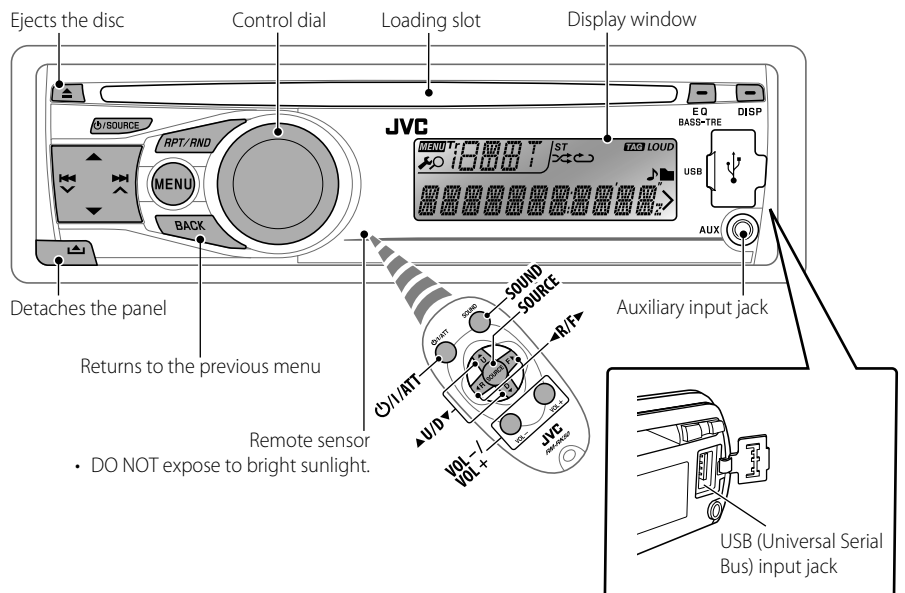

When you press or hold the following button(s)...

Main unit	Remote controller	General operations
		Turns on. • When the power is on, pressing  on the remote controller also attenuates the sound or pauses. Press  again to cancel muting or resume playback.
		Turns off if pressed and held. Selects the available sources (if the power is turned on). • If the source is ready, playback also starts.
		Adjusts the volume level.
	—	Selects items.
	—	• Mutes the sound while listening to a source. If the source is "CD" or "USB," playback pauses. Press the control dial again to cancel muting or resume playback. • Confirms selection.
		Selects the sound mode. • Enters tone level adjustment directly (see page 3) if pressed and held <b>EQ BASS-TRE</b> on the main unit.
	—	Enters playback mode menu directly (see page 2).
	—	<b>Power off</b> : Checks the current clock time. <b>Power on</b> : Changes the display information.

## Listening to the radio



⇒ "FM" or "AM"



"ST" lights up when receiving an FM stereo broadcast with sufficient signal strength.

### Manual search



"M" flashes, then press the button repeatedly.

### When an FM stereo broadcast is hard to receive



⇒ <TUNER> ⇒ <MONO> ⇒ <MONO ON>

Reception improves, but stereo effect will be lost.

To restore the stereo effect, repeat the same procedure to select <MONO OFF>.

### Automatic presetting (FM)—SSM (Strong-station Sequential Memory)

You can preset up to 18 stations for FM.

While listening to a station...

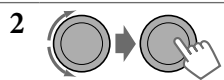

⇒ <TUNER> ⇒ <SSM> ⇒ <SSM 01 - 06> / <SSM 07 - 12> / <SSM 13 - 18>  
"SSM" flashes and local stations with the strongest signals are searched and stored automatically.

To preset another 6 stations, repeat the above procedure by selecting one of the other six SSM setting ranges.

### Manual presetting (FM/AM)

You can preset up to 18 stations for FM and 6 stations for AM.

Ex.: Storing FM station of 92.50 MHz into preset number "04."

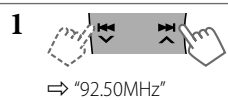

⇒ "92.50MHz"



"PRESET MODE" flashes.

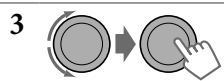

⇒ Selects preset number "04."  
"P04" flashes and "MEMORY" appears.

## Listening to the external components

You can connect an external component to the AUX (auxiliary) input jack on the control panel.

• Make sure <AUX ON> is selected for the <SRC SELECT> → <AUX IN> setting on page 3.



⇒ "AUX IN"

2 Turn on the connected component and start playing the source.

### Selecting a preset station

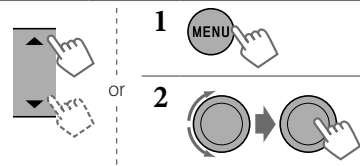

### Assigning title to a station

You can assign titles to 30 station frequencies (FM and AM) using 8 characters (maximum) for each title.

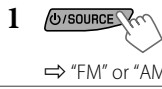

⇒ "FM" or "AM"



⇒ Show the title entry screen.



⇒ Selects a character.



⇒ Move to the next (or previous) character position.

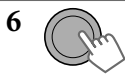
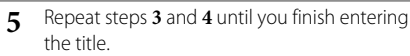

To erase the entire title, press and hold DISP after step 2, then press the control dial.

### Available characters

A	B	C	D	E	F	G	H	I	
J	K	L	M	N	O	P	Q	R	
S	T	U	V	W	X	Y	Z	0	
1	2	3	4	5	6	7	8	9	
-	/	<	>	Space					

### Changing the display information



Station name\* → Frequency → Clock → (back to the beginning)

\* If no title is assigned to a station, "NO NAME" appears for a few seconds.

### Using the remote controller



▲ U/D ▼ : Changes the preset stations  
◀ R/F ▶ : Searches for stations

## Listening to the disc



⇒ Turn on the power.



All tracks will be played repeatedly until you change the source or eject the disc.

### Stopping playback and ejecting the disc



"NO DISC" appears. Press SOURCE to listen to another playback source.

### Prohibiting disc ejection



To cancel the prohibition, repeat the same procedure.

### Caution on volume setting:

Discs produce very little noise compared with other sources. Lower the volume before playing a disc to avoid damaging the speakers by the sudden increase of the output level.

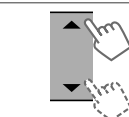

Selects folder of the MP3/WMA



Selects track



Fast-forwards or reverses the track

### Selecting a track/folder



For MP3/WMA discs, select the desired folder, then the desired track by repeating step 2.

• To return to the previous menu, press BACK.

### Selecting the playback modes

You can use only one of the following playback modes at a time.

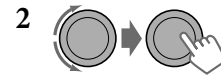

⇒ "REPEAT" ↔ "RANDOM"

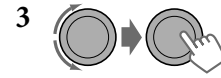

REPEAT  
TRACK RPT : Repeats current track  
FOLDER RPT : Repeats current folder  
RANDOM  
FOLDER RND : Randomly plays all tracks of current folder, then tracks of next folders  
ALL RND : Randomly plays all tracks

To cancel repeat play or random play, select "RPT OFF" or "RND OFF."

### Changing the display information



Disc title/Album name/performer (folder name)\* → Track title (file name)\* → Current track number with the elapsed playing time → Current track number with the clock time → (back to the beginning)

\* If the current disc is an audio CD, "NO NAME" appears. If an MP3/WMA file does not have Tag information or <TAG DISPLAY> is set to <TAG OFF> (see page 3), folder name and file name appear.

### Using the remote controller

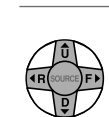

▲ U/D ▼ : Selects folder of the MP3/WMA  
◀ R/F ▶ : Selects track  
◀ R/F ▶ : Fast-forwards or reverses the track [Hold]

## Listening to the USB device

This unit can play MP3/WMA tracks stored in a USB device.



⇒ Turn on the power.

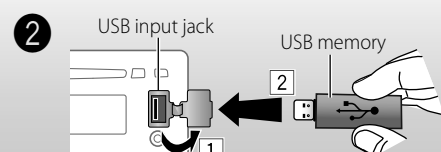

All tracks will be played repeatedly until you change the source or detach the USB device.

### If a USB device has been attached...

Pressing SOURCE turns on the power and playback starts from where it has been stopped previously.  
• If a different USB device is currently attached, playback starts from the beginning.

### Stopping playback and detaching the USB device

Straightly pull it out from the unit.  
"NO USB" appears. Press SOURCE to listen to another playback source.

You can operate the USB device in the same way you operate the files on a disc.

### Caution on volume setting:

USB devices produce very little noise compared with other sources. Lower the volume before playing a USB to avoid damaging the speakers by sudden increase of the output level.

### Cautions:

- Avoid using the USB device if it might hinder your safety driving.
- Do not pull out and attach the USB device repeatedly while "READING" is shown on the display.
- Do not start the car engine if a USB device is connected.
- This unit may not be able to play the files depending on the type of USB device.
- Operation and power supply may not work as intended for some USB devices.
- You cannot connect a computer to the USB input terminal of the unit.
- Make sure all important data has been backed up to avoid losing the data.
- Do not leave a USB device in the car, expose to direct sunlight, or high temperature to avoid deformation or cause damages to the device.
- Some USB devices may not work immediately after attaching USB device or turn on the power.
- For more details about USB operations, see page 5.

## Selecting a preset sound mode

You can select a preset sound mode suitable for the music genre.

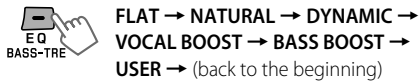

While listening, you can adjust the tone level of the selected sound mode.

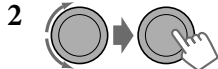

Adjust the level (-06 to +06) of the selected tone (BASS / MIDDLE / TREBLE).

The sound mode is automatically stored and changed to "USER."

## Storing your own sound mode

You can store your own adjustments in memory.



⇒ <PRO EQ> ⇒ <BASS> / <MIDDLE> / <TREBLE>

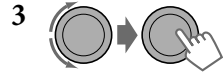

Adjust the sound elements of the selected tone (see table on the right).

4 Repeat steps 2 and 3 to adjust other tones.  
The adjustments made will be stored automatically in "USER."

The current sound mode changes to "USER" automatically.

Tone	Sound element		
	Frequency	Level	Q
BASS	60 Hz, 80 Hz, 100 Hz, 200 Hz	-06 to +06	Q1.0, Q1.25, Q1.5, Q2.0
MIDDLE	0.5 kHz, 1.0 kHz, 1.5 kHz, 2.5 kHz	-06 to +06	Q0.75, Q1.0, Q1.25
TREBLE	10.0 kHz, 12.5 kHz, 15.0 kHz, 17.5 kHz	-06 to +06	Q FIX

## Menu operations



3 Repeat step 2 if necessary.  
• To return to the previous menu, press **BACK**.  
• To exit from the menu, press **DISP** or **MENU**.

Category	Menu item	Selectable setting, [Initial: <u>Underlined</u> ]
DEMO	DEMO	• <u>DEMO ON</u> : Display demonstration will be activated automatically if no operation is done for about 20 seconds. • <u>DEMO OFF</u> : Cancels.
	CLOCK SET	[ <u>1:00</u> ] : Adjust the hour, then the minute.
PRO EQ	BASS	— : For settings, see "Storing your own sound mode."
	MIDDLE	—
	TREBLE	—
DISPLAY	DIMMER	• <u>DIMMER ON</u> : Dims the display and button illumination. • <u>DIMMER OFF</u> : Cancels.
	SCROLL *1	• <u>SCROLL ONCE</u> : Scrolls the displayed information once. • <u>SCROLL AUTO</u> : Repeats scrolling (at 5-second intervals). • <u>SCROLL OFF</u> : Cancels. Pressing <b>DISP</b> for more than one second can scroll the display regardless of the setting.
	TAG DISPLAY	• <u>TAG ON</u> : Shows the Tag information while playing MP3/WMA tracks. • <u>TAG OFF</u> : Cancels.
	SSM *2	• <u>SSM 01 - 06</u> : For settings, see "Automatic presetting (FM)—SSM (Strong-station Sequential Memory)" on page 2. • <u>SSM 07 - 12</u> • <u>SSM 13 - 18</u>
TUNER	AREA	• <u>AREA US</u> : When using in North/Central/South America. AM/FM intervals are set to 10 kHz/200 kHz. • <u>AREA EU</u> : When using in any other areas. AM/FM intervals are set to 9 kHz/50 kHz (100 kHz during auto search). • <u>AREA SA</u> : When using in South American countries where FM interval is 100 kHz. AM interval is set to 10 kHz.
	MONO *2	• <u>MONO ON</u> : Activate monaural mode to improve FM reception, but stereo effect will be lost. • <u>MONO OFF</u> : Restore the stereo effect.
	IF BAND	• <u>AUTO</u> : Increases the tuner selectivity to reduce interference noises between adjacent stations. (Stereo effect may be lost.) • <u>WIDE</u> : Subject to interference noises from adjacent stations, but sound quality will not be degraded and the stereo effect will remain.

Category	Menu item	Selectable setting, [Initial: <u>Underlined</u> ]
AUDIO	FADER *3	<u>R06 - F06</u> [ 00 ] : Adjust the front and rear speaker output balance.
	BALANCE *4	<u>L06 - R06</u> [ 00 ] : Adjust the left and right speaker output balance.
	LOUD	• <u>LOUD ON</u> : Boost low and high frequencies to produce a well-balanced sound at a low volume level. • <u>LOUD OFF</u> : Cancels.
	VOL ADJUST	<u>VOL ADJ -05</u> — : Preset the volume adjustment level of each source (except FM), compared to the FM volume level. The volume level will automatically increase or decrease when you change the source. <u>VOL ADJ +05</u> [ <u>VOL ADJ 00</u> ] • Before making an adjustment, select the source you want to adjust. • "VOL ADJ FIX" appears on the display if "FM" is selected as the source.
	L/O MODE	• <u>SUB.W</u> : Select if the REAR LINE OUT terminals are used for connecting a subwoofer (through an external amplifier). • <u>REAR</u> : Select if the REAR LINE OUT terminals are used for connecting the speakers (through an external amplifier).
	SUB.W FREQ *5	• <u>LOW</u> : Frequencies lower than 72 Hz are sent to the subwoofer. • <u>MID</u> : Frequencies lower than 111 Hz are sent to the subwoofer. • <u>HIGH</u> : Frequencies lower than 157 Hz are sent to the subwoofer.
	SUB.W LEVEL *5	<u>SUB.W 00</u> — : Adjust the subwoofer output level. <u>SUB.W 08</u> [ <u>SUB.W 04</u> ]
	BEEP	• <u>BEEP ON</u> : Activates the keypress tone. • <u>BEEP OFF</u> : Deactivates the keypress tone.
	AMP GAIN *6	• <u>LOW POWER</u> : VOLUME 00 - VOLUME 30 (Select if the maximum power of each speaker is less than 50 W to prevent damaging the speakers.) • <u>HIGH POWER</u> : VOLUME 00 - VOLUME 50
	SRC SELECT	AM *7
AUX IN *8		• <u>AUX ON</u> : Enable "AUX IN" in source selection. • <u>AUX OFF</u> : Disable "AUX IN" in source selection.

\*1 Some characters or symbols will not be shown correctly (or will be blanked) on the display.

\*2 Displayed only when the source is "FM."

\*3 If you are using a two-speaker system, set the fader level to "00."

\*4 This adjustment will not affect the subwoofer output.

\*5 Displayed only when <L/O MODE> is set to <SUB.W>.

\*6 The volume level automatically changes to "VOLUME 30" if you change to <LOW POWER> with the volume level is set higher than "VOLUME 30."

\*7 Displayed only when any source other than "AM" is selected.

\*8 Displayed only when any source other than "AUX IN" is selected.

# Installation

This unit is designed to operate on **12 V DC, NEGATIVE ground electrical systems**. If your vehicle does not have this system, a voltage inverter is required, which can be purchased at JVC car audio dealers.

Prepare these before installation...

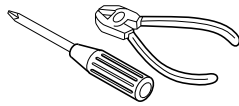

## Warnings

- To prevent short circuits:
  - Disconnect the battery's negative terminal and make all electrical connections before installing the unit.
  - Cover the terminals of the UNUSED leads with insulating tape.
- Be sure to ground this unit to the car's chassis again after installation.
- Replace the fuse with one of the specified rating.
- Connect speakers with a maximum power of more than 50 W (impedance of 4 Ω to 8 Ω). Otherwise, change the <AMP GAIN> setting. (See "Menu operations" on page 3.)
- The heat sink becomes very hot after use. Be careful not to touch it when removing this unit.

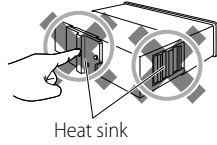

Heat sink

## Parts List

(A) Hard case.....	1	(D) Trim plate.....	1
(B) Control panel.....	1	(E) Power cord.....	1
(C) Sleeve.....	1	(F) Handles.....	2

The following illustration shows a typical installation. If you have any questions or require information regarding installation kits, consult your JVC car audio dealer or a company supplying kits.

## In-dash mounting

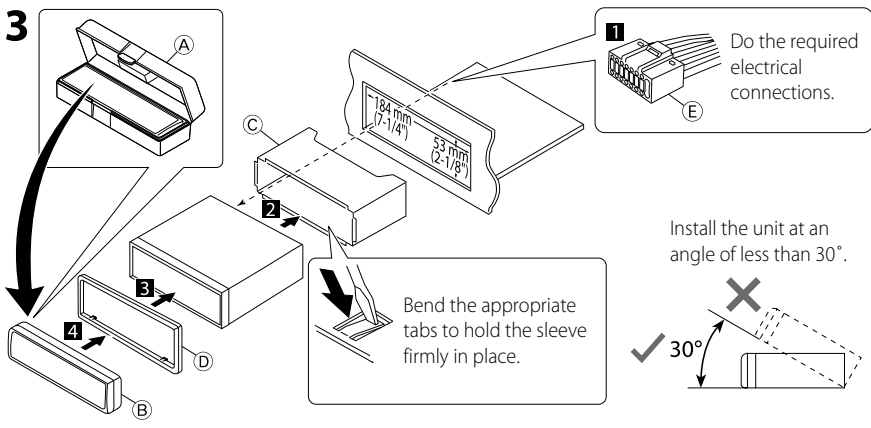
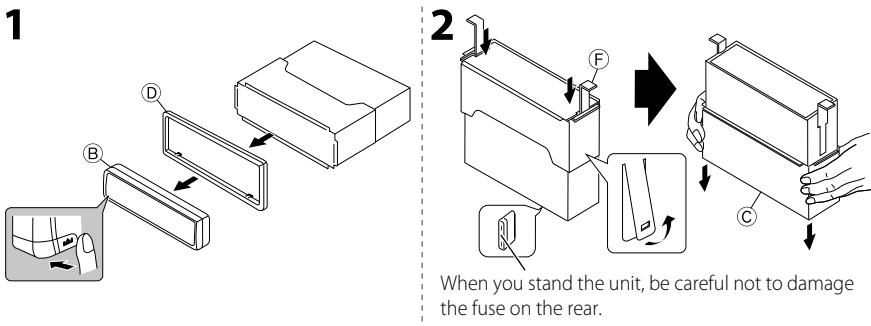

## When installing the unit without using the sleeve

Flat head screws—M5 x 8 mm (3/8") \*1

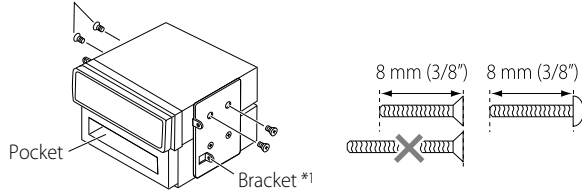

## Removing the unit

Release the rear section first...

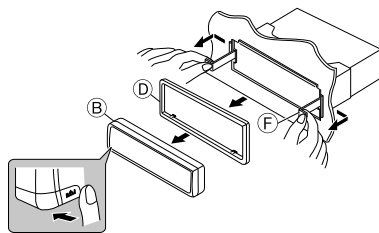

# Electrical connections

**IMPORTANT:** A custom wiring harness (separately purchased) which is suitable for your car is recommended for connection between the unit and your car.

• Consult your JVC car audio dealer or a company supplying kits for details.

## PRECAUTIONS on power supply and speaker connections

- DO NOT connect the speaker leads of the power cord to the car battery; otherwise, the unit will be seriously damaged.
- BEFORE connecting the speaker leads of the power cord to the speakers, check the speaker wiring in your car.

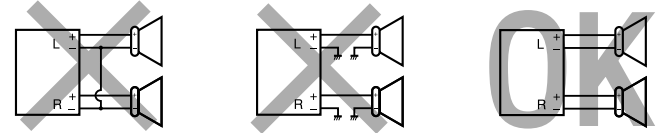

## Connecting the external amplifier or subwoofer

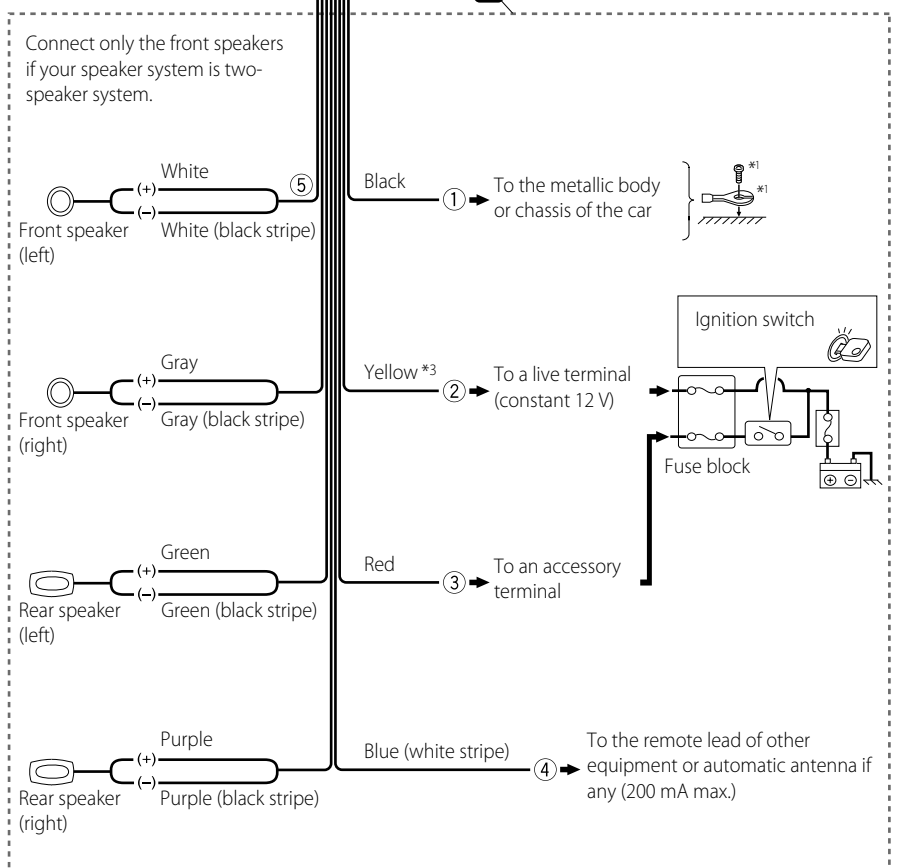
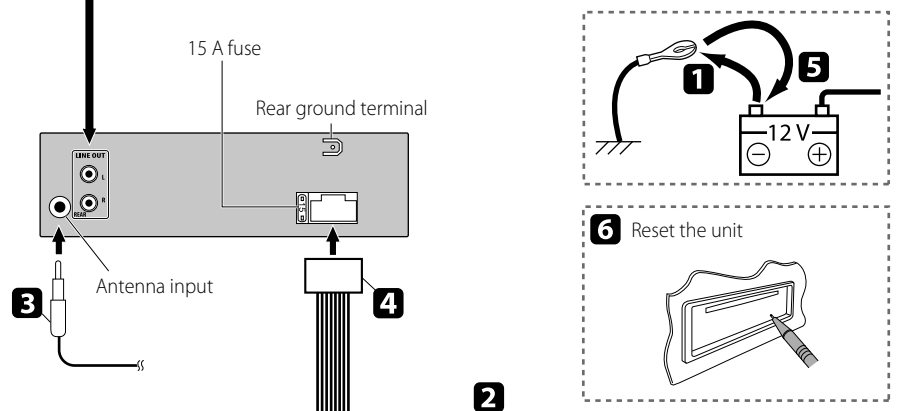
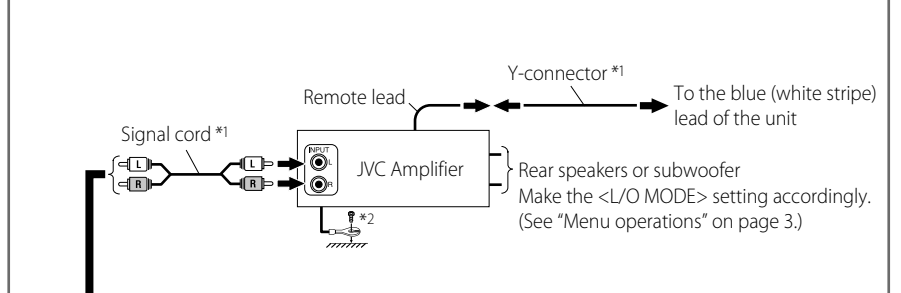

\*1 Not supplied for this unit.

\*2 Firmly attach the ground wire to the metallic body or to the chassis of the car—to the place uncoated with paint.

\*3 Before checking the operation of this unit prior to installation, this lead must be connected, otherwise the power cannot be turned on.

# Troubleshooting

	Symptom	Remedy/Cause
General	Sound cannot be heard from the speakers.	<ul style="list-style-type: none"> <li>Adjust the volume to the optimum level.</li> <li>Make sure the unit is not muted/paused. (See page 1.)</li> <li>Check the cords and connections.</li> </ul>
	"PROTECT" appears on the display and no operations can be done.	Check to be sure the terminals of the speaker leads are covered with insulating tape properly, then reset the unit. (See page 1.) If "PROTECT" does not disappear, consult your JVC car audio dealer or a company supplying kits.
	This unit does not work at all.	Reset the unit. (See page 1.)
	"AUX IN" cannot be selected.	Check the <SRC SELECT> → <AUX IN> setting. (See "Menu operations" on page 3.)
FM/AM	SSM automatic presetting does not work.	Store stations manually.
	Static noise while listening to the radio.	Connect the antenna firmly.
	"AM" cannot be selected.	Check the <SRC SELECT> → <AM> setting. (See "Menu operations" on page 3.)
Disc playback	Disc cannot be played back.	Insert the disc correctly.
	<ul style="list-style-type: none"> <li>CD-R/CD-RW cannot be played back.</li> <li>Tracks on the CD-R/CD-RW cannot be skipped.</li> </ul>	<ul style="list-style-type: none"> <li>Insert a finalized CD-R/CD-RW.</li> <li>Finalize the CD-R/CD-RW with the component which you used for recording.</li> </ul>
	Disc can be neither played back nor ejected.	<ul style="list-style-type: none"> <li>Unlock the disc. (See page 2.)</li> <li>Eject the disc forcibly. (See page 1.)</li> </ul>
	Disc sound is sometimes interrupted.	<ul style="list-style-type: none"> <li>Stop playback while driving on rough roads.</li> <li>Change the disc.</li> <li>Check the cords and connections.</li> </ul>
	"NO DISC" appears on the display.	Insert a playable disc into the loading slot.
	"PLEASE" and "EJECT" appear alternately on the display.	Press ▲, then insert a disc correctly.
MP3/WMA playback	Disc cannot be played back.	<ul style="list-style-type: none"> <li>Use a disc with MP3/WMA tracks recorded in a format compliant with ISO 9660 Level 1, Level 2, Romeo, or Joliet.</li> <li>Add the extension code &lt;.mp3&gt; or &lt;.wma&gt; to the file names.</li> </ul>
	Noise is generated.	Skip to another track or change the disc. (Do not add the extension code <.mp3> or <.wma> to non-MP3 or WMA tracks.)
	A longer readout time is required ("READING" keeps flashing on the display).	Do not use too many hierarchical levels and folders.
	Tracks are not played back in the order you have intended.	Playback order is determined when the files are recorded.
	"NO FILE" appears on the display.	Selected folder is an empty folder*. Select another folder that contains MP3/WMA tracks. * Folder that is physically empty or folder that contains data but does not contain valid MP3/WMA track.
	"NOT SUPPORT" appears on the display and track skips.	Skip to the next track encoded in an appropriate format or to the next non-copy-protected WMA track.
	The elapsed playing time is not correct.	This sometimes occurs during playback. This is caused by how the tracks are recorded on the disc.
	The correct characters are not displayed (e.g. album name).	This unit can only display letters (upper case), numbers, and a limited number of symbols. (See page 2.)
	Noise is generated.	The track played back is not an MP3/WMA track. Skip to another file. (Do not add the extension code <.mp3> or <.wma> to non-MP3 or WMA tracks.)
	"READING" keeps flashing on the display.	<ul style="list-style-type: none"> <li>Readout time varies depending on the USB device.</li> <li>Do not use too many hierarchy or folders.</li> <li>Turn off the power then on again.</li> <li>Reattach the USB device again.</li> </ul>
USB device playback	"NO FILE" appears on the display.	Selected folder is an empty folder*. Select another folder that contains MP3/WMA tracks. * Folder that is physically empty or folder that contains data but does not contain valid MP3/WMA track.
	"NOT SUPPORT" appears on the display and track skips.	Skip to the next track encoded in an appropriate format or to the next non-copy-protected WMA track.
	Tracks/folders are not played back in the order you have intended.	The playback order is determined by the write-in time stamp. The first track/folder written into the USB device will be the first track/folder for playback.
	<ul style="list-style-type: none"> <li>"CANNOT PLAY" flashes on the display.</li> <li>"NO USB" appears on the display.</li> <li>The unit cannot detect the USB device.</li> </ul>	<ul style="list-style-type: none"> <li>Attach a USB device that contains tracks encoded in an appropriate format.</li> <li>Reattach the USB device again.</li> </ul>
	While playing a track, sound is sometimes interrupted.	The MP3/WMA tracks have not been properly copied into the USB device. Copy MP3/WMA tracks again into the USB device, and try again.
	Correct characters are not displayed (e.g. album name).	This unit can only display letters (upper case), numbers, and a limited number of symbols. (See page 2.)
Installation/connection	The fuse blows.	Connect the red and black leads correctly.
	Power cannot be turned on.	Check to make sure the yellow lead is connected.
	No sound from the speakers.	Check to make sure the speaker output lead is not shortcircuited.
	Sound is distorted.	<ul style="list-style-type: none"> <li>Check to make sure the speaker output lead is grounded.</li> <li>Check to make sure the "-" terminals of L and R speakers are grounded in common.</li> </ul>
	Noise interfere with sounds.	Check to make sure the rear ground terminal connected to the car's chassis is using shorter and thicker cords.
	This unit becomes hot.	<ul style="list-style-type: none"> <li>Check to make sure the speaker output lead is grounded.</li> <li>Check to make sure the "-" terminals of L and R speakers are grounded in common.</li> </ul>
	This unit does not work at all.	Reset the unit. (See page 1.)

# More about this unit

## General

- If you turn off the power while listening to a track, playback will start from where it had been stopped previously next time you turn on the power.
- If no operation is done for about 60 seconds after pressing **MENU** button, the operation will be canceled.

## Tuner operations

- During SSM search...
  - All previously stored stations are erased and the stations are stored anew.
  - When SSM is over, the station stored in the lowest preset number will be automatically tuned in.
- When storing a station manually, the previously preset station is erased when a new station is stored in the same preset number.
- If you try to assign titles to more than 30 station frequencies, "NAME FULL" appears. Delete unwanted titles before assignment.

## Disc/USB operations

### Caution for DualDisc playback

- The Non-DVD side of a "DualDisc" does not comply with the "Compact Disc Digital Audio" standard. Therefore, the use of Non-DVD side of a DualDisc on this product may not be recommended.

## General

- This unit has been designed to reproduce CDs/CD Texts, and CD-Rs (Recordable)/CD-RWs (Rewritable) in audio CD (CD-DA), MP3 and WMA formats.
- If you change the source while listening to a disc, playback stops. Next time you select "CD" as the playback source, playback will start from where it had been stopped previously.
- If the ejected disc is not removed within 15 seconds, it is automatically inserted into the loading slot again to protect it from dust. Playback starts automatically.

## Playing a CD-R or CD-RW

- Use only "finalized" CD-Rs or CD-RWs.
- This unit can play back multi-session discs; however, unclosed sessions will be skipped while playing.
- Some CD-Rs or CD-RWs may not be played back on this unit:
  - Discs are dirty or scratched.
  - Moisture condensation has occurred on the lens inside the unit.
  - The pickup lens inside the unit is dirty.
  - The files on the CD-R/CD-RW are written using the "Packet Write" method.
  - There are improper recording conditions (missing data, etc.) or media conditions (stained, scratched, warped, etc.).
- CD-RWs may require a longer readout time since the reflectance of CD-RWs is lower than that of regular CDs.

## Playing an MP3/WMA disc

- This unit can play back MP3/WMA files with the extension code <.mp3> or <.wma> (regardless of the letter case—upper/lower).
- This unit can show the names of albums, artists (performer), and tag (Version 1.0, 1.1, 2.2, 2.3, or 2.4) for MP3 files and for WMA files.
- This unit can display only one-byte characters. No other characters can be correctly displayed.
- This unit can play back MP3/WMA files meeting the conditions below:
  - Bit rate: 32 kbps — 320 kbps
  - Sampling frequency of MP3:
    - 32 kHz, 44.1 kHz, 48 kHz (for MPEG-1)
    - 16 kHz, 22.05 kHz, 24 kHz (for MPEG-2)
  - Sampling frequency of WMA:
    - 22.05 kHz, 32 kHz, 44.1 kHz, 48 kHz
  - Disc format: ISO 9660 Level 1/ Level 2, Romeo, Joliet, Windows extension
- The maximum number of characters for file/folder names vary depending on the disc format used (includes 4 extension characters—<.mp3> or <.wma>).
  - ISO 9660 Level 1: up to 12 characters; ISO 9660 Level 2: up to 31 characters; Romeo: up to 64 characters; Joliet: up to 32 characters; Windows extension: up to 64 characters

- This unit can recognize a total of 512 files, 255 folders, and 8 hierarchical levels.
- This unit can play back files recorded in VBR (variable bit rate).  
Files recorded in VBR have a discrepancy in the elapsed time display, and do not show the actual elapsed time. In particular, this difference becomes noticeable after performing the search function.
- This unit cannot play back the following files:
  - MP3 files: encoded in MP3i and MP3 PRO format; an inappropriate format; layer 1/2.
  - WMA files: encoded in lossless, professional, and voice format; not based upon Windows Media® Audio; copy-protected with DRM.
  - Files which have data such as AIFF, ATRAC3, etc.
- The search function works but search speed is not constant.

## Playing MP3/WMA tracks from a USB device

- While playing from a USB device, the playback order may differ from other players.
- This unit may be unable to play back some USB devices or some files due to their characteristics or recording conditions.
- Depending on the shape of the USB devices and connection ports, some USB devices may not be attached properly or the connection might be loose.
- Connect one USB mass storage class device to the unit at a time. Do not use a USB hub.
- If the connected USB device does not have the correct files, "CANNOT PLAY" appears.
- This unit can show Tag (Version 1.0, 1.1, 2.2, 2.3, or 2.4) for MP3 files and for WMA files.
- This unit can play back MP3/WMA files meeting the conditions below:
  - Bit rate: 32 kbps — 320 kbps
  - Sampling frequency of MP3:
    - 32 kHz, 44.1 kHz, 48 kHz (for MPEG-1)
    - 16 kHz, 22.05 kHz, 24 kHz (for MPEG-2)
  - Sampling frequency of WMA:
    - 22.05 kHz, 32 kHz, 44.1 kHz, 48 kHz
- This unit can play back MP3 files recorded in VBR (variable bit rate).
- The maximum number of characters for:
  - Folder names: 32 characters; File names: 32 characters; MP3 Tag: 64 characters; WMA Tag: 32 characters
- This unit can recognize a total of 5 000 files, 255 folders (255 files per folder including folder without unsupported files), and of 8 hierarchies.
- This unit does not support SD card reader.
- This unit cannot recognize a USB device whose rating is other than 5 V and exceeds 500 mA.
- USB devices equipped with special functions such as data security functions cannot be used with the unit.
- Do not use a USB device with 2 or more partitions.
- This unit may not recognized a USB device connected through a USB card reader.
- This unit may not play back files in a USB device properly when using a USB extension cord.
- This unit cannot play back the following files:
  - MP3 files: encoded in MP3i and MP3 PRO format; an inappropriate format; layer 1/2.
  - WMA files: encoded in lossless, professional, and voice format; not based upon Windows Media® Audio.

Microsoft and Windows Media are either registered trademarks or trademarks of Microsoft Corporation in the United States and/or other countries.

**JVC bears no responsibility for any loss of the data in the USB mass storage class device while using this System.**

## Maintenance

### How to clean the connectors

Wipe the connectors with a cotton swab or cloth moistened with alcohol.

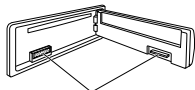

Connectors

### Moisture condensation

Moisture may condense on the lens inside the unit. Eject the disc and leave the unit turned on for a few hours until the moisture has evaporated.

### To keep discs clean

Wipe in a straight line from center of disc to edge. Do not use liquid cleaners, thinners, or benzene.



### To play new discs

Remove any rough areas from the inner and outer edges of the disc.

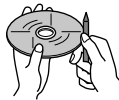

### Do not use the following discs:

- Single CD—8 cm (3-3/16") disc
- Warped disc
- Disc with sticker and sticker residue
- Disc with stick-on label
- Unusual shape disc
- C-thru Disc (semi-transparent disc)
- Disc with transparent or semi-transparent parts on its recording area

## Specifications

### AUDIO AMPLIFIER SECTION

#### Power Output:

20 W RMS × 4 Channels at 4 Ω and ≤ 1% THD+N

#### Signal-to-Noise Ratio:

80 dBA (reference: 1 W into 4 Ω)



Load Impedance: 4 Ω (4 Ω to 8 Ω allowance)

Tone Control Range:

Bass: ±12 dB (60 Hz, 80 Hz, 100 Hz, 200 Hz)  
Q1.0, Q1.25, Q1.5, Q2.0

Middle: ±12 dB (0.5 kHz, 1.0 kHz, 1.5 kHz,  
2.5 kHz)

Q0.75, Q1.0, Q1.25

Treble: ±12 dB (10.0 kHz, 12.5 kHz, 15.0 kHz,  
17.5 kHz)  
Q (Fixed)

Frequency Response: 40 Hz to 20 000 Hz

Line-Out Level/Impedance:

2.5 V/20 kΩ load (full scale)

Subwoofer-Out Level/Impedance:

2.5 V/20 kΩ load (full scale)

Output Impedance: 1 kΩ

Other Terminal: USB input jack, AUX (auxiliary)  
input jack, Antenna input

### TUNER SECTION

Frequency Range:

FM: 87.5 MHz to 107.9 MHz  
(with channel interval set to 100 kHz or  
200 kHz)

87.5 MHz to 108.0 MHz  
(with channel interval set to 50 kHz)

AM: 530 kHz to 1 710 kHz  
(with channel interval set to 10 kHz)

531 kHz to 1 602 kHz  
(with channel interval set to 9 kHz)

#### [FM Tuner]

Usable Sensitivity: 9.3 dBf (0.8 μV/75 Ω)

50 dB Quieting Sensitivity: 16.3 dBf (1.8 μV/75 Ω)

Alternate Channel Selectivity (400 kHz): 65 dB

Frequency Response: 40 Hz to 15 000 Hz

Stereo Separation: 40 dB

#### [AM Tuner]

Sensitivity/Selectivity: 20 μV/40 dB

### CD PLAYER SECTION

Type: Compact disc player  
Signal Detection System: Non-contact optical pickup  
(semiconductor laser)

Number of channels: 2 channels (stereo)

Frequency Response: 5 Hz to 20 000 Hz

Dynamic Range: 96 dB

Signal-to-Noise Ratio: 98 dB

Wow and Flutter: Less than measurable limit

MP3 Decoding Format: MPEG1/2 Audio Layer 3

Max. Bit Rate: 320 kbps

WMA (Windows Media® Audio) Decoding Format:

Max. Bit Rate: 320 kbps

### USB SECTION

USB Standard: USB 1.1, USB 2.0

Data Transfer Rate (Full Speed): Max. 12 Mbps

Compatible Device: Mass storage class

Compatible File System: FAT 32/16/12

Playable Audio Format: MP3/WMA

Max. Current: DC 5 V  $\overline{=}$  500 mA

### GENERAL

Power Requirement: Operating Voltage:  
DC 14.4 V (11 V to 16 V  
allowance)

Grounding System: Negative ground

Allowable Operating Temperature:  
0°C to +40°C (32°F to 104°F)

Dimensions (W × H × D):

Installation Size (approx.):

182 mm × 52 mm × 160 mm

(7-3/16" × 2-1/16" × 6-5/16")

Panel Size (approx.):

188 mm × 58 mm × 6 mm

(7-7/16" × 2-5/16" × 1/4")

Mass (approx.): 1.3 kg (2.9 lbs) (excluding  
accessories)

Design and specifications are subject to change  
without notice.

If a kit is necessary for your car, consult your  
telephone directory for the nearest car audio  
specialty shop.

**Having TROUBLE with operation?**  
**Please reset your unit**  
**Still having trouble??**

**Call 1-800-252-5722 (USA ONLY)**

**<http://www.jvc.com>**

## Free Manuals Download Website

<http://myh66.com>

<http://usermanuals.us>

<http://www.somanuals.com>

<http://www.4manuals.cc>

<http://www.manual-lib.com>

<http://www.404manual.com>

<http://www.luxmanual.com>

<http://aubethermostatmanual.com>

Golf course search by state

<http://golfingnear.com>

Email search by domain

<http://emailbydomain.com>

Auto manuals search

<http://auto.somanuals.com>

TV manuals search

<http://tv.somanuals.com>