

JVC



CASSETTE RECEIVER

KS-FX230/F130

RECEPTOR-REPRODUCTOR DE CASSETTE

KS-FX230/F130

RADIOCASSETTE

KS-FX230/F130

ENGLISH

ESPAÑOL

FRANÇAIS

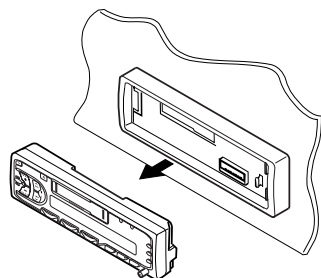
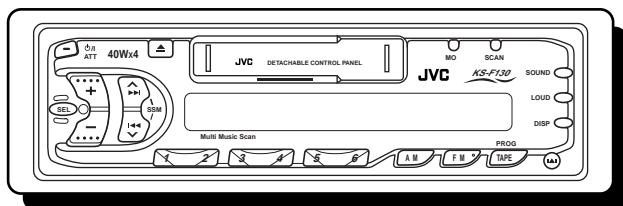
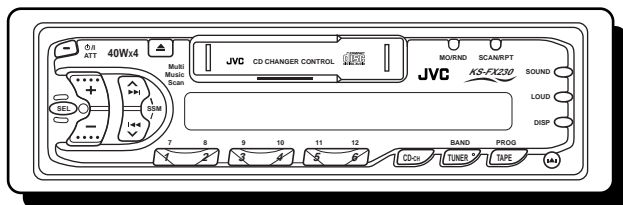

For installation and connections, refer to the separate manual.
Para la instalación y las conexiones, refiérase al manual separado.
Pour l'installation et les raccordements, se référer au manuel séparé.

INSTRUCTIONS

MANUAL DE INSTRUCCIONES
MANUEL D'INSTRUCTIONS

For customer Use:

Enter below the Model No. and Serial No. which are located on the top or bottom of the cabinet. Retain this information for future reference.

Model No. _____

Serial No. _____

FSUN3029-631D

Thank you for purchasing a JVC product. Please read all instructions carefully before operation, to ensure your complete understanding and to obtain the best possible performance from the unit.

CONTENTS



BASIC OPERATIONS 3

RADIO OPERATIONS 4

Listening to the radio	4
Storing stations in memory	5
FM station automatic preset: SSM	5
Manual preset	6
Tuning into a preset station	7
Other convenient tuner functions	8
Scanning broadcast stations	8
Selecting FM reception sound	8
Changing the AM/FM channel intervals	8



TAPE OPERATIONS 9

Listening to a tape	9
Finding the beginning of a tune	10
Other convenient tape functions	10
Prohibiting tape ejection	10



SOUND ADJUSTMENTS 11

Turning on/off the loudness function	11
Selecting preset sound modes	11
Adjusting the sound	12
Storing your own sound adjustments	13



OTHER MAIN FUNCTIONS 14

Setting the clock	14
Detaching the control panel	15



CD CHANGER OPERATIONS 16

(ONLY FOR KS-FX230)

Playing CDs	16
Selecting CD playback modes	18



MAINTENANCE 19

To extend the lifetime of the unit	19
--	----



TROUBLESHOOTING 20

SPECIFICATIONS 21

BEFORE USE

* *For safety...*

- Do not raise the volume level too much, as this will block outside sounds, making driving dangerous.
- Stop the car before performing any complicated operations.

* *Temperature inside the car...*

If you have parked the car for a long time in hot or cold weather, wait until the temperature in the car becomes normal before operating the unit.



BASIC OPERATIONS

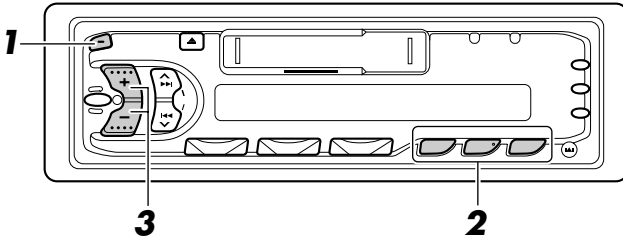

Note:
When you use this unit for the first time, set the built-in clock correctly, see page 14.



Turn on the power.

Note on One-Touch Operation:

When you select a source in step 2 below, the power automatically comes on. You do not have to press this button to turn on the power.

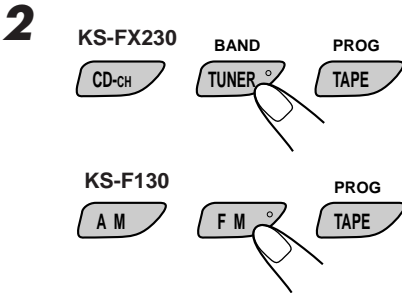

Select the source.

To operate the tuner, see pages 4 – 8.
To operate the tape deck, see pages 9 – 10.

ONLY FOR KS-FX230:
To operate the CD changer, see pages 16 – 18.

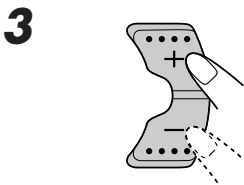

Adjust the volume.

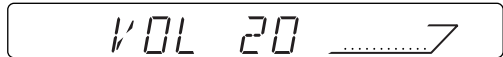

Volume level appears.

4 Adjust the sound as you want (see pages 11 – 13).

To drop the volume in a moment

Press ϕ/I ATT briefly while listening to any source. "ATT" starts flashing on the display, and the volume level will drop in a moment.

To resume the previous volume level, press the button briefly again.

To turn off the power

Press ϕ/I ATT for more than 1 second.



RADIO OPERATIONS

Listening to the radio

KS-FX230

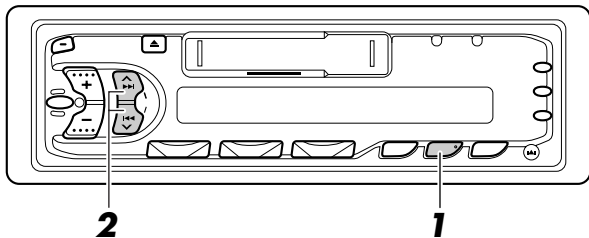

KS-F130

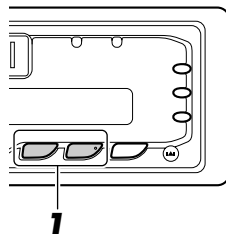

1 KS-FX230

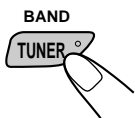

Select the band (FM1, FM2, FM3 or AM).

You can select any one of FM1, FM2, and FM3 to listen to an FM station.

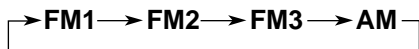

KS-F130

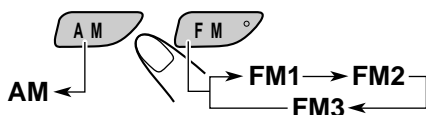

Audio level indicator



2

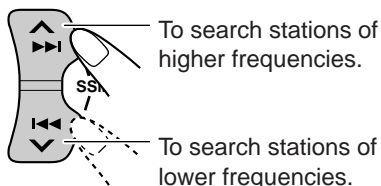

To search stations of higher frequencies.

To search stations of lower frequencies.

Start searching a station.

When a station is received, searching stops.



To stop searching before a station is received, press the same button you have pressed for searching.

To tune in a particular frequency manually:

1 Select the band (FM or AM)

For KS-FX230: Press TUNER/BAND repeatedly.

For KS-F130: Press FM or AM.

2 Press and hold SSM $\blacktriangleright\blacktriangleleft$ \blacktriangle or SSM $\blacktriangleleft\blacktriangleright$ \blacktriangledown until "M" starts flashing on the display. Now you can manually change the frequency while "M" is flashing.

3 Press SSM $\blacktriangleright\blacktriangleleft$ \blacktriangle or SSM $\blacktriangleleft\blacktriangleright$ \blacktriangledown repeatedly until the frequency you want is reached.

• If you hold down the button, the frequency keeps changing until you release the button.

Storing stations in memory

You can use one of the following two methods to store broadcasting stations in memory.

- Automatic preset of FM stations: SSM (Strong-station Sequential Memory)
- Manual preset of both FM and AM stations

FM station automatic preset: SSM

You can preset 6 local FM stations in each FM band (FM1, FM2, and FM3).

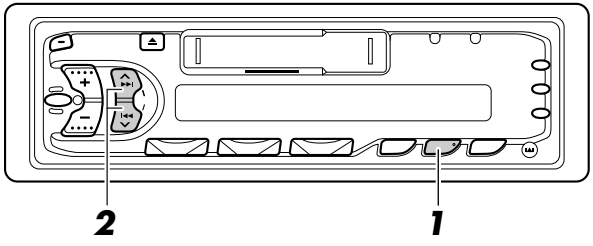

1 KS-FX230

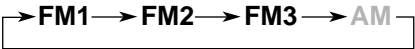
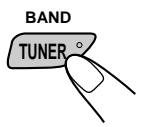

Select the FM band number (FM1, FM2 or FM3) you want to store FM stations into.

KS-F130

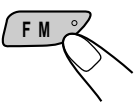

2

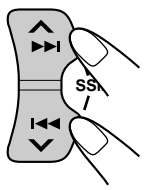

Press and hold the both buttons for more than 3 seconds.

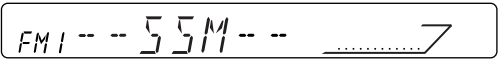

"SSM" appears, then disappears when automatic preset is over.

Local FM stations with the strongest signals are searched and stored automatically in the band number you have selected (FM1, FM2 or FM3). These stations are preset in the number buttons — No. 1 (lowest frequency) to No. 6 (highest frequency).

When automatic preset is over, the station stored in number button 1 will be automatically tuned in.



Manual preset

You can preset up to 6 stations in each band (FM1, FM2, FM3 and AM) manually.

EXAMPLE: Storing an FM station of 88.3 MHz into the preset number 1 of the FM1 band

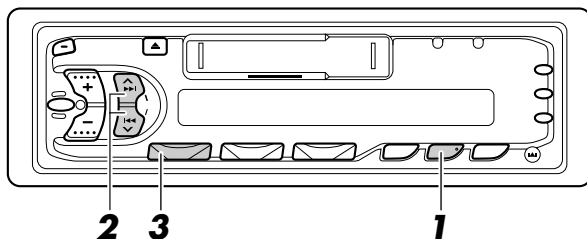

1 KS-FX230

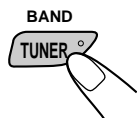

KS-F130

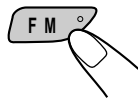

Select the FM1 band.



2

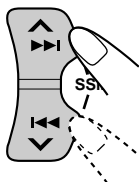

Tune into a station of 88.3 MHz.
See page 4 to tune into a station.



3

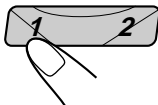

Press and hold the button for more than 1 second.



Preset number "1" starts flashing for a while.

4

Repeat the above procedure to store other station into other preset numbers.

Notes:

- A previously preset station is erased when a new station is stored in the same preset number.
- Preset stations are erased when the power supply to the memory circuit is interrupted (for example, during battery replacement). If this occurs, preset the stations again.

Tuning into a preset station

You can easily tune into a preset station. Remember that you must store stations first. If you have not stored them yet, see pages 5 and 6.

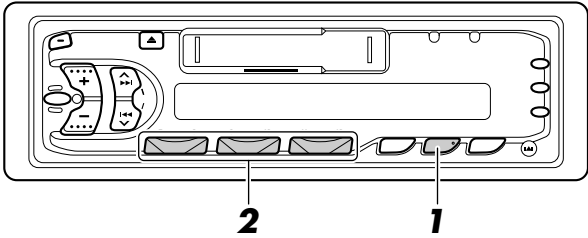
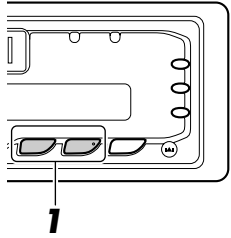
KS-FX230

KS-F130

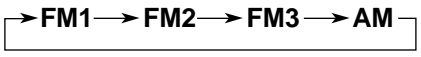
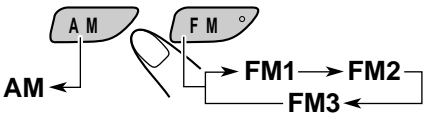
1 **KS-FX230** **BAND TUNER** Select the band (FM1, FM2, FM3 or AM) you want.

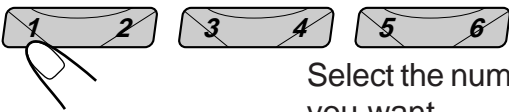

KS-F130

2 Select the number (1 – 6) for the preset station you want.



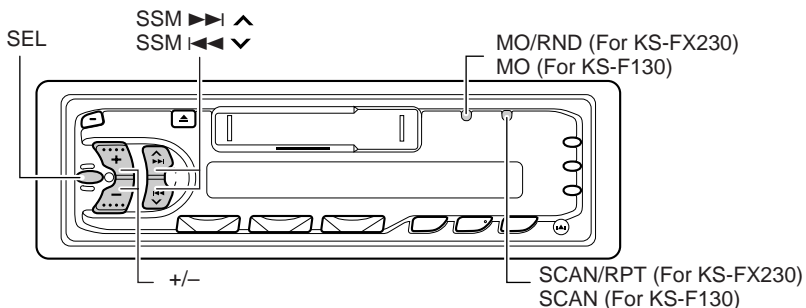

Other convenient tuner functions



Scanning broadcast stations

When you press SCAN/RPT (for KS-FX230) or SCAN (for KS-F130) while listening to the radio, station scanning starts. Each time a broadcast is tuned in, scanning stops for about 5 seconds (tuned frequency number flashes on the display), and you can check what program is now being broadcasted.

If you want to listen to that program, press the same button again to stop scanning.

Selecting FM reception sound

When an FM stereo broadcast is hard to receive:

Press MO/RND (mono/random: for KS-FX230) or MO (mono: for KS-F130) while listening to an FM stereo broadcast. The sound you hear becomes monaural but reception will be improved.

Lights when receiving an FM broadcast in stereo.



To restore the stereo effect, press the same button again.

Changing the AM/FM channel intervals

When using this unit in an area other than North or South America:

When this unit is shipped from the factory, the channel intervals are set to 10 kHz for AM and 200 kHz for FM. You can change the channel intervals by following the procedure below.

1 Press SEL (select) for more than 2 seconds.

“CLOCK H,” “CLOCK M” or “AREA” appears on the display.

2 If “AREA” does not appear, press SSM ►►► ▲ or SSM ◄◄◄ ▼ until it appears.

3 Press +.

“AREA EU” appears and the channel intervals are set to 9 kHz for AM and 50 kHz (for manual tuning) / 100 kHz (for searching) for FM.

To reset to the factory setting, follow the above step 1 and 2, then press – in step 3 (“AREA US” appears on the display.)

AREA EU: Select this when used in an area other than North and South America.
AREA US: Select this when used in North or South America.



Listening to a tape

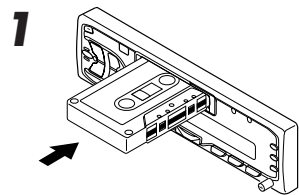
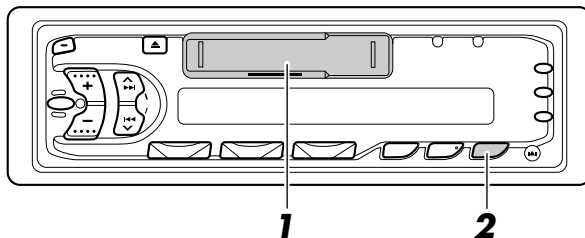

1 Insert a cassette.

The unit turns on and tape play starts automatically. When one side of the tape reaches its end during play, the other side of the tape automatically starts playing. (Auto Reverse)

Note on One-Touch Operation:
 When a cassette is already in the cassette compartment, pressing **TAPE/PROG** turns on the unit and starts tape play automatically.

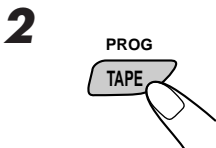

2 Select the tape direction.

Each time you press the button, the tape direction changes alternatively – forward (TAPE >>>) and reverse (TAPE <<<).

To stop play and eject the cassette

Press **▲**.

Tape play stops and the cassette automatically ejects from the cassette compartment. If you change the source to AM/FM (or CD changer for KS-FX230 only), the tape play also stops (without ejecting the cassette this time).

- You can also eject the tape with the unit turned off.

To fast-forward and rewind a tape

- Press **SSM >>> ▲** for more than 1 second to fast-forward the tape.

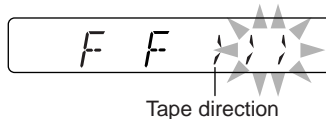

When the tape reaches its end, the tape is reversed and playback starts from the beginning of the other side.

- Press **SSM <<< ▼** for more than 1 second to rewind the tape.

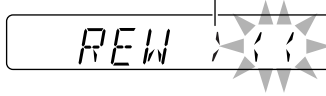

When the tape reaches its end, playback of the same side starts.

To stop fast-forward and rewind at any position on the tape, press **TAPE/PROG**.

Tape play starts from that position on the tape.



Finding the beginning of a tune

Multi Music Scan allows you to automatically start playback from the beginning of a specified tune. You can specify up to 9 tunes ahead or before the current tune.

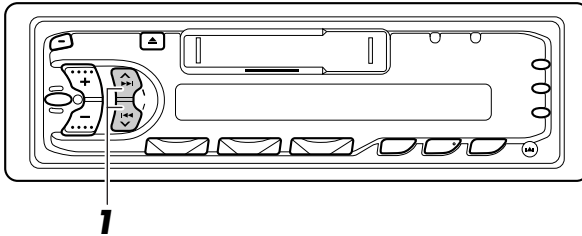

1 During playback

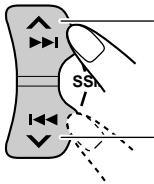

To locate a tune ahead of the current tune on the tape

To locate a tune before the current tune on the tape

Specify how many tunes ahead or before the current tune the tune you want is located.



Each time you set the tune, the number changes up to ± 9 .

When the beginning of the specified tune is located, playback starts automatically.

Notes:

- While locating a specified tune:
 - If the tape is rewound to its beginning, playback starts from the beginning of that side.
 - If the tape is fast forwarded to the end, it is reversed and played from the beginning of the other side.
- In the following cases, the Multi Music Scan function may not operate correctly.
 - Tapes with tunes having long pianissimo passages (very quiet parts) or non-recorded portions during tunes.
 - Tapes with short non-recorded sections.
 - Tapes with high level noise or humming between tunes.

Other convenient tape functions

Prohibiting tape ejection

You can prohibit the tape ejection and can “lock” a tape in the cassette compartment. Press and hold TAPE and \blacktriangle for more than 2 seconds. “EJECT” flashes on the display for about 5 seconds, and the tape is “locked.”

To cancel the prohibition and “unlock” the tape, press and hold TAPE and \blacktriangle for more than 2 seconds again. “EJECT” flashes again for about 5 seconds, and this time the tape is “unlock.”



Turning on/off the loudness function

The human ear is less sensitive to low and high frequencies at low volumes. The loudness function can boost these frequencies to produce a well-balanced sound at low volume level.

Each time you press LOUD, the loudness function turns on/off alternatively.



Selecting preset sound modes

You can select a preset sound adjustment suitable to the music genre.

Each time you press SOUND, the sound mode changes as follows.

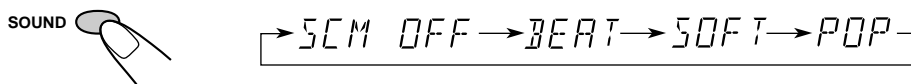

Indication	For:	Preset values		
		Bass	Treble	Loudness
SCM OFF	(Flat sound)	00	00	On
BEAT	Rock or disco music	+2	00	On
SOFT	Quiet background music	+1	-3	Off
POP	Light music	+4	+1	Off

Notes:

- You can adjust the preset sound mode as you like, and store in memory. If you want to adjust and store your original sound mode, see "Storing your own sound adjustments" on page 13.
- To adjust only the bass and treble reinforcement levels as you like, see "Adjusting the sound" on page 12.



Adjusting the sound

You can adjust the treble/bass sounds and the speaker balance.

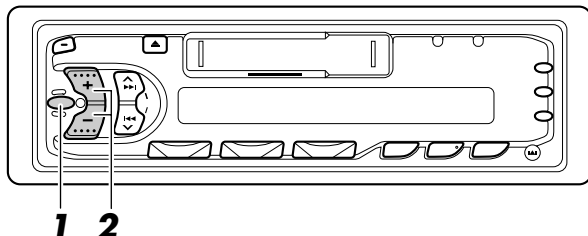

1



Select the item you want to adjust.

→ BAS → TRE → FAD → BAL → VOL

Indication	To do:	Range
BAS (bass)	Adjust the bass	-6 (min.) — +6 (max.)
TRE (treble)	Adjust the treble	-6 (min.) — +6 (max.)
FAD (Fader)*	Adjust the front and rear speaker balance	R6 (rear only) — F6 (front only)
BAL (Balance)	Adjust the left and right speaker balance	L6 (left only) — R6 (right only)
VOL (Volume)	Adjust the volume	00 (min.) — 50 (max.)

Note:

* If you are using a two-speaker system, set the fader level to "00" (center).

2

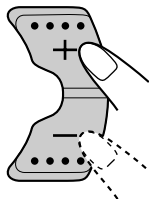

Adjust the level.

Note:

Normally the + and - buttons work as the volume control buttons. So you do not have to select "VOL" to adjust the volume level.

Storing your own sound adjustments

You can adjust the sound modes (BEAT, SOFT, POP: see page 11) as you like and store your own adjustments in memory.

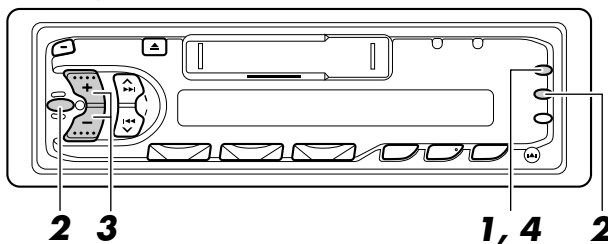

Call up the sound mode you want to adjust.
See page 11 for details.

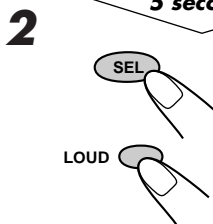

To adjust the bass or treble sound level
Select "BAS" or "TRE."

To turn on or off the loudness function
Each time you press LOUD, the loudness function turns on and off alternatively. (→ go to step 4)

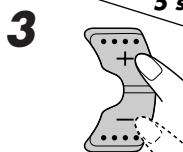

Adjust the bass or treble level.
See page 12 for details.

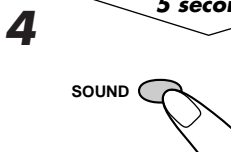

Press and hold SOUND until the sound mode you have selected in step 1 flashes on the display.
Your setting is stored in memory.

5 Repeat the same procedure to store other settings.

To reset to the factory settings

Repeat the same procedure and reassign the preset values listed in the table on page 11.

Setting the clock

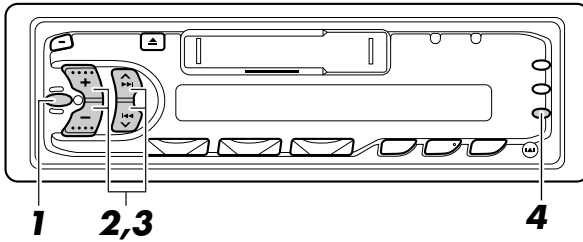

1



Press and hold the button for more than 2 seconds.

"CLOCK H," "CLOCK M" or "AREA" appears on the display.

2

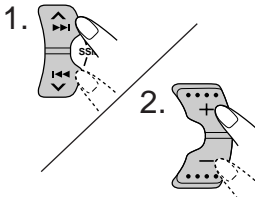

Set the hour.

1. Select "CLOCK H" if not shown on the display.



2. Adjust the hour.

3

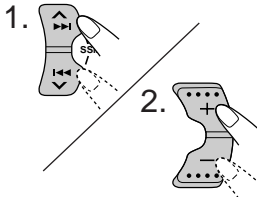

Set the minute.

1. Select "CLOCK M."



2. Adjust the minute.

4

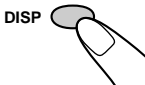

Start the clock.

To check the current clock time (changing the display mode)

Press DISP repeatedly. Each time you press the button, the display mode changes as follows.

<p>During tuner operation: Frequency ↔ Clock</p>	<p>During tape operation: Play mode ↔ Clock</p>	<p>ONLY FOR KS-FX230 During CD operation: Elapsed playing time ↔ Clock</p>
---	--	--

- If the unit is not in use when you press DISP, the power turns on, the clock time is shown for 5 seconds, then the power turns off.

Detaching the control panel

You can detach the control panel when leaving the car. When detaching or attaching the control panel, be careful not to damage the connectors on the back of the control panel and on the panel holder.

How to detach the control panel

Before detaching the control panel, be sure to turn off the power.

- 1 Unlock the control panel.

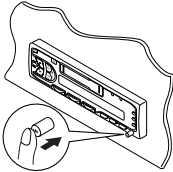

- 2 Pull the control panel out of the unit.

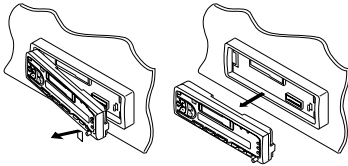

- 3 Put the detached control panel into the provided case.

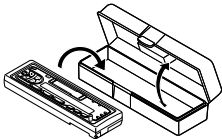

How to attach the control panel

- 1 Insert the left side of the control panel into the groove on the panel holder.

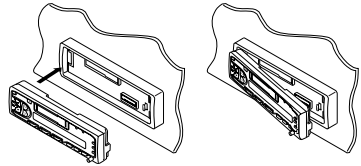

- 2 Press the right side of the control panel to fix it to the panel holder.

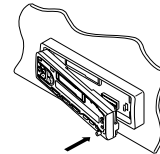

Note on cleaning the connectors:

If you frequently detach the control panel, the connectors will deteriorate.

To minimize this possibility, periodically wipe the connectors with a cotton swab or cloth moistened with alcohol, being careful not to damage the connectors.

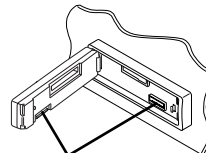

Connectors



CD CHANGER OPERATIONS

This section is **ONLY FOR KS-FX230**, when used with a JVC CD automatic changer (separately purchased).

We recommend that you use one of the CH-X series with your KS-FX230.

If you have another CD automatic changer, consult your JVC car audio dealer for connections.

- For example, if your CD automatic changer is one of the KD-MK series, you need a cord (KS-U15K) for connecting it to this unit.

Before operating your CD automatic changer:

- Refer also to the Instructions supplied with your CD changer.
- If no discs are in the magazine of the CD changer or the discs are inserted upside down, "NO CD" or "NO DISC" will appear on the display. If this happens, remove the magazine and set the discs correctly.
- If "RESET 1 - RESET 8" appears on the display, something is wrong with the connection between this unit and the CD changer. If this happens, check the connection, connect the connecting cord(s) firmly if necessary, then press the reset button of the CD changer.

Playing CDs

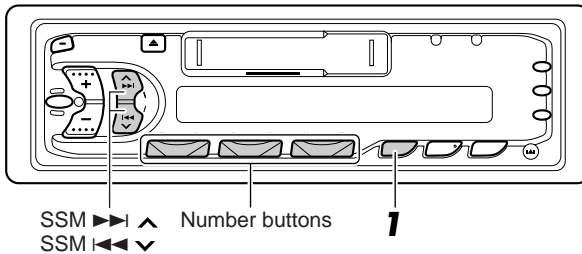

1



Select the CD automatic changer.

Play back starts from the first track of the first disc.

All tracks of all discs are played back.

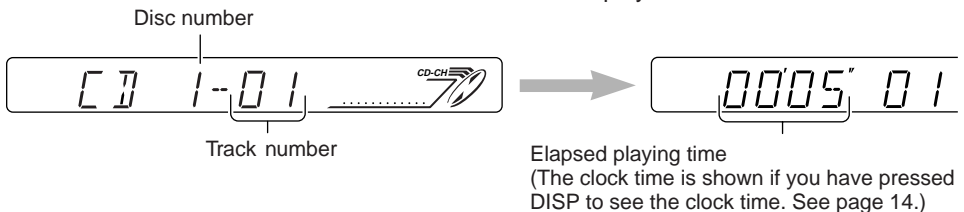

Note on One-Touch Operation:

When you press CD-CH, the power automatically comes on. You do not have to press ATT to turn on the power.



To fast forward or reverse the track

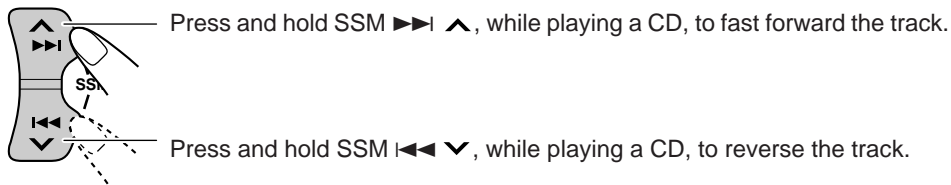

To go to the next track or the previous track

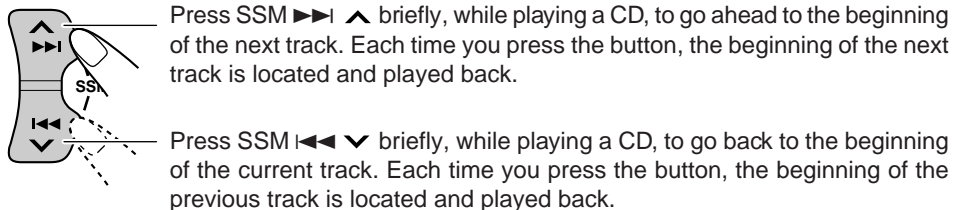

To go to a particular disc directly

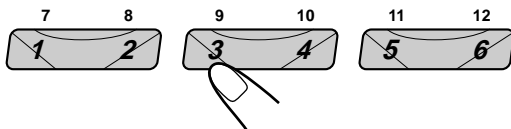

Press the number button corresponding to the disc number to start its playback.

- To select a disc number from 1 – 6:
Press 1 (7) – 6 (12) briefly.
- To select a disc number from 7 – 12:
Press and hold 1 (7) – 6 (12) for more than 1 second.

Ex. When disc number 3 is selected

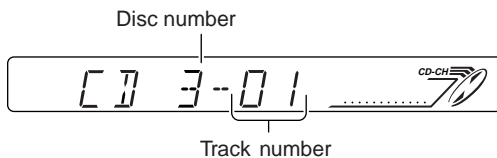



Selecting CD playback modes

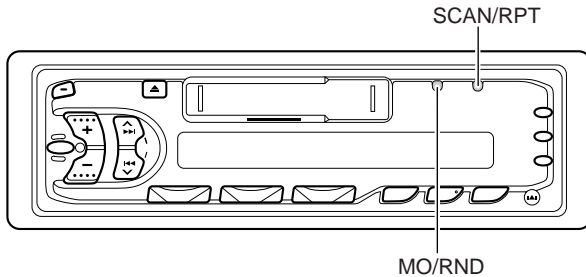

To play back tracks at random (Random Play)

Each time you press MO/RND (Mono/Random) while playing a CD, CD random play mode changes as follows:



Mode	RND Indicator	Plays at random
RND1	Lights	All tracks of the current disc, then the tracks of the next disc, and so on.
RND2	Flashes	All tracks of all discs inserted in the magazine.

To play back tracks repeatedly (Repeat Play)

Each time you press SCAN/RPT (Scan/Repeat) while playing a CD, CD repeat play mode changes as follows:



Mode	RPT Indicator	Plays repeatedly
RPT1	Lights	The current track (or specified track).
RPT2	Flashes	All tracks of the current disc (or specified disc).

To extend the lifetime of the unit

This unit requires very little attention, but you will be able to extend the life of the unit if you follow the instructions below.

To clean the heads

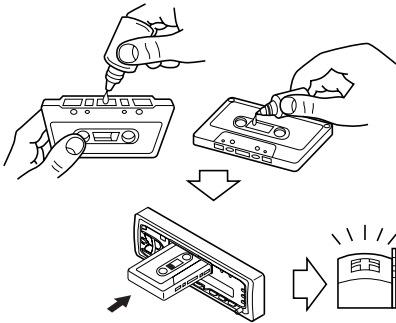

- Clean the heads after every 10 hours of use using a wet-type head cleaning tape (available at an audio store).

When the head becomes dirty, you may realize the following symptoms:

- Sound quality is reduced.
- Sound level decreases.
- Sound drops out.
- Do not play dirty or dusty tapes.
- Do not touch the highly-polished head with any metallic or magnetic tools.

To keep the tape clean

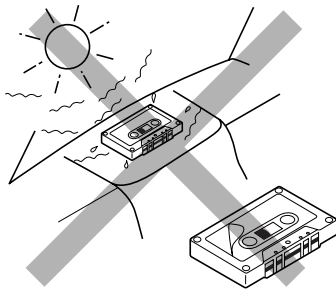

- Always store the tapes to their storage cases after use.
- Do not store tapes in the following places:
 - Subject to direct sunlight
 - With high humidity
 - At extremely hot temperatures

CAUTIONS:

- Do not play the tapes with peeling labels; otherwise, they can damage the unit.
- Tighten tapes to remove slack since loose tape may become entangled with the mechanism.
- Do not leave a cassette in the cassette compartment after use, as the tape may become slack.

The function below is also provided to ensure the longer life of this unit.

Ignition key-off Release/Ignition key-on play

- When you turn off the ignition key with a cassette in the compartment, the unit automatically releases the tape from its head.
- When you turn on the ignition key with a cassette in the compartment, playback automatically starts.



TROUBLESHOOTING

What appears to be trouble is not always serious. Check the following points before calling a service center.

Symptoms	Causes	Remedies
• A cassette tape cannot be inserted.	You have tried to insert a cassette in the wrong way.	Insert the cassette with the exposed tape facing right.
• Cassette tapes become hot.	This is not a malfunction.	—————
• Tape sound is at very low level and sound quality is degraded.	The tape head is dirty.	Clean it with a head cleaning tape.
• Sound is sometimes interrupted.	Connections are not good.	Check the cords and connections.
• Sound cannot be heard from the speakers.	The volume control is turned to the minimum level.	Adjust it to the optimum level.
	Connections are incorrect.	Check the cords and connections.
• SSM (Strong-station Sequential Memory) automatic preset does not work.	Signals are too weak.	Store stations manually.
• Static noise while listening to the radio.	The antenna is not connected firmly.	Connect the antenna firmly.
• “NO CD” or “NO DISC” appears on the display.	No CD is in the magazine.	Insert CDs into the magazine.
	CDs are inserted incorrectly.	Insert them correctly.
• “RESET 8” appears on the display.	This unit is not connected to a CD changer correctly.	Connect this unit and the CD changer correctly and press the reset button of the CD changer.
• “RESET 1-RESET 7” appears on the display.	—————	Press the reset button of the CD changer.
• The unit does not work at all.	The built-in microcomputer may function incorrectly due to noise, etc.	Press ATT and SEL at the same time for more than 2 seconds to reset the unit. (The clock setting and preset stations stored in memory are erased.)

SPECIFICATIONS

AUDIO AMPLIFIER SECTION

Maximum Power Output:

Front: 40 watts per channel

Rear: 40 watts per channel

Continuous Power Output (RMS):

Front: 16 watts per channel into 4 Ω , 40 to 20,000 Hz at no more than 0.8% total harmonic distortion.

Rear: 16 watts per channel into 4 Ω , 40 to 20,000 Hz at no more than 0.8% total harmonic distortion.

Load Impedance: 4 Ω (4 to 8 Ω allowance)

Tone Control Range

Bass: ± 10 dB at 100 Hz

Treble: ± 10 dB at 10 kHz

Frequency Response: 40 to 20,000 Hz

Signal-to-Noise Ratio: 70 dB

Line-Out Level/Impedance: 1.0 V/20 k Ω load (250 nWb/m)

TUNER SECTION

Frequency Range

FM: 87.5 to 107.9 MHz

(with channel interval set to 200 kHz)

87.5 to 108.0 MHz

(with channel interval set to 50 kHz)

AM: 530 to 1,710 kHz

(with channel interval set to 10 kHz)

531 to 1,602 kHz

(with channel interval set to 9 kHz)

[FM Tuner]

Usable Sensitivity: 11.3 dBf (1.0 μ V/75 Ω)

50 dB Quieting Sensitivity:

16.3 dBf (1.8 μ V/75 Ω)

Alternate Channel Selectivity (400 kHz):

65 dB

Frequency Response: 40 to 15,000 Hz

Stereo Separation: 35 dB

Capture Ratio: 1.5 dB

[AM Tuner]

Sensitivity: 20 μ V

Selectivity: 35 dB

CASSETTE DECK SECTION

Wow & Flutter: 0.11% (WRMS)

Fast-Wind Time: 100 sec. (C-60)

Frequency Response:

50 to 16,000 Hz (± 3 dB)

Signal-to-Noise Ratio: 54 dB

Stereo Separation: 40 dB

GENERAL

Power Requirement

Operating Voltage: DC 14.4 volts (11 to 16 volts allowance)

Grounding System: Negative ground

Dimensions (W x H x D)

Installation Size:

182 x 52 x 150 mm

(7-3/16" x 2-1/16" x 5-15/16")

Panel Size: 188 x 58 x 14 mm

(7-7/16" x 2-5/16" x 5/8")

Mass: 1.4 kg (3.1 lbs) (excluding accessories)

Design and specifications subject to change without notice.

If a kit is necessary for your car, consult your telephone directory for the nearest car audio speciality shop.

KS-FX230/F130

CASSETTE RECEIVER

JVC
VICTOR COMPANY OF JAPAN, LIMITED



EN, SP, FR



Printed in Indonesia
0997MNMMDWJEIN

Download from Www.Somanuals.com. All Manuals Search And Download.

Free Manuals Download Website

<http://myh66.com>

<http://usermanuals.us>

<http://www.somanuals.com>

<http://www.4manuals.cc>

<http://www.manual-lib.com>

<http://www.404manual.com>

<http://www.luxmanual.com>

<http://aubethermostatmanual.com>

Golf course search by state

<http://golfingnear.com>

Email search by domain

<http://emailbydomain.com>

Auto manuals search

<http://auto.somanuals.com>

TV manuals search

<http://tv.somanuals.com>