

JVC



COMPACT COMPONENT SYSTEM

MX-KC45

Consists of CA-MXKC45 and SP-MXKC45

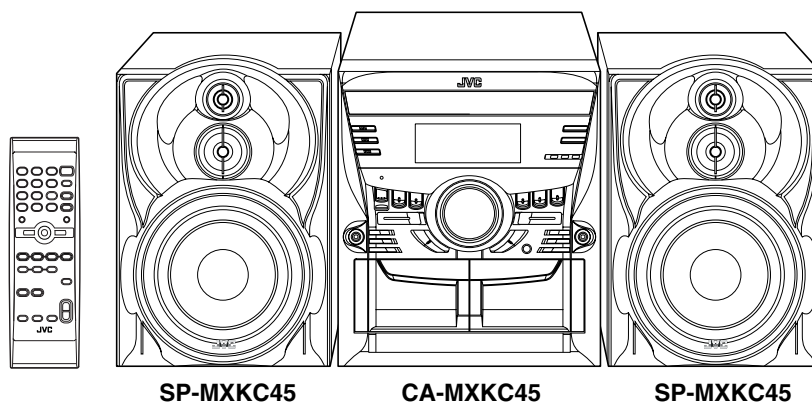

COMPACT
disc
DIGITAL AUDIO

MP3/WMA
PLAY BACK

INSTRUCTIONS

For Customer Use:

Enter below the Model No. and Serial No. which are located either on the rear, bottom or side of the cabinet. Retain this information for future reference.

Model No. _____

Serial No. _____

LVT1521-001A

[J]

Warnings, Cautions and Others / Mises en garde, précautions et indications diverses

(For U.S.A)

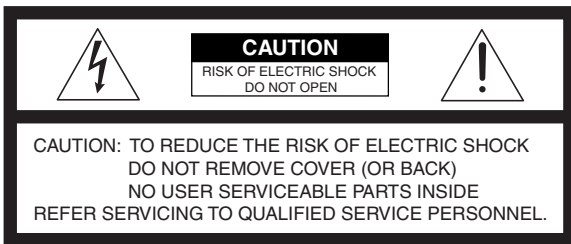

The lightning flash with arrowhead symbol, within an equilateral triangle is intended to alert the user to the presence of uninsulated "dangerous voltage" within the product's enclosure that may be of sufficient magnitude to constitute a risk of electric shock to persons.



The exclamation point within an equilateral triangle is intended to alert the user to the presence of important operating and maintenance (servicing) instructions in the literature accompanying the appliance.

WARNING: TO REDUCE THE RISK OF FIRE OR ELECTRIC SHOCK, DO NOT EXPOSE THIS APPLIANCE TO RAIN OR MOISTURE.

CAUTION

Changes or modifications not approved by JVC could void the user's authority to operate the equipment.

INFORMATION

This equipment has been tested and found to comply with the limits for a Class B digital device, pursuant to Part 15 of the FCC Rules. These limits are designed to provide reasonable protection against harmful interference in a residential installation. This equipment generates, uses, and can radiate radio frequency energy and, if not installed and used in accordance with the instructions, may cause harmful interference to radio communications. However, there is no guarantee that interference will not occur in a particular installation. If this equipment does cause harmful interference to radio or television reception, which can be determined by turning the equipment off and on, the user is encouraged to try to correct the interference by one or more of the following measures:

- Reorient or relocate the receiving antenna.
- Increase the separation between the equipment and receiver.
- Connect the equipment into an outlet on a circuit different from that to which the receiver is connected.
- Consult the dealer or an experienced radio/TV technician for help.

Note to CATV system installer:

This reminder is provided to call the CATV system installer's attention to section 820-40 of the NEC which provides guidelines for proper grounding and, in particular, specifies that the cable ground shall be connected to the grounding system of the building, as close to the point of cable entry as practical.

For Canada/pour le Canada

THIS DIGITAL APPARATUS DOES NOT EXCEED THE CLASS B LIMITS FOR RADIO NOISE EMISSIONS FROM DIGITAL APPARATUS AS SET OUT IN THE INTERFERENCE-CAUSING EQUIPMENT STANDARD ENTITLED "DIGITAL APPARATUS," ICES-003 OF THE DEPARTMENT OF COMMUNICATIONS.

CET APPAREIL NUMERIQUE RESPECTE LES LIMITES DE BRUITS RADIOELECTRIQUES APPLICABLES AUX APPAREILS NUMERIQUES DE CLASSE B PRESCRITES DANS LA NORME SUR LE MATERIEL BROUILLEUR: "APPAREILS NUMERIQUES", NMB-003 EDICTEE PAR LE MINISTRE DES COMMUNICATIONS.

CAUTION — ϕ /I STANDBY/ON button !

Disconnect the mains plug to shut the power off completely (all lamps and indications go off). When installing the product, ensure that the plug is easily accessible. The ϕ /I STANDBY/ON button in any position does not disconnect the mains line.

- When the unit is on standby, the STANDBY lamp lights red.
- When the unit is turned on, the STANDBY lamp goes off.

The power can be remote controlled.

ATTENTION — Touche ϕ /I STANDBY/ON

Déconnectez la fiche de secteur pour mettre l'appareil complètement hors tension (tous les témoins et toutes les indications s'éteignent). Lors de l'installation de l'appareil, assurez-vous que la fiche soit facilement accessible. La touche ϕ /I STANDBY/ON dans n'importe quelle position ne déconnecte pas l'appareil du secteur.

- Quand l'appareil est en mode d'attente, le témoin STANDBY est allumé en rouge.
- Quand l'appareil est sous tension, le témoin STANDBY s'éteint.

L'alimentation ne peut pas être commandée à distance.

IMPORTANT FOR LASER PRODUCTS / IMPORTANT POUR PRODUITS LASER

1. CLASS 1 LASER PRODUCT
 2. **CAUTION:** Do not open the top cover. There are no user serviceable parts inside the unit; leave all servicing to qualified service personnel.
 3. **CAUTION:** VISIBLE AND / OR INVISIBLE CLASS 1M LASER RADIATION WHEN OPEN. DO NOT STARE INTO BEAM OR VIEW DIRECTLY WITH OPTICAL INSTRUMENTS.
 4. REPRODUCTION OF LABEL: CAUTION LABEL, PLACED INSIDE THE UNIT.
1. PRODUIT LASER CLASSE 1
 2. **ATTENTION:** N'ouvrez pas le couvercle supérieur. Il n'y a aucune pièce réparable par l'utilisateur à l'intérieur de l'appareil; confiez toute réparation à un personnel qualifié.
 3. **ATTENTION:** RAYONNEMENT LASER VISIBLE ET / OU INVISIBLE DE CLASSE 1M UNE FOIS OUVERT. NE PAS FIXER LE FAISCEAU NI REGARDER DIRECTEMENT AVEC DES INSTRUMENTS OPTIQUES.
 4. REPRODUCTION DE L'ÉTIQUETTE: ÉTIQUETTE DE PRÉCAUTION PLACÉE À L'INTERIEUR DE L'APPAREIL.

CAUTION VISIBLE AND / OR INVISIBLE CLASS 1M LASER RADIATION WHEN OPEN. DO NOT STARE INTO BEAM OR VIEW DIRECTLY WITH OPTICAL INSTRUMENTS. (ENG)	VARNING SYNBLIG OCH/ELLER OSYNBLIG LASERSTRÅLNING. KLASS 1M, NÄR DENNA DEL ÄR ÖPPNAD. STIRRA EJ IN I STRÅLEN OCH BETRÄKTA EJ STRÅLEN MED OPTISKA INSTRUMENT. (SWE)	AVISO RADIACIÓN LASER DE CLASE 1M VISIBLE Y/O INVISIBLE. CUANDO ESTA ABIERTO, NO MIRAR FJAJEMENTE EL HAZ NI OBSERVAR DIRECTAMENTE CON INSTRUMENTAL OPTICO. (ESP)	ADVARSEL SYNLIG OG/ELLER USYNLIG KLASSE 1M-LASERSTRÅLING VED ÅBNING. SE IKKE IND I STRÅLEN - HELLER IKKE MED OPTISKE INSTRUMENTER. (DNK)	VARO! AVATTAESSA OLET ALTUINA NÄKYVÄLLE JÄLTAI NÄKYMÄTTÖMÄLLE LUOKAN 1M LASERSÄTEILYLLÄ. ÄLÄ KATSO SUORAAN SÄTEESEEN TAI TARKASTELE SITÄ OPTISEN LAITTEEN LAPI. (FIN)	ATTENTION RAYONNEMENT LASER VISIBLE ET / OU INVISIBLE DE CLASSE 1M UNE FOIS OUVERT. NE PAS FIXER LE FAISCEAU NI REGARDER DIRECTEMENT AVEC DES INSTRUMENTS OPTIQUES. (FRA)
---	---	--	--	---	--

CAUTION

To reduce the risk of electrical shocks, fire, etc.:

1. Do not remove screws, covers or cabinet.
2. Do not expose this appliance to rain or moisture.
3. To prevent electric shock, match wide blade of plug to wide slot, fully insert.

CAUTION

1. Do not block the ventilation openings or holes.
(If the ventilation openings or holes are blocked by a newspaper or cloth, etc., the heat may not be able to get out.)
2. Do not place any naked flame sources, such as lighted candles, on the apparatus.
3. When discarding batteries, environmental problems must be considered and local rules or laws governing the disposal of these batteries must be followed strictly.
4. Do not expose this apparatus to rain, moisture, dripping or splashing and that no objects filled with liquids, such as vases, shall be placed on the apparatus.

ATTENTION

Afin d'éviter tout risque d'électrocution, d'incendie, etc.:

1. Ne pas enlever les vis ni les panneaux et ne pas ouvrir le coffret de l'appareil.
2. Ne pas exposer l'appareil à la pluie ni à l'humidité.
3. Pour éviter tout risque d'électrocution, faites correspondre la fiche large de la prise à la fente large puis insérez-la complètement.

ATTENTION

1. Ne bloquez pas les orifices ou les trous de ventilation.
(Si les orifices ou les trous de ventilation sont bloqués par un journal un tissu, etc., la chaleur peut ne pas être évacuée correctement de l'appareil.)
2. Ne placez aucune source de flamme nue, telle qu'une bougie, sur l'appareil.
3. Lors de la mise au rebut des piles, veuillez prendre en considération les problèmes de l'environnement et suivre strictement les règles et, les lois locales sur la mise au rebut des piles.
4. N'exposez pas cet appareil à la pluie, à l'humidité, à un égouttement ou à des éclaboussures et ne placez pas des objets remplis de liquide, tels qu'un vase, sur l'appareil.

Caution: Proper Ventilation

To avoid risk of electric shock and fire, and to prevent damage, locate the apparatus as follows:

1. Front:
No obstructions and open spacing.
2. Sides/ Top/ Back:
No obstructions should be placed in the areas shown by the dimensions below.
3. Bottom:
Place on the level surface. Maintain an adequate air path for ventilation by placing on a stand with a height of 10cm (3¹⁵/₁₆ in.) or more.

Attention: Aération correcte

Pour prévenir tout risque de décharge électrique ou d'incendie et éviter toute détérioration, installez l'appareil de la manière suivante:

1. Avant:
Bien dégagé de tout objet.
2. Côtés/dessus/dessous:
Assurez-vous que rien ne bloque les espaces indiqués sur le schéma ci-dessous.
3. Dessous:
Posez l'appareil sur une surface plane et horizontale. Veillez à ce que sa ventilation correcte puisse se faire en le plaçant sur un support d'au moins dix centimètres de hauteur.

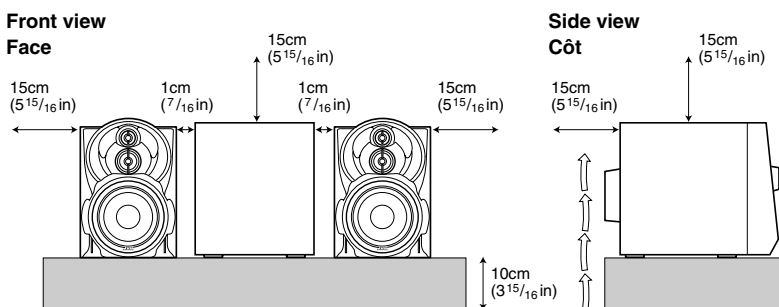

About the cooling fan

A cooling fan is mounted on the rear panel of the unit to prevent abnormal temperature inside the unit, thus assuring normal operation of the unit. The cooling fan automatically starts rotating to intake external cool air when the volume is increased up to more than a certain level.

À propos du ventilateur de refroidissement

Un ventilateur de refroidissement se trouve sur le panneau arrière de l'appareil afin d'éviter la création d'une température anormale à l'intérieur de l'appareil et permettre ainsi un fonctionnement normal de l'appareil. Le ventilateur de refroidissement commence à tourner et à aspirer de l'air frais automatiquement quand le volume est augmenté au-dessus d'un certain niveau.



[European Union only]

Introduction

Thank you for purchasing the JVC Compact Component System.
We hope it will be a valued addition to your home, giving you years of enjoyment.
Be sure to read this instruction manual carefully before operating your new stereo system.
In it you will find all the information you need to set up and use the system.
If you have a query that is not answered by the manual, please contact your dealer.

Features

Here are some of the things that make your System both powerful and simple to use.

- The controls and operations have been redesigned to make them very easy to use, freeing you to just enjoy the music.
 - With JVC's COMPU PLAY you can turn on the System and automatically start the Radio, Cassette Deck, or CD Player with a single touch.
- The great SEA (Sound Effect Amplifier) effects Rock, Pop and Classics are provided.
- The Sound Turbo function provides emphasized rich sound.
- A 45-station preset capability (30 FM and 15 AM) in addition to auto-seek and manual tuning.
- CD changer function can operate 3 discs.
 - Discs can be changed during play using the Carrousel tray (rotational tray).
- Two Decks enabling tape dubbing.
- Timer functions; Daily Timer, REC (Recording) Timer, and Sleep Timer.
- You can connect various external units, such as an MD recorder.
- The CD Player can play back a CD-R and CD-RW.



How This Manual Is Organized

- Basic information that is the same for many different functions - e.g. setting the volume - is given in the section "Basic Operations", and not repeated under each function.
- The names of buttons/controls and display messages are written in all capital letters: e.g. FM/AM, "NO DISC".
- If the button names on the Unit and the Remote Control are the same, the description on where the button is used will be omitted.
- System functions are written with an initial capital letter only: e.g. Normal Play.

Use the table of contents to look up specific information you require.

We have enjoyed making this manual for you, and hope it serves you in enjoying the many features built into your System.

IMPORTANT CAUTIONS

1 Installation of the System

- Select a place which is level, dry and neither too hot nor too cold. (Between 5°C and 35°C or 41°F and 95°F.)
- Leave sufficient distance between the System and a TV.
- Do not use the System in a place subject to vibrations.

2 Power cord

- Do not handle the power cord with wet hands!
- Some power is always consumed as long as the power cord is connected to the wall outlet.
- When unplugging the System from the wall outlet, always pull the plug, not the power cord.

3 Malfunctions, etc.

- There are no user serviceable parts inside. In case of system failure, unplug the power cord and consult your dealer.
- Do not insert any metallic object into the System.

Table of Contents

Introduction	1
Features.....	1
How This Manual Is Organized.....	1
IMPORTANT CAUTIONS.....	1
Table of Contents	2
Getting Started	3
Accessories	3
How To Put Batteries In the Remote Control.....	3
Using the Remote Control	3
Connecting the FM Antenna.....	4
Connecting the AM Antenna.....	5
Connecting the Speakers	5
Connecting External Equipment.....	6
Connecting to the Wall Outlet.....	6
DEMO Mode	6
COMPU Play.....	6
Basic Operations.....	7
Turning the Power On and Off.....	7
ECO Mode (ECO)	7
Adjusting the Volume.....	8
Fade-out Muting (FADE MUTING)	8
Emphasizing the sound (SOUND TURBO).....	8
Selecting the Sound Mode (SOUND MODE).....	8
Entering the Number with the Remote Control (Numeric Keys).....	8
Changing the Display	8
Using the Tuner	9
Tuning In a Station	9
Presetting Stations	10
To Change the FM Reception Mode	10
Using the CD Player	11
To Load CDs	12
To Unload CDs.....	12
Changing the MP3/WMA Playback Mode.....	12
Basics of Using the CD Player-Normal Play.....	13
Resume Play for Audio CD and MP3/WMA Disc.....	14
Programming the Playing Order of the Tracks.....	14
Random Play.....	15
Repeating Tracks	15
Tray Lock Function	15
Using the Cassette Deck (Listening to a Tape)	16
Playing a Tape	16
Using the Cassette Deck (Recording)	17
Standard Recording	18
CD Synchro Recording.....	18
Tape to Tape Recording (DUBBING).....	18
Using an External Equipment	19
Listening to the External Equipment	19
Using the Timers	20
Setting the Clock	20
Fixing the Clock	20
Setting the Daily Timer	21
Setting the REC (Recording) Timer	22
Setting the SLEEP Timer	24
Timer Priority	24
Care And Maintenance.....	25
Troubleshooting	26
Specifications	Back cover

Getting Started

Accessories

Make sure that you have all of the following items, which are supplied with the System.

- AM Loop Antenna (1)
- FM Wire Antenna (1)
- Remote Control (1)
- Batteries (2)

If any of these items are missing, contact your dealer immediately.

How To Put Batteries In the Remote Control

Match the polarity (+ and -) on the batteries with the + and - markings in the battery compartment.

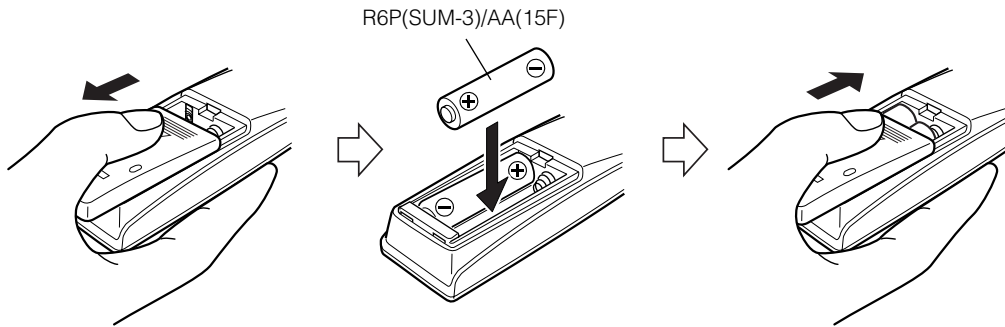

CAUTION:

- Handle batteries properly.

❑ To avoid battery leakage or explosion:

- Remove batteries when the Remote Control will not be used for a long time.
- When you need to replace the batteries, replace both batteries at the same time with new ones.
- Do not use an old battery with a new one.
- Do not use different types of batteries together.

Using the Remote Control

The Remote Control makes it easy to use many of the functions of the System from a distance of up to 7m (23 feet) away. You need to point the Remote Control at the remote sensor on the System's front panel.

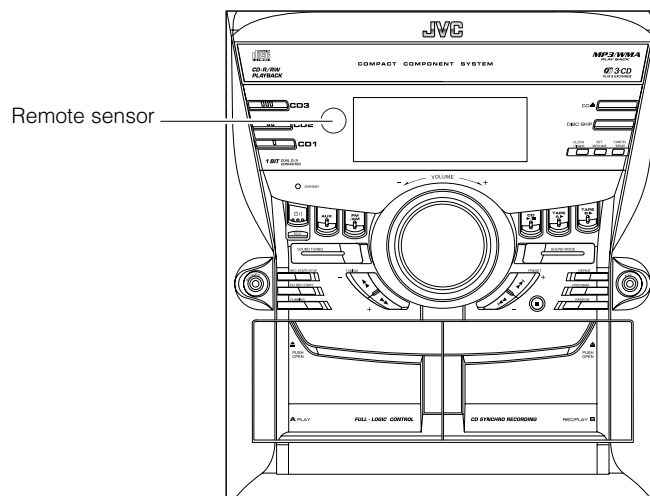

CAUTION:

- Make all connections before plugging the System into an AC power outlet.

Connecting the FM Antenna

Using the Supplied Wire Antenna

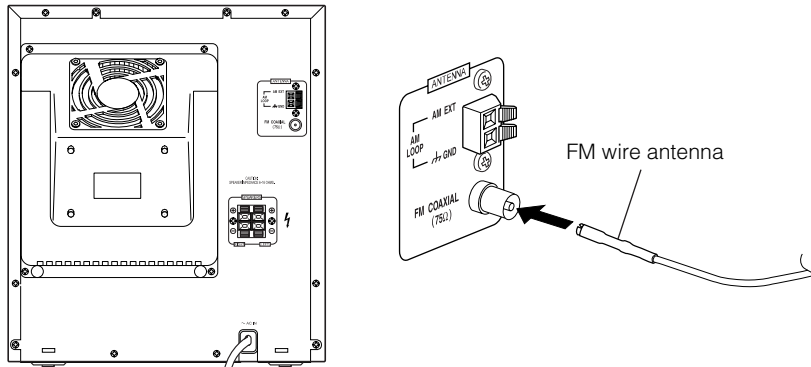

Using the Coaxial Type Connector (Not supplied)

A 75Ω antenna with coaxial type connector (IEC or DIN45 325) should be connected to the FM 75Ω COAXIAL terminal.

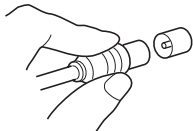

If reception is poor, connect the outdoor antenna.

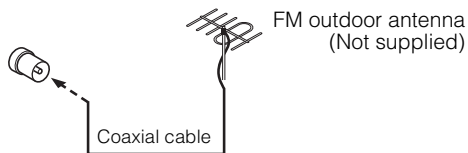

Note

- Before attaching a 75 ohm coaxial lead (the kind with a round wire going to an outdoor antenna), disconnect the supplied FM Wire Antenna.
-

Connecting the AM Antenna

Rear Panel of the Unit

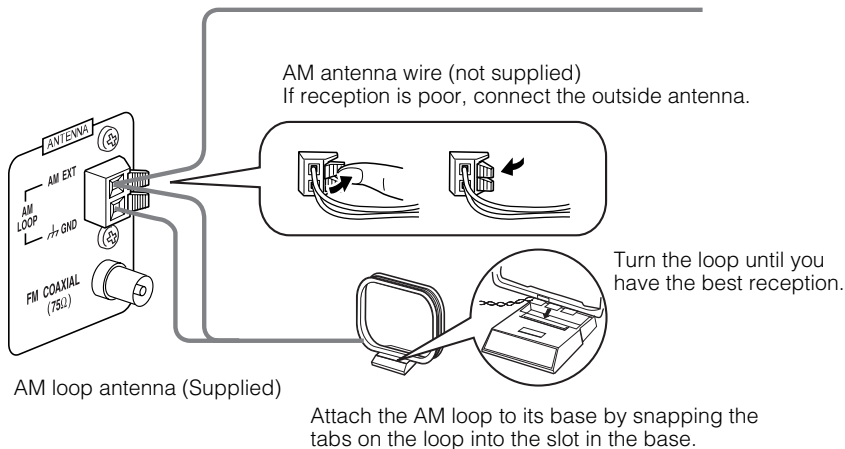
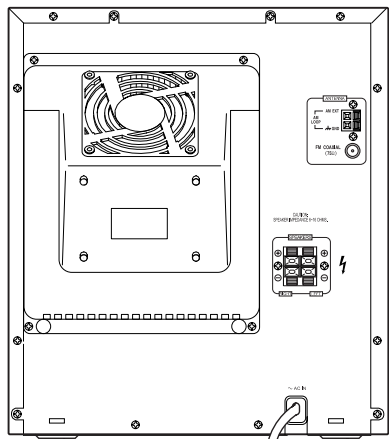

Note

- Even when connecting an outside AM antenna, keep the indoor AM loop connected.

CAUTION:

- To avoid noise, keep antennas away from the System, the connecting cord and the AC power cord.

Connecting the Speakers

1. Open each of the terminals to connect the speaker wire leads.
2. Connect the speaker cords to the Speaker terminals of the Unit.
Connect the gray (+) and gray with black stripe (-) cords of the right side speaker to the red (+) and black (-) terminals marked RIGHT on the System.
Connect the gray (+) and gray with black stripe (-) cords of the left side speaker to the red (+) and black (-) terminals marked LEFT on the System.
3. Close each of the terminals.

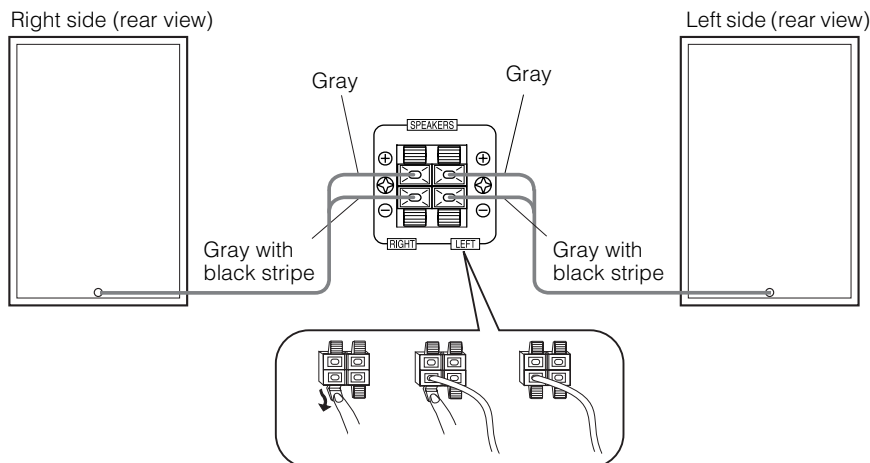

CAUTIONS:

- A TV may display irregular colors if located near the speakers. If this happens, set the speakers away from the TV.
- Use speakers with the correct impedance only. The correct impedance is indicated on the rear panel.

Connecting External Equipment

Connect a signal cord with stereo mini plugs (not supplied) between the System's AUX jack on the front panel and the audio output jack or output terminals of the external portable CD, MD player, STB, etc. You can then listen to the external source through the System.

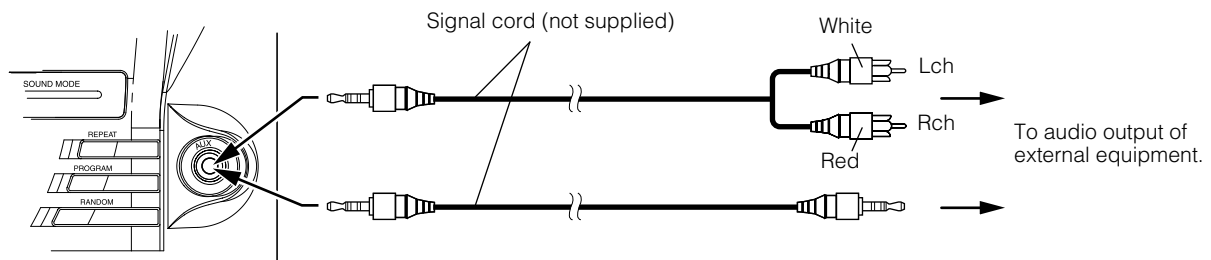

Connecting to the Wall Outlet

Plug the AC power cord into the wall outlet. Now, your System is at your command!

DEMO Mode

When the System is connected to the wall outlet, a DEMO mode displaying some of the system's features automatically starts.

To turn the DEMO display off, press any of the operation buttons. The DEMO display automatically stops.

To turn the DEMO display on, press the DEMO button on the Unit for more than 2 seconds.

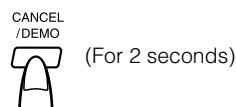

Note

- While the System is turned on, the DEMO display will automatically start if no operation is made for 2 minutes. To cancel this auto DEMO display function, press the CANCEL button on the Unit during DEMO display.

COMPU Play

JVC's COMPU PLAY feature lets you control the most frequently used System functions with a single touch.

With One Touch Operation you can play a CD, a tape, turn on the radio, or listen to an external equipment with a single press of the play button for that function. One Touch Operation turns the power on for you, then starts the function you have specified. If the System is not ready (no CD or tape in place), the System still powers on so you can insert a CD or tape.

How One Touch Operation works in each case is explained in the section dealing with that function.

The COMPU PLAY buttons are:

On the Unit

- CD ►/|| button
- FM/AM button
- TAPE A ►, TAPE B ► buttons
- AUX button
- CD1, CD2 and CD 3 buttons
- CD Open/Close ▲ button

On the Remote Control

- CD ►/|| button
- FM/AM button
- TAPE A, TAPE B buttons
- AUX button
- CD1, CD2 and CD 3 buttons

Basic Operations

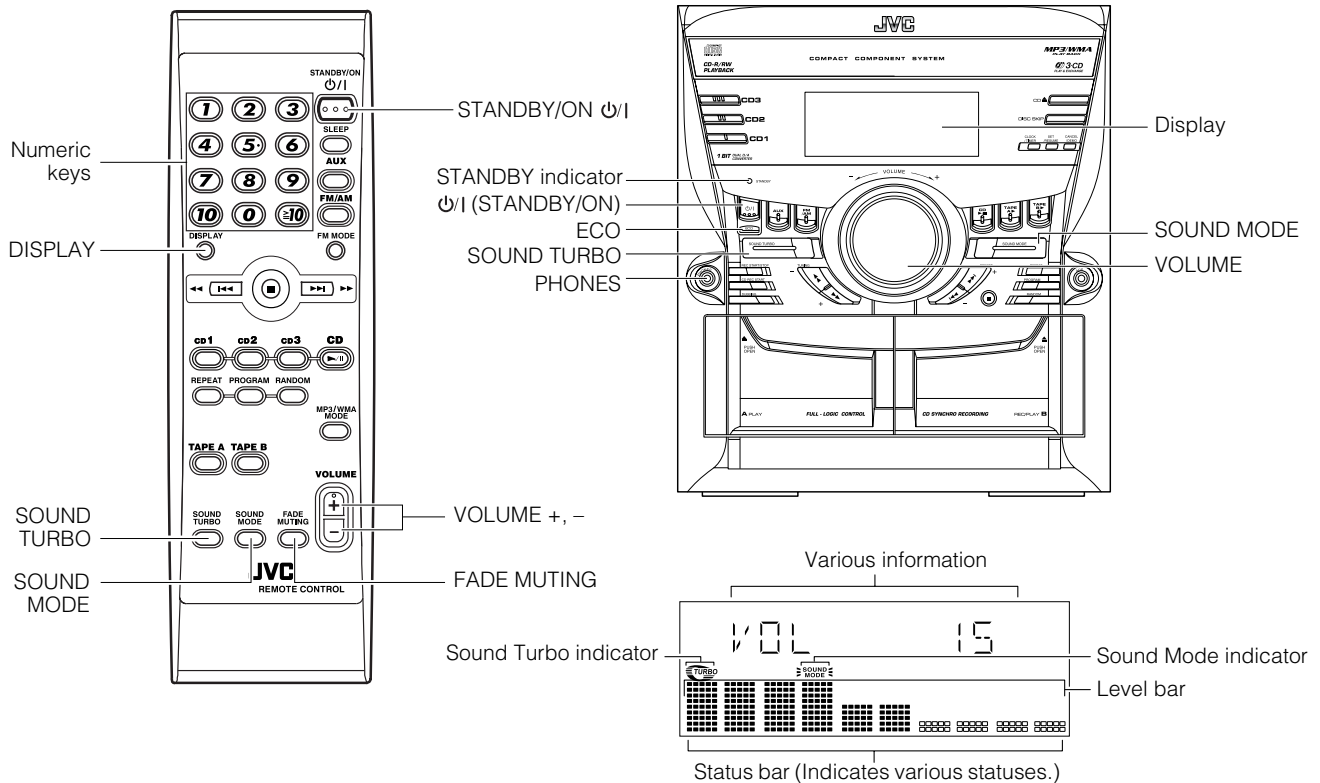

* When the System is in use, the display shows other items as well. For simplicity, we show here only the items described in this section.

Turning the Power On and Off

Turning the System On

- 1 Press the ϕ /I STANDBY/ON button.

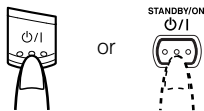

The display comes on and "POWER ON" is displayed once. The STANDBY indicator goes out. The System comes on ready to continue in the mode it was in when the power was last turned off.

Turning the System Off

- 1 Press the ϕ /I STANDBY/ON button again.

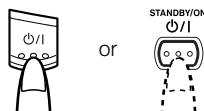

"GOOD BYE" is displayed and the display goes out, except for the clock display. The STANDBY indicator lights up. (The display is dimmed.)

- Some power is always consumed even though power is turned off (called Standby mode).
- To switch off the System completely, unplug the AC power cord from the wall outlet. When you unplug the AC power cord, the clock will be reset to AM 12:00 immediately.

ECO Mode (ECO)

The System has three energy modes; power on, power off (Standby) and ECO. In ECO mode, the display goes off and the least power is consumed.

To enter ECO mode, press the ECO button on the Unit in Standby mode (while the STANDBY indicator lights up). "ECO MODE" appears on the display, then the display goes off. The STANDBY indicator remains lit.

To cancel ECO mode and turn on the power, press the ϕ /I STANDBY/ON button on the Unit.

To cancel ECO mode and enter Standby mode, press the ECO button again.

Adjusting the Volume

Turn the VOLUME control on the Unit clockwise to increase the volume or turn it counterclockwise to decrease the volume.

Press the VOLUME + button on the Remote Control to increase the volume or press the VOLUME – button on the Remote Control to decrease the volume.



You can set the volume level to MIN, 1-30, or MAX.



- When you turn the power off at a volume level of over 19, the volume level is automatically set to 19 when the power is turned back on.

CAUTIONS:

- **DO NOT** turn on the System and/or start playing any source without first setting the VOLUME control to minimum, as a sudden blast of sound could damage your hearing, speakers and/or headphones.

For private listening

Connect a pair of headphones to the PHONES jack. No sound comes out of the speakers.

Be sure to turn down the volume before connecting or putting on headphones.

Fade-out Muting (FADE MUTING)

You can mute the output with one touch operation.

To muting the output, press the FADE MUTING button on the Remote Control. The output is faded out.

To release muting, press the FADE MUTING button once again. The output is faded in to the previous level.

- After Fade-out Muting, turning the VOLUME control on the unit or pressing the VOLUME button on the Remote Control will increase the volume from the previous level.

Emphasizing the sound (SOUND TURBO)

High and low frequencies are highly boosted.

To get the effect, press the SOUND TURBO button. The SOUND TURBO indicator lights up and “S-TURBO” appears on the display.

To cancel the effect, press the button again. The SOUND TURBO indicator goes out and “OFF” appears on the display.

Selecting the Sound Mode (SOUND MODE)

You can select one of 3 SEA (Sound Effect Amplifier) modes. You can use this effect only for playback.

To get the effect, press the SOUND MODE button until Sound Mode you want appears on the display.

The SOUND MODE indicator lights up in the display.

Each time you press the button, the SOUND MODE changes as follows:

ROCK → POP → CLASSIC → FLAT → (back to the beginning)

To cancel the effect, press the SOUND MODE button until “FLAT” appears on the display.

The “SOUND MODE” indicator goes off.

ROCK	Boosts low and high frequencies. Good for acoustic music.
POP	Good for vocal music.
CLASSIC	Set for wide and dynamic sound stereo systems.
FLAT	No sound effect applies.

Entering the Number with the Remote Control (Numeric Keys)

You will use the number keys on the Remote Control to enter numbers for presetting stations, recalling the preset stations, or programming the playing tracks on CDs.

How to enter the number with the number keys is explained here.

Examples:

- To enter number 5, press 5.
- To enter number 15, press $\geq 10 \rightarrow 1 \rightarrow 5$.
- To enter number 20, press $\geq 10 \rightarrow 2 \rightarrow 0$.
(For MP3/WMA disc only)
- To enter number 125, press ≥ 10 (2 times) $\rightarrow 1 \rightarrow 2 \rightarrow 5$.

Changing the Display

On the Remote Control ONLY

Each time you press the DISPLAY button, the display changes as shown below:

Currently selected source ↔ Current time

Using the Tuner

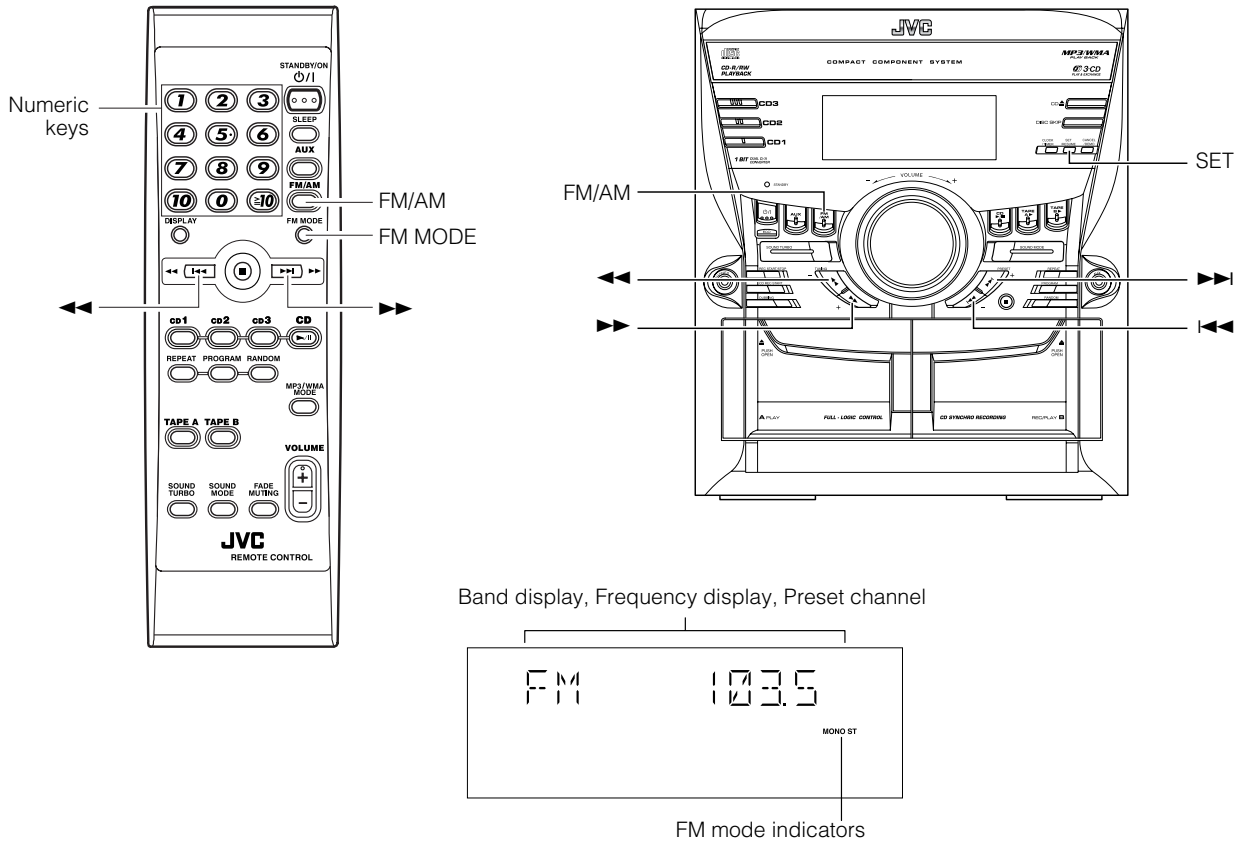

* When the System is in use, the display shows other items as well. For simplicity, we show here only the items described in this section.

You can listen to FM and AM stations. Stations can be tuned in manually, automatically, or from preset memory storage.

Before listening to the radio:

- Make sure that both the FM and AM antennas are correctly connected. (See pages 4 and 5.)

One Touch Radio

Just press the FM/AM button to turn on the System and start playing the station you were last tuned to.

You can switch from any other sound source to the radio by pressing the FM/AM button.

Tuning In a Station

1 Press the FM/AM button.

The Band and Frequency you were last tuned to appear on the display.

Each time you press the button, the band alternates between FM and AM.

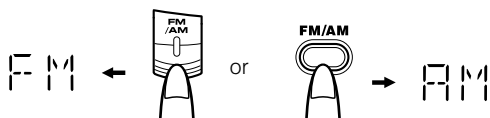

2 Select a station using one of the following methods.

• Manual Tuning

Briefly press the ◀◀ or ▶▶ button to move from frequency to frequency until you find the station you want.

OR

• Auto Tuning

If you hold down the ◀◀ or ▶▶ button for 1 second or more and then release it, the frequency changes down, or up, automatically until a station is found.

OR

• Preset Tuning (Possible only after presetting stations)

Preset tuning using the Unit:

Select the preset number you want, using the ◀◀ or ▶▶ button.

Example:

Press the ▶▶ button until the preset number "P-12" appears on the display. Then, the display will show the preset number's band and frequency.

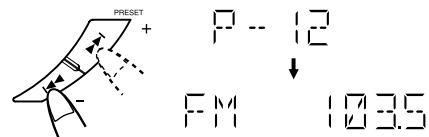

Preset tuning using the Remote Control:

Enter the preset number you want to recall using the numeric keys. See "Entering the Number with the Remote Control" on page 8.

Note

- In AM broadcast, reception sensitivity will be changed by turning the AM loop antenna. Turn the AM loop antenna for best reception.

Presetting Stations

You can preset up to 30 FM stations and up to 15 AM stations.

Notes

- Preset numbers may have been set to factory test frequencies prior to shipment. This is not a malfunction. You can preset the stations you want into memory by following one of the presetting methods below.
- During presetting stations, if no button operation is made for 5 seconds, the display returns to the band/frequency display. In this case, repeat steps from the beginning.

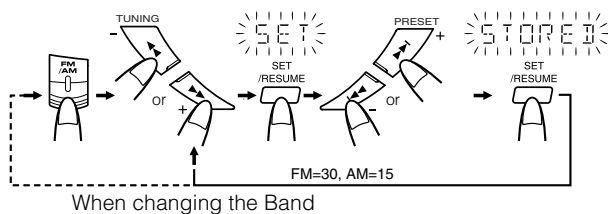
**On the Unit**

- Select a band by pressing the FM/AM button.
- Press the ◀◀ or ▶▶ button to tune in a station.
- Press the SET button.
“SET” will blink for 5 seconds.
- While “SET” is blinking, press the ◀◀ or ▶▶ button to select the preset number.
 - ▶▶: Increases the preset number by 1.
 - ◀◀: Decreases the preset number by 1.
- Press the SET button.
“STORED” appears and, after 2 seconds, the display returns to the band/frequency display.
- Repeat above steps 2 to 5 for each station you want to store in memory with a preset number.

To change the preset stations, repeat the same steps as above.

Note

- In step 4, you can select the preset number using the numeric keys on the Remote Control. See “Entering the Number with the Remote Control” on page 8.

CAUTION:

- Even if the System is unplugged or if the power failure occurs, the preset stations will be stored for a few days. However, in case the preset stations are erased, you will need to preset the stations again.

To Change the FM Reception Mode

When you are tuned in to an FM stereo broadcast, the “ST (Stereo)” indicator lights up and you can hear stereo effects. If an FM stereo broadcast is hard to receive or noisy, you can select Monaural mode. Reception improves, but you lose stereo effect.

Press the FM MODE button on the Remote Control so that the “MONO” indicator lights up on the display.

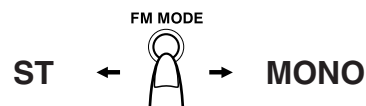

To restore the stereo effect, press the FM MODE button on the Remote Control so that the “MONO” indicator goes off.

Using the CD Player

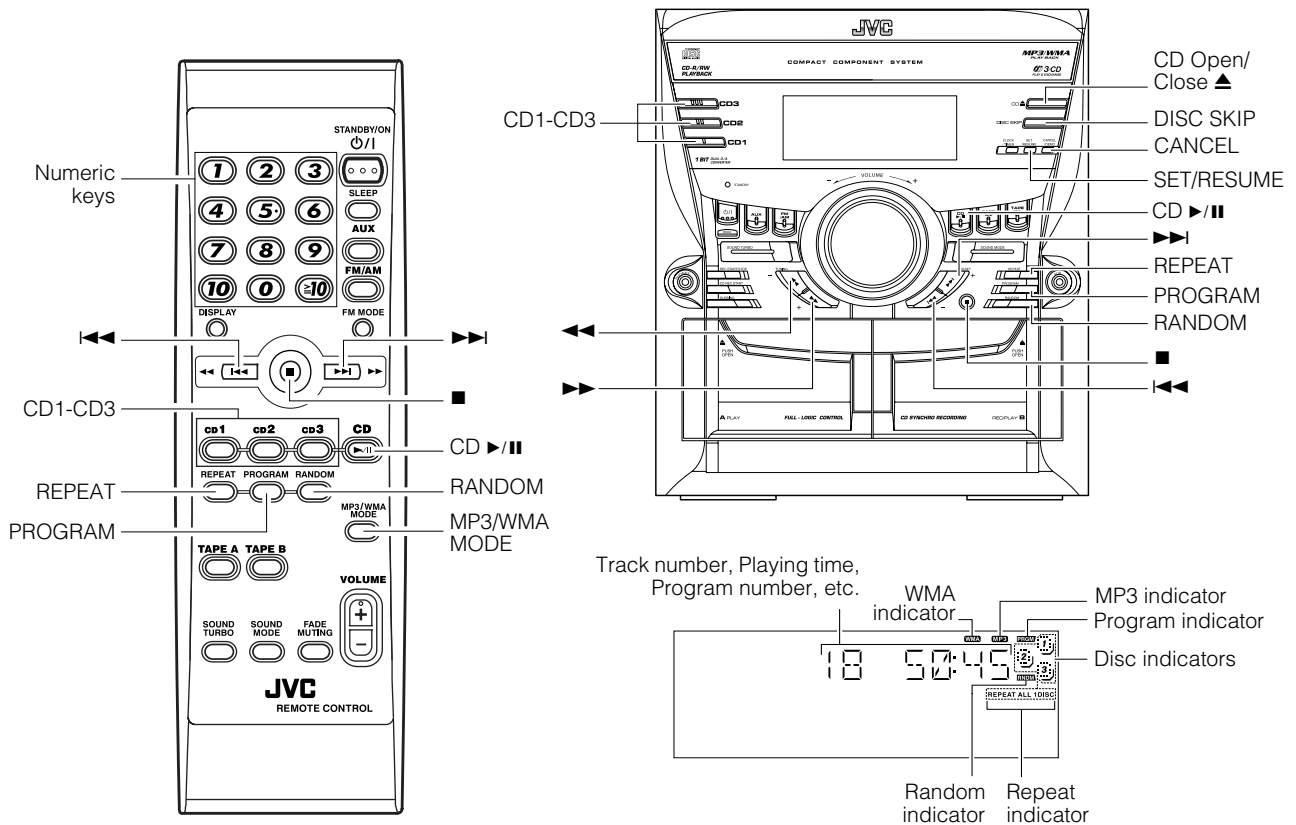

* When the System is in use, the display shows other items as well. For simplicity, we show here only the items described in this section.

This unit has been designed to playback the following CDs:

- Audio CD
- CD-R (CD-Recordable)
- CD-RW (CD-ReWritable)
- MP3/WMA disc (MP3/WMA files recorded on a CD-R or CD-RW)*



Only CDs bearing these marks can be used with this System. However, continued use of irregular shape CDs (heart-shape, octagonal, etc.) can damage the System.

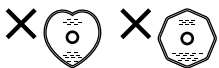

When playing a CD-R or CD-RW

- User-edited CD-Rs (CD-Recordable) and CD-RWs (CD-ReWritable) can be played back when they are already “finalized.”
- Before playing back CD-Rs or CD-RWs, read their instructions or cautions carefully.
- Some CD-Rs or CD-RWs may not be played back on this unit because of their disc characteristics, damage or stain on them, or if the player’s lens is dirty.
- CD-RWs may require a longer readout time since the reflectance of CD-RWs is lower than for regular CDs.

*For MP3/WMA discs

- This unit manages files and folders on MP3/WMA discs as “tracks” and “albums.”
- Playback order of the MP3/WMA files (tracks) recorded on a disc are determined by the writing (or encoding) application; therefore, playback order may be different from the one you have intended while recording the files and the folders.
- This unit shows the file (track) names and ID3v2 tags (only “Title”, “Artist” and “Album”) on the display after starts play; however, there is a limitation on available characters and some file names and ID3 tags are not shown correctly.

Notes

More about MP3/WMA discs

- MP3/WMA discs (either CD-R or CD-RW) require a longer readout time. (It varies due to the complexity of the recording configuration.)
- When making an MP3/WMA disc, select ISO 9660 Level 1 or Level 2 as the disc format.
- This unit does not support multisession recording.
- This unit can play MP3/WMA files only with the following file extensions— “.mp3” and “.wma”.
- Non-MP3/WMA files are ignored. If non-MP3/WMA files are recorded together with MP3/WMA files, this unit will take a longer time to scan the disc. It may also cause the unit to malfunction.
- Some MP3/WMA discs may not be played back because of their disc characteristics or recorded conditions.

Caution for DualDisc playback

The Non-DVD side of a “DualDisc” does not comply with the “Compact Disc Digital Audio” standard. Therefore, the use of Non-DVD side of a DualDisc on this product may not be recommended.

About Disc Indicator:

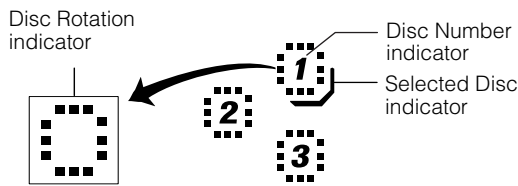

The Disc indicator consists of the following three kinds of indicators:

Disc Number indicator: Lights all the time.

Selected Disc indicator: Lights for the currently selected disc number.

Disc Rotation indicator: Runs when the selected CD is playing or paused. This indicator goes out if a CD is not loaded for the selected disc number.

One Touch Play

The power comes on, and operations are done automatically.

- ❑ By pressing the CD ►/|| button, the System will come on, and if a CD is loaded for the disc number that was lastly selected, it will start playing from the first track.
- ❑ By pressing the CD1-CD3 button, the System will come on, and if a CD is already loaded for the selected disc number, it will start play from the first track.

To Load CDs

1 Press the CD Open/Close ▲ button on the Unit to open the tray.

2 Place one or two CDs, with its label side up, onto the tray.

Be sure that the CD is securely seated inside the recess on the disc tray.

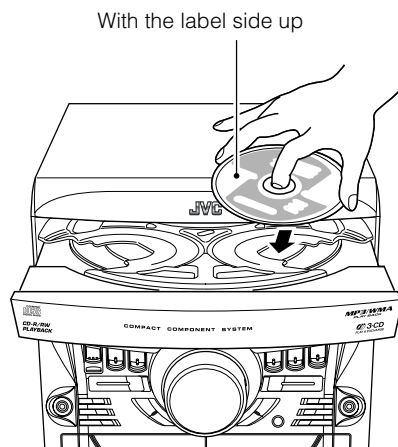

3 Press the DISC SKIP button on the Unit and place the next CD.

When you press the button, the tray turns for the next CD.

4 Press the CD Open/Close ▲ button on the Unit.

The tray is closed.

- ❑ When you use an 8 cm (3") CD, place it on the inner circle of the tray.
- ❑ You can load CDs while listening to the other source or while listening to the CD being played back.
- ❑ When power is turned off with the tray opened, the tray is automatically closed.
- ❑ If the CD cannot be read correctly (because it is scratched, for example), "NO DISC" appears on the display.

To Unload CDs

Take out the CD as shown below.

1 While the CD Player is stopped, press the CD Open/Close ▲ button on the Unit to open the tray.

2 Remove the CD, then press the DISC SKIP button on the Unit.

The tray turns for the next CD.

3 Repeat step 2 to remove all the CDs.

4 Press the CD Open/Close ▲ button on the Unit to close the tray.

- ❑ You can remove CDs while listening to the other source.

Tips:

- **Removing/changing the CDs during playback**

While playing back a CD (e.g. CD1), you can remove or change the other CDs (e.g. CD2 and CD3) by pressing the CD Open/Close ▲ button. After removing or changing, press the same button to close the tray.

Changing the MP3/WMA Playback Mode

When playing an MP3/WMA disc, you can choose the playback mode of the MP3/WMA disc as follows:

TRACK mode:

The unit recognizes only tracks (files). You can play an MP3/WMA disc like an Audio CD.

GROUP mode:

The unit recognizes tracks (files) and albums (folders) on an MP3/WMA disc. You can play an MP3/WMA disc according to the way how they are grouped.

On the Remote Control ONLY

Press MP3/WMA MODE before or during playing an MP3/WMA disc.



GROUP indicator appears when the MP3/WMA playback mode is the GROUP mode.



- Each time you press the button, the MP3/WMA playback mode changes between "GROUP" and "TRACK" alternately.

Basics of Using the CD Player- Normal Play

To Play CDs

1 Load CDs.

2 Press one of the Disc button (CD1-CD3) you want to play.

The selected disc number (e.g. "CD DISC 1") appears on the display.

The first track of the selected CD begins playing. When the first CD finishes playing, the next and the third CDs are continuously played back.

When the last CD has finished playing, it will return to the first CD and the CD Player automatically stops.

- You can start to play the currently selected disc by simply pressing the CD ►/|| button.

For Audio CD

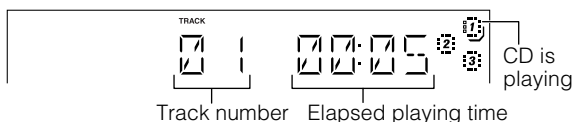

For MP3/WMA disc (The illustrations are for MP3 discs.)

TRACK mode

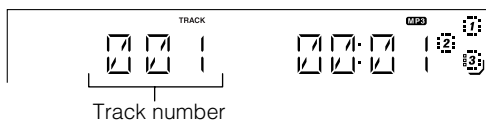

GROUP mode

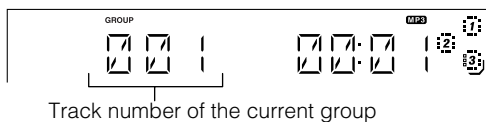

- After the display above is shown, if the tracks include ID3 tags, the display will scroll in the order of file name, title, artist, and album, then returns to the original display.

When the Disc button (CD1-CD3) is pressed with the tray opened, the tray is closed and the selected CD automatically begins playing.

To stop playing the CD, press the ■ button.

For Audio CD

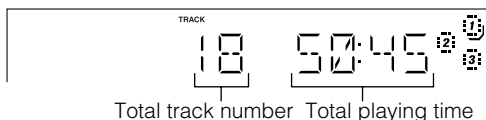

For MP3/WMA disc

TRACK mode

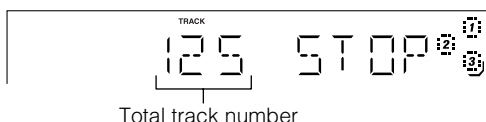

GROUP mode

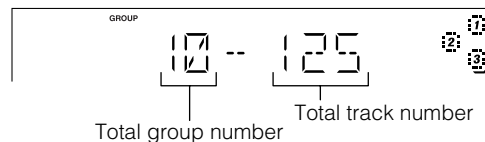

To pause, press the CD ►/|| button. The playing time indication blinks on the display.

To cancel pause, press the CD ►/|| button again. Play continues from the point where it was paused.

Tips:

• Playing back the CD using the DISC SKIP button

You can also play the CDs using the DISC SKIP button. During playback, each time you press the button, the next CD is automatically played back. If the next disc tray is empty, the disc tray is automatically skipped.

To Select a Track

During playback:

Briefly press the ◀◀ or ▶▶ button to select the track you want to play, except for MP3/WMA GROUP mode.

By pressing the button, you can skip to the next track or skip back to the previous track.

- The selected track starts playing.
- Press the ▶▶ button once to skip to the beginning of the next track.
- Press the ◀◀ button to skip to the beginning of the current track. Press twice quickly to skip to the beginning of the previous track.

In Stop mode:

By briefly pressing the ◀◀ or ▶▶ button, the CD Player operates in the same way as during playback, except for MP3/WMA GROUP mode.

Using the numeric keys on the Remote Control:

Using the numeric keys, you can directly select the track on the currently selected CD.

- The selected track starts playing.

See "Entering the Number with the Remote Control" on page 8.

In MP3/WMA GROUP mode:

The selected track of the current group starts playing.

Tips:

• For MP3/WMA discs

When the selected track starts playing, information of that track scrolls on the display, in the order of file name, title, artist, and album.

To Select a Group (For MP3/WMA GROUP mode only)

During playback:

Briefly press the ◀◀ or ▶▶ button to select the group you want to play.

- The first track of the selected group starts playing.

In Stop mode:

Briefly press the ◀◀ or ▶▶ button to select the group you want to play. The group number, the group name and the file name scroll on the display.

Search Play

Holding down the following buttons, during playback, will fast forward/backwards the CD so you can quickly find a particular passage in the track you are listening to.

- ◀◀ or ▶▶ button on the Unit
- ◀◀ or ▶▶ button on the Remote Control

Resume Play for Audio CD and MP3/WMA Disc

You can store the point of the track where you stopped playback. By pressing CD ►/|| button, you can start playback again from the point where you stopped it.

On the Unit ONLY

Press the SET/RESUME button for 2 seconds until both "RESUME" and "ON" appear on the display.

To turn off the resume play, press the SET/RESUME button for 2 seconds until both "RESUME" and "OFF" appear on the display.

Notes

- To playback from the first track while resume play is activated, press ■ button twice during playback.

The following operations will erase the memory of the track number that you have stopped playback when

- Pressing CD Open/Close ▲ button to eject the disc.
- Pressing CD1-CD3 button or DISC SKIP button to change the disc to play.

Programming the Playing Order of the Tracks

You can program the playing order of the tracks on all the CDs. Note that you can only make a program when the CD Player is stopped.

- You can program up to 32 tracks in any desired order including the same tracks.

Notes

For MP3/WMA discs

- If you try to select a MP3/WMA disc that has once been read or played, "MP3 DISC" or "WMA DISC" appears on the display and it can not be programmed.
- MP3/WMA disc that has not ever been read can be selected in a program mode. But when playback starts, "MP3 DISC" or "WMA DISC" appears on the display, the program is deleted and switched to a next program.

To Make a Program

1 Load CDs.

2 In Stop mode, set the CD Player in Program Play mode.

Press the PROGRAM button to light the "PRGM" indicator on the display.

At the same time, "PROGRAM" appears on the display. Each time you press the button, the display changes as follows: PROGRAM → Normal display (Normal Play) → (back to the beginning)

- If a program is already made, the last step of the program will be displayed.

3 Press one of the Disc button (CD1-CD3) to select the CD you want to program.

The display will change to the Program Entry display.

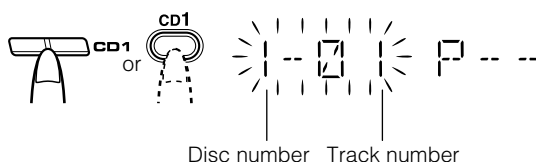

4 Select the track you want to program.

On the Unit

While the display is blinking, press the ◀◀ or ▶▶ button on the Unit to select the track, then press the SET button within 5 seconds. The program order number will be assigned from P-1.

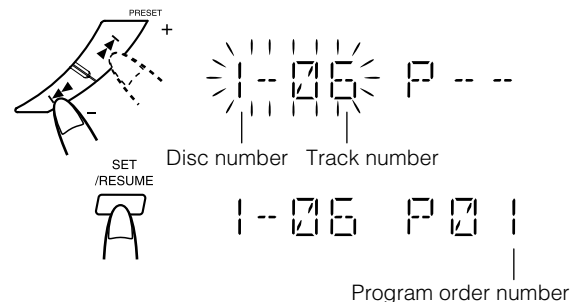

On the Remote Control

Press the numeric keys to directly enter the track number. Then, the program order number will be assigned from P-1.

- To delete the current program step, press the CANCEL button on the Unit.

5 Repeat steps 3 and 4 to program other tracks on the same CD or the other CD.

6 To play the program, Press the CD ►/|| button.

For details, see "To Play the Program You Have Made" mentioned below.

To confirm the programmed contents, while the CD player is stopped, select Program mode by pressing the PROGRAM button and press the ◀◀ or ▶▶ button on the Remote Control.

To delete all the tracks in the program, while the CD Player is stopped, press the ■ button or open the tray by pressing the CD Open/Close ▲ button.

To Modify the Program, while the CD Player is stopped and the program mode is selected, press the CANCEL button, the last track in the program is deleted. To add new tracks to the end of the program, repeat above steps 3 and 4.

Notes

- If you try to program a track number that does not exist on the CD, your entry will be ignored.
- If you try to program the 33rd track, "FULL" appears on the display.

To Play the Program You Have Made

Press the CD ►/|| button.

The System plays the tracks in the order you have programmed them.

- To use Repeat Play for Program Play, press the REPEAT button to select "REPEAT" before starting playback. For details, see "Repeating Tracks" on page 15.

- You can skip to a particular program track by pressing the ◀◀ or ▶▶ button during Program Play.

- To stop playing, press the ■ button once. If you press the ■ button, while the CD Player is stopped, the program is deleted.

Using the CD Player

To Exit and Re-enter Program Play

The program you have made is stored in memory. So, you can exit Program Play temporarily or re-enter Program Play unless you delete the program.

To exit the program mode once, press the ■ button to stop playing. The "PRGM" indicator goes off and the Program mode will be canceled. The program is stored in the memory.

To re-enter Program Play mode, press the PROGRAM button until the "PRGM" indicator lights up again.



- Tray will not open during the program playback.

Random Play

The tracks of the selected CD will play in no special order when you use this mode.

1 In Stop mode, set the CD Player in Random Play mode.

Press the RANDOM button to light the "RNDM" and "1 DISC" indicator.

At the same time, "RANDOM" appears on the display.

Each time you press the button, the display changes as follows: RANDOM → Normal display (Normal Play) → (back to the beginning)

2 Press the CD ►/|| button.

The tracks on selected CD are played in random order.

To stop playing, press the ■ button. The Random mode is canceled and the "RNDM" and "1 DISC" indicator goes off.

To skip a track during playback, press the ►► button to jump to the next track in the random sequence.

- To use Repeat Play for Random Play, press the RANDOM button to display "REPEAT" and "1DISC" before starting playback. For details, see "Repeating Tracks" mentioned below.

Repeating Tracks

You can repeat all tracks or individual track, as many times as you like.

Press the REPEAT button.

The Repeat indicator changes with each press of the button, as follows:

REPEAT 1 → REPEAT 1DISC → REPEAT ALL → Normal display (Normal Play) → (back to the beginning)

REPEAT 1: Repeats one track.

REPEAT 1DISC: Repeats all tracks on one CD. (Selectable in Normal Play and Random Play)

REPEAT ALL: In Normal Play mode, repeats all the tracks on all the CDs.

In Program Play mode, the Repeat indicator changes with each press of the REPEAT button, as follows:

REPEAT ↔ Blank display

It repeats all the tracks in the program.

To stop playing, press the ■ button. Changing the source to the other (e.g. Tuner) will also stop playing. The Repeat mode is canceled and the Repeat indicator goes off.

Tray Lock Function

In order to safely keep the CD in the CD Player, the tray can be electronically locked.

When the electronic lock is on, the tray cannot be opened even if the CD Open/Close ▲ button on the Unit is pressed.

Locking the Tray

- 1 Turn on the System and enter CD mode.
- 2 While pressing down the ■ button, press the CD Open/Close ▲ button on the Unit. "LOCKED" appears on the display.



- If you try to open the tray by pressing the CD Open/Close ▲ button, "LOCKED" appears on the display to let you know that the tray has been locked.

Unlocking the Tray

Repeat above steps 1 and 2.

"UNLOCKED" appears on the display.



Now, you can use the tray normally.



- Even after the System is unplugged, the tray lock condition will be retained for a few days. To unlock the tray after powering up, you need to perform the unlocking operation.

Using the Cassette Deck (Listening to a Tape)

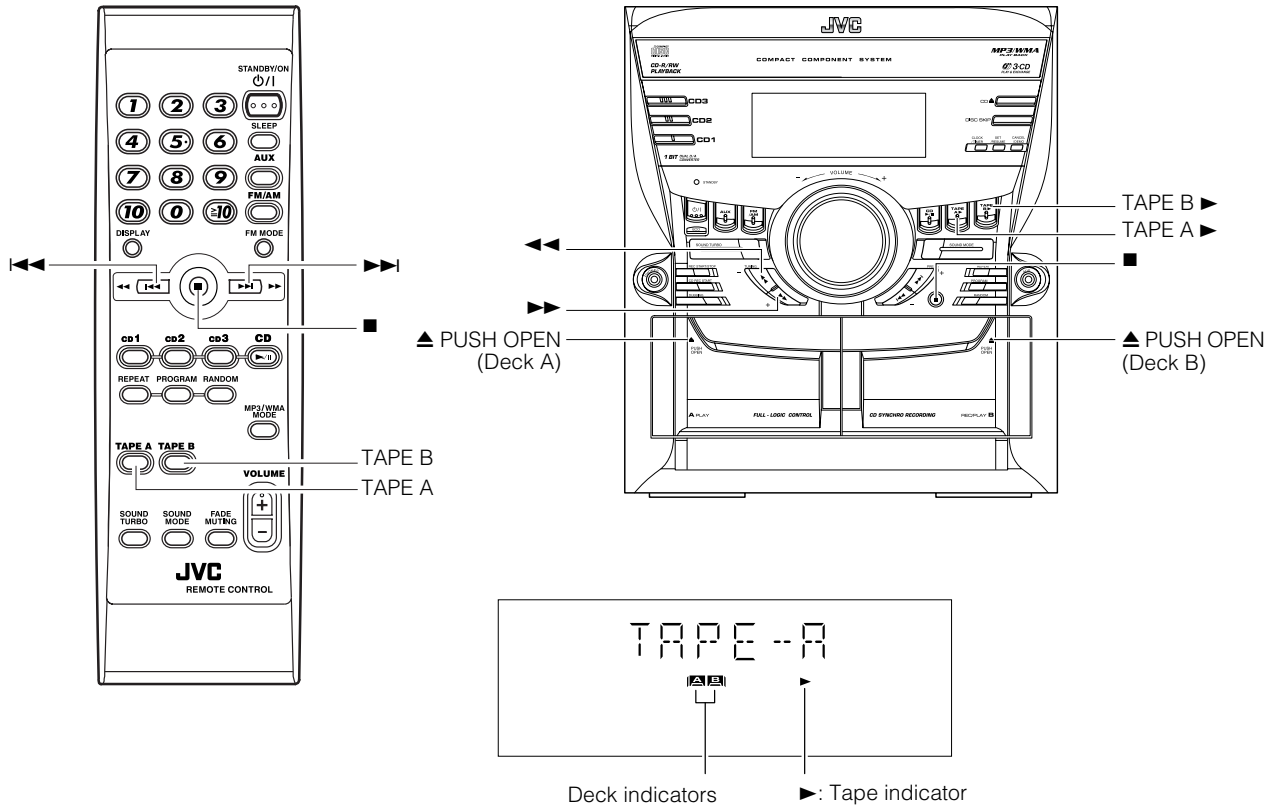

* When the System is in use, the display shows other items as well. For simplicity, we show here only the items described in this section.

The Cassette Deck allows you to play, record, and dub audio tapes.

□ Listening to type I tape is suitable for this Cassette Deck.

The use of tapes longer than 120 minutes (including 120 minute tapes) is not recommended, since characteristic deterioration may occur and these tapes easily jam in the pinch-rollers and the capstans.

One Touch Play

By pressing the TAPE A ► or TAPE B ► button, the System will come on, and if a tape is in the deck, it will start to play. If no tape is loaded in either Deck A or Deck B, "NO TAPE" appears on the display, the System will come on and wait for you to insert a tape, or select another function.

Playing a Tape

You can use either Deck A or Deck B at a time for playback.

1 Press the ▲ PUSH OPEN part for the deck you want to use.

2 When the cassette holder opens, put a cassette in, with the exposed part of the tape down, toward the base of the Unit.

The tape will travel from the left to right.

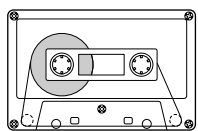

Tape travelling direction

3 Press ▲ PUSH OPEN gently to close the cassette holder.

The Deck indicator "A" or "B" lights up on the display.

4 Press the TAPE A ► or TAPE B ► button.

The Tape indicator (►) blinks on the display and the tape is played back.

The Cassette Deck automatically stops when one side of the tape has finished playing.

To stop playing, press the ■ button.

To remove the tape, stop the tape, and press the ▲ PUSH OPEN part to open the Cassette Holder.

To Fast-Wind a Tape

During playback or in Stop mode, press the ►► (FF) button on the Unit to fast-wind the tape onto the right side of the cassette without playing. (You can also use the ►►| button on the Remote Control.) During playback or in Stop mode, press the ◀◀ (REW) button on the Unit to fast-wind the tape onto the left side of the cassette without playing. (You can also use the |◀◀ button on the Remote Control.)

During fast-winding the tape, the Tape indicator (►) goes out.

During fast-winding, the status bar illumination at the bottom of the display moves counterclockwise.

During rewinding, it moves clockwise.

• The Cassette Deck automatically stops when one side of the tape has finished playing.

□ During fast-winding the tape, you can change the tape travelling direction by pressing the ►► (FF) or ◀◀ (REW) button.

Using the Cassette Deck (Recording)

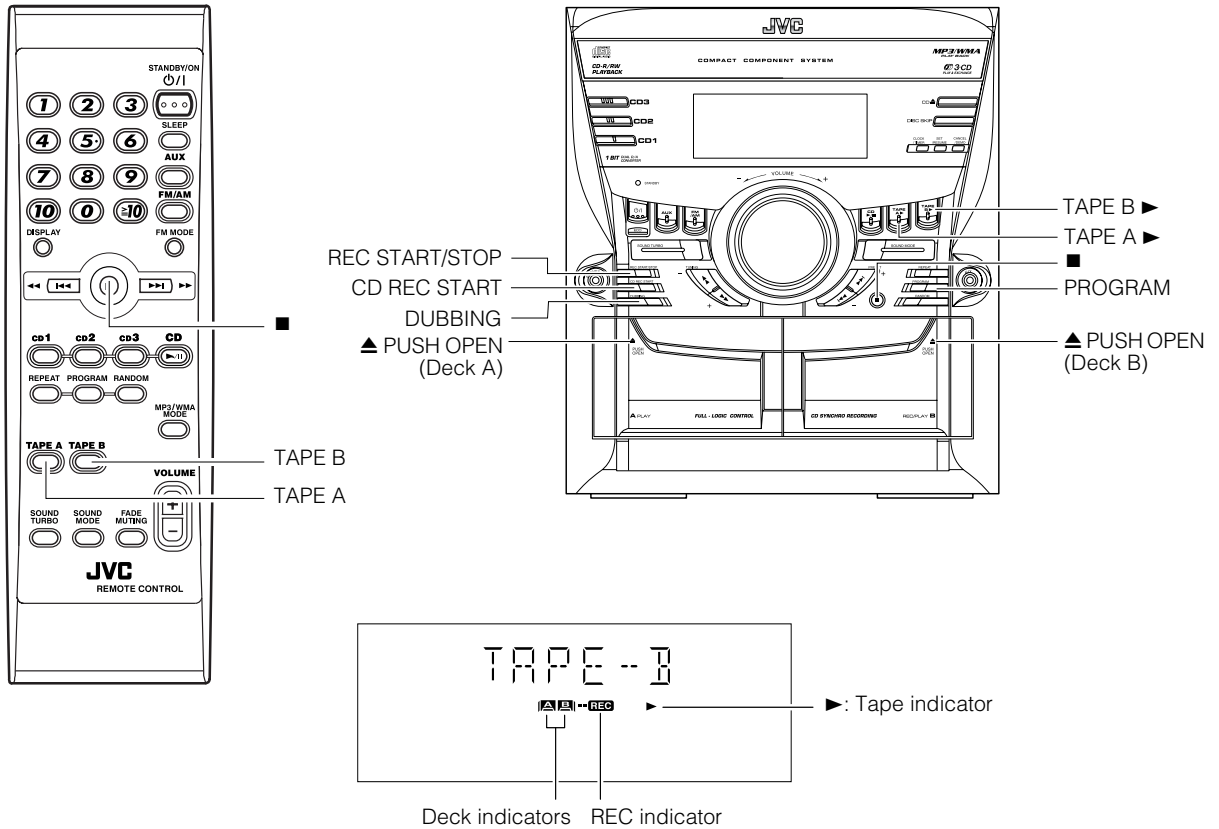

* When the System is in use, the display shows other items as well. For simplicity, we show here only the items described in this section.

Recording onto a cassette from any of the sound sources is simple. Just place a tape in Deck B, have the source ready, make one or two settings, and you're ready to record. For each source, the procedure is a little bit different so we explain each separately. But first, here are a few things to make your recordings better.

Things To Know Before You Start Recording

- ❑ It should be noted that it may be unlawful to re-record pre-recorded tapes, records, or discs without the consent of the owner of copyright in the sound or video recording, broadcast or cable program and in any literary, dramatic, musical, or artistic content embodied therein.
- ❑ The recording level, which is the volume at which the new tape is being made, is automatically set correctly, so it is not affected by the VOLUME Control on the System. Also, it is not affected by adjusting the sound effects. Thus, during recording, you can adjust the sound you are actually listening to without affecting the recording level.
- ❑ Two small tabs on the back of the cassette tape, one for side A and one for side B, can be removed to prevent accidental erasure or recording.

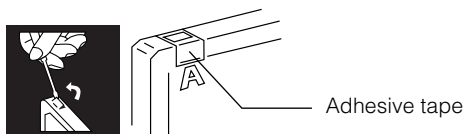

- ❑ To record on a cassette with the tabs removed, you must cover the holes with adhesive tape first.
- ❑ Type I tape can be used for recording.

Note

- At the start and end of cassette tapes, there is leader tape which cannot be recorded onto. Thus, when recording CDs, radio broadcasts, etc., wind on the leader tape first to ensure getting the beginning of the recording.

CAUTION:

- If a recording you make has excessive noise or static, the Unit may have been too close to a TV which was on during the recording. Either turn off the TV or increase the distance between the TV and the Unit.

Standard Recording

To Record Any Sound Source to Tape

Follow these steps to record from any sound source onto a tape in Deck B.

- 1 Insert a blank or erasable tape into the Deck B and wind past the tape leader.

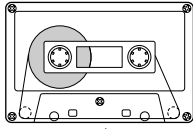

Tape travelling direction

- 2 Prepare the source, by, for example, tuning in a radio station, loading CDs, or turning on connected equipment.

- For CD recording, see “CD Synchro Recording” mentioned below.
- For dubbing, see “Tape to Tape Recording (DUBBING)” described below.

- 3 Press the REC START/STOP button on the Unit.

The “REC” indicator lights up and the System begins recording.

The Tape indicator (▶) blinks on the display.

- If the tab of the cassette tape on the Deck B is removed to prevent erasure or recording, “NO REC” will appear on the display.

To stop during recording, press the REC START/STOP button on the Unit, or press the ■ button.

Recording an AM Station to Tape (Beat Cut)

When recording an AM broadcast, beats may be produced which are not heard when listening to the broadcast. If this happens, press the FM MODE button on the Remote Control to eliminate the beats.

- 1 Set to AM station and start recording.
- 2 Press the FM MODE button on the Remote Control to eliminate the beats.

Each time you press the button, the display changes as shown below:

BEAT 1 ↔ BEAT 2

CD Synchro Recording

Everything on the CD goes onto the tape in the order it is on the CD, or according to the order you have set in a program.

- 1 Prepare CDs. (See page 12.)
Press the CD1-3 button (that you want to make recording), and then press the ■ button.
 - If you want to record specific tracks only, you need to program the tracks beforehand. (See page 14.)
 - If you want to record one CD only, you need to load one CD only.

- 2 Insert a blank or erasable tape into the Deck B and wind past the tape leader.

- 3 Press the CD REC START button on the Unit.

“CD REC” appears on the display and the “REC” indicator lights up. Then, the System begins CD Synchro Recording and the tracks on the CD are recorded on the tape.

When recording of the tracks of all CDs is finished, the CD Player and Cassette Deck stop.

- If the tab of the cassette tape on the Deck B is removed to prevent erasure or recording, “NO REC” will appear on the display.
- After the CD Player has played the entire CD or all the programmed tracks, the tape automatically stops.

To stop at any time during the recording process, press the ■ button. The CD Player and Cassette Deck stop.

Notes

- If the CD REC START button is pressed when “RESUME” is displayed (see page 14), CD Synchro Recording will be started from the beginning of the first track.
- When making SLEEP timer settings while doing CD Synchro recording, set enough time to allow for the CD to finish playing, otherwise the power will go off before recording is completed.

Tape to Tape Recording (DUBBING)

Recording from one tape to another is called dubbing.

You can dub tapes simply, with just a single button.

- 1 Press the TAPE A ▶ button, and then press the ■ button.
- 2 Insert the source cassette you want to copy from into Deck A for playback.
- 3 Insert a blank or erasable cassette you want to copy onto into Deck B for recording.
- 4 Press the DUBBING button on the Unit.

Deck A and Deck B will start simultaneously and the “REC” indicator lights up.

During dubbing, the Deck indicators “A” and “B” light up alternately.

- If no tape is inserted into Deck A, “NO TAPE” will appear on the display.
- If no tape is inserted into Deck B, “NO TAPE” will appear on the display.

To stop dubbing, press the REC START/STOP button on the Unit or the ■ button.

Note

- During dubbing, you can hear sound effects through the speakers or headphones. However, the sound is dubbed without sound effects.

Using an External Equipment

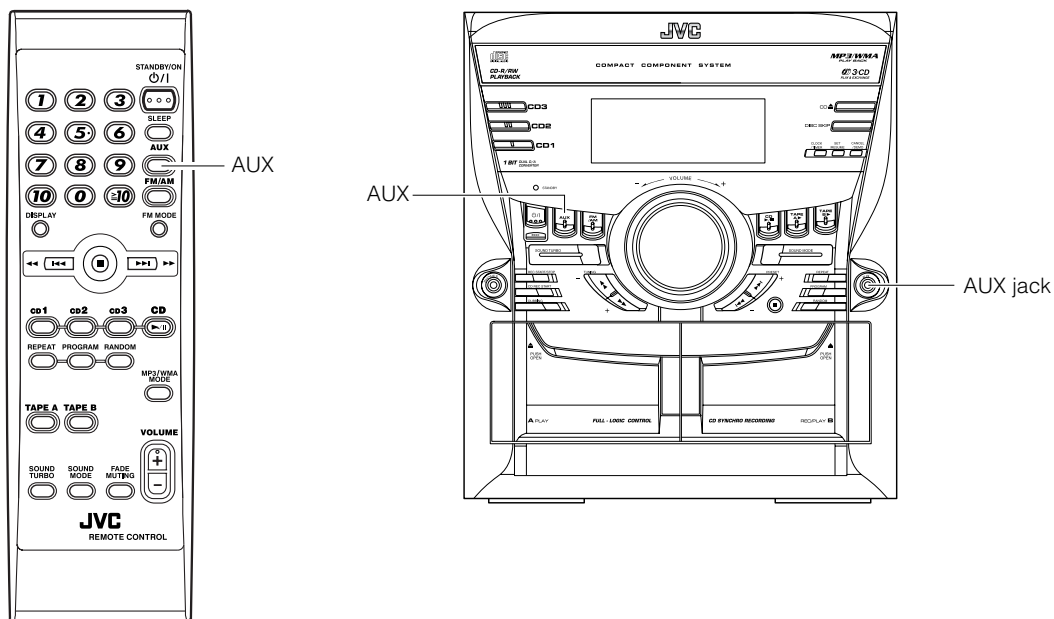

Listening to the External Equipment

You can listen to the external equipment such as portable CD, MD player, STB, or other auxiliary.

□ First, make sure that the external equipment is properly connected to the System. (See page 6.)

1 Set the volume level to the minimum position.

2 Press the AUX button.

“AUX IN” appears on the display.

AUX IN

3 Start playing the external equipment.

4 Adjust the volume level to the level you want listen to.

5 Apply the following sound effects, if you wish.

- SOUND TURBO (See page 8.)
- SOUND MODE (See page 8.)



• For operation of the external equipment, refer to its Instructions.

Using the Timers

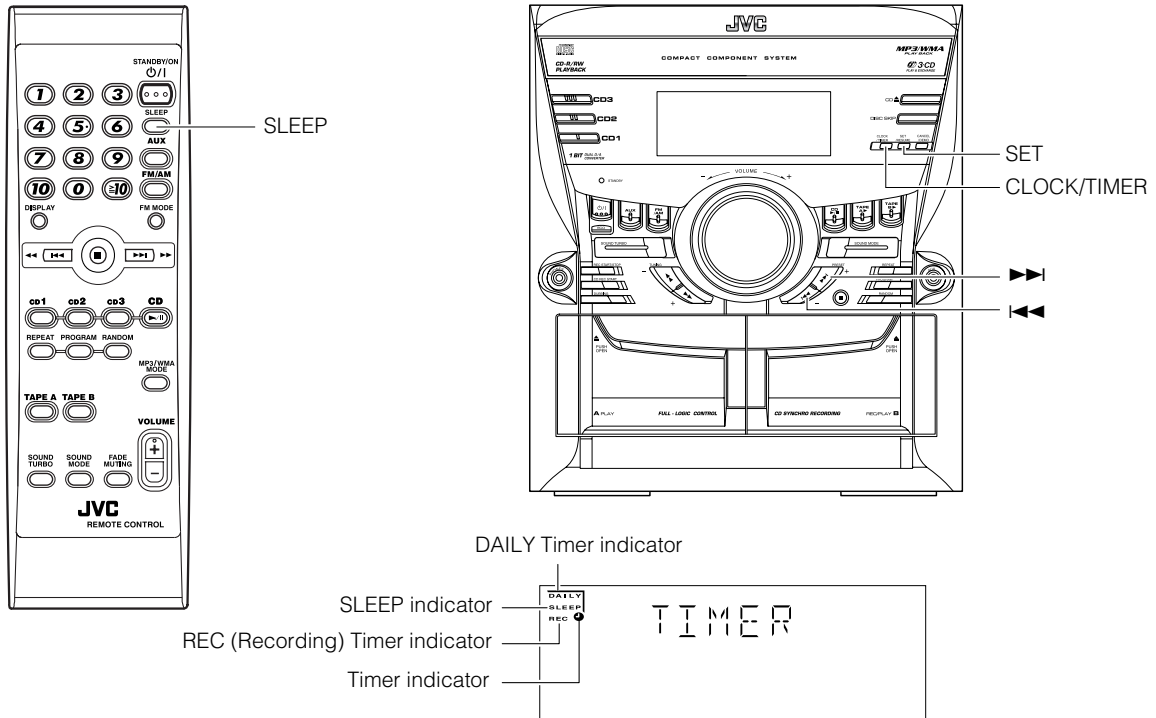

* When the System is in use, the display shows other items as well. For simplicity, we show here only the items described in this section.

Three types of timers are available:

DAILY Timer

Use this timer to set wake up everyday to music from any source, instead of an alarm clock.

REC (Recording) Timer

Unattended recording of radio broadcasts. You can set the starting time and ending time.

SLEEP Timer

Fall asleep and have your System turn off automatically after a certain length of time.

Setting the Clock

When you plug the AC power cord into the wall outlet, the time indication "AM 12:00" blinks on the display.

You can set the clock whether the System is on or off.

On the Unit

- 1 Press the CLOCK/TIMER button.**
The hour digit of the time indication blinks on the display.
- 2 Press the ◀◀ or ▶▶ button to set the hour.**
Pressing the ▶▶ button moves the time forwards and pressing the ◀◀ button moves it backwards. Holding down the button moves the hour rapidly.
- 3 Press the SET button.**
The minute digits of the time indication blink on the display.
 - To return to the hour setting, press the CANCEL button.
- 4 Press the ◀◀ or ▶▶ button to set the minute.**
- 5 Press the SET button.**
"CLOCK OK" appears on the display. Then, the selected time is set and the seconds start counting from 0.

Fixing the Clock

On the Unit

- 1 Press the ⏻/⏻ STANDBY/ON button to turn on the System.**
- 2 Press the CLOCK/TIMER button repeatedly until clock setting display (time indication) appears on the display.**
Each time you press the button, display changes as follows:
DAILY → ON TIME → REC → ON TIME → Clock Setting display (time indicator) → Canceled → (back to the beginning)
- 3 Press the SET button.**
The hour digits of the current clock blink on the display.
- 4 Follow steps 2 to 5 of "Setting the Clock" mentioned above.**



- The clock must be correctly set for the timers to work.
- Each setting step must be completed within approx. 30 seconds. Otherwise, the setting is cleared and must be repeated from the beginning.
- The clock may gain or lose one to two minutes per month.
- If there is a power failure, the clock loses its setting immediately. "AM 12:00" blinks on the display and the clock must be reset.

Setting the Daily Timer

Once you have set the Daily Timer, it is stored in memory. So, the Daily Timer will be activated at the same time every day until it is canceled.

The Timer indicator (🕒) and “DAILY” indicator on the display shows that the Daily Timer you have set is in effect.

You can set the Daily Timer whether the System is turned on or off.

Notes

- You can set the Daily Timer whether the System is on or off.
- Perform each setting within approx. 30 seconds. Otherwise, setting will be cleared and the procedure must be repeated from the beginning.
- If you have made a mistake while setting the timer, press the CANCEL button on the Unit. However, this does not always cancel the current setting. If the CANCEL button does not work, press the CLOCK/TIMER button on the Unit repeatedly until the display returns to the original display, and start from the first step.

On the Unit

1 Press the CLOCK/TIMER button until “ON TIME” immediately after “DAILY” appears on the display.

Each time you press the button, the display changes as follows:
DAILY → ON TIME* → REC → ON TIME → Clock setting display → Canceled → (back to the beginning)

*: This item should be selected for the Daily Timer setting.

Then, the System enters ON-time setting mode, and the current ON time appears on the display and the hour digits blink.

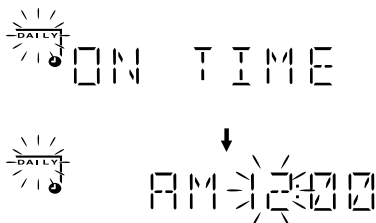

2 Setting the ON time (Example: AM 10:15).

1. Press the ►► or ◄◄ button to set the hour you want the System to come on, then press the SET button.
The minute digits of the ON time blink on the display.
Pressing the ►► button moves the time forwards and pressing the ◄◄ button moves it backwards.
Holding down the button moves the time rapidly.

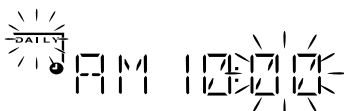

2. Press the ►► or ◄◄ button to set the minute, then press the SET button.



“OFF TIME” appears and then the System enters OFF-time setting mode. The current OFF time appears on the display, and the hour digits blink.

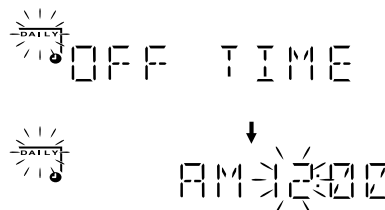

3 Setting the OFF time (Example: PM 1:15).

1. Press the ►► or ◄◄ button to set the hour you want the System to be turned off, then press the SET button.
The minute digits of the OFF time blink on the display.

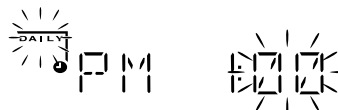

2. Press the ►► or ◄◄ button to set the minute, then press the SET button.



The System enters Music Source Selecting mode and “TUNER FM” appears on the display.



4 Selecting the music source.

Press the ►► or ◄◄ button to select the music source you want to listen to, then press the SET button.

Each time you press the ►► or ◄◄ button, the display changes as shown below:

TUNER FM → TUNER AM → CD → TAPE → AUX IN → (back to the beginning)

According to the music source you have selected, the next operation differs.

When selecting TUNER FM or TUNER AM:

Press the ►► or ◄◄ button to select the preset station number, then press the SET button.

When “P---” is selected, the last station you were listening to will be set.

When selecting CD :

Press the ►► or ◄◄ button to select the disc number, then press the SET button.

Each time you press the button the disc number changes as follows:

DISC – → DISC 1 → DISC 2 → DISC 3 → (back to the beginning)

- If no disc number is specified, playback will start from the first track of the currently selected disc.

When selecting TAPE:

Insert a cassette tape you want to play into Deck A.

When selecting AUX:

Prepare the external equipment so that it will turn on at the ON time set by the System.

To allow this, the equipment should have the timer function.

5 Setting the volume level.

Press the ►► or ◀◀ button to select the volume level.

MIN, 1-30, or MAX: When the timer is turned on, the Volume will be automatically set to the selected level.

**6 Press the SET button.**

The timer setting is completed and the display returns to the display before you set the Timer.

7 Press the ⏻/| STANDBY/ON button to turn off the System, if necessary.

The Timer indicator (●) and "DAILY" indicator are lit on the display, showing that the Daily Timer is set to on.

To confirm / change the timer setting, repeat the setting procedure from the beginning.

When the timer ON-time comes:

The following operation will be automatically repeated every day.

- When the timer ON-time comes, the System automatically turns on. The music source you have set is played. The Timer indicator (●) blinks and "DAILY" indicator lights during timer operation.
- When the timer OFF-time comes, the System automatically turns off. Then, the Timer indicator (●) and "DAILY" indicator remain lit on the display.



- *If the System is already on when the timer ON-time comes, the Daily Timer does not work.*

To cancel the Daily Timer temporarily:

1 Press the CLOCK/TIMER button on the Unit repeatedly until the "DAILY" appears on the display.

2 Press the CANCEL button on the Unit.

"OFF" appears and both the Timer indicator (●) and the "DAILY" indicator go out.

To activate the cancelled Daily Timer:

1 Press the CLOCK/TIMER button on the Unit repeatedly until the "DAILY" appears on the display.

The "DAILY" indicator blinks and the Timer indicator (●) lights up on the display.

2 Press the SET button on the Unit.

"DAILY SET" appears on the display. The Timer indicator (●) and the "DAILY" indicator remain lit, and the display returns to the original display.



- *If the System is unplugged, or a power failure occurs, the timer setting will be lost in a few days. You will need to reset the clock first, then the timer.*

Setting the REC (Recording) Timer

With the Recording Timer, you can make a tape of a radio broadcast automatically whether or not you are home.

Once you have set the REC Timer to record a source, the timer setting is stored in memory. So, though the REC Timer turns off once it is used, you can recall it at any time.



- *You can set the REC Timer whether the System is on or off.*
- *Perform each setting within approx. 30 seconds. Otherwise, setting will be cleared and the procedure must be repeated from the beginning.*
- *If you have made a mistake while setting the timer, press the CANCEL button on the Unit. However, this does not always cancel the current setting. If the CANCEL button does not work, press the CLOCK/TIMER button on the Unit repeatedly until the display returns to the original display, and start from the first step.*

On the Unit

You can set the time in the same way as for setting the Daily Timer.

1 Insert a blank or erasable tape into the Deck B and wind past the tape leader.

2 Press the CLOCK/TIMER button until "ON TIME" immediately after "REC" appears on the display.

Each time you press the button, the display changes as follows: DAILY → ON TIME → REC → ON TIME* → Clock setting display → Canceled → (back to the beginning)

*: This item should be selected for the REC Timer setting.

Then, the System enters ON-time setting mode. The current ON time appears on the display and the hour digits blink.

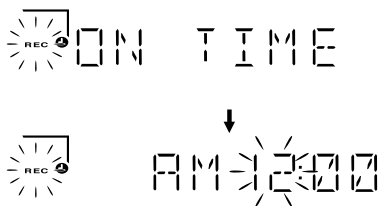

3 Setting the ON time you want the System to turn on.

1. Press the ◀◀ or ▶▶ button to set the hour, then press the SET button.

2. Press the ◀◀ or ▶▶ button to set the minute, then press the SET button.

"OFF TIME" appears and then the System enters OFF-time setting mode. The current OFF time appears on the display, and the hour digits blink.

4 Setting the OFF time you want the System to turn off.

1. Press the ◀◀ or ▶▶ button to set the hour, then press the SET button.

2. Press the ◀◀ or ▶▶ button to set the minute, then press the SET button.

The System enters Preset Station Entering mode.

5 Select the preset station for recording.

1. Press the ◀◀ or ▶▶ button to set the band (TUNER FM or TUNER AM), then press the SET button.

2. Press the ◀◀ or ▶▶ button to set the preset number, then press the SET button.

When "P---" is selected, the last station you were listening to will be set.

6 Setting the volume level.

Press the ▶▶ or ◀◀ button to select the volume level.

MIN, 1-30, or MAX: When the timer is turned on, the Volume will be automatically set to the selected level.



7 Press the SET button.

The timer setting is completed and the display returns to the display before you set the Timer.

8 Press the ⏻/| STANDBY/ON button to turn off the System, if necessary.

The Timer indicator (●) and "REC" indicator are lit on the display, showing that the Rec Timer is set to on.

To confirm / change the timer setting, repeat the setting procedure from the beginning.

When the timer ON-time comes:

- When the timer ON-time comes, the System automatically turns on. The station you have set is played. The Timer indicator (●) and Tape indicator (▶) blink, and the "REC" indicator lights during timer operation.

To stop timer recording, press the ■ button.

- When the timer OFF-time comes, the System automatically turns off.



If the System is already on when the timer ON-time comes, the REC Timer does not work.

To cancel the REC Timer temporarily:

1 Press the CLOCK/TIMER button on the Unit repeatedly until "REC" appears on the display.

2 Press the CANCEL button on the Unit.

"OFF" appears and both the Timer indicator (●) and the "REC" indicator go out.

To activate the cancelled REC Timer:

1 Press the CLOCK/TIMER button on the Unit repeatedly until "REC" appears on the display.

The Timer indicator (●) lights and the "REC" indicator blinks on the display.

2 Press the SET button on the Unit.

"REC SET" appears on the display. The Timer indicator (●) and the "REC" indicator remain lit, and the display returns to the original display.



If the System is unplugged, or a power failure occurs, the timer setting will be lost in a few days. You will need to reset the clock first, then the timer.

Setting the SLEEP Timer

Use the Sleep Timer to turn the System off after a certain number of minutes when it is playing. By setting the Sleep Timer, you can fall asleep to music and know that your System will turn off by itself rather than play all night.

- You can only set the Sleep Timer when the System is on.

On the Remote Control

1 During playback a source, press the SLEEP button.

The "SLEEP" indicator starts blinking on the display.

2 Set the length of time you want the source to play before shutting off.

Each time you press the SLEEP button, the time length changes as follows:

10 → 20 → 30 → 60 → 90 → 120 → OFF → (back to the beginning)



3 Wait for 5 seconds.

The "SLEEP" indicator stops blinking and remains lit, and the display returns to the original one before setting the Sleep Timer.

The System is now set to turn off after the number of minutes you have set.

To Confirm the Sleep Time:

When the SLEEP button on the Remote Control is pressed, the remaining sleep time is displayed. Wait until the display returns to the original display.

To Cancel the SLEEP Timer Setting:

Press the SLEEP button until "OFF" appears on the display.

- Turning off the System also cancels the SLEEP Timer.

Note

- When the REC Timer or the DAILY Timer is operating, SLEEP Timer can not be set.

Timer Priority

Since REC Timer and DAILY Timer can be set independently, you may wonder what happens if the settings overlap. Here are the priorities for REC Timer and DAILY Timer:

- Timer with the earlier time setting will have the priority. Timer will not operate when other Timer is operating.
- If other Timer is set to an exact same time as the REC Timer, the REC Timer will have the priority.

- REC Timer and DAILY Timer will not operate when SLEEP Timer is operating.

Example

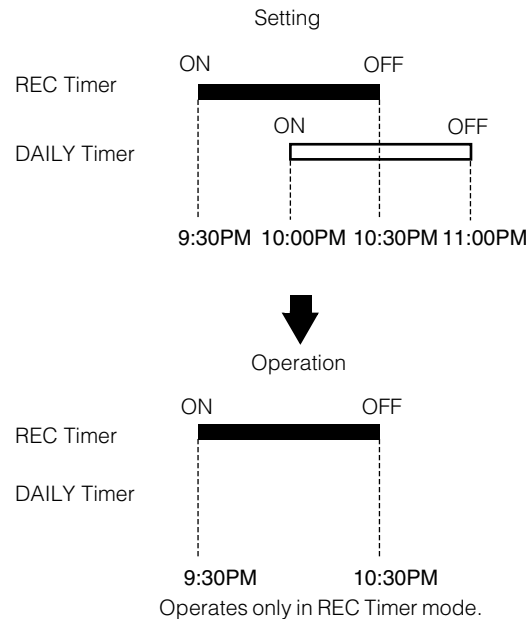

Care And Maintenance

Handle your CDs and tapes carefully, and they will last a long time.

Compact Discs



- Remove the CD from its case by holding it at the edges while pressing the case's center hole lightly.
- Do not touch the shiny surface of the CD, or bend the CD.



- Put the CD back in its case after use to prevent warping.
- Be careful not to scratch the surface of the CD when placing it back in the case.
- Avoid exposure to direct sunlight, temperature extremes, and moisture.



- A dirty CD may not play correctly. If a CD does become dirty, wipe it with a soft cloth in a straight line from center to edge.

CAUTION:

- Do not use any solvent (for example, conventional record cleaner, spray thinner, benzine, etc.) to clean a CD.

General Notes

In general, you will have the best performance by keeping your CDs and the mechanism clean.

- Store CDs in their cases, and keep them in cabinets or on shelves.
- Keep the System's Top Cover closed when not in use.

Moisture Condensation

Moisture may condense on the lens inside the System in the following cases:

- After turning on heating in the room.
 - In a damp room.
 - If the System is brought directly from a cold to a warm place.
- Should this occur, the System may malfunction. In this case, leave the System turned on for a few hours until the moisture evaporates, unplug the AC power cord, and then plug it in again.

Cassette Tapes

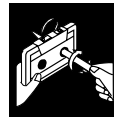

- If the tape is loose in its cassette, take up the slack by inserting a pencil in one of the reels and rotating.
- If the tape is loose, it may get stretched, cut, or caught in the cassette.



- Do not touch the tape surface.



- Do not store the tape:
 - In dusty places
 - In direct sunlight or heat
 - In moist areas
 - On a TV or speaker
 - Near a magnet

Cassette Deck

- If the heads, capstans, and pinch-rollers of the Cassette Deck become dirty, the following will occur:
 - Loss of sound quality
 - Discontinuous sound
 - Fading
 - Incomplete erasure
 - Difficulty recording
- Clean the heads, capstans, and pinch-rollers using a cotton swab moistened with alcohol.

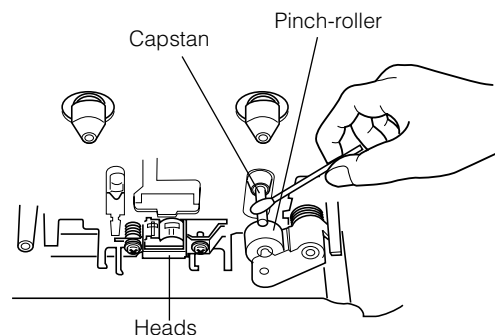

- If the heads become magnetized, the Unit will produce noise or lose high frequencies.
- To demagnetize the heads, turn off the Unit, and use a head demagnetizer (available at electronics and record shops).

Troubleshooting

- If you are having a problem with your System, check this list for a possible solution before calling for service.
- If you cannot solve the problem from the hints given here, or the System has been physically damaged, call a qualified person, such as your dealer, for service.

Symptom	Possible Cause	Action
No sound is heard.	<ul style="list-style-type: none"> • Connections are incorrect, or loose. • Headphones are connected. 	<ul style="list-style-type: none"> • Check all connections and make corrections. (See pages 4 to 6.) • Disconnect the headphones.
Poor radio reception	<ul style="list-style-type: none"> • The antenna is disconnected. • The AM Loop Antenna is too close to the System. • The FM Wire Antenna is not properly extended and positioned. 	<ul style="list-style-type: none"> • Reconnect the antenna securely. • Change the position and direction of the AM Loop Antenna. • Extend FM Wire Antenna to the best reception position.
The disc tray does not open.	<ul style="list-style-type: none"> • The AC power cord is not plugged in. • Tray is locked. 	<ul style="list-style-type: none"> • Plug the AC power cord. • Unlock the tray. (See page 15.)
The CD skips.	The CD is dirty or scratched.	Clean or replace the CD. (See page 25.)
The CD does not play.	The CD is upside down.	Put the CD in with the label side up.
The MP3/WMA disc does not play.	<ul style="list-style-type: none"> • No MP3/WMA files are recorded on the disc. • MP3/WMA files do not have the file extension —.wma or .mp3 in their file names. • MP3/WMA files are not recorded in the format compliant with ISO 9660 Level 1 or Level 2. 	Replace the disc.
The readout time of the MP3/WMA disc is too long.	The readout time varies with the complexity of the recording configuration.	Do not use too many hierarchies and folders when recording. Also, do not record any other types of audio tracks together with MP3/WMA files. (See page 11.)
The cassette holder cannot be opened.	During tape playing, the power cord was unplugged.	Plug in the power cord, and turn on the System.
Unable to record.	Cassette record protect tabs are removed.	Cover holes on back edge of cassette with tape.
Unable to operate the Remote Control.	<ul style="list-style-type: none"> • The path between the Remote Control and the sensor on the Unit is blocked. • The batteries have lost their charge. 	<ul style="list-style-type: none"> • Remove the obstruction. • Replace the batteries.
Operations are disabled.	The built-in microprocessor has malfunctioned due to external electrical interference.	Unplug the System then plug it back in.
“PROTECT” appears on the display, then the power goes off.	The speaker wire leads come in contact with each other.	Check the connections and make corrections. (See page 5.)

TO OUR VALUED CUSTOMER ———

THANK YOU FOR PURCHASING THIS JVC PRODUCT.
WE WANT TO HELP YOU ACHIEVE A PERFECT EXPERIENCE.

**NEED HELP ON HOW TO HOOK UP?
NEED ASSISTANCE ON HOW TO OPERATE?
NEED TO LOCATE A JVC SERVICE CENTER?
LIKE TO PURCHASE ACCESSORIES?**

JVC[®] IS HERE TO HELP!
TOLL FREE: 1(800)252-5722
<http://www.jvc.com>

Remember to retain your Bill of Sale for Warranty Service.

————— **Do not attempt to service the product yourself** —————

Caution

To prevent electrical shock, do not open the cabinet.
There are no user serviceable parts inside.
Please refer to qualified service personnel for repairs.



LIMITED WARRANTY

AUDIO-1

JVC COMPANY OF AMERICA (JVC) warrants this product and all parts thereof, except as set forth below ONLY TO THE ORIGINAL RETAIL PURCHASER to be FREE FROM DEFECTIVE MATERIALS AND WORKMANSHIP from the date of original purchase for the period shown below. ("The Warranty Period")

PARTS	1 YR	LABOR	1 YR
-------	-------------	-------	-------------

THIS LIMITED WARRANTY IS VALID ONLY IN THE FIFTY (50) UNITED STATES, THE DISTRICT OF COLUMBIA AND IN THE COMMONWEALTH OF PUERTO RICO.

WHAT WE WILL DO:

If this product is found to be defective within the warranty period, JVC will repair or replace defective parts with new or rebuilt equivalents at no charge to the original owner. Such repair and replacement services shall be rendered by JVC during normal business hours at JVC authorized service centers. Parts used for replacement are warranted only for the remainder of the Warranty Period. All products may be brought to a JVC authorized service center on a carry-in basis. Color televisions with a screen size of 27" or greater qualify for in-home service. In such cases, a technician will come to your home and either repair the TV there or remove and return it if it cannot be repaired in your home.

WHAT YOU MUST DO FOR WARRANTY SERVICE:

Please do not return your product to the retailer
Instead, return your product to the JVC authorized service center nearest you. If shipping the product to the service center, please be sure to package it carefully, preferably in the original packaging, and include a brief description of the problem(s). Please call 1-800-252-5722 to locate the nearest JVC authorized service center. Service locations can also be obtained from our website <http://www.jvc.com>. If your product qualifies for in-home service, the service representative will require clear access to the product.

If you have any questions concerning your JVC Product, please contact our Customer Relations Department at 800-252-5722

WHAT IS NOT COVERED:

This limited warranty provided by JVC does not cover:

1. Products which have been subject to abuse, accident, alteration, modification, tampering, negligence, misuse, faulty installation, lack of reasonable care, or if repaired or serviced by anyone other than a service facility authorized by JVC to render such service, or if affixed to any attachment not provided with the products, or if the model or serial number has been altered, tampered with, defaced or removed;
2. Initial installation, installation and removal from cabinets or mounting systems.
3. Operational adjustments covered in the Owner's Manual, normal maintenance, video and audio head cleaning;
4. Damage that occurs in shipment, due to act of God, and cosmetic damage;
5. Signal reception problems and failures due to line power surge;
6. Video Pick-up Tubes/CCD Image Sensors are covered for 90 days from the date of purchase;
7. Accessories;
8. Batteries (except that Rechargeable Batteries are covered for 90 days from the date of purchase);
9. Products used for commercial purposes, including, but not limited to rental.

There are no express warranties except as listed above.

THE DURATION OF ANY IMPLIED WARRANTIES, INCLUDING THE IMPLIED WARRANTY OF MERCHANTABILITY, IS LIMITED TO THE DURATION OF THE EXPRESS WARRANTY HEREIN.

JVC SHALL NOT BE LIABLE FOR ANY LOSS OF USE OF THE PRODUCT, INCONVIENCE, OR ANY OTHER DAMAGES, WHETHER DIRECT, INCIDENTAL OR CONSEQUENTIAL (INCLUDING, WITHOUT LIMITATION, DAMAGE TO TAPES, RECORDS OR DISCS) RESULTING FROM THE USE OF THIS PRODUCT, OR ARISING OUT OF ANY BREACH OF THIS WARRANTY. ALL EXPRESS AND IMPLIED WARRANTIES, INCLUDING THE WARRANTIES OF MERCHANTABILITY AND FITNESS FOR PARTICULAR PURPOSE, ARE LIMITED TO THE WARRANTY PERIOD SET FORTH ABOVE.

Some states do not allow the exclusion of incidental or consequential damages or limitations on how long an implied warranty lasts, so these limitations or exclusions may not apply to you. This warranty gives you specific legal rights and you may also have other rights which vary from state to state.

JVC COMPANY OF AMERICA
DIVISION OF JVC AMERICAS CORP.

1700 Valley Road
Wayne, NJ 07470

<http://www.jvc.com>

REFURBISHED PRODUCTS CARRY A SEPARATE WARRANTY, THIS WARRANTY DOES NOT APPLY. FOR DETAIL OF REFURBISHED PRODUCT WARRANTY, PLEASE REFER TO THE REFURBISHED PRODUCT WARRANTY INFORMATION PACKAGED WITH EACH REFURBISHED PRODUCT.

For customer use:

Enter below the Model No. and Serial No. which is located either on the rear, bottom or side of the cabinet. Retain this information for future reference.

Model No. : _____

Serial No. : _____

Purchase date : _____

Name of dealer : _____

Specifications

Amplifier

Output Power 200 W per channel, min. RMS, driven into 6 Ω at 1kHz, with no more than 10% total harmonic distortion

Input Sensitivity/Impedance (1 kHz)

AUX IN 400 mV/50 k Ω
Speaker terminals 6 - 16 Ω
Phones 32 Ω - 1 k Ω
17 mW/ch output into 32 Ω

Cassette Deck Section

Frequency Response
Type I (NORMAL) 63 Hz - 12 500 Hz
Wow And Flutter 0.15% (WRMS)

CD Player

CD Capacity 3 CDs
Dynamic Range 85 dB
Signal-To-Noise Ratio 85 dB
Wow And Flutter Unmeasurable

Tuner

FM Tuner
Tuning Range 87.5 MHz - 108.0 MHz
AM Tuner
Tuning Range 530 kHz - 1 710 kHz

Unit

Dimensions 270 mm \times 307 mm \times 492mm (W/H/D)
(10-11/16" \times 12-1/8" \times 19-3/8")
Mass Approx. 9.3 kg (20.5 lbs)

Speaker Specifications (each unit)

SP-MXKC45

Type 3-way bass-reflex type
Speaker Unit Woofer: 16 cm (6-5/16") cone \times 1
Mid: 5cm (2") cone \times 1
Tweeter: 2 cm (13/16") dome \times 1
Power Handling Capacity 200 W
Impedance 6 Ω
Frequency Range 45 Hz - 22 000 Hz
Sound pressure level 87 dB/W·m
Dimensions 220 mm \times 324 mm \times 238 mm(W/H/D)
(8-11/16" \times 12-13/16" \times 9-3/8")
Mass Approx. 3.6 kg (8 lbs)

Accessories

AM Loop Antenna (1)
FM Wire Antenna (1)
Remote Control (1)
Batteries R6P (SUM-3)/AA (15F) (2)

Power Specifications

Power Requirements AC 120 V \sim , 60 Hz
Power Consumption 180 W (power on mode)
23 W (in Standby mode)
1 W (in ECO mode)

Design and specifications are subject to change without notice.

JVC

JVC



English

Français

COMPACT COMPONENT SYSTEM SYSTEME DE COMPOSANTS COMPACT

MX-KC45

Consists of CA-MXKC45 and SP-MXKC45
Se compose de CA-MXKC45 et de SP-MXKC45

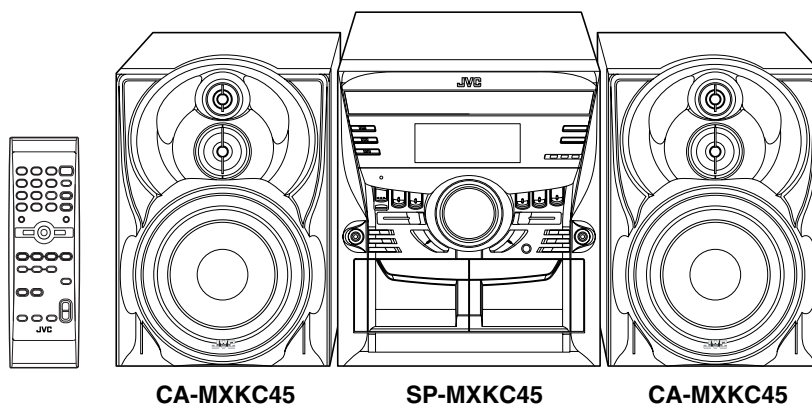

COMPACT
disc
DIGITAL AUDIO



MP3/WMA
PLAY BACK

INSTRUCTIONS MANUEL D'INSTRUCTIONS

LVT1521-002A
[C]

Warnings, Cautions and Others / Mises en garde, précautions et indications diverses

(For U.S.A)

	CAUTION RISK OF ELECTRIC SHOCK DO NOT OPEN	
CAUTION: TO REDUCE THE RISK OF ELECTRIC SHOCK DO NOT REMOVE COVER (OR BACK) NO USER SERVICEABLE PARTS INSIDE REFER SERVICING TO QUALIFIED SERVICE PERSONNEL.		



The lightning flash with arrowhead symbol, within an equilateral triangle is intended to alert the user to the presence of uninsulated "dangerous voltage" within the product's enclosure that may be of sufficient magnitude to constitute a risk of electric shock to persons.



The exclamation point within an equilateral triangle is intended to alert the user to the presence of important operating and maintenance (servicing) instructions in the literature accompanying the appliance.

WARNING: TO REDUCE THE RISK OF FIRE OR ELECTRIC SHOCK, DO NOT EXPOSE THIS APPLIANCE TO RAIN OR MOISTURE.

CAUTION

Changes or modifications not approved by JVC could void the user's authority to operate the equipment.

INFORMATION

This equipment has been tested and found to comply with the limits for a Class B digital device, pursuant to Part 15 of the FCC Rules. These limits are designed to provide reasonable protection against harmful interference in a residential installation. This equipment generates, uses, and can radiate radio frequency energy and, if not installed and used in accordance with the instructions, may cause harmful interference to radio communications. However, there is no guarantee that interference will not occur in a particular installation. If this equipment does cause harmful interference to radio or television reception, which can be determined by turning the equipment off and on, the user is encouraged to try to correct the interference by one or more of the following measures:

- Reorient or relocate the receiving antenna.
- Increase the separation between the equipment and receiver.
- Connect the equipment into an outlet on a circuit different from that to which the receiver is connected.
- Consult the dealer or an experienced radio/TV technician for help.

Note to CATV system installer:

This reminder is provided to call the CATV system installer's attention to section 820-40 of the NEC which provides guidelines for proper grounding and, in particular, specifies that the cable ground shall be connected to the grounding system of the building, as close to the point of cable entry as practical.

For Canada/pour le Canada

THIS DIGITAL APPARATUS DOES NOT EXCEED THE CLASS B LIMITS FOR RADIO NOISE EMISSIONS FROM DIGITAL APPARATUS AS SET OUT IN THE INTERFERENCE-CAUSING EQUIPMENT STANDARD ENTITLED "DIGITAL APPARATUS," ICES-003 OF THE DEPARTMENT OF COMMUNICATIONS.

CET APPAREIL NUMERIQUE RESPECTE LES LIMITES DE BRUITS RADIOELECTRIQUES APPLICABLES AUX APPAREILS NUMERQUES DE CLASSE B PRESCRITES DANS LA NORME SUR LE MATERIEL BROUILLEUR: "APPAREILS NUMERQUES", NMB-003 EDICTEE PAR LE MINISTRE DES COMMUNICATIONS.

CAUTION — ϕ /I STANDBY/ON button !

Disconnect the mains plug to shut the power off completely (all lamps and indications go off). When installing the product, ensure that the plug is easily accessible. The ϕ /I STANDBY/ON button in any position does not disconnect the mains line.

- When the unit is on standby, the STANDBY lamp lights red.
 - When the unit is turned on, the STANDBY lamp goes off.
- The power can be remote controlled.

ATTENTION — Touche ϕ /I STANDBY/ON

Déconnectez la fiche de secteur pour mettre l'appareil complètement hors tension (tous les témoins et toutes les indications s'éteignent). Lors de l'installation de l'appareil, assurez-vous que la fiche soit facilement accessible. La touche ϕ /I STANDBY/ON dans n'importe quelle position ne déconnecte pas l'appareil du secteur.

- Quand l'appareil est en mode d'attente, le témoin STANDBY est allumé en rouge.
- Quand l'appareil est sous tension, le témoin STANDBY s'éteint.

L'alimentation ne peut pas être commandée à distance.

IMPORTANT FOR LASER PRODUCTS / IMPORTANT POUR PRODUITS LASER

1. CLASS 1 LASER PRODUCT
2. **CAUTION:** Do not open the top cover. There are no user serviceable parts inside the unit; leave all servicing to qualified service personnel.
3. **CAUTION:** VISIBLE AND / OR INVISIBLE CLASS 1M LASER RADIATION WHEN OPEN. DO NOT STARE INTO BEAM OR VIEW DIRECTLY WITH OPTICAL INSTRUMENTS.
4. REPRODUCTION OF LABEL: CAUTION LABEL, PLACED INSIDE THE UNIT.

1. PRODUIT LASER CLASSE 1
2. **ATTENTION:** N'ouvrez pas le couvercle supérieur. Il n'y a aucune pièce réparable par l'utilisateur à l'intérieur de l'appareil; confiez toute réparation à un personnel qualifié.
3. **ATTENTION:** RAYONNEMENT LASER VISIBLE ET / OU INVISIBLE DE CLASSE 1M UNE FOIS OUVERT. NE PAS FIXER LE FAISCEAU NI REGARDER DIRECTEMENT AVEC DES INSTRUMENTS OPTIQUES.
4. REPRODUCTION DE L'ÉTIQUETTE: ÉTIQUETTE DE PRÉCAUTION PLACÉE À L'INTERIEUR DE L'APPAREIL.

CAUTION VISIBLE AND / OR INVISIBLE CLASS 1M LASER RADIATION WHEN OPEN. DO NOT STARE INTO BEAM OR VIEW DIRECTLY WITH OPTICAL INSTRUMENTS. (EN)	VARNING SYNBLIG OCH / ELLER OSYNBLIG LASERSTRÅLNING. KLASS 1M, NÄR DENNA DEL ÄR ÖPPNAD, STIRRA EJ IN I STRÅLEN OCH BETRÄKTA EJ STRÅLEN MED OPTISKA INSTRUMENT. (SVE)	AVISO RADIACIÓN LÁSER DE CLASE 1M VISIBLE Y/O INVISIBLE. CUANDO ESTÁ ABIERTO, NO MIRAR FLAMIENTE EL HAZ NI OBSERVAR DIRECTAMENTE CON INSTRUMENTAL ÓPTICO. (ESP)	ADVARSEL SYNBLIG OG/ELLER USYNBLIG KLASSE 1M-LASERSTRÅLING VED ÅBNING. SE IKKE IND I STRÅLEN - HELLER IKKE MED OPTISKE INSTRUMENTER. (DNK)	VARO! AVAT TAESSA OLET ALT TIINA NÄKYVÄLLE JA/TAI NÄKYMÄTTÖMÄLLE LUOKAN 1M LASERÄTILVYLLE. ÄLÄ KATSO SUORAAN SÄTEESEEN TAI TARKASTELE, SITÄ OPTISEN LAITTEEN LAPI. (FIN)	ATTENTION RAYONNEMENT LASER VISIBLE ET/OU INVISIBLE DE CLASSE 1M UNE FOIS OUVERT. NE PAS FIXER LE FAISCEAU NI REGARDER DIRECTEMENT AVEC DES INSTRUMENTS OPTIQUES. LV44603-001A (FRA)
--	---	---	--	--	---

CAUTION

To reduce the risk of electrical shocks, fire, etc.:

1. Do not remove screws, covers or cabinet.
2. Do not expose this appliance to rain or moisture.
3. To prevent electric shock, match wide blade of plug to wide slot, fully insert.

CAUTION

1. Do not block the ventilation openings or holes.
(If the ventilation openings or holes are blocked by a newspaper or cloth, etc., the heat may not be able to get out.)
2. Do not place any naked flame sources, such as lighted candles, on the apparatus.
3. When discarding batteries, environmental problems must be considered and local rules or laws governing the disposal of these batteries must be followed strictly.
4. Do not expose this apparatus to rain, moisture, dripping or splashing and that no objects filled with liquids, such as vases, shall be placed on the apparatus.

ATTENTION

Afin d'éviter tout risque d'électrocution, d'incendie, etc.:

1. Ne pas enlever les vis ni les panneaux et ne pas ouvrir le coffret de l'appareil.
2. Ne pas exposer l'appareil à la pluie ni à l'humidité.
3. Pour éviter tout risque d'électrocution, faites correspondre la fiche large de la prise à la fente large puis insérez-la complètement.

ATTENTION

1. Ne bloquez pas les orifices ou les trous de ventilation.
(Si les orifices ou les trous de ventilation sont bloqués par un journal un tissu, etc., la chaleur peut ne pas être évacuée correctement de l'appareil.)
2. Ne placez aucune source de flamme nue, telle qu'une bougie, sur l'appareil.
3. Lors de la mise au rebut des piles, veuillez prendre en considération les problèmes de l'environnement et suivre strictement les règles et, les lois locales sur la mise au rebut des piles.
4. N'exposez pas cet appareil à la pluie, à l'humidité, à un égouttement ou à des éclaboussures et ne placez pas des objets remplis de liquide, tels qu'un vase, sur l'appareil.

Caution: Proper Ventilation

To avoid risk of electric shock and fire, and to prevent damage, locate the apparatus as follows:

1. Front:
No obstructions and open spacing.
2. Sides/ Top/ Back:
No obstructions should be placed in the areas shown by the dimensions below.
3. Bottom:
Place on the level surface. Maintain an adequate air path for ventilation by placing on a stand with a height of 10cm or more.

Attention: Aération correcte

Pour prévenir tout risque de décharge électrique ou d'incendie et éviter toute détérioration, installez l'appareil de la manière suivante:

1. Avant:
Bien dégagé de tout objet.
2. Côtés/dessus/dessous:
Assurez-vous que rien ne bloque les espaces indiqués sur le schéma ci-dessous.
3. Dessous:
Posez l'appareil sur une surface plane et horizontale. Veillez à ce que sa ventilation correcte puisse se faire en le plaçant sur un support d'au moins dix centimètres de hauteur.

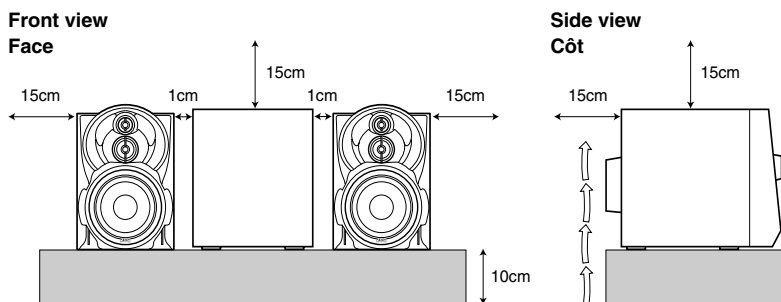

About the cooling fan

A cooling fan is mounted on the rear panel of the unit to prevent abnormal temperature inside the unit, thus assuring normal operation of the unit. The cooling fan automatically starts rotating to intake external cool air when the volume is increased up to more than a certain level.

À propos du ventilateur de refroidissement

Un ventilateur de refroidissement se trouve sur le panneau arrière de l'appareil afin d'éviter la création d'une température anormale à l'intérieur de l'appareil et permettre ainsi un fonctionnement normal de l'appareil. Le ventilateur de refroidissement commence à tourner et à aspirer de l'air frais automatiquement quand le volume est augmenté au-dessus d'un certain niveau.



[European Union only]

[Union européenne seulement]

Download from www.Somanuals.com. All Manuals Search And Download.

Introduction

Thank you for purchasing the JVC Compact Component System.
 We hope it will be a valued addition to your home, giving you years of enjoyment.
 Be sure to read this instruction manual carefully before operating your new stereo system.
 In it you will find all the information you need to set up and use the system.
 If you have a query that is not answered by the manual, please contact your dealer.

Features

Here are some of the things that make your System both powerful and simple to use.

- The controls and operations have been redesigned to make them very easy to use, freeing you to just enjoy the music.
 - With JVC's COMPU PLAY you can turn on the System and automatically start the Radio, Cassette Deck, or CD Player with a single touch.
- The great SEA (Sound Effect Amplifier) effects Rock, Pop and Classics are provided.
- The Sound Turbo function provides emphasized rich sound.
- A 45-station preset capability (30 FM and 15 AM) in addition to auto-seek and manual tuning.
- CD changer function can operate 3 discs.
 - Discs can be changed during play using the Carrousel tray (rotational tray).
- Two Decks enabling tape dubbing.
- Timer functions; Daily Timer, REC (Recording) Timer, and Sleep Timer.
- You can connect various external units, such as an MD recorder.
- The CD Player can play back a CD-R and CD-RW.



How This Manual Is Organized

- Basic information that is the same for many different functions - e.g. setting the volume - is given in the section "Basic Operations", and not repeated under each function.
- The names of buttons/controls and display messages are written in all capital letters: e.g. FM/AM, "NO DISC".
- If the button names on the Unit and the Remote Control are the same, the description on where the button is used will be omitted.
- System functions are written with an initial capital letter only: e.g. Normal Play.

Use the table of contents to look up specific information you require.

We have enjoyed making this manual for you, and hope it serves you in enjoying the many features built into your System.

IMPORTANT CAUTIONS

1 Installation of the System

- Select a place which is level, dry and neither too hot nor too cold. (Between 5°C and 35°C.)
- Leave sufficient distance between the System and a TV.
- Do not use the System in a place subject to vibrations.

2 Power cord

- Do not handle the power cord with wet hands!
- Some power is always consumed as long as the power cord is connected to the wall outlet.
- When unplugging the System from the wall outlet, always pull the plug, not the power cord.

3 Malfunctions, etc.

- There are no user serviceable parts inside. In case of system failure, unplug the power cord and consult your dealer.
- Do not insert any metallic object into the System.

Table of Contents

Introduction	1
Features.....	1
How This Manual Is Organized.....	1
IMPORTANT CAUTIONS.....	1
Table of Contents	2
Getting Started	3
Accessories	3
How To Put Batteries In the Remote Control.....	3
Using the Remote Control	3
Connecting the FM Antenna.....	4
Connecting the AM Antenna.....	5
Connecting the Speakers	5
Connecting External Equipment.....	6
Connecting to the Wall Outlet	6
DEMO Mode	6
COMPU Play	6
Basic Operations	7
Turning the Power On and Off	7
ECO Mode (ECO)	7
Adjusting the Volume.....	8
Fade-out Muting (FADE MUTING)	8
Emphasizing the sound(SOUND TURBO).....	8
Selecting the Sound Mode (SOUND MODE).....	8
Entering the Number with the Remote Control (Numeric Keys).....	8
Changing the Display	8
Using the Tuner	9
Tuning In a Station	9
Presetting Stations	10
To Change the FM Reception Mode	10
Using the CD Player	11
To Load CDs	12
To Unload CDs.....	12
Changing the MP3/WMA Playback Mode.....	12
Basics of Using the CD Player-Normal Play.....	13
Resume Play for Audio CD and MP3/WMA Disc.....	14
Programming the Playing Order of the Tracks.....	14
Random Play.....	15
Repeating Tracks	15
Tray Lock Function	15
Using the Cassette Deck (Listening to a Tape)	16
Playing a Tape	16
Using the Cassette Deck (Recording)	17
Standard Recording	18
CD Synchro Recording.....	18
Tape to Tape Recording (DUBBING).....	18
Using an External Equipment	19
Listening to the External Equipment	19
Using the Timers	20
Setting the Clock	20
Fixing the Clock	20
Setting the Daily Timer	21
Setting the REC (Recording) Timer	22
Setting the SLEEP Timer	24
Timer Priority	24
Care And Maintenance.....	25
Troubleshooting	26
Specifications	26

Getting Started

Accessories

Make sure that you have all of the following items, which are supplied with the System.

- AM Loop Antenna (1)
- FM Wire Antenna (1)
- Remote Control (1)
- Batteries (2)

If any of these items are missing, contact your dealer immediately.

How To Put Batteries In the Remote Control

Match the polarity (+ and -) on the batteries with the + and - markings in the battery compartment.

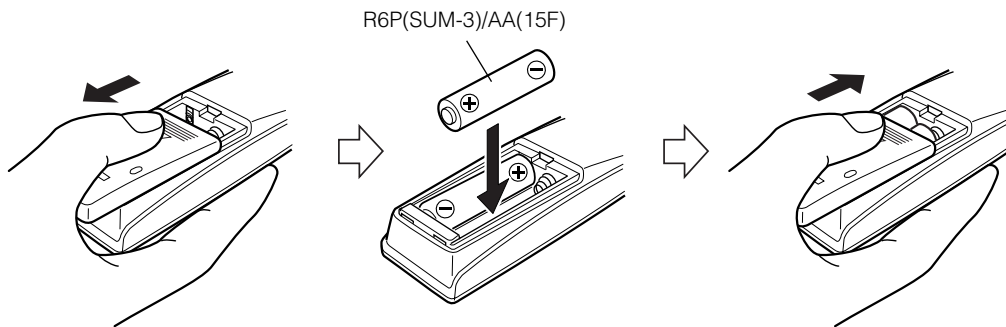

CAUTION:

- Handle batteries properly.

❑ To avoid battery leakage or explosion:

- Remove batteries when the Remote Control will not be used for a long time.
- When you need to replace the batteries, replace both batteries at the same time with new ones.
- Do not use an old battery with a new one.
- Do not use different types of batteries together.

Using the Remote Control

The Remote Control makes it easy to use many of the functions of the System from a distance of up to 7m away. You need to point the Remote Control at the remote sensor on the System's front panel.

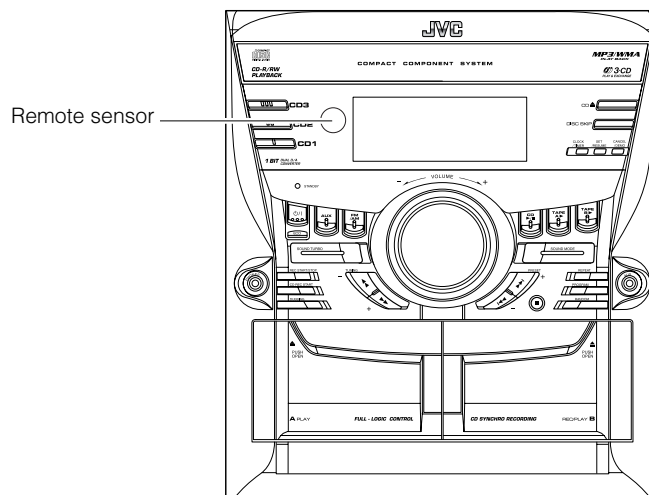

CAUTION:

- Make all connections before plugging the System into an AC power outlet.

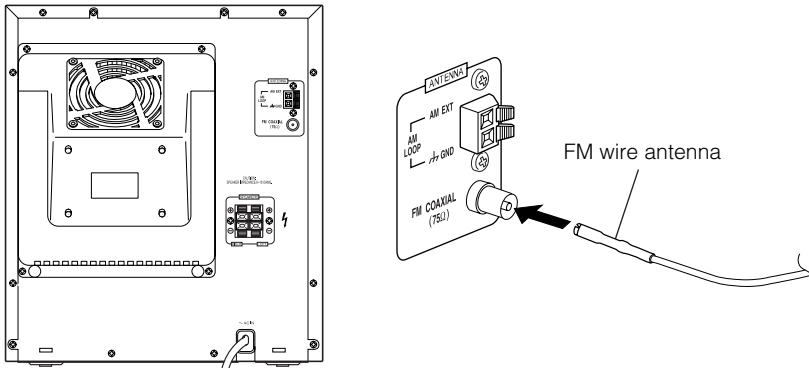
Connecting the FM Antenna**Using the Supplied Wire Antenna****Using the Coaxial Type Connector (Not supplied)**

A 75Ω antenna with coaxial type connector (IEC or DIN45 325) should be connected to the FM 75Ω COAXIAL terminal.

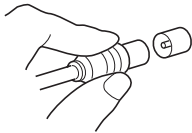

If reception is poor, connect the outdoor antenna.

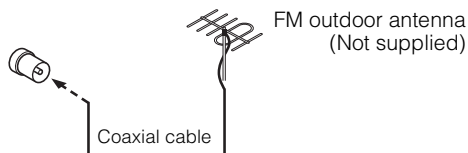
**Note**

- Before attaching a 75 ohm coaxial lead (the kind with a round wire going to an outdoor antenna), disconnect the supplied FM Wire Antenna.

Getting Started

Connecting the AM Antenna

Rear Panel of the Unit

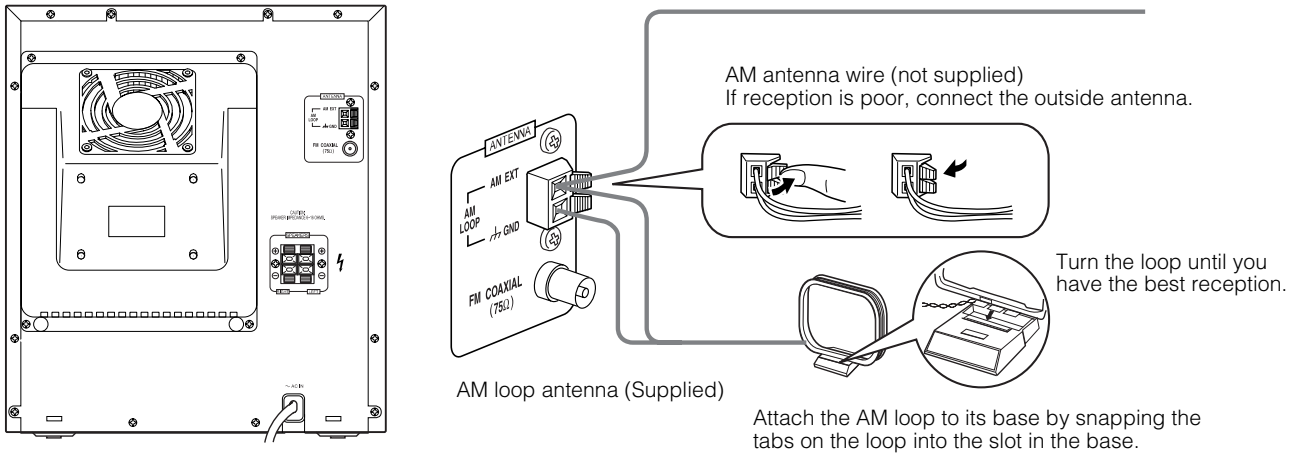

- Even when connecting an outside AM antenna, keep the indoor AM loop connected.

CAUTION:

- To avoid noise, keep antennas away from the System, the connecting cord and the AC power cord.

Connecting the Speakers

1. Open each of the terminals to connect the speaker wire leads.
2. Connect the speaker cords to the Speaker terminals of the Unit.
Connect the gray (+) and gray with black stripe (–) cords of the right side speaker to the red (+) and black (–) terminals marked RIGHT on the System.
Connect the gray (+) and gray with black stripe (–) cords of the left side speaker to the red (+) and black (–) terminals marked LEFT on the System.
3. Close each of the terminals.

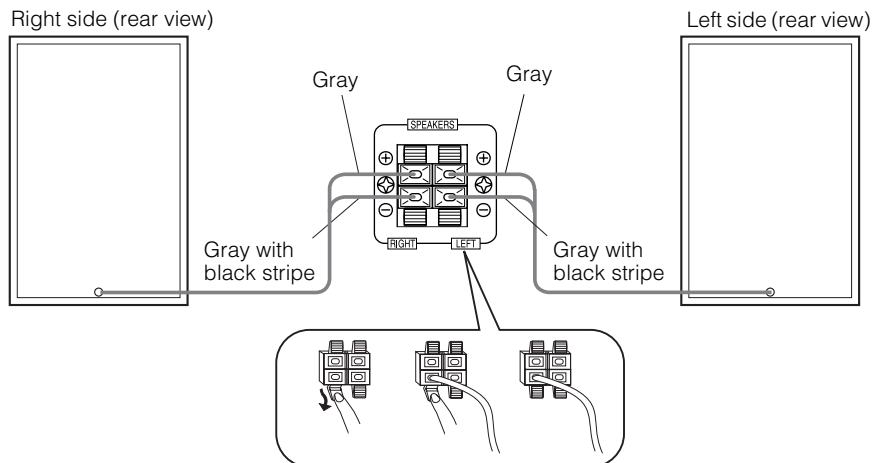

CAUTIONS:

- A TV may display irregular colors if located near the speakers. If this happens, set the speakers away from the TV.
- Use speakers with the correct impedance only. The correct impedance is indicated on the rear panel.

Connecting External Equipment

Connect a signal cord with stereo mini plugs (not supplied) between the System's AUX jack on the front panel and the audio output jack or output terminals of the external portable CD, MD player, STB, etc.

You can then listen to the external source through the System.

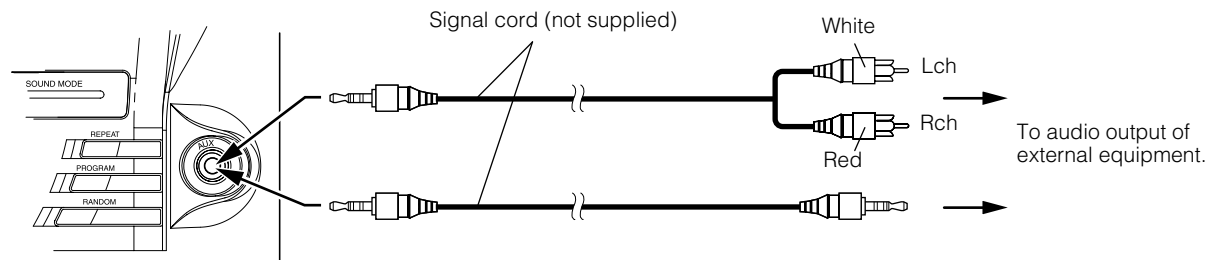

Connecting to the Wall Outlet

Plug the AC power cord into the wall outlet.

Now, your System is at your command!

DEMO Mode

When the System is connected to the wall outlet, a DEMO mode displaying some of the system's features automatically starts.

To turn the DEMO display off, press any of the operation buttons. The DEMO display automatically stops.

To turn the DEMO display on, press the DEMO button on the Unit for more than 2 seconds.

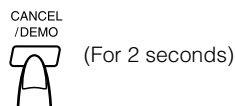

Note

- While the System is turned on, the DEMO display will automatically start if no operation is made for 2 minutes. To cancel this auto DEMO display function, press the CANCEL button on the Unit during DEMO display.

COMPU Play

JVC's COMPU PLAY feature lets you control the most frequently used System functions with a single touch.

With One Touch Operation you can play a CD, a tape, turn on the radio, or listen to an external equipment with a single press of the play button for that function. One Touch Operation turns the power on for you, then starts the function you have specified. If the System is not ready (no CD or tape in place), the System still powers on so you can insert a CD or tape.

How One Touch Operation works in each case is explained in the section dealing with that function.

The COMPU PLAY buttons are:

On the Unit

- CD ►/|| button
- FM/AM button
- TAPE A ►, TAPE B ► buttons
- AUX button
- CD1, CD2 and CD 3 buttons
- CD Open/Close ▲ button

On the Remote Control

- CD ►/|| button
- FM/AM button
- TAPE A, TAPE B buttons
- AUX button
- CD1, CD2 and CD 3 buttons

Basic Operations

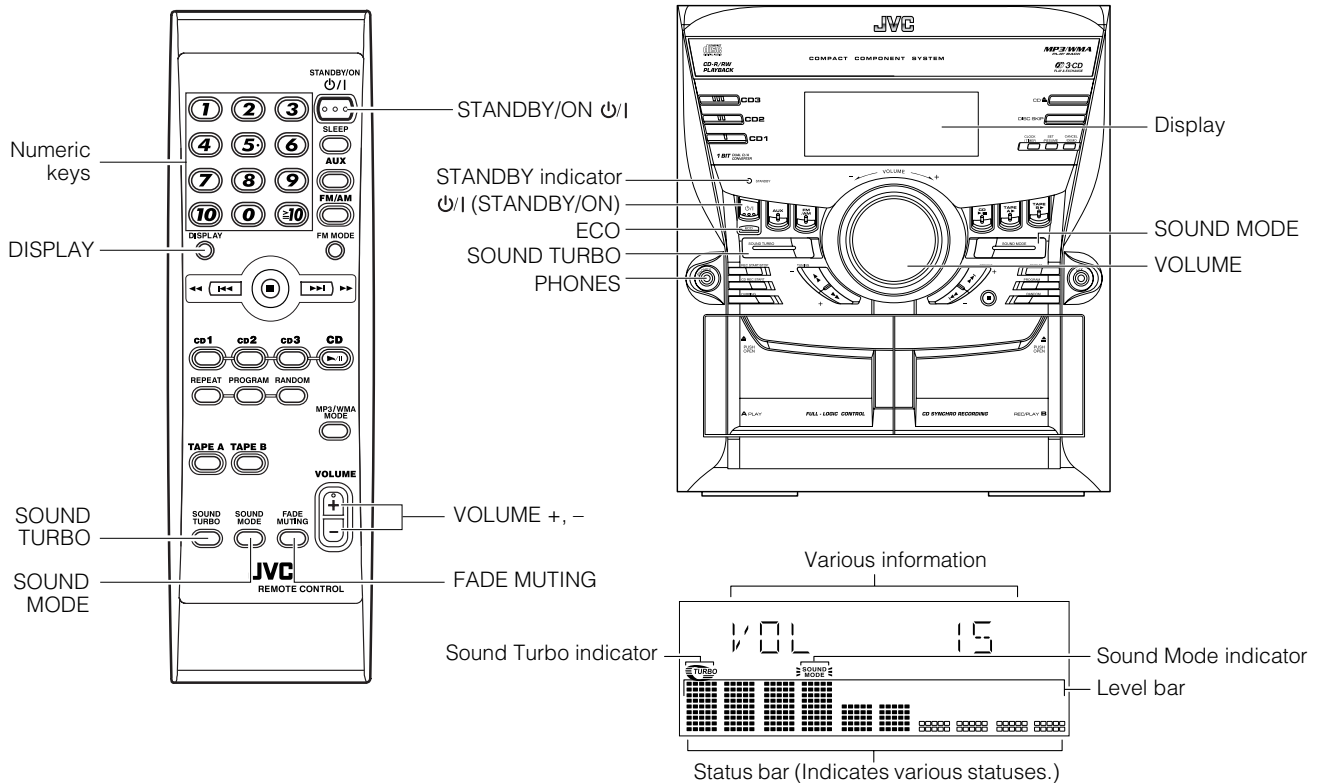

* When the System is in use, the display shows other items as well.
For simplicity, we show here only the items described in this section.

Turning the Power On and Off

Turning the System On

- 1 Press the $\phi/|$ STANDBY/ON button.

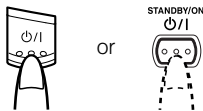

The display comes on and "POWER ON" is displayed once.
The STANDBY indicator goes out.
The System comes on ready to continue in the mode it was in when the power was last turned off.

Turning the System Off

- 1 Press the $\phi/|$ STANDBY/ON button again.

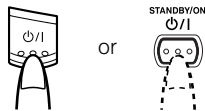

"GOOD BYE" is displayed and the display goes out, except for the clock display. The STANDBY indicator lights up. (The display is dimmed.)

- Some power is always consumed even though power is turned off (called Standby mode).
- To switch off the System completely, unplug the AC power cord from the wall outlet. When you unplug the AC power cord, the clock will be reset to AM 12:00 immediately.

ECO Mode (ECO)

The System has three energy modes; power on, power off (Standby) and ECO. In ECO mode, the display goes off and the least power is consumed.

To enter ECO mode, press the ECO button on the Unit in Standby mode (while the STANDBY indicator lights up). "ECO MODE" appears on the display, then the display goes off. The STANDBY indicator remains lit.

To cancel ECO mode and turn on the power, press the $\phi/|$ STANDBY/ON button on the Unit.

To cancel ECO mode and enter Standby mode, press the ECO button again.

Adjusting the Volume

Turn the VOLUME control on the Unit clockwise to increase the volume or turn it counterclockwise to decrease the volume.

Press the VOLUME + button on the Remote Control to increase the volume or press the VOLUME – button on the Remote Control to decrease the volume.



You can set the volume level to MIN, 1-30, or MAX.



- When you turn the power off at a volume level of over 19, the volume level is automatically set to 19 when the power is turned back on.

CAUTIONS:

- **DO NOT turn on the System and/or start playing any source without first setting the VOLUME control to minimum, as a sudden blast of sound could damage your hearing, speakers and/or headphones.**

For private listening

Connect a pair of headphones to the PHONES jack. No sound comes out of the speakers.

Be sure to turn down the volume before connecting or putting on headphones.

Fade-out Muting (FADE MUTING)

You can mute the output with one touch operation.

To muting the output, press the FADE MUTING button on the Remote Control. The output is faded out.

To release muting, press the FADE MUTING button once again. The output is faded in to the previous level.

- After Fade-out Muting, turning the VOLUME control on the unit or pressing the VOLUME button on the Remote Control will increase the volume from the previous level.

Emphasizing the sound (SOUND TURBO)

High and low frequencies are highly boosted.

To get the effect, press the SOUND TURBO button. The SOUND TURBO indicator lights up and “S-TURBO” appears on the display.

To cancel the effect, press the button again. The SOUND TURBO indicator goes out and “OFF” appears on the display.

Selecting the Sound Mode (SOUND MODE)

You can select one of 3 SEA (Sound Effect Amplifier) modes. You can use this effect only for playback.

To get the effect, press the SOUND MODE button until Sound Mode you want appears on the display.

The SOUND MODE indicator lights up in the display.

Each time you press the button, the SOUND MODE changes as follows:

ROCK → POP → CLASSIC → FLAT → (back to the beginning)

To cancel the effect, press the SOUND MODE button until “FLAT” appears on the display.

The “SOUND MODE” indicator goes off.

ROCK	Boosts low and high frequencies. Good for acoustic music.
POP	Good for vocal music.
CLASSIC	Set for wide and dynamic sound stereo systems.
FLAT	No sound effect applies.

Entering the Number with the Remote Control (Numeric Keys)

You will use the number keys on the Remote Control to enter numbers for presetting stations, recalling the preset stations, or programming the playing tracks on CDs.

How to enter the number with the number keys is explained here.

Examples:

- To enter number 5, press 5.
- To enter number 15, press $\geq 10 \rightarrow 1 \rightarrow 5$.
- To enter number 20, press $\geq 10 \rightarrow 2 \rightarrow 0$.
(For MP3/WMA disc only)
- To enter number 125, press ≥ 10 (2 times) $\rightarrow 1 \rightarrow 2 \rightarrow 5$.

Changing the Display

On the Remote Control ONLY

Each time you press the DISPLAY button, the display changes as shown below:

Currently selected source ↔ Current time

Using the Tuner

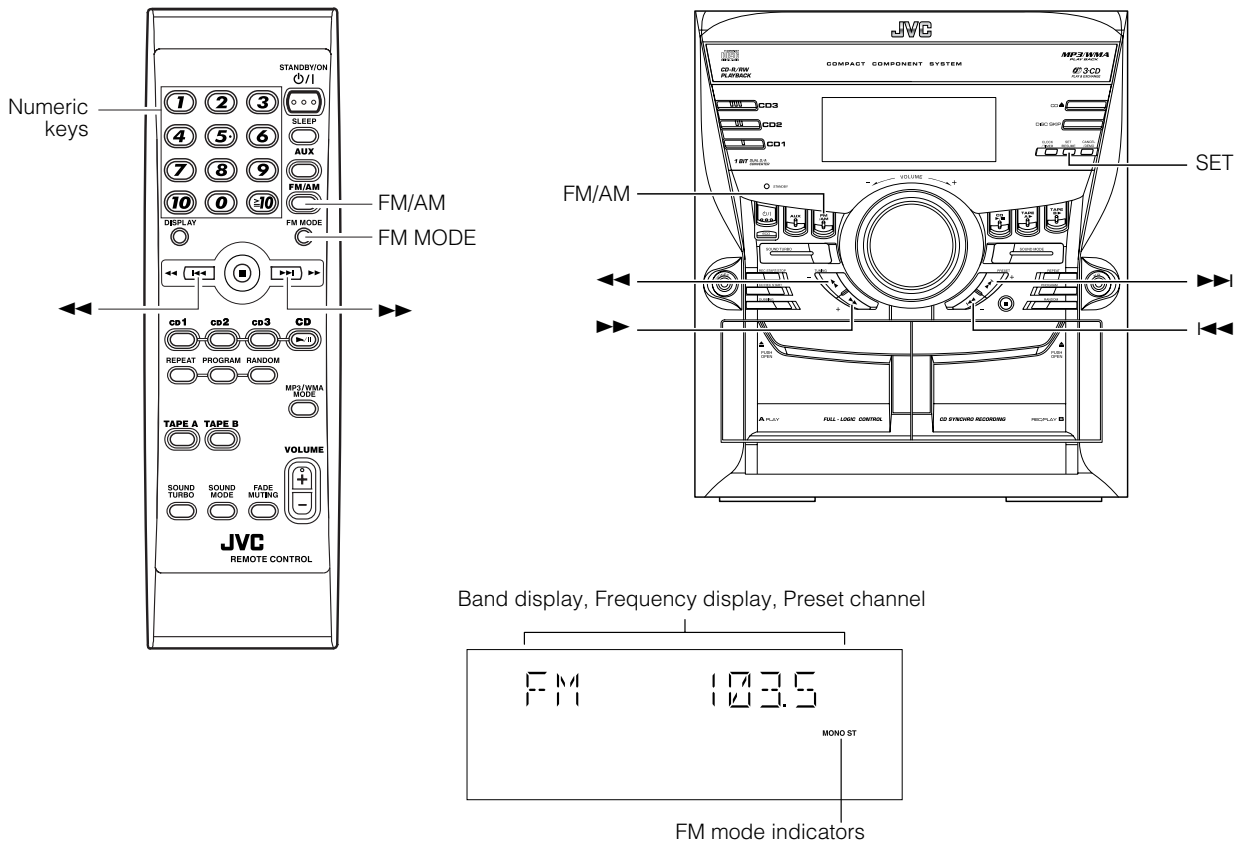

* When the System is in use, the display shows other items as well.
For simplicity, we show here only the items described in this section.

You can listen to FM and AM stations. Stations can be tuned in manually, automatically, or from preset memory storage.

☐ Before listening to the radio:

- Make sure that both the FM and AM antennas are correctly connected. (See pages 4 and 5.)

One Touch Radio

Just press the FM/AM button to turn on the System and start playing the station you were last tuned to.

☐ You can switch from any other sound source to the radio by pressing the FM/AM button.

Tuning In a Station

1 Press the FM/AM button.

The Band and Frequency you were last tuned to appear on the display.

Each time you press the button, the band alternates between FM and AM.

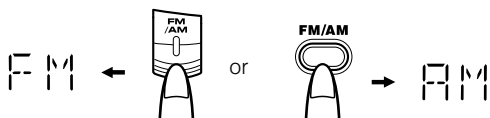

2 Select a station using one of the following methods.

• Manual Tuning

Briefly press the ◀◀ or ▶▶ button to move from frequency to frequency until you find the station you want.

OR

• Auto Tuning

If you hold down the ◀◀ or ▶▶ button for 1 second or more and then release it, the frequency changes down, or up, automatically until a station is found.

OR

• Preset Tuning (Possible only after presetting stations)

Preset tuning using the Unit:

Select the preset number you want, using the ◀◀ or ▶▶ button.

Example:

Press the ▶▶ button until the preset number "P-12" appears on the display. Then, the display will show the preset number's band and frequency.

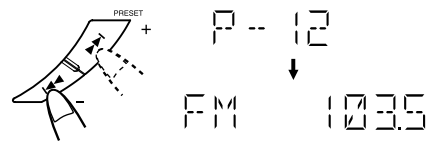

Preset tuning using the Remote Control:

Enter the preset number you want to recall using the numeric keys. See "Entering the Number with the Remote Control" on page 8.

Note

- In AM broadcast, reception sensitivity will be changed by turning the AM loop antenna. Turn the AM loop antenna for best reception.

Presetting Stations

You can preset up to 30 FM stations and up to 15 AM stations.

Notes

- Preset numbers may have been set to factory test frequencies prior to shipment. This is not a malfunction. You can preset the stations you want into memory by following one of the presetting methods below.
- During presetting stations, if no button operation is made for 5 seconds, the display returns to the band/frequency display. In this case, repeat steps from the beginning.

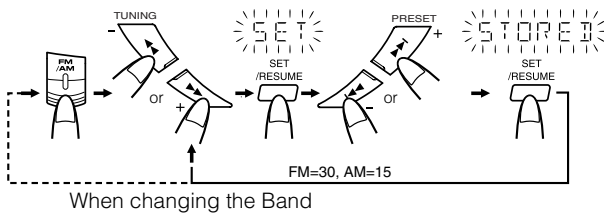
**On the Unit**

- 1 Select a band by pressing the FM/AM button.**
- 2 Press the ◀◀ or ▶▶ button to tune in a station.**
- 3 Press the SET button.**
“SET” will blink for 5 seconds.
- 4 While “SET” is blinking, press the ◀◀ or ▶▶ button to select the preset number.**
▶▶: Increases the preset number by 1.
◀◀: Decreases the preset number by 1.
- 5 Press the SET button.**
“STORED” appears and, after 2 seconds, the display returns to the band/frequency display.
- 6 Repeat above steps 2 to 5 for each station you want to store in memory with a preset number.**

To change the preset stations, repeat the same steps as above.

Note

- In step 4, you can select the preset number using the numeric keys on the Remote Control. See “Entering the Number with the Remote Control” on page 8.

CAUTION:

- Even if the System is unplugged or if the power failure occurs, the preset stations will be stored for a few days. However, in case the preset stations are erased, you will need to preset the stations again.

To Change the FM Reception Mode

When you are tuned in to an FM stereo broadcast, the “ST (Stereo)” indicator lights up and you can hear stereo effects. If an FM stereo broadcast is hard to receive or noisy, you can select Monaural mode. Reception improves, but you lose stereo effect.

Press the FM MODE button on the Remote Control so that the “MONO” indicator lights up on the display.

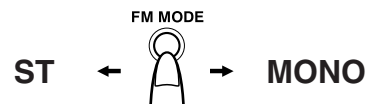

To restore the stereo effect, press the FM MODE button on the Remote Control so that the “MONO” indicator goes off.

Using the CD Player

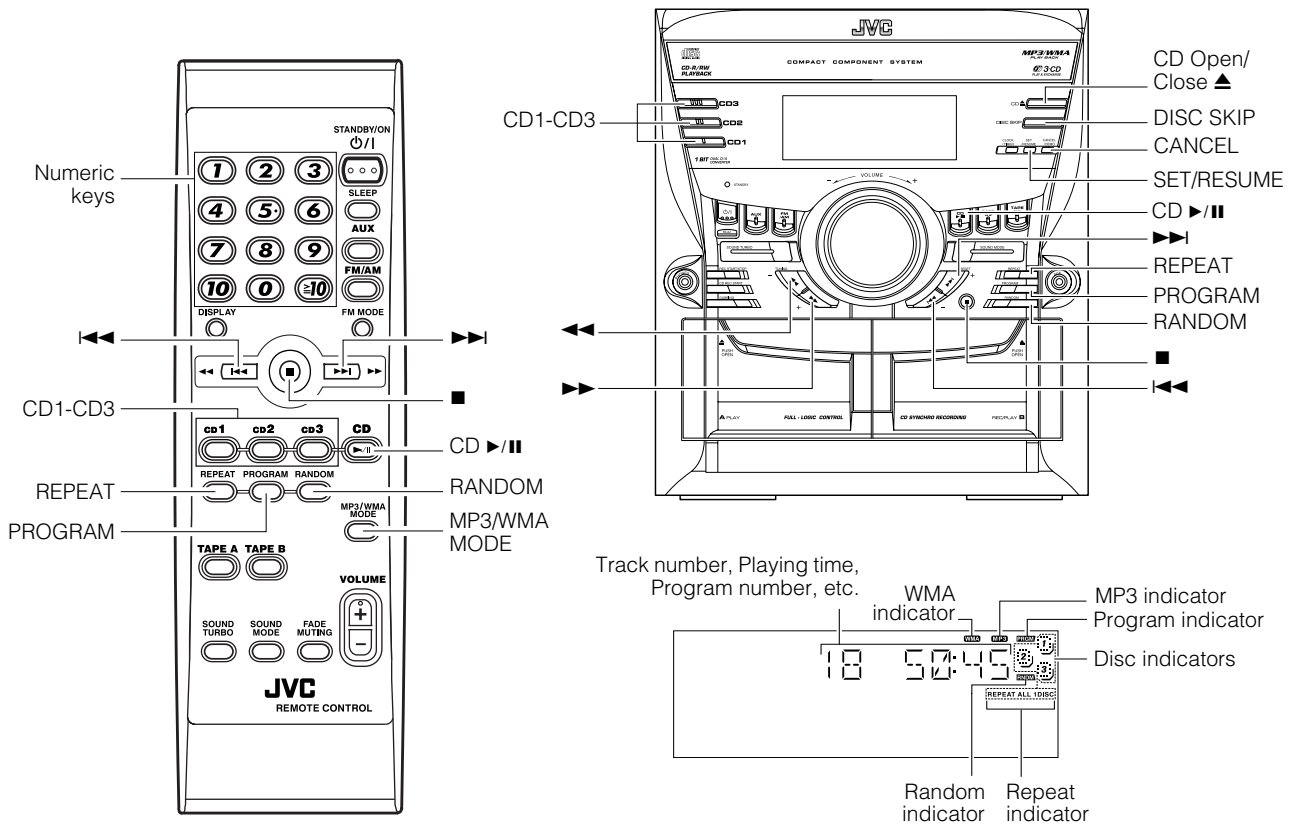

* When the System is in use, the display shows other items as well.
For simplicity, we show here only the items described in this section.

This unit has been designed to playback the following CDs:

- Audio CD
- CD-R (CD-Recordable)
- CD-RW (CD-ReWritable)
- MP3/WMA disc (MP3/WMA files recorded on a CD-R or CD-RW)*

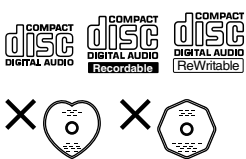

Only CDs bearing these marks can be used with this System. However, continued use of irregular shape CDs (heart-shape, octagonal, etc.) can damage the System.

When playing a CD-R or CD-RW

- User-edited CD-Rs (CD-Recordable) and CD-RWs (CD-ReWritable) can be played back when they are already “finalized.”
- Before playing back CD-Rs or CD-RWs, read their instructions or cautions carefully.
- Some CD-Rs or CD-RWs may not be played back on this unit because of their disc characteristics, damage or stain on them, or if the player’s lens is dirty.
- CD-RWs may require a longer readout time since the reflectance of CD-RWs is lower than for regular CDs.

*For MP3/WMA discs

- This unit manages files and folders on MP3/WMA discs as “tracks” and “albums.”
- Playback order of the MP3/WMA files (tracks) recorded on a disc are determined by the writing (or encoding) application; therefore, playback order may be different from the one you have intended while recording the files and the folders.
- This unit shows the file (track) names and ID3v2 tags (only “Title”, “Artist” and “Album”) on the display after starts play; however, there is a limitation on available characters and some file names and ID3 tags are not shown correctly.

Notes

More about MP3/WMA discs

- MP3/WMA discs (either CD-R or CD-RW) require a longer readout time. (It varies due to the complexity of the recording configuration.)
- When making an MP3/WMA disc, select ISO 9660 Level 1 or Level 2 as the disc format.
- This unit does not support multisession recording.
- This unit can play MP3/WMA files only with the following file extensions— “.mp3” and “.wma”.
- Non-MP3/WMA files are ignored. If non-MP3/WMA files are recorded together with MP3/WMA files, this unit will take a longer time to scan the disc. It may also cause the unit to malfunction.
- Some MP3/WMA discs may not be played back because of their disc characteristics or recorded conditions.

Caution for DualDisc playback

The Non-DVD side of a “DualDisc” does not comply with the “Compact Disc Digital Audio” standard. Therefore, the use of Non-DVD side of a DualDisc on this product may not be recommended.

About Disc Indicator:

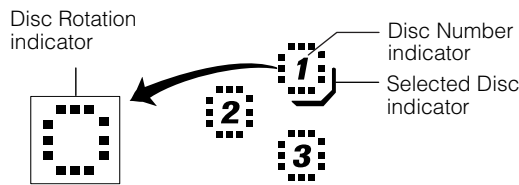

The Disc indicator consists of the following three kinds of indicators:

Disc Number indicator: Lights all the time.

Selected Disc indicator: Lights for the currently selected disc number.

Disc Rotation indicator: Runs when the selected CD is playing or paused. This indicator goes out if a CD is not loaded for the selected disc number.

One Touch Play

The power comes on, and operations are done automatically.

- By pressing the CD ►/|| button, the System will come on, and if a CD is loaded for the disc number that was lastly selected, it will start playing from the first track.
- By pressing the CD1-CD3 button, the System will come on, and if a CD is already loaded for the selected disc number, it will start play from the first track.

To Load CDs

1 Press the CD Open/Close ▲ button on the Unit to open the tray.

2 Place one or two CDs, with its label side up, onto the tray.

Be sure that the CD is securely seated inside the recess on the disc tray.

With the label side up

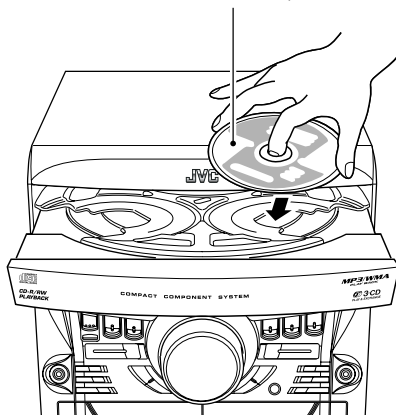

3 Press the DISC SKIP button on the Unit and place the next CD.

When you press the button, the tray turns for the next CD.

4 Press the CD Open/Close ▲ button on the Unit.

The tray is closed.

- When you use an 8 cm CD, place it on the inner circle of the tray.
- You can load CDs while listening to the other source or while listening to the CD being played back.
- When power is turned off with the tray opened, the tray is automatically closed.
- If the CD cannot be read correctly (because it is scratched, for example), “NO DISC” appears on the display.

To Unload CDs

Take out the CD as shown below.

1 While the CD Player is stopped, press the CD Open/Close ▲ button on the Unit to open the tray.

2 Remove the CD, then press the DISC SKIP button on the Unit.

The tray turns for the next CD.

3 Repeat step 2 to remove all the CDs.

4 Press the CD Open/Close ▲ button on the Unit to close the tray.

- You can remove CDs while listening to the other source.

Tips:

• Removing/changing the CDs during playback

While playing back a CD (e.g. CD1), you can remove or change the other CDs (e.g. CD2 and CD3) by pressing the CD Open/Close ▲ button. After removing or changing, press the same button to close the tray.

Changing the MP3/WMA Playback Mode

When playing an MP3/WMA disc, you can choose the playback mode of the MP3/WMA disc as follows:

TRACK mode:

The unit recognizes only tracks (files). You can play an MP3/WMA disc like an Audio CD.

GROUP mode:

The unit recognizes tracks (files) and albums (folders) on an MP3/WMA disc. You can play an MP3/WMA disc according to the way how they are grouped.

On the Remote Control ONLY

Press MP3/WMA MODE before or during playing an MP3/WMA disc.



GROUP indicator appears when the MP3/WMA playback mode is the GROUP mode.

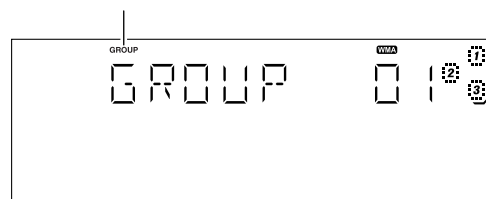

- Each time you press the button, the MP3/WMA playback mode changes between “GROUP” and “TRACK” alternately.

Basics of Using the CD Player- Normal Play

To Play CDs

- 1 Load CDs.
- 2 Press one of the Disc button (CD1-CD3) you want to play.

The selected disc number (e.g. "CD DISC 1") appears on the display.

The first track of the selected CD begins playing. When the first CD finishes playing, the next and the third CDs are continuously played back.

When the last CD has finished playing, it will return to the first CD and the CD Player automatically stops.

- You can start to play the currently selected disc by simply pressing the CD ►/|| button.

For Audio CD

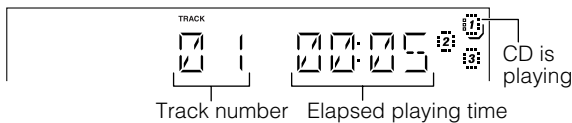

For MP3/WMA disc (The illustrations are for MP3 discs.)

TRACK mode

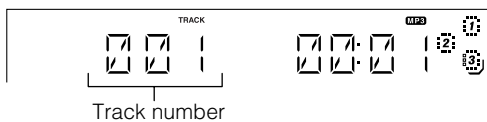

GROUP mode

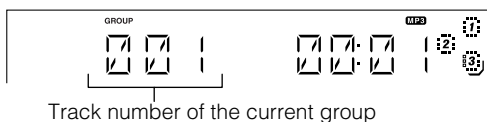

- After the display above is shown, if the tracks include ID3 tags, the display will scroll in the order of file name, title, artist, and album, then returns to the original display.

When the Disc button (CD1-CD3) is pressed with the tray opened, the tray is closed and the selected CD automatically begins playing.

To stop playing the CD, press the ■ button.

For Audio CD

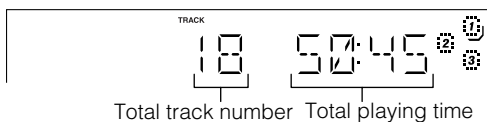

For MP3/WMA disc

TRACK mode

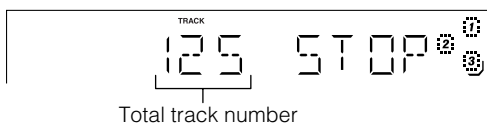

GROUP mode

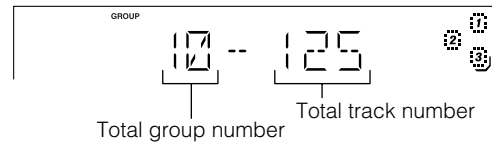

To pause, press the CD ►/|| button. The playing time indication blinks on the display.

To cancel pause, press the CD ►/|| button again. Play continues from the point where it was paused.

Tips:

- **Playing back the CD using the DISC SKIP button**

You can also play the CDs using the DISC SKIP button. During playback, each time you press the button, the next CD is automatically played back. If the next disc tray is empty, the disc tray is automatically skipped.

To Select a Track

During playback:

Briefly press the ◀◀ or ▶▶ button to select the track you want to play, except for MP3/WMA GROUP mode.

By pressing the button, you can skip to the next track or skip back to the previous track.

- The selected track starts playing.
- Press the ▶▶ button once to skip to the beginning of the next track.
- Press the ◀◀ button to skip to the beginning of the current track. Press twice quickly to skip to the beginning of the previous track.

In Stop mode:

By briefly pressing the ◀◀ or ▶▶ button, the CD Player operates in the same way as during playback, except for MP3/WMA GROUP mode.

Using the numeric keys on the Remote Control:

Using the numeric keys, you can directly select the track on the currently selected CD.

- The selected track starts playing.
- See "Entering the Number with the Remote Control" on page 8.
- In MP3/WMA GROUP mode:
The selected track of the current group starts playing.

Tips:

- **For MP3/WMA discs**

When the selected track starts playing, information of that track scrolls on the display, in the order of file name, title, artist, and album.

To Select a Group (For MP3/WMA GROUP mode only)

During playback:

Briefly press the ◀◀ or ▶▶ button to select the group you want to play.

- The first track of the selected group starts playing.

In Stop mode:

Briefly press the ◀◀ or ▶▶ button to select the group you want to play. The group number, the group name and the file name scroll on the display.

Search Play

Holding down the following buttons, during playback, will fast forward/backwards the CD so you can quickly find a particular passage in the track you are listening to.

- ◀◀ or ▶▶ button on the Unit
- ◀◀ or ▶▶ button on the Remote Control

Resume Play for Audio CD and MP3/WMA Disc

You can store the point of the track where you stopped playback. By pressing CD ►/|| button, you can start playback again from the point where you stopped it.

On the Unit ONLY

Press the SET/RESUME button for 2 seconds until both "RESUME" and "ON" appear on the display.

To turn off the resume play, press the SET/RESUME button for 2 seconds until both "RESUME" and "OFF" appear on the display.

Notes

- To playback from the first track while resume play is activated, press ■ button twice during playback.

The following operations will erase the memory of the track number that you have stopped playback when

- Pressing CD Open/Close ▲ button to eject the disc.
- Pressing CD1-CD3 button or DISC SKIP button to change the disc to play.

Programming the Playing Order of the Tracks

You can program the playing order of the tracks on all the CDs. Note that you can only make a program when the CD Player is stopped.

- You can program up to 32 tracks in any desired order including the same tracks.

Notes

For MP3/WMA discs

- If you try to select a MP3/WMA disc that has once been read or played, "MP3 DISC" or "WMA DISC" appears on the display and it can not be programmed.
- MP3/WMA disc that has not ever been read can be selected in a program mode. But when playback starts, "MP3 DISC" or "WMA DISC" appears on the display, the program is deleted and switched to a next program.

To Make a Program

1 Load CDs.

2 In Stop mode, set the CD Player in Program Play mode.

Press the PROGRAM button to light the "PRGM" indicator on the display.

At the same time, "PROGRAM" appears on the display.

Each time you press the button, the display changes as follows: PROGRAM → Normal display (Normal Play) → (back to the beginning)

- If a program is already made, the last step of the program will be displayed.

3 Press one of the Disc button (CD1-CD3) to select the CD you want to program.

The display will change to the Program Entry display.

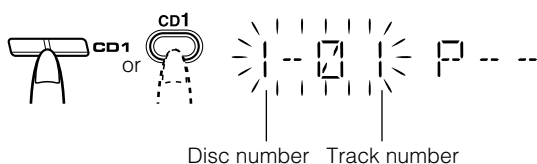

4 Select the track you want to program.

On the Unit

While the display is blinking, press the ◀◀ or ▶▶ button on the Unit to select the track, then press the SET button within 5 seconds. The program order number will be assigned from P-1.

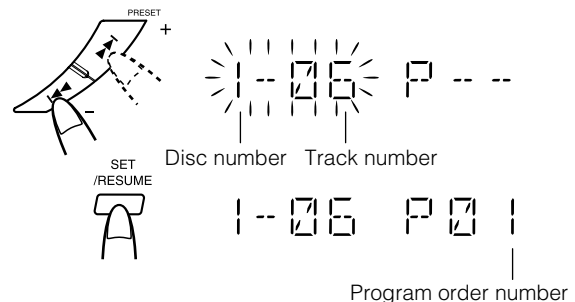

On the Remote Control

Press the numeric keys to directly enter the track number. Then, the program number will be assigned from P-1.

- To delete the current program step, press the CANCEL button on the Unit.

5 Repeat steps 3 and 4 to program other tracks on the same CD or the other CD.

6 To play the program, Press the CD ►/|| button.

For details, see "To Play the Program You Have Made" mentioned below.

To confirm the programmed contents, while the CD player is stopped, select Program mode by pressing the PROGRAM button and press the ◀◀ or ▶▶ button on the Remote Control.

To delete all the tracks in the program, while the CD Player is stopped, press the ■ button or open the tray by pressing the CD Open/Close ▲ button.

To Modify the Program, while the CD Player is stopped and the program mode is selected, press the CANCEL button, the last track in the program is deleted. To add new tracks to the end of the program, repeat above steps 3 and 4.

Notes

- If you try to program a track number that does not exist on the CD, your entry will be ignored.
- If you try to program the 33rd track, "FULL" appears on the display.

To Play the Program You Have Made

Press the CD ►/|| button.

The System plays the tracks in the order you have programmed them.

- To use Repeat Play for Program Play, press the REPEAT button to select "REPEAT" before starting playback. For details, see "Repeating Tracks" on page 15.

- You can skip to a particular program track by pressing the ◀◀ or ▶▶ button during Program Play.

- To stop playing, press the ■ button once. If you press the ■ button, while the CD Player is stopped, the program is deleted.

Using the CD Player

To Exit and Re-enter Program Play

The program you have made is stored in memory. So, you can exit Program Play temporarily or re-enter Program Play unless you delete the program.

To exit the program mode once, press the ■ button to stop playing. The "PRGM" indicator goes off and the Program mode will be canceled. The program is stored in the memory.

To re-enter Program Play mode, press the PROGRAM button until the "PRGM" indicator lights up again.



- Tray will not open during the program playback.

Random Play

The tracks of the selected CD will play in no special order when you use this mode.

1 In Stop mode, set the CD Player in Random Play mode.

Press the RANDOM button to light the "RNDM" and "1 DISC" indicator.

At the same time, "RANDOM" appears on the display.

Each time you press the button, the display changes as follows: RANDOM → Normal display (Normal Play) → (back to the beginning)

2 Press the CD ►/|| button.

The tracks on selected CD are played in random order.

To stop playing, press the ■ button. The Random mode is canceled and the "RNDM" and "1 DISC" indicator goes off.

To skip a track during playback, press the ►| button to jump to the next track in the random sequence.

- To use Repeat Play for Random Play, press the RANDOM button to display "REPEAT" and "1DISC" before starting playback. For details, see "Repeating Tracks" mentioned below.

Repeating Tracks

You can repeat all tracks or individual track, as many times as you like.

Press the REPEAT button.

The Repeat indicator changes with each press of the button, as follows:

REPEAT 1 → REPEAT 1DISC → REPEAT ALL → Normal display (Normal Play) → (back to the beginning)

REPEAT 1: Repeats one track.

REPEAT 1DISC: Repeats all tracks on one CD. (Selectable in Normal Play and Random Play)

REPEAT ALL: In Normal Play mode, repeats all the tracks on all the CDs.

In Program Play mode, the Repeat indicator changes with each press of the REPEAT button, as follows:

REPEAT ↔ Blank display

It repeats all the tracks in the program.

To stop playing, press the ■ button. Changing the source to the other (e.g. Tuner) will also stop playing. The Repeat mode is canceled and the Repeat indicator goes off.

Tray Lock Function

In order to safely keep the CD in the CD Player, the tray can be electronically locked.

When the electronic lock is on, the tray cannot be opened even if the CD Open/Close ▲ button on the Unit is pressed.

Locking the Tray

1 Turn on the System and enter CD mode.

2 While pressing down the ■ button, press the CD Open/Close ▲ button on the Unit.

"LOCKED" appears on the display.



- If you try to open the tray by pressing the CD Open/Close ▲ button, "LOCKED" appears on the display to let you know that the tray has been locked.

Unlocking the Tray

Repeat above steps 1 and 2.

"UNLOCKED" appears on the display.



Now, you can use the tray normally.



- Even after the System is unplugged, the tray lock condition will be retained for a few days. To unlock the tray after powering up, you need to perform the unlocking operation.

Using the Cassette Deck (Listening to a Tape)

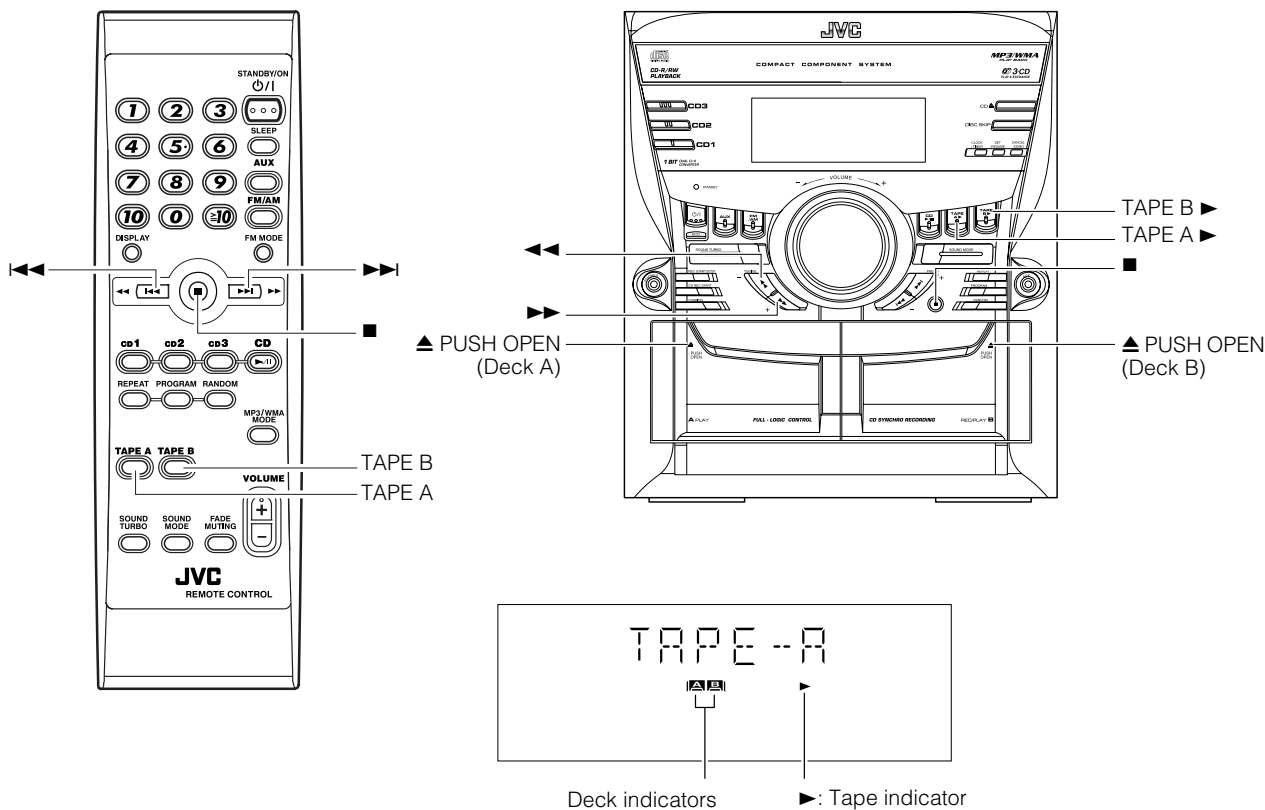

* When the System is in use, the display shows other items as well. For simplicity, we show here only the items described in this section.

The Cassette Deck allows you to play, record, and dub audio tapes.

Listening to type I tape is suitable for this Cassette Deck.

The use of tapes longer than 120 minutes (including 120 minute tapes) is not recommended, since characteristic deterioration may occur and these tapes easily jam in the pinch-rollers and the capstans.

One Touch Play

By pressing the TAPE A ► or TAPE B ► button, the System will come on, and if a tape is in the deck, it will start to play. If no tape is loaded in either Deck A or Deck B, "NO TAPE" appears on the display, the System will come on and wait for you to insert a tape, or select another function.

Playing a Tape

You can use either Deck A or Deck B at a time for playback.

1 Press the ▲ PUSH OPEN part for the deck you want to use.

2 When the cassette holder opens, put a cassette in, with the exposed part of the tape down, toward the base of the Unit.

The tape will travel from the left to right.

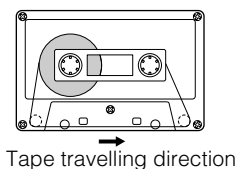

3 Press ▲ PUSH OPEN gently to close the cassette holder.

The Deck indicator "A" or "B" lights up on the display.

4 Press the TAPE A ► or TAPE B ► button.

The Tape indicator (►) blinks on the display and the tape is played back.

The Cassette Deck automatically stops when one side of the tape has finished playing.

To stop playing, press the ■ button.

To remove the tape, stop the tape, and press the ▲ PUSH OPEN part to open the Cassette Holder.

To Fast-Wind a Tape

During playback or in Stop mode, press the ►► (FF) button on the Unit to fast-wind the tape onto the right side of the cassette without playing. (You can also use the ►► button on the Remote Control.) During playback or in Stop mode, press the ◀◀ (REW) button on the Unit to fast-wind the tape onto the left side of the cassette without playing. (You can also use the ◀◀ button on the Remote Control.)

During fast-winding the tape, the Tape indicator (►) goes out.

During fast-winding, the status bar illumination at the bottom of the display moves counterclockwise.

During rewinding, it moves clockwise.

- The Cassette Deck automatically stops when one side of the tape has finished playing.

During fast-winding the tape, you can change the tape travelling direction by pressing the ►► (FF) or ◀◀ (REW) button.

Using the Cassette Deck (Recording)

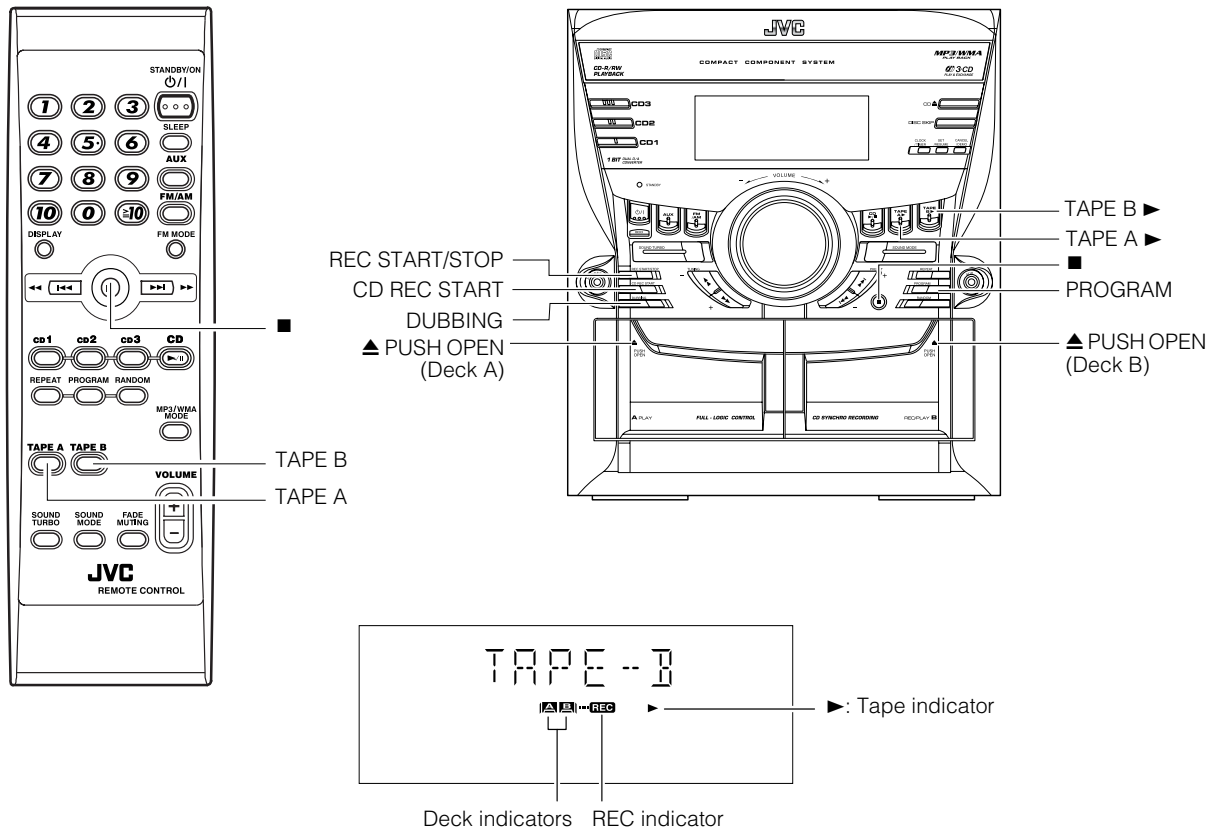

* When the System is in use, the display shows other items as well.
For simplicity, we show here only the items described in this section.

Recording onto a cassette from any of the sound sources is simple. Just place a tape in Deck B, have the source ready, make one or two settings, and you're ready to record. For each source, the procedure is a little bit different so we explain each separately. But first, here are a few things to make your recordings better.

Things To Know Before You Start Recording

- ❑ It may be unlawful to record or play back copyrighted material without the consent of the copyright owner.
- ❑ The recording level, which is the volume at which the new tape is being made, is automatically set correctly, so it is not affected by the VOLUME Control on the System. Also, it is not affected by adjusting the sound effects. Thus, during recording, you can adjust the sound you are actually listening to without affecting the recording level.
- ❑ Two small tabs on the back of the cassette tape, one for side A and one for side B, can be removed to prevent accidental erasure or recording.

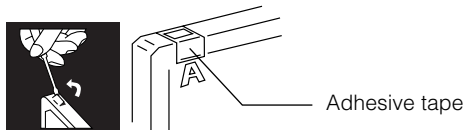

- ❑ To record on a cassette with the tabs removed, you must cover the holes with adhesive tape first.
- ❑ Type I tape can be used for recording.

Note

- At the start and end of cassette tapes, there is leader tape which cannot be recorded onto. Thus, when recording CDs, radio broadcasts, etc., wind on the leader tape first to ensure getting the beginning of the recording.

CAUTION:

- If a recording you make has excessive noise or static, the Unit may have been too close to a TV which was on during the recording. Either turn off the TV or increase the distance between the TV and the Unit.

Standard Recording

To Record Any Sound Source to Tape

Follow these steps to record from any sound source onto a tape in Deck B.

- 1 Insert a blank or erasable tape into the Deck B and wind past the tape leader.

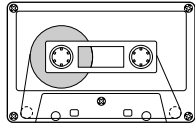

Tape travelling direction

- 2 Prepare the source, by, for example, tuning in a radio station, loading CDs, or turning on connected equipment.

- For CD recording, see “CD Synchro Recording” mentioned below.
- For dubbing, see “Tape to Tape Recording (DUBBING)” described below.

- 3 Press the REC START/STOP button on the Unit.

The “REC” indicator lights up and the System begins recording.

The Tape indicator (▶) blinks on the display.

- If the tab of the cassette tape on the Deck B is removed to prevent erasure or recording, “NO REC” will appear on the display.

To stop during recording, press the REC START/STOP button on the Unit, or press the ■ button.

Recording an AM Station to Tape (Beat Cut)

When recording an AM broadcast, beats may be produced which are not heard when listening to the broadcast. If this happens, press the FM MODE button on the Remote Control to eliminate the beats.

- 1 Set to AM station and start recording.
- 2 Press the FM MODE button on the Remote Control to eliminate the beats.

Each time you press the button, the display changes as shown below:

BEAT 1 ↔ BEAT 2

CD Synchro Recording

Everything on the CD goes onto the tape in the order it is on the CD, or according to the order you have set in a program.

- 1 Prepare CDs. (See page 12.)
Press the CD1-3 button (that you want to make recording), and then press the ■ button.
 - If you want to record specific tracks only, you need to program the tracks beforehand. (See page 14.)
 - If you want to record one CD only, you need to load one CD only.

- 2 Insert a blank or erasable tape into the Deck B and wind past the tape leader.

- 3 Press the CD REC START button on the Unit.

“CD REC” appears on the display and the “REC” indicator lights up. Then, the System begins CD Synchro Recording and the tracks on the CD are recorded on the tape.

When recording of the tracks of all CDs is finished, the CD Player and Cassette Deck stop.

- If the tab of the cassette tape on the Deck B is removed to prevent erasure or recording, “NO REC” will appear on the display.
- After the CD Player has played the entire CD or all the programmed tracks, the tape automatically stops.

To stop at any time during the recording process, press the ■ button. The CD Player and Cassette Deck stop.

Notes

- If the CD REC START button is pressed when “RESUME” is displayed (see page 14), CD Synchro Recording will be started from the beginning of the first track.
- When making SLEEP timer settings while doing CD Synchro recording, set enough time to allow for the CD to finish playing, otherwise the power will go off before recording is completed.

Tape to Tape Recording (DUBBING)

Recording from one tape to another is called dubbing.

You can dub tapes simply, with just a single button.

- 1 Press the TAPE A ▶ button, and then press the ■ button.
- 2 Insert the source cassette you want to copy from into Deck A for playback.
- 3 Insert a blank or erasable cassette you want to copy onto into Deck B for recording.
- 4 Press the DUBBING button on the Unit.

Deck A and Deck B will start simultaneously and the “REC” indicator lights up.

During dubbing, the Deck indicators “A” and “B” light up alternately.

- If no tape is inserted into Deck A, “NO TAPE” will appear on the display.
- If no tape is inserted into Deck B, “NO TAPE” will appear on the display.

To stop dubbing, press the REC START/STOP button on the Unit or the ■ button.

Note

- During dubbing, you can hear sound effects through the speakers or headphones. However, the sound is dubbed without sound effects.

Using an External Equipment

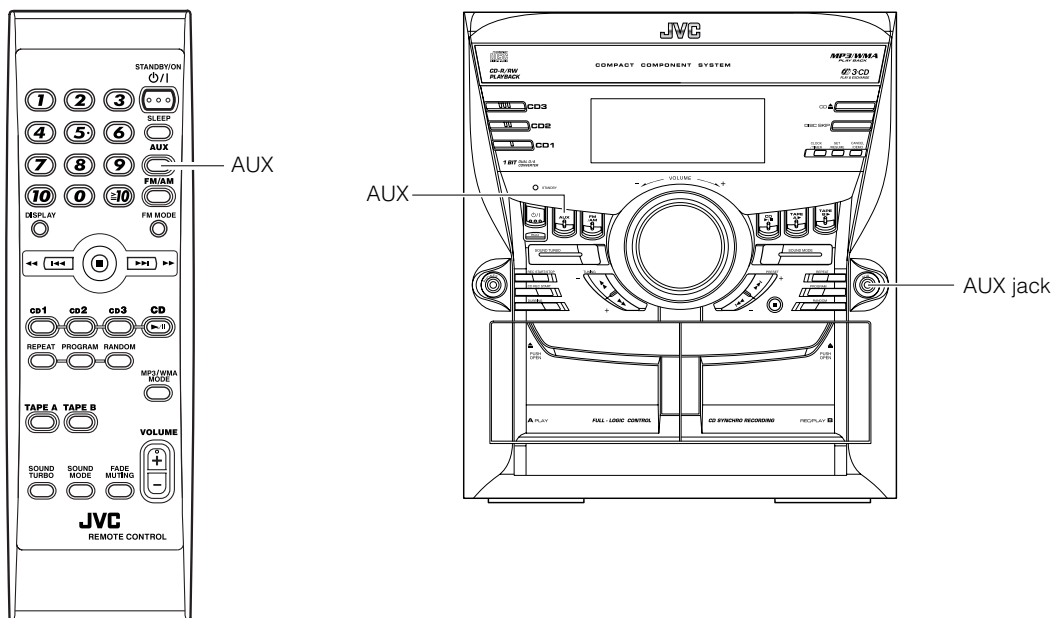

Listening to the External Equipment

You can listen to the external equipment such as portable CD, MD player, STB, or other auxiliary.

□ First, make sure that the external equipment is properly connected to the System. (See page 6.)

1 Set the volume level to the minimum position.

2 Press the AUX button.

“AUX IN” appears on the display.

AUX IN

3 Start playing the external equipment.

4 Adjust the volume level to the level you want listen to.

5 Apply the following sound effects, if you wish.

- SOUND TURBO (See page 8.)
- SOUND MODE (See page 8.)

Note

- For operation of the external equipment, refer to its Instructions.

Using the Timers

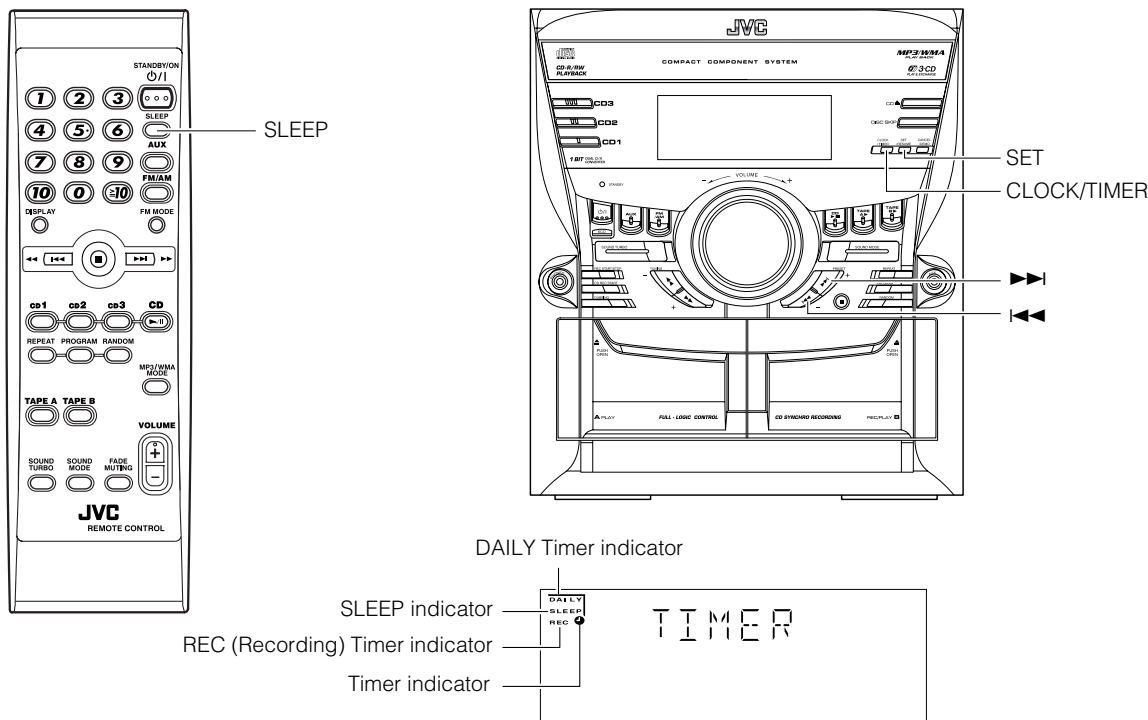

* When the System is in use, the display shows other items as well.
For simplicity, we show here only the items described in this section.

Three types of timers are available:

DAILY Timer

Use this timer to set wake up everyday to music from any source, instead of an alarm clock.

REC (Recording) Timer

Unattended recording of radio broadcasts. You can set the starting time and ending time.

SLEEP Timer

Fall asleep and have your System turn off automatically after a certain length of time.

Setting the Clock

When you plug the AC power cord into the wall outlet, the time indication "AM 12:00" blinks on the display.

You can set the clock whether the System is on or off.

On the Unit

1 Press the CLOCK/TIMER button.

The hour digit of the time indication blinks on the display.

2 Press the <<< or >>> button to set the hour.

Pressing the >>> button moves the time forwards and pressing the <<< button moves it backwards. Holding down the button moves the hour rapidly.

3 Press the SET button.

The minute digits of the time indication blink on the display.
• To return to the hour setting, press the CANCEL button.

4 Press the <<< or >>> button to set the minute.

5 Press the SET button.

"CLOCK OK" appears on the display. Then, the selected time is set and the seconds start counting from 0.

Fixing the Clock

On the Unit

1 Press the O/I STANDBY/ON button to turn on the System.

2 Press the CLOCK/TIMER button repeatedly until clock setting display (time indication) appears on the display.

Each time you press the button, display changes as follows:
DAILY → ON TIME → REC → ON TIME → Clock Setting display (time indicator) → Canceled → (back to the beginning)

3 Press the SET button.

The hour digits of the current clock blink on the display.

4 Follow steps 2 to 5 of "Setting the Clock" mentioned above.

Notes

- The clock must be correctly set for the timers to work.
- Each setting step must be completed within approx. 30 seconds. Otherwise, the setting is cleared and must be repeated from the beginning.
- The clock may gain or lose one to two minutes per month.
- If there is a power failure, the clock loses its setting immediately. "AM 12:00" blinks on the display and the clock must be reset.

Using the Timers

Setting the Daily Timer

Once you have set the Daily Timer, it is stored in memory. So, the Daily Timer will be activated at the same time every day until it is canceled.

The Timer indicator (🕒) and "DAILY" indicator on the display shows that the Daily Timer you have set is in effect.

You can set the Daily Timer whether the System is turned on or off.

Notes

- You can set the Daily Timer whether the System is on or off.
- Perform each setting within approx. 30 seconds. Otherwise, setting will be cleared and the procedure must be repeated from the beginning.
- If you have made a mistake while setting the timer, press the CANCEL button on the Unit. However, this does not always cancel the current setting. If the CANCEL button does not work, press the CLOCK/TIMER button on the Unit repeatedly until the display returns to the original display, and start from the first step.

On the Unit

1 Press the CLOCK/TIMER button until "ON TIME" immediately after "DAILY" appears on the display.

Each time you press the button, the display changes as follows:
DAILY → ON TIME* → REC → ON TIME → Clock setting display → Canceled → (back to the beginning)

*: This item should be selected for the Daily Timer setting.

Then, the System enters ON-time setting mode, and the current ON time appears on the display and the hour digits blink.

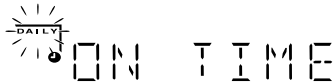
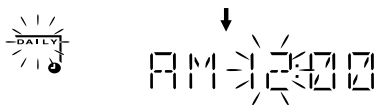
2 Setting the ON time (Example: AM 10:15).

1. Press the ►► or ◄◄ button to set the hour you want the System to come on, then press the SET button.
The minute digits of the ON time blink on the display.
Pressing the ►► button moves the time forwards and pressing the ◄◄ button moves it backwards.
Holding down the button moves the time rapidly.

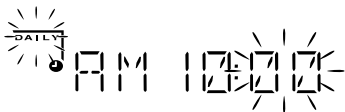

2. Press the ►► or ◄◄ button to set the minute, then press the SET button.



"OFF TIME" appears and then the System enters OFF-time setting mode. The current OFF time appears on the display, and the hour digits blink.

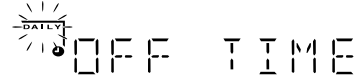

3 Setting the OFF time (Example: PM 1:15).

1. Press the ►► or ◄◄ button to set the hour you want the System to be turned off, then press the SET button.
The minute digits of the OFF time blink on the display.



2. Press the ►► or ◄◄ button to set the minute, then press the SET button.



The System enters Music Source Selecting mode and "TUNER FM" appears on the display.



4 Selecting the music source.

Press the ►► or ◄◄ button to select the music source you want to listen to, then press the SET button.

Each time you press the ►► or ◄◄ button, the display changes as shown below:

TUNER FM → TUNER AM → CD → TAPE → AUX IN → (back to the beginning)

According to the music source you have selected, the next operation differs.

When selecting TUNER FM or TUNER AM:

Press the ►► or ◄◄ button to select the preset station number, then press the SET button.

When "P--" is selected, the last station you were listening to will be set.

When selecting CD :

Press the ►► or ◄◄ button to select the disc number, then press the SET button.

Each time you press the button the disc number changes as follows:

DISC - → DISC 1 → DISC 2 → DISC 3 → (back to the beginning)

- If no disc number is specified, playback will start from the first track of the currently selected disc.

When selecting TAPE:

Insert a cassette tape you want to play into Deck A.

When selecting AUX:

Prepare the external equipment so that it will turn on at the ON time set by the System.

To allow this, the equipment should have the timer function.

5 Setting the volume level.

Press the ►► or ◀◀ button to select the volume level.

MIN, 1-30, or MAX: When the timer is turned on, the Volume will be automatically set to the selected level.

**6 Press the SET button.**

The timer setting is completed and the display returns to the display before you set the Timer.

7 Press the ⏻/| STANDBY/ON button to turn off the System, if necessary.

The Timer indicator (●) and "DAILY" indicator are lit on the display, showing that the Daily Timer is set to on.

To confirm / change the timer setting, repeat the setting procedure from the beginning.

When the timer ON-time comes:

The following operation will be automatically repeated every day.

- When the timer ON-time comes, the System automatically turns on. The music source you have set is played. The Timer indicator (●) blinks and "DAILY" indicator lights during timer operation.
- When the timer OFF-time comes, the System automatically turns off. Then, the Timer indicator (●) and "DAILY" indicator remain lit on the display.



- *If the System is already on when the timer ON-time comes, the Daily Timer does not work.*

To cancel the Daily Timer temporarily:

1 Press the CLOCK/TIMER button on the Unit repeatedly until the "DAILY" appears on the display.

2 Press the CANCEL button on the Unit.

"OFF" appears and both the Timer indicator (●) and the "DAILY" indicator go out.

To activate the cancelled Daily Timer:

1 Press the CLOCK/TIMER button on the Unit repeatedly until the "DAILY" appears on the display.

The "DAILY" indicator blinks and the Timer indicator (●) lights up on the display.

2 Press the SET button on the Unit.

"DAILY SET" appears on the display. The Timer indicator (●) and the "DAILY" indicator remain lit, and the display returns to the original display.



- *If the System is unplugged, or a power failure occurs, the timer setting will be lost in a few days. You will need to reset the clock first, then the timer.*

Setting the REC (Recording) Timer

With the Recording Timer, you can make a tape of a radio broadcast automatically whether or not you are home.

Once you have set the REC Timer to record a source, the timer setting is stored in memory. So, though the REC Timer turns off once it is used, you can recall it at any time.



- *You can set the REC Timer whether the System is on or off.*
- *Perform each setting within approx. 30 seconds. Otherwise, setting will be cleared and the procedure must be repeated from the beginning.*
- *If you have made a mistake while setting the timer, press the CANCEL button on the Unit. However, this does not always cancel the current setting. If the CANCEL button does not work, press the CLOCK/TIMER button on the Unit repeatedly until the display returns to the original display, and start from the first step.*

Using the Timers

On the Unit

You can set the time in the same way as for setting the Daily Timer.

1 Insert a blank or erasable tape into the Deck B and wind past the tape leader.

2 Press the CLOCK/TIMER button until "ON TIME" immediately after "REC" appears on the display.

Each time you press the button, the display changes as follows: DAILY → ON TIME → REC → ON TIME* → Clock setting display → Canceled → (back to the beginning)

*: This item should be selected for the REC Timer setting.

Then, the System enters ON-time setting mode. The current ON time appears on the display and the hour digits blink.

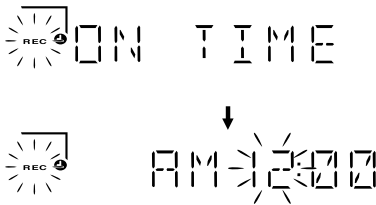

3 Setting the ON time you want the System to turn on.

1. Press the ◀◀ or ▶▶ button to set the hour, then press the SET button.

2. Press the ◀◀ or ▶▶ button to set the minute, then press the SET button.

"OFF TIME" appears and then the System enters OFF-time setting mode. The current OFF time appears on the display, and the hour digits blink.

4 Setting the OFF time you want the System to turn off.

1. Press the ◀◀ or ▶▶ button to set the hour, then press the SET button.

2. Press the ◀◀ or ▶▶ button to set the minute, then press the SET button.

The System enters Preset Station Entering mode.

5 Select the preset station for recording.

1. Press the ◀◀ or ▶▶ button to set the band (TUNER FM or TUNER AM), then press the SET button.

2. Press the ◀◀ or ▶▶ button to set the preset number, then press the SET button.

When "P---" is selected, the last station you were listening to will be set.

6 Setting the volume level.

Press the ▶▶ or ◀◀ button to select the volume level.

MIN, 1-30, or MAX: When the timer is turned on, the Volume will be automatically set to the selected level.



7 Press the SET button.

The timer setting is completed and the display returns to the display before you set the Timer.

8 Press the ⏻/| STANDBY/ON button to turn off the System, if necessary.

The Timer indicator (●) and "REC" indicator are lit on the display, showing that the Rec Timer is set to on.

To confirm / change the timer setting, repeat the setting procedure from the beginning.

When the timer ON-time comes:

- When the timer ON-time comes, the System automatically turns on. The station you have set is played. The Timer indicator (●) and Tape indicator (▶) blink, and the "REC" indicator lights during timer operation. To stop timer recording, press the ■ button.
- When the timer OFF-time comes, the System automatically turns off.

Note

- If the System is already on when the timer ON-time comes, the REC Timer does not work.

To cancel the REC Timer temporarily:

1 Press the CLOCK/TIMER button on the Unit repeatedly until "REC" appears on the display.

2 Press the CANCEL button on the Unit.

"OFF" appears and both the Timer indicator (●) and the "REC" indicator go out.

To activate the cancelled REC Timer:

1 Press the CLOCK/TIMER button on the Unit repeatedly until "REC" appears on the display.

The Timer indicator (●) lights and the "REC" indicator blinks on the display.

2 Press the SET button on the Unit.

"REC SET" appears on the display. The Timer indicator (●) and the "REC" indicator remain lit, and the display returns to the original display.

Note

- If the System is unplugged, or a power failure occurs, the timer setting will be lost in a few days. You will need to reset the clock first, then the timer.

Setting the SLEEP Timer

Use the Sleep Timer to turn the System off after a certain number of minutes when it is playing. By setting the Sleep Timer, you can fall asleep to music and know that your System will turn off by itself rather than play all night.

- You can only set the Sleep Timer when the System is on.

On the Remote Control

1 During playback a source, press the SLEEP button.

The "SLEEP" indicator starts blinking on the display.

2 Set the length of time you want the source to play before shutting off.

Each time you press the SLEEP button, the time length changes as follows:

10 → 20 → 30 → 60 → 90 → 120 → OFF → (back to the beginning)



3 Wait for 5 seconds.

The "SLEEP" indicator stops blinking and remains lit, and the display returns to the original one before setting the Sleep Timer.

The System is now set to turn off after the number of minutes you have set.

To Confirm the Sleep Time:

When the SLEEP button on the Remote Control is pressed, the remaining sleep time is displayed. Wait until the display returns to the original display.

To Cancel the SLEEP Timer Setting:

Press the SLEEP button until "OFF" appears on the display.

- Turning off the System also cancels the SLEEP Timer.



- When the REC Timer or the DAILY Timer is operating, SLEEP Timer can not be set.

Timer Priority

Since REC Timer and DAILY Timer can be set independently, you may wonder what happens if the settings overlap. Here are the priorities for REC Timer and DAILY Timer:

- Timer with the earlier time setting will have the priority. Timer will not operate when other Timer is operating.
 - If other Timer is set to an exact same time as the REC Timer, the REC Timer will have the priority.
- REC Timer and DAILY Timer will not operate when SLEEP Timer is operating.

Example

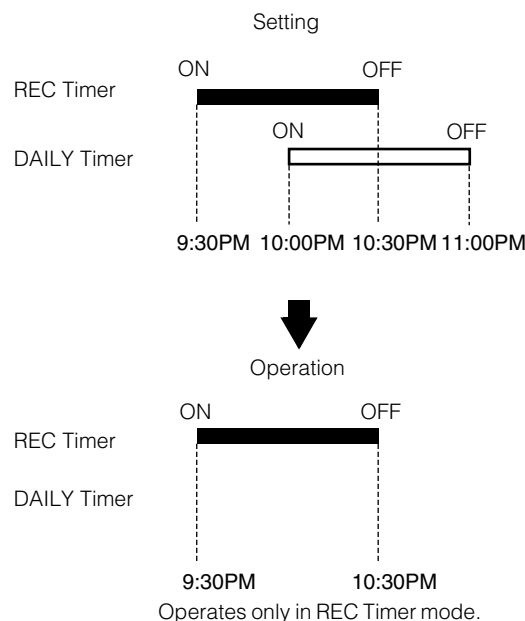

Care And Maintenance

Handle your CDs and tapes carefully, and they will last a long time.

Compact Discs



- Remove the CD from its case by holding it at the edges while pressing the case's center hole lightly.
- Do not touch the shiny surface of the CD, or bend the CD.



- Put the CD back in its case after use to prevent warping.
- Be careful not to scratch the surface of the CD when placing it back in the case.
- Avoid exposure to direct sunlight, temperature extremes, and moisture.



- A dirty CD may not play correctly. If a CD does become dirty, wipe it with a soft cloth in a straight line from center to edge.

CAUTION:

- Do not use any solvent (for example, conventional record cleaner, spray thinner, benzine, etc.) to clean a CD.

General Notes

In general, you will have the best performance by keeping your CDs and the mechanism clean.

- Store CDs in their cases, and keep them in cabinets or on shelves.
- Keep the System's Top Cover closed when not in use.

Moisture Condensation

Moisture may condense on the lens inside the System in the following cases:

- After turning on heating in the room.
- In a damp room.
- If the System is brought directly from a cold to a warm place.

Should this occur, the System may malfunction. In this case, leave the System turned on for a few hours until the moisture evaporates, unplug the AC power cord, and then plug it in again.

Cassette Tapes

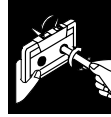

- If the tape is loose in its cassette, take up the slack by inserting a pencil in one of the reels and rotating.
- If the tape is loose, it may get stretched, cut, or caught in the cassette.

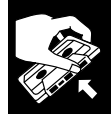

- Do not touch the tape surface.



- Do not store the tape:
 - In dusty places
 - In direct sunlight or heat
 - In moist areas
 - On a TV or speaker
 - Near a magnet

Cassette Deck

- If the heads, capstans, and pinch-rollers of the Cassette Deck become dirty, the following will occur:
 - Loss of sound quality
 - Discontinuous sound
 - Fading
 - Incomplete erasure
 - Difficulty recording
- Clean the heads, capstans, and pinch-rollers using a cotton swab moistened with alcohol.

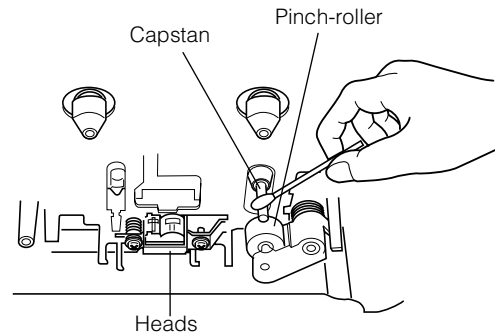

- If the heads become magnetized, the Unit will produce noise or lose high frequencies.
- To demagnetize the heads, turn off the Unit, and use a head demagnetizer (available at electronics and record shops).

Troubleshooting

- If you are having a problem with your System, check this list for a possible solution before calling for service.
- If you cannot solve the problem from the hints given here, or the System has been physically damaged, call a qualified person, such as your dealer, for service.

Symptom	Possible Cause	Action
No sound is heard.	<ul style="list-style-type: none"> • Connections are incorrect, or loose. • Headphones are connected. 	<ul style="list-style-type: none"> • Check all connections and make corrections. (See pages 4 to 6.) • Disconnect the headphones.
Poor radio reception	<ul style="list-style-type: none"> • The antenna is disconnected. • The AM Loop Antenna is too close to the System. • The FM Wire Antenna is not properly extended and positioned. 	<ul style="list-style-type: none"> • Reconnect the antenna securely. • Change the position and direction of the AM Loop Antenna. • Extend FM Wire Antenna to the best reception position.
The disc tray does not open.	<ul style="list-style-type: none"> • The AC power cord is not plugged in. • Tray is locked. 	<ul style="list-style-type: none"> • Plug the AC power cord. • Unlock the tray. (See page 15.)
The CD skips.	The CD is dirty or scratched.	Clean or replace the CD. (See page 25.)
The CD does not play.	The CD is upside down.	Put the CD in with the label side up.
The MP3/WMA disc does not play.	<ul style="list-style-type: none"> • No MP3/WMA files are recorded on the disc. • MP3/WMA files do not have the file extension — .wma or .mp3 in their file names. • MP3/WMA files are not recorded in the format compliant with ISO 9660 Level 1 or Level 2. 	Replace the disc.
The readout time of the MP3/WMA disc is too long.	The readout time varies with the complexity of the recording configuration.	Do not use too many hierarchies and folders when recording. Also, do not record any other types of audio tracks together with MP3/WMA files. (See page 11.)
The cassette holder cannot be opened.	During tape playing, the power cord was unplugged.	Plug in the power cord, and turn on the System.
Unable to record.	Cassette record protect tabs are removed.	Cover holes on back edge of cassette with tape.
Unable to operate the Remote Control.	<ul style="list-style-type: none"> • The path between the Remote Control and the sensor on the Unit is blocked. • The batteries have lost their charge. 	<ul style="list-style-type: none"> • Remove the obstruction. • Replace the batteries.
Operations are disabled.	The built-in microprocessor has malfunctioned due to external electrical interference.	Unplug the System then plug it back in.
“PROTECT” appears on the display, then the power goes off.	The speaker wire leads come in contact with each other.	Check the connections and make corrections. (See page 5.)

Specifications

Amplifier Output Power 200 W per channel, min. RMS, driven into 6 Ω at 1kHz, with no more than 10% total harmonic distortion		Speaker Specifications (each unit) SP-MXKC45 Type 3-way bass-reflex type Speaker Unit Woofer: 16 cm cone × 1 Mid: 5cm cone × 1 Tweeter: 2 cm dome × 1	
Input Sensitivity/Impedance (1 kHz) AUX IN 400 mV/50 kΩ Speaker terminals 6 - 16 Ω Phones 32 Ω - 1 kΩ 17 mW/ch output into 32 Ω		Power Handling Capacity 200 W Impedance 6 Ω Frequency Range 45 Hz - 22 000 Hz Sound pressure level 87 dB/W·m Dimensions 220 mm × 324 mm × 238 mm(W/H/D) Mass Approx. 3.6 kg	
Cassette Deck Section Frequency Response Type I (NORMAL) 63 Hz - 12 500 Hz Wow And Flutter 0.15% (WRMS)		Accessories AM Loop Antenna (1) FM Wire Antenna (1) Remote Control (1) Batteries R6P (SUM-3)/AA (15F) (2)	
CD Player CD Capacity 3 CDs Dynamic Range 85 dB Signal-To-Noise Ratio 85 dB Wow And Flutter Unmeasurable		Power Specifications Power Requirements AC 120 V $\sqrt{}$, 60 Hz Power Consumption 180 W (power on mode) 23 W (in Standby mode) 1 W (in ECO mode)	
Tuner FM Tuner Tuning Range 87.5 MHz - 108.0 MHz AM Tuner Tuning Range 530 kHz - 1 710 kHz		<i>Design and specifications are subject to change without notice.</i>	
Unit Dimensions 270 mm × 307 mm × 492mm (W/H/D) Mass Approx. 9.3 kg			



JVC

Free Manuals Download Website

<http://myh66.com>

<http://usermanuals.us>

<http://www.somanuals.com>

<http://www.4manuals.cc>

<http://www.manual-lib.com>

<http://www.404manual.com>

<http://www.luxmanual.com>

<http://aubethermostatmanual.com>

Golf course search by state

<http://golfingnear.com>

Email search by domain

<http://emailbydomain.com>

Auto manuals search

<http://auto.somanuals.com>

TV manuals search

<http://tv.somanuals.com>