

JVC

GD-463D10U GD-463D10E

3D LCD MONITOR INSTRUCTIONS



HDMI

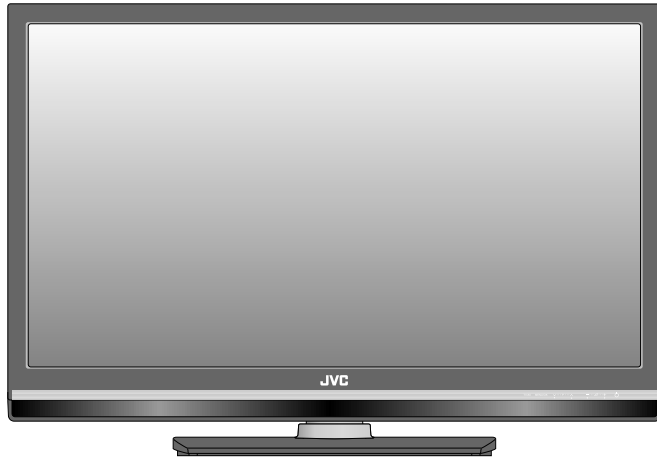

HD
ready
1080p



Contents

First things first!	● Safety Precautions..... 1
Getting started	● Remote control..... 6 ● Names and functions of parts 7 ● Getting started..... 9
Let's try it out	● Viewing 3D images 11 ● Watching videos / DVDs 13
Try the advanced features	● Useful functions 14
Just the way you like it	● Configuring your remote control..... 15 ● Customising your monitor 17 Picture 17 Features (sub menu)..... 18 Sound..... 19 Features 20 Set Up 21
When you have trouble	● Troubleshooting 23 ● Technical information 25 ● Specifications 26

Safety Precautions

 <div style="border: 1px solid black; padding: 5px; text-align: center;"> <p>CAUTION</p> <p>RISK OF ELECTRICAL SHOCK</p> <p>DO NOT OPEN</p> </div> 	<p>The lightning flash with arrowhead symbol, within an equilateral triangle is intended to alert the user to the presence of uninsulated "dangerous voltage" within the product's enclosure that may be of sufficient magnitude to constitute a risk of electric shock to persons.</p>
<p>CAUTION: To reduce the risk of electric shock. Do not remove cover (or back). No user serviceable parts inside. Refer servicing to qualified service personnel.</p>	<p>The exclamation point within an equilateral triangle is intended to alert the user to the presence of important operating and maintenance (servicing) instructions in the literature accompanying the appliance.</p>

WARNING: TO REDUCE RISK OF FIRE OR ELECTRIC SHOCK, DO NOT EXPOSE THIS APPARATUS TO RAIN OR MOISTURE. NO OBJECTS FILLED WITH LIQUIDS, SUCH AS VASES, SHALL BE PLACED ON THE APPARATUS.

IMPORTANT SAFEGUARDS

Electrical energy can perform many useful functions. This unit has been engineered and manufactured to assure your personal safety. But **IMPROPER USE CAN RESULT IN POTENTIAL ELECTRIC SHOCK OR FIRE**. In order not to defeat the safeguards incorporated into this product, observe the following basic rules for its installation, use, and service. Please read these "IMPORTANT SAFEGUARDS" carefully before use.

- All the safety and operating instructions should be read before the product is operated.
- The safety and operating instructions should be retained for future reference.
- All warnings on the product and in the operating instructions should be adhered to.
- All operating instructions should be followed.

POWER CONNECTION

The power supply voltage rating of this product is AC 100 V – 240 V.

- This product should be operated only with the type of power source indicated on the label. If you are not sure of the type of power supply of your home, consult your product dealer or local electric power company.

Note for United Kingdom power cord only

The plug of United Kingdom power cord has a built-in fuse. When replacing the fuse, be sure to use only a correctly rated approved type, re-fit the fuse cover. (Consult your dealer or qualified personnel.)

How to replace the fuse

Open the fuse compartment with the blade screwdriver, and replace the fuse.

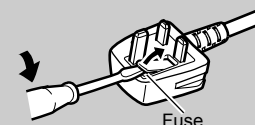

- Before connecting other products such as VCR's and personal computers, you should turn off the power of this product for protection against electric shock.
- Do not use attachments not recommended by the manufacturer as they may be hazardous.
- **When replacement parts are required**, be sure the service technician has used replacement parts specified by the manufacturer or equivalents. Unauthorized substitutions may result in fire, electric shock, or other hazards.
- **Upon completion of any service or repairs to this product**, ask the service technician to perform safety checks to determine that the product is in proper operating condition.

Under the following conditions,

1. Turn off the power.
2. Unplug this product from the wall outlet.
3. Refer service to qualified service personnel.
 - a) When the product emits smoke or unusual smell.
 - b) When the product exhibits a distinct change in performance—for example, no picture or no sound.
 - c) If liquid has been spilled, or objects have fallen on the product.
 - d) If the product has been exposed to rain or water.
 - e) If the product has been dropped or damaged in any way.
 - f) When the power supply cord or plug is damaged.

- Do not install this product in the following places:
 - in a damp or dusty room
 - where the product is exposed to soot or steam, such as near the cooking counter or a humidifier
 - near heat sources
 - where condensation easily occurs, such as near the window
- Do not place this product on an unstable cart, stand, or table. The product may fall, causing serious injury to a child or adult, and serious damage to the product.
The product should be mounted according to the manufacturer's instructions, and should use a mount recommended by the manufacturer.
- Do not use this product near water.
- Be sure to install the product in the place where proper temperature and humidity are kept (See "Operating conditions" on page 26).
This product becomes hot during its use. Take enough care when handling the product.

Do not attempt to service this product yourself, as opening or removing covers may expose you to dangerous voltages and other hazards. Refer all service to qualified service personnel.

- Do not use the product for a long time if the sound is distorted.
- Never listen to headphones at high volume, it may damage your hearing.

- Make enough room for inserting or removing the power plug. Place the product as close to an AC outlet as possible. The main power supply for the product is controlled by inserting or removing the power plug.
- When the product is left unattended and unused for a long period of time, unplug it from the wall outlet and disconnect the cable system.
- Do not overload wall outlets, extension cords, or convenience receptacles on other equipment as this can result in a risk of fire or electric shock.

- Slots and openings in the cabinet are provided for ventilation. These ensure reliable operation of the product and protect it from overheating. These openings must not be blocked or covered.
- Never push objects of any kind into this product through openings as they may touch dangerous voltage points or short-circuit the parts, which could result in a fire or electric shock.
- Never spill liquid of any kind on the product.
- Never place anything on the product. (Placing liquids, naked flames, cloths, paper, etc. on the product may cause a fire.)
- Do not apply any strong shock to the LCD panel. (Do not hit any object against it or push it with a sharp-pointed tool.)
- Do not put heavy objects on the product.
- Do not step on or hang on the product.

U.S.A. only

FCC NOTICE (U.S.A. only)

CAUTION:

Changes or modifications not approved by JVC could void the user's authority to operate the equipment.

NOTE:

This equipment has been tested and found to comply with the limits for a Class B digital device, pursuant to Part 15 of the FCC Rules. These limits are designed to provide reasonable protection against harmful interference in a residential installation. This equipment generates, uses and can radiate radio frequency energy and, if not installed and used in accordance with the instructions, may cause harmful interference to radio communications. However, there is no guarantee that interference will not occur in a particular installation. If this equipment does cause harmful interference to radio or television reception, which can be determined by turning the equipment off and on, the user is encouraged to try to correct the interference by one or more of the following measures:

- Reorient or relocate the receiving antenna.
- Increase the separation between the equipment and receiver.
- Connect the equipment into an outlet on a circuit different from that to which the receiver is connected.
- Consult the dealer or an experienced radio/TV technician for help.

U.S.A. only**IMPORTANT RECYCLING INFORMATION**

This product has a fluorescent lamp that contains mercury. Disposal of these materials may be regulated in your community due to environmental considerations. For disposal or recycling information, please contact your local authorities or for USA, the Electronic Industries Alliance: <http://www.eiae.org>

IMPORTANT SAFETY INSTRUCTIONS

- 1) Read these instructions.
- 2) Keep these instructions.
- 3) Heed all warnings.
- 4) Follow all instructions.
- 5) Do not use this apparatus near water.
- 6) Clean only with dry cloth.
- 7) Do not block any ventilation openings. Install in accordance with the manufacturer's instructions.
- 8) Do not install near any heat sources such as radiators, heat registers, stoves, or other apparatus (including amplifiers) that produce heat.
- 9) Do not defeat the safety purpose of the polarized or grounding-type plug. A polarized plug has two blades with one wider than the other. A grounding type plug has two blades and a third grounding prong. The wide blade or the third prong are provided for your safety. If the provided plug does not fit into your outlet, consult an electrician for replacement of the obsolete outlet.
- 10) Protect the power cord from being walked on or pinched particularly at plugs, convenience receptacles, and the point where they exit from the apparatus.
- 11) Only use attachments/accessories specified by the manufacturer.
- 12) Use only with the cart, stand, tripod, bracket, or table specified by the manufacturer, or sold with the apparatus. When a cart is used, use caution when moving the cart/ apparatus combination to avoid injury from tip-over.
- 13) Unplug this apparatus during lightning storms or when unused for long periods of time.



- 14) Refer all servicing to qualified service personnel. Servicing is required when the apparatus has been damaged in any way, such as power-supply cord or plug is damaged, liquid has been spilled or objects have fallen into the apparatus, the apparatus has been exposed to rain or moisture, does not operate normally, or has been dropped.
- 15) Apparatus shall not be exposed to dripping or splashing and no objects filled with liquids, such as vases, shall be placed on the apparatus.
- 16) Batteries shall not be exposed to excessive heat such as sunshine, fire or the like.
- 17) When discarding batteries, environmental problems must be considered and the local rules or laws governing the disposal of these batteries must be followed strictly.
- 18) Avoid improper installation and never position the unit where good ventilation is impossible. When installing this monitor, distance recommendations must be maintained between the set and the wall, as well as inside a tightly enclosed area or piece of furniture. Keep to the minimum distance guidelines shown for safe operation.

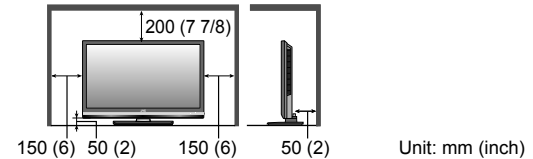

- 19) When this monitor is connected to the wall outlet, it is always on standby even when all the LED lamps are not lit. To shut down the monitor, unplug the monitor from the wall outlet.

European Union only

Dear Customer,

This apparatus is in conformance with the valid European directives and standards regarding electromagnetic compatibility and electrical safety.

European representative of Victor Company of Japan, Limited is:

JVC Technical Services Europe GmbH

Postfach 10 05 04

61145 Friedberg

Germany

Information for Users on Disposal of Old Equipment and Batteries



Products



Battery

Notice:

The sign Pb below the symbol for batteries indicates that this battery contains lead.

[European Union]

These symbols indicate that the electrical and electronic equipment and the battery with this symbol should not be disposed of as general household waste at its end-of-life. Instead, the products should be handed over to the applicable collection points for the recycling of electrical and electronic equipment as well as batteries for proper treatment, recovery and recycling in accordance with your national legislation and the Directive 2002/96/EC and 2006/66/EC.

By disposing of these products correctly, you will help to conserve natural resources and will help to prevent potential negative effects on the environment and human health which could otherwise be caused by inappropriate waste handling of these products.

For more information about collection points and recycling of these products, please contact your local municipal office, your household waste disposal service or the shop where you purchased the product.

Penalties may be applicable for incorrect disposal of this waste, in accordance with national legislation.

[Business users]

If you wish to dispose of this product, please visit our web page <http://www.jvc-eu/> to obtain information about the take-back of the product.

[Other Countries outside the European Union]

These symbols are only valid in the European Union.

If you wish to dispose of these items, please do so in accordance with applicable national legislation or other rules in your country for the treatment of old electrical and electronic equipment and batteries.

Maintenance

Unplug this product from the wall outlet before cleaning.

Screen

To avoid irreparable change in appearance of the screen such as uneven color, discoloration, scratches, be careful about the following:

- Do not paste or stick anything using any glues or adhesive tapes.
- Do not write anything on the screen.
- Do not strike the screen with a hard object.
- Avoid condensation on the screen.
- Do not wipe the screen with any liquid such as water. In addition, wiping the screen with water-diluted neutral detergent or solvent such as alcohol, thinner, or benzene may affect the anti-reflection treatment of the screen.
- Do not wipe the screen forcefully.

If the screen gets stained, wipe it with a soft dry cloth.

Cabinet

To avoid the deterioration or damages of the cabinet such as its paint's peeling away, be careful about the following:

- Do not wipe the cabinet using solvent such as alcohol, thinner, or benzene.
- Do not expose the cabinet to any volatile substance such as insecticides.
- Do not allow any rubber or plastic in contact for a long time.
- Do not wipe the cabinet forcefully.

Wipe stains off the cabinet with a soft cloth. If the cabinet gets heavily stained, wipe it with a soft cloth soaked in water-diluted neutral detergent and wrung well, then wipe with a soft dry cloth.

See "Handling the glossy finish of the monitor" (P. 8) on how to handle the glossy finish.

Ventilation openings

Use a vacuum cleaner to get rid of the dust around the intakes (all the openings). If a vacuum cleaner is not available, use a cloth and wipe it off. Leaving the dust around the intakes may prevent proper temperature control and cause damage to the product.

Glasses

If the glasses get stained, wipe it with a soft dry cloth.

Remote control

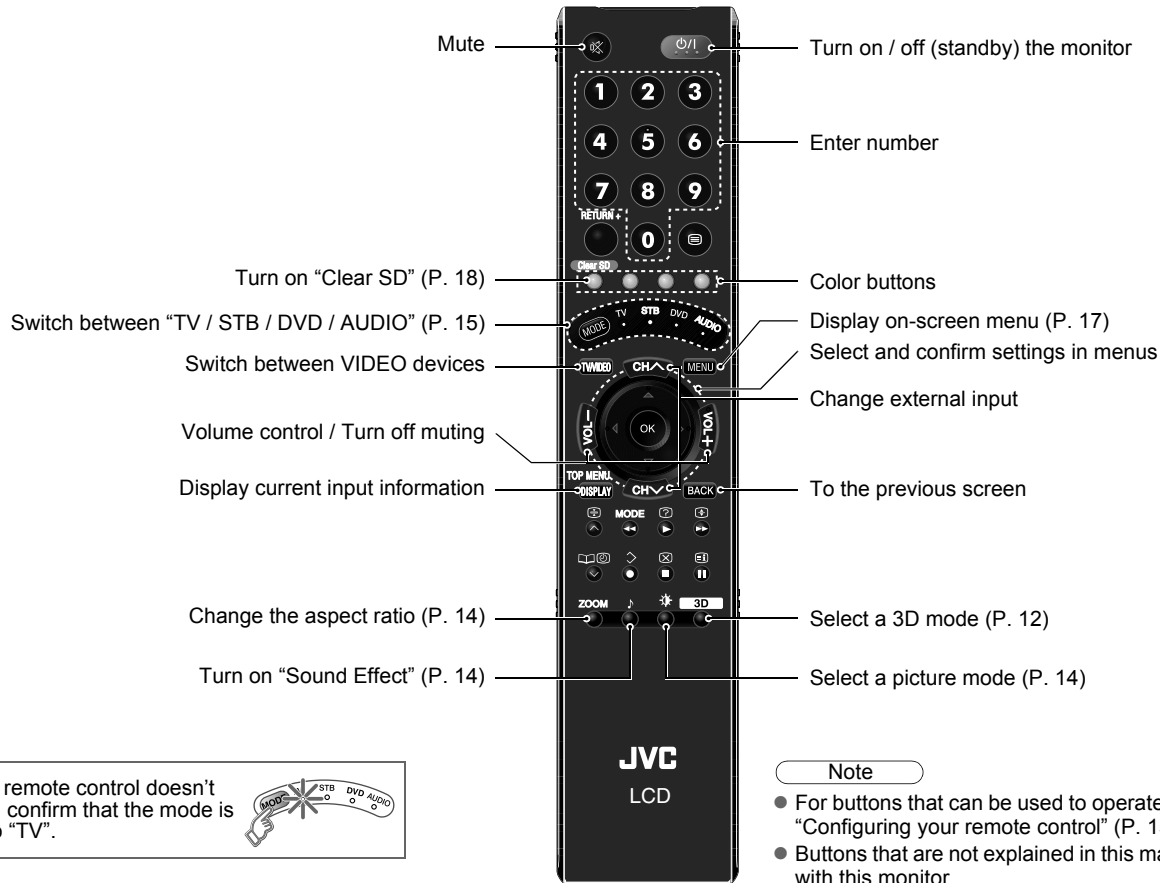

- If the remote control doesn't work, confirm that the mode is set to "TV".

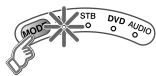

Names and functions of parts

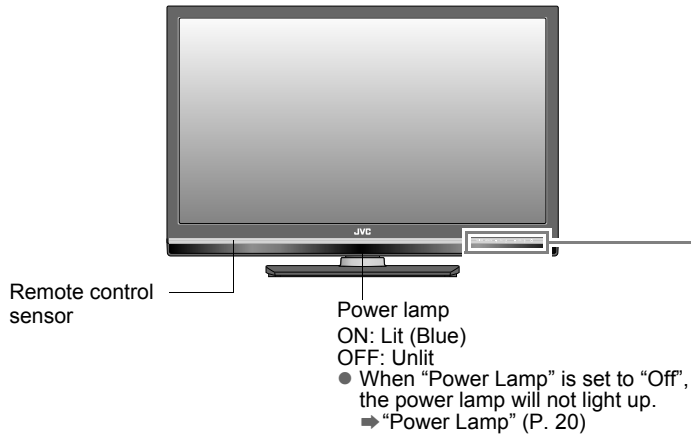

Note

Peel off the protection films pasted on the glossy finish of the monitor after the monitor has been placed properly. (P. 8)

Change the direction of monitor

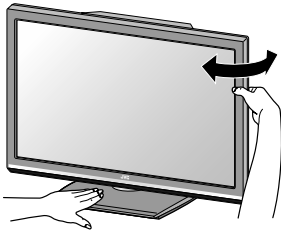

Touch sensor panel operation

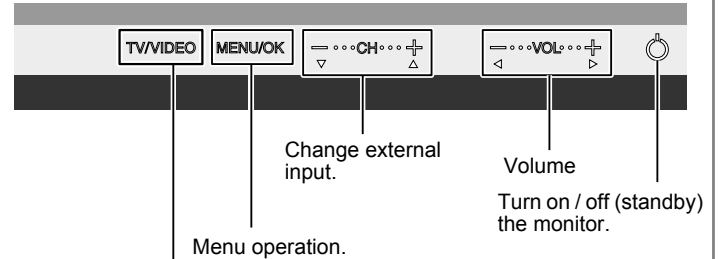

Switch to an external input. (P. 13)

- Touching **TV/VIDEO** and **MENU/OK** simultaneously switches the monitor to 3D mode.
- Touch on the function name to operate the function

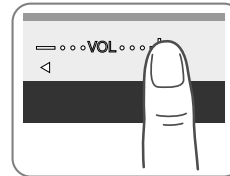

- You will hear a beep if you have touched the button correctly.

- Operate the menus

MENU/OK Use as "MENU" button or "OK" button.

=...CH...+> Use as "▼" and "▲" buttons.

<...VOL...+> Use as "◀" and "▶" buttons.

- For details on menu operations, refer to "Customising your monitor" (P. 17).

Attach the stand to the monitor

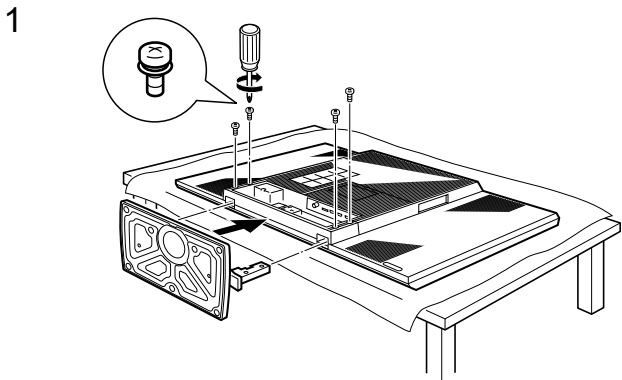

To prevent scratches on the panel, lay a piece of soft cloth on an even platform and place the monitor onto it.

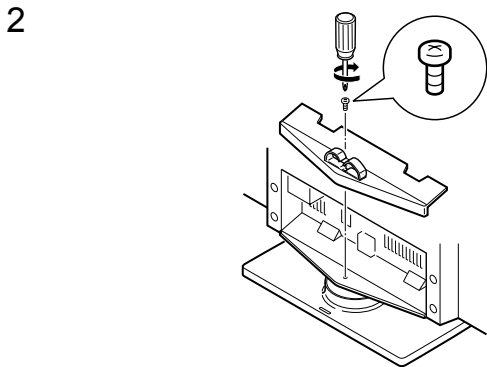

Note

- When the stand is not used:
Seal up the two holes at the bottom of the TV using the plates provided. Peel off the protection films on the plates. Then peel the plates from the paper and stick them on the holes.

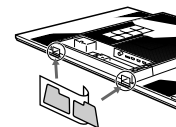

Handling the glossy finish of the monitor

Be careful when handling the glossy finish of the monitor

The glossy finish of the monitor scratches easily.

- Protection films have been pasted onto the glossy finish of the monitor to prevent scratches. Peel off the films after the monitor has been placed properly.
- If the glossy finish gets dirty, clear the dust off the glossy finish first. Then wipe softly with the cleaning cloth provided. If you do not clear the dust first, or you wipe the glossy finish too hard, or a cleaning cloth other than the one provided is used, the glossy finish may be scratched.

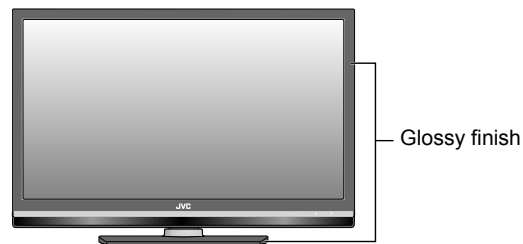

Getting started

Please read P. 10 of this manual to set up your monitor.

Check accessories



Remote control



Cleaning cloth
(For details on using the cleaning cloth, see P. 8.)



Circular polarizing glasses
(x2)
(For viewing 3D images)



"AAA/R03" Batteries
(For confirming the monitor works)

WARNING:

Batteries shall not be exposed to excessive heat such as direct sunshine, fire or the like.

- Stand, stand cover, screws and plates are also included. For details, refer to page 8.

Install your monitor

Follow the instructions on page 8 to attach the stand provided to the monitor.

- Place the monitor on a flat and stable location.
- Power requirements
 - Connect the power cord only to a 100 - 240 V, 50/60 Hz AC outlet.
- Installation requirements
 - To prevent the monitor from falling, thread the belt through the hole on the back of the stand and secure it to the rack, etc.

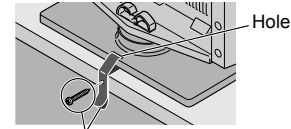

Belt and screw (not provided)

Insert the batteries

Use two "AAA/R03" dry cell batteries. Insert the batteries from the \ominus end, making sure the \oplus and \ominus polarities are correct.

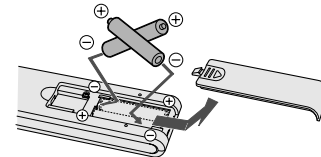

Connecting your external devices

Make sure all the devices and the monitor are turned off.
You can connect many different devices to the rear panel of the monitor.
Please read the user manuals of each device before setting up.
(Connecting cables are not supplied with this monitor.)

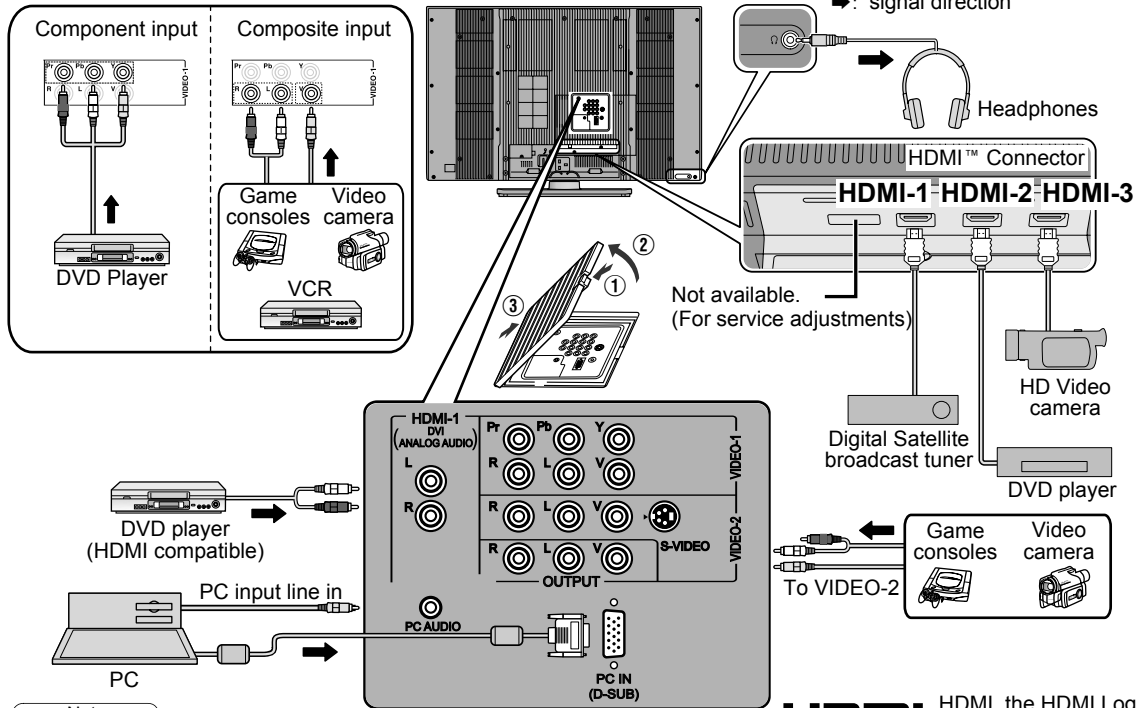

Note

- To reduce noise, use a VGA cable with core filters.

VIDEO-1 Watching videos

Output ↑	Input ↓
/	
	<ul style="list-style-type: none"> • Composite signal / Component signal (P. 27) • Sound L / R

- Use component signal
⇒ "VIDEO Setting" (P. 21)

VIDEO-2 Watching videos

Output ↑	Input ↓
/	
	<ul style="list-style-type: none"> • Composite signal / S-VIDEO • Sound L / R

- If both composite and S-VIDEO cables are connected, S-VIDEO input takes priority over composite inputs.

HDMI-1 HDMI-2 HDMI-3

Connecting HDMI devices

Output ↑	Input ↓
/	
	<ul style="list-style-type: none"> • HDMI signal (P. 27)

- "HDMI-1 Audio Setting" ⇒ (P. 21)
- HDMI-2 and HDMI-3 inputs do not support analog sound.

OUTPUT

Video and sound signals of a monitor channel you are viewing output from these terminals

Output ↑
<ul style="list-style-type: none"> • Composite signal • Sound L / R

- DVI devices
⇒ "Connect DVI devices" (P. 25)

HDMI HDMI, the HDMI Logo and High-Definition Multimedia Interface are trademarks or registered trademarks of HDMI Licensing LLC.

IMPORTANT! PREPARE USE SETTING! TROUBLE?

Viewing 3D images

This product is a 3D LCD Monitor which adopts the Xpol®¹ circular polarizing method. You can enjoy 3D stereoscopic content by using the supplied circular polarizing glasses.

¹: Xpol® is a registered trademark of Arisawa Manufacturing Co., Ltd.

Basic 3D principle

By having a filter of different polarization on every alternate scan line on the monitor, and projecting the left eye image (left circular polarization) and the right eye image (right circular polarization) through the filters, users can enjoy a realistic three dimensional view by viewing the left and right images simultaneously through the circular polarizing glasses.

As the left and right images are always displayed together on the screen, users can view flicker-free 3D images.

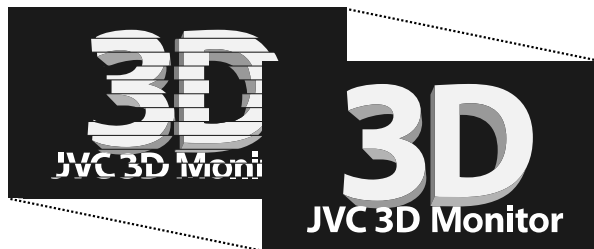

When viewing in 3D

- To view in 3D, input the 3D images and press the “3D” button to change to a suitable mode before putting on the circular polarizing glasses to view the 3D images.
- Every individual will have a different experience when viewing 3D images. Viewing at a close distance may cause disorders and discomfort; it is recommended to view at a distance of about 2 m (6 feet) from the front of the screen.
- The 3D effects may differ when viewing the screen from different angles.
- Stop using the product and rest immediately if you experience eyestrain, dizziness, vomiting, headaches or any other discomforts. Take periodic breaks and rest even if you do not experience any discomfort.
- If the symptoms persist even after resting, please consult a doctor.
- For users with past experiences of PSS (Photo Sensitive Seizure) or users with heart problems, please consult a doctor before using this monitor.
- For infants still in the visual development stage, please consult a doctor and have an adult guardian accompany the child.

Cautions on using the circular polarizing glasses

- Use the circular polarizing glasses only when viewing 3D images.
- Use only the circular polarizing glasses provided.
- For users who wear spectacles, cover the spectacles with the circular polarizing glasses.
- Do not use the circular polarizing glasses as sunglasses.
- Please consult a doctor if allergies appear on the areas that come into contact with the circular polarizing glasses.

Note

- For purchase of additional circular polarizing glasses, please contact the dealer where you purchased your monitor.

To view 3D images

This monitor supports LINE BY LINE and SIDE BY SIDE 3D signals. To view 3D images, input a compatible 3D signal to enjoy the 3D effects.

You can activate the 3D mode using the following method.

Touch **TV/VIDEO** and **MENU/OK** on the touch sensor panel (P. 7) simultaneously.

OR

Press the "3D" button on remote control. (P. 6)

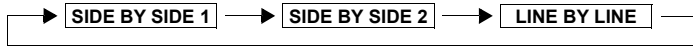

LINE BY LINE

For line-by-line 3D input and normal 2D input.



Input signal

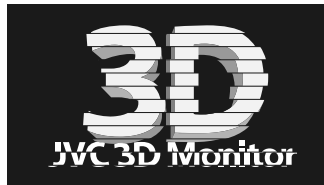

Monitor screen

SIDE BY SIDE 1

For horizontally compressed side-by-side 3D input.



Left screen Right screen
Input signal



Monitor screen

SIDE BY SIDE 2

For non-compressed side-by-side 3D input



Left screen Right screen
Input signal

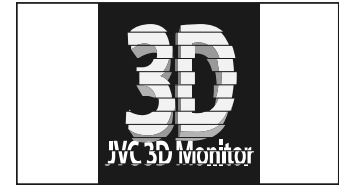

Monitor screen

Note

- 2D to 3D image conversion function is not available.
- When using SIDE BY SIDE to view 3D images, screen displays such as menu screen will appear either on the left or right side of the screen. If you cannot see the screen clearly, remove your circular polarizing glasses.
- Set the 3D/ZOOM mode to the following setting when viewing in 3D.

Input	Format	3D Mode	Zoom Mode (P. 14)
HDMI	1080p	LINE BY LINE, SIDE BY SIDE 1/2	Full Native
HDMI, Component	1080i	SIDE BY SIDE 1/2	Full Native

- If double vision occurs when viewing in 3D using the component inputs, set the following items.
"Sharpness": Minimum (P. 17)
"Clear SD", "Digital VNR", "DigiPure", "MPEG Noise Reduction": "Off" (P. 18)

Watching videos / DVDs



1 Select the video source

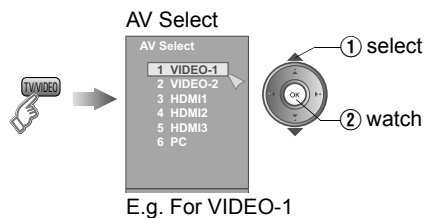

2 Operate the connected device and play a video

■ To operate using the monitor's touch sensor panel

- 1 Touch **TV/VIDEO**
- 2 Touch **↓** and **↑** to select
- 3 Touch **MENU/OK**

Useful functions



ZOOM Zoom

Change the aspect ratio



2 Select the aspect ratio

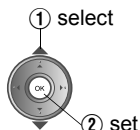
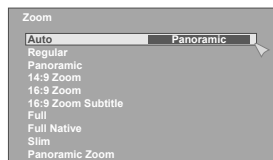

3



Move the picture with ▲ or ▼ while this bar is displayed

- When “Slim” is selected, a 4:3 image stretched out to 16:9 will revert back to its original aspect ratio with black bands.
- When “Panoramic Zoom” is selected, a 4:3 image with black bands will be stretched out to 16:9.
- “Full Native” ➔ “What is “Full Native?”” (P. 25)
- Using “Auto” ➔ “Auto in “Zoom”” (P. 25)

Note

- Depending on the signal formats, some zoom modes will be displayed in black and will not be selectable.
- If an image is displayed in an aspect ratio that differs from its original aspect ratio, the image will be distorted or portions of the image will be cut off.

Sound Effect

Enjoy the sound setting that you like

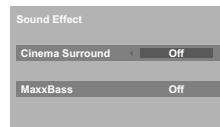

Cinema Surround (P. 19)

Enjoy ambient sound.

- “Cinema Surround” does not work with headphones.

MaxxBass (P. 19)

Compensates low frequencies to widen the frequency band.

- “MaxxBass” does not work with headphones.



Picture Mode (P. 17)

You can select a preset picture setting according to the brightness of your room or when playing video games.

Configuring your remote control



You can configure your monitor's remote control to operate your other devices.

Configure your remote control.

- 1 Turn on the device manually.
- 2 Switch the remote control mode to a mode that matches your device. Refer to the table below to select an appropriate mode.

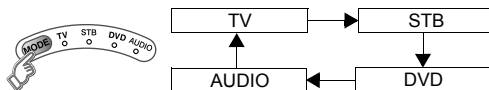

- The indicator lights for 3 seconds each time the remote control is operated.

- 3 Find the remote control code for your JVC device from the table below.

MODE	Applicable devices	Remote control codes
TV	This monitor only	
STB	Not in use	
DVD	DVD	0503, 0539, 0623, 1241, 1550, 1602, 1701, 1860, 1863, 1940
	DVD/DVD-R	1164, 1275, 1597
	Home Theater in Box	0623, 1701, 1860, 1863, 1940
AUDIO	Receiver/Home Theater in Box	0074, 1374, 1676, 2000, 2001

- 4 Set the remote control code.



Press and hold

Enter four digit number

Release the button

- 5 Point the remote control at your device, press and confirm that your device is turned off. If your device does not respond, try entering another available code.

Note

- If none of the code works, refer to "Using the search code function" (P. 16).

Customising your monitor



Note

- Depending on the situation (video signal formats, external inputs, etc.), some items will be displayed in black color and will not work. You will not be able to change their setting as well.

1 Display the menu bar



2 Display the desired menu

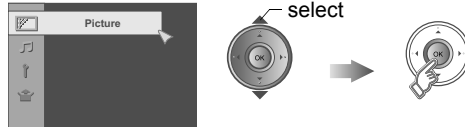

3 Change or adjust the setting

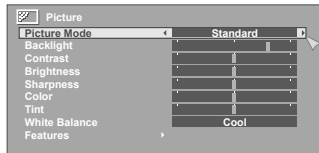

- The menu disappears after one minute of inactivity.
- To the previous screen
➔ **BACK**

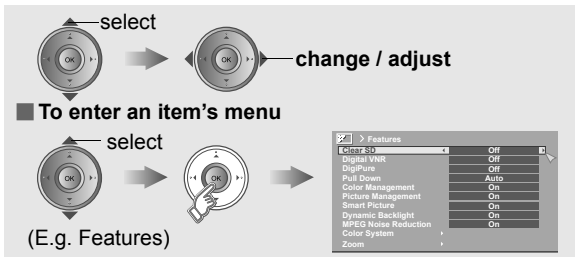

4 Close the menu



Picture

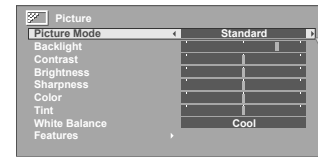

Note

- "Sharpness" is not available during HDMI input.

Picture Mode

You can select a preset picture setting according to the brightness of your room or when playing video games.

- Bright** : in a fairly bright room
- Soft** : in a dark room
- Standard** : in a room with standard brightness
- Game Mode** : when playing video games

■ You can make further adjustments to the selected preset "Picture Mode" to your liking.

Backlight	Backlight brightness (Darker ⇔ Brighter)
Contrast	Contrast (Lower ⇔ Higher)
Brightness	Brightness (Darker ⇔ Brighter)
Sharpness	Sharpness (Softer ⇔ Sharper)
Color	Color (Lighter ⇔ Deeper)
Tint	Tint (Reddish ⇔ Greenish) (NTSC only)
White Balance	Color temperature (Warm / Mid / Cool)

■ To return to the default adjustments ➔ (blue)

Features

➔ "Features (sub menu)" (P. 18)

Features (sub menu)

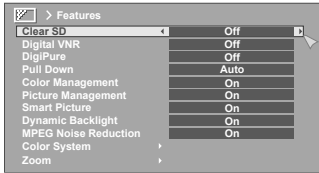

Note

- “Clear SD”, “Digital VNR”, “DigiPure” and “MPEG Noise Reduction” are not available during HDMI input.
- “Smart Picture” is not available when “Picture Mode” is set to “Bright” (P. 17).
- “Clear SD”, “Digital VNR”, “DigiPure”, “Pull Down”, “MPEG Noise Reduction” and “Color System” are not available when “AV Select” is set to “PC”. (P. 13)

Clear SD

For clearer picture (Off / Mode-1 / Mode-2)

- When “Mode-1” or “Mode-2” is selected, “Digital VNR”, “DigiPure”, “MPEG Noise Reduction” and “Picture Management” settings are not available.

Digital VNR

Reduce noise

On : Maintain constant effect **Off** : Function is turned off level

DigiPure

For natural-looking outlines

On : When the picture loses sharpness **Off** : Function is turned off

Pull Down

For smooth cinema film

On : Function is always on **Off** : Function is turned off
Auto : Turn on / off the function automatically

Color Management

Maintain a natural color balance (On / Off)

Picture Management

Make it easier to view bright / dark pictures (On / Off)

Smart Picture

Make it easier to view white areas (On / Off)

Dynamic Backlight

Reduce the brightness of the backlight when the screen is dark (On / Off)

MPEG Noise Reduction

Reduce MPEG video noise (On / Off)

Color System

When there is no color, change the color system (PAL / SECAM / NTSC3.58 / NTSC4.43 / Auto)

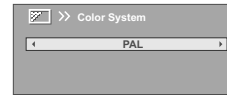

- Select “Auto” when watching videos etc.

Zoom

Select a default aspect ratio for Auto in “Zoom” (P. 14)

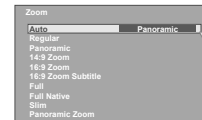

Panoramic

Regular

14:9 Zoom

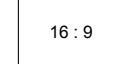

Sound

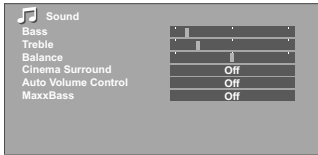

Bass Low tones (Weaker ⇔ Stronger)

Treble High tones (Weaker ⇔ Stronger)

Balance Speaker balance (Left stronger ⇔ Right stronger)

Cinema Surround Ambient sound (High / Low / Mono / Off)

- "Cinema Surround" does not work with headphones.

Auto Volume Control Turns down the volume automatically when an excessive sound signal is input. (On / Off)

- "Auto Volume Control" does not work with headphones.

MaxxBass Compensates low frequencies to widen the frequency band (Low / High / Off)

- "MaxxBass" does not work with headphones.

MaxxBass is a registered trademark of Waves Audio Ltd. in the USA, Japan and other countries.

Features

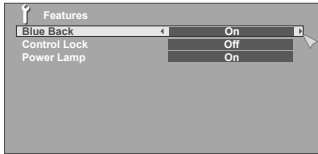

Blue Back

Displays a blue screen and mutes the sound when the signal is weak or absent (On / Off)

- "Blue Back" does not function when the 3D mode is set to "SIDE BY SIDE 2". (P. 12)

Control Lock

Disable the front control buttons on the monitor. (On / Off)

Power Lamp

Lights the power lamp (P. 7) while the monitor is on (On / Off)

Set Up

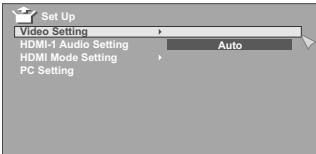

Note

- "PC Setting" is only available when "AV Select" is set to "PC". (P. 13)

VIDEO Setting

⇒ "Setting video terminals" (P. 22)

HDMI-1 Audio Setting

Set to "Digital" or "Auto" for HDMI devices, or "Analog" or "Auto" for DVI devices. (Not available for HDMI-2 and HDMI-3.)

HDMI Mode Setting

For setting the HDMI input
If there is no picture displayed on the screen, set "Mode" to "1" or "2".

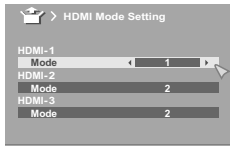

PC Setting

For setting the PC input

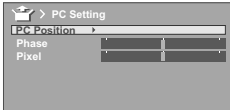

PC Position:

Adjust screen position

Phase:

Sets the focus of the screen.

Pixel:

Adjusts the horizontal feature of the screen.

Adjust the position of the PC image

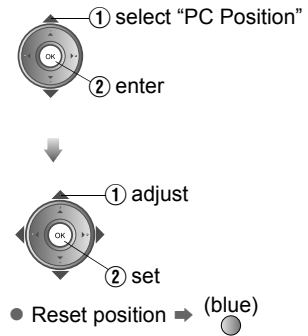
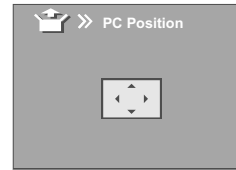

Setting video terminals

1 Display the "VIDEO Setting" menu

Display the menu bar



Select "Set Up"

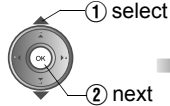

Select "VIDEO Setting"

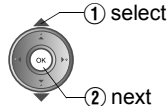

2 Select an input, and then proceed with setting

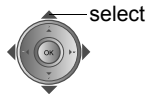

Edit names of connected devices (ID LIST)

① Show the name list

(blue)



② Select a name from the list

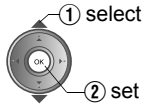

■ Clear the name ➔ Select the blank space in the list

Switch between component and composite input (ⓄⓄⓄ Pr/Pb/Y, Ⓞ V)

① Select "VIDEO-1"

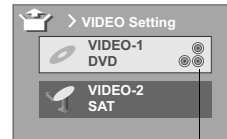

Ⓞ V

② Set to component input

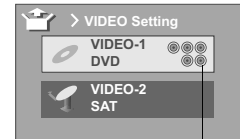

ⓄⓄⓄ Pr/Pb/Y

■ Return to composite input ➔ Press "Ⓞ" (yellow) in ② again.



	Problem	Actions
Basics	Remote control stops working	<ul style="list-style-type: none"> ● Unplug monitor, several minutes later plug it in again.
	Aspect ratio changes unintentionally	<ul style="list-style-type: none"> ● Press "ZOOM" to return to your settings. (P. 14)
Screen	PC screen alignment is off	<ul style="list-style-type: none"> ● Adjust "PC Setting". (P. 21)
	Black or white dots appear on the screen	<ul style="list-style-type: none"> ● LCD panels use fine dots ("pixels") to display images. While more than 99.99% of these pixels function properly, a very small number of pixels may not light, or may light all the time. Please understand that this is not a malfunction.
Picture	Poor picture quality	<ul style="list-style-type: none"> ● Change the "Picture Mode" setting. (P. 17) ● Unnatural color >>> Adjust "Color" and "Backlight". (P. 17) Check your "Color System". (P. 18) ● Noise >>> Set to the following functions. Picture Mode: Standard (P. 17) Digital VNR: On (P. 18) DigiPure: Off (P. 18) ● Dull picture >>> Set to the following functions. Picture Mode: Bright (P. 17) Digital VNR: Off (P. 18) DigiPure: On (P. 18)

	Problem	Actions
Picture	Strange picture when using an external device	<ul style="list-style-type: none"> ● If the top of the image is distorted, check the video signal quality itself. ● If movement appears unnatural when receiving a signal from a DVD player etc., with 576p, change the output setting of the external device to 576i.
	Poor sound	<ul style="list-style-type: none"> ● Adjust "Bass" and "Treble". (P. 19)
Sound	No sound from the audio component	<ul style="list-style-type: none"> ● Audio signals received from HDMI-1, HDMI-2 and HDMI-3 cannot be sent to the OUTPUT terminal.
	Some functions do not work	<ul style="list-style-type: none"> ● It is not a malfunction. Depending on the situation, some function items will be displayed in black color and will not work. (P. 17)
HDMI	Wrong screen size	<ul style="list-style-type: none"> ● Read the user manual of the connected device and perform the following: <ul style="list-style-type: none"> ➔ Check if the output setting of the device is correct. ➔ Change the signal format of the device to other format.
	No picture, no sound	<ul style="list-style-type: none"> ● Use the cable marked with HDMI logo. HDMI
	Picture noise or no picture	<ul style="list-style-type: none"> ● Set "HDMI Mode Setting" to "1" or "2". (P. 21)

	Problem	Actions
HDMI	No sound	<ul style="list-style-type: none"> ● Check if the device is compliant with HDMI. ● Set "HDMI-1 Audio Setting" to "Digital" or "Auto" for HDMI devices, or "Analog" or "Auto" for DVI devices. (Not available for HDMI-2 and HDMI-3.) (P. 21)
	Green and distorted screen	<ul style="list-style-type: none"> ● Wait a little for the signal to stabilize when switching the signal format for an HDMI device.
3D	Images do not appear as 3D or double vision	<ul style="list-style-type: none"> ● Set to the 3D mode or ZOOM mode. (P. 12) ● If the images are not displayed properly even after switching the 3D/ZOOM mode, the 3D signal may not be supported.

Technical information

PC signals that can be displayed

- If the signal doesn't appear, check that the vertical frequency on the PC is set to "60Hz".

Resolution	640 x 480 (VGA)	1024 x 768 (XGA)
Vertical frequency (Hz)	60.0	60.0

Connect DVI devices

Connect a DVI device to HDMI-1 using DVI-HDMI conversion cable. Connect analog sound output of the DVI device to L and R terminals in HDMI-1 (DVI ANALOG AUDIO).

- Set "HDMI-1 Audio Setting" to "Analog" or "Auto" ➔ (P. 21)
- HDMI-2 and HDMI-3 inputs do not support analog sound (HDMI-1 (DVI ANALOG AUDIO)).

Auto in "Zoom"

When "Auto" is selected in Zoom, the aspect ratio will turn to the ratio obtained from the information the monitor received.

- The aspect ratio will turn to the ratio obtained from WSS (Wide Screen Identification Signal), video signal, or control signal of the external devices. Without receiving the aspect information, it will be the setting in "Zoom". (P. 18)

What is "Full Native"?

- With the full HD LCD display and "Full Native", you can enjoy full native HD resolution of 1920 x 1080. It exposes flaws in the video that were hidden when viewing on "Full".

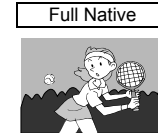
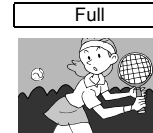

- * The illustrations are emphasised to make clear differences between "Full" and "Full Native".
- Dark bar or noise may appear at the edges of the screen when viewing in "Full Native" for some videos. This is resulted from the signal itself, not due to monitor malfunction.

Specifications

Main unit	
Model	GD-463D10U / GD-463D10E
Power requirements	AC 100 V - 240 V, 50 Hz / 60 Hz
Audio output (Rated power output)	10 W + 10 W
Speakers	(4.5 cm x 13 cm) x 2
Power consumption [standby]	210 W [0.5 W]
Screen size (visible area size measured diagonally)	116.8 cm
Headphone jack	Stereo mini jack (3.5 mm in diameter) x 1
Operating conditions	Temperature: 0°C – 40°C (32°F – 104°F) Relative humidity: 20% – 80% (non-condensation) (Slightly variable depending on ambient conditions for installation.)
Dimensions (W x H x D) [without stand]	1071 mm (42 1/4") x 725 mm (28 5/8") x 275 mm (10 7/8") [1071 mm (42 1/4") x 680 mm (26 7/8") x 74.5 mm (3")]
Weights [without stand]	26.9 kg (59.18 lbs) [22.9 kg (50.38 lbs)]
Accessories	(See "Check accessories", P. 9)
Color systems	PAL, SECAM, NTSC 3.58/4.43 MHz
Aspect ratio	16:9 (Wide format)
LCD panel type	46 inch wide, active matrix TFT
Effective screen size (W x H)	1018 mm (41") x 573 mm (23")
Number of pixels displayed (panel)	1920 (H) x 1080 (V)
Number of colors displayed	16.7 million
Contrast ratio (typ.)	2000:1

Terminals / Connectors				
Terminal name		Terminal type	Signal type (IN)	Signal type (OUT)
Input terminals	VIDEO-1	RCA connectors x 6	Composite video, Analog component 480/60i, 576/50i, 480/60p, 576/50p, 720/60p, 720/50p, 1080/60i, 1080/50i Audio L / R	
	VIDEO-2	RCA connectors x 3 S-VIDEO connector x 1	Composite video, S-Video, Audio L / R	
	HDMI-1	HDMI connector x 1	HDMI 480/60i, 576/50i, 480/60p, 576/50p, 720/60p, 720/50p, 1080/60i, 1080/50i, 1080/60p, 1080/50p, 1080/24p	
	HDMI-2			
	HDMI-3			
	HDMI-1 (DVI ANALOG AUDIO)	RCA connectors x 2	Audio L / R	
	PC INPUT	D-SUB (15 pins) x 1	Analog PC signal VGA/60, XGA/60	
PC AUDIO	Stereo mini-jack x 1 (3.5 mm in diameter)	Audio L / R		
Output terminals	OUTPUT	RCA connectors x 3		Composite video, Audio L / R
	Headphone	Stereo mini-jack x 1 (3.5 mm in diameter)		Headphone output

- We may change the design and specifications without notice.

Dimensions Unit: mm (inch)

<Front view>

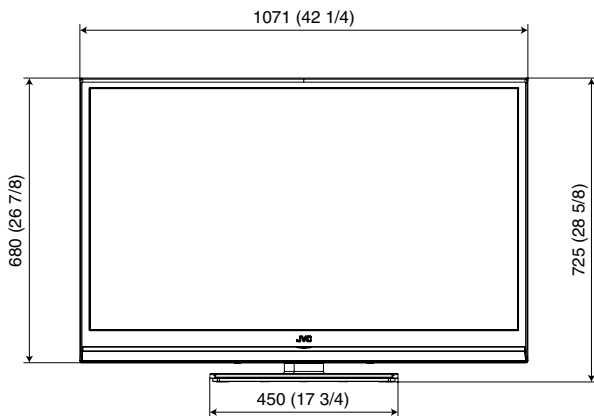

<Side view>

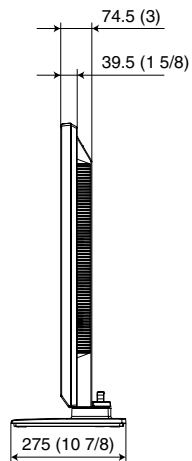

<Rear view>

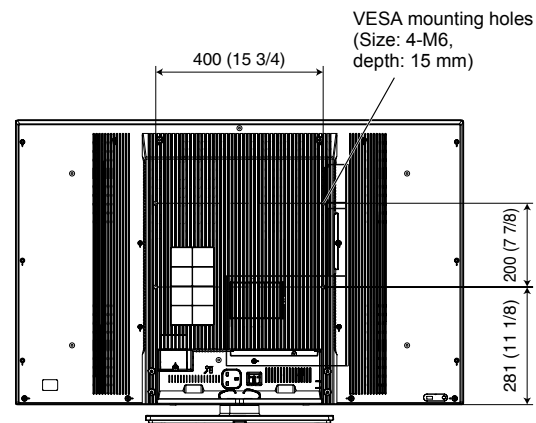

Note

- The adjustable angle of the monitor screen from side to side is 20 degrees.

JVC

Free Manuals Download Website

<http://myh66.com>

<http://usermanuals.us>

<http://www.somanuals.com>

<http://www.4manuals.cc>

<http://www.manual-lib.com>

<http://www.404manual.com>

<http://www.luxmanual.com>

<http://aubethermostatmanual.com>

Golf course search by state

<http://golfingnear.com>

Email search by domain

<http://emailbydomain.com>

Auto manuals search

<http://auto.somanuals.com>

TV manuals search

<http://tv.somanuals.com>