



JVC

 CAUTION RISK OF ELECTRICAL SHOCK DO NOT OPEN 	<p>The lightning flash with arrowhead symbol, within an equilateral triangle is intended to alert the user to the presence of uninsulated "dangerous voltage" within the product's enclosure that may be of sufficient magnitude to constitute a risk of electric shock to persons.</p> <p>The exclamation point within an equilateral triangle is intended to alert the user to the presence of important operating and maintenance (servicing) instructions in the literature accompanying the appliance.</p>
<p>CAUTION: To reduce the risk of electric shock. Do not remove cover (or back). No user serviceable parts inside. Refer servicing to qualified service personnel.</p>	

DT-R24L41D

DT-R17L4D

MULTI FORMAT LCD MONITOR

INSTRUCTIONS



The illustration of the monitor is of DT-R24L41D.

For Customer Use:
Enter below the Serial No. which is located on the rear of the cabinet. Retain this information for future reference.

Model No. : **DT-R24L41D / DT-R17L4D**
Serial No. :

LCT2646-002A-H

Table of Contents

Safety Precautions	3
IMPORTANT SAFEGUARDS	3
Operating Precautions	5
Caution for use of the product for many hours.....	5
Caution for use of the product in the high temperature	5
Maintenance	5
Installation	6
Connections	8
Rear panel	8
Daily Operations	10
Front panel.....	10
Menu Configuration	12
The operation procedure.....	12
Menu Transition Diagram.....	12
MAIN MENU	13
SET-UP MENU	15
External Control	18
About the external control	18
Using the MAKE/TRIGGER system.....	18
Using the serial communication	20
Troubleshooting	22
Self-check program.....	23
Specifications	24
General	24
LCD panel	24
Input/output terminals	24
Dimensions	25
Available signals	26

Safety Precautions

WARNING: TO REDUCE RISK OF FIRE OR ELECTRIC SHOCK, DO NOT EXPOSE THIS APPARATUS TO RAIN OR MOISTURE. NO OBJECTS FILLED WITH LIQUIDS, SUCH AS VASES, SHALL BE PLACED ON THE APPARATUS.

IMPORTANT SAFEGUARDS

Electrical energy can perform many useful functions. This unit has been engineered and manufactured to assure your personal safety. But **IMPROPER USE CAN RESULT IN POTENTIAL ELECTRIC SHOCK OR FIRE**. In order not to defeat the safeguards incorporated into this product, observe the following basic rules for its installation, use, and service. Please read these "IMPORTANT SAFEGUARDS" carefully before use.

- All the safety and operating instructions should be read before the product is operated.
- The safety and operating instructions should be retained for future reference.
- All warnings on the product and in the operating instructions should be adhered to.
- All operating instructions should be followed.

POWER CONNECTION

The power supply voltage rating of this product is AC 120 V. The power cord attached conforms to the following power supply voltage and countries. Use only the power cord designated to ensure safety and EMC regulations of each country.

- Not all types of power cords are supplied to this product.

For U.S.A. and Canada:
AC 120 V



This plug will fit only into a grounded power outlet. If you are unable to insert the plug into the outlet, contact your electrician to install the proper outlet. Do not defeat the safety purpose of the grounded plug.

- This product should be operated only with the type of power source indicated on the label. If you are not sure of the type of power supply of your home, consult your product dealer or local electric power company.

Warning: This is a class A product. In a domestic environment this product may cause radio interference in which case the user may be required to take adequate measures.

- Before connecting other products such as VCR's and personal computers, you should turn off the power of this product for protection against electric shock.
- Do not use attachments not recommended by the manufacturer as they may be hazardous.
- **When replacement parts are required**, be sure the service technician has used replacement parts specified by the manufacturer or equivalents. Unauthorized substitutions may result in fire, electric shock, or other hazards.
- **Upon completion of any service or repairs to this product**, ask the service technician to perform safety checks to determine that the product is in proper operating condition.

Under the following conditions,

1. Turn off the power.
2. Unplug this product from the wall outlet.
3. Refer service to qualified service personnel.
 - a) When the product emits smoke or unusual smell.
 - b) When the product exhibits a distinct change in performance—for example, no picture or no sound.
 - c) If liquid has been spilled, or objects have fallen on the product.
 - d) If the product has been exposed to rain or water.
 - e) If the product has been dropped or damaged in any way.
 - f) When the power supply cord or plug is damaged.

- Do not install this product in the following places:
 - in a damp or dusty room
 - where the product is exposed to soot or steam, such as near the cooking counter or a humidifier
 - near heat sources
 - where condensation easily occurs, such as near the window
 - in a location exposed to direct sunlight or strong light
- Do not place this product on an unstable cart, stand, or table. The product may fall, causing serious injury to a child or adult, and serious damage to the product. The product should be mounted according to the manufacturer's instructions, and should use a mount recommended by the manufacturer.
- Do not use this product near water.
- Be sure to install the product in the place where proper temperature and humidity are kept (see "Operating conditions" on page 24). This product becomes hot during its use. Take enough care when handling the product.

Do not attempt to service this product yourself, as opening or removing covers may expose you to dangerous voltages and other hazards. Refer all service to qualified service personnel.

Do not use the product for a long time if the sound is distorted.

Use only the power source specified on the unit.

- AC power: 120 V, 50 Hz/60 Hz

- The AC power supply is controlled by turning on/off the POWER switch on the rear panel. If the product is installed in a place where you cannot easily turn on/off the POWER switch, control the AC power supply by plugging/unplugging the power cord into/from the AC outlet. In this case, install the product as close to the AC outlet as possible, and leave enough space for plugging/unplugging the power cord. If the product is installed in a place where you cannot easily plug/unplug the power cord, equip an easily accessible device to the wiring of the building for turning on/off the power.
- When the product is left unattended and unused for a long period of time, unplug it from the wall outlet and disconnect the cable system.
- Do not overload wall outlets, extension cords, or convenience receptacles on other equipment as this can result in a risk of fire or electric shock.
- Use only the accessory cord designed for this product to prevent shock.

Safety Precautions (cont.)

- Slots and openings in the cabinet are provided for ventilation. These ensure reliable operation of the product and protect it from overheating. These openings must not be blocked or covered.
- Never push objects of any kind into this product through openings as they may touch dangerous voltage points or short-circuit the parts, which could result in a fire or electric shock.
- Never spill liquid of any kind on the product.
- Never place anything on the product. (Placing liquids, naked flames, cloths, paper, etc. on the product may cause a fire.)
- Do not apply any strong shock to the LCD panel. (Do not hit any object against it or push it with a sharp-pointed tool.)
- Do not put heavy objects on the product.
- Do not step on or hang on the product.

To prevent an accidental fall

Fix the monitor to a wall by using strings.

Fixing the monitor

Attach the hook (not provided) to the VESA mounting holes on the rear panel (use the two holes on the upper side) using M4 x 10 mm screws (not provided). Bind the hooks on the rear panel of the monitor to a wall or a pillar using durable string.

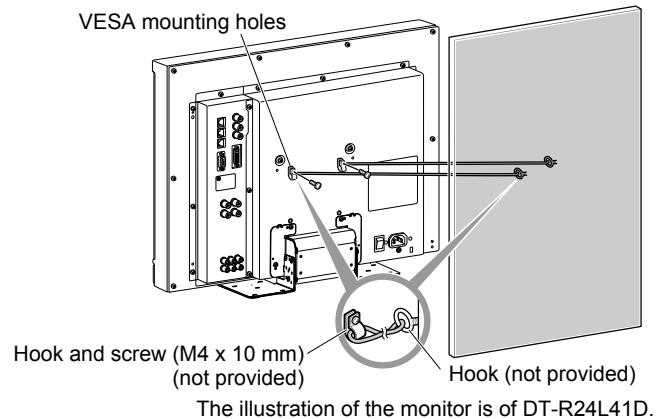

FCC NOTICE

CAUTION: Changes or modifications not approved by JVC could void the user's authority to operate the equipment.

NOTE: This equipment has been tested and found to comply with the limits for a Class A digital device, pursuant to Part 15 of the FCC Rules. These limits are designed to provide reasonable protection against harmful interference when the equipment is operated in a commercial environment. This equipment generates, uses, and can radiate radio frequency energy and, if not installed and used in accordance with the instruction manual, may cause harmful interference to radio communications. Operation of this equipment in a residential area is likely to cause harmful interference in which case the user will be required to correct the interference at his own expense.

IMPORTANT RECYCLING INFORMATION

This product has a fluorescent lamp that contains mercury. Disposal of these materials may be regulated in your community due to environmental considerations. For disposal or recycling information, please contact your local authorities or for USA, the Electronic Industries Alliance: <http://www.eiae.org>

WARNING: TO PREVENT FIRE OR SHOCK HAZARDS, DO NOT EXPOSE THIS APPARATUS TO RAIN OR MOISTURE.

WARNING: THIS APPARATUS MUST BE CONNECTED TO A MAINS SOCKET OUTLET WITH A PROTECTIVE EARTHING CONNECTION.

CAUTION: DANGER OF EXPLOSION IF BATTERY IS INCORRECTLY REPLACED. REPLACE ONLY WITH THE SAME OR EQUIVALENT TYPE.

IMPORTANT SAFETY INSTRUCTIONS

- 1) Read these instructions.
- 2) Keep these instructions.
- 3) Heed all warnings.
- 4) Follow all instructions.
- 5) Do not use this apparatus near water.
- 6) Clean only with dry cloth.
- 7) Do not block any ventilation openings. Install in accordance with the manufacturer's instructions.
- 8) Do not install near any heat sources such as radiators, heat registers, stoves, or other apparatus (including amplifiers) that produce heat.
- 9) Do not defeat the safety purpose of the polarized or grounding-type plug. A polarized plug has two blades with one wider than the other. A grounding type plug has two blades and a third grounding prong. The wide blade or the third prong are provided for your safety. If the provided plug does not fit into your outlet, consult an electrician for replacement of the obsolete outlet.
- 10) Protect the power cord from being walked on or pinched particularly at plugs, convenience receptacles, and the point where they exit from the apparatus.
- 11) Only use attachments/accessories specified by the manufacturer.
- 12) Use only with the cart, stand, tripod, bracket, or table specified by the manufacturer, or sold with the apparatus. When a cart is used, use caution when moving the cart/apparatus combination to avoid injury from tip-over.
- 13) Unplug this apparatus during lightning storms or when unused for long periods of time.
- 14) Refer all servicing to qualified service personnel. Servicing is required when the apparatus has been damaged in any way, such as power-supply cord or plug is damaged, liquid has been spilled or objects have fallen into the apparatus, the apparatus has been exposed to rain or moisture, does not operate normally, or has been dropped.
- 15) Apparatus shall not be exposed to dripping or splashing and no objects filled with liquids, such as vases, shall be placed on the apparatus.
- 16) Batteries shall not be exposed to excessive heat such as sunshine, fire or the like.
- 17) When discarding batteries, environmental problems must be considered and the local rules or laws governing the disposal of these batteries must be followed strictly.



Operating Precautions

The LCD panel and backlight have life expectancy. Due to the basic characteristics of the LCD panel, an afterimage or uneven display may occur. It is recommended that you change images occasionally, activate the power saving function, or often turn off the power to reduce the load on the LCD panel. Charges will apply for repairs resulting from deterioration due to the passage of time.

■ Caution for use of the product for many hours

In the case that you use the monitor for many hours, we recommend that you set "NO SYNC ACTION" in "SYNC FUNCTION" to "P.SAVE" in MAIN MENU. This will reduce power consumption and relieve strain on the monitor.

■ Caution for use of the product in the high temperature

Do not use the product in places of high temperature; otherwise, parts of this product or the LCD panel may be damaged. This product is equipped with a temperature sensor to give warning if the temperature becomes too high. If the temperature exceeds the range of normal use, "TEMP. OVER" is displayed, and the power is turned off automatically if the temperature becomes any higher. In this case, move the product to a place of low temperature to let it cool down.

■ Maintenance

Unplug this product from the wall outlet before cleaning.

Screen

To avoid irreparable change in appearance of the screen such as uneven color, discoloration, scratches, be careful about the following:

- Do not paste or stick anything using any glues or adhesive tapes.
- Do not write anything on the screen.
- Do not strike the screen with a hard object.
- Avoid condensation on the screen.
- Do not wipe the screen with solvent such as alcohol, thinner, or benzine.
- Do not wipe the screen forcefully.

Wipe stains off the screen with a soft cloth. If the screen gets heavily stained, wipe it with a soft cloth soaked in water-diluted neutral detergent and wrung well, then wipe with a soft dry cloth.

Cabinet

To avoid the deterioration or damages of the cabinet such as its paint's peeling away, be careful about the following:

- Do not wipe the cabinet using solvent such as alcohol, thinner, or benzine.
- Do not expose the cabinet to any volatile substance such as insecticides.
- Do not allow any rubber or plastic in contact for a long time.
- Do not wipe the cabinet forcefully.

Wipe stains off the cabinet with a soft cloth. If the cabinet gets heavily stained, wipe it with a soft cloth soaked in water-diluted neutral detergent and wrung well, then wipe with a soft dry cloth.

Ventilation openings

Use a vacuum cleaner to get rid of the dust around the intakes (all the openings). If a vacuum cleaner is not available, use a cloth and wipe it off. Leaving the dust around the intakes may prevent proper temperature control and cause damage to the product.

Installation

CAUTION

- Do not rest your arm on the monitor or lean against the monitor.
- Do not touch the LCD panel when installing the monitor.
- Be sure to install the monitor securely to prevent the monitor from falling over, which may cause damage to the monitor or injury.

To install the monitor on a shelf or any other suitable surface using screws

You can install the monitor without protruding the stand bottom plate by moving the stand bottom plate to the rear position.

CAUTION

- Lay the monitor on a cloth with the LCD panel facing down to prevent the LCD panel from being damaged.
- After moving the stand bottom plate to the rear position, be sure to attach the stand with commercially available screws.

- 1 Loosen the stand screws on the stand support and remove the bottom plate.

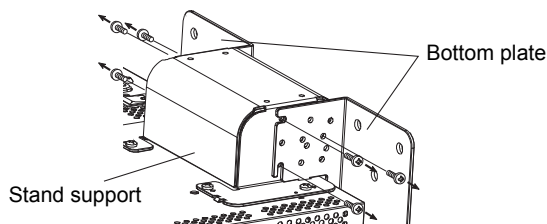

- 2 Temporarily set the stand screws to screw holes "3" on the right and left sides of the stand support.
 - Tighten the temporarily set stand screws so that they protrude from the screw holes by about 4 mm.

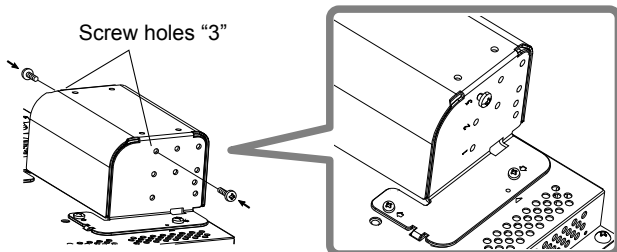

- 3 Hook right and left recesses "A" onto the temporarily set screws in the stand support.

Recesses "A"

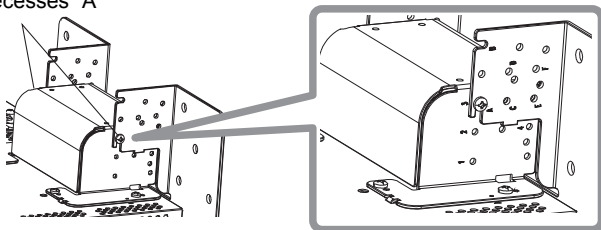

- 4 Adjust the position so that the screw holes on the stand support align with right and left screw holes "C" and "E" on the bottom plate, tighten the two stand screws on one side (four screws on both sides), and finally retighten the temporarily set screws to lock the stand support and the bottom plate.

Screw hole "C" and "E"

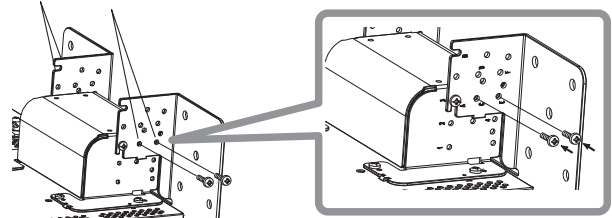

- 5 Use no less than two commercially available screws (no less than four screws on both sides) for the screw holes (10 - φ8) on the stand bottom plate, to anchor the monitor. (Use screws having enough holding strength and resistance against external force of expected vibrations.)

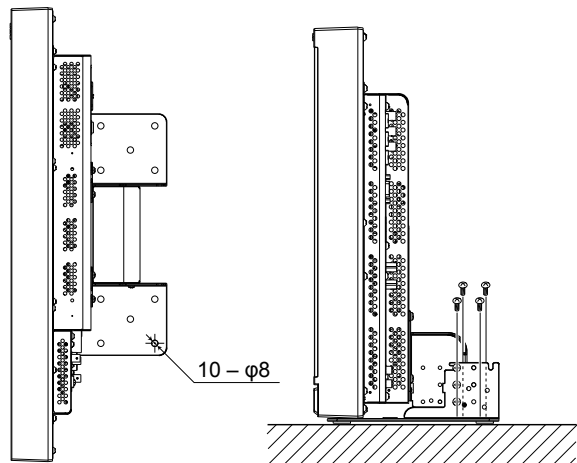

CAUTION

It is very dangerous not to anchor the stand with screws as this may cause not only breakage due to the monitor falling or dropping, but also injury or electrical shock.

To detach the stand

CAUTION

Lay the monitor on a cloth with the LCD panel facing down to prevent the LCD panel from being damaged.

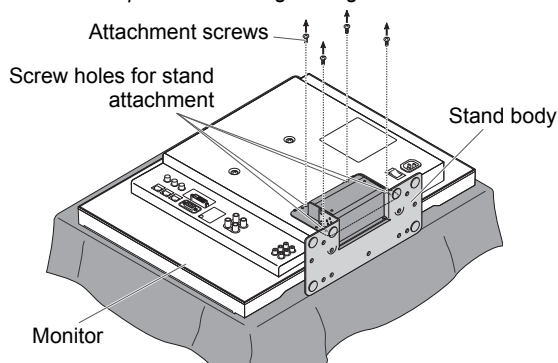

The illustration of the monitor is of DT-R24L41D.

To install the stand

When attaching the stand to the monitor, insert the guides of the stand into the guide holes on the monitor to place the stand in the correct position. Then fix the stand firmly with the attachment screws.

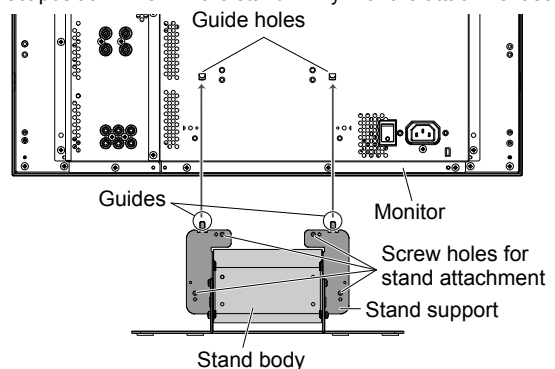

The illustration of the monitor is of DT-R24L41D.

To install the monitor on a wall

You can install the monitor on a wall by changing how the stand bottom plate is attached.

Installation Only for Authorized Service Personnel

Consult authorized service personnel for the installation of this unit. Installation instructions must be followed precisely in order to prevent accidents. We are selling this product with the understanding that it will be assembled and installed by properly trained and qualified service personnel.

We are not liable for any damage caused by faulty assembly, faulty wall mounting, insecure wall mounting, misuse, alterations, or natural disasters.

- Please be aware that screw holes and anchor bolts will remain in the wall surface if the monitor is removed after having been mounted to the wall.
Long-term use of the LCD display monitor may result in discoloration of the wall surface due to heat/air emitted by the display.

Danger

- Consult authorized service personnel for the installation and attachment of this unit to the wall. Do not attempt to mount the unit by yourself.
This unit weighs 12 kg at maximum (26.5 lbs. at maximum), including LCD display monitor. Improper assembly or installation may cause the unit to fall when it is mounted, which may result in fatal accidents. To prevent this happening, check the strength of the materials in the mounting surface. Check the material strength again after mounting as well.

Warning

- Using a monitor other than this product may result in damage or bodily injury due to the LCD display monitor toppling over.
- Assemble all screws securely. Failure to do so may result in the LCD monitor and stand falling down, potentially causing damage or bodily injury.
- This unit does not come with anchor bolts for securing it to walls, etc. Be sure you have materials on hand as appropriate for the mounting location.
- The monitor should be mounted to a wall that can adequately hold the total weight of the monitor and stand over a long period of time and which can adequately withstand earthquakes, conceivable vibrations, and other external forces.
- Mounting On Wooden Walls
The weight of the unit should be borne by the wall posts or studs, and these should be reinforced if insufficiently strong. Do not install the Wall Mounting Unit on walls made of plasterboard or thin plywood. Use the commercially sold screws best suited for the wall structure and material.
- Mounting On Concrete Walls
Use commercially sold wall anchors capable of supporting the weight of the LCD monitor.
- Do not install the Wall Mounting Unit near the blower or air inlet of an air conditioner.
- Do not install the Wall Mounting Unit in a location subject to frequent vibration, impact or other external forces.
- Do not install the unit in a location where people may hang on it or lean against it.
- Do not block the ventilation holes.
- Do not install the monitor on a non-vertical wall.

Caution

- Consult authorized service personnel for electrical work. Using power cords damaged during installation (i.e., exposed or severed wiring) may result in fire or electric shock.
- Conduct the work with adequate working space. Damage or bodily injury may result from working under unsuitable conditions.
- Avoid mounting this unit in areas where there is electrical wiring or water pipes, as fire or electric shock may result.

- 1 Lay the monitor on a cloth with the LCD panel facing down to prevent the LCD panel from being damaged. Loosen the stand screws on the stand support and remove the bottom plate.

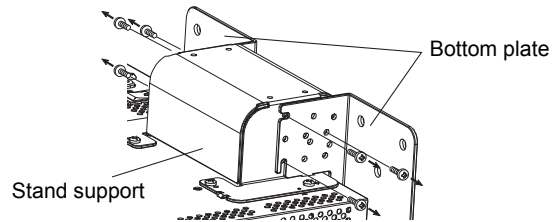

- 2 Temporarily set the stand screws in screw holes "2" and "4" on the right and left sides of the stand support.
 - Tighten the temporarily set stand screws so that they protrude from the screw holes by about 4 mm.

Stand screws "2" and "4"

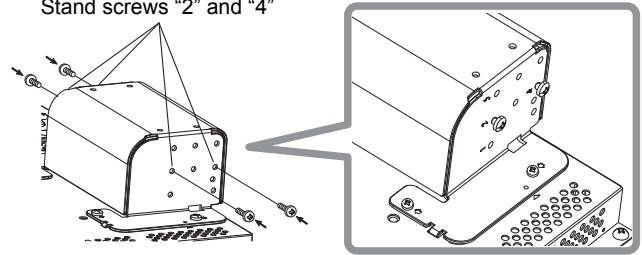

- 3 Tighten commercially available screws in the 6 holes shown in the figure below to install the monitor on the wall.

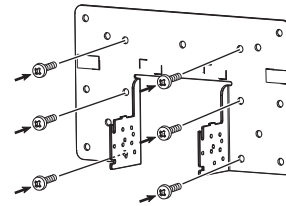

- 4 Hook the temporarily set screws on the stand support in right and left recesses "A" and "B" on the bottom plate, tighten the two stand screws in right and left screw holes "D" and finally retighten the temporarily set screws to lock the stand support and bottom plate.

Recesses "A" and "B"

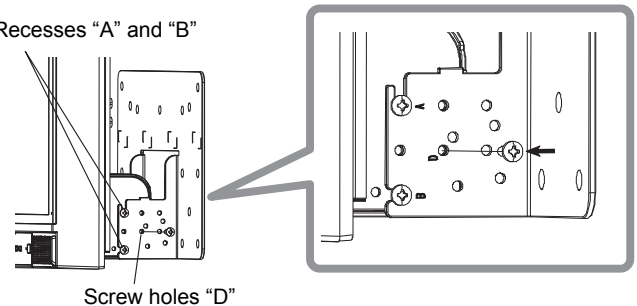

Connections

■ Rear panel

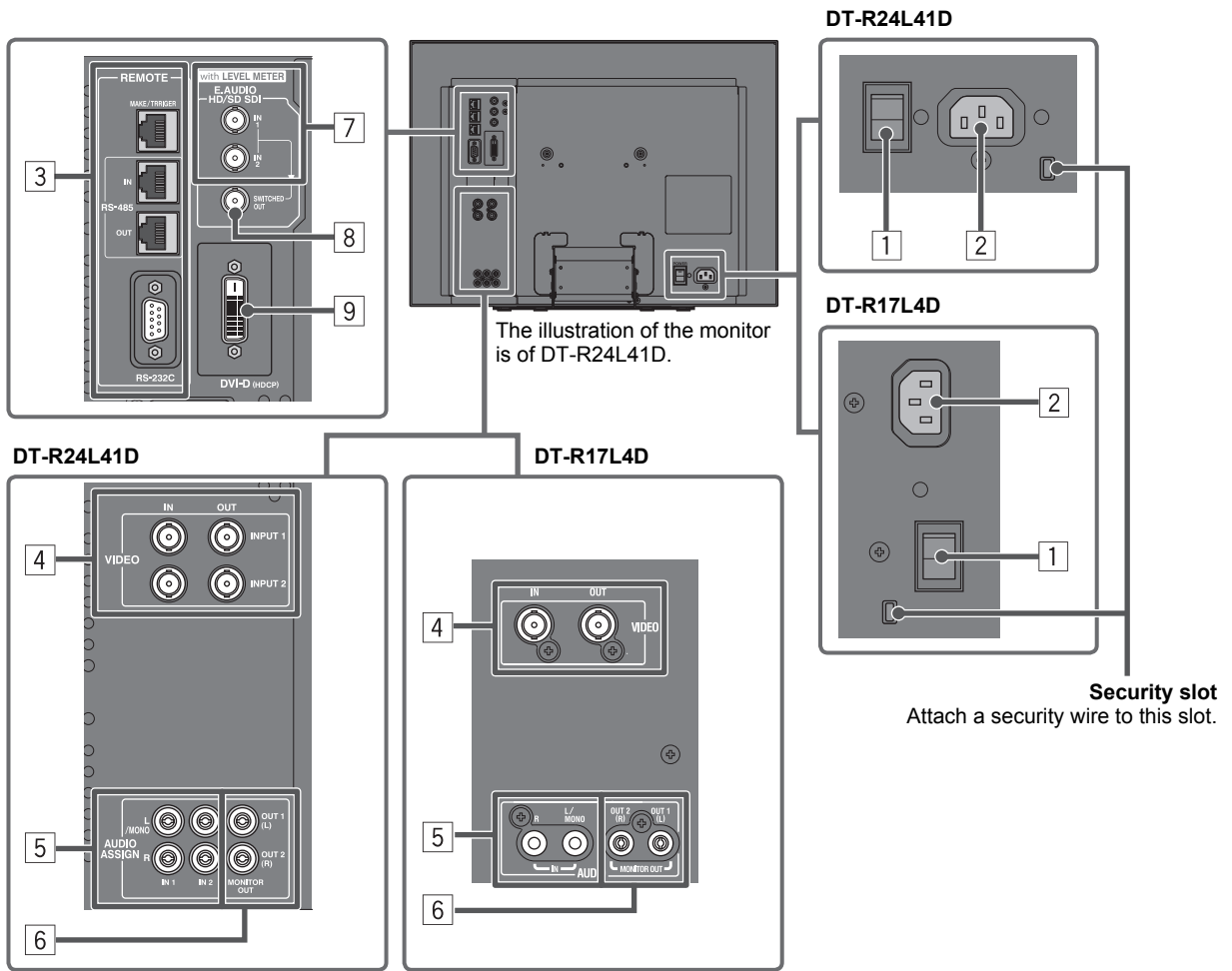

1 POWER switch

Turns AC power on or off.

- You need to press P / I button (see 15 on page 10) to use the monitor after turning on the POWER switch.

2 AC IN terminal

AC power input connector.

Connect the provided AC power cord to an AC outlet.

- Attach the provided power cord holder to prevent accidental disconnection of the AC power cord (see "Attaching the power cord holder" on page 9).

CAUTION

Do not connect the power cord until all other connections are completed.

3 REMOTE terminal

Terminal for controlling the monitor by an external control (see "External Control" on page 18).

4 For DT-R24L41D: VIDEO (INPUT 1/INPUT 2) terminals (BNC) / For DT-R17L4D: VIDEO terminals (BNC)

Input (IN) and output (OUT) terminals for the composite signals.

5 For DT-R24L41D: AUDIO ASSIGN (IN 1/IN 2) terminals (pin jack) / For DT-R17L4D: AUDIO (IN) terminals (pin jack)

Input terminals for the analog audio signals.

- Use this terminal for the analog audio connection of the SDI. When a superimposed signal (EMBEDDED AUDIO signal on an SDI signal) is input, analog audio signals cannot be input.
- For DT-R24L41D: Select the video input to assign the audio signal in "AUDIO1 ASSIGN." or "AUDIO2 ASSIGN." (see "AUDIO SETTING" on page 14).

- 6 **For DT-R24L41D: AUDIO ASSIGN (MONITOR OUT) terminals (pin jack) / For DT-R17L4D: AUDIO (MONITOR OUT) terminals (pin jack)**
Output terminals for the analog audio signal.
- For DT-R24L41D: The terminals output the audio signal through AUDIO ASSIGN (IN 1 or IN 2) terminals when you select the video input you have selected for "AUDIO1 ASSIGN." or "AUDIO2 ASSIGN." in "AUDIO SETTING" (☞ page 14).
 - For DT-R17L4D: The terminals emit the audio signals through the AUDIO (IN) terminal or EMBEDDED AUDIO signals through the E. AUDIO HD/SD SDI (IN 1 or IN 2) input terminal.
 - The signal is output from this terminal only when the monitor is on or in "P.SAVE" (power save) mode (☞ "NO SYNC ACTION" on page 15).
 - The EMBEDDED AUDIO signal...
 - is decoded into an analog signal, then emitted.
 - is emitted only when "SDI 1" or "SDI 2" is selected, and when EMBEDDED AUDIO signals come in to the E. AUDIO HD/SD SDI (IN 1 or IN 2) terminal.
 - has priority over the audio signal input to AUDIO ASSIGN (IN 1 or IN 2) terminals when "SDI-1" or "SDI-2" is selected for "AUDIO1 ASSIGN." or "AUDIO2 ASSIGN." and the EMBEDDED AUDIO signal is input to E.AUDIO HD/SD SDI (IN 1 or IN 2) terminal (DT-R24L41D only).
- 7 **E. AUDIO HD/SD SDI (IN 1, IN 2) terminals (BNC)**
Input terminals for the HD/SD SDI signals.
- The terminals accept also EMBEDDED AUDIO signals including up to 12 audio channels with a sampling frequency of 48 kHz.
- 8 **E. AUDIO HD/SD SDI (SWITCHED OUT) terminal (BNC)**
Output terminal for the HD/SD SDI signals.
- The SDI signals of the current input (SDI 1 or SDI 2) are re-clocked, then emitted.
 - When an input other than SDI 1 and SDI 2 is selected, the SDI signal of the input selected last time is emitted from this terminal.
 - The signals are emitted from this terminal only when the monitor is on or in "P.SAVE" (power save) mode.
- 9 **DVI-D (HDCP) terminal**
Input terminal for the DVI-D signal compatible with HDCP.
- When the picture is not displayed correctly, change the setting of "DVI INPUT SEL." (☞ page 17).

Note for connections

- Before making any connections, turn off all the equipment.
- Use a cord whose plugs correctly match the terminals on this monitor and the equipment.
- Plugs should be firmly inserted; poor connections could cause noise.
- When unplugging a cord, be sure to grasp its plug and pull it out.
- DO NOT connect the power cord until all connections are complete.
- Refer also to the user manual of each piece of equipment.

Attaching the power cord holder

The provided power cord holder prevents accidental disconnection of the AC power cord from the AC IN terminal.

- The power cord holder consists of two parts, a case and a cover.

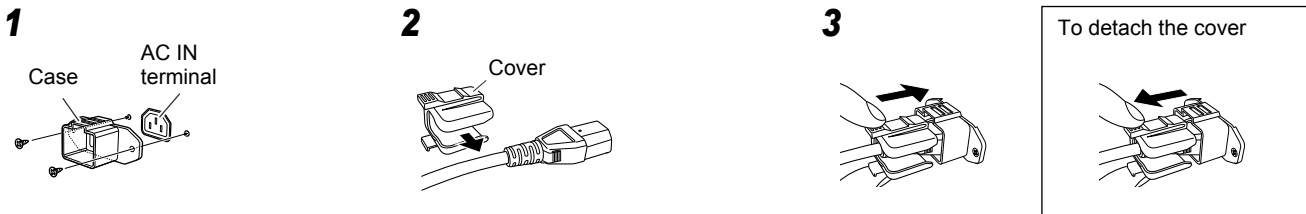

CAUTION

- Use only the provided screws.
- Make sure the plug will not be pulled out after the cover is attached to the case.
- The illustration above is of DT-R24L41D. When using DT-R17L4D, pay attention to the direction in which the power cord holder is attached.

■ Front panel

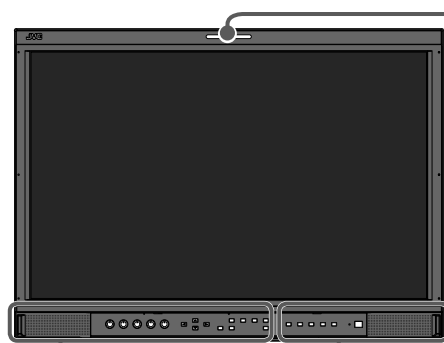

The illustration of the monitor is of DT-R24L41D.

Tally lamp

This lamp is controlled by the tally function of the MAKE/TRIGGER terminal.

- You can select the color of the tally lamp from "GREEN" or "RED." (☞ "TALLY SELECT" in "FUNCTION SETTING" on page 15 and "External Control" on page 18)

- "NO EFFECT" is displayed when you press a button which is not available for the current input or signal format (the lamp lights even when the function does not actually work).
- The items controlled by the MAKE system cannot be controlled by the buttons on the front panel ("REMOTE ON" is displayed and the lamps do not light).

DT-R17L4D

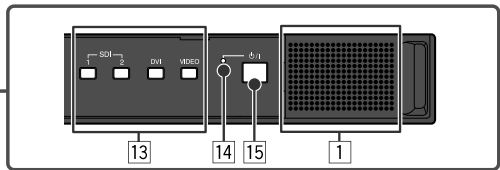

DT-R24L41D

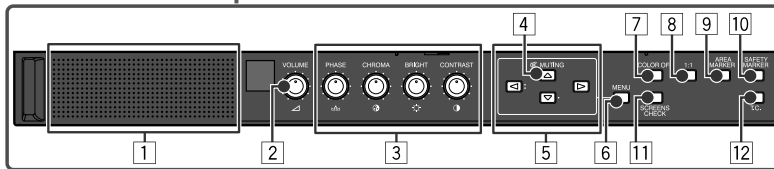
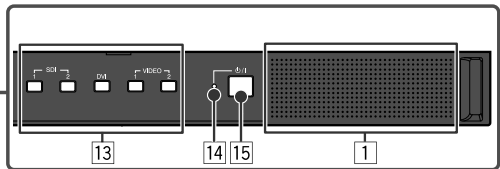

1 Speakers (stereo)

The speakers emit the same audio signal emitted from the AUDIO ASSIGN (DT-R24L41D) / AUDIO (DT-R17L4D) (MONITOR OUT) terminals. (☞ "6 AUDIO ASSIGN (DT-R24L41D) / AUDIO (DT-R17L4D) (MONITOR OUT) terminals" on page 9)

2 VOLUME adjustment knob

Adjusts the volume.

3 Picture adjustment knob

PHASE: Adjusts the picture hue.
CHROMA: Adjusts the picture color density.
BRIGHT: Adjusts the picture brightness.
CONTRAST: Adjusts the picture contrast.

- PHASE and CHROMA cannot be adjusted for certain signal formats.
- When "COMPONENT PHASE" is set to "DISABLE" and an NTSC signal is input, PHASE can be adjusted (☞ page 15).

4 MUTING button

Turns off the sound when no menu screen is displayed.

- To cancel the function, press the button again or turn the VOLUME adjustment knob.
- Muting function is also canceled when "BALANCE" of "AUDIO SETTING" in the MAIN MENU is changed (☞ page 14).

5 </>/Δ/∇ buttons

When a menu screen is displayed
 Selects or adjusts menu items. (☞ "The operation procedure" on page 12)

When no menu screen is displayed
 Selects the audio channels of EMBEDDED AUDIO signals. (☞ "Audio Channel Selection" on page 11)

- Pressing </> button while holding ∇ button displays the SET-UP MENU. (☞ "The operation procedure" on page 12)

6 MENU button

Activates/deactivates the display of the MAIN MENU. (☞ "The operation procedure" on page 12)

7 COLOR OFF button/lamp

Displays only the luminance signal.

- This function does not work for RGB input signals.

8 1:1 button/lamp

Displays the picture in the original resolution of the input signal.

- The aspect ratio of the picture may change depending on the input signal.

9 AREA MARKER button/lamp

Displays/hides the area marker.

- Select the style of the area marker in "MARKER" of the MAIN MENU (☞ page 13).
- This function works only when displaying the picture in 16:9 aspect ratio.
- This function does not work when "AREA MARKER" or "R-AREA MARKER" is set to "OFF" in "MARKER."

10 SAFETY MARKER button/lamp

Displays/hides the safety marker.

- Adjust the area of the safety marker in "MARKER" of MAIN MENU (☞ page 13).
- This function does not work when displaying the picture in the 1:1 mode.
- This function does not work when "SAFETY MARKER" or "R-SAFETY MARKER" is set to "OFF" in "MARKER."

11 SCREENS CHECK button/lamp

Displays only the selected element (R, G, or B) of the video signal.

- Each time you press this button, the picture changes in the following order.

→ RGB (Normal screen) → Red screen
 ← Blue screen ← Green screen ←

12 T.C. (time code) button/lamp

Activates/deactivates the display of the time data (time code) contained in the SDI signal. (☞ "On the Information Display" on page 11)

- Select the time code type in "INFORMATION" of SET-UP MENU (☞ page 17).

13 INPUT SELECT buttons/lamps

Selects an input.

SDI 1: E. AUDIO HD/SD SDI (IN 1) terminal
SDI 2: E. AUDIO HD/SD SDI (IN 2) terminal
DVI: DVI-D (HDCP) terminal

DT-R24L41D

VIDEO 1: VIDEO (INPUT 1) terminal
VIDEO 2: VIDEO (INPUT 2) terminal

DT-R17L4D

VIDEO: VIDEO terminal

- The lamp for the selected input lights.

14 Power lamp

Unlit: The monitor is completely off (the power switch on the rear panel is turned off).

Lights in Green:
 The monitor is on.

Lights in orange:
 The monitor is off (on standby).

Flashes in orange:
 The monitor is in the P. SAVE (power save) mode. (☞ "NO SYNC ACTION" in "SYNC FUNCTION" on page 15)

15 ⏻ / I button

Turns on and off (on standby) the monitor.

- The power switch is equipped on the rear panel of the monitor (☞ 1 on page 8).

Audio Channel Selection

Select audio channels emitted from the speakers (L/R) and the AUDIO ASSIGN (DT-R24L41D) / AUDIO (DT-R17L4D) (MONITOR OUT) (OUT1(L)/OUT2(R)) terminals, when EMBEDDED AUDIO signals come in to the E. AUDIO HD/SD SDI terminal (IN1 or IN2) and SDI input (1 or 2) is selected.

- You have to choose a group of selectable audio channels before the channel selection. (☞ “E.AUDIO GROUP” in “AUDIO SETTING” on page 14)
- The setting is memorized for each input (SDI 1 and SDI 2).

1 Press ◀ or ▶ button when a menu is not displayed.

The screen for audio channel selection is displayed.

- The screen for audio channel selection automatically disappears in about 30 seconds after the previous operation.

Audio channel selection screen

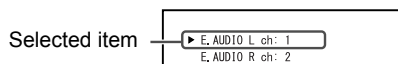

2 Press △ ▽ buttons to select the left (L ch) or right (R ch).

3 Press ◀ ▶ buttons to select an audio channel.

- Each time you press the button, the audio channel changes according to the settings of “E.AUDIO GROUP.” (☞ page 14)

4 Press MENU button.

The screen for audio channel selection disappears.

On the Information Display

The monitor displays the information below.

- Make the setting to display/hide each information using the MENU with the exception of [5], controlled with T.C. button (☞ [12] on page 10).
- Select the position of the information display. (☞ “POSITION” in “INFORMATION” on page 17)

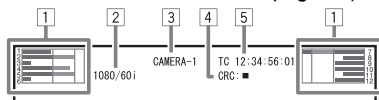

1 Audio level meter

- You can check the conditions of the EMBEDDED AUDIO signals when “LEVEL METER ch” is set to “LINE” or “DIVIDE.”
 - Not displayed when “LEVEL METER ch” is set to “OFF.”
- ☞ “AUDIO SETTING” on page 14

2 Signal format

- Displayed when “STATUS DISPLAY” is set to “ON.”
- (☞ “INFORMATION” on page 17)
- For the contents displayed, see “Available signals” on page 26 and “On the signal format” below.

3 Source name assigned in “CHARACTER SET.”

- Displayed when “SOURCE ID” is set to “ON” or “AUTO.”
- Displayed in large letters when “STATUS DISPLAY” is set to “OFF” or “AUTO.”

☞ “INFORMATION” on page 17

4 CRC error indication

- Displayed when “CRC ERROR” is set to “ON.”
- (☞ “INFORMATION” on page 17)
- A red square is displayed when an error occurs.

5 Time code

- When the input signal includes no time code, “TC --:--:--:--:--” is displayed (☞ [12] on page 10).

- When any information of [1], [2], [3], or [4] above is displayed while signals come in from equipment other than a computer, the picture is displayed without overlapping the information display area.

However, the information display will overlap with the picture when...

- displaying the picture with higher resolution than the resolution of the panel in 1:1 mode.
- “SD4:3 SIZE” setting in MAIN MENU is “H FULL” and “V FULL”: (DT-R24L41D)
- “SD4:3 SIZE” setting in MAIN MENU is “H FULL”: (DT-R17L4D)

On the Status Display

If you press the INPUT SELECT button (☞ [13] on page 10) currently lit, the status of the input signal and setting of MUTING are displayed for about 3 seconds.

- Make the setting to display/hide the status in “STATUS DISPLAY” of the “INFORMATION” (☞ page 17).
- When “STATUS DISPLAY” is set to “AUTO” or “ON,” the status below is also displayed in the following cases:
 - When you change the input
 - When the signal condition of the current input changes
 - When you turn on the monitor
- When “STATUS DISPLAY” is set to “ON,” the signal format will remain displayed 3 seconds after the status is displayed.

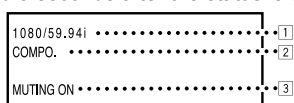

1 Signal format

- For the contents displayed, see “Available signals” on page 26 and “On the signal format” below.

On the signal format

The following messages appear depending on the type of input signals and their conditions.

When a DVI-D signal protected with HDCP is input

➔ “*” (at the end of the indication)

When no video signal comes in

➔ “NO SYNC”

When a noncompliant video signal comes in

➔ “Out of range”

When “COLOR SYSTEM” (☞ “FUNCTION SETTING” on page 15) is set to “AUTO” and the noncompliant composite video signals come in

➔ “OTHERS”

2 Signal format of DVI input

☞ “DVI INPUT SEL.” on page 17

3 Setting of “MUTING”

- Displayed only when muting is activated (☞ [4] on page 10).

Menu Configuration

The operation procedure

1 Display the menu.

To display the MAIN MENU

→ Press MENU button.

To display the SET-UP MENU

→ Press ◀ button while holding ▽ button.

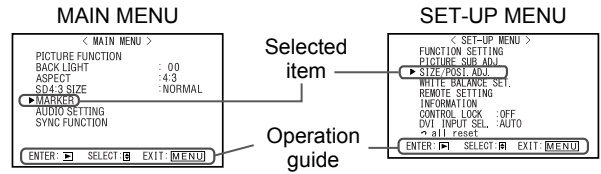

2 Press △ ▽ buttons to select an item, then press ▷ button.

• For some items, adjustments will be made by pressing ◀▷.



Ex.: When "MARKER" in the MAIN MENU is selected

3 Press △ ▽ buttons to select an item, then press ◀▷ buttons to make adjustments.

4 Press MENU button to finish the menu operation.

• Pressing MENU button repeatedly deactivates the display of the menu.

Menu Transition Diagram

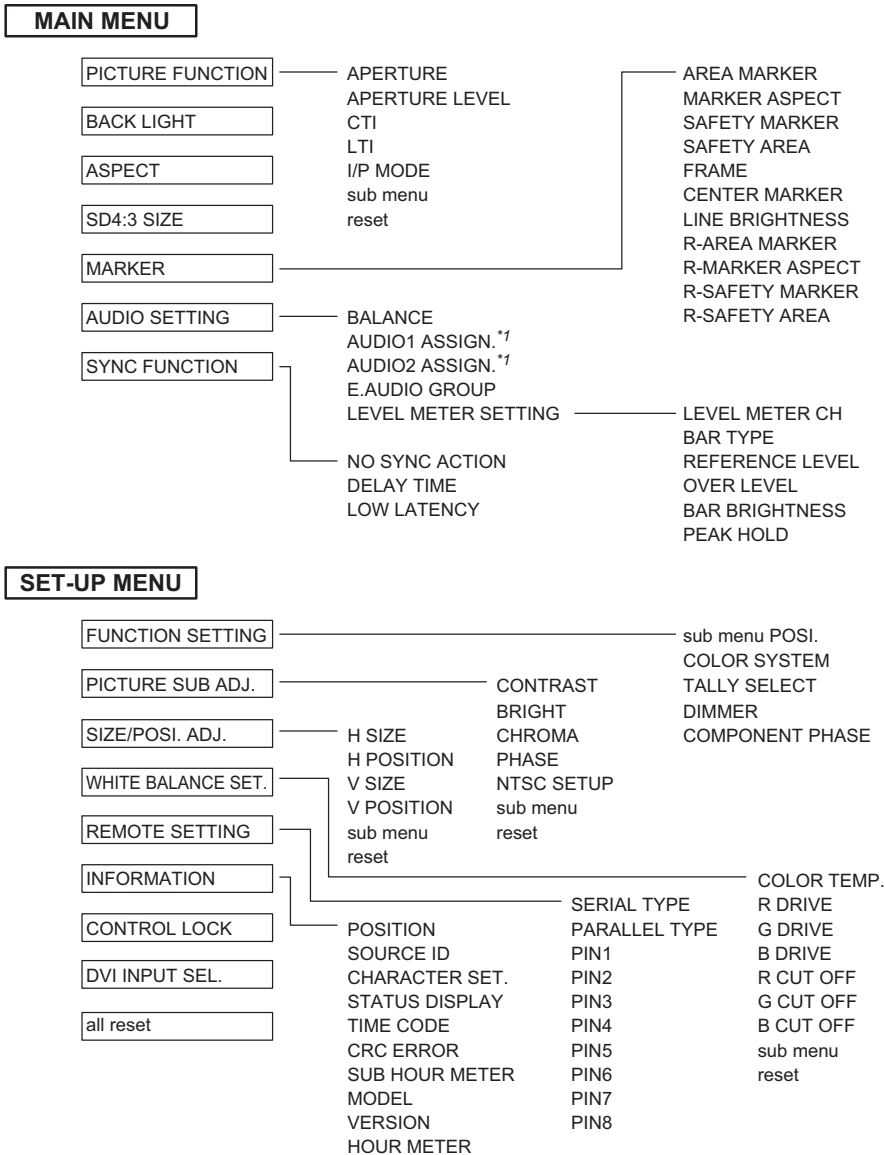

*1 DT-R24L41D only

- The menu automatically disappears in about 30 seconds after the previous operation.
- Some items may not appear on the menu depending on the input or the input signal.
- The items controlled by the MAKE system do not appear on the menu.

■ MAIN MENU

■ PICTURE FUNCTION

Setting for the picture quality

Item	To do	Setting value
APERTURE ^{*1}	Activates/deactivates the function at the level set in "APERTURE LEVEL."	OFF, ON
APERTURE LEVEL ^{*1}	Compensate the frequency response of the luminance signal of the video signal.	01 – 10
CTI	Adjust the clearness of the outlines of the chrominance signal.	OFF, NORMAL, HARD
LTI	Adjust the clearness of the outlines of the luminance signal.	OFF, NORMAL, HARD
IP MODE	Selects a proper mode corresponding to the input picture.	NORMAL, CINEMA, FIELD
sub menu	Display the sub menu which enables you to adjust the items of "PICTURE FUNCTION" while viewing the actual picture.	
reset	Restore the default settings for all the items in "PICTURE FUNCTION."	

^{*1} Memorized for each input.

■ BACK LIGHT Setting value: -20 – +20

Adjusts the brightness of the display.

- Adjust according to the ambient light conditions.

■ ASPECT Setting value: 4:3, 16:9

Sets the aspect ratio (horizontal to vertical ratio of the screen) of the SD signal.

- Not activate when picture is displayed in the 1:1 mode.

■ SD4:3 SIZE Setting value: NORMAL, H FULL, V FULL^{*1}

Selects the picture size when the input signal format is 4:3.

NORMAL: Matches the vertical picture size to the number of pixels.

H FULL: Matches the horizontal picture size to the horizontal size of the screen. At this time, the top and bottom of the picture are overscanned.

V FULL: Matches the vertical picture size to the vertical size of the screen.

- Not activate when picture is displayed in the 1:1 mode.

^{*1} DT-R24L41D only

■ MARKER^{*1*2}

Settings for marker functions

1/2

Item	To do	Setting value
AREA MARKER ^{*3}	Activate/deactivate the area marker and select the style of it. The setting values and features are as follows. OFF: Deactivate the marker. LINE: Displays the area with an outline. HALF: The area outside the specified aspect ratio of the screen is displayed at 50% transparency. HALF+L: The area of the specified aspect ratio of the screen is indicated by an outline, and the area outside of that is displayed at 50% transparency. BLK.: The area outside the specified aspect ratio of the screen is black. Only the portion of the picture within the designated area is displayed. BLK. +L: The area of the specified aspect ratio of the screen is indicated by an outline, and the area outside of that becomes black so that only the area inside the line is displayed.	OFF, LINE, HALF, HALF+L, BLK. , BLK.+L
MARKER ASPECT ^{*3}	Select the aspect ratio of the area marker.	4:3, 14:9, 13:9, 2.35:1, 1.85:1, 1.66:1
SAFETY MARKER	Activate/deactivate the safety marker and select the style of it. ^{*4}	OFF, LINE, HALF, HALF+L, BLK. , BLK.+L
SAFETY AREA	Adjust the area of the safety marker.	80% – 100%
FRAME	Displays/hides the frame indicating the area of the specified aspect ratio.	OFF, ON
CENTER MARKER	Displays/hides the marker indicating the center position of the picture.	OFF, ON
LINE BRIGHTNESS	Adjust the brightness of the marker.	HIGH, LOW

- The area marker or the safety marker is displayed by using AREA MARKER or SAFETY MARKER button, or external control.

- Select either non-"R-" items or "R-" items to activate by using external control. (☞ "External Control" on page 18)

- When a picture is displayed in 4:3 aspect ratio, the safety marker for the 4:3 area is displayed.

- To display the safety marker for the area of a picture displayed in 16:9 aspect ratio, hide the area marker.

^{*1} Memorized for each input.

^{*2} Not displayed when the picture is displayed in the 1:1 mode and when "SD4:3 SIZE" setting in MAIN MENU is "H FULL" and the input signal format is 4:3.

^{*3} Displayed only when picture is displayed in 16:9 aspect ratio.

^{*4} The setting values are the same as that of "AREA MARKER".

Menu Configuration (cont.)

MARKER^{1,2}

Settings for marker functions

2/2

Item	To do	Setting value
R-AREA MARKER³	Activate/deactivate the area marker and select the style of it. ⁴	OFF, LINE, HALF, HALF+L, BLK. , BLK.+L
R-MARKER ASPECT³	Select the aspect ratio of the area marker.	4:3, 14:9, 13:9, 2.35:1, 1.85:1, 1.66:1
R-SAFETY MARKER	Activate/deactivate the safety marker and select the style of it. ⁴	OFF, LINE, HALF, HALF+L, BLK. , BLK.+L
R-SAFETY AREA	Adjust the area of the safety marker.	80% – 100%

- The area marker or the safety marker is displayed by using AREA MARKER or SAFETY MARKER button, or external control.
- Select either non-"R-" items or "R-" items to activate by using external control. (☞ "External Control" on page 18)
- When a picture is displayed in 4:3 aspect ratio, the safety marker for the 4:3 area is displayed.
- To display the safety marker for the area of a picture displayed in 16:9 aspect ratio, hide the area marker.

¹ Memorized for each input.

² Not displayed when the picture is displayed in the 1:1 mode and when "SD4:3 SIZE" setting in MAIN MENU is "H FULL" and the input signal format is 4:3.

³ Displayed only when picture is displayed in 16:9 aspect ratio.

⁴ The setting values are the same as that of "AREA MARKER". (☞ page 13).

AUDIO SETTING

Settings for the audio output balance, EMBEDDED AUDIO signals and level meter

Item	To do	Setting value
BALANCE	Adjust the balance between the right and left speakers.	L5 – L1, 0, R1 – R5
AUDIO1 ASSIGN.¹	Select the video input which the audio signal through AUDIO ASSIGN (IN 1) terminal is assigned to.	SDI-1, SDI-2, DVI, VIDEO-1, VIDEO-2
AUDIO2 ASSIGN.¹	Select the video input which the audio signal through AUDIO ASSIGN (IN 2) terminal is assigned to.	
E.AUDIO GROUP²	Select the audio channel group of the EMBEDDED AUDIO signals. The setting values and selectable audio channels of EMBEDDED AUDIO signals are as follows. (G means GROUP) 1G: channel(s) 1/2/3/4/1+2/3+4/1 – 4 (1G) 2G: channel(s) 5/6/7/8/5+6/7+8/5 – 8 (2G) 1-2G: channel(s) 1/2/3/4/5/6/7/8/1+2/3+4/5+6/7+8/1 – 4 (1G)/5 – 8 (2G)/1 – 8 (1G+2G) 3G: channel(s) 9/10/11/12/9+10/11+12/9 – 12 (3G) 1-3G: channel(s) 1/2/3/4/5/6/7/8/9/10/11/12/1+2/3+4/5+6/7+8/9+10/11+12/1 – 4 (1G)/5 – 8 (2G)/9 – 12 (3G)/1 – 8 (1G+2G)/1 – 12 (1-3G)	1G, 2G, 1-2G, 3G, 1-3G

LEVEL METER SETTING²

Adjust the level meter display for the EMBEDDED AUDIO signals.

Example of the level meter display —Level meter position and audio channels

Ex.: When "LEVEL METER ch" is set to "LINE" and "BAR TYPE" is set to "3COLORS"

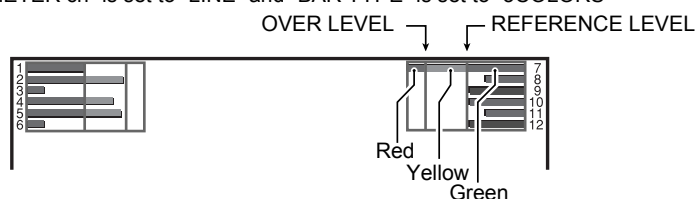

- The level meter with no audio signal input is displayed in white for "3COLORS", and in gray for "W.100."
- You can select the position of the level meter display—top or bottom of the screen. (☞ "POSITION" in "INFORMATION" on page 17)
- When "PEAK HOLD" is set to "ON," the maximum level meter value will remain displayed for a set period of time. (At the time the signal input level reaches the highest value.)

- LEVEL METER ch	Select how the audio channels are displayed on the level meter. LINE: Displays the channels 1 – 6 at the left of the screen and 7 – 12 at the right. DIVIDE: Displays the odd channels at the left of the screen and the even channels at the right.	OFF, LINE, DIVIDE
- BAR TYPE	Select the color of the level meter display. 3COLORS: 3 colors to indicate variations in input levels. W.100 : White	3COLORS, W.100
- REFERENCE LEVEL	Select the standard input level indicated on the level meter.	-20dB, -18dB
- OVER LEVEL	Select the input level's lower limit indicated in red for the "3COLORS" display.	-10dB, -8dB, -6dB, -4dB, -2dB
- BAR BRIGHTNESS	Select the brightness of the level meter.	LOW, HIGH
- PEAK HOLD	Activates/deactivates the peak hold function of the level meter.	OFF, ON

¹ DT-R24L41D only

² Memorized for each input.

SYNC FUNCTION

Settings for the synchronization with signals

Item	To do	Setting value
NO SYNC ACTION	Select the screen status when no signal is coming in. P.SAVE: power save mode GRAY B.: gray screen	OFF, P.SAVE, GRAY B.
DELAY TIME	Select the period until the screen status changes as selected in "NO SYNC ACTION" after signals stop coming in.	30sec., 5min., 15min.
LOW LATENCY	Activates/deactivates the function to shorten the time taken to display the picture (low latency function). • If the picture is not displayed steadily while "ON" is selected, select "OFF." • While "ON" is selected, the displayed picture may become unstable when an operation using buttons on the front panel or the menu is performed, or when the signal format changes.	ON, OFF

- When setting "NO SYNC ACTION" to "GRAY B.," the screen color changes to gray and the power consumption of the back light is saved by half. Selecting "P.SAVE" (power save mode) saves more power consumption by turning off the back light.
- In the initial setting, "NO SYNC ACTION" is set to "P.SAVE", and "DELAY TIME" set to "15min." Change the settings if necessary.

SET-UP MENU

FUNCTION SETTING

Settings for the sub menu display, color system, color of the tally lamp, picture size, intensity of the button lamps and the PHASE adjustment.

Item	To do	Setting value
sub menu POSI.	Select the contents and displaying position of "sub menu." The setting values and features are as follows. LOWER1: Displays the current setting and adjustment bar at the lower part of the screen. UPPER1: Displays the current setting and adjustment bar at the upper part of the screen. LOWER2: Displays the current setting at the lower part of the screen. UPPER2: Displays the current setting at the upper part of the screen. • The adjustment bar is not displayed for some items.	LOWER1, UPPER1, LOWER2, UPPER2
COLOR SYSTEM	Select the color system. • If the picture is unstable with "AUTO," select "NTSC" or "PAL."	AUTO, NTSC, PAL
TALLY SELECT	Select the color of the tally lamp.	GREEN, RED
DIMMER	Select the intensity of the button lamps.	NORMAL, DARK
COMPONENT PHASE	Deactivates the function of PHASE adjustment (Picture adjustment knob and "PICTURE SUB ADJ." in SET-UP MENU) except when an NTSC signal comes in (see [3] on page 10).	ENABLE, DISABLE

PICTURE SUB ADJ.

Adjusts the standard level for the picture adjustment and selects the set-up level for the input video signal.

Item	To do	Setting value
CONTRAST ^{*1}	Adjust the standard level for the contrast adjusted with the CONTRAST knob on the front panel.	-20 – +20
BRIGHT ^{*1}	Adjust the standard level for the brightness adjusted with the BRIGHT knob on the front panel.	-20 – +20
CHROMA ^{*1}	Adjust the standard level for the chroma adjusted with the CHROMA knob on the front panel.	-20 – +20
PHASE ^{*1, *2}	Adjust the standard level for the phase adjusted with the PHASE knob on the front panel.	-20 – +20
NTSC SETUP	Select the set-up level of the input NTSC signal. 00: compliant with 0% set-up signal 7.5: compliant with 7.5% set-up signal	00, 7.5
sub menu	Display the sub menu which enables you to adjust the items in "PICTURE SUB ADJ." while viewing the actual picture.	
reset	Restore the default settings for all the items in "PICTURE SUB ADJ."	

^{*1} Memorized for each input.

^{*2} When "COMPONENT PHASE" is set to "DISABLE" and an NTSC signal is input, PHASE can be adjusted.

Menu Configuration (cont.)

SIZE/POSI. ADJ.

Adjusts the size and position of the picture.

Item	To do	Setting value
H SIZE ^{*1}	Adjust the horizontal picture size.	Setting value varies depending on the signals.
H POSITION ^{*1}	Adjust the horizontal picture position.	
V SIZE ^{*1}	Adjust the vertical picture size.	
V POSITION ^{*1}	Adjust the vertical picture position.	
sub menu	Display the sub menu which enables you to adjust the items of "SIZE/POSI. ADJ." while viewing the actual picture.	
reset	Restore the default settings for all the items in "SIZE/POSI. ADJ."	

^{*1} Memorized for each signal format.

WHITE BALANCE SET.

Selects the color temperature and adjusts the drive level and cutoff point of each color (R/G/B).

Item	To do	Setting value
COLOR TEMP.	Select the color temperature.	9300K, 6500K, USER
R DRIVE G DRIVE B DRIVE ^{*2}	Adjust the drive level of each color (red, green, and blue).	MIN – 000 – MAX (in 256 grades)
R CUT OFF G CUT OFF B CUT OFF ^{*2}	Adjust the cutoff point of each color (red, green, and blue).	MIN – 000 – MAX (in 256 grades)
sub menu	Display the sub menu which enables you to adjust the items in "WHITE BALANCE SET." while viewing the actual picture.	
reset	Restore the default settings for the drive levels and cutoff points of the selected color temperature.	

^{*2} Memorized for each color temperature.

REMOTE SETTING (☞ "External Control" on pages 18 to 21)

Settings for the external control

Item	To do	Setting value
SERIAL TYPE	Select the input terminal used for external control by serial communication.	RS232C, RS485
PARALLEL TYPE	Select the external control method for the MAKE/TRIGGER terminal.	MAKE, TRIGGER, SET
PIN1 PIN2 PIN3 PIN4 PIN5	Assign the control functions to the pins of the MAKE/TRIGGER terminal. • Assign a function to each pin terminal by selecting "SET" in "PARALLEL TYPE" mentioned above.	☞ "Functions controlled by the MAKE/TRIGGER system" on page 19
PIN6 PIN7 PIN8	The functions are assigned for "PIN6" – "PIN8" and you cannot change the assignment of these functions.	☞ "Using the MAKE/TRIGGER system" on page 18

INFORMATION

Settings for the information display of the monitor

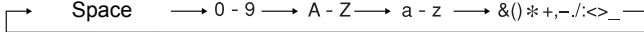
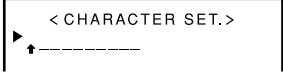
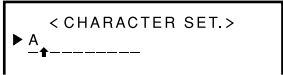
Item	To do	Setting value
POSITION	Select the position to show the information display (☞ "On the Information Display" on page 11).	UPPER, LOWER
SOURCE ID	Select whether the name assigned in "CHARACTER SET." is displayed on the screen (☞ "On the Information Display" on page 11). • When "AUTO" is selected, the display color synchronizes with the color of the tally lamp while the tally lamp is lit.	OFF, ON, AUTO
CHARACTER SET.*1	Assign a name to each video source as you like (10 characters at maximum). You can also enter a name using the RS-232C system. Setting of "CHARACTER SET." 1 Change the input to one that you want to assign a video source name for. 2 Select "CHARACTER SET." 3 Press Δ ∇ buttons to select the first character. • Each time you press Δ button, the character changes as follows. Press ∇ button to reverse the order.  4 Press \triangleright button to move the arrow to the next space. • The characters entered before moving the arrow are memorized. 5 Repeat steps 3 and 4 (10 characters at maximum). 6 Press MENU button to store the name.  	
STATUS DISPLAY	Select whether the status of the current input and the setting of MUTING are displayed on the screen (☞ "On the Status Display" on page 11).	AUTO, OFF, ON
TIME CODE	Select the type of the TIME CODE display.	VITC*2, LTC*2, D-VITC
CRC ERROR	Select whether the CRC error indication for the input HD SDI signal is displayed on the screen (☞ "On the Information Display" on page 11).	OFF, ON
SUB HOUR METER	Display the hours of use (unit: hour). You can reset this item.	
MODEL	Display the model name of the monitor.	
VERSION	Display the version of the monitor.	
HOURLY METER	Display the total hours of use (unit: hour). This item is used for maintenance of the monitor. You cannot reset this item.	

*1 Memorized for each input.

*2 Ancillary time code

CONTROL LOCK Setting value: OFF, VOL.LOCK, ALL LOCK

Settings for disabling the buttons on the front panel.

- The following operations are not available when "VOL.LOCK" is selected.
 - VOLUME adjustment knob
 - Picture adjustment knob
 - The "ALL LOCK" function disables to control the buttons on the front panel. But following operations are available.
 - Turning on/off (on standby) the monitor
 - Displaying the SET-UP MENU (by pressing \triangleleft button while holding ∇ button) and turning "CONTROL LOCK" to "OFF"
 - Operating the monitor by an external control
- If you try other operations, "Control lock on!" appears on the screen.

DVI INPUT SEL. Setting value: AUTO, COMPO., RGB, PC

When "AUTO" is selected, the format of signals come in to the DVI-D (HDCP) terminal is automatically recognized. (Normally, select "AUTO.")

- Select "COMPO.," "RGB" or "PC" when the picture is not displayed correctly with "AUTO."
- DVI-D input of the monitor is compatible with HDCP.

all reset

Restores all the settings and adjustments of the monitor to the default.

- "HOURLY METER" and the settings done by using the adjustment knobs on the front panel will not be reset.
- After performing "all reset," the monitor is turned off then turned on automatically.

■ About the external control

This monitor has three external control terminals.

- **MAKE/TRIGGER terminal** (RJ-45): The following external control systems are available.
 - (1) **MAKE (make contact) system**: Controls the monitor by short-circuiting the corresponding pin terminal to the GND pin terminal, or disconnecting (opening) it.
 - (2) **TRIGGER (trigger) system**: Controls the monitor by sending the pulse signal instantaneously to the corresponding pin terminal.
- **RS-485 terminals** (RJ-45): Controls the monitor with the RS-485 system (☞ "Using the serial communication" on page 20).
- **RS-232C terminal** (D-sub 9-pin): Controls the monitor with the RS-232C system (☞ "Using the serial communication" on page 20).

Set the following items of "REMOTE SETTING" in SET-UP MENU according to the external control terminal and control system (☞ "SERIAL TYPE," "PARALLEL TYPE" on page 16).

Control terminal	Control system		The settings of this unit	
			"SERIAL TYPE" setting	"PARALLEL TYPE" setting
MAKE/TRIGGER terminal	MAKE	RS-485	—	MAKE
	TRIGGER	RS-232C	—	TRIGGER
RS-485 terminal	Serial communication	RS-485	RS485*1	—
RS-232C terminal		RS-232C	RS232C*1	—

*1 For a monitor connected to a personal computer etc, select the terminal the equipment is actually connected to. For other monitors, select "RS485."

Control priority is as follows.

MAKE > TRIGGER = serial communication = buttons and menu on the monitor

- You can use external control even when "CONTROL LOCK" is set to "VOL.LOCK" or "ALL LOCK" (☞ page 17).
- When the monitor is off (on standby), external control is not available. But certain external controls (starting/terminating communication, turning on the monitor) are available through the serial communication (☞ page 21).

<MAKE/TRIGGER system>

You can control the monitor by a personal computer or dedicated controller*2.

- "Using the MAKE/TRIGGER system" on the right.
- *2 The controller is not commercially available. Consult your dealer if you need it.

<Serial communication>

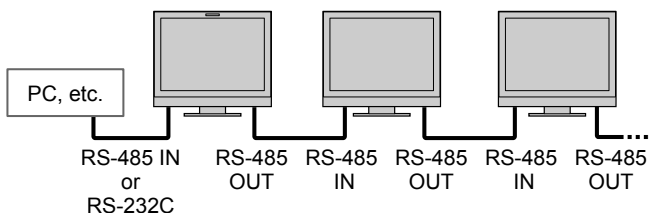

- For the details, see page 20.

■ Using the MAKE/TRIGGER system

The MAKE/TRIGGER terminal is configured as follows. You can assign a function to each pin terminal in "REMOTE SETTING" (☞ "PIN1, PIN2, PIN3, PIN4, PIN5" in "PARALLEL TYPE" on page 16).

- You cannot change the functions assigned to the pin terminals from 6th to 8th.

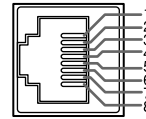

This is a female terminal.

Pin No.	Pin name
1	PIN1
2	PIN2
3	PIN3
4	PIN4
5	PIN5
6	TALLY*1
7	ENABLE*2
8	GND

*1 The 6th pin terminal controls turning on or off the tally lamp (available to control even when the 7th pin terminal is invalid).

*2 The 7th pin terminal makes the external control valid/invalid. Make sure to control the terminal by the MAKE system.

To assign the functions to the pin terminals

For the operation procedure, see page 12.

- 1 Select "REMOTE SETTING" on the SET-UP MENU.
- 2 Set "PARALLEL TYPE" to "SET."
- 3 Select a pin name ("PIN1" – "PIN5") for which you want to assign a function, then select the function you want to assign. For the selectable functions, see the table on page 19.

Operation of the external control

- 1 Set "PARALLEL TYPE" of "REMOTE SETTING" to "MAKE" or "TRIGGER" in the SET-UP MENU.
 - 2 Short-circuit the 7th pin terminal (ENABLE) to the 8th pin terminal (GND) so that the monitor can be controlled by the external control.
 - 3 When the "MAKE" system is selected: Operate each function by short-circuiting the corresponding pin terminal to the 8th pin terminal (GND) or opening it. When the "TRIGGER" system is selected: Operate each function by pulse control, that is short-circuiting the corresponding pin terminal to the 8th pin terminal (GND) for about 1 second and opening it.
- When changing the input with MAKE system, only one pin terminal must be short-circuited. (Other pin terminals must be opened.)
 - When selecting the "TRIGGER" system, you can operate only one function at a time. Operate the functions one by one.

<Functions controlled by the MAKE/TRIGGER system>

Display	Functions to be controlled	Opening	Short-circuiting	
TALLY SEL	Selects the color of the tally lamp.	Green	Red	
SDI 1	Changes the input to "SDI 1."	Invalid	Valid	
SDI 2	Changes the input to "SDI 2."	Invalid	Valid	
DVI	Changes the input to "DVI."	Invalid	Valid	
DT-R24L41D	VIDEO 1	Changes the input to "VIDEO 1."	Invalid	Valid
	VIDEO 2	Changes the input to "VIDEO 2."	Invalid	Valid
DT-R17L4D	VIDEO	Changes the input to "VIDEO."	Invalid	Valid
A.MARKER	The area marker indication	Off	On	
S.MARKER	The safety marker indication	Off	On	
FRAME	Indication of the area of the specified aspect ratio	Off	On	
C.MARKER	The center marker indication	Off	On	
MARK.SEL	Selects the items of "MARKER"* ³	Non-"R-" items	"R-" items	
ASPECT	Changes the aspect ratio.	4:3	16:9	
1:1	Displays in 1:1 mode.	Off	On	
STATUS	Status display* ⁴	☞ "On the Status Display" on page 11		
L.METER	Audio level meter display	* ⁵		
TIME CODE	Time code display	Off	On	
SOURCE ID	☞ "SOURCE ID" in "INFORMATION" on page 17	* ⁶		
COLOR OFF	Color off	Color	Monochrome	
SCR CHECK	Screens check	* ⁷		
I/P MODE	Change a mode according to a input picture.	* ⁸		
MUTING	Muting on/off	Off	On	
DIMMER	Change the intensity of the button lamps.	NORMAL	DARK	
---	No function	—	—	

*³ Selects which functions in "MARKER" are activated, non-"R-" items or "R-" items (☞ "MARKER" on page 13 to 14).

*⁴ Displays the information shown when INPUT SELECT button of the current input is pressed (☞ "On the Status Display" on page 11). While controlling with the MAKE system, the information is displayed only at the moment of short-circuiting.

*⁵ While controlling with the MAKE system, the level meter is switched between displayed (short-circuiting) and hidden (opening). When "LEVEL METER ch" is set to "OFF," the level meter is not displayed ("NO EFFECT" appears).
While controlling with the TRIGGER system, the pattern of the audio channel display is switched.

*⁶ While controlling with the MAKE system, the available set-up options will be the setting value currently selected in "SOURCE ID" ("ON" or "AUTO" [short-circuiting]) and "OFF" (opening). While controlling with the TRIGGER system, uses the same set-up option as those in the SET-UP MENU (☞ "SOURCE ID" in "INFORMATION" on page 17).

*⁷ While controlling with the MAKE system, the screen is switched between normal screen (opening) and blue screen (short-circuiting). While controlling with the TRIGGER system, the screen changes in the same way as when pressing SCREENS CHECK button (☞ 11 on page 10).

*⁸ Must be controlled with the TRIGGER system. The mode changes in the order of "NORMAL" ➔ "CINEMA" ➔ "FIELD." (This function cannot be controlled with the MAKE system.)

- You cannot assign the same function to different pin terminals.
- The TRIGGER system switches each function by short-circuiting the pin terminal for about 1 second and opening it.

External Control (cont.)

■ Using the serial communication

You can control the monitor from a personal computer etc. via the RS-485 or RS-232C terminal.

- Consult your dealer for the details of the external control specification.

<Communication specifications>

Input terminal	Cable	Terminal specification	Communication specifications
RS-485	A straight LAN cable	☞ See below	Baud Rate: 4800 bps Data Bits: 8 bits Parity: No parity Stop Bits: 1 bit Flow Control: No control Communication Code: ASCII Code
RS-232C	A straight cable with a D-sub 9-pin connector (male for the monitor, female for the personal computer etc.)		

<Specifications of the RS-485 terminal>

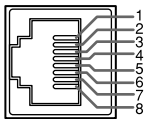

This is a female terminal.

Pin No.	IN terminal signal	OUT terminal signal
1	TXD +	TXD +
2	TXD -	TXD -
3	RXD +	RXD +
4	NC	NC
5	NC	NC
6	RXD -	RXD -
7	NC	NC
8	GND	GND

<Specifications of the RS-232C terminal>

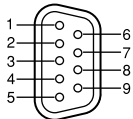

This is a female terminal.

Pin No.	Signal
1	NC
2	RXD
3	TXD
4	NC
5	GND
6	NC
7	RTS
8	CTS
9	NC

- The 7th terminal and the 8th terminal are connected.

<Command outline>

All commands consist of the following segments.

Header	Monitor ID	Command ID	Function	Data	Cr (0Dh)
--------	------------	------------	----------	------	----------

On Header

"!": Operation commands from the personal computer, etc. (☞ <Basic command list> on page 21).

"?": Reference commands from the personal computer, etc.

"@": Status returns from the monitor

To start communication, send the connection command from the personal computer etc.

To terminate the communication, send the termination command from the personal computer etc.

Example of communication procedures

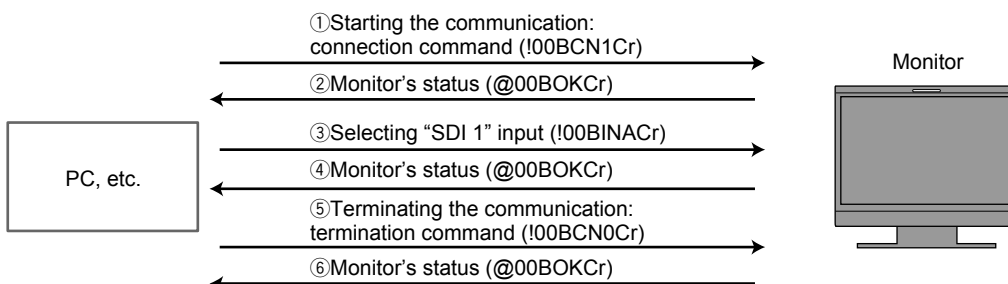

<Basic command list>

No.	Commands	Functions	Data
1	! * **1 B C N 1 Cr	Starts communication (connection)	No data
2	! * **1 B C N 0 Cr	Terminates communication (termination)	No data
3	! * **1 B I D S E T x x*2 Cr	Assigns the control ID	01 – 99
4	! * **1 B I D R E T Cr	Initializes the control ID	No data
5	! * **1 B I D D S P x x*2 Cr	Displays/hides the ID	00: Hide, 01: Display
6	! * **1 B I D C H K x x*2 Cr	Flashes/hides the selected ID No. of the monitor	00: Hide, 01: Display
7	! * **1 B M E N U Cr	Displays the MAIN MENU/Quits the menu operation	No data
8	! * **1 B U P Cr	Moves the cursor upward (Δ)	No data
9	! * **1 B D O W N Cr	Moves the cursor downward (∇)	No data
10	! * **1 B A D J R Cr	Makes setting/adjustment (▷)	No data
11	! * **1 B A D J L Cr	Makes setting/adjustment (◁)	No data
12	! * **1 B S E T U P Cr	Displays the SET-UP MENU	No data
13	! * **1 B P W 1 Cr	Turns on the monitor	No data
14	! * **1 B P W 0 Cr	Turns off the monitor (on standby)	No data
15	! * **1 B I N A Cr	Selects "SDI 1" input	No data
16	! * **1 B I N B Cr	Selects "SDI 2" input	No data
17	! * **1 B I N C Cr	Selects "DVI" input	No data
18	! * **1 B I N E Cr	Selects "VIDEO 1"(DT-R24L41D)/ "VIDEO"(DT-R17L4D) input	No data
19	! * **1 B I N F Cr	Selects "VIDEO 2" input*3	No data
20	! * **1 B D I S P Cr	Displays the status*4	No data
21	! * **1 B A M U T E x x*2 Cr	Turns muting on/off	00: Off, 01: On
22	! * **1 B A S P x x*2 Cr	Changes the aspect ratio	00: 4:3, 01: 16:9

• "Cr" is 0Dh.

• The commands for starting communication (connection) (No. 1), terminating communication (termination) (No. 2), and turning on the monitor (No. 13) can be used while the monitor is off (on standby).

*1 Enter the monitor's ID for "**." The initial setting of the monitor's ID is "00." When connecting several monitors, "00" is a command for controlling all monitors at once.

*2 Enter the appropriate data to "xx."

*3 DT-R24L41D only

*4 Displays the information shown when the INPUT SELECT button currently lit is pressed (☞ "On the Status Display" on page 11).

Troubleshooting

Solutions to common problems related to the monitor are described here. If none of the solutions presented here solve the problem, unplug the monitor and consult an authorized dealer or service center.

Symptom	Probable cause and corrective action	Page
No power supply	• Press the  / button.	10
	• Firmly insert the AC power plug.	8
	• Turn on the POWER switch on the rear panel.	8
No picture with the power on	• Select the correct input using the INPUT SELECT buttons.	10
	• Connect the signal cable firmly.	8
	• Turn on the power of the connected component and set the output correctly.	—
	• Check whether the input signal format is acceptable on the monitor.	26, 27
No sound	• Adjust the volume level.	10
	• Deactivate the muting function.	10
	• Connect the signal cable firmly.	8
	• Turn on the power of the connected component and set the output correctly.	—
“OTHERS” or “Out of range” appears.	• Check whether the input signal format is acceptable on the monitor.	11, 26, 27
“NO SYNC” appears.	• Select the correct input using the INPUT SELECT buttons.	10
	• Connect the signal cable firmly.	8
	• Turn on the power of the connected component and output video signals. Or, check whether the video output of the component (video output setting of the VCR or graphic board of the computer) is set correctly.	—
Wrong color, no color	• Adjust each picture adjustment knob on the front panel or adjust the items of “PICTURE SUB ADJ.” in the SET-UP MENU. Or, perform “reset” in “PICTURE SUB ADJ.”	10, 15
	• Check whether the setting of COLOR OFF or SCREENS CHECK buttons are appropriate.	10
	• Select the proper color system (“COLOR SYSTEM”) in “FUNCTION SETTING” of the SET-UP MENU.	15
	• Adjust the items of “WHITE BALANCE SET.” in the SET-UP MENU. Or, perform “reset” in “WHITE BALANCE SET.”	16
The picture becomes blurred.	• Adjust the picture contrast or brightness by using the adjustment knobs on the front panel. Or, adjust “CONTRAST” or “BRIGHT” of “PICTURE SUB ADJ.” in the SET-UP MENU.	10, 15
Wrong picture position, wrong picture size.	• Check whether the setting of 1:1 is appropriate.	10
	• Check “ASPECT” and “SD4:3 SIZE” settings in MAIN MENU.	13
	• Check whether the input signal format is acceptable on the monitor.	26, 27
	• Adjust the picture size (H SIZE/V SIZE) or position (H POSITION/V POSITION) of “SIZE/POS. ADJ.” in the SET-UP MENU.	16
Some items do not appear on the menu.	• For some signals, the picture cannot be displayed fully in the effective screen area. There is no sure method to solve this problem.	—
	• The items which are not available for the current input or the current input signal are not displayed on the menu. Change the input or the input signal.	18
Buttons on the monitor do not work.	• The items controlled by the MAKE system do not appear on the menu.	18
	• Set “CONTROL LOCK” in the SET-UP MENU to “OFF.”	17
	• You cannot use the buttons for the items controlled by the MAKE system. Disable the external control.	18, 19

The following are not malfunctions.

- When a still image is displayed for a long time, it may remain indistinctly on the screen after the picture has changed. Though the remaining picture will disappear after a while, there may be a case that it remains for a long period depending on the length of time the still image was displayed for. This is due to the characteristics of the LCD display and is not a malfunction.
- Red spots, blue spots and green spots on the panel surface are a normal characteristic of LCD displays, and not a problem. The LCD display is built with very high precision technology; however, be aware that a few pixels may be missing or constantly lit.
- The following symptoms are problems only when pictures or sounds are not played back normally.
 - A slight electric shock occurs when you touch the monitor.
 - The top and/or rear panel of the monitor becomes hot.
 - The monitor emits a cracking noise.
 - The monitor emits a mechanical noise.

■ Self-check program

This monitor has a self-check function, which allows it to detect malfunctions and alert you. This makes troubleshooting easier. Whenever a problem occurs, one or some of the INPUT SELECT lamps will flash. If this happens, follow the steps below and contact your dealer to resolve the problem.

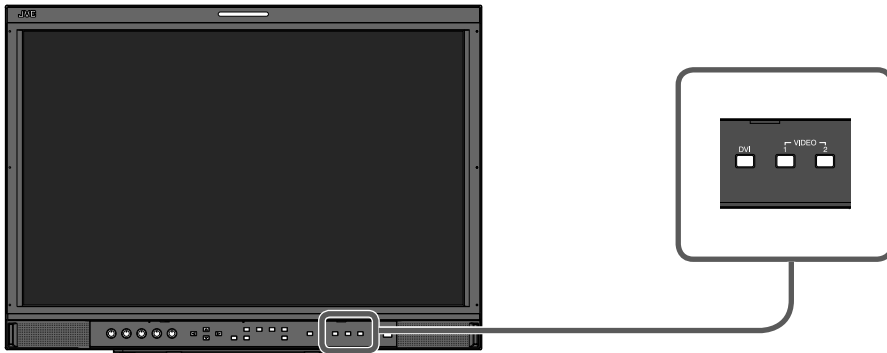

The illustration of the monitor is of DT-R24L41D.

When the screen goes blank, and one or some of the INPUT SELECT lamps (For DT-R24L41D: DVI, VIDEO1, VIDEO2 / For DT-R17L4D: SDI 2, DVI, VIDEO) on the front control panel start flashing...

- 1** Check which lamps are flashing.
- 2** Press \odot / I button to turn off (on standby) the monitor.
- 3** Turn off the power switch on the rear panel.
- 4** Disconnect the AC power cord from the AC outlet.
- 5** Contact your dealer with the information about which lamps were flashing.

- If you turn on the monitor soon after turning it off (or after a short-term power failure), the INPUT SELECT lamps may flash and no image may be displayed.

When this happens, turn off power and wait at least 10 seconds before turning on the monitor again.

If the INPUT SELECT lamps do not flash, you can use the monitor as normal.

Specifications

■ General

Model name	DT-R24L41D	DT-R17L4D
Type	Multi format LCD monitor	
Screen size	Type 24 wide format	Type 17 wide format
Aspect ratio	16:10	16:9
Horizontal/vertical frequency (computer signal)	H: 31.469 kHz – 75.000 kHz V: 48 Hz – 65 Hz * Some signals within this frequency range may not be displayed ("Out of range" is displayed).	
Compliant video signal format	☞ "Available signals" on page 26	
Format	HD SDI: BTA S-004C, SMPTE292M SD SDI: ITU-R BT.656: 525/625 SMPTE259M: 525 EMBEDDED AUDIO: SMPTE299M, SMPTE272M	
Audio output	Internal speaker: 1.0 W + 1.0 W	
Operating conditions	Operating temperature: 5°C – 35°C (41°F – 95°F) Operating humidity: 20% – 80% (non-condensing) (Slightly variable depending on ambient conditions for installation.)	
Power requirements	AC 120 V, 50 Hz/60 Hz	
Rated current	1.15 A	1.2 A
External dimensions (excluding protruding parts)	Width: 564 mm (22 1/4") 564 mm (22 1/4") Height: 413.1 mm (16 3/8") 408 mm (16 1/8") Depth: 181 mm (7 1/4") 99 mm (4") (with the stand) (without the stand)	Width: 430 mm (17") 430 mm (17") Height: 314.1 mm (12 3/8") 309 mm (12 1/4") Depth: 181 mm (7 1/4") 102 mm (4 1/8") (with the stand) (without the stand)
Weight	10.0 kg (22 lbs) (with the stand) 8.5 kg (18.7 lbs) (without the stand)	8.0 kg (17.6 lbs) (with the stand) 6.5 kg (14.3 lbs) (without the stand)
Accessories	AC power cord, Power cord holder x 1, Screw x 2 (for power cord holder)	

■ LCD panel

Model name	DT-R24L41D	DT-R17L4D
Type	24" wide, active matrix TFT	17" wide, active matrix TFT
Effective screen size	Width: 518.4 mm (20 1/2") Height: 324 mm (12 7/8")	Width: 372.9 mm (14 3/4") Height: 209.7 mm (8 3/8")
Number of pixels displayed	1 920 x 1 200	1 366 x 768
Number of colors displayed	16.77 million	
Viewing angle (TYP.)	178° (Horizontally), 178° (Vertically)	178° (Horizontally), 178° (Vertically)
Brightness (TYP.)	400 cd/m ²	350 cd/m ²
Contrast ratio (TYP.)	1000:1	900:1

■ Input/output terminals

Model name	DT-R24L41D	DT-R17L4D		
Video	VIDEO (INPUT 1)	VIDEO	Input/output of composite signal: 2 line, BNC connector x 4, 1 V(p-p), 75 Ω	Input/output of composite signal: 1 line, BNC connector x 2, 1 V(p-p), 75 Ω
	VIDEO (INPUT 2)		* The input (IN) and output (OUT) terminals are bridge-connected (auto termination).	* The input (IN) and output (OUT) terminals are bridge-connected (auto termination).
	DVI-D (HDCP)	DVI-D signal input (compatible with HDCP): DVI-D connector x 1 (compatible with DDC2B)		
	E. AUDIO HD/SD SDI (IN 1)	Digital signal input (compatible with EMBEDDED AUDIO signals): auto detection, 2 line, BNC connector x 2		
	E. AUDIO HD/SD SDI (IN 2)			
E. AUDIO HD/SD SDI (SWITCHED OUT)	Digital signal output (compatible with EMBEDDED AUDIO signals): 1 line switched out, BNC connector x 1			
Audio	AUDIO ASSIGN (IN 1)	AUDIO (IN)	Analog audio signal input: 2 line, RCA connector x 4, 500 mV (rms), high impedance	Analog audio signal input: 1 line, RCA connector x 2, 500 mV (rms), high impedance
	AUDIO ASSIGN (IN 2)			
	AUDIO ASSIGN (MONITOR OUT)	AUDIO (MONITOR OUT)	Analog audio signal output: 1 line, RCA connector x 2, 500 mV (rms)	
External control	REMOTE (MAKE/TRIGGER)	☞ "Using the MAKE/TRIGGER system" on page 18		
	REMOTE (RS-485)	☞ "Using the serial communication" on page 20		
	REMOTE (RS-232C)			

■ Dimensions Unit: mm (inch)

DT-R24L41D

<Front view>

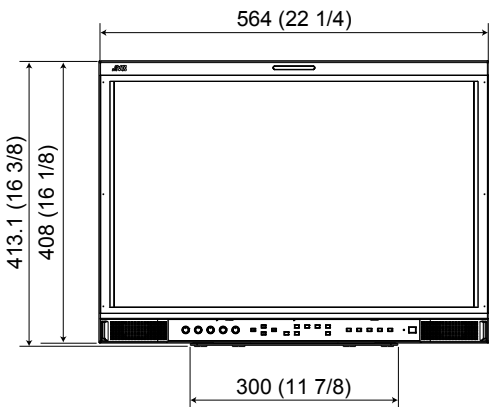

<Side view>

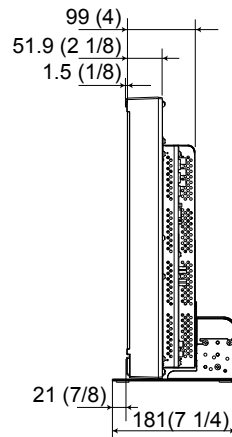

<Rear view>

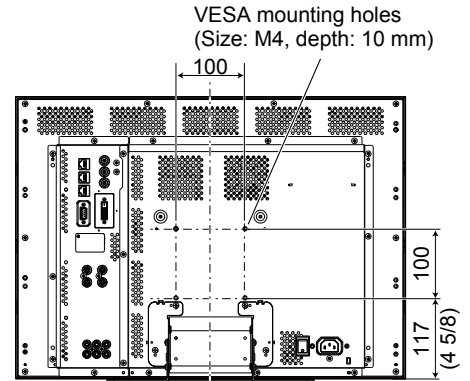

To install the monitor on a shelf

<Top view>

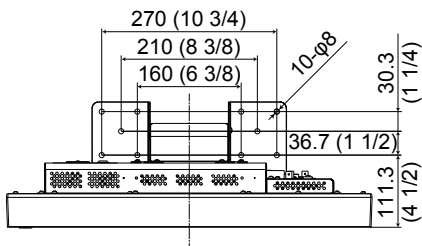

<Side view>

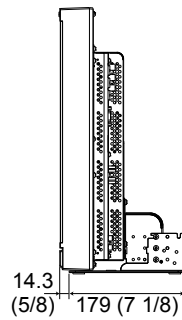

To install the monitor on a wall

<Rear view>

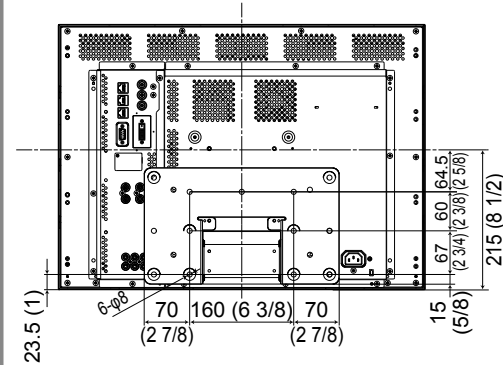

<Side view>

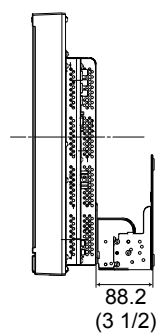

DT-R17L4D

<Front view>

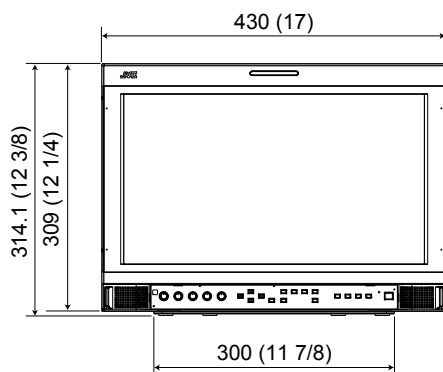

<Side view>

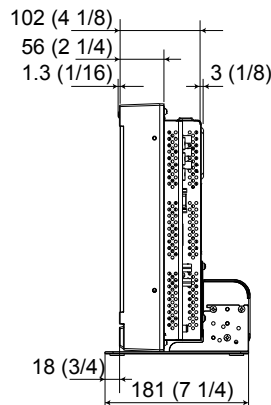

<Rear view>

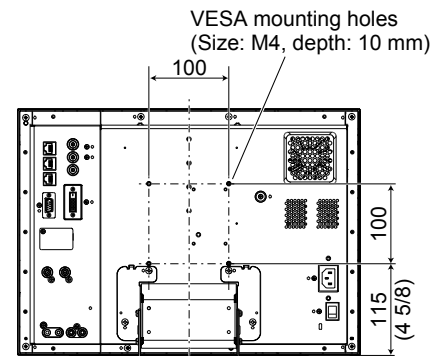

To install the monitor on a shelf

<Top view>

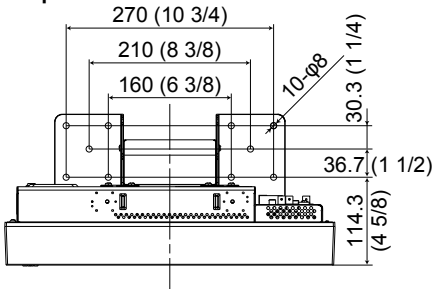

<Side view>

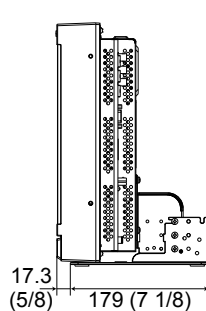

To install the monitor on a wall

<Rear view>

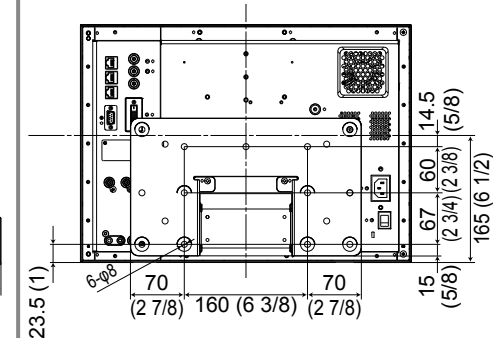

<Side view>

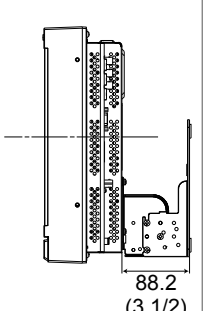

Specifications (cont.)

Available signals

The following signals are available for this monitor.

Video signals

No.	Signal name	Signal format shown in the status display (see page 11)	Input terminal		
			VIDEO (INPUT1, INPUT2)	E. AUDIO HD/SD SDI (IN 1, IN 2)* ¹	DVI-D (HDCP) (Digital component /Digital RGB)
1	NTSC	NTSC	√	—	—
2	PAL	PAL	√	—	—
3	B/W50	B/W50	√	—	—
4	B/W60	B/W60	√	—	—
5	480/60i	480/60i	—	—	—
6	480/59.94i	480/59.94i	—	√	—
7	576/50i	576/50i	—	√	—
8	480/60p	480/60p	—	—	√
9	480/59.94p	480/59.94p	—	—	√
10	576/50p	576/50p	—	—	√
11	640*480/60p	640*480/60p	—	—	√
12	640*480/59.94p	640*480/59.94p	—	—	√
13	720/60p	720/60p	—	√	√
14	720/59.94p	720/59.94p	—	√	√
15	720/50p	720/50p	—	√	√
16	720/30p	720/30p	—	√	—
17	720/29.97p	720/29.97p	—	√	—
18	720/25p	720/25p	—	√	—
19	720/24p	720/24p	—	√	—
20	720/23.98p	720/23.98p	—	√	—
21	1080/60i	1080/60i	—	√	√
22	1080/59.94i	1080/59.94i	—	√	√
23	1035/60i	1035/60i	—	√	√* ²
24	1035/59.94i	1035/59.94i	—	√	√* ³
25	1080/50i	1080/50i	—	√	√
26	1080/60p	1080/60p	—	—	√
27	1080/59.94p	1080/59.94p	—	—	√
28	1080/50p	1080/50p	—	—	√
29	1080/30p	1080/30p	—	√	√
30	1080/29.97p	1080/29.97p	—	√	√
31	1080/25p	1080/25p	—	√	√
32	1080/24p	1080/24p	—	√	√
33	1080/23.98p	1080/23.98p	—	√	√
34	1080/30psF	1080/30psf	—	√* ²	—
35	1080/29.97psF	1080/29.97psf	—	√* ³	—
36	1080/24psF	1080/24psf	—	√	—
37	1080/23.98psF	1080/23.98psf	—	√	—

√: Acceptable

—: Not acceptable

*¹ Compatible with EMBEDDED AUDIO signals.

*² The signal is recognized as 1080/60i, and the status is displayed as "1080/60i."

*³ The signal is recognized as 1080/59.94i, and the status is displayed as "1080/59.94i."

Computer signals (preset)

DVI-D (HDCP) terminals

No.	Signal name	Resolution		Frequency		Scan system
		Horizontal	Vertical	Horizontal (kHz)	Vertical (Hz)	
1	VGA60	640	480	31.5	59.9	Non-interlace
2	WVGA60	852	480	31.5	59.9	Non-interlace
3	SVGA60	800	600	37.9	60.3	Non-interlace
4	XGA60	1024	768	48.4	60.0	Non-interlace
5	WXGA (1280)	1280	768	47.8	60.0	Non-interlace
6	WXGA+60* ⁴	1440	900	55.9	60.0	Non-interlace
7	SXGA60* ⁴	1280	1024	64.0	60.0	Non-interlace
8	WSXGA+60* ⁴	1680	1050	65.2	60.0	Non-interlace
9	UXGA60* ⁴	1600	1200	75.0	60.0	Non-interlace
10	WUXGA60* ⁴	1920	1200	74.0	60.0	Non-interlace
11	720/60p	1280	720	45.0	60.0	Non-interlace
12	1080/60p* ⁴	1920	1080	67.5	60.0	Non-interlace
13	720/50p	1280	720	37.5	50.0	Non-interlace
14	1080/50p* ⁴	1920	1080	56.25	50.0	Non-interlace

⁴ For DT-R17L4D: When No. 6-10, 12 or 14 signals come in, thin lines will become obscured because their signal resolution is higher than the screen resolution.

- Non-preset signals may not be displayed normally even if their frequency is within the acceptable range (refer to "Horizontal/vertical frequency (computer signal)" on page 24).
- When a preset signal comes in, the signal format is shown on the status display. For other signals, the resolution is shown.

Specification of the DVI-D (HDCP) terminal

Connect it to the DVI-D output terminal on a personal computer.

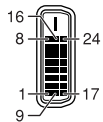

Pin No.	Input signal	Pin No.	Input signal	Pin No.	Input signal
1	T.M.D.S Data 2-	9	T.M.D.S Data 1-	17	T.M.D.S Data 0-
2	T.M.D.S Data 2+	10	T.M.D.S Data 1+	18	T.M.D.S Data 0+
3	T.M.D.S Data 2 shield	11	T.M.D.S Data 1 shield	19	T.M.D.S Data 0 shield
4	NC	12	NC	20	NC
5	NC	13	NC	21	NC
6	DDC Clock	14	+5 V Power	22	T.M.D.S Clock shield
7	DDC Data	15	GND	23	T.M.D.S Clock+
8	NC	16	Hot Plug Detect	24	T.M.D.S Clock-

Notice on transportation

This monitor is precision equipment and needs dedicated packing material for transportation. Never use any packing material supplied from sources other than JVC or JVC-authorized dealers.

- For easy understanding, pictures and illustrations are shown by being emphasized, omitted or composed, and may be slightly different from actual products.
- Design and specifications are subject to change without notice.
- All company names and product names mentioned herein are used for identification purposes only, and may be the trademarks or registered trademarks of their respective companies.



Free Manuals Download Website

<http://myh66.com>

<http://usermanuals.us>

<http://www.somanuals.com>

<http://www.4manuals.cc>

<http://www.manual-lib.com>

<http://www.404manual.com>

<http://www.luxmanual.com>

<http://aubethermostatmanual.com>

Golf course search by state

<http://golfingnear.com>

Email search by domain

<http://emailbydomain.com>

Auto manuals search

<http://auto.somanuals.com>

TV manuals search

<http://tv.somanuals.com>