

JVC

COLOR VIDEO MONITOR

TM-1011G

INSTRUCTIONS

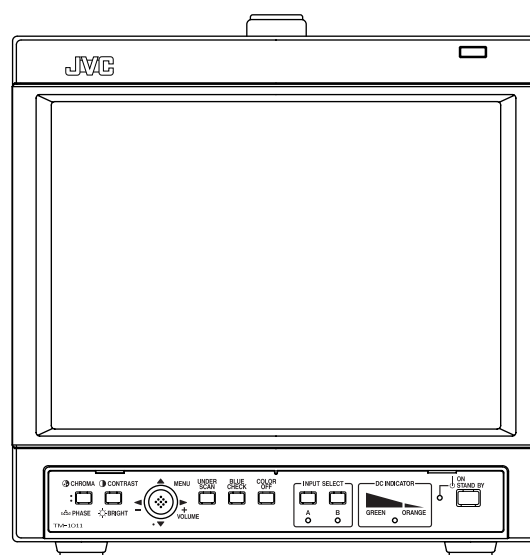

LCT1989-001A-H

Thank you for purchasing this JVC Color Video Monitor. Before using it, read and follow all instructions carefully to take full advantage of the monitor's capabilities.

SAFETY PRECAUTIONS

In order to prevent any fatal accidents caused by misoperation or mishandling of the monitor, be fully aware of all the following precautions.

WARNINGS

To prevent fire or shock hazard, do not expose this monitor to rain or moisture. Dangerous high voltages are present inside the unit. Do not remove the back cover of the cabinet. When servicing the monitor, consult qualified service personnel. Never try to service it yourself.

WARNING : THIS APPARATUS MUST BE EARTHED.

Improper operations, in particular alternation of high voltage or changing the type of tube may result in x-ray emissions of a considerable dose. A unit altered in such a way no longer meets the standards of certification, and must therefore no longer be operated.

This monitor is equipped with a 3-blade grounding-type plug to satisfy FCC rule. If you are unable to insert the plug into the outlet, contact your electrician.

FCC INFORMATION (U.S.A. only)

CAUTION: Changes or modification not approved by JVC could void the user's authority to operate the equipment.

NOTE: This equipment has been tested and found to comply with the limits for a Class B digital device, pursuant to Part 15 of the FCC Rules. These limits are designed to provide reasonable protection against harmful interference in a residential installation. This equipment generates, uses and can radiate radio frequency energy and, if not installed and used in accordance with the instructions, may cause harmful interference to radio communications. However, there is no guarantee that interference will not occur in a particular installation. If this equipment does cause harmful interference to radio or television reception, which can be determined by turning the equipment off and on, the user is encouraged to try to correct the interference by one or more of the following measures:

- Reorient or relocate the receiving antenna.
- Increase the separation between the equipment and receiver.
- Connect the equipment into an outlet on a circuit different from that to which the receiver is connected.
- Consult the dealer or an experienced radio/TV technician for help.

Notice (U.S.A. only)

This product utilizes both a Cathode Ray Tube (CRT) and other components that contain lead. Disposal of these materials may be regulated in your community due to environmental considerations. For disposal or recycling information please contact your local authorities, or the Electronics Industries Alliance: <<http://www.eiae.org>>

■ PRECAUTIONS

- Use only the power source specified on the unit.
 - AC power: 120 V/220-240 V, 50 Hz/60 Hz
 - DC power: 12 V
- Keep flammable material, water, and metal objects away from the unit – especially the interior of the unit.
- This unit incorporates high voltage circuitry. For your own safety and that of your equipment, do not attempt to modify or disassemble this monitor. There are no user-serviceable parts inside.

■ SCREEN BURN

- It is not recommended to keep a certain still image displayed on screen for a long time as well as displaying extremely bright images on screen. This may cause a burning (sticking) phenomenon on the screen of the cathode-ray tube. This problem does not occur as far as displaying normal video playback motion images.

■ HANDLING

- Avoid shocks or vibrations. These may damage the unit and cause it to malfunction.
- Do not block the ventilation slots.
- Do not expose this unit to high temperatures. Extended exposure to direct sunlight or a heater could deform the cabinet or cause the performance of internal components to deteriorate.
- Do not place the unit near appliances generating strong electric or magnetic fields. These can generate picture noise and instability.
- Keep the monitor clean by wiping the cabinet and CRT screen with a soft cloth. Do not apply thinner or benzene. These chemicals can damage the finish and erase printed letters. If the unit is excessively dirty, use a diluted neutral cleanser, then wipe away the cleanser with a dry cloth.

POWER CONNECTION

The power supply voltage rating of this product is AC 120 V (For U.S.A. and Canada only) and AC 220-240 V (For European countries or United Kingdom), the power cord attached conforms to the following power supply voltage and countries. Use only the power cord designated to ensure Safety and EMC regulations of each countries.

Power cord

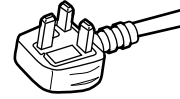
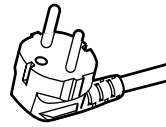
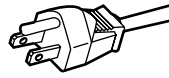

Power supply voltage: AC 120 V
Countries: U.S.A. and Canada

AC 220-240 V
European countries

AC 220-240 V
United Kingdom

Warning:

- Do not use the same Power Cord for AC 120 V as for AC 220-240 V. Doing so may cause malfunction, electric shock or fire.

Note for the United Kingdom power cord only

The plug on the United Kingdom power cord has a built-in fuse. When replacing the fuse, be sure to use only a correctly rated approved type, re-fit the fuse cover.

(Consult your dealer or qualified service personnel.)

How to replace the fuse

Open the fuse compartment with a blade screw driver, and replace the fuse.

(* An example is shown in the illustration.)

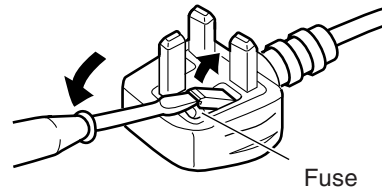

CONTENTS

SAFETY PRECAUTIONS	2
Controls and Features	4
Basic Menu Operations	8
How to Use MAIN MENU	10
How to Use SET-UP MENU	11
How to Use the External Control	14
Troubleshooting	16
Self-check Indications	17
Specifications	18

Controls and Features

Front Panel

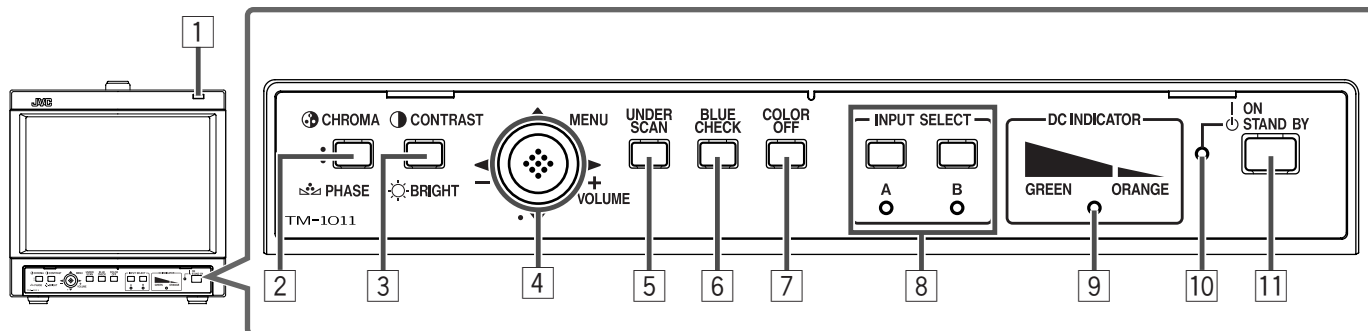

1 Tally lamp

This lamp is controlled by the tally function of the MAKE/TRIGGER terminal.

- ☞ “How to Use the MAKE/TRIGGER Terminal” on pages 14 and 15
- You can set the lamp color to red or green.
 - ☞ “TALLY SELECT” on page 12

2 CHROMA (⊗)/PHASE (⊙) button

Activates the Chroma (picture color density) adjustment mode or the Phase (picture hue) adjustment mode. Each time you press the button, the adjustment modes change. To adjust the value, move the MENU/VOLUME control (4) to </>.

NOTES:

- CHROMA is not adjustable when the B/W (50 Hz/60 Hz) signal is input.
- PHASE is not adjustable when the PAL signal or the B/W (50 Hz/60 Hz) signal is input.

3 CONTRAST (●)/BRIGHT (☀) button

Activates the picture contrast adjustment mode or picture brightness adjustment mode. Each time you press the button, the adjustment modes change. To adjust the value, move the MENU/VOLUME control (4) to </>.

4 MENU/VOLUME control

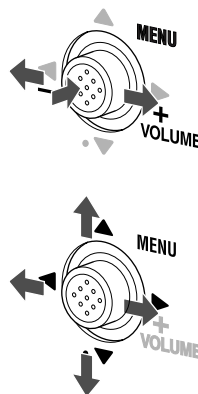

- Adjusts the volume level by moving the control to </>.
- Displays or closes a menu screen by pushing in the control.
- Turns off/on the sound each time moving the control to Δ when no menu screen is displayed.

While a menu screen is displayed, selects or adjusts the menu items by moving the control to Δ/∇/</>.

- ☞ “Basic Menu Operations” on pages 8 and 9

To display the SET-UP MENU:

Press the CHROMA/PHASE button (2) while moving the MENU/VOLUME control to ∇.

5 UNDER SCAN button

Reduces the screen size so that the whole screen is displayed.

6 BLUE CHECK button

Displays the blue video signal only.

7 COLOR OFF button

Displays the luminance signal only.

8 INPUT SELECT buttons/lamps

Select an input to display.

A: Select the video and audio signals input to the VIDEO A and AUDIO A terminals.

B: Select the video and audio signals input to the VIDEO B and AUDIO B terminals.

- The corresponding lamp of the input currently selected lights up.

9 DC INDICATOR lamp

Turns to orange from green when the DC power voltage lowers. When the voltage becomes lower than the certain level, the monitor automatically turns off and the lamp turns to red.

- Make sure to turn off the DC switch on the rear panel before replacing the battery.
- The length of time the lamp lights in orange differs depending on the type of the battery or the battery condition.

It is recommended to replace the battery when the lamp turns to orange.

10 Power lamp

Unlit: The AC or DC switch on the rear panel is off.

Orange: The AC or DC switch on the rear panel is on and the monitor is in stand-by mode.

Green: The monitor is on.

11 Stand-by button

Turns on and off the monitor when the AC or DC switch on the rear panel is on.

NOTE:

- When using the DC power supply, turning on the DC switch on the rear panel puts the monitor in stand-by mode. To turn on the monitor, press the stand-by button.

■ About the status display

Displays information of the current input selection and the monitor settings for about 3 seconds.

To show the status display, set "STATUS DISPLAY" to "AUTO" or "MANUAL" beforehand.

☞ "STATUS DISPLAY" on page 13

Pressing the INPUT SELECT button currently selected shows the status display.

NOTE:

- When "STATUS DISPLAY" is set to "AUTO," the status display also appears on the screen if you change the inputs or the signal condition changes.

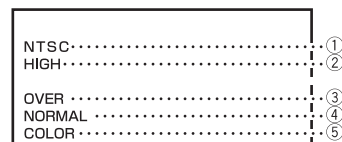

① Signal format

- "NO SYNC" is displayed when no video signal is input.
- "Out of range" is displayed when a noncompliant signal is input.

② Setting of "COLOR TEMP:"

☞ "COLOR TEMP./BAL." on page 12

"*" is displayed if white balance is adjusted in the "COLOR TEMP./BAL." menu.

③ Setting of UNDER SCAN

☞ "[5] UNDER SCAN button" on the left column

OVER: Over-scan

UNDER: Under-scan

④ Setting of BLUE CHECK

☞ "[6] BLUE CHECK button" on the left column

NORMAL: Normal screen

B ONLY: Blue screen

⑤ Setting of COLOR OFF

☞ "[7] COLOR OFF button" on the left column

COLOR: Normal screen

MONO: Monochrome screen

Controls and Features (cont.)

Rear Panel

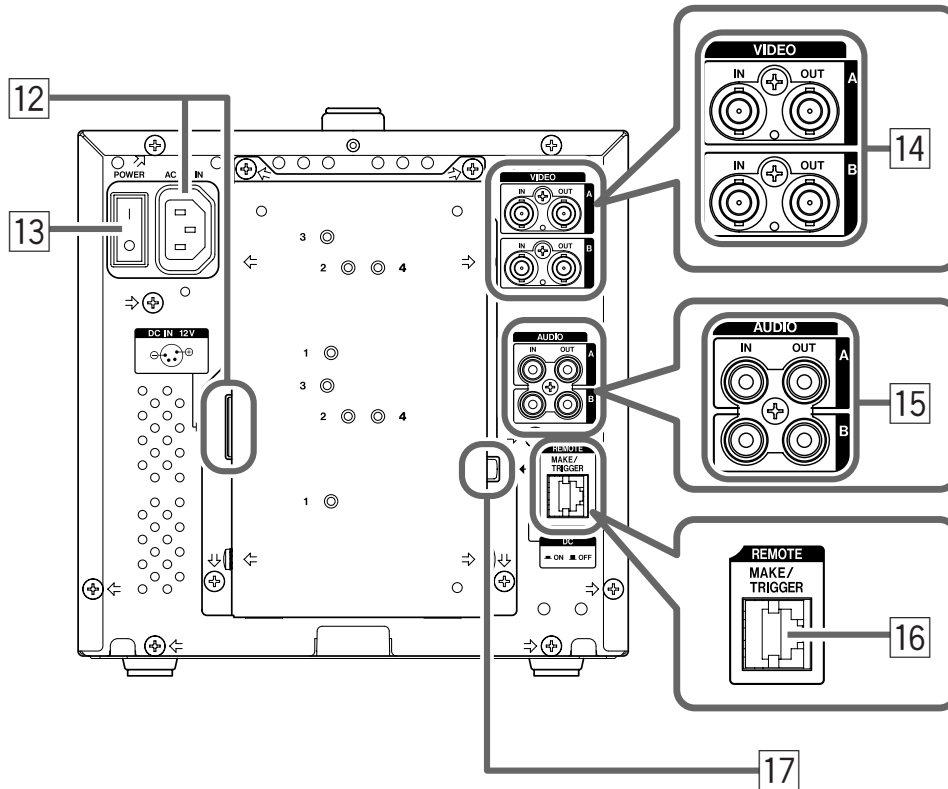

12 Power input connectors

You can use either AC or DC power supply to operate the monitor.

AC IN: Connect to an AC outlet with the provided AC power cord. (AC 120 V/ 220-240 V, 50 Hz/60Hz).

DC IN 12 V: Connect the power cord from the DC power supply (12 V).

NOTES:

- Regarding the DC power supply, consult with your dealer.
- While connecting both the AC and DC power supply...
 - AC power supply is preferentially used.
 - If the AC power supply is cut off (for example, when unplugging the AC power cord), the power supply automatically switches to the DC power supply.

Pin terminals of the DC IN 12 V connector:

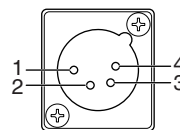

Pin No.	Signal
1	GND
2	—
3	—
4	DC 12V

13 AC power switch

Turns the AC power on and off.

- I : on O : off

NOTE:

- You need to turn on the stand-by button on the front panel to turn on the monitor after turning on the AC power switch.

14 Composite signal input/output terminals (VIDEO A, VIDEO B)

Input (IN) and output (OUT) terminals for the composite signals of the NTSC, PAL, and B/W (50 Hz/60 Hz).

NOTES:

- NTSC and PAL are switched in the "COLOR SYSTEM."
 ☞ "COLOR SYSTEM" on page 12
- The IN and OUT terminals are bridge-connected (auto termination).

15 Analog audio signal input/output terminals (AUDIO A, AUDIO B)

Input (IN) and output (OUT) terminals for the analog audio signals.

NOTE:

- The IN and OUT terminals are bridge-connected.

16 REMOTE (external control) terminals

Terminals for controlling the monitor by an external control.

- ☞ "How to Use the External Control" on pages 14 and 15

17 DC switch

Turns the DC power on and off.

- I : on O : off

NOTES:

- You need to turn on the stand-by button on the front panel to turn on the monitor after turning on the DC switch.
- The monitor consumes the battery even while the monitor is on stand-by. To save battery life, turn off the DC switch on the rear panel.
- While you operate the monitor with the DC power supply, the built-in degaussing circuit does not work. If the monitor has become magnetized, switch the power supply to AC so that the built-in degaussing circuit works or use an external degausser.

Basic Menu Operations

About the Menu Screens

This monitor features MAIN MENU which contains the functions normally used and SET-UP MENU which contains the initial settings of the monitor.

MAIN MENU

Items	Functions
APERTURE CONTROL	Compensates the frequency characteristics of the luminance signal of a video signal.
sub menu SELECT	Selects the positions and the contents of the sub-menu display.
ASPECT	Selects the aspect ratio.

SET-UP MENU

Items	Functions
FUNCTION SETTING	Sets the control systems for the COLOR SYSTEM, colors of the tally lamp, and MAKE/TRIGGER terminal. • Can be also used to check the amount of time that the monitor has been used.
PICTURE SUB ADJ.	The standard value ("00") of the picture adjustment is initially set at the factory. You can adjust the standard value as you want.
COLOR TEMP./BAL.	Sets or adjusts the color temperature and white balance.
SIZE/POSI. ADJ.	Adjusts the size and position of the picture.
DISTORTION ADJ.	Compensates the picture distortion. Also compensates the picture tilt which is caused by geomagnetic influence.
STATUS DISPLAY	Sets the item related to turning on/off the status display.
CONTROL LOCK	Prohibits altering the monitor operations except turning the monitor on/off and deactivating this function. • Operating the monitor by the external control is available if this function is activated.
all reset	Resets all the settings you have made to factory-preset values. • Adjustments made by using the front panel buttons will also be reset.

NOTE:

- Some items do not appear on the menu depending on the signal currently input or if there is no signal input. Those items are not available to use.

Buttons for Menu Operations

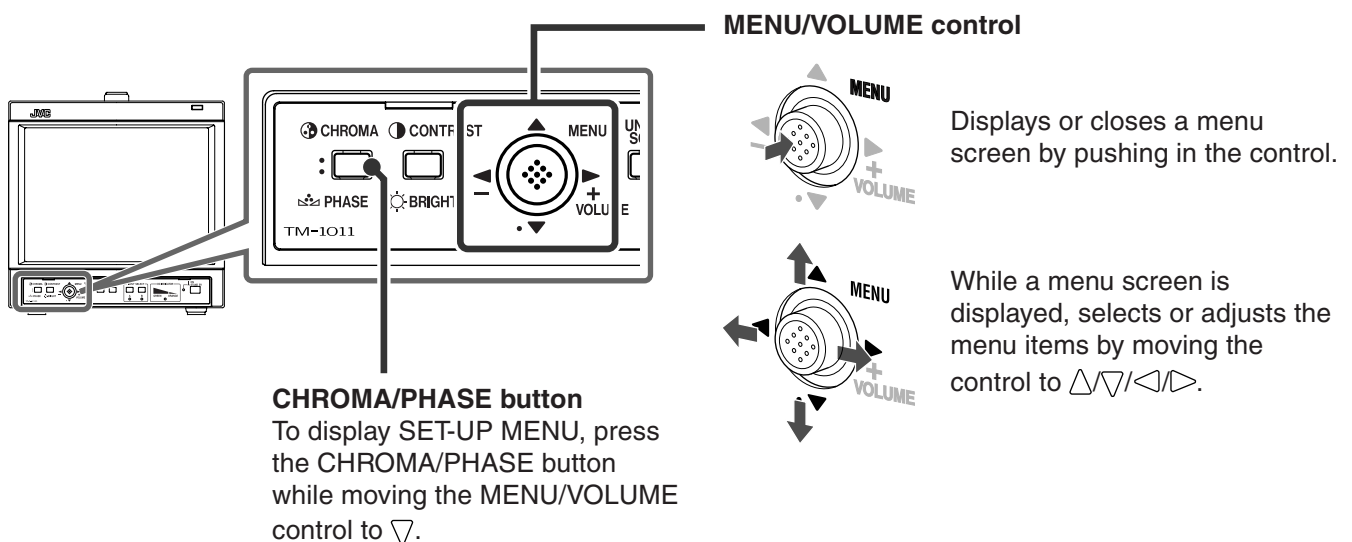

■ Displaying the Menu Screens

To display MAIN MENU

Push in the MENU/VOLUME control on the front panel.

To display SET-UP MENU

Push in the CHROMA/PHASE button while moving the MENU/VOLUME control to ▽.

NOTES:

- To exit the menu, push in the MENU/VOLUME control several times.
- The menu automatically exits about 30 seconds after the last menu operation.
- To go back to the previous menu, push in the MENU/VOLUME control.

■ Menu Operation Procedure

1. Push in the MENU/VOLUME control.

MAIN MENU is displayed on the screen.

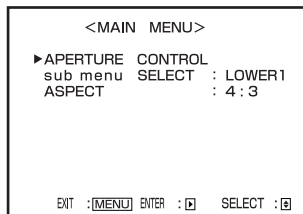

2. Move the MENU/VOLUME control to △ / ▽ to select the item you want to set, then move it to ▷.

The menu screen of the selected item is displayed on the screen.

(Ex.)



3. Move the MENU/VOLUME control to △ / ▽ to select the item you want to adjust.

4. Move the MENU/VOLUME control to ◀ / ▶ to make adjustments.

(Ex.)

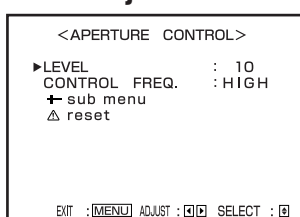

5. Push in the MENU/VOLUME control several times to exit MAIN MENU.

■ About “+ sub menu”

When “+ sub menu” is displayed in the menu, only selected item in that menu can be displayed and adjusted. This allows you to make adjustments while looking at the actual screen.

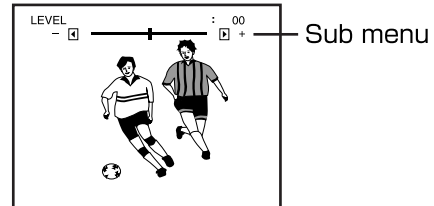

1. Select “+ sub menu,” then move the MENU/VOLUME control to ▷.

The adjustment bar is displayed at the bottom or top of the screen.

2. Move the MENU/VOLUME control to △ / ▽ to select the item you want to set.

3. Move the MENU/VOLUME control to ◀ / ▶ to make adjustments.

To exit the sub-menu display:

Push in the MENU/VOLUME control.

To change the positions and the contents of the sub-menu display

Select “sub menu SELECT” in MAIN MENU, then change the setting by moving the MENU/VOLUME control to ◀ / ▶.

UPPER1: The current setting and adjustment bar of the selected item appear at the top of the screen.

LOWER2: The current setting of the selected item appears at the bottom of the screen.

UPPER2: The current setting of the selected item appears at the top of the screen.

LOWER1: The current setting and adjustment bar of the selected item appear at the bottom of the screen.

■ About “reset”

Restores all menu settings (currently displayed) to factory-preset values.

1. Move the MENU/VOLUME control to △ / ▽ to select “reset,” then move it to ▷.

Confirmation message is displayed.

2. To initialize, move the MENU/VOLUME control to ▷.

- To cancel the initialization, push in the MENU/VOLUME control.

NOTE:

- This function is only available when “reset” is displayed in the menu.

How to Use MAIN MENU

MAIN MENU Screens

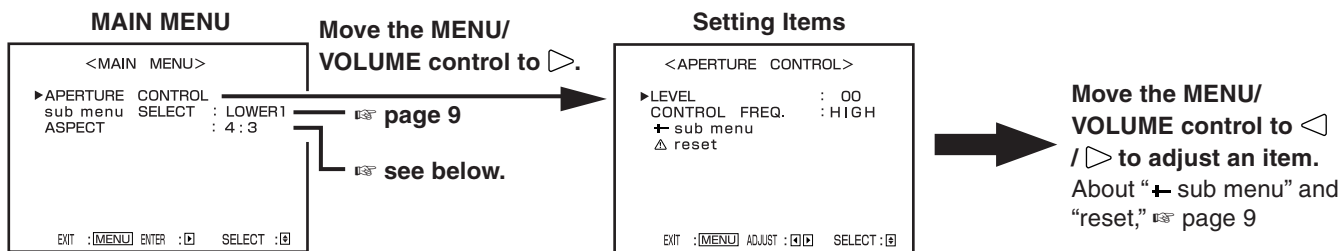

* To go back to the previous menu,
press the MENU/VOLUME control.

NOTE:

- Some items do not appear on the menu depending on the signal currently input or if there is no signal input. Those items are not available to use.

Functions and Adjustment Range of Items

APERTURE CONTROL

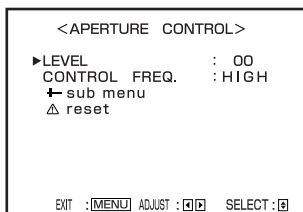

Compensates the frequency characteristics of the luminance signal of a video signal.

sub menu SELECT

Selects the positions and the contents of the sub-menu display.

☞ "To change the positions and the contents of the sub-menu display" on page 9

ASPECT

Selects the aspect ratio.

- 4:3/16:9

LEVEL

Adjusts the compensation value. The higher the number is, the larger the compensation value gets.

- 00 ~ 10

CONTROL FREQ.

Selects the frequency to compensate.

- HIGH:** Compensates the high frequencies.
- LOW:** Compensates the low frequencies.
- OFF:** No compensation.

How to Use SET-UP MENU

SET-UP MENU Screens

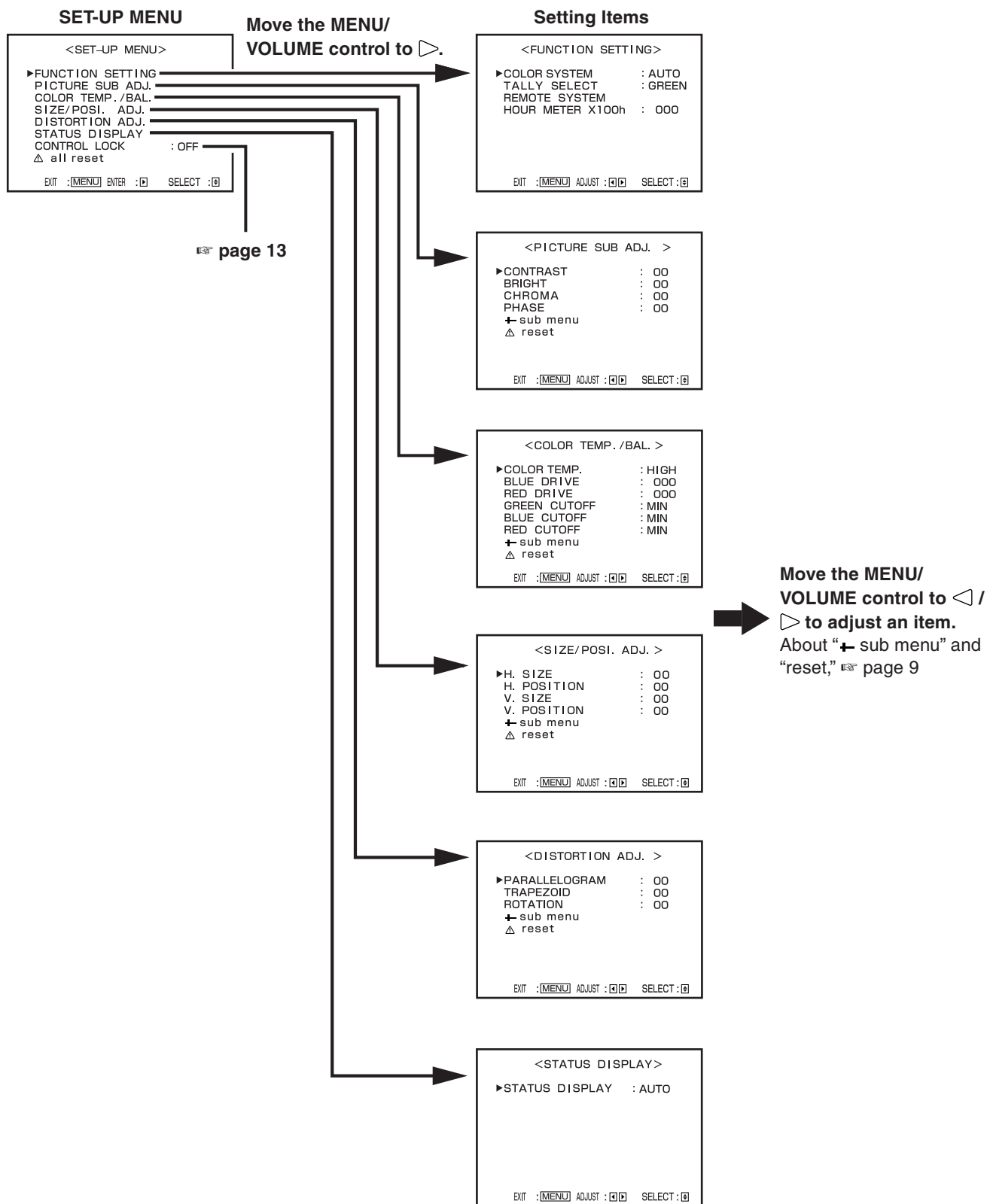

* To go back to the previous menu, press the MENU/VOLUME control.

NOTE:

- Some items do not appear on the menu depending on the signal currently input or if there is no signal input. Those items are not available to use.

How to Use SET-UP MENU (cont.)

Functions and Adjustment Range of Items

FUNCTION SETTING

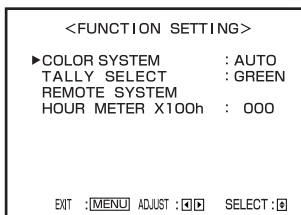

Sets the control systems for the COLOR SYSTEM, colors of the tally lamp, and MAKE/TRIGGER terminal.

- Can be also used to check the amount of time that the monitor has been used.

■ COLOR SYSTEM

Selects the color system.

- AUTO:** Changes NTSC and PAL automatically.
- NTSC:** Keeps the color system NTSC.
- PAL:** Keeps the color system PAL.

NOTE:

- Normally select "AUTO." However, if the input signal is unstable, select "NTSC" or "PAL."

■ TALLY SELECT

Selects the color of the tally lamp on the upper right of the front panel.

- GREEN:** The tally lamp lights in green.
- RED:** The tally lamp lights in red.

NOTES:

- "TALLY SELECT" does not appear on the menu when both of the following conditions are applied:
 - When selecting "TA. SEL" to a pin terminal of the MAKE/TRIGGER terminal in "REMOTE SYSTEM" of SET-UP MENU.
 - When the external control is activated.
- The tally lamp is controlled using the MAKE/TRIGGER terminal of the REMOTE (external control) terminals.
- ☞ "REMOTE SYSTEM" below, "How to Use the External Control" on pages 14 and 15

■ REMOTE SYSTEM

Sets the MAKE/TRIGGER terminal.

- ☞ "How to Use the MAKE/TRIGGER Terminal" on pages 14 and 15

• CONTROL FORM:

Selects the control system for the MAKE/TRIGGER terminal.

- MAKE:** Selects the make contact system as the external control method.
- TRIG.:** Selects the trigger system as the external control method.
- SET:** You can apply the functions to the 1st to 6th pin terminals of the MAKE/TRIGGER terminal as you want.

• PORT F1 – PORT F6:

Selects the function to be applied to the 1st to 6th pin terminals of the MAKE/TRIGGER terminal.

- ☞ "How to Use the MAKE/TRIGGER Terminal" on page 14

NOTE:

- You can set "PORT F1" – "PORT F6" only when "CONTROL FORM" is set to "SET."

■ HOUR METER X100h

Displays the total usage time of the monitor in hundred-hour units.

- 000 ⇄ 655

NOTES:

- When the timer passes 655, it returns to 000.
- The timer does not count usage time under one hour.

PICTURE SUB ADJ.

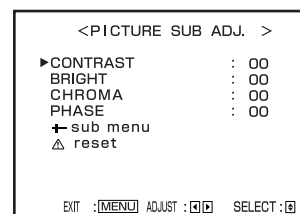

The standard value ("00") of the picture adjustment is initially set at the factory. You can adjust the standard value as you want.

■ CONTRAST

- -20 ⇄ 00 ⇄ +20

■ BRIGHT

- -20 ⇄ 00 ⇄ +20

■ CHROMA

- -20 ⇄ 00 ⇄ +20

■ PHASE

- -20 ⇄ 00 ⇄ +20

COLOR TEMP./BAL.

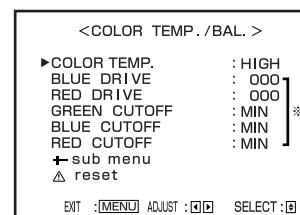

Sets or adjusts the color temperature and white balance.

NOTE:

- Use the five items indicated with ※ mark to make fine adjustments between the monitors.

■ COLOR TEMP.

Selects the color temperature.

- HIGH:** Sets the color temperature to 9300.
- LOW:** Sets the color temperature to 6500.

■ BLUE DRIVE

Adjusts the blue drive level.

- MIN ⇄ 000 ⇄ MAX (in 127 grades)

■ RED DRIVE

Adjusts the red drive level.

- MIN ⇄ 000 ⇄ MAX (in 127 grades)

■ GREEN CUTOFF

Adjusts the green cut-off point.

- MIN ⇄ MAX (in 155 grades)

■ BLUE CUTOFF

Adjusts the blue cut-off point.

- MIN \rightleftarrows MAX (in 155 grades)

■ RED CUTOFF

Adjusts the red cut-off point.

- MIN \rightleftarrows MAX (in 155 grades)

SIZE/POSI. ADJ.

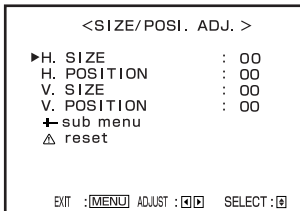

Adjusts the size and position of the picture.

■ H. SIZE

Adjusts the horizontal screen size.

- -20 \rightleftarrows 00 \rightleftarrows +20 (*)

- : Reduces the screen size horizontally.
- +: Enlarges the screen size horizontally.

* You can adjust this item with in the range between 00 and +20 during the under-scan mode.

■ H. POSITION

Adjusts the horizontal screen position.

- -20 \rightleftarrows 00 \rightleftarrows +20

- : Moves the screen to the left.
- +: Moves the screen to the right.

■ V. SIZE

Adjusts the vertical screen size.

- -20 \rightleftarrows 00 \rightleftarrows +20

- : Reduces the screen size vertically.
- +: Enlarges the screen size vertically.

■ V. POSITION

Adjusts the vertical screen position.

- -10 \rightleftarrows 00 \rightleftarrows +10

- : Moves the screen down.
- +: Moves the screen up.

DISTORTION ADJ.

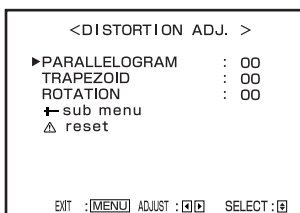

Compensates the picture distortion. Also compensates the picture tilt which is caused by geomagnetic influence.

■ PARALLELOGRAM

Compensates the parallelogram picture distortion.

- -20 \rightleftarrows 00 \rightleftarrows +20

- : Moves the upper side of the picture to the right, and the lower side to the left.
- +: Moves the upper side of the picture to the left, and the lower side to the right.

■ TRAPEZOID

Compensates the trapezoid picture distortion.

- -20 \rightleftarrows 00 \rightleftarrows +20

- : Enlarges the upper side of the picture.
- +: Reduces the upper side of the picture.

■ ROTATION

Compensates a picture tilt.

- -31 \rightleftarrows 00 \rightleftarrows +31

- : Turns the picture clockwise.
- +: Turns the picture counterclockwise.

STATUS DISPLAY

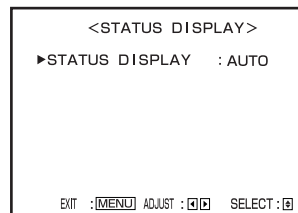

Sets the item related to turning on/off the status display.

■ STATUS DISPLAY

Sets the status display.

- AUTO/MANUAL/OFF

☞ "About the status display" on page 5

CONTROL LOCK

Prohibits altering the monitor operations except turning the monitor on/off and deactivating this function.

- ON/OFF

NOTES:

- When "CONTROL LOCK" is set to "ON,"  "Control lock on!" appears on the screen if you try to operate the monitor.
- Operating the monitor by the external control is available if this function is activated.

all reset

Resets all the settings you have made to factory-preset values.

- Adjustments made by using the front panel buttons will also be reset.

1. Move the MENU/VOLUME control to \triangle / ∇ to select "all reset," then move it to \triangleright . Confirmation message is displayed.
2. To initialize, move the MENU/VOLUME control to \triangleright .
 - To cancel the initialization, press the MENU/VOLUME control.

How to Use the External Control

About the External Control

The Monitor has the MAKE/TRIGGER terminal, which allows you to control the monitor by the MAKE (make contact) or TRIG. (trigger) system selected in the function setting.

MAKE (make contact) system: Controls the function by short-circuiting the corresponding pin terminal to the GND pin terminal, or disconnecting (opening) it.

TRIG. (trigger) system: Controls the function by inputting the pulse signal instantaneously to the corresponding pin terminal.

* Select "MAKE" or "TRIG." from "REMOTE SYSTEM" in SET-UP MENU.

☞ "REMOTE SYSTEM" on page 12

NOTES:

- The external control has priority over operations using front panel buttons or menu functions of the monitor.
- When using the make contact system, you cannot use the functions which are applied to the MAKE/TRIGGER terminal operating the front panel buttons or the menu of the monitor. (When using the trigger system you can also use those functions operating the monitor directly.)

How to Use the MAKE/TRIGGER Terminal

Function of the MAKE/TRIGGER terminal

The following are the configurations and the functions of the pin terminals of the RJ-45 connector. You can change the functions applied to the 1st to 6th pin terminals by setting "REMOTE SYSTEM" of SET-UP MENU.

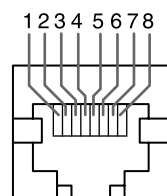

Caution:
This is a female connector.

NO.		Functions to be controlled
1	INP. A	Changes the input to INPUT A
2	INP. B	Changes the input to INPUT B
3	CO. OFF	Turns on/off COLOR OFF
4	ASPECT	Changes ASPECT
5	TALLY	Controls the tally lamp
6	STATUS	Turns on/off the status display
7		External control
8		GND

To change the functions applied to the pin terminals

1. Display SET-UP MENU, then move the MENU/VOLUME control to Δ / ∇ to select "REMOTE SYSTEM," then move it to \triangleright .
2. Move the MENU/VOLUME control to Δ / ∇ to select "CONTROL FORM," then move it to $\triangleleft / \triangleright$ to select "SET."
3. Move the MENU/VOLUME control to Δ / ∇ to select the number of the pin terminal (PORT F1 – PORT F6) you want to set, then move it to $\triangleleft / \triangleright$ to select the function.

NOTE:

- You cannot apply two or more functions to one terminal.

Functions controlled by the MAKE/TRIGGER Terminal

Display	Functions to be controlled	Opening	Short-circuiting	*1
INP. A	Changes the input to INPUT A	Invalid	Valid	
INP. B	Changes the input to INPUT B	Invalid	Valid	
CO. OFF	Turns on/off COLOR OFF	Off	On (Monochrome screen)	*2
ASPECT	Changes ASPECT	4:3	16:9	
TALLY	Controls the tally lamp	Off	On	*3
TA. SEL	Selects the color of the tally lamp	Green	Red	
STATUS	Turns on/off the status display	Off	On	

*1 The TRIG. (trigger) system switches each function by short-circuiting for approx. 1 second.

*2 When selecting the TRIG. (trigger) system, these functions cannot be controlled if no signal is input.

*3 Tally lamp Control and External control (the 7th pin terminal) can be controlled by the MAKE (make contact) system even when you select the "TRIG." (trigger) system.

Operation

- Short-circuit the 7th pin terminal (External control) to the 8th pin terminal (GND) so that the monitor can be controlled by the external control.
- When selecting the "MAKE" (make contact) system**, operate each function by short-circuiting the corresponding pin terminal to the 8th pin terminal (GND) or opening it.
When selecting the "TRIG." (trigger) system, operate each function by Pulse control, that is short-circuiting the corresponding pin terminal to the 8th pin terminal (GND) for about 1 second.

NOTES:

- When controlling INP. A or INP. B, only one terminal must be short-circuited. (Other terminals must be opened.)
- When selecting the "TRIG." (trigger) system, you can operate only one function at a time. Operate the functions one by one.

Troubleshooting

Solutions to common problems related to your monitor are described here. If none of the solutions presented here solve the problem, unplug the monitor and consult a JVC-authorized dealer or service center for assistance.

Problems	Points to be checked	Measures (Remedy)	Reference pages
No power supply	Is the AC or DC power plug loose or disconnected?	Firmly insert the power plug.	—
	When using the DC power supply, is the battery charged?	Charge the battery or replace it with the one charged. (Refer to the instructions of the battery.)	—
	Is the AC or DC switch turned off?	Turn the AC or DC switch on.	6, 7
No picture with the power on	Is the signal cable disconnected?	Connect the signal cable firmly.	6, 7
	Is the power of the connected component on?	Turn on the power of the connected component and set the output correctly.	—
	Is the signal being output from the connected component?		
	Is the input selected correctly?	Select the correct input with the INPUT SELECT buttons.	5
	Is the input signal adapted to the monitor's specification?	Check if the input signal format is acceptable to the monitor.	18
	Are any of the self-check indicators flashing?	Follow the procedures in "Self-check Indications."	17
No sound with the power on	Is the audio signal being output from the connected component?	Turn on the power of the connected component and set the output correctly.	—
	Is the volume level set to minimum or the sound is turned off?	Adjust the volume level or turn on the sound using the MENU/VOLUME control.	4
	Is the audio cable disconnected?	Connect the audio cable firmly.	6, 7
Wrong color	Has the picture adjustment been changed?	Set each picture adjustment to the standard (00) value. Or, perform "reset" in "PICTURE SUB ADJ." to set each item of picture adjustment to the standard value.	4, 12
	Has the white balance setting been changed?	Perform "reset" in "COLOR TEMP./BAL." to set each item to the standard value.	12, 13
	Is the BLUE CHECK function activated?	Press the BLUE CHECK button on the front panel repeatedly to return the screen to normal.	5
Unnatural picture	Has "CONTRAST" or "BRIGHT" been changed?	Adjust CONTRAST or BRIGHT by using the front panel buttons. Or, adjust "CONTRAST" or "BRIGHT" in "PICTURE SUB ADJ." in SET-UP MENU.	4, 12
Shaking picture	Is the monitor close to a motor, transformer or any other device generating a strong magnetic field? (a fan, fluorescent light, laser printer, another monitor, etc.)	Move the monitor away from the device until the picture stops shaking. Connect the power plug to another AC outlet away from the former one.	—
Irregular color	Is the monitor placed or moved close to a speaker or any other magnetic device? Has the position of the monitor been changed with the power on?	Move the device away from the monitor.	—

Problems	Points to be checked	Measures (Remedy)	Reference pages
Wrong picture position, wrong picture size	Has the picture position, size, distortion, or tilt been changed?	Adjust the picture size (H. SIZE, V. SIZE) or position (H. POSITION, V. POSITION) in "SIZE/ POSI. ADJ." Adjust the picture distortion (PARALLELOGRAM, TRAPEZOID) or tilt (ROTATION) in "DISTORTION ADJ." It may not be possible to expand the picture due to the selected input mode. In this case, adjustment is impossible.	13
	Has the UNDER SCAN button been pressed?	Press the UNDER SCAN button to remove the setting.	5
Some items do not appear on the menu	The items which are not available for the current input or the current input signal do not appear on the menu.	Change the input or the input signal.	—
Front panel buttons do not function	Has the CONTROL LOCK function been set to "ON"?	Set the CONTROL LOCK function to "OFF."	13
	Has the monitor's setting been changed to enable control by the external control connected to the REMOTE terminal?	Change the setting of the external control so that the monitor can be operated by the buttons on the front panel.	14, 15

The following are not malfunctions:

- When a bright still image (such as a white cloth) is displayed for a long period, it may appear to be colored. This is due to the structure of the cathode ray tube and will disappear when another image is displayed.
- You may sometimes experience a mild electric shock when you touch the picture tube. This phenomenon is due to a normal buildup of static electricity on the CRT and is not harmful.
- The monitor emits a strange sound when the room temperature changes suddenly. This is only a problem if an abnormality appears on the screen as well.
- If two or more monitors are placed close each other, their images may shake or be distorted. This phenomenon is due to mutual interference; it is not a malfunction. Move the monitors away from each other until the interference disappears or turn the power off on any monitor that is not being used.

Self-check Indications

When the INPUT SELECT A/B and DC INDICATOR lamps on the front panel start flashing after the screen goes blank...

This monitor has a self-check function, which allows it to detect malfunctions and alert you. This makes troubleshooting easier. Whenever a problem occurs, a combination of "self-check indicators" (INPUT SELECT A/B and DC INDICATOR lamps) will flash and the monitor's power automatically turns off. If this happens, follow the steps below and contact your dealer to resolve the problem.

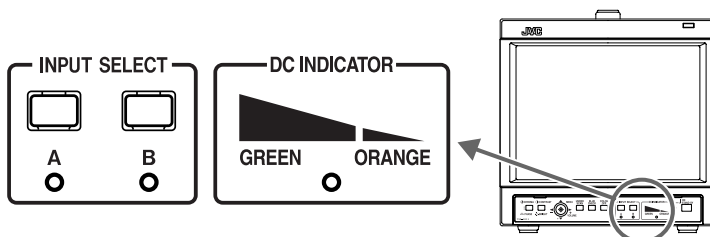

1. Check which indicators are flashing.
2. Turn off the AC or DC switch on the rear panel.
3. When using the AC power supply, unplug the AC power cord.
When using the DC power supply, remove the battery or unplug the DC power cord.
4. Contact your dealer with the information about which indicators are flashing.

NOTE:

- If you turn on the monitor's power immediately after turning it off (or after a short-term power failure), the self-check indicators may flash, and no image may be displayed. When this happens, turn off the power, and wait at least 10 seconds before turning it on again. If the self-check indicators have stopped flashing, you can use the monitor as usual.

Specifications

Model	TM-1011G
Type	Color Video Monitor
Picture Tube	10" measured diagonally
Effective Screen Size	Width: 176.9 mm (6 15/16") Height: 137.6 mm (5 3/8") Diagonal: 224.5 mm (8 13/16")
Scanning Frequency	H: 15 kHz V: 50 Hz/60 Hz
Video Band	6 MHz (-3 dB)
Horizontal Resolution	280 TV lines
Input/Output Terminals	Composite signal input/output terminals VIDEO A/VIDEO B: 2 lines, BNC connector x 4 (1 Vp-p, 75 Ω) * The input (IN) and output (OUT) terminals are bridge-connected. (Auto termination) Analogue audio input/output terminals AUDIO A/AUDIO B: 2 lines, RCA connector x 4 (0.5 V (rms), high impedance) * The input (IN) and output (OUT) terminals are bridge-connected. Remote input terminal MAKE/TRIGGER: Point-of-contact connection, 1 line, RJ-45 connector (8-pin) x 1
Audio output	1 W
Speaker	8 cm (3 1/8") round x 1, 8 Ω
Compliant Video Signal	INPUT A/B: NTSC (3.58 MHz), PAL (4.43 MHz), B/W (50 Hz/60 Hz)
Environmental Conditions	Operating temperature: 0°C – 40°C (32°F – 104°F) Operating humidity: 20% – 80% (non-condensing)
Power Requirements	AC power: 120 V/220-240 V, 50 Hz/60 Hz DC power: 12 V
Power Consumption	0.9 A (AC 120 V)/0.6 A (AC 220-240 V) 4.3 A (DC 12 V)
Dimensions	Width: 222 mm (8 3/4") Height: 229 mm (9 1/8") Depth: 338.3 mm (13 3/8")
Weight	7.8 kg (17.2 lbs)
Accessory	AC power cord

* Illustrations and pictures used in this manual have been exaggerated, abbreviated or compounded for explanatory purposes only.

The appearance of the actual product may differ slightly.

* Dimensions and weight are approximate.

* E. & O.E. Design and specifications subject to change without notice.

■ Dimensions

Unit : mm (inch)

Front View

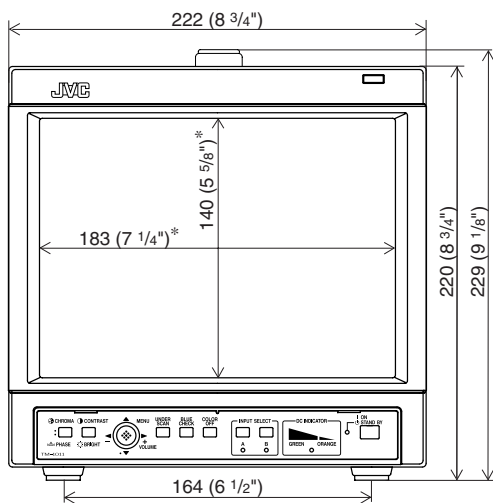

Side View

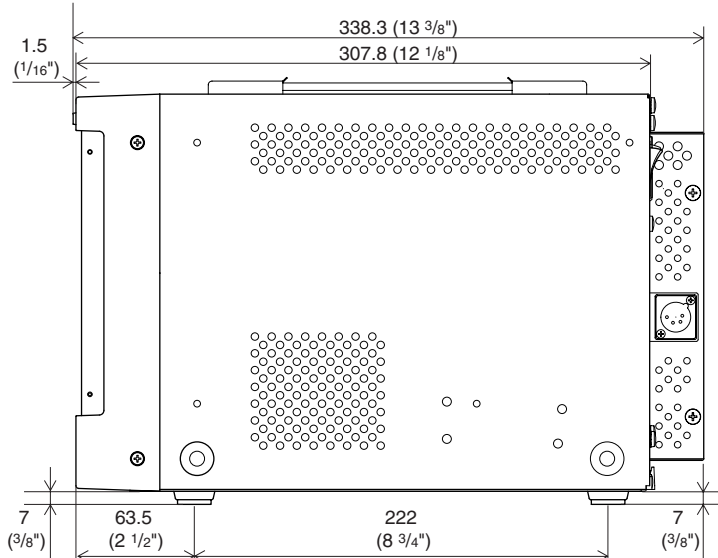

Asterisks (*) are used to indicate front panel dimensions.



Free Manuals Download Website

<http://myh66.com>

<http://usermanuals.us>

<http://www.somanuals.com>

<http://www.4manuals.cc>

<http://www.manual-lib.com>

<http://www.404manual.com>

<http://www.luxmanual.com>

<http://aubethermostatmanual.com>

Golf course search by state

<http://golfingnear.com>

Email search by domain

<http://emailbydomain.com>

Auto manuals search

<http://auto.somanuals.com>

TV manuals search

<http://tv.somanuals.com>