

# JVC<sup>®</sup>

## ***Color Monitor/Receiver Users Guide***

***For Model TM-2003U***



***Illustration of TM-2003U and RM-C205***

### **Important Note:**

In the spaces below, enter the model and serial number of your television (located at the rear of the television cabinet). Staple your sales receipt or invoice to the inside cover of this guide. Keep this user's guide in a convenient place for future reference. Keep the carton and original packaging for future use.

**Model Number:** \_\_\_\_\_

**Serial Number:** \_\_\_\_\_

LCT1420-001A-A  
0303-TN-II-IM

# Important Safety Precautions



## CAUTION

**RISK OF ELECTRICAL SHOCK  
DO NOT OPEN**



**CAUTION:** To reduce the risk of electric shock. Do not remove cover (or back). No user serviceable parts inside. Refer servicing to qualified service personnel.



The lightning flash with arrowhead symbol, within an equilateral triangle is intended to alert the user to the presence of uninsulated "dangerous voltage" within the product's enclosure that may be of sufficient magnitude to constitute a risk of electric shock to persons.



The exclamation point within an equilateral triangle is intended to alert the user to the presence of important operating and maintenance (servicing) instructions in the literature accompanying the appliance.

**WARNING:** TO PREVENT FIRE OR SHOCK HAZARDS, DO NOT EXPOSE THIS TV SET TO RAIN OR MOISTURE.

**CAUTION:** TO INSURE PERSONAL SAFETY, OBSERVE THE FOLLOWING RULES REGARDING THE USE OF THIS UNIT.

1. Operate only from the power source specified on the unit.
2. Avoid damaging the AC plug and power cord.
3. Avoid Improper installation and never position the unit where good ventilation is unattainable.
4. Do not allow objects or liquid into the cabinet openings.
5. In the event of trouble, unplug the unit and call a service technician. Do not attempt to repair it yourself or remove the rear cover.

Changes or modifications not approved by JVC could void the warranty.

- When you don't use this TV set for a long period of time, be sure to disconnect both the power plug from the AC outlet and antenna for your safety.
- To prevent electric shock do not use this polarized plug with an extension cord, receptacle or other outlet unless the blades can be fully inserted to prevent blade exposure.

## IMPORTANT RECYCLING INFORMATION

This product utilizes both a Cathode Ray Tube (CRT) and other components that contain lead. Disposal of these materials may be regulated in your community due to environmental considerations. For disposal or recycling information, please contact your local authorities, or the Electronic Industries Alliance: <http://www.eiae.org>

## Important Safeguards

### CAUTION:

#### Please read and retain for your safety.

Electrical energy can perform many useful functions. This TV set has been engineered and manufactured to assure your personal safety. But **improper use can result in potential electrical shock or fire hazards.** In order not to defeat the safeguards incorporated in this TV set, observe the following basic rules for its installation, use and servicing. Also follow all warnings and instructions marked on your TV set.

### INSTALLATION

- 1 Your TV set is equipped with a polarized AC line plug (one blade of the plug is wider than the other). This safety feature allows the plug to fit into the power outlet only one way. Should you be unable to insert the plug fully into the outlet, try reversing the plug. Should it still fail to fit, contact your electrician.
- 2 Operate the TV set only from a power source as indicated on the TV set or refer to the operating instructions for this information. If you are not sure of the type of power supply to your home, consult your TV set dealer or local power company. For battery operation, refer to the operating instructions.
- 3 Overloaded AC outlets and extension cords are dangerous, and so are frayed power cords and broken plugs. They may result in a shock or fire hazard. Call your service technician for replacement.
- 4 Do not allow anything to rest on or roll over the power cord, and do not place the TV set where power cord is subject to traffic or abuse. This may result in a shock or fire hazard.
- 5 Do not use this TV set near water – for example, near a bathtub, washbowl, kitchen sink, or laundry tub, in a wet basement, or near swimming pool, etc.
- 6 If an outside antenna is connected to the TV set, be sure the antenna system is grounded so as to provide some protection against voltage surges and built-up static charges. Section 810 of the National Electrical Code provides information with respect to proper grounding of the mast and supporting structure, grounding of the lead-in wire to an antenna discharge unit, size of grounding conductors, location of antenna discharge unit, connection requirements for the grounding electrode.

(POLARIZED-TYPE)



- 7 An outside antenna system should not be located in the vicinity of overhead power lines or other electric light or power circuits, or where it can fall into such power lines or circuits. When installing an outside antenna system, extreme care should be taken to keep from touching such power lines or circuits as contact with them might be fatal.

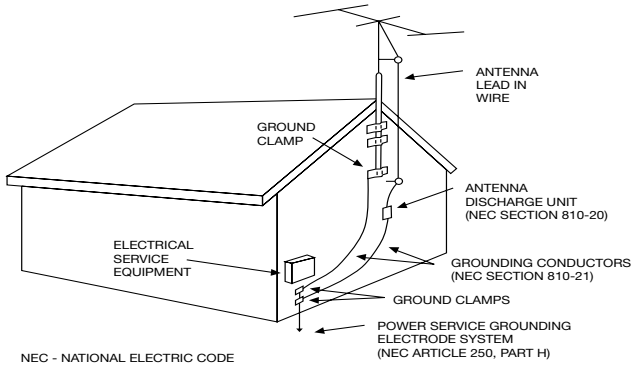

### EXAMPLE OF ANTENNA GROUNDING AS PER NATIONAL ELECTRICAL CODE

- 8 TV sets are provided with ventilation openings in the cabinet to allow heat generated during operation to be released.

**Therefore:**

- Never block the bottom ventilation slots of a portable TV set by placing it on a bed, sofa, rug, etc.
- Never place a TV set in a "built-in" enclosure unless proper ventilation is provided.
- Never cover the openings with a cloth or other material.
- Never place the TV set near or over a radiator or heat register.

- 9 To avoid personal injury:

- Do not place a TV set on a sloping shelf unless properly secured.
- Use only a cart or stand recommended by the TV set manufacturer.
- Do not try to roll a cart with small casters across thresholds or deep pile carpets.
- Wall or shelf mounting should follow the manufacturer's instructions, and should use a mounting kit approved by the manufacturer.

## Use

- 10 Caution children about dropping or pushing objects into the TV set through cabinet openings. Some internal parts carry hazardous voltages and contact can result in a fire or electrical shock.
- 11 Unplug the TV set from the wall outlet before cleaning. Do not use liquid or an aerosol cleaner.
- 12 Never add accessories to a TV set that has not been designed for this purpose. Such additions may result in a hazard.



## PORTABLE CART WARNING (Symbol provided by RETAC)

- 13 For added protection of the TV set during a lightning storm or when the TV set is to be left unattended for an extended period of time, unplug it from the wall outlet and disconnect the antenna. This will prevent damage to product due to lightning storms or power line surges.
- 14 A TV set and cart combination should be moved with care. Quick stops, excessive force, and uneven surfaces may cause the TV set and cart combination to overturn.

## Service

- 15 Unplug this TV set from the wall outlet and refer servicing to qualified service personnel under the following conditions:
  - A. When the power cord or plug is damaged or frayed.
  - B. If liquid has been spilled into the TV set.
  - C. If the TV set has been exposed to rain or water.
  - D. If the TV set does not operate normally by following the operating instructions. Adjust only those controls that are covered in the operating instructions as improper adjustment of other controls may result in damage and will often require extensive work by a qualified technician to restore the TV set to normal operation.
  - E. If the TV set has been dropped or damaged in any way.
  - F. When the TV set exhibits a distinct change in performance — this indicates a need for service.
- 16 Do not attempt to service this TV set yourself as opening or removing covers may expose you to dangerous voltage or other hazards. Refer all servicing to qualified service personnel.
- 17 When replacement parts are required, have the service technician verify in writing that the replacement parts he uses have the same safety characteristics as the original parts. Use of manufacturer's specified replacement parts can prevent fire, shock, or other hazards.
- 18 Upon completion of any service or repairs to this TV set, please ask the service technician to perform the safety check described in the manufacturer's service literature.
- 19 When a TV set reaches the end of its useful life, improper disposal could result in a picture tube implosion. Ask a qualified service technician to dispose of the TV set.
- 20 Note to CATV system installer.

This reminder is provided to call the CATV system installer's attention to Article 820-40 of the NEC that provides guidelines for proper grounding and, in particular, specifies that the cable ground shall be connected to the grounding system of the building, as close to the point of cable entry as practical.

# Table of Contents

## Quick Setup . . . . . 7

Unpacking your TV . . . . .	7
Diagrams . . . . .	8
Remote Control . . . . .	9
Getting Started . . . . .	10
The Remote Control . . . . .	10
Connecting Your Devices . . . . .	11
Auto Tuner Setup . . . . .	15

## Onscreen Menus . . . . . 16

Using the Guide . . . . .	16
---------------------------	----

## Initial Setup . . . . . 17

Auto Tuner Setup . . . . .	17
Channel Summary . . . . .	18
V-Chip . . . . .	19
Set Lock Code . . . . .	26

## Picture Adjust . . . . . 27

Picture Settings . . . . .	27
Adjust Picture Settings . . . . .	27
Noise Muting . . . . .	27
Set Video Status . . . . .	28

## Sound Adjust . . . . . 29

Sound Settings . . . . .	29
Adjust Sound Settings . . . . .	29
MTS (Multi-channel Sound) . . . . .	29
TV Speaker . . . . .	30

## Clock Timers . . . . . 31

Set Clock . . . . .	31
On/Off Timer . . . . .	32

## Initial Setup . . . . . 33

Language . . . . .	33
Closed Caption . . . . .	33
Background . . . . .	34

## Button Functions . . . . . 35

Menu . . . . .	35
Exit . . . . .	35
Display . . . . .	35
Input . . . . .	35
Video Status . . . . .	36
Sleep Timer . . . . .	36
Muting . . . . .	36
VCR Buttons . . . . .	36
Return + . . . . .	37
Power . . . . .	37
Number Buttons - 10key Pad . . . . .	37
Channel +/- . . . . .	37
Volume +/- . . . . .	37
100+ . . . . .	37

## Appendices . . . . . 38

Troubleshooting . . . . .	38
Specifications . . . . .	39

# Quick Setup

# Unpacking Your TV

Thank you for your purchase of a JVC Color Television. Before you begin setting up your new television, please check to make sure you have all of the following items. In addition to this guide, your television box should include:

1 Television

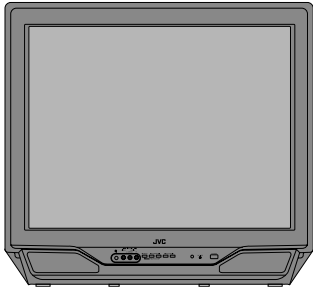

1 Remote Control



Two AA  
Batteries



BNC Connection  
Box

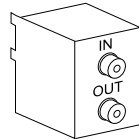

Once you have unpacked your television, the next step is to connect it to your antenna/cable or satellite system and to connect the audio/video devices you want to use with your television. To make these connections you will use plugs like the ones illustrated below.

## Coaxial Cables



Used to connect an external antenna or cable TV system to your TV.

## Component Cables Composite Cables Audio Cables



Used to connect audio/video devices like VCRs, DVD players, stereo amplifiers, game consoles, etc.

We recommend that before you start using your new television, you read your entire User's Guide so you can learn about your new television's many great features. If you're anxious to start using your television right away, a quick setup guide follows on the next few pages.

**NOTE:** Before you connect your television to another device, please refer to the proper diagrams for your specific TV and remote. These will help assist you in understanding how to connect your television to another device, as well as use the remote to set up your television.

## Rear Panel Diagram

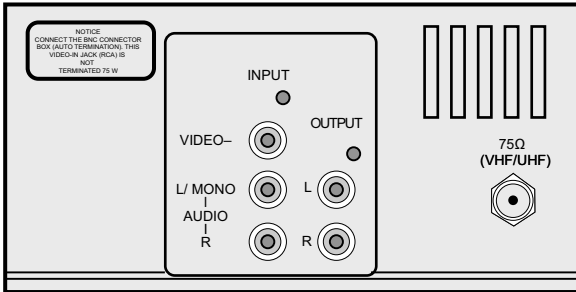

## Front Panel Diagram

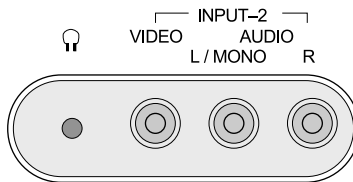



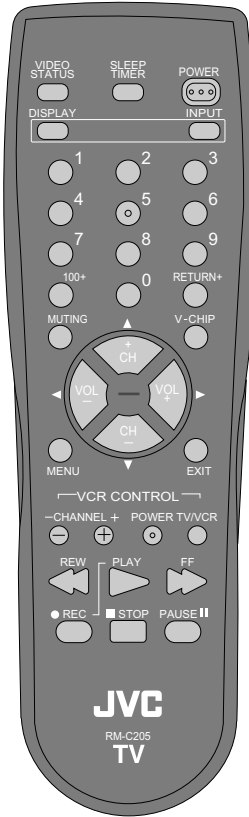

**RM-C205**

- For information on remote control buttons, see pages 35 - 37.

## Getting Started

These quick setup pages will provide you, in three easy steps, with the basic information you need to begin using your new television right away.

If you have questions, or for more detailed information on any of these steps, please consult other sections of this manual.

## Step 1 – The Remote Control

Before you can operate your remote control, you first need to install the batteries (included).

Raise the latch on the remote's back cover to remove. Insert two batteries carefully noting the "+" and "-" markings, placing the "-" end in the unit first. Snap the cover back into place.

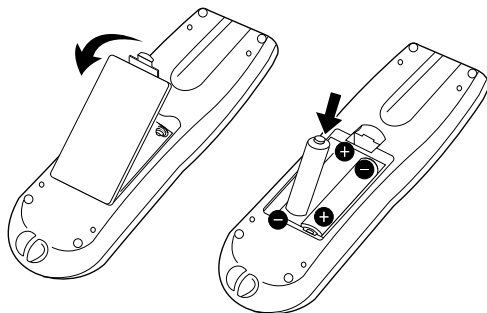

## Key Feature Buttons

The four key feature buttons at the center of the remote can be used for basic operation of the television. The top and bottom buttons will scan forward and back through the available channels. To move rapidly through the channels using JVC's **Hyperscan** feature, press and hold CH+ or CH-. The channels will zip by at a rate of five channels per second. The right and left buttons will turn the volume up or down. These buttons are also marked with four arrows and are used with JVC's onscreen menu system. To use the onscreen menus, press the MENU button.

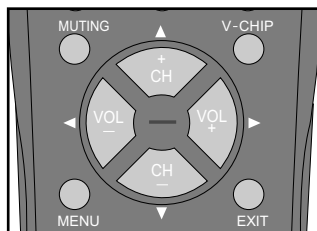

## Basic Operation

Turn the television on and off by pressing the **POWER** button at the top right corner of the remote.

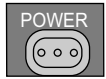

## Step 2 – Connecting Your Devices

Please follow the flow chart below to determine which connection setup is right for you. Then, refer to the appropriate diagrams to connect your television to other devices that you may have. After you are finished connecting your devices, plug the power cord into the nearest power outlet and turn on the TV.

A VCR is not necessary for operation of the television. If you follow these diagrams and the television does not work properly, contact your local cable operator.

- To connect a DVD player, see **Diagram #3**. A DVD player is optional.
- If you have a satellite television system, please refer to the satellite TV manual.

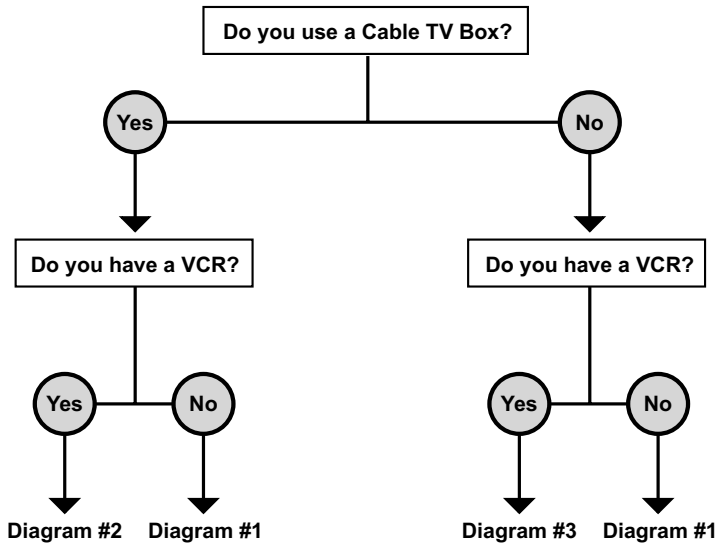

**Diagram #1**

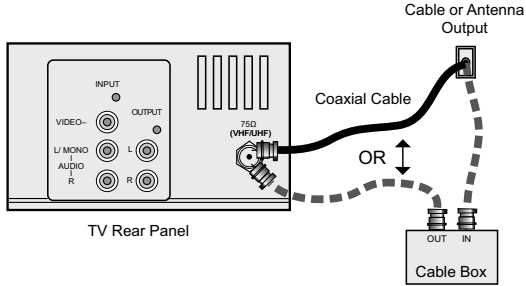

**Note:**

- If you do not have a cable box, connect the cable wire directly from the wall outlet into the back of the TV.

**Diagram #2**

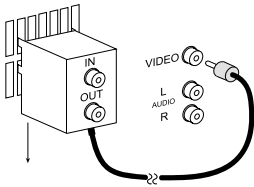

Before connecting any video devices to the Monitor/Receiver, you must connect the BNC Connector Box in order for those devices to work.

- 1) Slide the clips on the back of the BNC connector box into the slots to the left of the jackpack on the back of the television.
- 2) Connect the BNC connector box's yellow video cable to the yellow video input on the TV's rear jack panel.

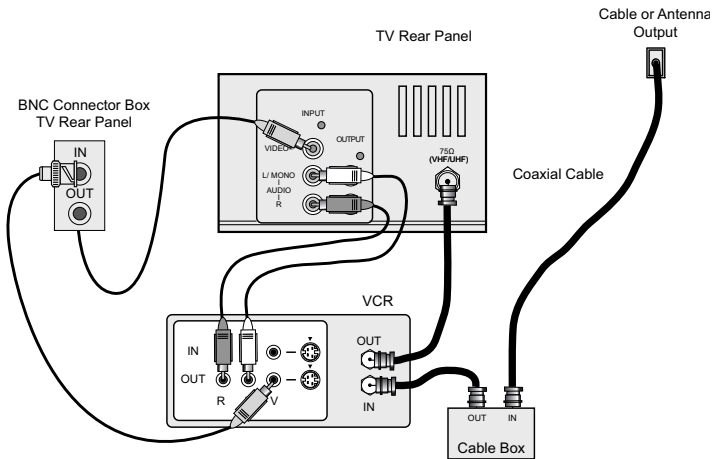

**Notes:**

- You must connect the video cable from the DVD player to the BNC connector box in order for it to work.
- If your VCR is a mono sound unit, it will have only one audio out jack. Connect it to the TV's LEFT AUDIO INPUT.
- Your VCR must be turned on to view premium cable channels.

**Diagram #3**

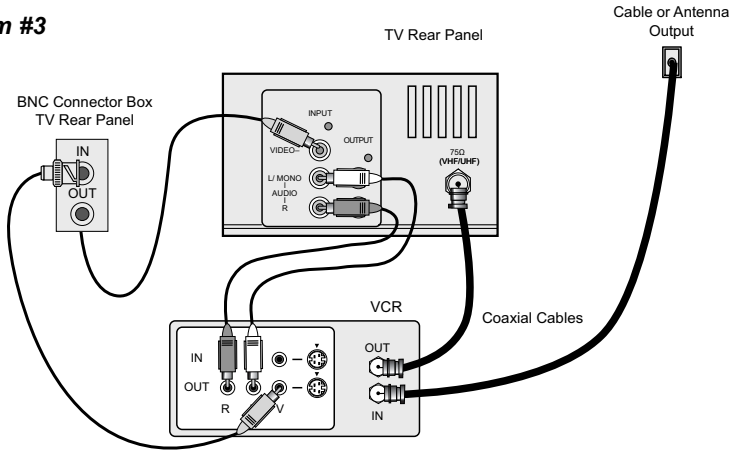

## Connecting to A DVD Player

You can connect a DVD player instead of a VCR as illustrated in Diagram #2 on page 12 or Diagram #3 above.

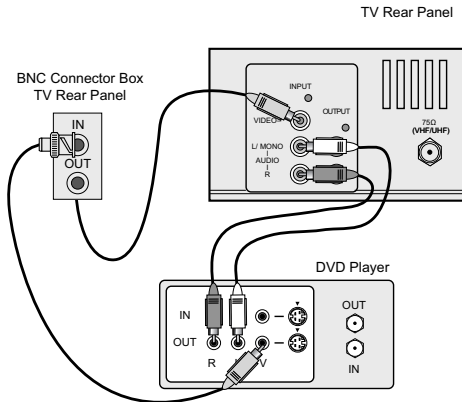

- You must connect the video cable from the DVD player to the BNC connector box in order for it to work.
- Please consult the user's manual for your DVD player for more information on how to hook it up properly.
- Progressive DVD players (players with an output scan of 31.5 KHz) will not work properly with this television. Set your DVD player's output to "interlaced", or non-progressive mode.

## Connecting to an External Amplifier

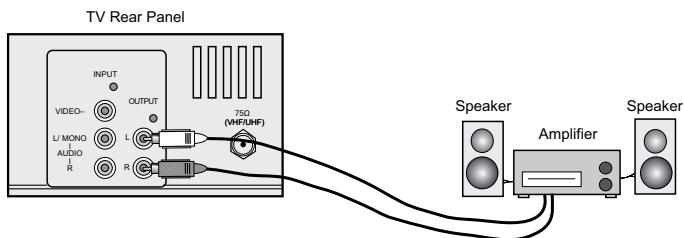

- 1) Connect a white composite cable from the LEFT AUDIO OUTPUT on the back of the TV to the LEFT AUDIO INPUT on the amplifier.
- 2) Connect a red composite cable from the RIGHT AUDIO OUTPUT on the back of the TV to the RIGHT AUDIO INPUT on the amplifier.

### Notes:

- Refer to your amplifier's manual for more information.
- You can use AUDIO OUTPUT for your home theater system.

## Connecting to a Camcorder

You may connect a camcorder, game console or other equipment to your television by using the front input jacks. You can also connect these using the television's rear input jacks, using the same instructions.



- 1) Connect a yellow composite cable from the camcorder VIDEO OUT, into the VIDEO IN on the front of the TV.
- 2) Connect a white composite cable from the camcorder LEFT AUDIO OUT, into the LEFT AUDIO IN on the front of the TV.
- 3) Connect a red composite cable from the camcorder RIGHT AUDIO OUT, into the RIGHT AUDIO IN on the front of the TV.

### Note:

- If your camcorder is a mono sound model it will have only one AUDIO OUT. Connect it to the LEFT AUDIO IN.

## Headphone Connection

You can connect a pair of headphones to the television using the headphone jack located on the front of the TV by plugging headphones into the headphone jack on the TV's front panel.

## Step 3 – Auto Tuner Setup

JVC's onscreen menu system lets you set your television up to meet your own personal viewing preferences. The menu screens and their features are discussed in detail in this book. The menu settings are optional, you can set as many or as few of them as you wish. But to begin watching your television right away you will need to run the Auto Tuner Setup. This lets your television learn the channels it is able to receive. To run the Auto Tuner Setup follow the steps below.



Press the Menu button on the remote control.

Press the ▲▼ buttons to move to AUTO TUNER SETUP

Press the ◀▶ buttons to begin AUTO TUNER SETUP

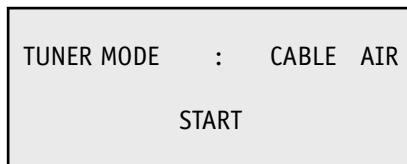

◀▶ To choose CABLE (if you are connected to a cable system) or AIR (if you use an antenna)

▲▼ To move to START

◀▶ To start Auto Tuner Setup

The Auto Tuner will now memorize all of the clear, active channels your television can receive. This will take one or two minutes.



When the setup is finished, PROGRAMMING OVER ! is displayed. Your quick setup is now complete. You can now begin watching your television, or you can continue on in this guide for more information on programming your remote control, or using the JVC onscreen menu system to customize your television viewing experience.

**Cable Box and Satellite Users:** After your auto tuner setup is complete, you may, (depending on the type of hookup), have only 1 channel, usually 3 or 4 in the auto tuner memory. This is normal.



## The Quick Setup is complete

# Onscreen Menus

## Using the Guide

Certain symbols are used throughout this guide to help you learn about the features of your new television. The ones you will see most frequently are:

- ▲▼ Up and Down arrows mean press the CH+ or CH- buttons. Pressing the CH+ or CH- buttons let you:
  - Move vertically in a main menu screen
  - Move through a submenu screen
  - Move to the next letter, number, or other choice in a submenu
  - Back up to correct an error
  - Scan through TV channels (when not in a menu screen)
- ◀▶ Left and right arrows mean press the VOLUME+ or VOLUME- buttons to move left or right to:
  - Select a highlighted menu item
  - Select an item in a submenu
  - Select numbers in certain menu options
  - Turn the volume up or down (when not in a menu screen)



The “press button” icon means you should press the button named on your remote control. (Button names appear in SMALL CAPITAL LETTERS.)

**To bring up the onscreen menu**, press the MENU button on the remote control. The item that appears in yellow is the one currently selected.

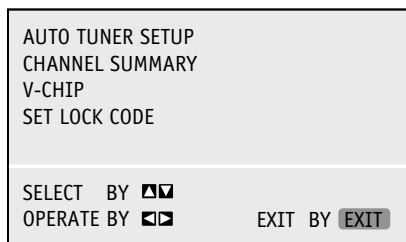

### Notes:

- Menus shown in this book are illustrations, not exact replications of the television's onscreen displays.
- If you do not press any buttons for a few seconds, the onscreen menu will automatically shut off.



# Initial Setup

## Auto Tuner Setup

If you have already run the Auto Tuner as part of the quick setup earlier in this guide, please skip ahead to "Channel Summary" to continue setting up your television.

In Auto Tuner Setup, the TV automatically scans through all available channels, memorizing the active ones and skipping over blank ones or channels with weak signals. This means when you scan (using the CHANNEL +/- buttons) you will receive only clear, active channels.



Press the MENU button



To AUTO TUNER SETUP



To operate



To choose CABLE or AIR



To move to START



To start Auto Tuner Setup



Programming will take approximately  
1 to 2 minutes.



- Noise Muting will not work during Auto Tuner Setup.

### Note:

- Some cable systems experience interference from radio frequencies on cable Channel 95. You may delete this channel from your scan by removing the "X" next to it on the Channel Summary screen shown on the next page.

# Initial Setup

## Channel Summary

Channel Summary allows you to customize the line-up of channels received by your TV. You can add or delete channels from the line-up or prevent any unauthorized viewers from watching any or all 181 channels.



Press the MENU button



To CHANNEL SUMMARY



To operate

The Channel Summary screen (right) will now be displayed with the channels set to scan marked with an "X". You can delete channels from the scan by removing the "X". If any channels were missed during Auto Tuner Setup and you wish to add them, you may by placing an "X" next to the channel number.



To the ADD column



To include or delete from scan



EXIT when finished

You can block access to a channel by activating the Channel Lock.



To CHANNEL SUMMARY



To operate



To the Lock Column



ZERO to lock or unlock that channel



EXIT when finished

CH	ADD		:	CH	ADD	
01	—	—	:	06	—	—
02	X	—	:	07	X	—
03	—	—	:	08	—	—
04	X	—	:	09	X	—
05	X	—	:	10	—	—

SELECT BY

OPERATE BY EXIT BY **EXIT**

## Channel Guard Message

When a viewer attempts to watch a guarded channel, the following message appears:

THIS CHANNEL IS LOCKED BY  
CHANNEL GUARD.  
PLEASE ENTER LOCK CODE BY  
10 KEY PAD TO UNLOCK IT.  
NO. - - - -

To watch a channel that you have locked, enter the Lock Code using the 10 key pad.

If the wrong code is entered, the message "INVALID LOCK CODE!" will flash on the screen:

The channel cannot be accessed until the correct code is entered.

- Once a channel has been unlocked, it will remain unlocked until the television is turned off.
- See also "Set Lock Code", page 26.

# Initial Setup

## V-Chip

Your TV is equipped with V-Chip technology which enables TV Parental Guidelines (for United States and Canada) and Movie (MPAA) Guideline controls. V-Chip technology allows you to program your TV to receive, or not to receive, programs based on content according to the guidelines. Programs which exceed the ratings limits you set will be blocked. When a viewer attempts to watch a blocked channel, this message appears:

The channel will remain blocked until the correct lock code is entered (see page 26 for information on setting your lock code). You can customize the V-Chip settings of your television to match your personal tastes. The V-Chip menu below is the starting point for your V-Chip settings.

THIS PROGRAMMING EXCEEDS  
YOUR RATING LIMITS.  
PLEASE ENTER LOCK CODE BY  
10 KEY PAD TO UNLOCK IT.  
NO. - - - -

You can use US V-Chip settings (for programming broadcast from the United States), Canadian V-Chip settings (for programming broadcast from Canada), and movie ratings. You may use any or all of the settings (US V-Chip, Canada V-Chip, Movie ratings). Descriptions for setting each of the three V-Chip formats appear in the next seven pages along with descriptions of the rating categories.

```
V-CHIP  ON  OFF
SET US TV RATINGS
SET MOVIE RATINGS
SET CANADIAN RATINGS ENG
SET CANADIAN RATINGS FRE
UNRATED  VIEW  BLOCK
                               FINISH

SELECT BY  [ON]
OPERATE BY [OFF]                EXIT BY [EXIT]
```

To access the rating categories:



Press the MENU button



To V-CHIP



To operate (Lock icon  will appear)



Press ZERO to access the V-Chip menu



To turn V-Chip ON or OFF (V-Chip must be turned ON for rating settings to operate)



To move to SET US TV RATINGS, SET MOVIE RATINGS, or SET CANADIAN RATINGS, (see following pages for descriptions of each item).

### Special Note about Ratings

Some programs are not broadcast with a ratings signal. Therefore, even if you setup V-Chip ratings limits, these programs will not be blocked. Parents are cautioned to preview the contents of these programs or movies.

# Initial Setup

## US V-Chip Ratings

### U.S. PARENTAL RATING SYSTEMS

Programs with the following ratings are appropriate for children.

**TV Y is Appropriate for All Children**

Programs are created for very young viewers and should be suitable for all ages, including children ages 2 - 6.

**TV Y7 is for Older Children**

Most parents would find such programs suitable for children 7 and above. These programs may contain some mild fantasy violence or comedic violence, which children should be able to discern from reality.

Programs with the following ratings are designed for the entire audience.

**TV G stands for General Audience**

Most parents would find these programs suitable for all age groups. They contain little or no violence, no strong language, and little or no sexual dialog or situations.

**TV PG Parental Guidance Suggested**

May contain some, but not much, strong language, limited violence, and some suggestive sexual dialog or situations. It is recommended that parents watch these programs first, or with their children.

**TV 14 Parents Strongly Cautioned**

Programs contain some material that may be unsuitable for children under the age of 14 including possible intense violence, sexual situations, strong coarse language, or intensely suggestive dialog. Parents are cautioned against unattended viewing by children under 14.

**TV MA Mature Audiences Only**

These programs are specifically for adults and may be unsuitable for anyone under 17 years of age. TV MA programs may have extensive V, S, L, or D.









### Viewing Guidelines

In addition to the ratings categories explained above, information on specific kinds of content are also supplied with the V-Chip rating. These types of content may also be blocked. The content types are:

- **V/FV** is for VIOLENCE/FANTASY VIOLENCE
- **S** stands for SEXUAL CONTENT
- **L** stands for strong LANGUAGE
- **D** stands for suggestive DIALOG

# Initial Setup

## Setting US V-Chip Ratings





-  Press the MENU button
-  To V-CHIP
-  To operate (lock icon  appears)
-  Press ZERO to access the V-Chip menu
-  To turn V-Chip ON or OFF
-  To move to SET US TV RATINGS
-  To operate





```
V-CHIP  ON  OFF
SET US TV RATINGS
SET MOVIE RATINGS
SET CANADIAN RATINGS ENG
SET CANADIAN RATINGS FRE
UNRATED  VIEW  BLOCK
                               FINISH
SELECT BY  ▲▼
OPERATE BY ◀▶                EXIT BY EXIT
```

## Directions to set US V-Chip Ratings

Line up the cursor in the column (TV PG, TV G, etc.) with the content row (V/FV, S, etc.) and press the ▲ or ▼ to move the cursor to the correct location. Press ◀ or ▶ to turn the locking feature on or off. An item is locked if the  icon appears instead of a “—”.

**For example.** To block viewing of all TV 14 shows, move the cursor to the top row of that column and add a lock icon. Once you've put a lock on the top row, everything in that column is automatically locked.

-  To the TV 14 Column
-  To turn on the lock
-  To FINISH
-  To save settings and exit
-  Press the Exit button when finished

	TV MA	TV 14	TV PG	TV G	TV Y7	TV
V/FV	—		—	—	—	—
S	—		—	—	—	—
L	—		—	—	—	—
D	—		—	—	—	—

FINISH

SELECT BY ▲▼  
OPERATE BY ◀▶ EXIT BY EXIT

### Note:

- If you want to change the setup, move the cursor to the top column and change the lock icon to “—” by pressing ◀ or ▶ again. You may then select individual categories to block.

# Initial Setup

## Setting Ratings with the V-Chip Button

To access Rating information about a certain program, press the V-CHIP button while viewing that program. A display like this will appear:

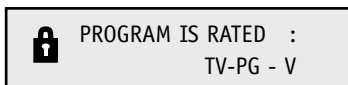

If you decide you want to block this category of viewing, press "0" while the above screen is visible, and all programs from that category will be blocked.

### Example 1:

If you want to set your V-Chip settings to block all programming above TV PG:



Press ZERO when TV-PG is displayed

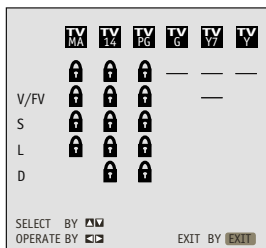

All Programming above TV PG will be blocked.

### Example 2:

If you want to set your V-Chip settings to block all programming above a current setting such as TV PG-V (with violence):



Press ZERO when TV-PG - V is displayed

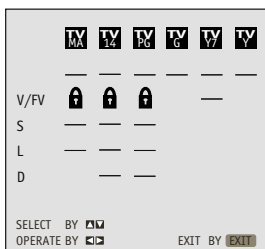

All Programming above TV PG - V (with Violence) will be blocked.

- For Children's programming you can block TV-Y and Y7 programs by Pressing "0" when Y is displayed during a program. Programming for audiences other than children's audiences will not be affected.

## Movies Ratings

### NR – Not Rated

This is a film which has no rating. In many cases these films were imported from countries which do not use the MPAA ratings system. Other NR films may be from amateur producers who didn't intend to have their film widely released.

**NR (Not Rated) Programming may contain all types of programming including children's programming, foreign programs, or adult material.**

### G – General Audience

In the opinion of the review board, these films contain nothing in the way of sexual content, violence, or language that would be unsuitable for audiences of any age.

### PG – Parental Guidance

Parental Guidance means the movie may contain some contents such as mild violence, some brief nudity, and strong language. The contents are not deemed intense.

### PG-13 – Parents Strongly Cautioned

Parents with children under 13 are cautioned that the content of movies with this rating may include more explicit sexual, language, and violence content than movies rated PG.

### R – Restricted

These films contain material that is explicit in nature and is not recommended for unsupervised children under the age of 17.

### NC-17 – No One Under 17

These movies contain content which most parents would feel is too adult for their children to view. Content can consist of strong language, nudity, violence, and suggestive or explicit subject matter.

### X – No One under 18

Inappropriate material for anyone under 18.

## Directions to set Movie (MPAA) Ratings



Press the MENU button



To V-CHIP



To operate (Lock icon  appears)



Press ZERO to access V-Chip setup options



To SET MOVIE RATINGS



To enter movies menu

### For example:

To block viewing of X and NC-17 rated from shows:



To the X Column



To turn on the lock



To the NC-17 Column



To turn on the lock



To FINISH



To save settings and exit

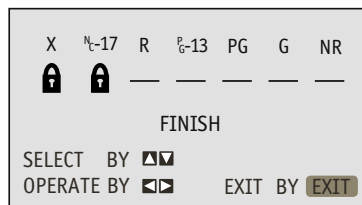

# Initial Setup

## Canadian V-Chip Ratings

### E – Exempt

Exempt programming includes: news, sports, documentaries and other information programming, talk shows, music videos, and variety programming.

### C – Programming Intended for Children

Violence Guidelines: There will be no realistic scenes of violence. Depictions of aggressive behavior will be infrequent and limited to portrayals that are clearly imaginary, comedic or unrealistic in nature.

### C8+ – Programming Intended for Children 8 and Over

Violence Guidelines: Any realistic depictions of violence will be infrequent, discreet, of low intensity and will show the consequences of the acts. There will be no offensive language, nudity or sexual content.

### G – General Audience

Programming will contain little violence and will be sensitive to themes which could affect younger children.

### PG – Parental Guidance

Programming intended for a general audience, but which may not be suitable for younger children. Parents may consider some content not appropriate for children aged 8-13.

### 14+ – 14 Years and Older

Parents are strongly cautioned to exercise discretion in permitting viewing by pre-teens and early teens. Programming may contain mature themes and scenes of intense violence.

### 18+ – Adult

Material intended for mature audiences only.

## Directions to set Canadian V-Chip Ratings



Press the MENU button



To V-CHIP



To operate (lock icon  appears)



Press ZERO to access V-Chip setup options



To SET CANADIAN RATINGS ENG (for English)



To enter ratings menu

### **For example:**

To block viewing of programming rated 14+ and 18+:



To the 18+ Column



To turn on the lock



To the 14+ Column



To turn on the lock



To FINISH



To save settings and exit

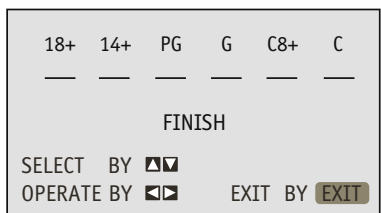



## Unrated Programs

Unrated programming refers to any programming which does not contain a rating signal. Programming on television stations which do not broadcast rating signals will be placed in the "Unrated Programming" category.

Examples of Unrated programs:

- Emergency Bulletins
- News
- Public Service Announcements
- Sports
- Some Commercials
- Locally Originated Programming
- Political Programs
- Religious Programs
- Weather

### Note:

- TV programs or movies that do not have rating signals will be blocked if the unrated category is set to BLOCK.

## Directions to Block Unrated Programs

You can block programs that are not rated.



Press the MENU button



To V-CHIP



To operate (The lock icon  appears)



Press ZERO to access V-Chip setup options



To UNRATED



To VIEW or BLOCK



Press EXIT when done

# Initial Setup

## Set Lock Code

Channel guard and V-Chip settings are protected by a four-digit lock code. Your TV comes pre-set with a lock code of "0000". You may change the code to any four-digit number you wish. To change the lock code, follow the steps below.



Press the MENU button



To SET LOCK CODE



To operate (lock icon  appears)



Press ZERO to access the lock code



The first digit will be highlighted



To select the number



To move to the next digit

Continue to follow these directions for all four numbers



To FINISH



To save settings and exit

(your lock code is now set)

When a viewer attempts to watch a blocked channel, this message appears:

THIS PROGRAM IS LOCKED BY  
CHANNEL GUARD.  
PLEASE ENTER LOCK CODE BY  
10 KEY PAD TO UNLOCK IT.  
NO. - - - -

The channel will remain blocked until the correct lock code is entered (see above for information on setting your lock code).

### Notes:

- After a power interruption you must reset the lock code.
- Write your lock code number down and keep it hidden from potential viewers.
- If you forget the lock code, a new code may be set using the steps listed above.

# Picture Adjust

## Picture Settings

These settings allow you to change and adjust the way the picture appears on your television.

### TINT

Tint allows you to adjust the levels of red and green in your TV picture.

### COLOR

The color function lets you make all the colors in the TV picture appear either more vivid or subtle.

### PICTURE

Picture allows you to adjust the levels of black and white on the TV screen, giving you a darker or brighter picture overall.

### BRIGHT

You can adjust the overall brightness of the TV picture with the Bright control.

### DETAIL

The Detail feature adjusts the level of fine detail displayed in the picture.

## Adjust the Picture Settings



Press the MENU button



To TINT, COLOR, PICTURE, BRIGHT or  
DETAIL



To enter



To adjust the setting



To move to the next setting

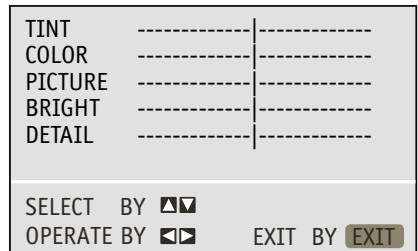

## Noise Muting

This feature inserts a blank blue screen over channels which are not broadcasting or are too weak to be received clearly.



Press the MENU button



To NOISE MUTING



To turn noise muting ON or OFF

### Note:

- Noise muting will not work during auto tuner setup or when you operate channel summary.

# Picture Adjust

## Set Video Status

With Set Video Status, you can save your own set of picture quality adjustments as “Choice” and have access to them at the touch of a button.



Press the MENU button



To SET VIDEO STATUS



To operate



To set the TINT levels



To move to the next option

Repeat these steps until all levels are set.



To SAVE AS CHOICE



To save settings and exit

- You must use SAVE AS CHOICE to exit the Set Video Status menu, otherwise your preferences will not be saved.
- You can access your “Choice” settings at any time by pressing the VIDEO STATUS button on the remote control.

TINT	----- -----
COLOR	----- -----
PICTURE	----- -----
BRIGHT	----- -----
DETAIL	----- -----
SAVE AS CHOICE	
SELECT BY	▲▼
OPERATE BY	◀▶
EXIT BY	EXIT

### Note:

The setting screen will disappear if you do not make any adjustments or move to the next setting in approximately three seconds. Any changes you have made to picture settings up to that point will be stored. You can exit the Picture Settings menu at any time by pressing the EXIT button on the remote control.

# Sound Adjust

## Sound Settings

These settings allow you to change and adjust the sound preferences on your television.

**BASS** – You can increase or decrease the level of low-frequency sound in the TV's audio with the bass adjustment.

**TREBLE** – Use treble to adjust the level of high-frequency sound in your TV's audio.

**BALANCE** – Adjust the level of sound between the TV's left and right speakers with the balance setting.

## Adjust the Sound Settings



Press the **MENU** button



To **BASS**, **TREBLE** or **BALANCE**



To adjust the setting



To move to the next setting



Press the **EXIT** button when finished

## MTS (Multi-Channel Television Sound)

MTS technology allows several audio signals to be broadcast at once, giving you a choice in what you wish to hear with a TV program. In addition to mono or stereo sound, an MTS broadcast may also include a second audio program (SAP).



Press the **MENU** button



To **MTS**



Select the mode

(The **ON AIR** arrow tells you if a broadcast is in stereo and/or contains an SAP).

### Notes:

- Keep the TV in stereo mode to get the best sound quality. The sound will work in stereo mode even if a certain broadcast is in mono sound only.
- Choose the mono setting to reduce excessive noise on a certain channel or broadcast.
- Selecting SAP will allow you to hear an alternative soundtrack, if one is available.

# Sound Adjust

## TV Speaker

If your TV is connected to a stereo system, you can turn off the TV speakers and listen to the audio through your stereo.



Press the MENU button



To TV SPEAKER



To turn the TV's speakers ON or OFF



EXIT when finished

- Before you turn the TV Speaker setting from OFF to ON, **make sure that the TV volume level is low!** If the TV volume is set too high, the sound level will be extremely loud.
- After a power interruption, the TV Speaker settings will return to "ON".

## Set Clock

Before you use any of your TV's timer functions, you must first set the clock. You may precisely set your clock using the XDS time signal broadcast by most public broadcasting stations. If you do not have this in your area, you will have to set the clock manually. See manual clock set below. To set the clock using the XDS signal:



Press the MENU button

▲▼ To SET CLOCK

◀▶ To operate

When you set the clock automatically, choose **AUTO** by pressing the ◀ or ▶ arrows.

▲▼ To TIME ZONE

◀▶ To select your time zone

▲▼ To D.S.T. (daylight savings time)

◀▶ To turn D.S.T. ON or OFF

▼ To FINISH

◀▶ To save settings

MODE	AUTO	MANUAL
TIME ZONE	EASTERN	
D.S.T.	ON	OFF
FINISH		

When you set the clock manually, choose **MANUAL** by pressing the ◀ or ▶ arrows.

▲▼ To move to the hour

◀▶ To set the hour

▲▼ To move to minutes

◀▶ To set the minutes

▼ To START CLOCK

◀▶ To operate

MODE	AUTO	MANUAL
TIME	--:-- --	
START CLOCK		

THANK YOU !!

















### Notes:

- The Daylight Savings Time feature automatically adjusts your TV's clock for Daylight Savings. The clock will move forward one hour at 2:00 am on the first Sunday in April. The clock will move back one hour at 2:00 am on the last Sunday in October.
- You will have to reset the clock after a power interruption. You must set the clock before operating any timer functions.

# Clock/Timers

## On/Off Timer

The on/off timer lets you program your television to turn itself on or off. You can use it as an alarm to wake up, to help you remember important programs, or as a decoy when you're not home.

-  Press the MENU button
-  To ON/OFF TIMER
-  To operate (begins with ON TIME)
-  To set the hour (AM/PM) you want the TV to turn on
-  To move to minutes
-  To set the minutes
-  To accept ON TIME and move to OFF TIME (the time the TV will turn off). Set the OFF TIME the same way as ON TIME
-  To accept OFF TIME and move to CHANNEL
-  To select channel
-  To move to MODE
-  Choose ONCE or EVERYDAY
-  To ON/OFF TIMER
-  Choose YES to accept the timer setting, choose NO if you don't wish to accept
-  To FINISH
-  To save settings
-  Press the EXIT button when finished

### Notes:

- The on/off time cannot be set to locked or guarded channels.
- In order for the on/off timer to work, the clock must be set.
- After a power interruption, the timer settings must be reset.



# Initial Setup

## Language

You can choose to view your onscreen menus in three languages: English, French (Français) or Spanish (Español).



Press the MENU button



To LANGUAGE



To choose a language

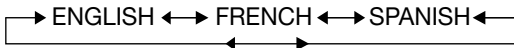

EXIT when finished

## Closed Caption

Many broadcasts now include an onscreen display of dialog called CLOSED CAPTIONS. Some broadcasts may also include displays of additional information in text form. Your television can access and display this information using the CLOSED CAPTION feature. To activate the closed caption feature, follow the steps below.



Press the MENU button



To CLOSED CAPTION



To operate



To select CAPTION, TEXT, or OFF



To move to CAPTION or TEXT



To select a caption (CC1 to CC4) or text channel (T1 to T4)



To accept that selection and move to FINISH



To save settings and exit

MODE	:	TEXT
CAPTION	:	CC1 CC2 CC3 CC4
TEXT	:	T1 T2 T3 T4
FINISH		
SELECT BY	:	▲▼
OPERATE BY	:	◀▶ EXIT

### Notes:

- Closed caption subtitles are usually found on closed caption channel CC1. Some programs may include additional text information which is usually found on text channel T1. The other channels are available for future use.
- Closed captioning may not work correctly if the signal being received is weak or if you are playing a video tape.
- Most broadcasts containing closed captioning will display a notice at the start of the program.

# Initial Setup

## Background

This feature inserts either a black or clear background behind the onscreen menu displays.



Press the MENU button



To BACKGROUND



To turn Set Background to BLACK or CLEAR



EXIT when finished

# Button Functions

## Menu

The MENU button allows you to access JVC's onscreen menu system. Press MENU to activate the onscreen menu system.

- See individual topics like "Sound Adjust" for specific information on using menus.

## Exit

Use this button to enter or exit the TV's onscreen menus.

## Display

The display screen shows the current status of timers and inputs.



Press the DISPLAY button

The screen to the right shows the following information:

- The current channel or AV input (Channel 05)
- The current time (12:20 pm)
- Sleep timer status/minutes remaining (The Sleep Timer is off)
- On/off timer status (Set to turn on everyday at 7:00 PM, off at 10:00 PM)
- Each Press of the DISPLAY button changes the display mode:

05	
NOW	12:20 PM
SLEEP TIMER	OFF
ON/OFF TIMER	EVERYDAY
ON TIME	7:00 PM
OFF TIME	10:00 PM

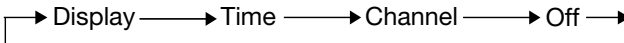

**Display** - Full screen shown above

**Time** - Shows the current time only

**Channel** - Shows the current channel

**Off** - Turns display off

### Notes:

- You may also turn off the display at any step by pressing EXIT.
- If the clock, sleep timer or on/off timer are not set, the display screen will show: "CLOCK NOT SET", "SLEEP TIMER OFF", and "ON/OFF TIMER OFF" respectively.

## Input

Selects the signal input source for the television: TV, for Antenna or Cable; Video 1; or Video 2, for video devices like VCRs, DVD players, or camcorders.



INPUT

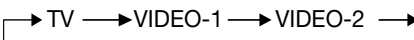

# Button Functions

## Video Status

The video status button gives you a choice of three TV picture display settings, including a display of your own preferences.

**STANDARD** - Resets the picture display to the factory settings.

**CHOICE** - Displays the setting levels you specified on the "Set Video Status" Menu (see page 28).

**GAME** - Used for when you are playing video games connected to your TV.



Press the VIDEO STATUS button

*By every press of the video status button, you change the mode.*



## Sleep Timer

The Sleep Timer can turn the TV off for you after you fall asleep. Program it to work in intervals of 15 minutes, for a total time of up to 180 minutes.



Press the SLEEP TIMER button

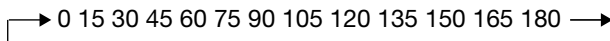

### Sleep Timer Message

20 seconds before the automatic shutoff, this message will appear:

GOOD NIGHT!!  
PUSH SLEEP TIMER BUTTON  
TO EXTEND.

You then have 20 seconds to press the sleep timer button to delay the shut off for another 15 minutes.

## Muting

The muting button instantly turns the volume down completely when you press it. Press **MUTING** and the volume level will instantly go to zero. To restore the volume to its previous level, press **MUTING** again.

## VCR Buttons

You can use your remote control, RM-C205, to operate the basic functions of a JVC brand VCR. These functions include: play, record, rewind, fast-forward, stop, pause, channel scan, TV / VCR, power on, and power off.

# Button Functions

## Return +

The return+ button has two functions:

**Return** - Returns to the channel viewed just before the channel currently onscreen.

**Return+** - Lets you program a specific channel to return to while scanning through the channels using the CH+ and CH- buttons.



RETURN+ and hold for three seconds

RETURN CHANNEL  
PROGRAMMED !

The channel currently active has been programmed as your return+ channel. Now scan through the channels using the CHANNEL+/- buttons.



RETURN+

You will return to your programmed channel.

- To cancel your return+ channel, press and hold the RETURN+ button for three seconds. The message "RETURN CHANNEL CANCELLED!" will appear.
- Return+ works only with the Channel+/- buttons. Pressing any number key will cancel return+.

## Power

Turns the TV on or off.



Press the POWER button

## Number Buttons - 10Key Pad

Use the number buttons on the remote control to move directly to a specific channel. For example, to move to channel 7:



0 (Zero)



7 (Seven)

## Channel +/-

Use these buttons to move up or down all the available channels your TV is able to receive.

## Volume +/-

Use these buttons to raise or lower the TV's volume level.

## 100+ Button

Use the 100+ button to directly access channels above channel 99. For example, to move to channel 124, press 100+, 2 (Two), 4 (Four).

# Troubleshooting

PROBLEMS	CHECK
There is no power	<ul style="list-style-type: none"> <li>• See if the power cord became unplugged.</li> <li>• Check for a blown fuse or circuit breaker or a power outage.</li> </ul>
There is no picture or sound	<ul style="list-style-type: none"> <li>• The antenna could be disconnected.</li> <li>• The input mode could be set improperly. See page 35.</li> <li>• The tuner (Auto Tuner Setup) could be set improperly. See page 17.</li> <li>• The TV station may be having difficulties. Check to see if other stations are working.</li> </ul>
Remote control is not operating properly or at all	<ul style="list-style-type: none"> <li>• Check to see that the batteries are still working and properly installed.</li> <li>• Make sure the remote has a clear sight path to the TV.</li> <li>• You may be too far from the TV. You must be within 23 feet (7 meters).</li> </ul>
You cannot select a certain channel	<ul style="list-style-type: none"> <li>• Make sure the channels have been programmed. See "Channel Summary", page 18.</li> <li>• Check to see if the channel is locked. See "Channel Summary - Lock" page 18.</li> </ul>
The power turns off by itself	<ul style="list-style-type: none"> <li>• Make sure the set did not become unplugged.</li> <li>• Perhaps the On/Off Timer is set. See page 32.</li> <li>• Check to see if the Sleep Timer was set. See page 36.</li> </ul>
The clock is wrong	<ul style="list-style-type: none"> <li>• The power was interrupted and the clock was not reset. See page 31.</li> </ul>
The On Timer is blinking	<ul style="list-style-type: none"> <li>• There is a problem with the TV. Unplug the set and call for service.</li> </ul>
The color quality is poor	<ul style="list-style-type: none"> <li>• Tint and Color may be improperly adjusted. See page 27.</li> <li>• The Video Status mode may be turned to the wrong setting. See page 28.</li> </ul>
There are lines across the picture	<ul style="list-style-type: none"> <li>• There could be interference from another electrical appliance, such as a computer, another TV or VCR. Move any such appliances further away from the TV.</li> </ul>
The picture is spotted	<ul style="list-style-type: none"> <li>• There could be interference from a high-wattage appliance, like a hairdryer or vacuum, operating nearby. Move the antenna away from the appliance or change to a coaxial cable connection which is less prone to interference.</li> </ul>
There are double pictures (ghosts)	<ul style="list-style-type: none"> <li>• A building or passing airplane can reflect the original signal and produce a second, slightly delayed one. Adjust your antenna position.</li> </ul>
Picture is snowy (image noise)	<ul style="list-style-type: none"> <li>• Your antenna may be damaged, disconnected or turned. Check the antenna connection. If the antenna is damaged, replace it.</li> </ul>
Screen is 80% black	<ul style="list-style-type: none"> <li>• The Closed Caption Text mode is on. Turn it off in the Closed Caption Menu, page 33.</li> </ul>
Stereo or bilingual programs can't be heard	<ul style="list-style-type: none"> <li>• Make sure the MTS settings are correct. See "MTS" on page 29.</li> </ul>
There is no sound from the TV's speakers	<ul style="list-style-type: none"> <li>• The TV Speaker option may be turned off. See page 30.</li> </ul>
Static electricity	<ul style="list-style-type: none"> <li>• It is normal to feel static electricity if you brush or touch the screen.</li> </ul>
You hear occasional crackling sounds	<ul style="list-style-type: none"> <li>• It is normal for the TV to make crackling sounds when first turned on or off. Unless the sound or picture become abnormal, this is fine.</li> </ul>
The picture is excessively bright	<ul style="list-style-type: none"> <li>• Make sure the BNC connector box is properly connected to the TV.</li> <li>• The television Video Input Jack (RCA) is not terminated.</li> </ul>

# Specifications

MODEL	TM-2003U
Reception Format	NTSC, BTSC System (Multi-Channel Sound)
Reception Range	VHF 2 to 13, UHF 14 to 69 Sub Mid, Mid, Super, Hyper and Ultra bands (181 channel frequency synthesizer system)
Power Source	AC 120V, 60Hz
Power Consumption	87W / 1.4A
Screen Size	20 inch / 51 cm measured diagonally full square
Audio Output	1W + 1W
Speakers	2 x 3 1/2 / 5x9 cm oval x 2
Antenna Terminal	75 ohms (VHF/UHF) (F-type connector)
External Input Jacks	Video: 1 Vp-p, 75 ohms Audio: 500mVrms (-4dBs) high impedance
Audio Output (FIXED)	500 mVrms (-4 dBs) Low impedance (400 Hz when modulated 100%)
Headphone Jack	Ø3.5 mm x 1
Dimensions (Inch) WxHxD (cm)	19 7/8 x 17 7/8 x 19 1/2 50.3 x 45.2 x 49.3
Weight (lbs / kg)	43.8 / 19.9
Accessories	Remote control unit x 1 / AA batteries x 2 / BNC Connector Box x 1

*Specifications subject to change without notice.*



**JVC PROFESSIONAL PRODUCTS COMPANY**

Division of JVC Americas Corp.

1700 Valley Road

Wayne, New Jersey, 07470

Download from [Www.Somanuals.com](http://www.Somanuals.com). All Manuals Search And Download.



## Free Manuals Download Website

<http://myh66.com>

<http://usermanuals.us>

<http://www.somanuals.com>

<http://www.4manuals.cc>

<http://www.manual-lib.com>

<http://www.404manual.com>

<http://www.luxmanual.com>

<http://aubethermostatmanual.com>

Golf course search by state

<http://golfingnear.com>

Email search by domain

<http://emailbydomain.com>

Auto manuals search

<http://auto.somanuals.com>

TV manuals search

<http://tv.somanuals.com>