



## COLOR VIDEO MONITOR

# TM-A130SU

## INSTRUCTIONS

**For Customer Use:**

Enter below the Serial No. which is located on the rear of the cabinet. Retain this information for future reference.

Model No. : TM-A130SU

Serial No. : \_\_\_\_\_

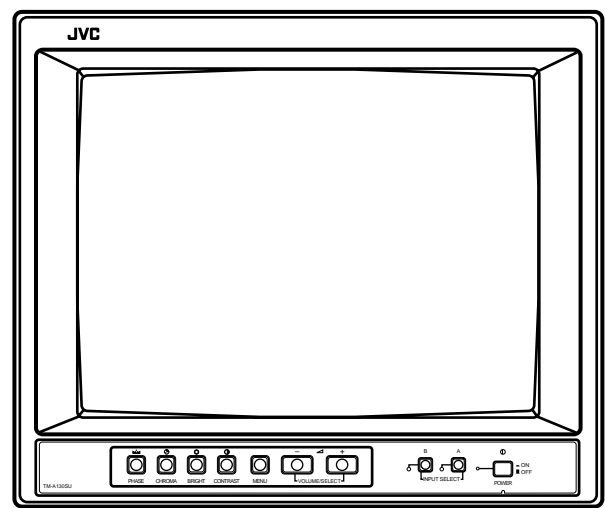

Thank you for purchasing this JVC color video monitor. Before using it, read and follow all instructions carefully to take full advantage of the monitor's capabilities.

## SAFETY PRECAUTIONS

### WARNING :

TO PREVENT FIRE OR SHOCK HAZARDS, DO NOT EXPOSE THIS MONITOR TO RAIN OR MOISTURE.

### CAUTION :

To reduce the risk of electric shock, do not remove cover. Refer servicing to qualified service personnel.

This monitor is equipped with a 3-blade grounding-type plug to satisfy FCC rule. If you are unable to insert the plug into the outlet, contact your electrician.

### FCC INFORMATION (U.S.A. only)

**CAUTION:** Changes or modification not approved by JVC could void the user's authority to operate the equipment.

**NOTE:** This equipment has been tested and found to comply with the limits for a Class B digital device, pursuant to Part 15 of the FCC Rules. These limits are designed to provide reasonable protection against harmful interference in a residential installation. This equipment generates, uses and can radiate radio frequency energy and, if not installed and used in accordance with the instructions, may cause harmful interference to radio communications. However, there is no guarantee that interference will not occur in a particular installation. If this equipment does cause harmful interference to radio or television reception, which can be determined by turning the equipment off and on, the user is encouraged to try to correct the interference by one or more of the following measures:

- Reorient or relocate the receiving antenna.
- Increase the separation between the equipment and receiver.
- Connect the equipment into an outlet on a circuit different from that to which the receiver is connected.
- Consult the dealer or an experienced radio/TV technician for help.

### ■ PRECAUTIONS

- Use only the power source specified on the unit. (120 V AC, 50/60 Hz)
- Keep flammable material, water, and metal objects away from the unit – especially the interior of the unit.
- This unit incorporates high voltage circuitry. For your own safety and that of your equipment, do not attempt to modify or disassemble this monitor. There are no user-serviceable parts inside.
- Unplug the monitor when you're not going to be using it for a long period.

### ■ HANDLING

- Avoid shocks or vibrations. These may damage the unit and cause it to malfunction.
- Do not block the ventilation slots.
- Do not expose this unit to high temperatures. Extended exposure to direct sunlight or a heater could deform the cabinet or cause the performance of internal components to deteriorate.
- Do not place the unit near appliances generating strong electric or magnetic fields. These can generate picture noise and instability.
- Keep the monitor clean by wiping the cabinet and CRT screen with a piece of soft cloth. Do not apply thinner or benzine. These chemicals can damage the finish and erase printed letters. When the unit is excessively dirty, use a diluted neutral cleanser, then wipe away the cleanser with a dry cloth.

### SCREEN BURN

- It is not recommended to keep a certain still image displayed on screen for a long time as well as displaying extremely bright images on screen. This may cause a burning (sticking) phenomenon on the screen of cathode-ray tube. This problem does not occur as far as displaying normal video playback motion images.

# CONTENTS



<b>SAFETY PRECAUTIONS .....</b>	<b>2</b>
<b>CONTROLS AND FEATURES .....</b>	<b>4</b>
<b>HOW TO HANDLE BASIC OPERATIONS .....</b>	<b>6</b>
<b>HOW TO USE THE MENU FUNCTIONS .....</b>	<b>7</b>
<b>HOW TO INITIALIZE THE SETTING .....</b>	<b>10</b>
<b>BASIC CONNECTION EXAMPLE .....</b>	<b>11</b>
<b>TROUBLESHOOTING .....</b>	<b>12</b>
<b>SPECIFICATIONS .....</b>	<b>13</b>

# CONTROLS AND FEATURES

## FRONT VIEW

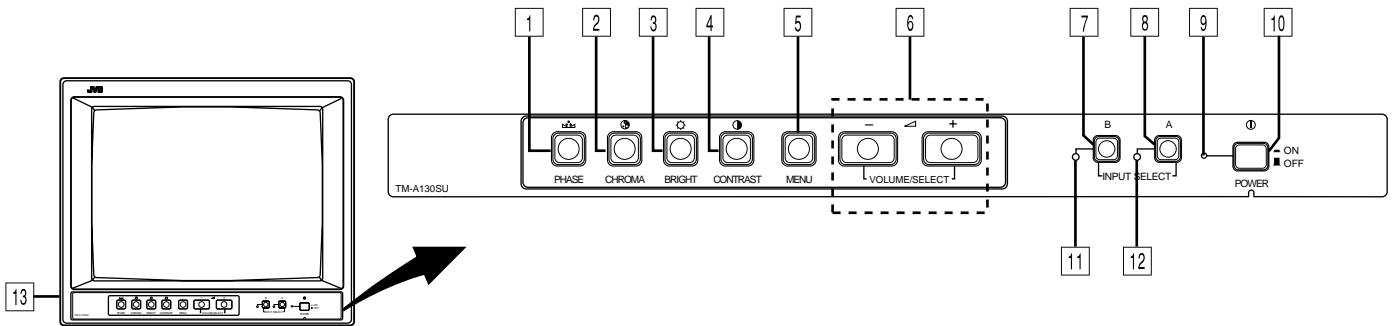
### <Front Panel>



- 1 Phase button [PHASE  +]**  
 Adjusts the speaker volume. Also used as a control button in the menu function mode.
- 7 Input B button [INPUT SELECT B]**  
 Selects the video signal input to the VIDEO B terminal and the audio signal input to the AUDIO B terminal (RCA connector) on the rear panel. When selected, the input B indicator **11** lights.
- 8 Input A button [INPUT SELECT A]**  
 Selects the video signal input to the VIDEO A terminal (BNC connector) and the audio signal input to the AUDIO A terminal (RCA connector) on the rear panel. When selected, the input A indicator **12** lights.
- 9 Power indicator**  
 Lights in green when the power is ON.  
**Lit** : When the power is on.  
**Unlit** : When the power is off.
- 10 Power switch [POWER 

#### Notes:**

- \* The VIDEO B terminals include a video terminal (BNC connector) and a Y/C terminal (mini-DIN 4-pin connector). The Y/C (S-video) terminal is given priority.

# REAR VIEW

## <Rear Panel>

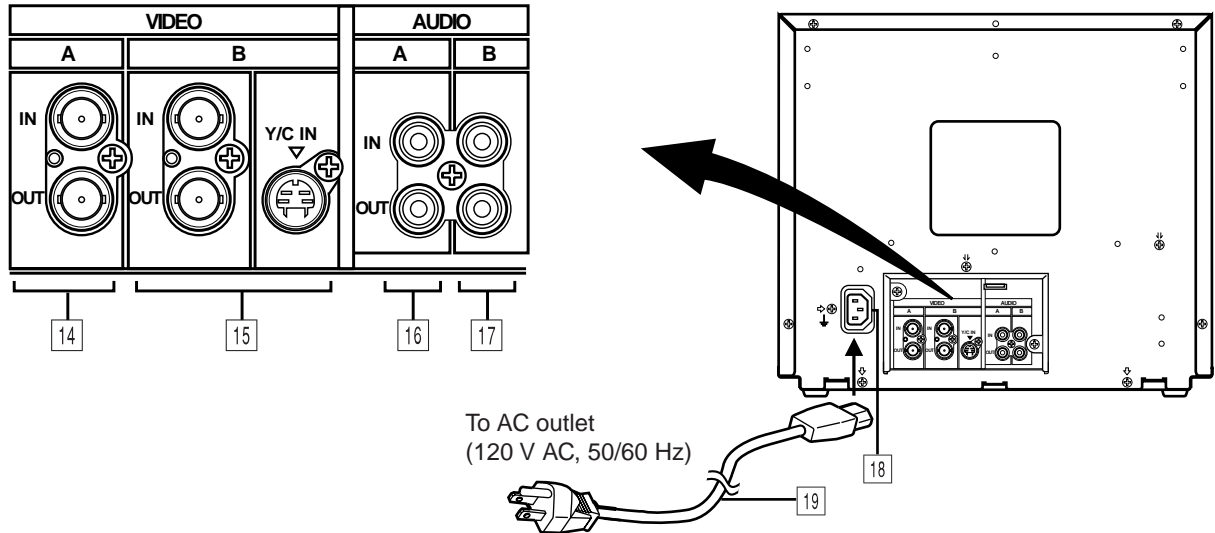

### 14 Video A terminals [VIDEO A IN/OUT]

Video signal input (IN) and output (OUT) terminals. The output terminal is bridge-connected.

**IN** : Video signal input terminal

**OUT** : Bridge-connected video signal output terminal

#### Notes:

- \* For corresponding audio signals, use the AUDIO A terminals 16.
- \* Also refer to the BASIC CONNECTION EXAMPLE on page 11.

### 15 Video B terminals [VIDEO B IN/OUT]

#### [ BNC connector ]

Video signal input (IN) and output (OUT) terminals. The output terminal is bridge-connected.

**IN** : Video signal input terminal

**OUT** : Bridge-connected video signal output terminal

#### [ Y/C connector ]

Y/C (S-Video) signal input (mini-DIN 4-pin connector) terminal.

**Y/C IN** : Y/C signal input terminal.

#### Notes:

- \* For corresponding audio signals, use the AUDIO B terminals 17.
- \* There is no Y/C (S-video) signal output terminal.
- \* When both VIDEO B terminals are connected (input) at the same time, the Y/C terminal is given priority.
- \* Also refer to the BASIC CONNECTION EXAMPLE on page 11.

### 16 Audio A terminals [AUDIO A IN/OUT]

Input (IN) and output (OUT) terminals for the audio signals corresponding to the VIDEO A terminals 14. The output terminal is bridge-connected.

**IN** : Audio signal input terminal

**OUT** : Bridge-connected audio signal output terminal

#### Notes:

- \* For corresponding video signals, use the VIDEO A terminals 14.
- \* Also refer to the BASIC CONNECTION EXAMPLE on page 11.

### 17 Audio B terminals [AUDIO B IN/OUT]

Input (IN) and output (OUT) terminals for the audio signals corresponding to the VIDEO B terminals 15. The output terminal is bridge-connected.

**IN** : Audio signal input terminal

**OUT** : Bridge-connected audio signal output terminal

#### Notes:

- \* For corresponding video signals, use the VIDEO B terminals 15.
- \* Also refer to the BASIC CONNECTION EXAMPLE on page 11.

### 18 AC Inlet [AC IN]

Power input connector. Connect the provided AC power cord 19 to an AC outlet (120 V AC, 50/60 Hz).

### 19 Power cord

Connects the provided power cord (120 V AC, 50/60 Hz) to the AC IN connector.

# HOW TO HANDLE BASIC OPERATIONS

## BASIC OPERATION

1. Press the **POWER** switch to turn on the power.

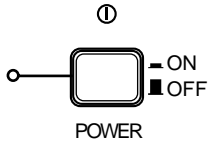

- ON : Power turns ON. (Power indicator: lit)
- OFF : Power turns OFF. (Power indicator: unlit)

2. Press the **INPUT SELECT** button to choose input.

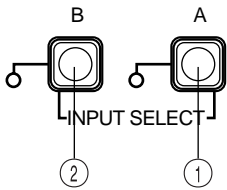

Selects video/audio signals input to terminals on the rear panel.

INPUT SELECT button	Terminals on the rear panel	
	Video signal input	Audio signal input
① Input A	VIDEO A terminal	AUDIO A terminal
② Input B	VIDEO B terminal	AUDIO B terminal

3. Press the **VOLUME/SELECT** buttons to adjust the speaker volume.

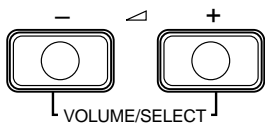

Press this button to display the speaker volume level on the screen.

- + : The Built-in speaker volume is increased. (00 → 50)
- : The Built-in speaker volume is decreased. (50 → 00)
- \* Screen indication will disappear about 10 seconds after operating.

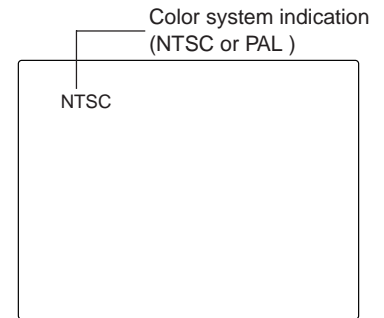

With regard to Color system indication

- With the COLOR SYSTEM setting set to AUTO mode, when you turn on the power or select inputs, the color system indication appears for about 3 seconds on the screen while PAL or NTSC signals are being detected. It does not appear when receiving B/W signal or when no signal is input. See page 7 for COLOR SYSTEM setting.

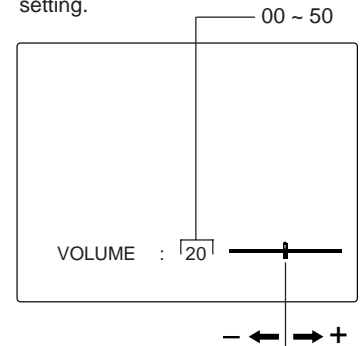

## PICTURE ADJUSTMENT

1. Press select button corresponding to the item you want to adjust.

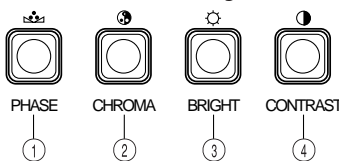

The item you select is displayed on the screen.

- ① PHASE ( 👑 ) : Phase control
- ② CHROMA ( 👑 ) : Chroma control
- ③ BRIGHT ( ☀ ) : Brightness control
- ④ CONTRAST ( 👑 ) : Contrast control

2. Adjust with the **VOLUME/SELECT** buttons.

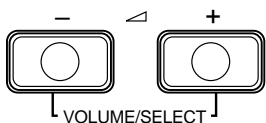

Items	VOLUME/SELECT button	
	-	+
PHASE (Phase)	reddish	greenish
CHROMA (Chroma)	lighter	deeper
BRIGHT (Brightness)	darker	brighter
CONTRAST (Contrast)	lower	higher

\* Screen indication will disappear about 10 seconds after operating.

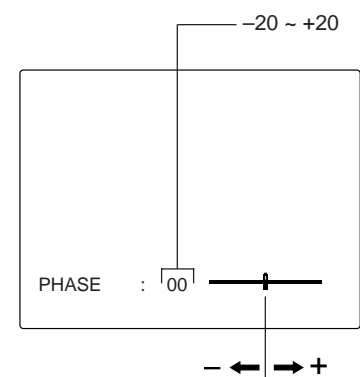

### Notes:

- Phase control is effective only in the NTSC color system mode.
- Chroma control is not effective when receiving B/W or when no signal is input.
- When the Chroma control is set to level " -20", the picture turns monochrome.
- "NO EFFECT" is displayed (for about 3 seconds) when your selected function has no effect.

# HOW TO USE THE MENU FUNCTIONS

## DISPLAY AND SELECTION IN THE <MENU> SCREEN MODE (SETTING)

You can set the following menu items.  
Set them depending on your needs.

- SHARPNESS
- COLOR SYSTEM

### 1. Press the MENU button.



The <MENU> screen is displayed.

### 2. Press the PHASE ( ) or CHROMA ( ) button to select MENU items.



A selection mark (▶) is put next to the selected item.

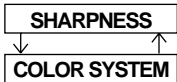

Front panel button	Function displayed	Contents
PHASE ( )	▼	Advance selection mark (▶)
CHROMA ( )	▲	Reverse selection mark (▶)

### 3. Press the VOLUME/SELECT buttons to set.

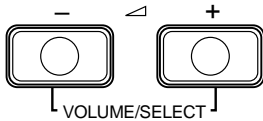

Front panel button	Function displayed	Contents
VOLUME/SELECT (+)	+	Increase (to max. value)
	▶	Advance the setting value
VOLUME/SELECT (-)	-	Decrease (to min. value)
	◀	Reverse the setting value

Menu items	Purpose	Setting range
SHARPNESS	Picture sharpness	00 ↔ +1 ↔ +2 ↔ +3 ↔ +4 ↔ +5
COLOR SYSTEM	Color system	AUTO ↔ NTSC ↔ PAL

\* Normally set the COLOR SYSTEM to the AUTO mode. If reception in the AUTO mode is not good, set it to the exclusive mode (NTSC or PAL) corresponding to the received color system.

### 4. If you want to set the other menu items, repeat procedures 2 and 3.

### 5. Press the MENU button to quit.



Front panel button	Function displayed	Contents
MENU	EXIT	Quit (or Release) the <MENU> screen

<MENU> screen

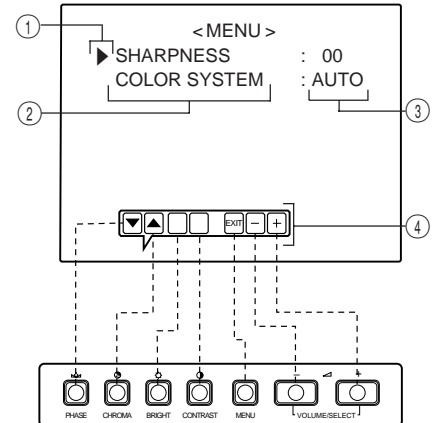

<Front panel button>

- ① **Selection mark (▶):** Indicates the menu item you select.
- ② **Menu item:** Menu items you can select.
- ③ **Setting display:** Indicates the current settings (value).
- ④ **Function display:** The functions of the front panel buttons (7 buttons on the left) correspond to the function displayed.

Function displayed	Contents
▼	Advance the menu item.
▲	Reverse the menu item.
-	Lower the adjustment value. (to the minimum)
+	Raise the adjustment value. (to the maximum)
▶	Advance the setting value.
◀	Reverse the setting value.
EXIT	Exits the <MENU> screen.

# HOW TO USE THE MENU FUNCTIONS (cont'd)

## DISPLAY AND SELECTIONS IN THE <SET-UP MENU> MODE (SETTING)

You can set the following set-up menu items.

- H. POSITION
- WHITE BALANCE
- CONTROL LOCK

### Note:

- Parameters for H. POSITION can be set separately depending on the video input (Input A or Input B) selected by the input select buttons on the front panel. Select the required video input with the input select buttons on the front panel in advance.

### 1. While pressing the MENU button, press the PHASE ( ) button.

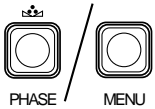

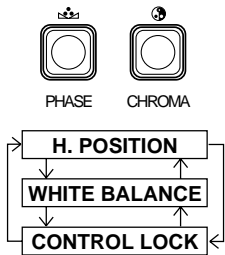

The <SET-UP MENU> screen is displayed.

### 2. Press the PHASE ( ) or CHROMA ( ) button to select the desired menu item.



A selection mark (▶) is put next to the selected item.

Front panel button	Function displayed	Contents
PHASE (  )	▼	Advance selection mark (▶)
CHROMA (  )	▲	Reverse selection mark (▶)

### 3. Press the VOLUME/SELECT buttons to set.

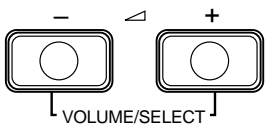

Front panel button	Function displayed	Contents
VOLUME/SELECT (+)	+	Increase (to max. value)
	▶	Advance the setting value
	CUTO	Selects CUT OFF setting screen
VOLUME/SELECT (-)	-	Decrease (to min. value)
	◀	Reverse the setting value
	DRV	Selects DRIVE setting screen

### Notes:

- For the WHITE BALANCE setting, select the CUT OFF or DRIVE setting screen, then select the buttons (PHASE/CHROMA/BRIGHT) corresponding to the function indicated (R/G/B).
- To return to the <SET-UP MENU> screen, press the EXIT (MENU) button.

### <SET-UP MENU> screen

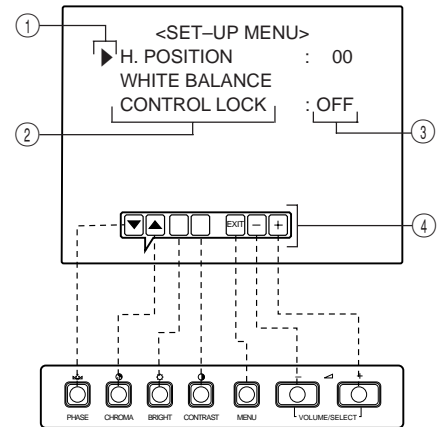

<Front panel button>

- ① **Selection mark (▶):** Indicates the menu item you select.
- ② **Menu item:** Menu items you can select.
- ③ **Setting display:** Indicates the current settings (value).
- ④ **Function display:** The functions of the front panel buttons (7 buttons on the left) correspond to the function displayed.

Function displayed	Contents
▼	Advance the menu item.
▲	Reverse the menu item.
-	Lower the adjustment value. (to the minimum)
+	Raise the adjustment value. (to the maximum)
▶	Advance the setting value.
◀	Reverse the setting value.
EXIT	Exit the <SET-UP MENU> screen. (release)
DRV	Selects DRV adjustment.
CUTO	Selects CUT OFF adjustment.
R	Adjusts red signal level.
G	Adjusts green signal level.
B	Adjusts blue signal level.
DISP	Turns the ON-SCREEN display on or off. (This function is effective only in the DRIVE or CUT OFF adjustment mode.)



Set-up menu items	Purpose	Settings
H. POSITION	Adjusts the horizontal position of the screen (+ : Horizontal position shifts to the right/-: Horizontal position shifts to the left)	-05 ↔ -04 ←•••→ -01↔00 ↔ +01←•••→ +04 ↔ +05
WHITE BALANCE	Adjusts the white balance	Selects DRIVE (DRV) or CUT OFF (CUTO) adjustment. Screen setting is changed to the selected setting mode. Select R/G/B buttons corresponding to the function display to adjust.
DRIVE   R.DRIVE	Adjusts red level	-09 ↔ -08 ←••••••→ -01↔00 ↔ +01←••••••→ +08 ↔ +09
B.DRIVE	Adjusts blue level	-09 ↔ -08 ←••••••→ -01↔00 ↔ +01←••••~•→ +08 ↔ +09
CUT OFF   R. CUT OFF	Adjusts red cut off	-09 ↔ -08 ←••••~•→ -01↔00 ↔ +01←••••~•→ +08 ↔ +09
G. CUT OFF	Adjusts green cut off	-09 ↔ -08 ←••••~•→ -01↔00 ↔ +01←••••~•→ +08 ↔ +09
B. CUT OFF	Adjusts blue cut off	-09 ↔ -08 ←••••~•→ -01↔00 ↔ +01←••••~•→ +08 ↔ +09
CONTROL LOCK	Sets the operation buttons on the front panel to control lock mode	OFF ↔ ON

**4. To set the other set-up menu items, repeat the procedures 2 and 3.**

**5. Press the MENU button to quit.**



Front panel button	Function displayed	Contents
MENU	EXIT	Quit (or Release) the <MENU> screen

**Notes:**

- When the CONTROL LOCK function is set to ON, pressing operation buttons on the front panel will display the message "CONTROL LOCK ON!" on the screen for about 3 seconds.
- The CONTROL LOCK function is maintained even when the power is turned off.
- To turn off the CONTROL LOCK function, while holding the MENU button press the PHASE button. Then set the CONTROL LOCK function to OFF.
- Even when the CONTROL LOCK function is set to ON, the following operations are available:
  - Power Switch operation.
  - Sound volume adjustment with the VOLUME/SELECT buttons.
  - Display or disappear of the <SET-UP MENU> screen.

# HOW TO INITIALIZE THE SETTING

## SCREEN DISPLAY AND SELECTIONS IN THE <SET-UP MENU> RESET MODE

You can set <MENU> and <SET-UP MENU> screen items, picture adjustment items and the volume level to their factory-set (initial) values.

**1. Press the POWER (ⓘ) switch to turn the power OFF (■).**

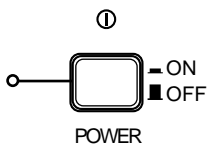

**2. While pressing both MENU button and PHASE (👑) button, press the POWER (ⓘ) switch to turn the power ON (■).**

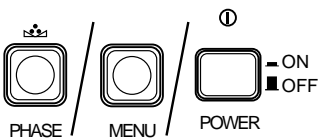

The <SET-UP MENU> RESET screen is displayed.

**Note:**

- The <SET-UP MENU> RESET screen will not be displayed if the MENU or PHASE buttons are pressed for a very short time. Keep pressing them until the display screen appears.

### 3. Setting

● **Initialization is required.**



Press the CONTRAST (●) button.

\* When initialization is completed, and the <SET-UP MENU> RESET screen disappears.

● **Initialization is not required.**

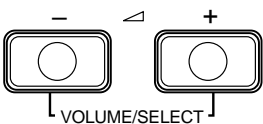

Press the VOLUME/SELECT [+] or [-] buttons.

\* Initialization is aborted, and the <SET-UP MENU> RESET screen disappears.

#### <SET-UP MENU> RESET screen

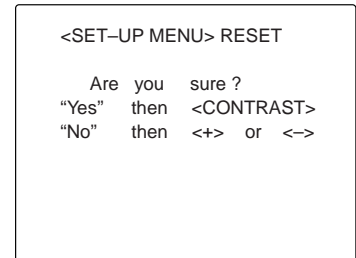

#### Initial settings

Sorts	Functions (Items)	Initialization (setting)
<MENU> screen	SHARPNESS	00
	COLOR SYSTEM	AUTO
<SET-UP MENU> screen	H. POSITION	00
	WHITE BALANCE	
	R. CUT OFF	00
	G. CUT OFF	00
	B. CUT OFF	00
	R. DRIVE	00
	B. DRIVE	00
CONTROL LOCK	OFF	
Picture adjustment	PHASE	00
	CHROMA	00
	CONTRAST	00
	BRIGHT	00
Volume	VOLUME	20

# BASIC CONNECTION EXAMPLE

## Notes:

- Before connecting your system, make sure that all units are turned off.
- The illustration below shows some examples of different connections. Terminal connections may differ depending on the component connected. Be sure to refer to the instructions provided with the unit(s) you are connecting.
- Each pair of input (IN) and output (OUT) terminals are bridge-connected. However, the Y/C input terminal (Y/C IN) has no output terminal (OUT) corresponding to it.
- If you're not connecting any equipment to a bridged output (OUT) terminal, be sure not to connect any other cables to the bridged output (OUT) terminal as this will cause the terminating resistance switch to open (auto terminate function).
- When making a bridge connection, connect the input (IN) and output (OUT) terminals on the monitor to separate video components.  
(For example, if both terminals are connected to the same VCR, resonance may occur except during playback. This is caused by the same video signal "looping" between the VCRs, and is not a malfunction.)
- Select the video input (Input A or Input B) with the input select button on the front panel.

### VIDEO A Connection Example (Select Input A button)

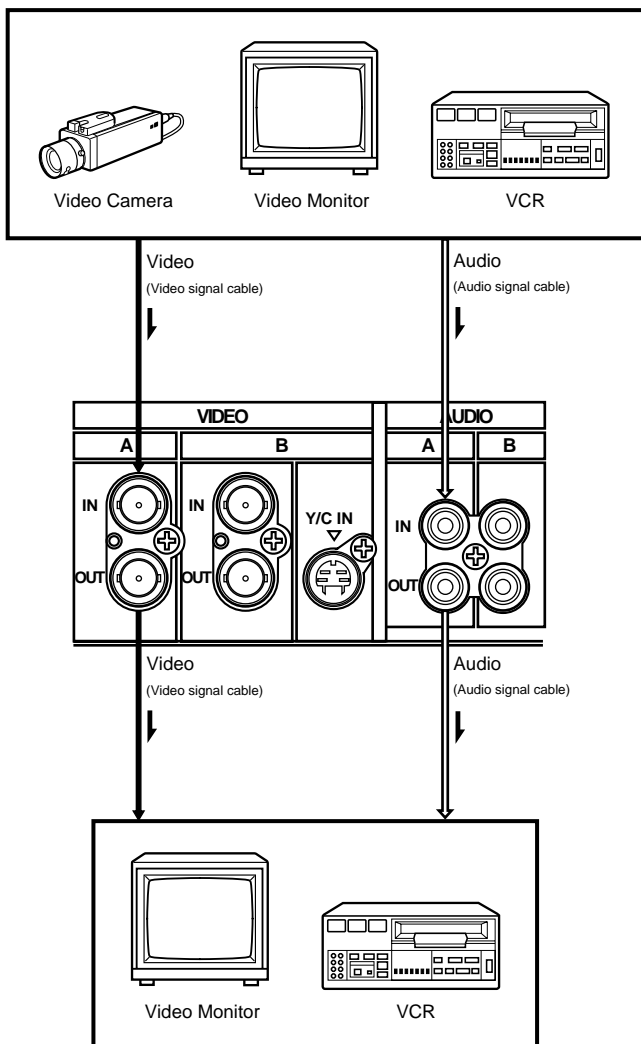

### VIDEO B Connection Example (Select Input B button)

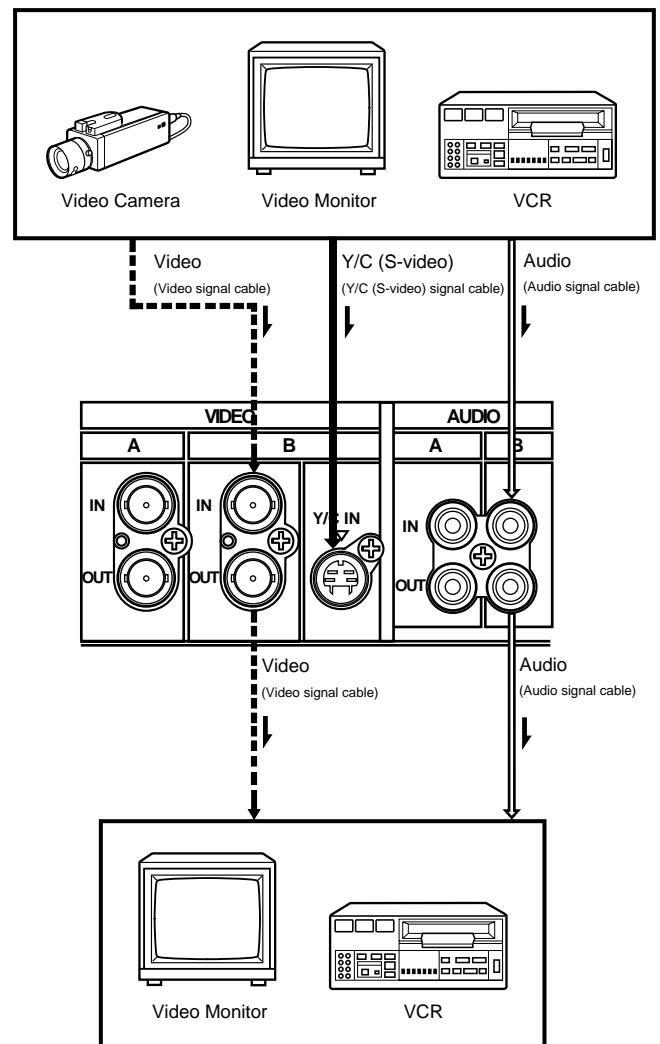

↓ : Signal Flow

↓ : Signal Flow

# TROUBLESHOOTING

Solutions to common problems related to your monitor are described here. If none of the solutions presented here solves the problem, unplug the monitor and consult a JVC-authorized dealer or service center for assistance.

Problems	Points to be checked	Measures (Remedy)
<b>No power supply.</b>	Is the power plug loosened or disconnected?	Firmly insert the power plug.
<b>No picture with the power on.</b>	Is the video signal output from the connected component?	Set the connected component correctly.
	Is the input signal selected properly?	Select the required video signal input with the Input select button. (See page 6.)
	Is the video cable disconnected?	Connect the video signal cable firmly. (See page 11.)
<b>No sound.</b>	Is the audio signal output from the connected component?	Set the connected component correctly.
	Is the volume output set to minimum?	Adjust the speaker volume with the VOLUME/ SELECT buttons. (See page 6.)
	Is the audio cable disconnected?	Connect the audio signal cable firmly. (See page 11.)
<b>Shaking picture.</b>	Is the monitor close to a device generating a strong magnetic field?	Move the device away from the monitor until the picture stabilizes.
<b>No colors, wrong color, or dark picture.</b>	Is the color system selected properly?	Set the COLOR SYSTEM in the <MENU> screen mode to [AUTO] mode. (See page 7.)
	Has the picture control setting (CONTRAST, BRIGHT, CHROMA or PHASE) been changed?	Set each picture control to the standard setting. (See page 6.)
<b>Unnatural, irregularly colored, or distorted picture.</b>	Is the monitor close to a speaker, magnet or any other device generating a strong magnetic field?	Move the device away from the monitor and turn the monitor's power off. Wait at least 30 minutes, then turn the power on again.
<b>Front panel button does not function.</b>	Are the operation buttons on the front panel locked? ( Has CONTROL LOCK function set to ON?)	Set the CONTROL LOCK to OFF in the <SET-UP MENU> screen mode. (See pages 8 and 9.)

## The following are not malfunctions:

- When a bright still image (such as a white cloth) is displayed for a long period, it may appear to be colored. This is due to the structure of the cathode ray tube and will be deleted when another image is displayed.
- You experience a mild electric shock when you touch the picture tube. This phenomenon is due to a normal buildup of static electricity on the CRT and is not harmful.
- The monitor emits a strange sound when the room temperature changes suddenly. This is only a problem if an abnormality appears on the screen as well.
- If two or more monitors are operated next to each other, their images may shake or be distorted. This phenomenon is due to mutual interference; it is not a malfunction.  
Move the monitors away from each other until the interference disappears or turn the power off on any monitor that is not being used.

# SPECIFICATIONS

<b>MODEL</b>		<b>TM-A130SU</b>
<b>Type</b>		Color video monitor
<b>Color system</b>		NTSC (3.58), PAL
<b>Picture tube</b>		13" measured diagonally, 90° deflection, in-line gun, vertical line trio type (phosphor stripe pitch 0.64 mm)
<b>Effective screen size</b>		Width 11-1/8" (280.8 mm) Height 8-3/8" (210.6 mm) Diagonal 13-1/4" (335.4 mm)
<b>Scanning frequency</b>		H : 15.734 kHz (NTSC), 15.625 kHz (PAL) V : 59.94 Hz (NTSC), 50 Hz (PAL)
<b>Horizontal resolution</b>		320 TV lines or more (NTSC)
<b>Input terminals</b>	<b>VIDEO A</b>	Composite video: 1 line, BNC connector x 2, 1 Vp-p, 75 Ω negative sync (bridge connection possible, auto termination)
	<b>VIDEO B</b>	Composite video: 1 line, BNC connector x 2, 1 Vp-p, 75 Ω negative sync (bridge connection possible, auto termination)
		Y/C-separated: 1 line, mini-DIN 4-pin connector x 1 Y: 1.0 Vp-p, 75 Ω C: 0.286 Vp-p, 75 Ω (NTSC), 0.3 Vp-p, 75 Ω (PAL)
	<b>AUDIO A</b>	1 line (monaural), RCA pin x 2, 0.5 V rms, high-impedance (bridge connection possible)
	<b>AUDIO B</b>	1 line (monaural), RCA pin x 2, 0.5 V rms, high-impedance (bridge connection possible)
<b>Audio power output</b>		1 W (monaural)
<b>Built-in speaker</b>		8 cm round x 1, impedance of 8 Ω
<b>Environmental conditions</b>		Operation temperature: 0 – 40 °C (32 – 104 °F) Operation humidity: 20 – 80% (non-condensing)
<b>Power requirements</b>		120V AC, 50/ 60 Hz
<b>Power consumption</b>		0.87 A (120 V AC)
<b>Dimensions</b>		Width 13-5/8" (346 mm) Height 12-1/4" (310 mm) Depth 14-5/8" (368.5 mm)
<b>Weight</b>		26.9 lbs (12.2 kg)
<b>Accessory</b>		AC power cord [7.87 ft (2.4 m)] x 1

\* Illustrations used in this manual are for explanatory purposes only. The appearance of the actual product may differ slightly.

\* Dimensions and weight are approximate.

\* E. & O. E. Design and specifications subject to change without notice.

## ■ Dimensions

Unit : Inch (mm)

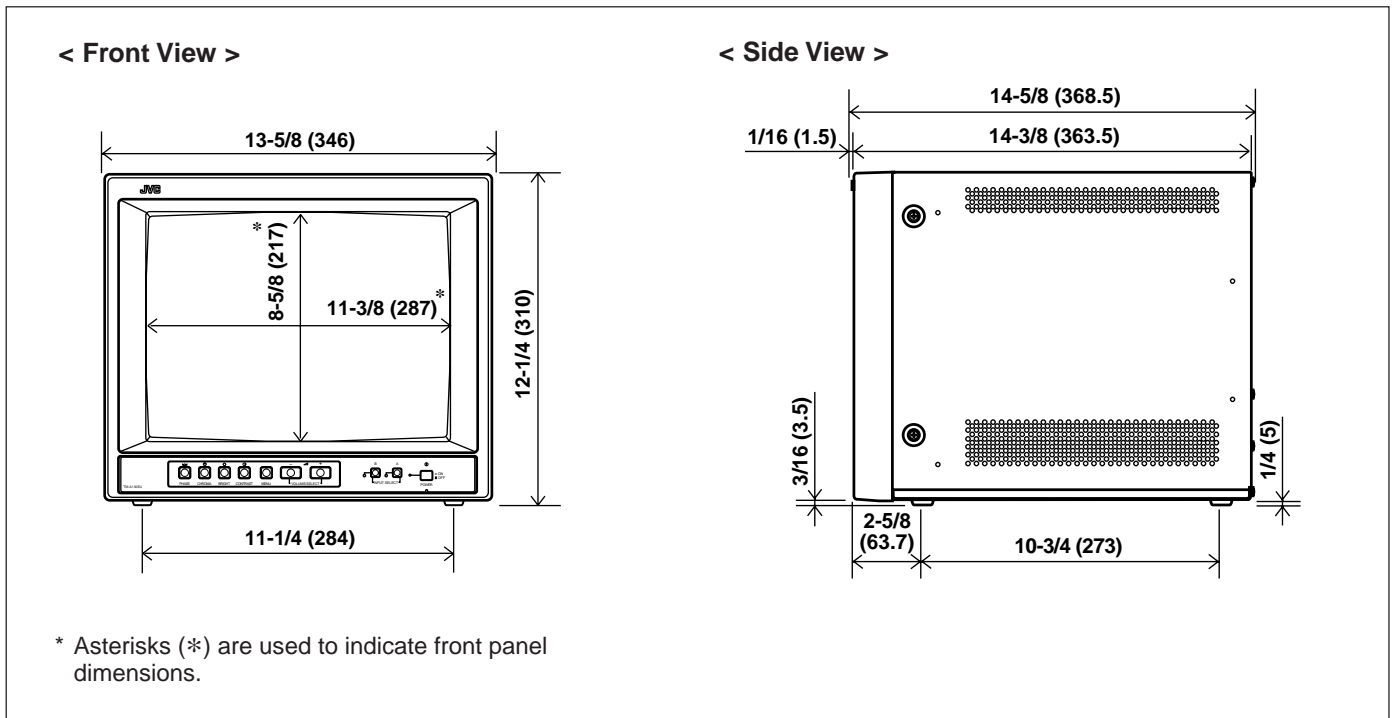

## ■ Y/C (Mini DIN 4 pin) terminal specification

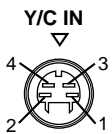

Pin No.	Signal
1	GND (Y)
2	GND (C)
3	Y
4	C



---

**JVC**<sup>®</sup>

**JVC PROFESSIONAL PRODUCTS COMPANY**  
DIVISION OF US JVC CORP.  
1700 Valley Road Wayne, NJ07470  
**JVC CANADA INC.**

21 Finchdene Square, Scarborough Ontario M1X 1A7



LCT0367-002A-H  
0699-Tu-U-JMT



## Free Manuals Download Website

<http://myh66.com>

<http://usermanuals.us>

<http://www.somanuals.com>

<http://www.4manuals.cc>

<http://www.manual-lib.com>

<http://www.404manual.com>

<http://www.luxmanual.com>

<http://aubethermostatmanual.com>

Golf course search by state

<http://golfingnear.com>

Email search by domain

<http://emailbydomain.com>

Auto manuals search

<http://auto.somanuals.com>

TV manuals search

<http://tv.somanuals.com>