



COLOR VIDEO MONITOR

BEDIENUNGSANLEITUNG : FARB-VIDEO-MONITOR

MANUEL D'INSTRUCTIONS : MONITEUR VIDEO COULEUR

MANUALE DI ISTRUZIONI : MONITOR VIDEO A COLORI

INSTRUCCIONES : MONITOR DE VIDEO A COLOR

使用说明书 : 彩色视频监视器

TM-A210G

INSTRUCTIONS

ENGLISH

DEUTSCH

FRANÇAIS

ITALIANO

ESPAÑOL

文

中

For Customer Use:

Enter below the Serial No. which is located on the rear of the cabinet.
Retain this information for future reference.

Pour l'usage du client:

Enter ci-dessous le numéro de série qui est situé sur l'arrière du coffret.
Conserver cette information pour une référence ultérieure.

Model No. :

Numéro de modèle : **TM-A210G**

Serial No. :

Numéro de série :

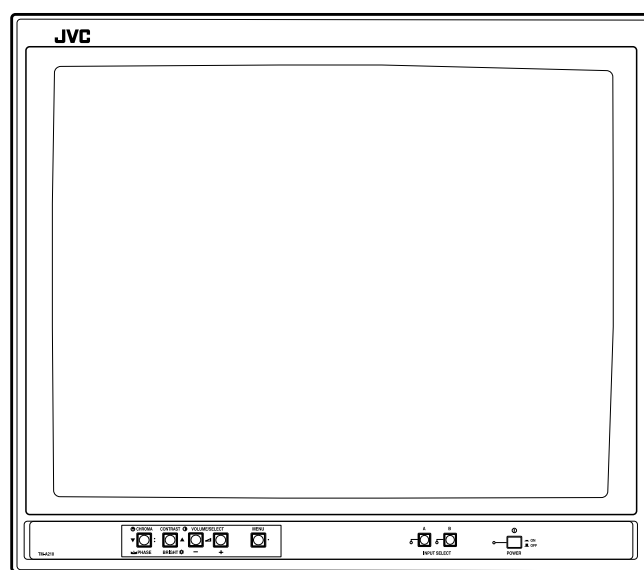

LCT1357-001A-H

INSTRUCTIONS

COLOR VIDEO MONITOR

TM-A210G

ENGLISH

Thank you for purchasing this JVC color video monitor. Before using it, read and follow all instructions carefully to take full advantage of the monitor's capabilities.

SAFETY PRECAUTIONS

In order to prevent any fatal accidents caused by misoperation or mishandling the monitor, be fully aware of all the following precautions.

WARNINGS

To prevent fire or shock hazard, do not expose this monitor to rain or moisture. Dangerous high voltages are present inside the unit. Do not remove the back cover of the cabinet. When servicing the monitor, consult qualified service personnel. Never try to service it yourself.

WARNING : THIS APPARATUS MUST BE EARTHED.

Machine Noise Information Ordinance 3. GSGV, January 18, 1991: The sound pressure level at the operator position is equal or less than 70 dB(A) according to ISO 7779.

Improper operations, in particular alternation of high voltage or changing the type of tube may result in x-ray emission of considerable dose. A unit altered in such a way no longer meets the standards of certification, and must therefore no longer be operated.

This monitor is equipped with a 3-blade grounding-type plug to satisfy FCC rule. If you are unable to insert the plug into the outlet, contact your electrician.

FCC INFORMATION (U.S.A. only)

CAUTION: Changes or modification not approved by JVC could void the user's authority to operate the equipment.

NOTE: This equipment has been tested and found to comply with the limits for a Class B digital device, pursuant to Part 15 of the FCC Rules. These limits are designed to provide reasonable protection against harmful interference in a residential installation. This equipment generates, uses and can radiate radio frequency energy and, if not installed and used in accordance with the instructions, may cause harmful interference to radio communications. However, there is no guarantee that interference will not occur in a particular installation. If this equipment does cause harmful interference to radio or television reception, which can be determined by turning the equipment off and on, the user is encouraged to try to correct the interference by one or more of the following measures:

- Reorient or relocate the receiving antenna.
- Increase the separation between the equipment and receiver.
- Connect the equipment into an outlet on a circuit different from that to which the receiver is connected.
- Consult the dealer or an experienced radio/TV technician for help.

Notice (U.S.A. only)

This product utilizes both a Cathode Ray Tube (CRT) and other components that contain lead. Disposal of these materials may be regulated in your community due to environmental considerations. For disposal or recycling information please contact your local authorities, or the Electronics Industries Alliance: <<http://www.eiae.org>>

PRECAUTIONS

- Use only the power source specified on the unit. (120 V AC/220 – 240 V AC, 50 Hz/60 Hz)
- When not using this unit for a long period of time, or when cleaning it, be sure to disconnect the power plug from the AC outlet.
- Do not allow anything to rest on the power cord. And do not place this unit where people will tread on the cord. Do not overload wall outlets or power cords as this can result in a fire or electric shock.
- Avoid using this unit under the following conditions:
 - in extremely hot, cold or humid places,
 - in dusty places,
 - near appliances generating strong magnetic fields,
 - in places subject to direct sunlight,
 - in badly ventilated places,
 - in automobiles with doors closed.
- Do not cover the ventilation slots while in operation as this could obstruct the required ventilation flow.
- When dust accumulates on the screen surface, clean it with a soft cloth.
- Unplug this unit from the AC outlet and refer servicing to qualified service personnel under the following conditions:
 - when the power cord is frayed or the plug is damaged,
 - if liquid has been spilled into the unit,
 - if the unit has been dropped or the cabinet has been damaged,
 - when the unit exhibits a distinct change in performance.
- Do not attempt to service this unit yourself as opening or removing covers may expose you to dangerous voltage or other hazards. Always refer servicing to qualified service personnel.
- When replacement parts are required, have the service personnel verify in writing that the replacement parts he/she uses have the same safety characteristics as the original parts. Use of manufacture's specified replacement parts can prevent fire, shock, or other hazards.
- Upon completion of any servicing or repair work to this unit, please ask the service personnel to perform the safety check described in the manufacturer's service literature.
- When this unit reaches the end of its useful life, improper disposal could result in a picture tube implosion. Ask qualified service personnel to dispose of this unit.

POWER CONNECTION

The power supply voltage rating of this product is 120 V AC (For U.S.A. and Canada only) and 220 – 240 V AC (For European countries or United Kingdom), the power cord attached conforms to the following power supply voltage and countries. Use only the power cord designated to ensure Safety and EMC regulations of each countries.

Power cord

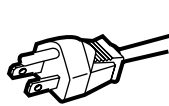

Power supply voltage : 120 V AC
 Countries : U.S.A. and Canada

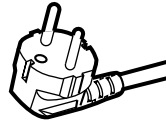

220 – 240 V AC
 European countries

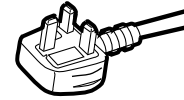

220 – 240 V AC
 United Kingdom

Warning:

- Do not use the same Power Cord for 120 V AC as for 220 – 240 V AC. Doing so may cause malfunction, electric shock or fire.

Note for the United Kingdom power cord only

The plug on the United Kingdom power cord has a built-in fuse. When replacing the fuse, be sure to use only a correctly rated approved type, re-fit the fuse cover.

(Consult your dealer or qualified service personnel.)

How to replace the fuse

Open the fuse compartment with the blade screw driver, and replace the fuse.

(* An example is shown in the illustration.)

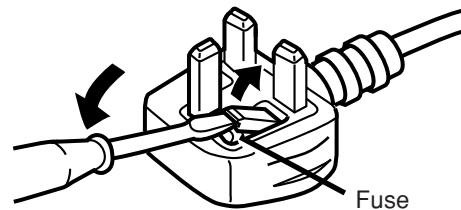

SCREEN BURN

- It is not recommended to keep a certain still image displayed on screen for a long time as well as displaying extremely bright images on screen. This may cause a burning (sticking) phenomenon on the screen of cathode-ray tube. This problem does not occur as far as displaying normal video playback motion images.

CONTENTS

SAFETY PRECAUTIONS 2

CONTROLS AND FEATURES 4

HOW TO HANDLE BASIC OPERATIONS 7

HOW TO USE THE MENU FUNCTIONS 8

HOW TO INITIALIZE THE SETTING 11

BASIC CONNECTION EXAMPLE 12

TROUBLESHOOTING 14

SPECIFICATIONS 15

CONTROLS AND FEATURES

FRONT VIEW

<Front Panel>

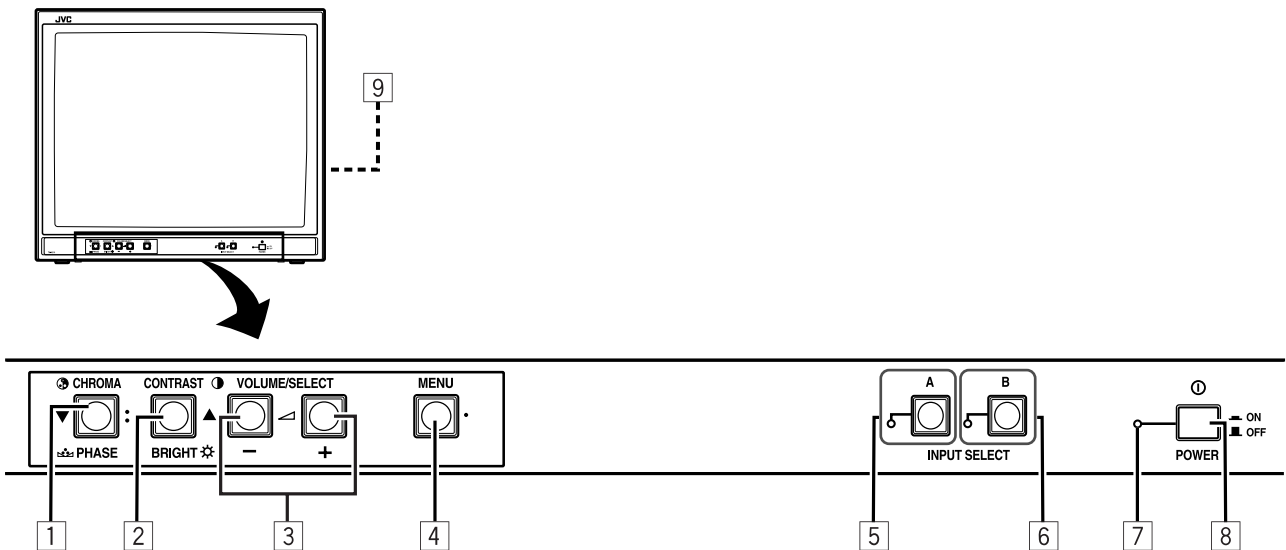

1 Chroma/Phase button

[CHROMA / PHASE]

Press this button to activate the picture color density adjustment mode or picture hue adjustment mode. Each time you press the button, the adjustment item changes.

Picture color density ↔ Picture hue

Adjust the value with the VOLUME/SELECT buttons [3]. Also used as a control button in the menu function mode.

2 Contrast/Brightness button

[CONTRAST / BRIGHT]

Press this button to activate the picture contrast adjustment mode or picture brightness adjustment mode. Each time you press the button, the adjustment item changes.

Picture contrast ↔ Picture brightness

Adjust the value with the VOLUME/SELECT buttons [3]. Also used as a control button in the menu function mode.

3 Volume/Select buttons

[VOLUME/SELECT - +]

Adjusts the speaker volume. Also used as a control button in the menu function mode.

4 Menu button [MENU]

Displays and disappears the <MENU> screen. Pressing the CHROMA/PHASE button [1] with the Menu button depressed will display the <SET-UP MENU> screen.

5 Input A (VIDEO) button and lamp [INPUT SELECT A]

Selects the video and audio signals input to the VIDEO A [13] and AUDIO A [10] terminals on the rear panel. The lamp lights when selected.

6 Input B (VIDEO / Y/C) button and lamp [INPUT SELECT B]

Selects the video and audio signals input to the VIDEO B [14] and AUDIO B [11] terminals on the rear panel. The lamp lights when selected.

Notes:

• When both VIDEO B terminals are connected (input) at the same time, the Y/C terminal has priority.

7 Power indicator

Lights in green when the power is ON.

Lit : When the power is on.

Unlit : When the power is off.

8 Power switch [POWER Ⓡ]

Press this switch to turn the power on or off.

ON : Power is turned on.

OFF : Power is turned off.

9 Speaker

A built-in speaker is located inside the right side panel when the monitor is viewed from the front.

REAR VIEW

<Rear Panel>

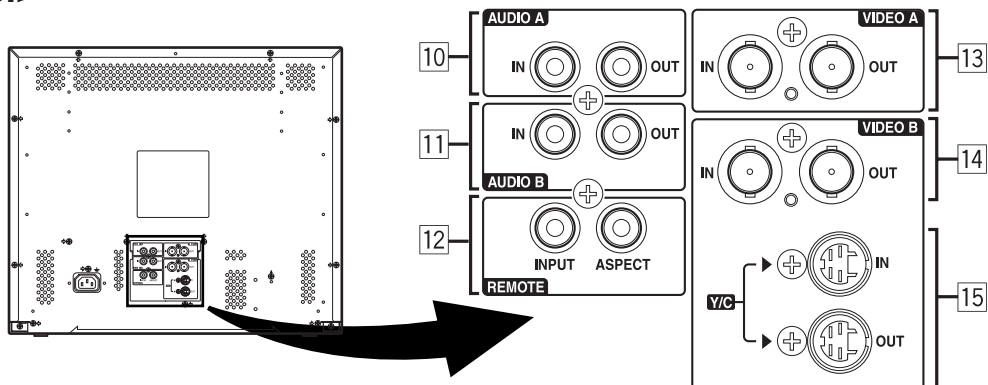

10 Audio A terminals [AUDIO A IN/OUT]
 Input (IN) and output (OUT) terminals for the audio signal corresponding to the VIDEO A terminals **13**.
 The output terminal is bridge-connected.
IN : Audio signal input terminal
OUT : Bridge-connected audio signal output terminal

Notes:

- For corresponding video signals, use the VIDEO A terminal **13**.
- Also refer to BASIC CONNECTION EXAMPLE on page 12.

11 Audio B terminals [AUDIO B IN/OUT]
 Input (IN) and output (OUT) terminals for the audio signals corresponding to the VIDEO B terminals **14**.
 The output terminal is bridge-connected.
IN : Audio signal input terminal
OUT : Bridge-connected audio signal output terminal

Notes:

- For corresponding video signals, use the VIDEO B terminals **14**.
- Also refer to BASIC CONNECTION EXAMPLE on page 12.

12 Remote terminals [REMOTE INPUT, ASPECT]
 Remote terminals for external control. Selecting VIDEO A or VIDEO B and ASPECT RATIO is available via external control. External control is set in the <SET-UP MENU> screen.
 To use external control, you must build a switch cable and connect it to the REMOTE terminals.

External control functions	External control switch	
	Open circuit (open)	Closed circuit (short)
ASPECT RATIO	4-3 (4:3)	16-9 (16:9)
INPUT	INPUT A	INPUT B

Note:

- Also refer to BASIC CONNECTION EXAMPLE on page 12.

13 Video A terminals [VIDEO A IN/OUT]
 Video signal input (IN) and output (OUT) terminals.
 The output terminal is bridge-connected.
IN : Video signal input terminal
OUT : Bridge-connected video signal output terminal

Notes:

- For corresponding audio signals, use the AUDIO A terminals **10**.
- Also refer to BASIC CONNECTION EXAMPLE on page 12.

14 Video B terminals [VIDEO B IN/OUT]
 Video signal input (IN) and output (OUT) terminals.
 The output terminal is bridge-connected.
IN : Video signal input terminal
OUT : Bridge-connected video signal output terminal

Notes:

- For corresponding audio signals, use the AUDIO B terminals **11**.
- When both VIDEO B terminals are connected (input) at the same time, the Y/C terminal has priority.
- Also refer to BASIC CONNECTION EXAMPLE on page 12.

15 Video B (Y/C) terminals [VIDEO B Y/C IN/OUT]
 Y/C (S-video) signal input (IN) and output (OUT) terminals.
 The output terminal is bridge-connected.
 (The input signal is automatically terminated if a cable is not connected to the OUT terminals.)
 The output terminal is bridge-connected.
IN : Y/C-separated (S-video) signal input terminal
OUT : Bridge-connected Y/C-separated (S-video) signal output terminal

Notes:

- For corresponding audio signals, use the AUDIO B terminals **11**.
- When both VIDEO B terminals are connected (input) at the same time, the Y/C terminal has priority.
- Also refer to BASIC CONNECTION EXAMPLE on page 13.

CONTROLS AND FEATURES (cont'd)

REAR VIEW

<Rear Panel>

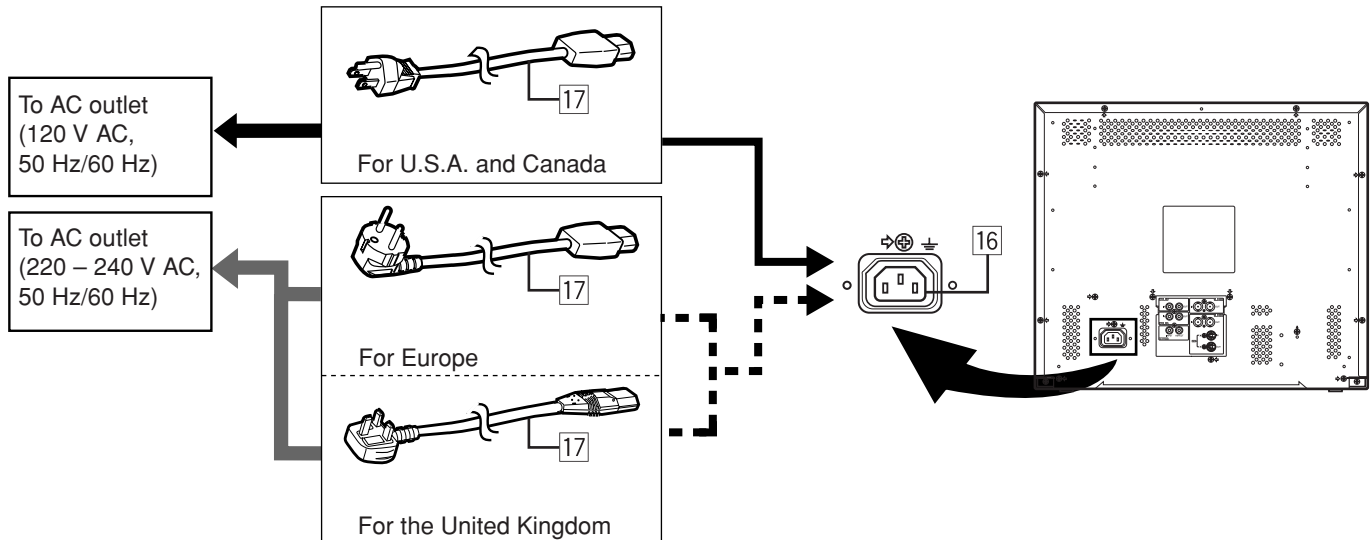

16 AC inlet [AC IN]

Power input connector. Connect the provided AC power cord 17 to an AC outlet (120 V AC or 220 – 240 V AC, 50 Hz/60 Hz).

17 Power cord

Connects the provided power cord (120 V AC or 220 – 240 V AC, 50 Hz/60 Hz) to the AC IN connector 16.

Caution:

In North America (USA and Canada), this monitor comes with one power cable. In Europe and the United Kingdom, two power cables are provided (one for use in continental European countries and the other for the UK). Be sure to use the power cable that is appropriate for the AC outlets used in your region. If none of the power cables provided is suitable, please contact your dealer or qualified service personnel to obtain the correct type of power cable.

HOW TO HANDLE BASIC OPERATIONS

BASIC OPERATION

1. Press the **POWER** switch to turn on the power.

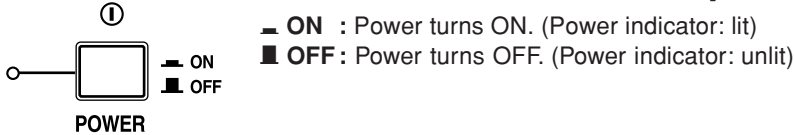

2. Press the **INPUT SELECT** buttons to choose input.

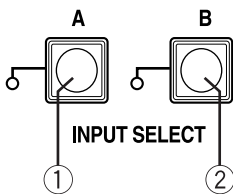

Select video/audio signals input to terminals on the rear panel. The lamp for the selected button lights up.

INPUT SELECT button	Terminals on the rear panel	
	Video signal input	Audio signal input
① Input A (VIDEO)	VIDEO A terminal	AUDIO A terminal
② Input B (VIDEO Y/C)	VIDEO B terminal VIDEO B (Y/C) terminal	AUDIO B terminal

Note: The Y/C (S-video) terminal has priority.

3. Press the **VOLUME/SELECT** buttons to adjust the speaker volume.

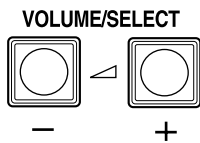

Press this button to display the speaker volume level on the screen.
 + : The Built-in speaker volume is increased. (00 → 50)
 - : The Built-in speaker volume is decreased. (50 → 00)
 * Screen indication will disappear about 10 seconds after operating or immediately when you press the MENU button.

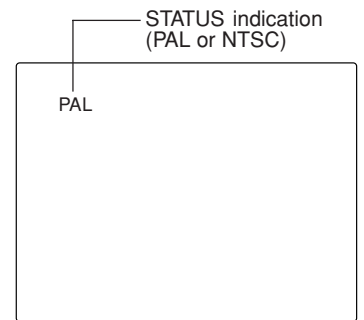

About the STATUS indication

- With the COLOR SYSTEM setting set to AUTO mode, when you turn on the power or select inputs, the color system indication appears for about 3 seconds on the screen while PAL or NTSC signals are being detected. It does not appear when receiving a B/W signal or when no signal is input. Refer to page 8 for more information about COLOR SYSTEM setting and page 9 for more information about STATUS indication setting.

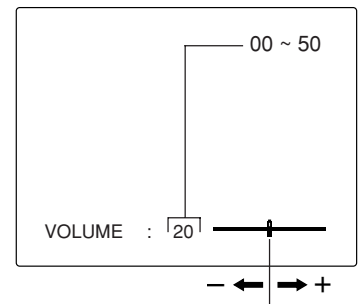

PICTURE ADJUSTMENT

1. Press select buttons corresponding to the item you want to adjust.

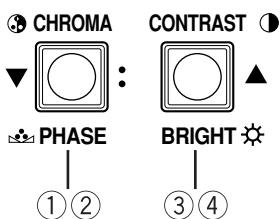

The item you select is displayed on the screen.

- Phase control : Press the CHROMA/PHASE button twice.
- Chroma control : Press the CHROMA/PHASE button once.
- Brightness control : Press the CONTRAST/BRIGHT button twice.
- Contrast control : Press the CONTRAST/BRIGHT button once.

2. Adjust with the **VOLUME/SELECT** buttons.

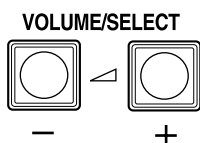

Items	VOLUME/SELECT button	
	-	+
PHASE (Phase)	reddish	greenish
CHROMA (Chroma)	lighter	deeper
BRIGHT (Brightness)	darker	brighter
CONTRAST (Contrast)	lower	higher

* Screen indication will disappear about 10 seconds after operating or immediately when you press the MENU button.

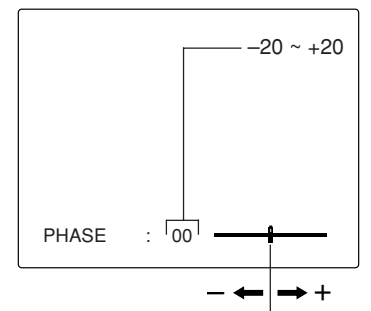

Notes:

- Phase control is effective only in the NTSC color system mode.
- Chroma control is not effective when receiving B/W or when no signal is input.
- When CHROMA is adjusted to "-20," the picture becomes less colorful.
- "NO EFFECT" is displayed (for about 3 seconds) when your selected function has no effect.

HOW TO USE THE MENU FUNCTIONS

DISPLAY AND SELECTION IN THE <MENU> SCREEN MODE (SETTING)

You can set the following menu items.
Set them depending on your needs.

- SHARPNESS
- COLOR SYSTEM
- ASPECT RATIO
- COLOR TEMP.

1. Press the MENU button.

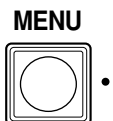

The <MENU> screen is displayed.

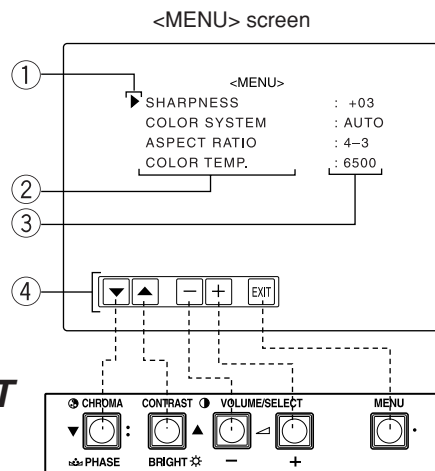

2. Press the CHROMA/PHASE or CONTRAST/BRIGHT button to select MENU items.

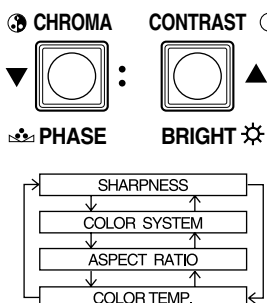

A selection mark (▶) is put next to the selected item.

Front panel button	Function displayed	Contents
CHROMA/PHASE	▼	Forward selection mark (▶)
CONTRAST/BRIGHT	▲	Reverse selection mark (▶)

3. Press the VOLUME/SELECT buttons to set.

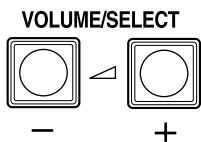

Front panel button	Function displayed	Contents
VOLUME/SELECT (+)	+	Increase (to max. value)
	▶	Forward the setting value
VOLUME/SELECT (-)	-	Decrease (to min. value)
	◀	Reverse the setting value

Menu items	Purpose	Setting range
SHARPNESS	Picture sharpness	00 ↔ +1 ↔ ↔ +04 ↔ +05
COLOR SYSTEM	Color system	AUTO ↔ NTSC ↔ PAL
ASPECT RATIO	Aspect ratio	4 - 3 ↔ 16 - 9
COLOR TEMP.	Color temperature of white balance	9300 ↔ 6500

4. If you want to set the other menu items, repeat procedures 2 and 3.

5. Press the MENU button to quit.

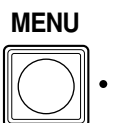

Front panel button	Function displayed	Contents
MENU	EXIT	Quit (or Release) the <MENU> screen

<Front panel buttons>

- ① Selection mark (▶): Indicates the menu item you select.
- ② Menu item: Menu items you can select.
- ③ Setting display: Indicates the current settings (value).
- ④ Function display: The functions of the front panel buttons (5 buttons on the left) correspond to the function displayed.

Function displayed	Contents
▼	Forward the menu item.
▲	Reverse the menu item.
-	Lower the adjustment value. (to the minimum)
+	Raise the adjustment value. (to the maximum)
▶	Forward the setting value.
◀	Reverse the setting value.
EXIT	Exits the <MENU> screen.

Notes:

- When the screen aspect ratio is set to 16 - 9 (16:9) in ASPECT RATIO, the picture will be vertically reduced.
- When ASPECT REMOTE is set to ON in the <SET-UP MENU> screen, REMOTE is displayed in ASPECT RATIO. ASPECT RATIO cannot be set in the MENU when ASPECT REMOTE is ON.

DISPLAY AND SELECTIONS IN THE <SET-UP MENU> MODE (SETTING)

You can set the following set-up menu items.

- H. POSITION
- CONTROL LOCK
- INPUT REMOTE
- WHITE BALANCE
- STATUS DISPLAY
- ASPECT REMOTE

Notes:

- Parameter for H. POSITION can be set separately depending on the video input (Input A (VIDEO) or Input B (VIDEO)) selected by the input select buttons on the front panel.
Select the required video input with the input select buttons on the front panel in advance.
- WHITE BALANCE can be set independently at 6500 or 9300 for the color temperature value. Set COLOR TEMP. to 6500 or 9300 on the <MENU> screen beforehand.

1. While pressing the MENU button, press the CHROMA/PHASE button.

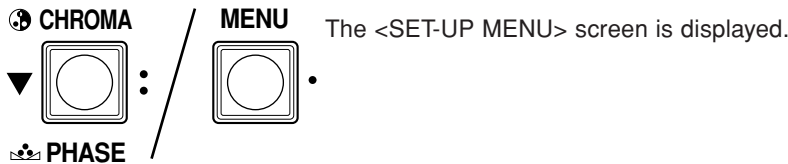

2. Press the CHROMA/PHASE or CONTRAST/BRIGHT button to select the desired menu item.

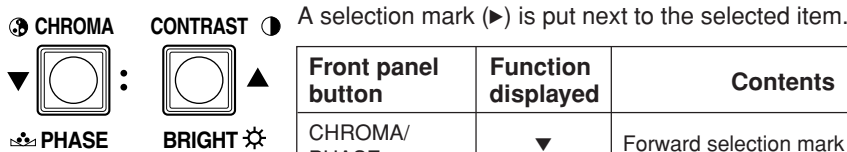

Front panel button	Function displayed	Contents
CHROMA/PHASE	▼	Forward selection mark (▶)
CONTRAST/BRIGHT	▲	Reverse selection mark (◀)

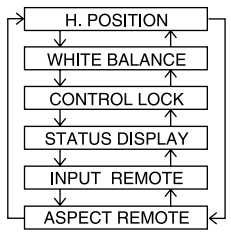

3. Press the VOLUME/SELECT buttons to set.

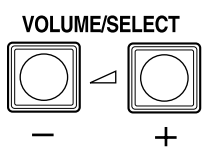

Front panel button	Function displayed	Contents
VOLUME/SELECT (+)	+	Increase (to max. value)
	▶	Forward the setting value
VOLUME/SELECT (-)	CUTO	Selects CUT OFF setting screen
	-	Decrease (to min. value)
	◀	Reverse the setting value
	DRV	Selects DRIVE setting screen

Notes:

- To adjust the white balance, select WHITE BALANCE and press the VOLUME/SELECT (+) or (-) button to display the CUT OFF or DRIVE setting screen, then adjust each setting.
- Press the EXIT (MENU) button to return to the <SET-UP MENU> screen.

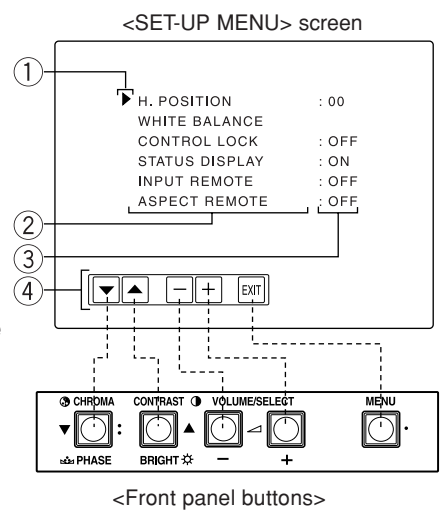

- ① Selection mark (▶): Indicates the menu item you select.
- ② Menu item: Menu items you can select.
- ③ Setting display: Indicates the current settings (value).
- ④ Function display: The functions of the front panel buttons (5 buttons on the left) correspond to the function displayed.

Function displayed	Contents
▼	Forward the menu item.
▲	Reverse the menu item.
-	Lower the adjustment value. (to the minimum)
+	Raise the adjustment value. (to the maximum)
▶	Forward the setting value.
◀	Reverse the setting value.
EXIT	Exit the <SET-UP MENU> screen. (release)
DRV	Selects DRIVE adjustment.
CUTO	Selects CUT OFF adjustment.
R·B	Adjusts red and blue signal level.
RGB	Adjusts red, green and blue signal level.
DISP	Turns the ON-SCREEN display on or off. (This function is effective only in the DRIVE or CUT OFF adjustment mode.)

ENGLISH

HOW TO USE THE MENU FUNCTIONS (cont'd)

Set-up menu items	Purpose	Settings
H. POSITION	Adjusts the horizontal position of the screen (+ : Horizontal position shifts to the right/-: Horizontal position shifts to the left)	-05 ↔ -04 ←.....→ -01 ↔ 00 ↔ +01 ←.....→ +04 ↔ +05
WHITE BALANCE	Adjusts the white balance	Selects DRIVE (DRV) or CUT OFF (CUTO) adjustment. Screen setting is changed to the selected setting mode.
DRIVE R.DRIVE	Adjusts red level	-09 ↔ -08 ←.....→ -01 ↔ 00 ↔ +01 ←.....→ +08 ↔ +09
B.DRIVE	Adjusts blue level	-09 ↔ -08 ←.....→ -01 ↔ 00 ↔ +01 ←.....→ +08 ↔ +09
CUT OFF R. CUT OFF	Adjusts red cut off	-09 ↔ -08 ←.....→ -01 ↔ 00 ↔ +01 ←.....→ +08 ↔ +09
G. CUT OFF	Adjusts green cut off	-09 ↔ -08 ←.....→ -01 ↔ 00 ↔ +01 ←.....→ +08 ↔ +09
B. CUT OFF	Adjusts blue cut off	-09 ↔ -08 ←.....→ -01 ↔ 00 ↔ +01 ←.....→ +08 ↔ +09
CONTROL LOCK	Sets the operation buttons on the front panel to control lock mode	OFF ↔ ON
STATUS DISPLAY	Sets the status display of the color system	ON ↔ OFF
INPUT REMOTE	Sets external control of input selection (INPUT A/B)	OFF ↔ ON
ASPECT REMOTE	Sets external control of the aspect ratio	OFF ↔ ON

4. To set the other set-up menu items, repeat the procedures 2 and 3.

5. Press the MENU button to quit.

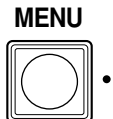

Front panel button	Function displayed	Contents
MENU	EXIT	Quit (or Release) the <MENU> screen

Notes:

- When the CONTROL LOCK function is set to ON, pressing operation buttons on the front panel will display the message "CONTROL LOCK ON!" on the screen for about 3 seconds.
- The CONTROL LOCK function is maintained even when the power is turned off.
- To turn off the CONTROL LOCK function, while holding the MENU button press the CHROMA/PHASE button. Then set the CONTROL LOCK function to OFF.
- Even when the CONTROL LOCK function is set to ON, the following operations are available:
 - Power Switch operation
 - Volume control with the VOLUME/SELECT buttons
 - External control when INPUT REMOTE or ASPECT REMOTE is valid
 - Display or disappear of the <SET-UP MENU> screen.
- The STATUS DISPLAY function can be set to display (ON) or not display (OFF) the present color system when the power is turned on or the input signal is changed. Refer to page 7 for more information.
- When the INPUT REMOTE function is valid (ON), pressing the Input A or Input B buttons will display the message "REMOTE ON!" on the screen for about 3 seconds.
- To enable INPUT REMOTE or ASPECT REMOTE, select the function on the <SET-UP MENU> screen and set to ON.

HOW TO INITIALIZE THE SETTING

SCREEN DISPLAY AND SELECTIONS IN THE <SET-UP MENU> RESET MODE

You can set <MENU> and <SET-UP MENU> screen items, picture adjustment items and the volume level to their factory-set (initial) values.

1. Press the Power (ⓘ) switch to turn the power OFF (■).

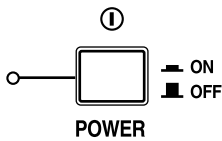

2. While pressing both MENU button and CHROMA/PHASE button, press the Power (ⓘ) switch to turn the power ON (■).

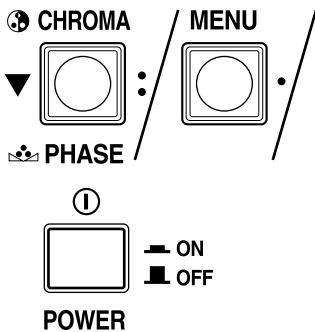

The <SET-UP MENU> RESET screen is displayed.
* The screen automatically disappears when no operation is performed after about 5 minutes.

Note:

- The <SET-UP MENU> RESET screen will not be displayed if the MENU or CHROMA/PHASE buttons are pressed for a very short time. Keep pressing them until the display screen appears.

3. Setting

- Initialization is required.

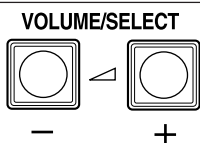

Press the VOLUME/SELECT [+] button.
* Initialization is completed, and the <SET-UP MENU> RESET screen disappears.

- Initialization is not required.

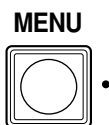

Press the MENU button.
* Initialization is aborted, and the <SET-UP MENU> RESET screen disappears.

<SET-UP MENU> RESET screen

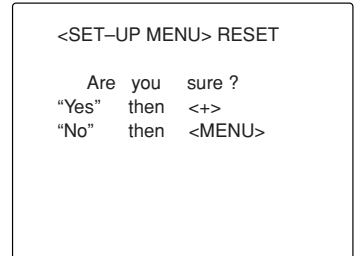

Initial settings

Sorts	Functions (Items)	Initialization (setting)
<MENU> screen	SHARPNESS	+03
	COLOR SYSTEM	AUTO
	ASPECT RATIO	4-3
	COLOR TEMP.	6500
<SET-UP MENU> screen	H. POSITION	00
	WHITE BALANCE	
	R. CUT OFF	00
	G. CUT OFF	00
	B. CUT OFF	00
	R. DRIVE	00
	B. DRIVE	00
	CONTROL LOCK	OFF
	STATUS DISPLAY	ON
INPUT REMOTE	OFF	
ASPECT REMOTE	OFF	
Picture adjustment	PHASE	00
	CHROMA	00
	CONTRAST	00
	BRIGHT	00
Volume	VOLUME	20

BASIC CONNECTION EXAMPLE

Notes:

- Before connecting your system, make sure that all units are turned off.
- The illustration below shows some examples of different connections. Terminal connections may differ depending on the component connected. Be sure to refer to the instructions provided with the unit(s) you are connecting.
- Each pair of input (IN) and output (OUT) terminals are bridge-connected.
- If you're not connecting any equipment to a bridged output (OUT) terminal, be sure not to connect any other cables to the bridged output (OUT) terminal as this will cause the terminating resistance switch to open (auto terminate function).
- When making a bridge connection, connect the input (IN) and output (OUT) terminals on the monitor to separate video components. (For example, if both terminals are connected to the same VCR, resonance may occur except during playback. This is caused by the same video signal "looping" between the VCRs, and is not a malfunction.)
- Select the video input (INPUT A (VIDEO) or INPUT B (VIDEO)) with the INPUT SELECT buttons on the front panel.
- The ASPECT RATIO or INPUT A/B settings can be controlled via the REMOTE terminal by setting ASPECT REMOTE or INPUT REMOTE in the <SET-UP MENU> screen to valid. (Refer to pages 9 and 10.)

VIDEO A Connection Example (Select Input A (VIDEO))

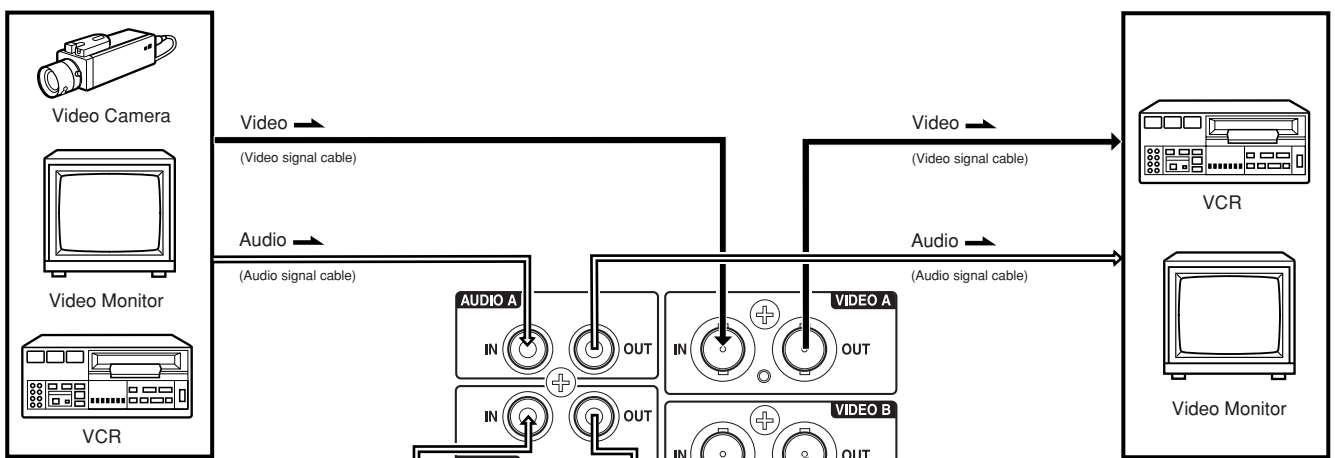

VIDEO B (VIDEO) Connection Example (Select Input B (VIDEO))

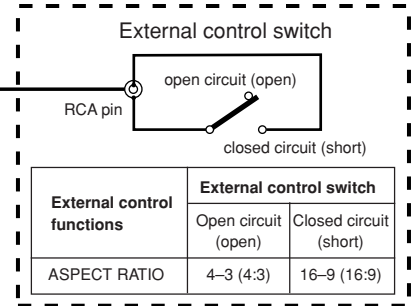
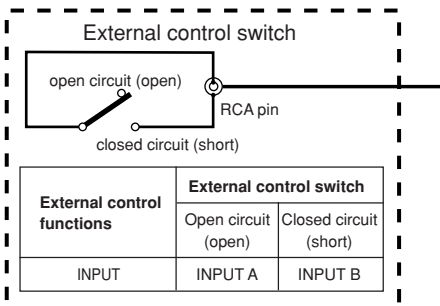
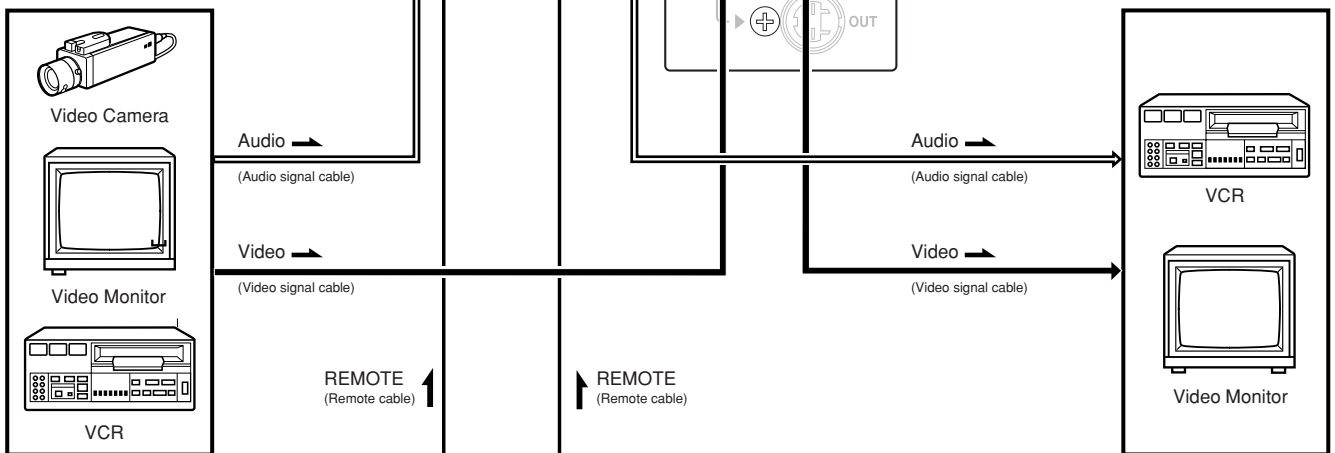

➡ : Signal Flow

■ VIDEO B (Y/C) Connection Example (Select Input B (Y/C))

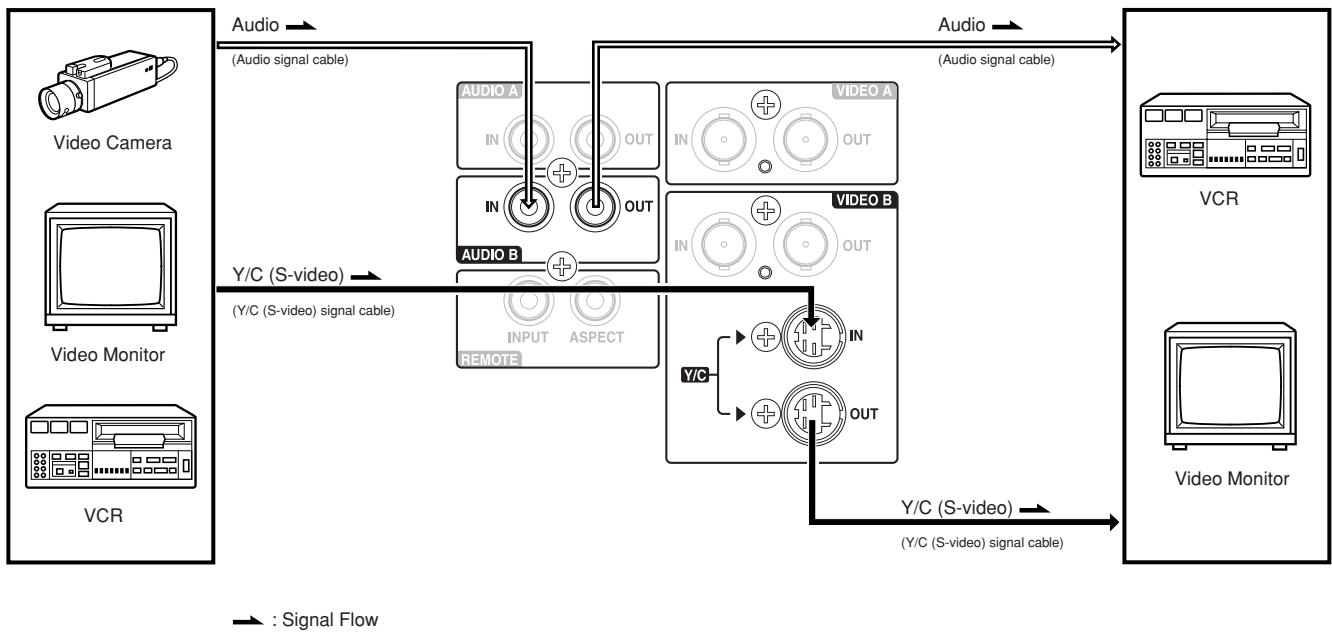

TROUBLESHOOTING

Solutions to common problems related to your monitor are described here. If none of the solutions presented here solves the problem, unplug the monitor and consult a JVC-authorized dealer or service center for assistance.

Problems	Points to be checked	Measures (Remedy)
No power supply.	Is the power plug loosened or disconnected?	Firmly insert the power plug.
No picture with the power on.	Is the video signal output from the connected component?	Set the connected component correctly.
	Is the input signal selected properly?	Select the required video signal input with the Input select button. (See page 7.)
	Is the video cable disconnected?	Connect the video signal cable firmly. (See page 12 and 13.)
No sound.	Is the audio signal output from the connected component?	Set the connected component correctly.
	Is the volume output set to minimum?	Adjust the speaker volume with the VOLUME/SELECT button. (See page 7.)
	Is the audio cable disconnected?	Connect the audio signal cable firmly. (See page 12 and 13.)
Shaking picture.	Is the monitor close to a device generating a strong magnetic field?	Move the device away from the monitor until the picture stabilizes.
No colors, wrong color, or dark picture.	Is the color system selected properly?	Set COLOR SYSTEM in the <MENU> screen to AUTO. (See page 8.)
	Has the picture control setting (CONTRAST, BRIGHT, CHROMA or PHASE) been changed?	Set each picture control to the standard setting. (See page 7.)
Unnatural, irregularly colored, or distorted picture.	Is the monitor close to a speaker, magnet or any other device generating a strong magnetic field?	Move the device away from the monitor and turn the monitor's power off. Wait at least 30 minutes, then turn the power on again.
Dark stripes appear at the top and bottom of the screen, picture vertically squeezed.	Is the aspect ratio set to 16:9?	Set ASPECT RATIO in the <MENU> screen to [4 – 3 (4 : 3)]. (See page 8.) When controlling externally, ASPECT RATIO should be set to [4 – 3 (4 : 3)]. (See page 12.)
Function buttons on the front panel do not function.	Has control of the buttons been locked? (Has the CONTROL LOCK function been set to ON?)	Set CONTROL LOCK in the <SET-UP MENU> screen to OFF. (See pages 9 and 10.)
The INPUT SELECT buttons do not function.	Is input selection under external control? (Has the INPUT REMOTE function been set to valid (A/B)?)	Set INPUT REMOTE in the <SET-UP MENU> screen to OFF. (See pages 9 and 10.)

The following are not malfunctions:

- When a bright still image (such as a white cloth) is displayed for a long period, it may appear to be colored. This is due to the structure of the cathode ray tube and will be deleted when another image is displayed.
- You experience a mild electric shock when you touch the picture tube. This phenomenon is due to a normal buildup of static electricity on the CRT and is not harmful.
- The monitor emits a strange sound when the room temperature changes suddenly. This is only a problem if an abnormality appears on the screen as well.
- If two or more monitors are operated next to each other, their images may shake or be distorted. This phenomenon is due to mutual interference; it is not a malfunction. Move the monitors away from each other until the interference disappears or turn the power off on any monitor that is not being used.

SPECIFICATIONS

MODEL		TM-A210G
Type		Color video monitor
Colour system		PAL, NTSC (3.58)
Picture tube		54 cm measured diagonally, flat-square type, 90° deflection, in-line gun, vertical line trio type (phosphor stripe pitch H/V: 0.63/0.64 mm)
Effective screen size		Width 406.4 mm (16") Height 304.8 mm (12") Diagonal 508 mm (20")
Scanning frequency		H: 15.734 kHz (NTSC), 15.625 kHz (PAL) V: 59.94 Hz (NTSC), 50 Hz (PAL)
Horizontal resolution		450 TV lines or more
Input terminals	VIDEO A	Composite video: 1 line, BNC connector x 2, 1 V(p-p), 75 Ω, negative sync (bridge connection possible, auto termination)
	VIDEO B <small>When both VIDEO B terminals are connected (input) at the same time, the Y/C terminal has priority.</small>	Composite video: 1 line, BNC connector x 2, 1 V(p-p), 75 Ω, negative sync (bridge connection possible, auto termination)
		Y/C-separated: 1 line, mini-DIN 4-pin connector x 2 Y: 1.0 V(p-p), 75 Ω, negative sync C: burst 0.286 V(p-p), 75 Ω (NTSC), 0.3 V(p-p), 75 Ω (PAL) (bridge connection possible, auto termination)
	AUDIO A	1 line (monaural), RCA pin x 2, 0.5 V(rms), high-impedance (bridge connection possible)
	AUDIO B	1 line (monaural), RCA pin x 2, 0.5 V(rms), high-impedance (bridge connection possible)
	REMOTE	2 line, RCA pin x 2
Audio power output		1 W (nominal)
Built-in speaker		8 cm round x 1, impedance of 8 Ω
Environmental conditions		Operation temperature: 0 to 40 °C Operation humidity: 20 to 80% (non-condensing)
Power requirements		120 V AC / 220 – 240 V AC, 50 Hz/60 Hz
Power consumption		1.3 A (120 V AC), 0.9 A (220 – 240 V AC)
Dimensions		Width 476 mm (18-3/4") Height 407.5 mm (16-1/8") Depth 492 mm (19-3/8")
Weight		28.1 kg (61.8 lbs)
Accessory		AC power cord

* Illustrations used in this manual are for explanatory purposes only. The appearance of the actual product may differ slightly.

* Dimensions and weight are approximate.

* E. & O. E. Design and specifications subject to change without notice.

■ Dimensions

Unit : mm (inch)

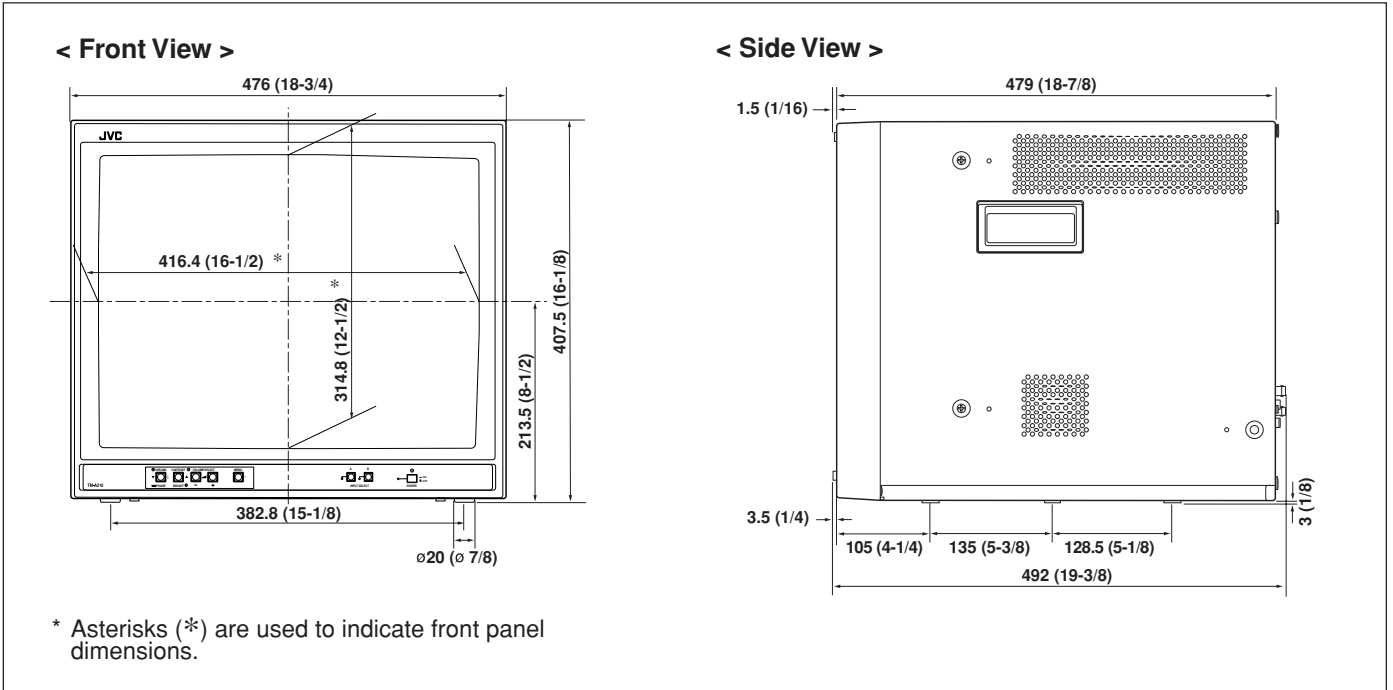

■ Y/C (Mini DIN 4 pin) terminal specification

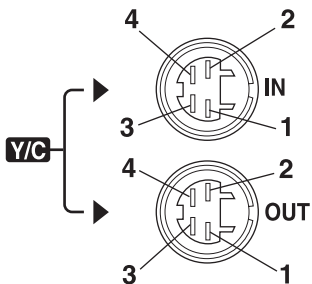

Pin No.	Signal
1	GND (Y)
2	GND (C)
3	Y
4	C



Free Manuals Download Website

<http://myh66.com>

<http://usermanuals.us>

<http://www.somanuals.com>

<http://www.4manuals.cc>

<http://www.manual-lib.com>

<http://www.404manual.com>

<http://www.luxmanual.com>

<http://aubethermostatmanual.com>

Golf course search by state

<http://golfingnear.com>

Email search by domain

<http://emailbydomain.com>

Auto manuals search

<http://auto.somanuals.com>

TV manuals search

<http://tv.somanuals.com>