

# JVC



## DVD VIDEO PLAYER

# XV-S200BK

Introduction	2
Preliminary knowledge	5
Getting started	13
Basic operations	17
Advanced operations	20
MP3 CD playback	35
Initial settings	39
Additional information	46

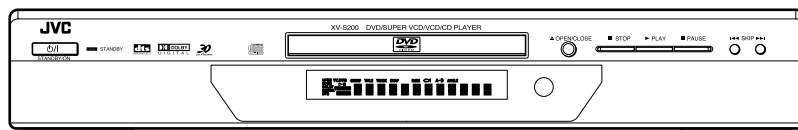
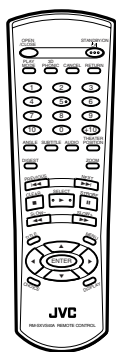

## INSTRUCTIONS

### For Customer Use:

Enter below the Model No. and Serial No. which are located on the rear, bottom or side of the cabinet. Retain this information for future reference.

Model No. \_\_\_\_\_

Serial No \_\_\_\_\_

GNT0017-001B

[J]

# Warnings, Cautions and Others

## Mises en garde, précautions et indications diverses



The lightning flash with arrowhead symbol, within an equilateral triangle is intended to alert the user to the presence of uninsulated "dangerous voltage" within the product's enclosure that may be of sufficient magnitude to constitute a risk of electric shock to persons.



The exclamation point within an equilateral triangle is intended to alert the user to the presence of important operating and maintenance (servicing) instructions in the literature accompanying the appliance.

### For U.S.A.

This equipment has been tested and found to comply with the limits for a Class B digital device, pursuant to part 15 of the FCC Rules. These limits are designed to provide reasonable protection against harmful interference in a residential installation.

This equipment generates, uses and can radiate radio frequency energy and, if not installed and used in accordance with the instructions, may cause harmful interference to radio communications. However, there is no guarantee that interference will not occur in a particular installation. If this equipment does cause harmful interference to radio or television reception, which can be determined by turning the equipment off and on, the user is encouraged to try to correct the interference by one or more of the following measures:

Reorient or relocate the receiving antenna.

Increase the separation between the equipment and receiver.

Connect the equipment into an outlet on a circuit different from that to which the receiver is connected.

Consult the dealer or an experienced radio/TV technician for help.

**WARNING: TO REDUCE THE RISK OF FIRE OR ELECTRIC SHOCK, DO NOT EXPOSE THIS APPLIANCE TO RAIN OR MOISTURE.**

### For Canada/pour le Canada

**CAUTION:** TO PREVENT ELECTRIC SHOCK, MATCH WIDE BLADE OF PLUG TO WIDE SLOT, FULLY INSERT

**ATTENTION:** POUR EVITER LES CHOCS ELECTRIQUES, INTRODUIRE LA LAME LA PLUS LARGE DE LA FICHE DANS LA BORNE CORRESPONDANTE DE LA PRISE ET POUSSER JUSQU'AU FOND

### For Canada/pour le Canada

THIS DIGITAL APPARATUS DOES NOT EXCEED THE CLASS B LIMITS FOR RADIO NOISE EMISSIONS FROM DIGITAL APPARATUS AS SET OUT IN THE INTERFERENCE-CAUSING EQUIPMENT STANDARD ENTITLED "DIGITAL APPARATUS", ICES-003 OF THE DEPARTMENT OF COMMUNICATIONS. CET APPAREIL NUMERIQUE RESPECTE LES LIMITES DE BRUITS RADIOELECTRIQUES APPLICABLES AUX APPAREILS NUMERIQUES DE CLASSE B PRESCRITES DANS LA NORME SUR LE MATERIEL BROUILLEUR: "APPAREILS NUMERIQUES", NMB-003 EDICTEE PAR LE MINISTRE DES COMMUNICATIONS.

### CAUTION

To reduce the risk of electrical shocks, fire, etc.:

1. Do not remove screws, covers or cabinet.
2. Do not expose this appliance to rain or moisture.

### ATTENTION

Afin d'éviter tout risque d'électrocution, d'incendie, etc.:

1. Ne pas enlever les vis ni les panneaux et ne pas ouvrir le coffret de l'appareil.
2. Ne pas exposer l'appareil à la pluie ni à l'humidité.

### Caution — STANDBY/ON switch!

Disconnect the mains plug to shut the power off completely. The STANDBY/ON  switch in any position does not disconnect the mains line. The power can be remote controlled.

### Attention — Commutateur STANDBY/ON !

Déconnecter la fiche de secteur pour couper complètement le courant.

Le commutateur STANDBY/ON  ne coupe jamais complètement la ligne de secteur, quelle que soit sa position. Le courant peut être télécommandé.

### IMPORTANT FOR LASER PRODUCTS IMPORTANT POUR LES PRODUITS LASER

1. CLASS 1 LASER PRODUCT
2. **DANGER:** Visible laser radiation when open and interlock failed or defeated. Avoid direct exposure to beam.
3. **CAUTION:** Do not open the top cover. There are no user service-able parts inside the Unit; leave all servicing to qualified service personnel.
1. PRODUIT LASER CLASSE 1
2. **ATTENTION:** Radiation laser visible quand l'appareil est ouvert ou que le verrouillage est en panne ou désactivé. Eviter une exposition directe au rayon.
3. **ATTENTION:** Ne pas ouvrir le couvercle du dessus. Il n'y a aucune pièce utilisable à l'intérieur. Laisser à un personnel qualifié le soin de réparer votre appareil.

### CAUTION

- Do not block the ventilation openings or holes. (If the ventilation openings or holes are blocked by a newspaper or cloth, etc., the heat may not be able to get out.)
- Do not place any naked flame sources, such as lighted candles, on the apparatus.
- When discarding batteries, environmental problems must be considered and local rules or laws governing the disposal of these batteries must be followed strictly.
- Do not expose this apparatus to rain, moisture, dripping or splashing and that no objects filled with liquids, such as vases, shall be placed on the apparatus.

### ATTENTION

- Ne bloquez pas les orifices ou les trous de ventilation. (Si les orifices ou les trous de ventilation sont bloqués par un journal un tissu, etc., la chaleur peut ne pas être évacuée correctement de l'appareil.)
- Ne placez aucune source de flamme nue, telle qu'une bougie, sur l'appareil.
- Lors de la mise au rebut des piles, veuillez prendre en considération les problèmes de l'environnement et suivre strictement les règles et les lois locales sur la mise au rebut des piles.
- N'exposez pas cet appareil à la pluie, à l'humidité, à un égouttement ou à des éclaboussures et ne placez pas des objets remplis de liquide, tels qu'un vase, sur l'appareil.

# Table of Contents

<b>Introduction</b> .....	Page 2		
<b>Features</b> .....	2		
<b>Supplied accessories</b> .....	2		
<b>About this instruction manual</b> .....	3		
<b>Notes on handling</b> .....	4		
<b>Preliminary knowledge</b> .....	Page 5		
<b>Names of parts and controls</b> .....	5		
Front panel.....	5		
Remote control unit.....	6		
Display window.....	8		
Rear panel.....	8		
<b>Operational Principles</b> .....	9		
On-screen displays.....	9		
To prevent the monitor from burning out [SCREEN SAVER].....	10		
On-screen guide icons.....	11		
How to use numeric buttons.....	11		
<b>About discs</b> .....	12		
Playable disc types.....	12		
Disc structure.....	12		
<b>Getting started</b> .....	Page 13		
<b>Connections</b> .....	13		
Before making any connections.....	13		
To connect to a TV.....	13		
To connect to a TV with the component video input jacks.....	14		
To connect to an audio amplifier or receiver.....	15		
To connect to audio equipment with a digital input.....	15		
To connect the power cord.....	16		
<b>To install batteries in the remote control unit</b> .....	16		
<b>Basic operations</b> .....	Page 17		
<b>Turning on/off the unit</b> .....	17		
<b>Inserting and removing discs</b> .....	17		
<b>Basic playback</b> .....	18		
To start playback.....	18		
To stop playback completely.....	18		
To stop playback temporarily.....	18		
To advance or reverse playback rapidly while monitoring.....	18		
To locate the beginning of the scene or song.....	19		
<b>Resuming playback</b> .....	19		
To memorize the interrupted position.....	19		
To resume playback.....	19		
<b>Advanced operations</b> .....	Page 20		
<b>Playing from a specific position on a disc</b> .....	20		
To locate a desired scene from the DVD menu.....	20		
To locate a desired scene from the menu of the Video CD/SVCD with PBC.....	20		
To locate a desired selection using the numeric buttons.....	21		
To locate a desired selection using ◀◀ or ▶▶.....	21		
To locate a desired scene by specifying the chapter number [CHAP.SEARCH].....	22		
To locate a desired position in the current title or track [TIME SEARCH].....	22		
To locate a desired scene from the display [DIGEST].....	23		
<b>Special picture playback</b> .....	24		
		To advance a still picture frame-by-frame.....	24
		To display continuous still pictures [STROBE].....	24
		To playback in slow-motion [SLOW].....	25
		To zoom a scene [ZOOM].....	25
		<b>Changing the playback order</b> .....	26
		To playback in the desired order [PROGRAM].....	26
		To playback in random order [RANDOM].....	27
		<b>Repeat playback</b> .....	27
		To repeat the current selection or all tracks [REPEAT].....	27
		To repeat a desired part [A-B REPEAT].....	28
		<b>Selecting a scene angle of DVD VIDEO</b> .....	29
		To select a scene angle from the normal screen [ANGLE].....	29
		To select a scene angle from the angle list display [ANGLE].....	30
		<b>Changing the language and sound</b> .....	30
		To select the subtitle language [SUBTITLE].....	30
		To change the audio language or sound [AUDIO].....	31
		<b>Selecting the picture character</b> .....	32
		To select the picture character [THEATER POSITION].....	32
		<b>Enjoying virtual surround sound</b> .....	32
		To simulate surround sound [3D PHONIC].....	32
		<b>Checking the status</b> .....	33
		To check the disc/time information.....	33
		To check the DVD function status.....	34
		<b>To dim the brightness of the display window</b> .....	34
		Dimming brightness of the display window.....	34
		<b>MP3 CD playback</b> .....	Page 35
		<b>About MP3 CD disc</b> .....	35
		<b>Unavailable functions</b> .....	35
		<b>Basic operations</b> .....	35
		Basic operations using the basic control buttons.....	35
		Track/Group selection using the numeric buttons.....	36
		<b>Advanced functions</b> .....	36
		Program playback.....	36
		Random playback.....	37
		Repeat playback.....	38
		Disc/time information.....	38
		<b>Initial settings</b> .....	Page 39
		<b>Selecting preferences</b> .....	39
		How to set preferences.....	39
		LANGUAGE page.....	39
		AUDIO page.....	40
		DISPLAY page.....	41
		SYSTEM page.....	42
		<b>Limiting playback by children</b> .....	43
		To set Parental Lock for the first time [PARENTAL LOCK].....	43
		To change the settings [PARENTAL LOCK].....	44
		To temporarily release the Parental lock [PARENTAL LOCK].....	45
		<b>Additional information</b> .....	Page 46
		<b>Care and handling of discs</b> .....	46
		<b>Troubleshooting</b> .....	47
		<b>Specifications</b> .....	48
		<b>Table of languages and their abbreviations</b> ... Appendix A	
		<b>Country/Area code list for parental lock</b> ..... Appendix B	

## Features

### Picture functions

#### ■ Strobe function

The unit can display nine continuous still pictures on the TV screen.

#### ■ Digest function

You can select the desired selection to be played from the opening scenes displayed on the TV screen.

#### ■ Angle function\*

You can select a desired angle from multiple camera angles recorded on the DVD VIDEO disc.

#### ■ Zoom function

You can view scenes close-up.

#### ■ Parental lock\*

You can restrict the playback of DVD VIDEO discs with scenes which you do not want children to see, such as adult or violent films.

#### ■ Theater position

You can select the picture character according to the lighting of your room.

### Audio functions

#### ■ High quality digital sound

You can enjoy high quality sound with Dolby Digital or Linear-PCM.

#### ■ Surround function\*

The unit accommodates the Dolby Digital and, DTS surround systems.

(These surround signals are output only from the DIGITAL OUT jacks.)

#### ■ 3D Phonic function

You can enjoy surround sound with your 2-channel system.

### Other functions

#### ■ Multi-language subtitles and sound\*

You can select a subtitle or sound language from those recorded on the DVD VIDEO disc.

#### ■ Multi-disc playback

You can enjoy Audio CD, Video CD and SVCD discs as well as DVD VIDEO discs.

In addition, you can also enjoy MP3 CD discs.

#### ■ Operation from the on-screen display

User-friendly on-screen displays allow you to operate the unit easily.

Functions with (\*) mark only work on a DVD VIDEO disc that is compatible with each function.

## Supplied accessories

- Audio/video cable (x 1)



- Remote Control Unit (x 1)

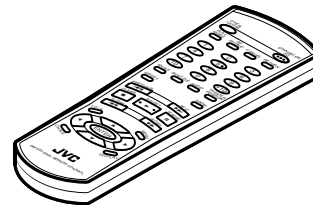

- R6P(SUM-3)/AA(15F) batteries (x 2)

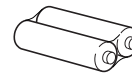

- AC power cord (x 1)

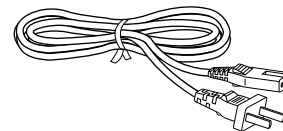

## About this instruction manual

- This instruction manual basically explains operations according to the format as below.
- For operations for MP3 CD discs, see "MP3 CD playback" on and after page 35. The other sections of this manual do not refer to MP3 CD playback.

### To playback in random order [RANDOM]



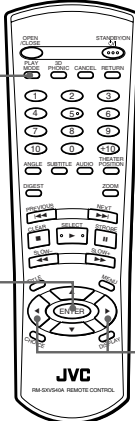

You can play titles or tracks on discs inserted in random order by using the Random function.



■ While stopped

**1** Press **PLAY MODE**.

The play mode menu appears on the TV screen.

**2** Use **CURSOR**   to move  to [RANDOM].

REPEAT   PROGRAM   RANDOM

**3** Press **ENTER**.

The unit starts random playback.  
The "RANDOM" indicator appears in the display window on the front panel. After playing all titles/tracks of the discs, random playback ends.

 **Hints**

- The same title or track will not be played back more than once during random play.

• **To stop/quit random playback in the middle**  
Press **■** to stop playback. The unit is still in random playback mode, so pressing **▶** starts random playback again.  
To quit random playback, press **■** again while stopped. The "RANDOM" indicator in the display window turns off.

**NOTE**

- **Some DVD VIDEO discs may not be played back correctly in the random mode.**

These symbols indicate the types of discs which the operation can be used for.

The number indicates the following procedural step(s) in which the button(s) is(are) used.  
You may also use the corresponding buttons on the front panel of the unit if available.

The number indicates the procedural step.

The names of buttons on the remote control unit (or on the front panel of the unit) are all given in uppercase letters.

Other convenient procedures, etc.

Additional supplemental remarks

# Notes on handling

## Important cautions

### Installation of the unit

- Select a place which is level, dry and neither too hot nor too cold (between 5°C and 35°C, 41°F and 95°F).
- Leave sufficient distance between the unit and the TV.
- Do not use the player in a place subject to vibrations.

### Power cord

- Do not handle the power cord with wet hands!
- A small amount of power\* is always consumed while the power cord is connected to the wall outlet.
- When unplugging the player from the wall outlet, always pull the plug, not the power cord.

\* : For power consumption in standby mode, see "Specifications" on page 48

### To prevent malfunction of the unit

- There are no user-serviceable parts inside. If anything goes wrong, unplug the power cord and consult your dealer.
- Do not insert any metallic object into the unit.
- Do not use any non-standard shape disc available on the market, because it may damage the unit.
- Do not use a disc with tape, seals, or paste on it, because damage to the unit may result.

### Note about copyright laws

- Please check the copyright laws in your country before recording from DVD VIDEO, Audio CD, Video CD, SVCD and MP3 CD discs. Recording of copyrighted material may infringe copyright laws.

### Note about the copyguard system

- The DVD VIDEO disc is protected by the copyguard system. When you connect the unit to your VCR directly, the copyguard system activates and the picture may not be played back correctly.

## Safety precautions

### Avoid moisture, water and dust

Do not place the unit in moist or dusty places.

### Avoid high temperatures

Do not expose the unit to direct sunlight or place it near a heating device.

### When you're away

When away on travel or otherwise for an extended period of time, remove the plug from the wall outlet.

### Do not insert foreign objects into the unit

Do not insert wires, hairpins, coins, etc. into the unit.

### Do not block the vents

Blocking the vents may damage the unit.

### Care of the cabinet

When cleaning the unit, use a soft cloth and follow the relevant instructions on the use of chemically-coated cloths. Do not use benzene, thinner or other organic solvents and disinfectants. These may cause deformation or discoloring.

### If water gets inside the unit

Turn off the power switch and remove the plug from the wall outlet, then call the store where you made your purchase. Using the unit in this state may cause a fire or electrical shock.

This product incorporates copyright protection technology that is protected by method claims of certain U.S. patents and other intellectual property rights owned by Macrovision Corporation and other rights owners. Use of this copyright protection technology must be authorized by Macrovision Corporation, and is intended for home and other limited viewing uses only unless otherwise authorized by Macrovision Corporation. Reverse engineering or disassembly is prohibited.

Manufactured under license from Dolby Laboratories. "Dolby" and double-D symbol are trademarks of Dolby Laboratories.

Confidential Unpublished Works.

© 1992-1998 Dolby Laboratories, Inc. All rights reserved.

Manufactured under license from Digital Theater Systems, Inc. US Pat. No. 5,451,942 and other world-wide patents issued and pending. "DTS", "DTS Digital Surround", are trademarks of Digital Theater Systems, Inc.

© 1996 Digital Theater Systems, Inc. All Rights Reserved.

## Names of parts and controls

Refer to the corresponding pages indicated in () for details.

### Front panel

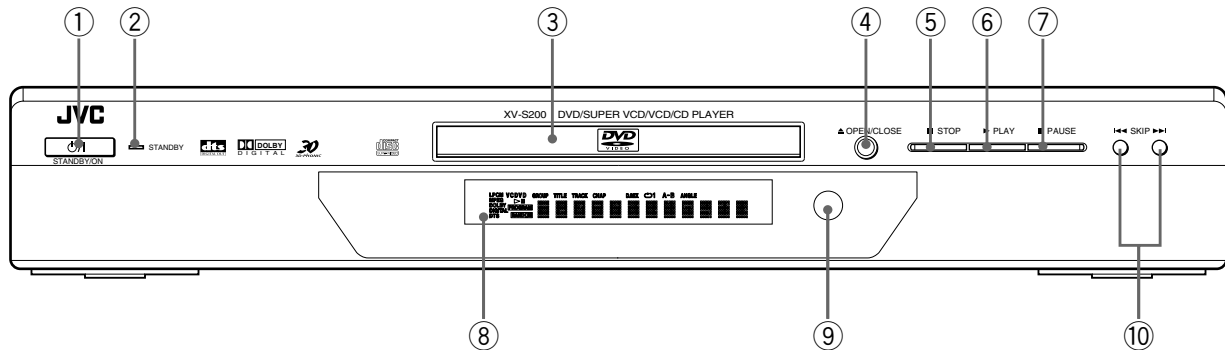

① **STANDBY/ON** button (17)

Turns the unit on or off (standby).

② **STANDBY indicator**

Lights when the power cord is connected and the unit is on standby. When the unit is turned on, the STANDBY indicator goes off.

③ **Disc tray** (17)

Used to load a disc.

④ **▲ (OPEN/CLOSE) button** (17)

Used to open and close the disc tray.

⑤ **■ (STOP) button** (18, 36)

Stops playback.

⑥ **▶ (PLAY) button** (18, 36)

Starts playback. Also, used as a SELECT button for PBC of Video CDs/SVCDs.

⑦ **|| (PAUSE) button** (18, 36)

Pauses playback. Also, used to display nine continuous still pictures (STROBE function).

⑧ **Display window** (8)

Indicates the current status of the unit.

⑨ **Remote sensor**

Receives signals from the remote control unit.

⑩ **◀◀/▶▶ (SKIP) buttons** (18, 36)

Used to skip a chapter, title or track. Also, used for the page selection of a menu screen (for Video CD/SVCD). Holding down ◀◀ or ▶▶ during playback reverses or advances playback rapidly (except MP3 CD).

## Remote control unit

Preliminary knowledge

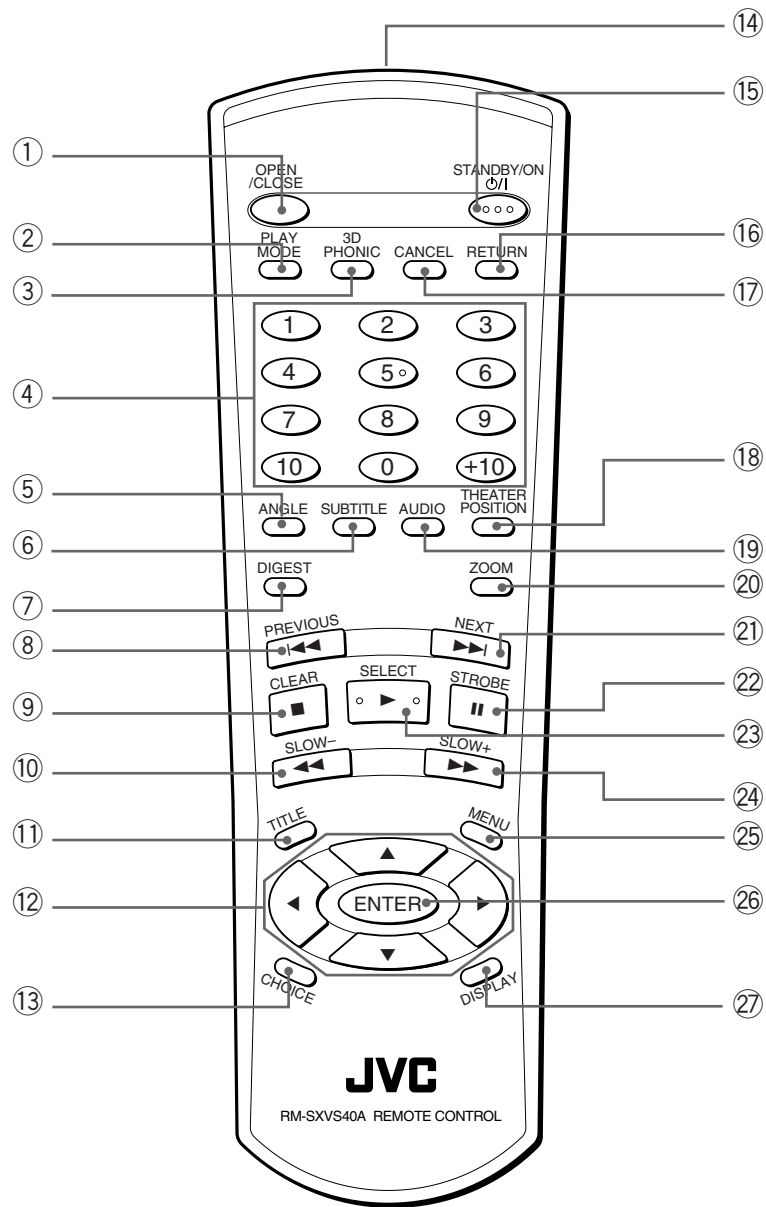



- ① **OPEN/CLOSE button (17)**  
Opens and closes the disc tray.
- ② **PLAY MODE button (22, 26, 27, 28, 36, 37, 38)**  
Displays an on-screen display for controlling the advanced playback functions.
- ③ **3D PHONIC button (32)**  
Produces a simulated surround effect.
- ④ **Numeric buttons (11)**  
Used to select a selection, as well as used to enter a time for the Time search and a chapter number for the Chapter search.
- ⑤ **ANGLE button (29, 30)**  
Changes camera angles during playback of a DVD VIDEO disc containing multiple camera angles (for DVD VIDEO).
- ⑥ **SUBTITLE button (30)**  
Used to display the subtitle selection display on the TV screen, as well as used to turn the subtitle on or off (for DVD VIDEO/SVCD).
- ⑦ **DIGEST button (23)**  
Displays beginning scenes of each title, chapter or track on the TV screen (for DVD VIDEO/Video CD/SVCD).
- ⑧ **◀◀/PREVIOUS button (18, 19, 21, 36)**  
Skips back a chapter, title or track. Also used for the page selection of a menu screen (for DVD VIDEO/Video CD/SVCD).  
Holding down this button during playback reverses playback rapidly (except MP3 CD).
- ⑨ **■/CLEAR button (18, 26, 36, 37)**  
Stops playback. Also used to erase all the programmed selection for the program play.
- ⑩ **◀◀/SLOW- button (18, 25, 36)**  
Pressing this button during playback reverses playback rapidly (except MP3 CD).  
With an MP3 CD disc, pressing this button skips back a Group.  
Pressing this button while a DVD VIDEO disc is paused reverses playback slowly.
- ⑪ **TITLE button (20)**  
Displays the top menu of a DVD VIDEO disc on the TV screen.
- ⑫ **▲ UP, ▼ DOWN, ◀ LEFT, ▶ RIGHT (CURSOR) buttons**  
Used to select an item from a menu or on-screen display, or to change the setting of an item in the on-screen display.  
In this manual, we sometimes call them "CURSOR" buttons.
- ⑬ **CHOICE button (39)**  
Displays the preference on-screen display on the TV screen.
- ⑭ **Infrared signal-emitting window**  
Point this window toward the remote sensor on the front panel when pressing buttons.
- ⑮ **STANDBY/ON ⏻/I button (17)**  
Turns the unit on or off (standby).
- ⑯ **RETURN button (20)**  
Returns to the previous menu (for DVD VIDEO/Video CD/SVCD).
- ⑰ **CANCEL button (26, 37)**  
Cancels the last programmed selection in the Program mode.
- ⑱ **THEATER POSITION button (32)**  
Selects a picture character from 4 options (for DVD VIDEO/Video CD/SVCD).
- ⑲ **AUDIO button (31)**  
Selects the audio (for DVD VIDEO/Video CD/SVCD).
- ⑳ **ZOOM button (25)**  
Zooms in the picture (for DVD VIDEO/Video CD/SVCD).
- ㉑ **▶▶/NEXT button (18, 19, 21, 36)**  
Skips forward a chapter, title or track. Also used for the page selection of a menu screen (for DVD VIDEO/Video CD/SVCD).  
Holding down this button during playback advances playback rapidly (except MP3 CD).
- ㉒ **⏸/STROBE button (18, 24, 36)**  
Pauses playback. Also, used to display nine continuous still pictures (STROBE function).
- ㉓ **▶/SELECT button (18, 20, 36)**  
Starts playback. Also used as a SELECT button for PBC of Video CDs/SVCDs.
- ㉔ **▶▶/SLOW+ button (18, 25, 36)**  
Pressing this button during playback advances playback rapidly (except MP3 CD).  
With an MP3 CD disc, pressing this button skips forward a Group.  
Pressing this button while a DVD VIDEO, Video CD or SVCD disc is paused advances playback slowly.
- ㉕ **MENU button (20)**  
Displays a DVD menu on the TV screen.
- ㉖ **ENTER button**  
Executes the selected item in a menu or on-screen display.
- ㉗ **DISPLAY button (33)**  
Displays the status information (only for DVD disc) or the time information (for any types of discs).

## Display window

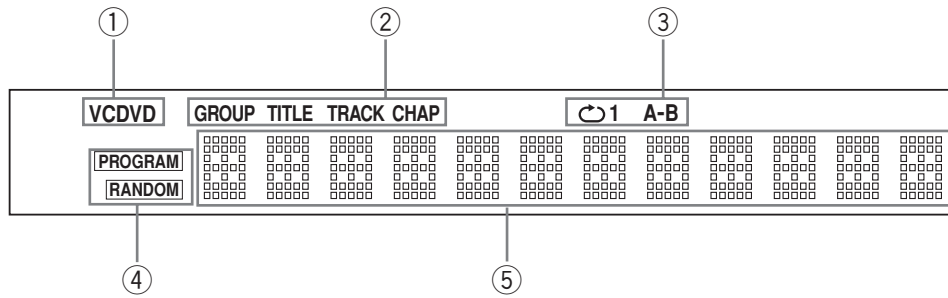

- ① **Disc indicator**  
Indicates the type of the disc set in the tray. When a DVD VIDEO disc is set, "DVD" lights up. When a SVCD or Video CD disc is set, "VCD" lights up. When an Audio CD or MP3 CD disc is set, "CD" lights up.
- ② **Group/title/track/chapter indicators**  
Displays group/title/track, or chapter number.
- ③ **Repeat mode indicators**  
The appropriate indicator illuminates according to the current repeat mode.
- ④ **PROGRAM/RANDOM indicators**  
The appropriate indicator illuminates while the unit is in the Program or Random playback mode.
- ⑤ **Multi-information window**  
Displays the current group/title/track/chapter number(s), time and status information.

## Rear panel

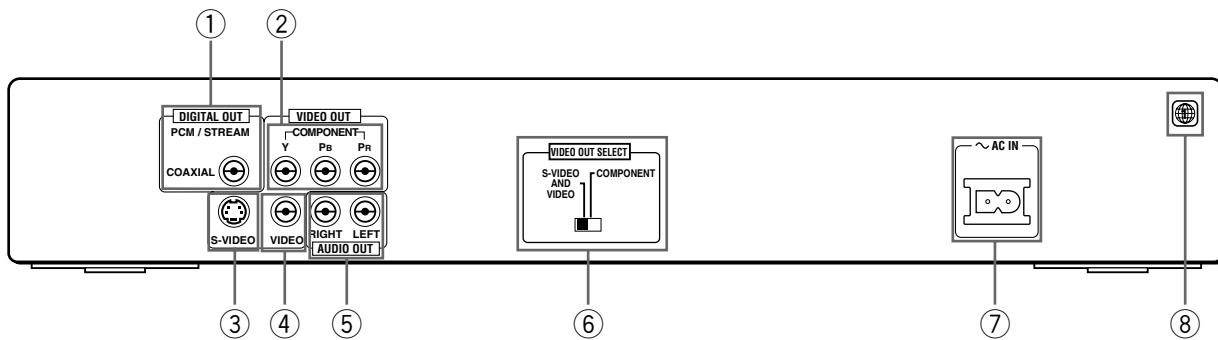

- ① **DIGITAL OUT jack (COAXIAL) (15)**  
Outputs digital audio signals. You must select the type correctly according to the external device connected to via the Preference display.
- ② **COMPONENT VIDEO OUT jacks (Y/Pb/Pr) (14)**  
Output component video signals.  
To enable these jacks, select VIDEO OUT SELECT (COMPONENT/S-VIDEO) switch to "COMPONENT".
- ③ **S-VIDEO OUT jack (13)**  
Outputs a S-video signal.  
To enable this jack, select VIDEO OUT SELECT (COMPONENT/S-VIDEO) switch to "S-VIDEO AND VIDEO".
- ④ **VIDEO OUT jack (13)**  
Outputs a composite video signal.  
To enable this jack, select VIDEO OUT SELECT (COMPONENT/S-VIDEO) switch to "S-VIDEO AND VIDEO".
- ⑤ **AUDIO OUT jacks (LEFT/RIGHT) (13, 14)**  
Outputs stereo analog audio signals.
- ⑥ **VIDEO OUT SELECT switch (COMPONENT/S-VIDEO) (13)**  
Select "COMPONENT or "S-VIDEO AND VIDEO". Note that you must change the switch position while the unit is stopped, or the unit power is off. Otherwise, the changed setting will not be effective.
- ⑦ **~ AC IN connector (16)**  
Connects to the wall outlet using the supplied AC power cord.
- ⑧ **Region Code label (12)**  
Shows Region Code number.

Preliminary knowledge

# Operational Principles

## On-screen displays

The unit provides several on-screen displays. With some displays, you can set or select preferences or functions, while the others are display-only.

### Opening displays

The Opening display appears automatically in some conditions.

At the bottom, the following information are indicated depending on the unit's status.

- NOW READING: The unit is now reading the disc information (TOC).
- REGION CODE ERROR!: The DVD VIDEO disc loaded cannot be played because the region code of the disc does not match the unit.
- OPEN: The disc tray is now opening.
- CLOSE: The disc tray is now closing.

### Preference displays

When no disk is inserted or when a DVD VIDEO or Video CD disk is inserted and stopped, pressing the CHOICE button brings up the preference display for setting the preferences.

There are four pages: LANGUAGE, AUDIO, DISPLAY and SYSTEM as shown on the right.

See page 39 for detailed information.

Opening display

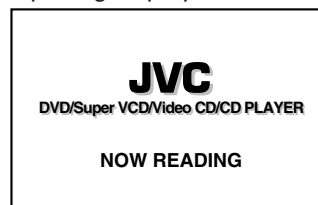

LANGUAGE

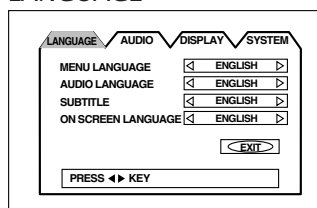

AUDIO

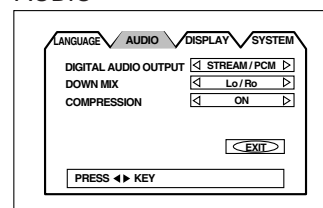

DISPLAY

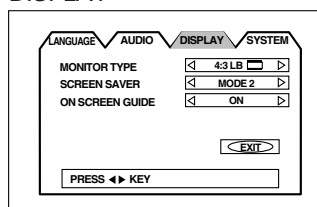

SYSTEM

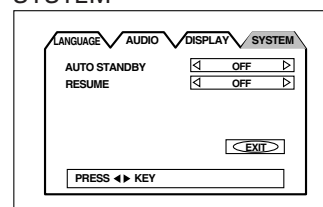

### PARENTAL LOCK display

When no disc is inserted or a DVD VIDEO disc is stopped, pressing the ENTER button while holding down the ■ button brings up the PARENTAL LOCK display in which you can set the level for limiting playback.

See page 43 for detailed information.

PARENTAL LOCK

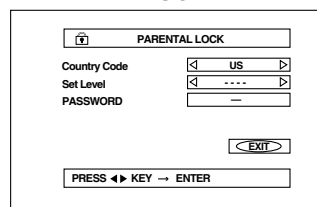

## Play mode displays

Pressing the PLAY MODE button brings up the play mode display in which you can control playback functions. Different displays appear depending on the disc type and the unit's status.

While stopped

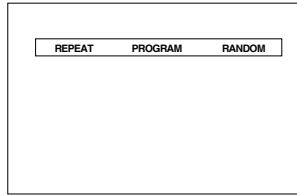

During DVD VIDEO playback

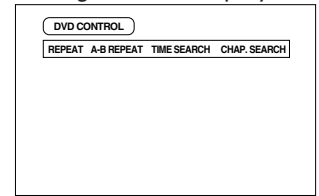

During Audio CD/MP3 CD playback

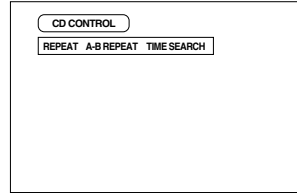

During Video CD/SVCD playback

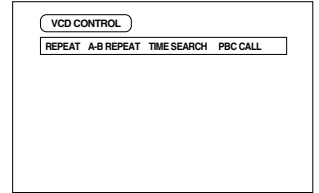

## Status displays

Pressing the DISPLAY button during playback brings up the status display. For a DVD VIDEO disc, pressing the DISPLAY button toggles between the DVD VIDEO function status display, the disc/time display and off. For a Video CD, SVCD, Audio CD or MP3 CD disc, pressing the DISPLAY button switches the disc/time display on and off.

DVD VIDEO function status

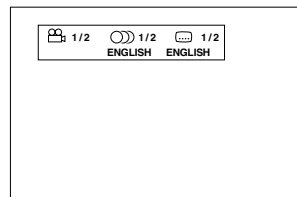

Disc/time (DVD VIDEO)

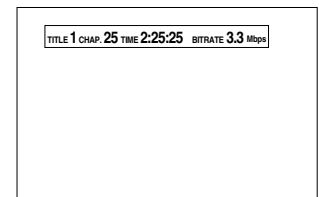

Disc/time (Audio CD/Video CD/SVCD without PBC)

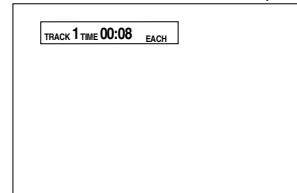

Disc/time (Video CD/SVCD with PBC)

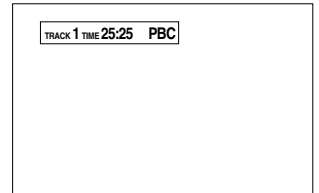

Disc/time (MP3 CD)

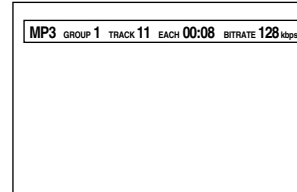

## To prevent the monitor from burning out [SCREEN SAVER]

A television monitor screen may be burned out if a static picture is displayed for a long time. To prevent this, the unit automatically activates the screen saver function if a static picture, such as an on-screen display or menu, is displayed for over 5 minutes.

- Pressing any button on the unit or the remote control unit will release the screen saver function and return to the previous display.
- You can select one of several screen saver modes available (see page 41).
- The screen saver function is not activated during Audio CD playback or after stopping Audio CD playback.

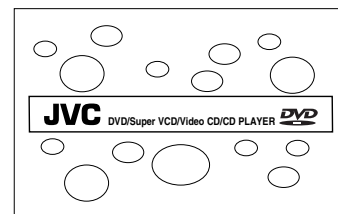

## On-screen guide icons

During DVD VIDEO playback, you may see icons displayed over the picture. These have the following meanings.



: Displayed at the beginning of a scene recorded from multiple angles. (See page 29.)





: Displayed at the beginning of a scene recorded with multiple audio languages. (See page 31.)



: Displayed at the beginning of a scene recorded with multiple subtitle languages. (See page 30.)

You can set the unit not to display on-screen icons above via the preference settings described on page 42.

### About invalid operation icon

When you press a button, if the unit does not accept its operation,  appears on your television screen. Operations are occasionally unacceptable even if  is not displayed.

Note that some operations may not be accepted. For example, some discs may not allow rapid advance/reverse or slow-motion playback.

## How to use numeric buttons

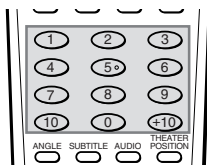

### To select a track/title number

- **To select a number between 1 and 10**  
Press the corresponding button for the number.
- **To select a number higher than 10**  
Use the +10 button.

Examples:

To select 13            +10 → 3

To select 34           +10 → +10 → +10 → 4

To select 40           +10 → +10 → +10 → 10

### To enter a time or chapter number

The method for entering a time for Time search or chapter number for Chapter search is different from above. See the corresponding sections in this manual for the details.





- \* There is another method for selecting a track or group of an MP3 CD disc. See the appropriate section.

# About discs

## Playable disc types

Playable and non-playable disc types are as follows:

### Playable discs

DVD VIDEO 	SVCD 	Video CD 	Audio CD 
------------------------------------------------------------------------------------------------	-------------------------------------------------------------------------------------------	-----------------------------------------------------------------------------------------------	-----------------------------------------------------------------------------------------------

The DVD VIDEO Logo is a trademark.

- CD-R and CD-RW discs recorded with SVCD, Video CD, Audio CD or MP3 format can be played back, though some may not be played back because of the disc characteristics or recording condition.
- DVD VIDEO players and DVD discs have their own Region Code numbers. This unit only can play back DVD VIDEO discs whose Region Code numbers include "1."

Examples of playable DVD VIDEO discs:



This unit accommodates the NTSC television system and can playback discs recorded with the NTSC system. Note that the unit cannot playback the disc recorded with the PAL system.

### Non-playable discs

DVD-ROM, DVD-RAM, DVD AUDIO, DVD-R, DVD-RW, DVD+RW, CD-ROM, PHOTO CD, CD-EXTRA, CD-G, CD-TEXT, SACD

- Playing back discs listed as "Non-playable discs" above may generate noise and damage speakers.
- This unit can play back audio recorded in CD-G, CD-EXTRA and CD-TEXT discs.

## Disc structure

A DVD VIDEO disc is comprised of "titles," while an Audio CD, Video CD or SVCD is comprised of "tracks". Each title may be divided into some "chapters". For example, if a DVD VIDEO disc contains some movies, each movie may have its own title number, and each movie may be divided into some chapters. In a DVD VIDEO karaoke disc, each song usually has its own title number and does not have chapters. In general, each title has independent content, while each chapter in the same title has continuity.

For the MP3 CD disc structure, see page 35.

(Example: DVD VIDEO disc)

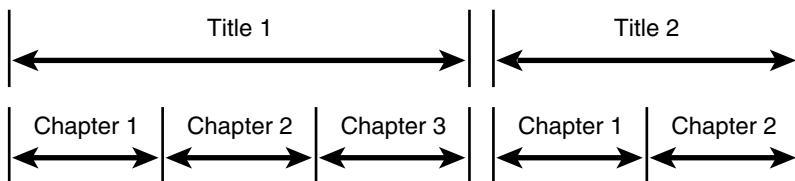

(Example: Audio CD/Video CD/SVCD)

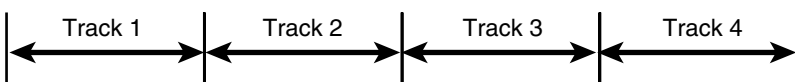

## Connections

- \*In the following description, "TV" may be substituted with "monitor" or "projector."
- \*Before using the unit, you have to connect the unit to a TV and/or amplifier.

### Before making any connections

- Do not connect the AC power cord until all other connections have been made.
- Since different components have different terminal names, carefully read the instructions supplied with the component you are going to connect.

### To connect to a TV

You can enjoy using the unit by simply connecting it to a TV. To improve audio sound quality, connect the audio outputs to your separate audio equipment. (See the following pages.)

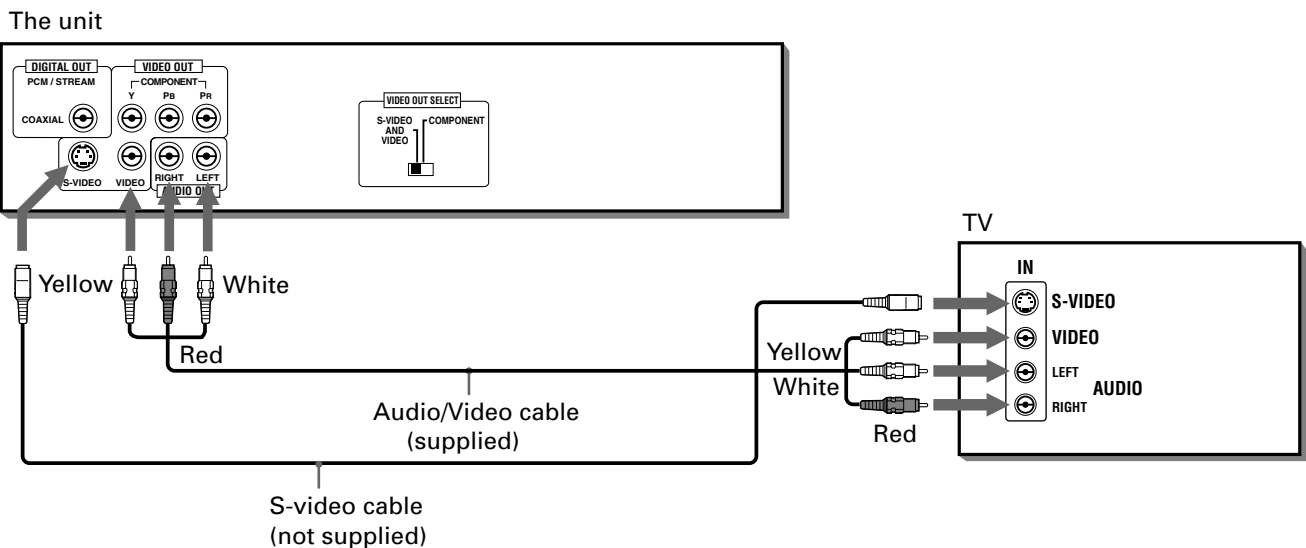

Connect the unit to a TV equipped with stereo audio input and video input jacks using the supplied audio/video cables.

- If your TV has a monaural audio input instead of stereo, you need to use an optional audio cable which converts stereo audio output to monaural.
- If your TV has an S-video input, you should connect it with the S-VIDEO output of the unit using the S-video cable (optional) in addition to the (standard) video connection to get better picture quality.

### Enabling the S-VIDEO output or the VIDEO output

For your TV connection, you can use either the S-video output or the component video output at a time. When you use the S-VIDEO jack or the VIDEO jack, set the VIDEO OUT SELECT (COMPONENT/S-VIDEO) switch on the rear panel to "S-VIDEO AND VIDEO". Then, "S-VIDEO" appears on the display window for a few seconds.

(Display Window)

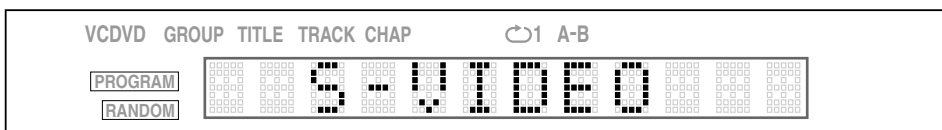

Note that you must change the switch position while the unit is stopped, or the unit power is off. Otherwise, the changed setting is not effective.

#### NOTES

- Connect VIDEO OUT of the unit directly to the video input of your TV. Connecting VIDEO OUT of the unit to a TV via a VCR may cause a monitor problem when playing back a copy-protected disc.
- Connect the unit to an NTSC television. Do not connect the unit to a PAL television.
- When you use the S-VIDEO or VIDEO signal connection, no picture will appear if setting is made to COMPONENT. In this case, switch the setting to S-VIDEO.

## To connect to a TV with the component video input jacks

You can enjoy high picture quality by connecting the unit's COMPONENT VIDEO OUT jacks to the COMPONENT VIDEO IN jacks of your TV with the video cables. Note that the COMPONENT VIDEO OUT jacks are not active in the initial (factory preset) condition. See below for details how to make them active.

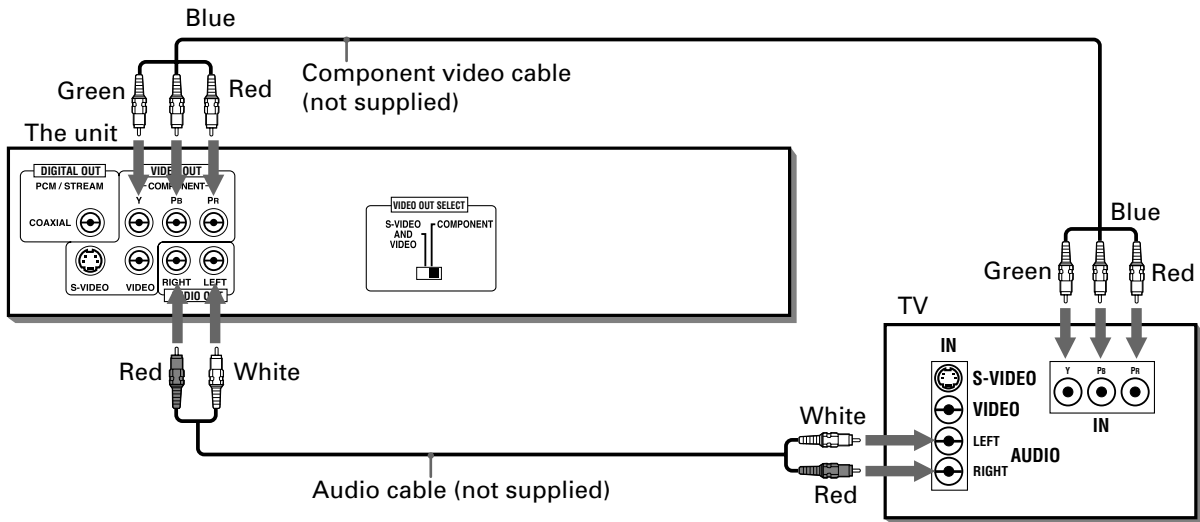

Getting started

- Connect "Y" to "Y," "PB" to "PB," "PR" to "PR" correctly.

### Enabling the COMPONENT VIDEO OUT

For your TV connection, you can use either the component video output or the S-video output at a time. When you use the component video output, set the VIDEO OUT SELECT (COMPONENT/S-VIDEO) switch on the rear panel to "COMPONENT". Then, "COMPONENT" appears on the display window for a few seconds.

(Display Window)

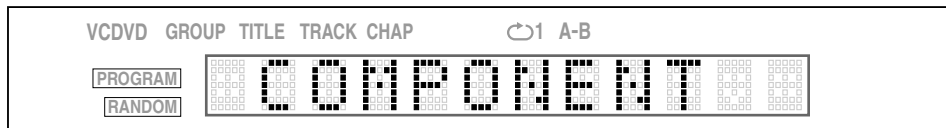

Note that you must change the switch position while the unit is stopped, or the unit power is off. Otherwise, the changed setting is not effective.

#### NOTES

- When the component video input jacks of the TV is the BNC type, use an adapter to convert a pin jack to a BNC jack (optional).
- When you use the component signal connection, the screen will become blue if setting is made to S-VIDEO. In this case, switch the setting to COMPONENT.
- If you switch the VIDEO OUT SELECT switch while the unit power is off with a DVD inserted, depending on the DVD being used, the unit may automatically start playback and the video out is not switched as you expected. In this case, press the ■ button. The unit stops and switching is correctly made according to your switch selection.



## To connect to an audio amplifier or receiver

You can enjoy high-quality audio by connecting the unit's audio output to your amplifier or receiver.

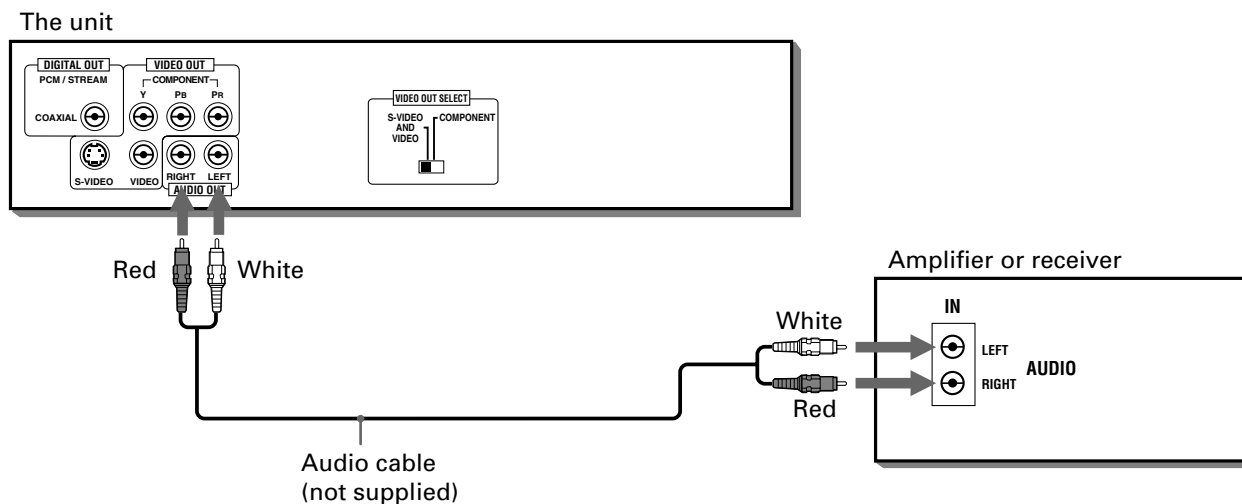

- Connect the unit's AUDIO OUT to any line-level inputs (such as AUX, DVD, CD, etc.) of an audio amplifier or receiver.

## To connect to audio equipment with a digital input

You can enhance the sound quality by connecting the unit's DIGITAL OUT jack (COAXIAL) to the digital input of a receiver, CD Recorder, etc. by using an optional digital cable. The digital audio signal from a disc is directly transferred. If you connect the unit to a Dolby Digital or DTS decoder or an amplifier with a built-in decoder by using an optional digital cable, you can enjoy high-quality surround sound.

When you make the digital connection, we also recommend to make the analog connection, because, depending on discs, no signal may be output from the DIGITAL OUT.

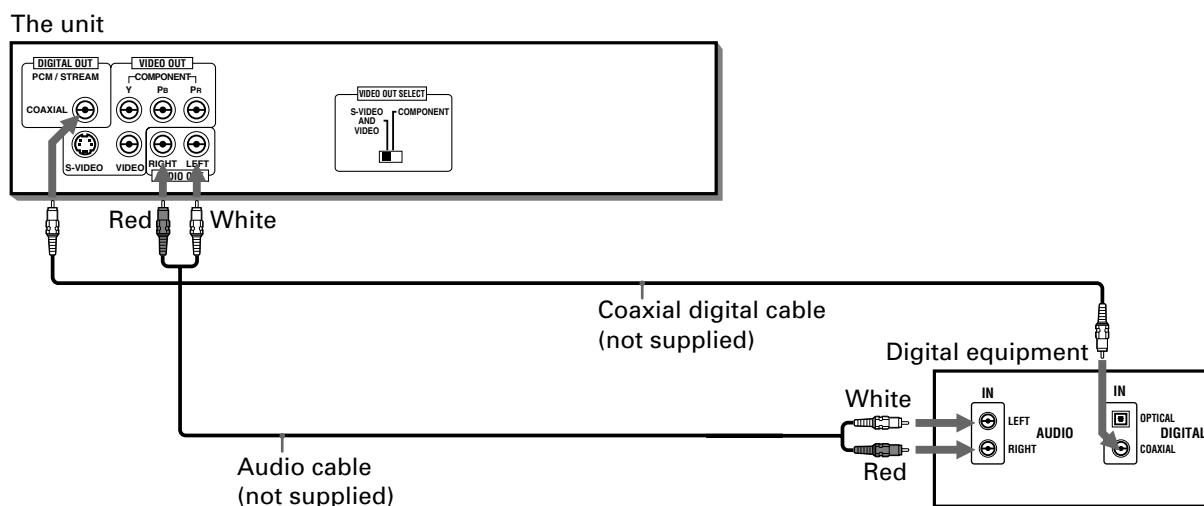

### NOTES

- When you connect the unit's DIGITAL OUT to digital audio equipment, before using, make the "DIGITAL AUDIO OUTPUT" setting in the "AUDIO" page of the preference display correctly according to the connected audio equipment. If the "DIGITAL AUDIO OUTPUT" is not set correctly, loud noise may be generated from speakers, causing damage to your speakers. See "DIGITAL AUDIO OUTPUT" on page 40.
- With the digital connection, the COMPRESSION settings in the AUDIO page of the preference display are invalid. Settings for these items must be made from the decoder.

## To connect the power cord

When all the audio/video connections have been made, insert the smaller plug of the supplied AC power cord to the unit's AC IN connector, then insert the other end to the wall outlet. Make sure that plugs are inserted firmly. The STANDBY indicator lights and setup is completed.

### ⚠ Warning

- Disconnect the power cord if you are not going to use the unit for a long time.
- Disconnect the power cord before cleaning the unit.
- Disconnect the power cord before moving the unit.
- Do not connect or disconnect the power cord with wet hands.
- Do not pull the power cord when disconnecting it, as this may damage the cord and cause fire, electric shock, or other accidents.

### ⚠ Warning

- Do not damage, alter, twist, or pull the power cord, as this may cause fire, electric shock, or other accidents.
- To prevent any accidents or damages caused by an unsuitable AC power cord, only use the supplied power cord. If the cord is damaged, contact a dealer and get the new power cord.
- Do not put anything heavy, or the unit, on the power cord, as this may cause fire, electric shock, or other accidents.

## To install batteries in the remote control unit

The battery compartment is located on the back of the remote control unit.

- 1 Press down on the point shown by the arrow at the top of the compartment cover, and pull up the cover to open the compartment.

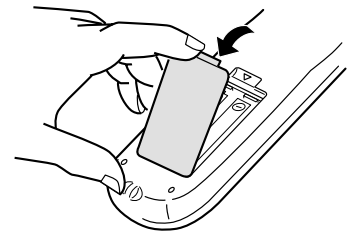

- 2 Place the two accessory R6P (SUM-3)/AA(15F) batteries in the remote control according to the polarity markings ("+" and "-") inside the compartment and on the batteries.

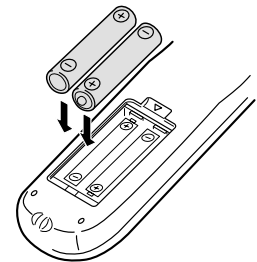

- 3 Place the cover over the compartment, and press down lightly.

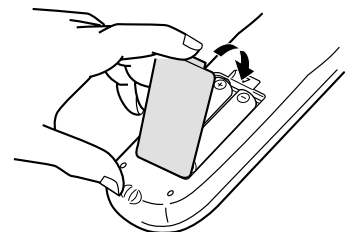

- The batteries will last about six months with normal use. If the functions of the remote control become erratic, replace the batteries. See below for more information.

### Precautions for the safe use of batteries

Observe the following precautions for the safe use of batteries. If they are used improperly their life will be shortened, they may burst or their contents may leak.



#### Precautions

- Remove the batteries from the remote control if it is not going to be used for a long period of time.
- Remove dead batteries and dispose of them properly.
- Never leave dead batteries lying around, take them apart, mix them with other refuse, or throw them into an incinerator.
- Never touch liquid that has leaked out of a battery.
- Do not mix new and old batteries, or batteries of different types, when replacing them.

# Basic operations

In the following description, the buttons on the remote control unit are mainly used, however, you may use the corresponding buttons on the front panel of the unit if available.

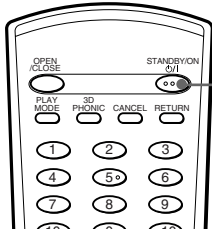

## Turning on/off the unit

Press STANDBY/ON  on the remote control unit or press  on the front panel.





STANDBY/ON 



- You can turn on the unit by pressing the  button. In this case, the unit starts playback if the disc is set in the disc tray.
- If no disc is set, "NO DISC" appears on the display window.
- You can turn on the unit by pressing the  (OPEN/CLOSE) button on the front panel.

### NOTE

- Even if you press the STANDBY/ON  or  button to turn off the unit, the unit is not disconnected from the AC power source as long as it is connected to the wall outlet. This state is called the standby mode. In this state, the unit consumes a very small amount of power.

## Inserting and removing discs

- 1 Press  (OPEN/CLOSE) to open the disc tray.
- 2 Place the disc in the tray.

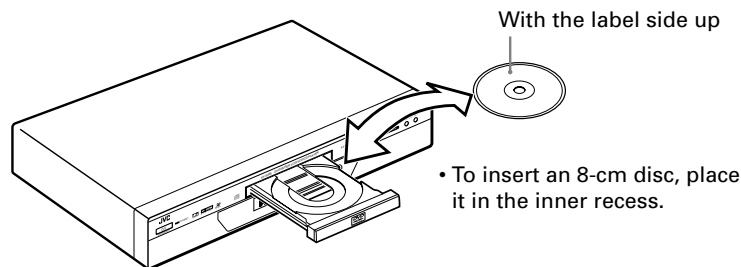

- 3 Press  (OPEN/CLOSE) to close the disc tray.



- If you press  (OPEN/CLOSE) during playback, the unit stops playback and opens the tray.

### NOTES

- The unit can playback DVD VIDEO, Audio CD, Video CD/SVCD and MP3 CD discs only. Do not load other disc types. For details about playable disc types, see page 12.
- When loading a disc in the tray, be sure to position the disc inside the recess. Otherwise, the disc may be damaged when the tray is closed, and the disc may not be removed from the unit.

## Basic playback

Now you can play a disc. First, let's enjoy simple playback using a DVD VIDEO, Audio CD, Video CD or SVCD disc according to the following procedure. For basic operations with an MP3 CD disc, see pages 35.

### To start playback



Press ►.

The unit starts playback from the beginning.

#### NOTES

- When the resume point is memorized, pressing ► starts playback from that point instead of the beginning. See page 19 and 42.
- During playback, the display window shows the title/chapter or track number being played.
- With Video CD/SVCD discs with PBC control or some DVD discs, the menu display may appear on the TV screen after starting playback. In such a case, select an item to be played back from the menu.  
For operation using a menu, see page 20.
- With some DVD discs, the unit starts playback automatically after inserting the disc.

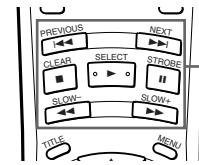

Basic control buttons

### To stop playback completely



Press ■.

The unit stops playback.

### To stop playback temporarily



Press ||.

The unit pauses playback. To resume playback, press ►.

### To advance or reverse playback rapidly while monitoring



■ During playback

#### From the Remote control unit

Press ◀◀ or ▶▶.

Each press of ◀◀ or ▶▶ increases the playback speed. You can select the speed among 2x, 5x, 10x, 20x and 60x the normal speed.

Pressing ► returns the unit to normal playback.

#### From the Front panel

Hold down ◀◀ or ▶▶.

Holding down ▶▶ advances playback rapidly, while holding down ◀◀ reverses playback rapidly. The speed will change from 5x to 20x the normal speed if you keep holding down the button for a certain period of time. Releasing the button returns the unit to normal playback.

## To locate the beginning of the scene or song



### ■ During playback

Press **⏮** or **⏭**.

Press **⏮** to locate the beginning of the current chapter, title, or track, and press **⏭** to locate the beginning of the next chapter, title, or track.

### NOTE

- When you play a Video CD/SVCD disc with the PBC function or a DVD VIDEO disc, the unit may locate a different place, but it will generally locate the beginning of the title, chapter or track.

## Resuming playback

The unit can memorize the position on a disc where you interrupt playback, and resume playback from that position next time you press **▶**.

## To memorize the interrupted position



### 1 Set the “RESUME” setting on the “SYSTEM” page of the preference display to “ON”.

(See page 42 for details about how to set.)

### 2 At the position you want to interrupt playback, press **■**, or press STANDBY/ON **⏻** on the remote control or **⏻** on the front panel.

The unit memorizes the interrupted position.



- If you interrupt playback by pressing **■** in step 2 above and then turn off the power, the memory is not cleared.

## To resume playback



### ■ While the disc you interrupt playback last time is still in the disc tray

Press **▶**.

The unit starts playback from the position where you interrupted playback last time.

### • To clear the resume position memory

Carry out one of the followings.

\*Take out the disc from the tray.

\*Press **■** while stopped.

\*Turn on the unit by pressing STANDBY/ON **⏻** (on the remote control) or **⏻** (on the front panel).

### NOTES

- The resume function does not work with Audio CD and MP3 CD discs.
- The resume function does not work if “RESUME” on the “SYSTEM” page of the preference display is set to “OFF”.
- In the case of a Video CD/SVCD disc with PBC function, the unit may resume playback from a point slightly earlier than the resume point you stored.
- The resume function does not work in the program or random mode.

# Advanced operations

In this section, we describe advanced operations for playback of a DVD VIDEO, Audio CD, Video CD or SVCD disc. For operations with an MP3 CD disc, see pages 35, 36, 37 and 38.

## Playing from a specific position on a disc

You can play a disc from the selected track, title or chapter, or from the specified time.

### To locate a desired scene from the DVD menu



DVD VIDEO discs generally have their own menus which show the disc contents. These menus contain various items such as titles of a movie, names of songs, or artist information, and display them on the TV screen. You can locate a desired scene by using the menu.

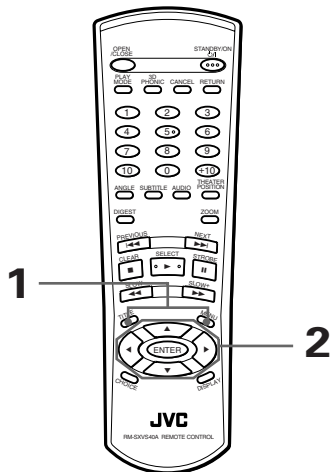

■ Whenever a DVD VIDEO disc is loaded

#### 1 Press TITLE or MENU.

The menu appears on the TV screen.



#### About menu

Normally, a DVD VIDEO disc which contains more than one title may have a "title" menu which lists the titles. In this case, the menu appears on the TV screen by pressing the TITLE button. Some DVD VIDEO discs may also have a different menu which appears by pressing the MENU button.

See the instructions of each DVD VIDEO disc for its particular menu.

#### 2 Use CURSOR ▲/▼/◀/▶ to select a desired item, then press ENTER.

The unit starts playback of the selected item.

Example:

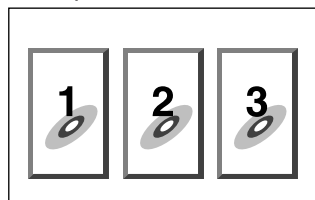

- With some discs, you can also select items by entering the corresponding number using the numeric buttons, which may cause the unit to automatically start playback.

### NOTES

- When appears on the TV screen by pressing TITLE in step 1:  
The disc does not have a menu listing the titles.
- When appears on the TV screen by pressing MENU in step 1:  
The disc does not have a menu.
- The menu button does not work while stopped.

### To locate a desired scene from the menu of the Video CD/SVCD with PBC



Some Video CD/SVCD discs supports the PBC function. PBC is an abbreviation of "PlayBack Control." A Video CD/SVCD disc recorded with PBC has its own menus, such as a list of the songs of the disc. You can locate a specific scene by using the menu.

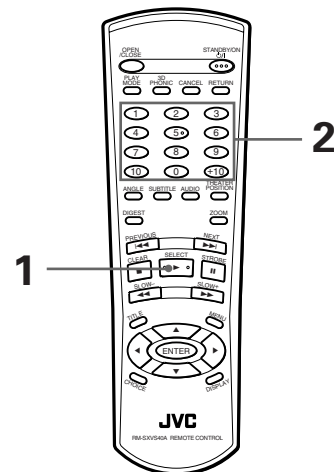

■ When a Video CD/SVCD disc with PBC is stopped

#### 1 Press PBC.

A disc menu appears on the TV screen (The PBC function is activated).

Example:

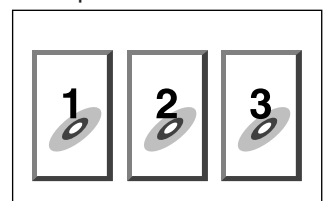

"PBC" is indicated in the display window on the front panel.

#### 2 Use the numeric buttons to select the desired item.

- See page 11 for details about how to use the numeric buttons.

The unit starts playback of the selected item. You can return to the menu by pressing the RETURN button.

When "NEXT" or "PREVIOUS" appears on the TV screen, the unit generally works as follows:

- Pressing ►► advances to the next page.
- Pressing ◀◀ returns to the previous page.
- \* The method of the operation is different depending on the disc.

#### Hints

- If you want to playback a PBC-compatible Video CD/SVCD disc without activating the PBC function, start playback by using the numeric buttons instead of the ► button.
- To activate the PBC function when a PBC-compatible Video CD/SVCD disc is being played back without the PBC function, press ■ then press ►.
- You can also activate the PBC function using the play mode menu display as follows.
  - 1 Press PLAY MODE.
  - 2 Use CURSOR ◀▶ to move ◀ to [PBC CALL], then press ENTER.

## To locate a desired selection using the numeric buttons



You can play a desired title or chapter (DVD VIDEO) or track (Audio CD/Video CD/SVCD) by specifying the number.

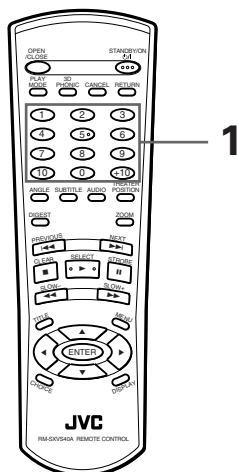

- For DVD VIDEO/Audio CD:  
During playback or while stopped
- For Video CD/SVCD:  
During playback without PBC function or while stopped

### 1 Use the numeric buttons to specify the number.

- \* During DVD VIDEO playback (except when a menu is shown), a chapter is specified.
- \* While a DVD VIDEO is stopped, a title is specified.
- \* For an Audio CD or Video CD, a track is specified.

The unit starts playback from the beginning of the selection.

- See page 11 for details about how to use the numeric buttons.

#### NOTES

- During DVD VIDEO playback, if a menu is shown on the TV screen, the numeric buttons may be used for selecting an item in the menu.
- When ◯ appears on the TV screen:  
The title or track you have selected is not contained in the disc.
- This function does not work during Video CD/SVCD playback with PBC function.

## To locate a desired selection using

◀◀ or ►►

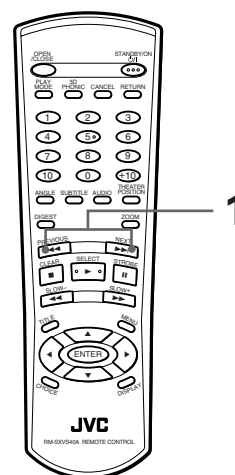

- For DVD VIDEO: During playback
- For Audio CD: During playback
- For Video CD/SVCD:  
During playback without PBC function

### 1 Press ◀◀ or ►►.

With an Audio CD, Video CD or SVCD pressing the button skips a track. With a DVD VIDEO disc, pressing the button skips a chapter or title depending on the disc configuration.

The selection number appears in the display window on the front panel.

- To locate a subsequent selection, press ►► once or repeatedly until the desired selection number appears in the display.
- To locate to beginning of the current selection, press ◀◀ once.
- To locate a former selection, press ◀◀ repeatedly until the desired selection number appears in the display.

#### NOTES

- This function may not work with some DVD VIDEO discs.
- This function does not work during Video CD/SVCD playback with PBC function.

## To locate a desired scene by specifying the chapter number [CHAP.SEARCH]



If the current title of a DVD VIDEO disc being played is divided into chapters, you can skip to a desired chapter by specifying the chapter number using the on-screen display.

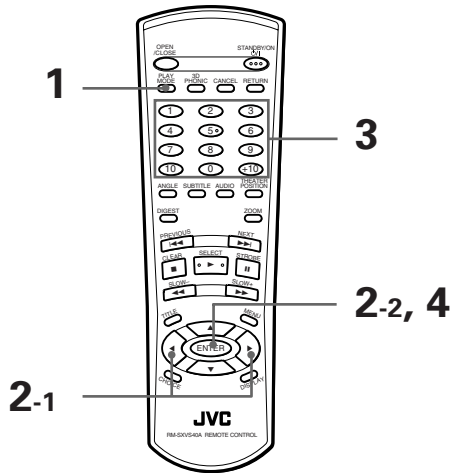

■ During DVD VIDEO playback

### 1 Press PLAY MODE.

The DVD play mode menu appears on the TV screen.

### 2 Use CURSOR ◀▶ to move to [CHAP. SEARCH], then press ENTER.

"GO TO CHAPTER =" appears under the menu.

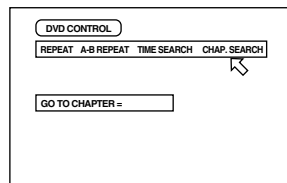

### 3 Use the numeric buttons (0 to 9) to enter the desired chapter number.

Example:

To select chapter number 8:  
Press "8" → ENTER.

To select chapter number 37:  
Press "3" → "7" → ENTER.

### 4 Press ENTER.

The unit starts playback from the selected chapter.



- The "10" and "+10" buttons are not used in this function.

## NOTES

- You can also locate a desired chapter directly by specifying the chapter number using the numeric buttons during playback (except when a menu is shown). See page 21.
- When the chapter number is incorrect in step 3: Overwrite the incorrect number with the correct number.
- When ⓪ is displayed in the TV screen in step 4: The chapter you have selected is not contained in the disc, or chapter search does not work on the disc.
- To turn off the play mode menu: Press PLAY MODE.

## To locate a desired position in the current title or track [TIME SEARCH]



You can play a disc from the desired position by specifying the elapsed time from the beginning of the current title or track using the TIME SEARCH function. Note that some DVD VIDEO discs do not contain time information, and the TIME SEARCH function cannot be used.

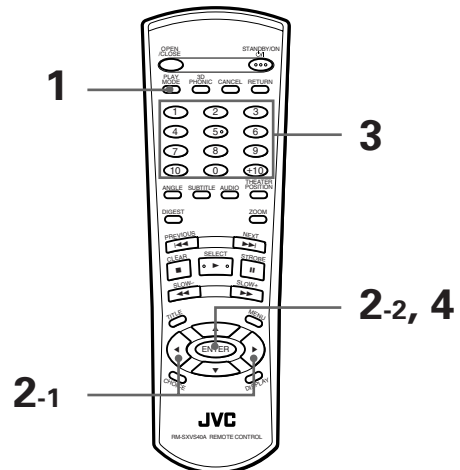

- For DVD VIDEO: During playback
- For Audio CD: During playback
- For Video CD/SVCD: During playback without PBC function

### 1 Press PLAY MODE.

The play mode menu appears on the TV screen.

### 2 Use CURSOR ◀▶ to move to [TIME SEARCH], then press ENTER.

"GO TO" appears under the menu.



### 3 Use the numeric buttons (0 to 9) to enter the time.

You can specify the elapsed time of the current title or track to set the location which you want to playback from.

### 4 Press ENTER.

The unit starts playback from the specified time.

(for DVD VIDEO)

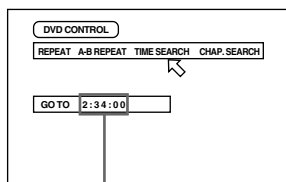

Selected time

(for Audio CD)

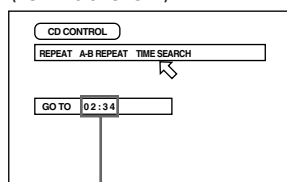

Selected time



- "10" and "+10" buttons are not used in this function.
- You can specify the time in hour/minute/second format for DVD VIDEO discs, and in minute/second format for Audio CD, Video CD and SVCD discs.

(for Video CD/SVCD)

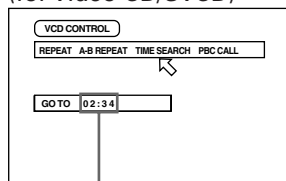

Selected time

#### • Example (for DVD VIDEO)

To playback from 2(H):34(M):00(S)

GO TO \_ : \_ : \_

↓ Press "2".

GO TO 2 : \_ : \_

↓ Press "3".

GO TO 2 : 3 \_ : \_

↓ Press "4".

GO TO 2 : 3 4 : \_

↓ Press ENTER

You do not have to press "0" to enter the trailing zeros (for the last two digits in the example above). Of course, it is possible to enter them.

#### • When you make a mistake

Move the cursor to the incorrect value, then press the correct button to re-select the value.

GO TO 2 : 3 5 : \_

↓ Press CURSOR ◀.

GO TO 2 : 3 \_ : \_

↓ Press "4".

GO TO 2 : 3 4 : \_

### NOTES

- When appears on the TV screen in step 2:  
The time you have selected is not contained on the disc, or the time search function does not work on the disc.  
Also note that the time search function does not work during Video CD/SVCD playback with the PBC function.
- To turn off the play mode menu:  
Press PLAY MODE.
- The TIME SEARCH function cannot be used during program playback.

## To locate a desired scene from the display [DIGEST]



The unit can display the opening scene of each title or chapter on a DVD VIDEO or each track of a Video CD/SVCD. You can select a desired scene from those displayed on the TV screen.

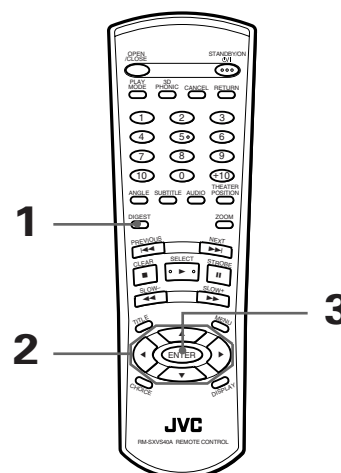

- For DVD VIDEO: While stopped or during playback
- For Video CD/SVCD: While stopped or during playback without PBC function

### 1 Press DIGEST.

Up to nine opening scenes are displayed.

- While a DVD VIDEO disc is stopped:  
The opening scene of each title appears on the TV screen.
- During DVD VIDEO disc playback:  
The opening scene of each chapter in the current title appears on the TV screen.
- When a Video CD/SVCD disc is loaded:  
The opening scene of each track appears on the TV screen.

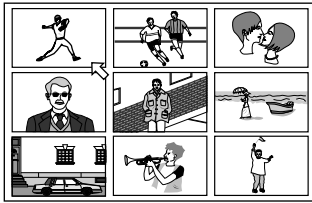

**2** Use CURSOR ▲/▼/◀/▶ to select the desired scene.

The selected scene is indicated by . If there are more than 9 scenes, the digest screen will have more than one page. In this case, pressing ▶▶ advances to the next page, while pressing ◀◀ returns to the previous page.

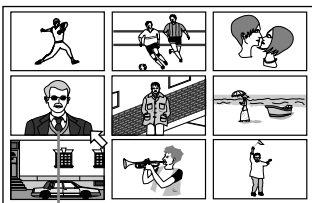

Selected scene

**Hints**

- When the lower right scene is selected, pressing CURSOR ▶ advances to the next page if available. Similarly, when the upper left scene is selected, pressing CURSOR ◀ returns to the previous page (if available).
- When there are more than one digest page, after pressing DIGEST, pressing ▶▶ before all 9 scenes of the first page appear on the TV screen will advance to the next page. Similarly, pressing ◀◀ before all the scenes of the second or latter page appear on the TV screen will return to the previous page.

**3** Press ENTER.

The unit starts playback from the selected scene.

**NOTE**

- With some discs, depending on the contents, it may take some time until all the scenes appear on the screen.

## Special picture playback

The unit provides special picture playback functions including Frame-by-frame, Strobe, Slow-motion and Zoom.

### To advance a still picture frame-by-frame

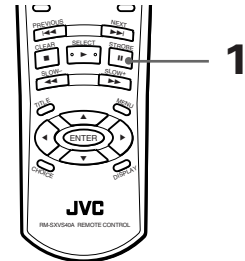

- While paused (still)

**1** Press .

Each time you press , the still picture advances to the next frame. Pressing returns to normal playback.

### To display continuous still pictures [STROBE]

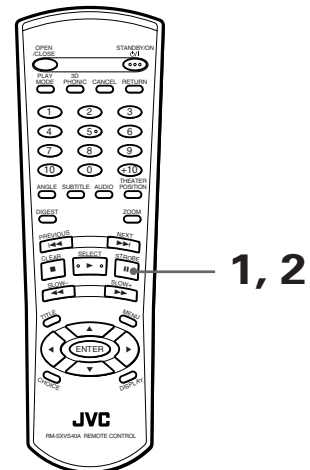

- During playback

**1** At the point you want to view as continuous photographs, press .

The unit pauses playback.

**2** Press and hold for more than 1 second.

Nine continuous still pictures appear on the TV screen.

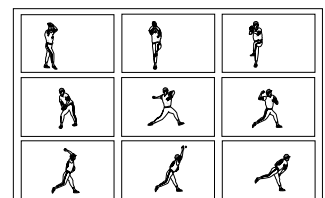

**Hints**

- Pressing **II** when the nine still pictures is shown will advance to the next nine still pictures.
  - Pressing **▶** when the nine still pictures is shown will advance pictures in normal playback speed.
- **To cancel strobe play**  
Press and hold **II** for more than 1 second.

**NOTE**

- If you press and hold **II** for more than 1 second during playback, nine still pictures also appear but they advance in normal playback speed.

**To playback in slow-motion [SLOW]**

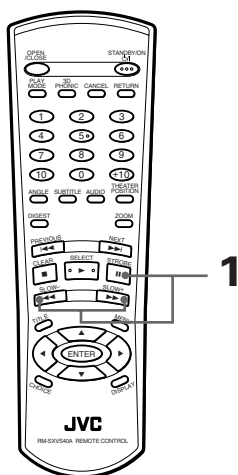

- During playback

1 Press **II**, then use **◀◀ / ▶▶**.

To play forward slow-motion, press **▶▶**, and to play reverse slow-motion (for DVD VIDEO discs only), press **◀◀**. First, the unit plays the slowest speed, and each time you press the button, the playback speed increases.

- **To return to normal playback**  
Press **▶**.
- **To pause slow-motion playback**  
Press **II**.

**NOTES**

- The sound is muted during slow-motion playback.
- Reverse slow-motion playback is not possible for a Video CD/SVCD.

**To zoom a scene [ZOOM]**

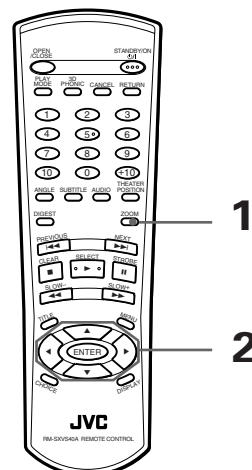

- During playback or while paused

1 Press ZOOM.

“ZOOM” appears on the TV screen. The unit zooms in to the center part of the scene to produce a double-sized image.

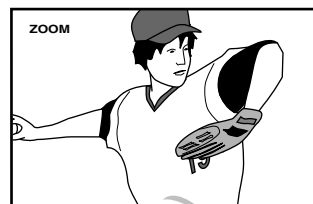
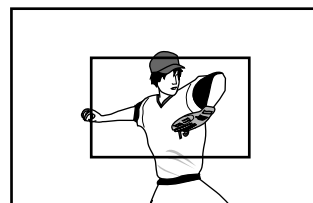

2 Use **CURSOR ▲/▼/◀/▶** to move the zoomed-in scene.

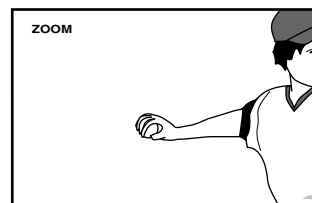

- **To return to normal playback**  
Press ZOOM.

**NOTE**

- While zoomed, the picture may look coarse.

# Changing the playback order

You can play titles or tracks on a disc inserted in the desired order or in random order.

## To playback in the desired order [PROGRAM]



You can play titles or tracks on a disc inserted in the desired order by using the Program function.

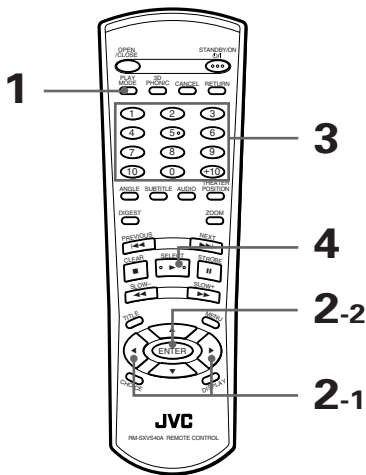

■ While stopped

### 1 Press PLAY MODE.

The play mode menu appears on the TV screen.

### 2 Use CURSOR ◀▶ to move to [PROGRAM] and press ENTER.

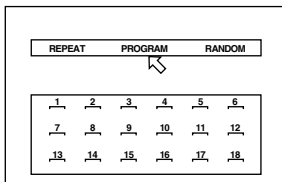

The program table appears under the menu bar (as shown above).

The "PROGRAM" indicator appears in the display window on the front panel.

### 3 Specify the titles or tracks in the desired order using the numeric buttons.

See page 11 for details about how to use the numeric buttons.

Up to 18 titles or tracks can be programmed. You may select the same title or track more than once.

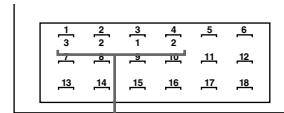

The programmed title/track number is shown under each program number.

#### • If you specify a wrong selection

Press CANCEL. The last selection programmed is erased.

#### • To clear the program

Press ■.

#### 4 Press ▶ to start program play.

When all of the programmed titles/tracks have finished playback, the unit stops but the program remains.

### NOTES

- Some DVD VIDEO discs may not be played back correctly in program mode.
- During program playback, pressing ▶▶ skip to the next selection of the program. Pressing ◀◀ returns to the beginning of the current selection, however, you cannot skip back to the previous selection.
- By pressing PLAY MODE during program playback, the program table is displayed on the TV screen and the current program number is indicated in yellow.

#### • To quit program playback

Press ■ while stopped.

The "PROGRAM" indicator in the display window turns off.

Note that the program remains.

To clear the program, press ■ while the program table is shown on the TV screen.



- While stopped and the play mode menu is displayed on the TV screen, by moving ◀▶ to [PROGRAM] and pressing ENTER, the program mode quits. Note that the program remains.

## To playback in random order [RANDOM]



You can play titles or tracks on a disc inserted in random order by using the Random function.

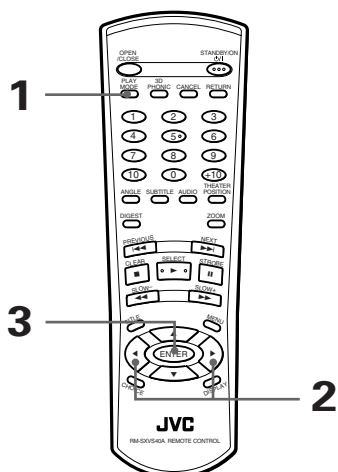

■ While stopped

**1** Press PLAY MODE.

The play mode menu appears on the TV screen.

**2** Use CURSOR ◀/▶ to move to [RANDOM].

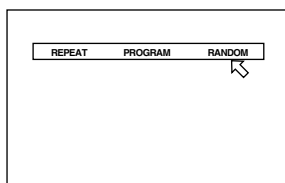

**3** Press ENTER.

The unit starts random playback. The "RANDOM" indicator appears in the display window on the front panel. After playing all titles/tracks of the disc, random playback ends.

Hints

- The same title or track will not be played back more than once during random play.
- **To stop/quit random playback in the middle**  
Press ■ to stop playback. The unit is still in random playback mode, so pressing ▶ starts random playback again.  
To quit random playback, press ■ again while stopped. The "RANDOM" indicator in the display window turns off.

**NOTE**

- Some DVD VIDEO discs may not be played back correctly in the random mode.

## Repeat playback

You can repeat playback of the current selection or all disc contents (except DVD VIDEO). You can also repeat playback of a desired part.

### To repeat the current selection or all tracks [REPEAT]

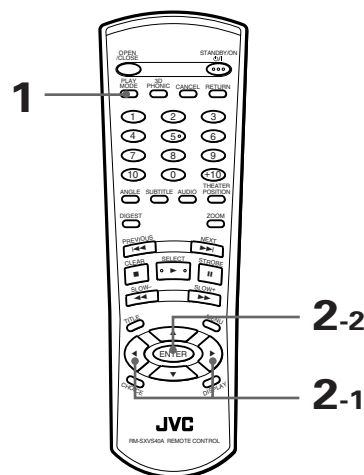

- For DVD VIDEO: During playback
- For Audio CD/Video CD/SVCD: In any condition except Video CD/SVCD playback with PBC

**1** Press PLAY MODE.

The play mode menu appears on the TV screen.

**2** Use CURSOR ◀/▶ to move to [REPEAT], then press ENTER.

Each time you press ENTER, the repeat mode changes as follows depending on the disc type and unit's status:

- **During DVD VIDEO playback**

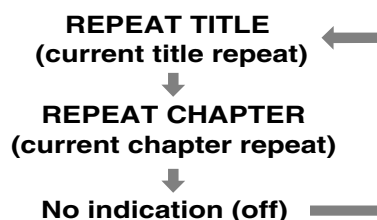
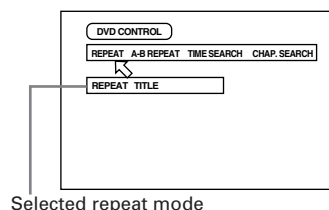

• **Audio CD/Video CD/SVCD**

(for Audio CD)

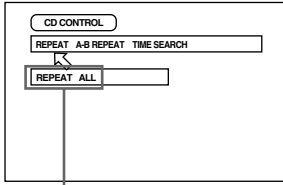

Selected repeat mode

(for Video CD/SVCD)

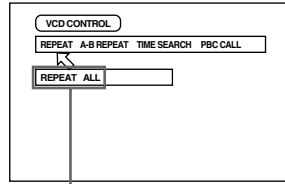

Selected repeat mode

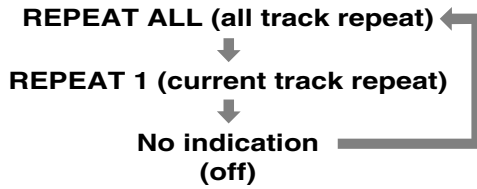

**Hints**

- If you press ■ in REPEAT ALL or REPEAT1 mode, the unit stops playback but remains in the mode.
- If you press ■ in REPEAT TITLE or REPEAT CHAPTER mode, the unit stops playback and quits the mode.

• **To quit repeat playback**

With pointed at [REPEAT], press ENTER repeatedly until the mode is set to off.

**NOTES**

- Some DVD VIDEO discs do not allow the title repeat or/ and chapter repeat.
- Some DVD VIDEO discs automatically stops playback in the middle of the disc.
- Repeat playback function cannot be used during Video CD/SVCD playback with PBC function.
- To turn off the play mode menu display Press PLAY MODE.

**To repeat a desired part [A-B REPEAT]**

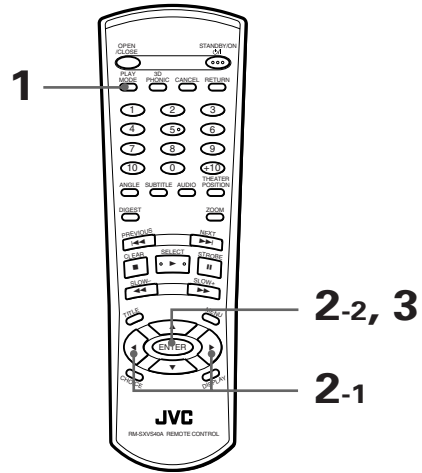

■ **During playback**

**1 Press PLAY MODE.**

The play mode menu appears on the TV screen.

**2 Use CURSOR** to move to [A-B REPEAT], then press ENTER at the beginning of the part you want to repeat (point A). Make sure that the REPEAT mode is off. If any REPEAT mode is selected, you cannot move to [A-B REPEAT].

**3 Press ENTER** at the end of the part you want to repeat (point B). The unit locates "A" and starts repeat playback between "A" and "B."

(for DVD VIDEO)

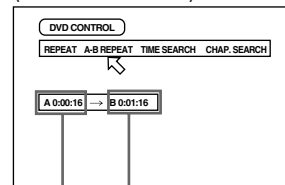

Point A Point B

(for Audio CD)

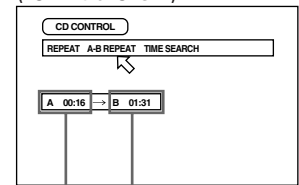

Point A Point B

(for Video CD/SVCD)

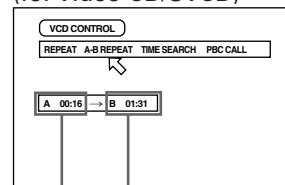

Point A Point B

### To quit A-B repeat playback

Press ■. The unit stops playback and quits A-B repeat mode.



- During playback, pressing ENTER when ⏏ is pointed at [A-B REPEAT] quits A-B repeat mode and continues playback.
- You can also quit A-B repeat mode by pressing ◀◀ or ▶▶.

### NOTES

- **To turn off the play mode menu**  
Press PLAY MODE.
- If ⏏ appears when pressing ENTER in step 2 during DVD/SVCD playback  
You cannot repeat the selected portion because of the disc contents.
- **The A-B REPEAT function cannot be used during program playback.**

## Selecting a scene angle of DVD VIDEO

You can enjoy a variety of scene angles if the DVD VIDEO disc contains "multi-angle" parts, where multiple cameras were used to shoot the same scene from different angles.



- At the beginning of a "multi-angle" part, 📹 appears on the TV screen.

### To select a scene angle from the normal screen [ANGLE]

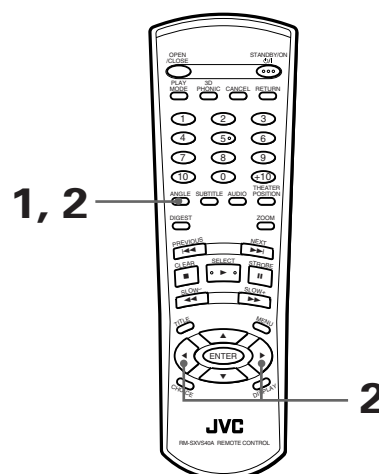

- During DVD VIDEO playback

#### 1 Press ANGLE.

The Angle selection display appears on the TV screen.

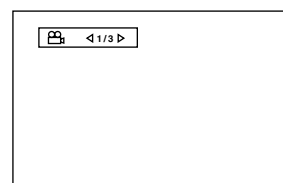

#### 2 Use ANGLE or CURSOR ◀▶ to select the desired angle.

Each time you press ANGLE or CURSOR ◀▶, the angle changes.

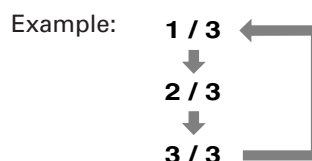

### NOTES

- The Angle selection display will automatically disappear if you do not change the angle for 10 seconds.
- To turn off the Angle selection display manually, press ENTER.
- When ⏏ appears on the TV screen  
The current scene is not recorded from multiple angles.

## To select a scene angle from the angle list display [ANGLE]

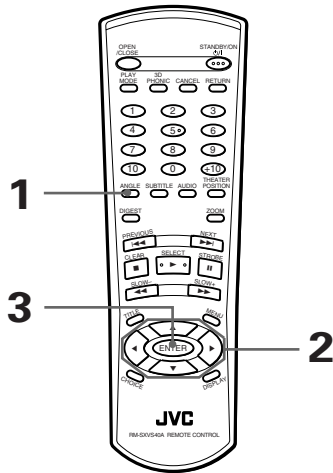

■ During DVD VIDEO playback

**1** Press and hold ANGLE for more than 1 second.

Up to nine camera angles recorded on a disc appear on the TV screen.

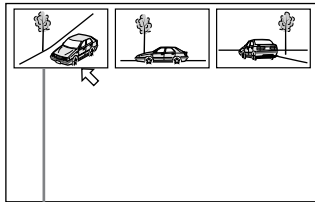

The selected camera angle

**2** Use CURSOR ▲/▼/◀/▶ to select the desired angle.

**3** Press ENTER.

The unit starts playback by the selected angle on the full-sized screen.

**NOTES**

- When  appears on the TV screen in step 1: The current scene is not recorded from multiple angles.
- During the operation above, audio is muted.

## Changing the language and sound

For DVD VIDEO discs, you can select the subtitle language, as well as the audio language/sound included on a disc. For Video CD/SVCD discs, you can select the audio channel(s).

### To select the subtitle language [SUBTITLE]

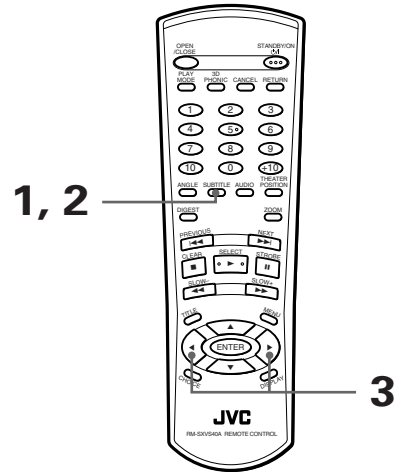

■ During playback

**1** Press SUBTITLE.

The Subtitle selection display appears on the TV screen.

(for DVD VIDEO)

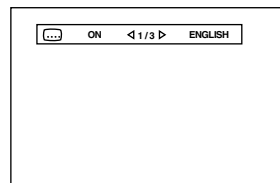

(for SVCD)

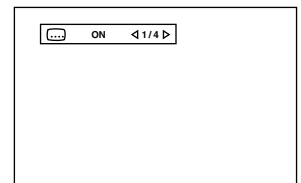

**2** To turn the subtitle on and off, press SUBTITLE.

**3** To select the desired subtitle language, use CURSOR ◀/▶.

• For DVD VIDEO

Each time you press CURSOR ◀/▶, the subtitle language changes.

Example:

- 1/3 ENGLISH
- ↓
- 2/3 FRENCH
- ↓
- 3/3 SPANISH
- ↓
- /3 (off)





• For SVCD

Pressing CURSOR ◀/▶ cycles among the four subtitle channels as follows regardless of whether the subtitle is recorded or not. You can also select the subtitle by pressing SUBTITLE.

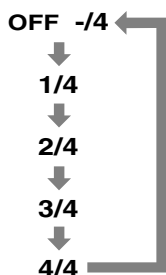

**NOTES**

- For DVD VIDEO, the selected language may be abbreviated on the TV screen. See "Appendix A: Table of languages and their abbreviations" at the end of this manual.
- The Subtitle selection display will automatically disappear if you do not change the subtitle for 10 seconds.
- To turn off the Subtitle selection display manually, press ENTER.
- When Ⓞ appears on the TV screen: You cannot select the subtitle.

(for DVD VIDEO)

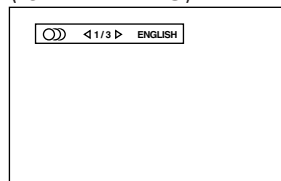

(for Video CD)

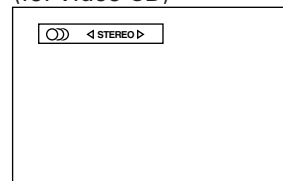

(for SVCD)

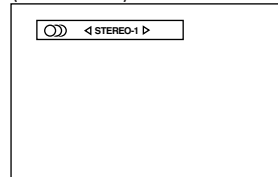

**2** Use AUDIO or CURSOR ◀/▶ to select the desired audio.

• For DVD VIDEO

Each time you press AUDIO or CURSOR ◀/▶, the audio language or sound changes.

Example:

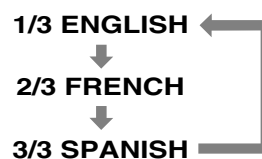

**To change the audio language or sound [AUDIO]**



By AUDIO selection, you can choose the audio language of movies or choose to enjoy karaoke with or without the vocal.

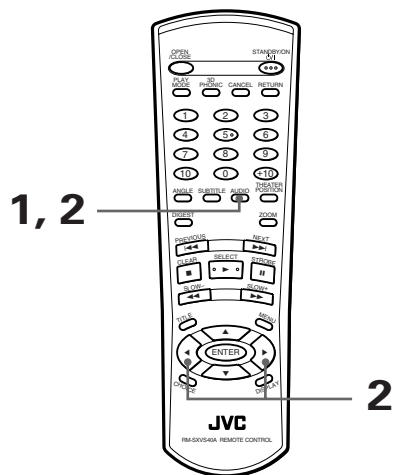

■ During playback

**1** Press AUDIO.

The Audio selection display appears on the TV screen.

• For Video CD/SVCD

Each time you press AUDIO or CURSOR ◀/▶, the playback audio changes as follows.

(Video CD)

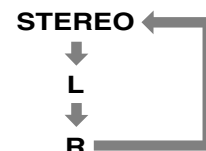

(SVCD)

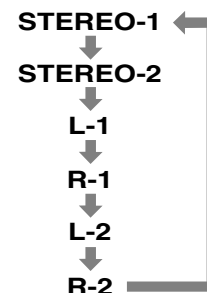

**NOTES**

- For DVD VIDEO, the selected language may be abbreviated on the TV screen. See "Appendix A: Table of languages and their abbreviations" at the end of this manual.
- The Audio selection display will automatically disappear if you do not change the audio for 10 seconds.
- To turn off the Audio selection display manually, press ENTER.
- When Ⓞ appears on the TV screen (for a DVD VIDEO disc): You cannot select the audio.

Advanced operations

## Selecting the picture character

You can select the picture character from among four options according to the source program, lighting condition of the room and/or personal preference.

### To select the picture character [THEATER POSITION]

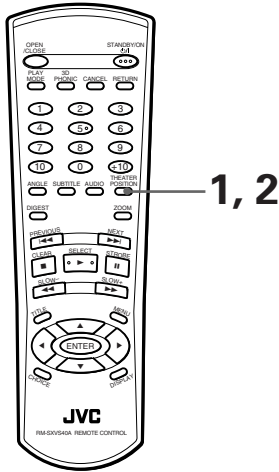

■ During playback

#### 1 Press THEATER POSITION.

The theater position display appears on the TV screen.

#### 2 Select the desired theater position by using THEATER POSITION.

Each time you press the THEATER POSITION button, the picture character changes as follows:



Selected picture character

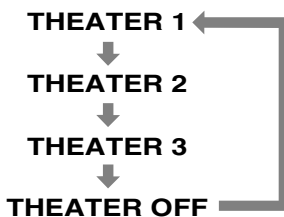

"THEATER OFF" is the normal position. Selecting a higher number tones down the picture character.

#### NOTES

- The theater position display will automatically disappear if you do not change the theater position for 5 seconds.
- To turn off the theater position display manually, press ENTER.

## Enjoying virtual surround sound

Using the 3D PHONIC function, you can get a simulated surround effect from your stereo system.

### To simulate surround sound [3D PHONIC]

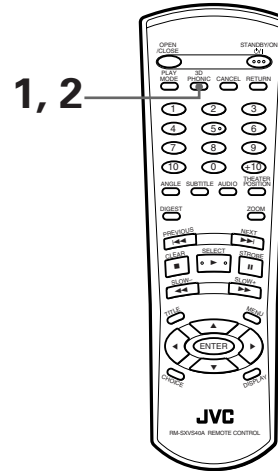

■ During playback

#### 1 Press 3D PHONIC.

The 3D PHONIC display appears on the TV screen.

#### 2 Select the desired mode by using 3D PHONIC.

Each time you press the 3D PHONIC button, the 3D PHONIC mode changes as follows:

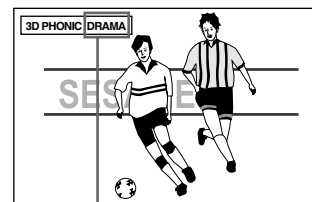

Selected effect mode

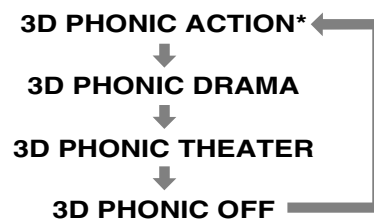

#### • ACTION

Suitable for action movies and sports programs in which sounds dynamically move.

#### • DRAMA

Natural and warm sound. You can enjoy movies in a relaxed mood.

**• THEATER**

You can enjoy sound effects like in a major theater in Hollywood.

- \* When you play a DVD VIDEO disc recorded in Dolby Digital which contains more than 3 channels, ACTION does not appear.

**NOTES**

- The 3D Phonic display will automatically disappear if you do not change the 3D PHONIC for 5 seconds.
- To turn off the 3D PHONIC display manually, press ENTER.
- With a Video CD disc, if the Audio setting is set to L or R, you cannot activate the 3D PHONIC function (i.e the 3D PHONIC mode is fixed to OFF).  
Conversly, when the 3D PHONIC function is active, changing the AUDIO setting to L or R from STEREO cancels the 3D PHONIC function.
- The 3D PHONIC function works correctly when playing back discs recorded in the Dolby Surround or Dolby Digital 5.1-CH format.  
It also works when playing back discs other than those above, but does not provide the correct effect.
- The 3D PHONIC function does not affect the DTS or Dolby Digital bitstream signal from the DIGITAL OUT jack.
- The sound effect will not be set or operate, even if 3D PHONIC is pressed, for the sound of DVD VIDEO discs recorded in Linear PCM.
- When you set the 3D PHONIC function to on, the DOWN MIX and COMPRESSION settings in the AUDIO page of the preference display are disabled.

## Checking the status

You can view the disc/time information, as well as the DVD functions status on the TV screen.

### To check the disc/time information

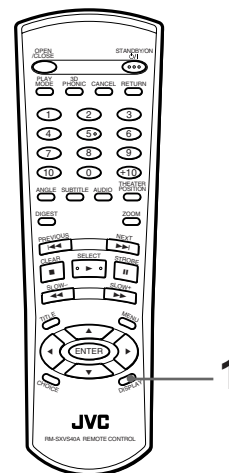

■ During playback

- 1 Press DISPLAY once for a Audio CD, Video CD or SVCD disc, or twice for a DVD VIDEO disc. The disc/time display appears on the TV screen.

(for DVD VIDEO)

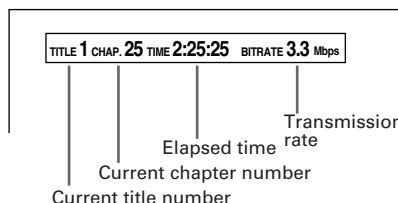

(for Audio CD, Video CD or SVCD playing without PBC)

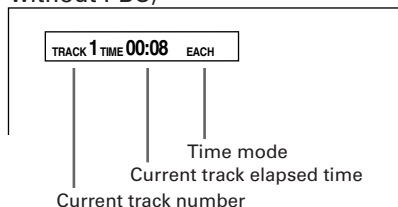

(for Video CD/SVCD playing with PBC)

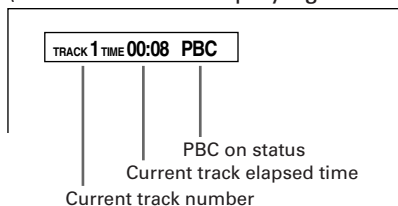

- To turn off the disc/time display  
Press DISPLAY.

Advanced operations

## To check the DVD function status

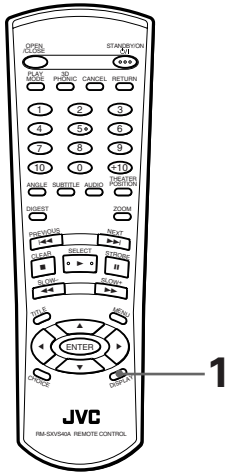

- During DVD VIDEO playback

### 1 Press DISPLAY.

The DVD function status display appears on the TV screen.

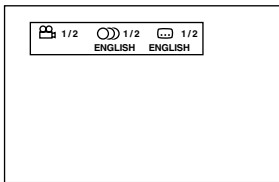

The current selections of the camera angle, audio language and subtitle language are shown.

- **To turn off the DVD function status display**  
Press DISPLAY twice.

## To dim the brightness of the display window

You can dim the brightness of the display window.

### Dimming brightness of the display window

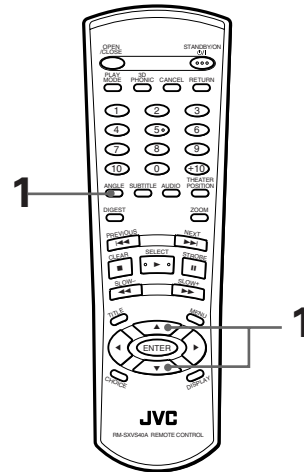

- When no disc is inserted or while stopped

### 1 Press CURSOR ▼ while holding down ANGLE.

You can set the brightness from among three levels. Each press of the button makes the display window darker.

To restore the display window brighter, press CURSOR ▲.

# MP3 CD playback

This unit can play back CD discs recorded by the MP3 format (we refer to those discs as MP3 CD discs in this manual). Operations for MP3 CD discs are similar to those for Audio CD discs, though there are some restrictions and differences.

## What is MP3?

MP3 is the abbreviation of "MPEG1 Audio Layer 3". MPEG Audio is a compression specification that compresses the audio portion only. This image compression method is used in DVD or Video CD, etc. The audio data has been compressed into about 1/10.

## About MP3 CD disc

On an MP3 CD disc, each material (song) is recorded on each Track (file), which usually belongs to a Group (folder).

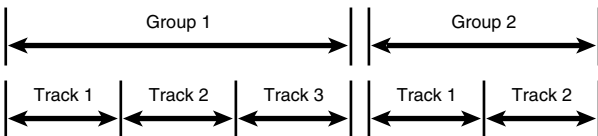

This unit can recognize up to 99 Groups and up to 254 Tracks per Group, however, the number of Tracks to be played back on a disc is limited to 1023.

If a disc includes more than 1023 Tracks, the unit stops detecting Tracks when the number of detected Tracks reaches 1023 and ignores the subsequent Tracks. The unit also ignores any non-MP3 file in the disc.

## NOTES for making a private MP3 CD using a CD-R/CD-RW disc:

- Select "ISO 9660" as the disc format.
- Do not select the "multi-session" recording.
- Finalize the disc.

## NOTES

- The unit does not support "packet write" discs.
- If there are any Tracks (files) which are stored on a disc directly and do not belong to any Group (directory), the unit recognized them as belonging to an independent Group.
- The unit does not output a digital audio signal from DIGITAL OUT when playing back an MP3 CD disc.
- The unit plays back Groups/Tracks on an MP3 CD disc in the alphabetical order.

For example, if there are three title Groups [one], [two] and [three] on a disc, the playback order is [one], [three] then [two]. Tracks in a Group are played back in the same way.

Therefore, an MP3 CD disc on the market may be played back in the different order from the order printed on its sleeve.

## Unavailable functions

As described earlier, there are some restriction for playback of MP3 CD discs. Following functions are not available with MP3 CD discs.

## Unavailable functions for MP3 discs

Function name	Function
Resume	To resume playback
Time search	To locate a desired position in the current track
Manual search	To advance or reverse playback rapidly
A-B repeat	To repeat a desired part
3D phonic	To simulate surround sound

## NOTES

- You cannot playback Tracks in the desired (programmed) or random order, nor playback a Track repeatedly.
- The screen saver function is not active with an MP3 CD disc, as with an Audio CD.

## Basic operations

### Basic operations using the basic control buttons

MP3

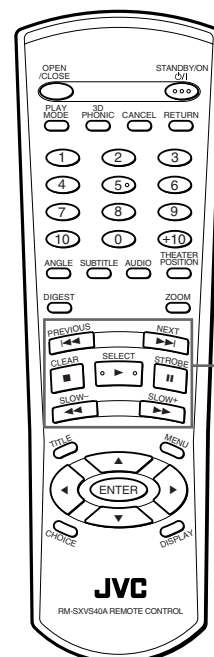

Basic control buttons

The following table shows basic functions of basic control buttons.

As you can see ►, ■, || and ◀◀/▶▶ buttons function the same as with Audio CD discs, though ◀◀/▶▶ buttons function is different.

MP3 CD playback

Buttons	Functions
	Starts playback
	Stops playback completely
	Pauses playback temporarily
	Skips back or forward a Track*.
	Skips back or forward a Group.

\* You can skip a Track across a Group. i.e. pressing when the last Track of the current Group is selected skips to the first Track of the next Group.

**NOTES**

- The current Group and Track numbers are shown on the display window in the following manner.

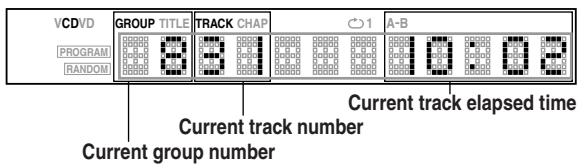

- You cannot advance or reverse playback of an MP3 CD disc rapidly.

**Track/Group selection using the numeric buttons**



While stopped, you can select a Group to be played using the numeric buttons. During playback, you can select a Track in the current Group to be played using the numeric buttons.

**How to select a Track or Group:**

The same method for selecting a track of an Audio CD disc can be applied for selecting a Group or Track of an MP3 CD disc except for a three-figure Track. For selecting a three-figure Track (i.e. Track 100 or higher), follow the procedure below.

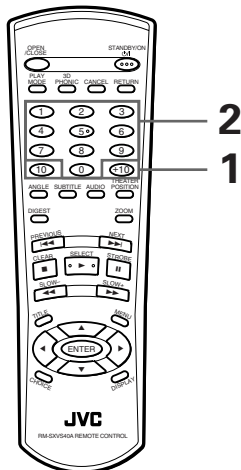

**1** Holding down the +10 button for 2 seconds or more.

“- - -” appears in the display window showing that you can now enter a three-figure number directly.

**2** Use the numeric buttons (0 through 9) to specify the desired Track number directly.

**Example:**

To specify Track 254 : press 2, 5 and 4.



- You can also specify a single- or double-figure Track using this method.

Example:

- To specify Track 5, press 0, 0 and 5.
- To specify Track 25, press 0, 2 and 5.

**Advanced functions**

**Program playback**



You can playback Groups on an MP3 CD disc in the desired order.

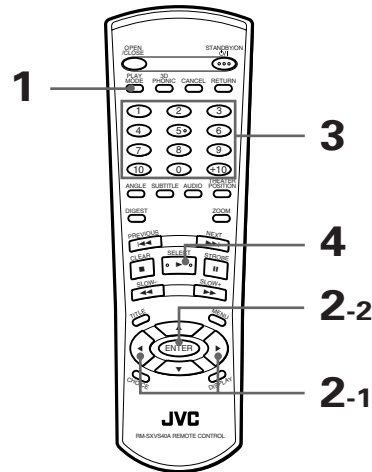

**While stopped**

**1** Press PLAY MODE.

The play mode menu appears on the TV screen.

**2** Use CURSOR to move to [PROGRAM] and press ENTER.

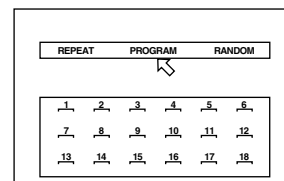

The program table appears under the menu bar (as shown above).

The “PROGRAM” indicator appears in the display window on the front panel.

### 3 Specify the groups in the desired order using the numeric buttons.

See page 11 for details about how to use the numeric buttons.

Up to 18 groups can be programmed. You may select the same group more than once.

REPEAT			PROGRAM			RANDOM		
1	2	3	4	5	6			
7	8	9	10	11	12			
13	14	15	16	17	18			

The programmed group number is shown under each program number.

- **If you specify a wrong selection**  
Press CANCEL. The last selection programmed is erased.
- **To clear the program**  
Press ■ .
- **4 Press ► to start program play.**  
When all of the programmed groups have finished playback, the unit stops but the program remains.
- **To quit program playback**  
Press ■ while stopped.  
The "PROGRAM" indicator in the display window turns off.  
Note that the program remains.  
To clear the program, press ■ while the program table is shown on the TV screen.

#### Hints

- While stopped and the play mode menu is displayed on the TV screen, by moving  to [PROGRAM] and pressing ENTER, the program mode quits. Note that the program remains.

#### NOTES

- You cannot playback Tracks in a Group in the desired order.
- By pressing PLAY MODE during program playback, the program table is displayed on the TV screen and the current program number is indicated in yellow.

## Random playback

MP3

You can playback Groups on an MP3 CD disc in random order.

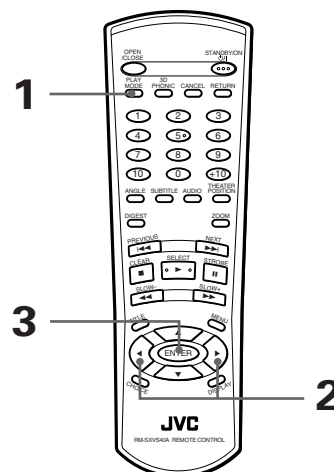

- While stopped

### 1 Press PLAY MODE.

The play mode menu appears on the TV screen.

### 2 Use CURSOR to move to [RANDOM].

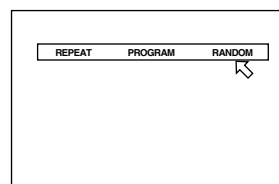

### 3 Press ENTER.



The unit starts random playback.

The "RANDOM" indicator appears in the display window on the front panel. After playing all groups of the disc, random playback ends.

#### Hints

- The same group will not be played back more than once during random play.
- **To stop/quit random playback in the middle**  
Press ■ to stop playback. The unit is still in random playback mode, so pressing ► starts random playback again.  
To quit random playback, press ■ again while stopped. The "RANDOM" indicator in the display window turns off.

#### NOTES

- Tracks in a Group are played back in the regular order.
- Pressing the   button during random playback skips forward or back a track.

## Repeat playback

MP3

You can repeat playback of the current Group or all Groups.

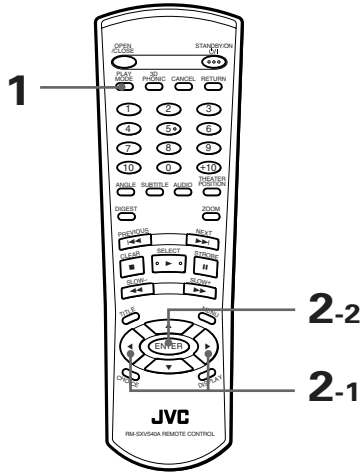

■ During playback or while stopped

### 1 Press PLAY MODE.

The play mode menu appears on the TV screen.

### 2 Use CURSOR ◀/▶ to move to [REPEAT], then press ENTER.

Each time you press ENTER, the repeat mode changes as follows depending on the disc type and unit's status:

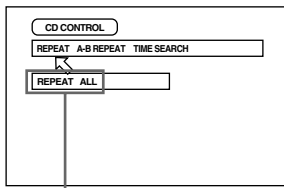

Selected repeat mode

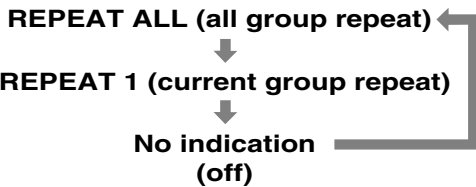

### Hints

- If you press in REPEAT ALL or REPEAT1 mode, the unit stops playback but remains in the mode.

### • To quit repeat playback

With pointed at [REPEAT], press ENTER repeatedly until the mode is set to off.

### NOTE

- **To turn off the play mode menu display**  
Press PLAY MODE.

## Disc/time information

MP3

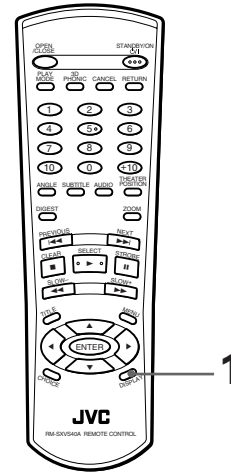

■ During playback

### 1 Press DISPLAY.

The disc/time display appears on the TV screen.

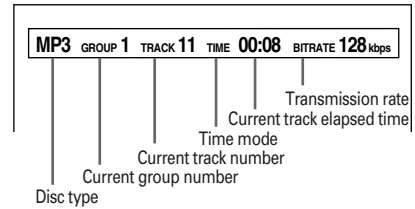

- **To turn off the disc/time display**  
Press DISPLAY.



## Selecting preferences

You can set various preferences for playback via four dedicated displays.

### How to set preferences

Note that you cannot bring up a preference display during playback or when an Audio CD is loaded in the tray.

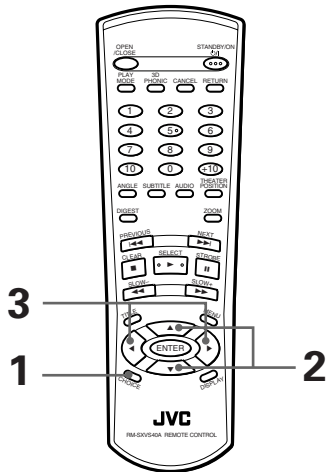

- When no disc is inserted in the tray, or when a DVD VIDEO or Video CD is inserted and stopped

#### 1 Press CHOICE.

One of the preference pages appears on the TV screen. There are four preference pages: LANGUAGE, AUDIO, DISPLAY and SYSTEM. To turn the page, move to the desired tab using CURSOR /▶.

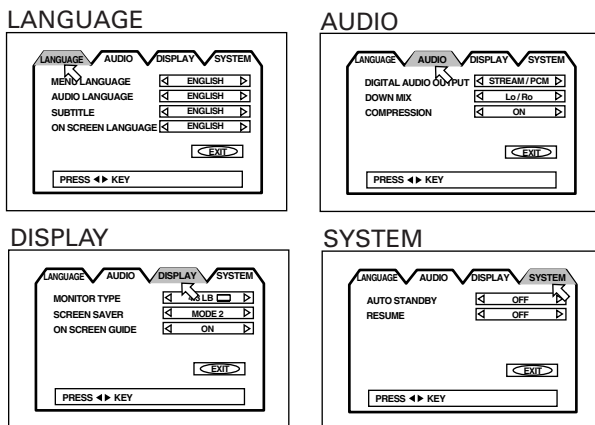

#### 2 Move to select the item you want to set by using CURSOR .

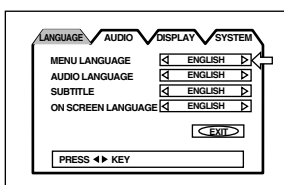

#### 3 Press CURSOR to select the setting you want.

- To turn off the preference display, press CHOICE or move to [EXIT] and press ENTER.
- For details about each setting, see the following paragraphs:

## LANGUAGE page

### MENU LANGUAGE

You can select the default “display” language to be displayed if it is contained on the disc.

Each time you press CURSOR , the language setting changes in the following order:

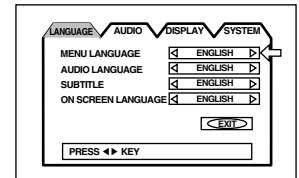

**ENGLISH → SPANISH → FRENCH → CHINESE → GERMAN → ITALIAN → JAPANESE → language code from AA to ZU**

(See “Appendix A: Table of languages and their abbreviations” at the end of this manual.)

Pressing CURSOR changes the language setting in the reverse order of the above.

\* If the selected language is not recorded, the disc’s default display language will be displayed.

### AUDIO LANGUAGE

You can select the default audio language to be played if it is contained on the disc.

Each time you press CURSOR , the language setting changes in the following order:

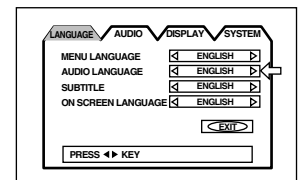

**ENGLISH → SPANISH → FRENCH → CHINESE → GERMAN → ITALIAN → JAPANESE → language code from AA to ZU**

(See “Appendix A: Table of languages and their abbreviations” at the end of this manual.)

Pressing CURSOR changes the language setting in the reverse order of the above.

\* If the selected language is not recorded, the disc’s default audio language will be played.

## SUBTITLE

You can select the default subtitle language to be displayed if it is contained on the disc.

Each time you press CURSOR ►, the language setting changes in the following order:

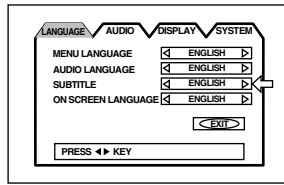

**ENGLISH → SPANISH → FRENCH → CHINESE → GERMAN → ITALIAN → JAPANESE → language code from AA to ZU**

(See "Appendix A: Table of languages and their abbreviations" at the end of this manual.)

Pressing CURSOR ◀ changes the language setting in the reverse order of the above.

\* If the selected language is not recorded, the disc's default subtitle language will be displayed.

## ON SCREEN LANGUAGE

You can select the on-screen display language to be displayed.

Each time you press CURSOR ►, the language setting changes as follows:

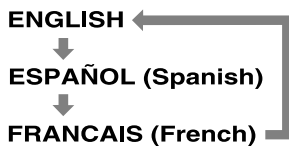
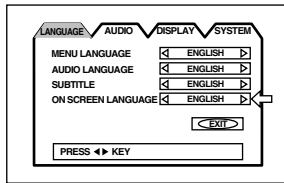

English	ON SCREEN LANGUAGE ◀ ENGLISH ▶
Spanish	IDIOMA EN PANTALLA ◀ ESPAÑOL ▶
French	LANGUE D'ECRAN ◀ FRANCAIS ▶

Pressing CURSOR ◀ changes the language setting in the reverse order of the above.

## AUDIO page

### DIGITAL AUDIO OUTPUT

To connect the unit's digital output to an external device equipped with a digital input, this item must be set correctly.

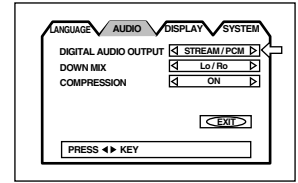

- PCM ONLY**  
 When you connect the DIGITAL OUT jack of the unit to the linear PCM digital input of other audio equipment.
- STREAM/PCM**  
 When you connect to the digital input of an amplifier to a built-in DTS, Dolby Digital, or MPEG multichannel decoder.
- DOLBY DIGITAL/PCM**  
 When you connect to the digital input of a Dolby Digital decoder, or an amplifier with a built-in Dolby Digital decoder.

The following chart shows the relationship between types of playback discs and output signals.

Playback discs	Output		
	STREAM/PCM	DOLBY DIGITAL/PCM	PCM ONLY
DVD with 48 kHz, 16 bit linear PCM	48 kHz, 16 bit linear PCM	←	←
DVD with 48 kHz, 20/24 bit linear PCM	48 kHz, 20/24 bit linear PCM	←	←
DVD with 96 kHz, linear PCM	No output	←	←
DVD with DTS	DTS bitstream	No output	←
DVD with Dolby Digital	Dolby Digital bitstream	←	48 kHz, 16 bit linear PCM
DVD with MPEG multichannel	MPEG bitstream	48 kHz, 16 bit linear PCM	←
Video CD/SVCD	44.1 kHz, 16 bit linear PCM	←	←
Audio CD	48 kHz, 16 bit linear PCM	←	←
Audio CD with DTS	DTS bitstream	←	←
MP3 CD	No output	←	←

### NOTES

- The unit does not provide the DTS decoding function.
- When playing a DVD VIDEO or Audio CD disc with DTS, use a DTS decoder to get correct signals from your speakers. Never use the unit's analog output jacks, which output incorrect signals that may damage your speakers.
- If you connect the analog outputs and digital outputs simultaneously, be sure to select the source of the amplifier correctly, or set the level control of the amplifier connected to the analog outputs to minimum.

## DOWN MIX

To playback a DVD VIDEO disc recorded with surround multichannel audio correctly, the DOWN MIX setting must be properly made according to your audio system.

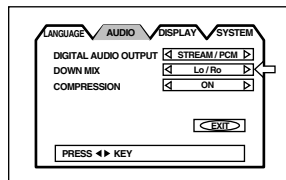

Note that this setting affects the output signal from the AUDIO (both DIGITAL and ANALOG) output jacks when playing back a DVD VIDEO disc recorded with surround multichannel audio.

- **Lt/Rt**

When you enjoy multichannel surround audio by connecting the unit's AUDIO output (normally, the DIGITAL output) to a surround decoder.

- **Lo/Ro**

When you enjoy conventional 2-channel stereo audio by connecting the unit's AUDIO output to a stereo amplifier/receiver or television set, or when you duplicate audio of a DVD VIDEO disc recorded with surround audio to your MD, cassette, etc.

### NOTES

- The Down mix function does not work when the 3D PHONIC function is activated.

- The DOWN MIX setting does not affect an MPEG or Dolby Digital bitstream signal from DIGITAL OUT.

To enjoy the DOWN MIX effect from DIGITAL OUT when playing back a disc recorded with the MPEG multichannel or Dolby Digital format, set "DIGITAL AUDIO OUTPUT" to "PCM ONLY" (see page 40).

- When playing back a disc recorded with DTS, you cannot get the DOWN MIX effect from both DIGITAL and ANALOG outputs.

## COMPRESSION

You can compress the dynamic range of the sound if needed. Using this function, you can listen to sound at low volumes easily.

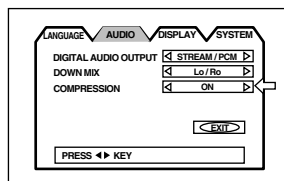

- **ON**

Audio is played back with the dynamic range compressed.

- **OFF**

Audio is played back as it was recorded.

### NOTES

- The Compression function works only when playing back a disc recorded with DOLBY DIGITAL 1CH or 2CH. The setting is not effective for other discs.
- The Compression function does not work when the 3D PHONIC function is activated.
- With the digital connection, the COMPRESSION settings in the AUDIO page of the preference display are invalid. Settings for these items must be made from the decoder.

## DISPLAY page

### MONITOR TYPE

You can select the monitor type to match your TV when you playback DVD VIDEO discs recorded for wide screen televisions.

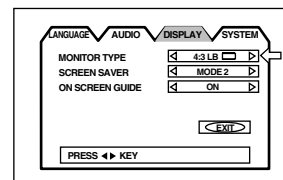

- **4:3 LB**  (Letter Box Conversion)

When you connect a normal TV to the unit.

When you play a wide picture recorded on a DVD VIDEO disc, the picture is displayed with bands across the upper and lower portions of the screen.



- **4:3 PS**  (Pan Scan Conversion)

When you connect a normal TV to the unit.

When you play a wide picture recorded on a DVD VIDEO disc, a portion of the picture is automatically cut off from the left and right sides of the image.

Depending on the disc, it may not be possible to playback in this mode. In that case, the picture is played back as in 4:3 LB  mode.

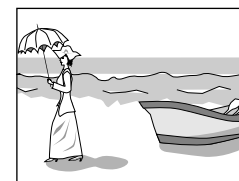

- **16:9 WIDE** (Wide Television screen)

When you connect a wide-screen TV to the unit.

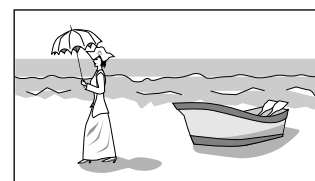

## SCREEN SAVER

A television monitor screen may be burned out if a static picture is displayed for a long time. To prevent this, the unit automatically activates the screen saver function if a static picture, such as an on-screen display or menu, is displayed for over 5 minutes.

- **MODE 1**

The current picture gets dark.

- **MODE 2**

The "screen saver" picture appears and its brightness changes.

- **OFF**

The screen saver function is off.

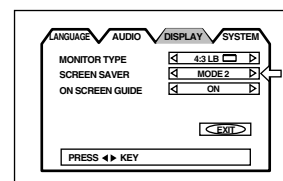

### NOTES

- The monitor screen of a projector or projection TV is easily burned out if the screen saver mode is set to OFF and a static picture is displayed for a long time.
- The screen saver function is not activated when the selected disc is an Audio CD.

## ON SCREEN GUIDE

The unit can display "on-screen guide" icons or characters on the picture, which show what is happening to the disc or the unit.

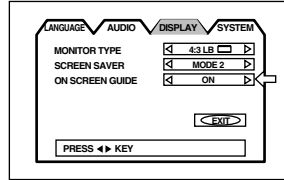

- **ON**  
The on-screen guide will be displayed.
- **OFF**  
The on-screen guide will not be displayed. Examples of "on-screen guide" icons or characters are following (see page 11):



## SYSTEM page

### AUTO STANDBY

When the unit is stopped for more than 30 minutes or 60 minutes, the unit enters standby mode automatically.

- **60**  
Time is set to 60 minutes.
- **30**  
Time is set to 30 minutes.
- **OFF**  
The auto standby function is off.

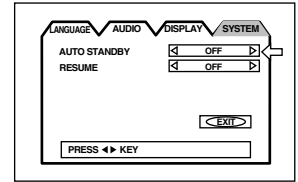

### RESUME

You can select the resume function to be on or off. See page 19.

- **ON**  
Pressing ▶ while stopped or on standby starts playback from the resume point if it is memorized.
- **OFF**  
Pressing ▶ while stopped or on standby starts playback from the beginning of the disc.

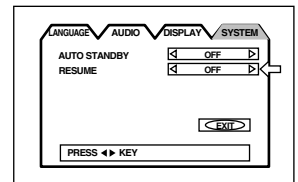

## Limiting playback by children

This function restricts playback of DVD VIDEO discs which contain violent (and other) scenes according to the level set by the user. For example, if a movie which includes violent scenes supports the parental lock feature, such scenes which you do not want to let children view can be cut or replaced with other scenes.

### To set Parental Lock for the first time [PARENTAL LOCK]

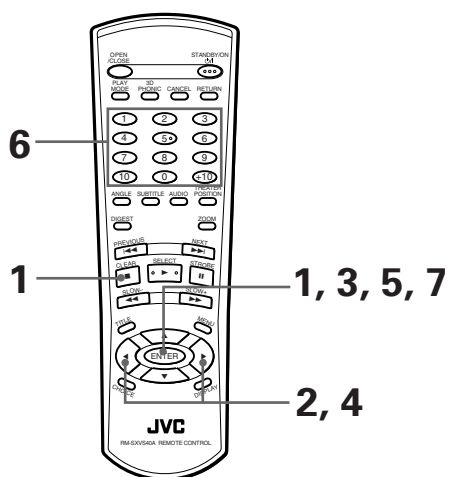

■ While a DVD VIDEO disc is stopped or no disc is inserted

#### 1 Press ENTER while holding down ■ on the remote control unit.

The Parental Lock on-screen display appears on the TV screen.

← points [Country Code].

#### 2 While ← points [Country Code], use CURSOR ←/→ to select the "US" for country code.

The country code whose standards were applied to rate the DVD VIDEO disc should be selected. See "Appendix B: Country/Area code list for parental lock".

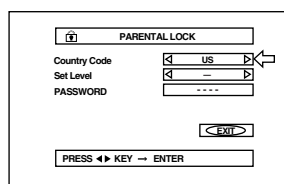

#### 3 Press ENTER.

← moves to [Set Level].

#### 4 While ← points [Set Level], use CURSOR ←/→ to select the parental lock level.

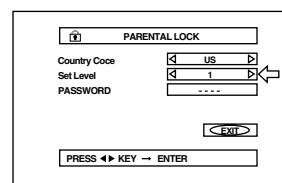

Each time you press CURSOR ←/→, the parental level changes as follows:

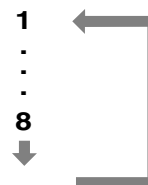

- "1" is the strictest level. "-" means no restriction. Discs rated higher than the selected level are restricted.

#### 5 Press ENTER.

← moves to [PASSWORD].

#### 6 Enter your 4-digit password using the numeric buttons (0 to 9).

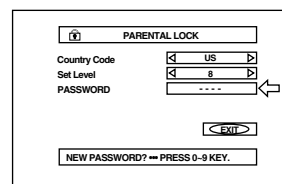

#### 7 Press ENTER.

The parental level and password are set.

← moves to [EXIT].

Pressing ENTER again returns to the opening display.



- If you enter an undesired password in step 6 above, reenter the password before pressing ENTER.

## To change the settings [PARENTAL LOCK]



You can change the Parental lock settings later.

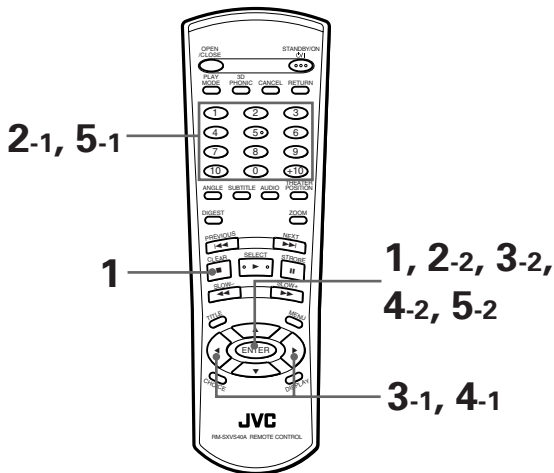

■ While a DVD VIDEO disc is stopped or no disc is inserted

**1** Press ENTER while holding down ■ on the remote control unit.

The Parental Lock on-screen display appears on the TV screen.

↵ points [PASSWORD].

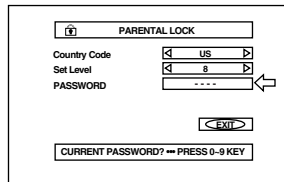

**2** Enter your current 4-digit password using the numeric buttons (0 to 9) and press ENTER.

↵ moves to [Country Code] if you enter the correct password.

If you enter the wrong password, "WRONG! RETRY..." appears on the TV screen, and you cannot go to next step.

**3** To change the country code, use CURSOR ◀/▶ to select the desired country code and press ENTER.

↵ moves to [Set Level].

When you change the country code, you must select the parental level.

**4** To change the set level, use CURSOR ◀/▶ to select the desired level while ↵ points [Set Level], and then press ENTER.

↵ moves to [PASSWORD].

**5** Enter the password using the numeric buttons (0 to 9) and press ENTER.

↵ moves to [EXIT].

The password entered in the above step becomes the new password. If you do not change the password, enter the same password as in the step 2. Even if you want to change only the country/area code and/or set level, do not forget to enter the password after changing the country/area code and/or set level. Otherwise, the new country code and/or set level will not become effective. Pressing ENTER again returns to the opening display.

### NOTES

- When you enter the wrong password more than 3 times in step 2 above, ↵ moves to [EXIT] automatically and CURSOR ▲/▼ does not work.
- If you forget your password in step 2 Enter "8888."

## To temporarily release the Parental lock [PARENTAL LOCK]



When you set the parental level strictly, some discs may not be played back at all. When you insert such a disc and try to play it, the following Parental Lock on-screen display appears on the TV screen, asking you whether you want the parental lock to be temporarily released or not.

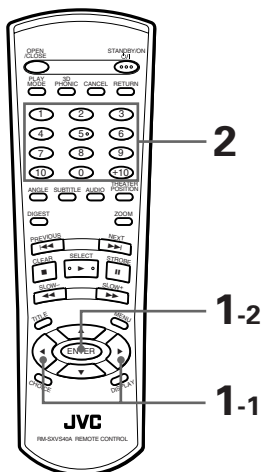

**1** Use the CURSOR ▲/▼ to move ← to [YES], then press ENTER.

← moves to the PASSWORD field. When selecting [NO], press OPEN/CLOSE to remove the disc.

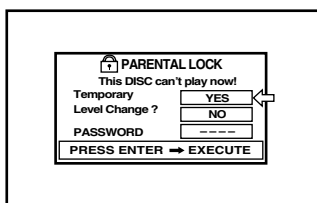

**2** Enter your 4-digit password using the numeric buttons (0 to 9).

If you enter the wrong password, "WRONG! RETRY..." appears on the TV screen. Enter the correct password. The Parental lock is released, and the unit starts playback.

### NOTE

- When you enter the wrong password more than 3 times in step 2 above, ← moves to [NO] automatically and CURSOR ▲/▼ do not work.

## Care and handling of discs

### How to handle discs

When handling a disc, do not touch the surface of the disc. Since discs are made of plastic, they are easily damaged. If a disc gets dirty, dusty, scratched or warped, the images and sound will not be picked up correctly, and such a disc may cause the player to malfunction.

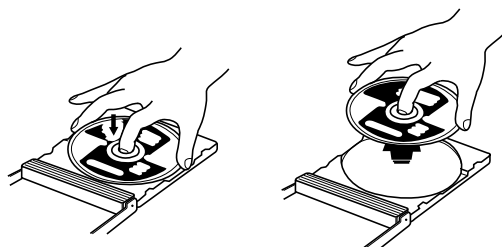

### Label side

Do not damage the label side, stick paper to or use any adhesive on its surface.

### Storage

Make sure that discs are kept in their cases. If discs are piled on top of one another without their protective cases, they can be damaged. Do not put discs in a location where they may be exposed to direct sunlight, or in a place where the humidity or temperature is high. Avoid leaving discs in your car!

### Maintenance of discs

If there are fingerprints or other dirt adhering to a disc, wipe with a soft dry cloth, moving from the center outwards. If a disc is difficult to clean, wipe with a cloth moistened with water. Never use record cleaners, petrol, alcohol or any anti-static agents.

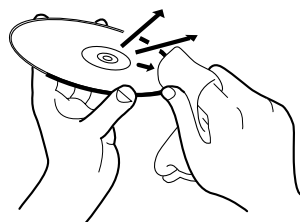

### CAUTION

Sometimes during play noise or images may be garbled. This is sometimes due to the disc. (It may not be up to industry standards.)

These symptoms are caused by the discs, not by the malfunction of the unit.



## Troubleshooting

What appears to be a malfunction may not always be serious. Please go through the following list before requesting service.

Symptom	Possible case	Remedy
Power does not come on.	Power plug is not inserted securely.	Plug in securely.
Remote control does not work.	Too far from the unit.	Move closer to the unit.
	The tip of the remote unit is not pointed in the right direction.	Point the infrared light-emitting window toward the remote sensor on the front panel.
	Batteries are exhausted.	Replace the batteries with new ones.
	Battery polarity is incorrect.	Take out the batteries and insert them again in the correct direction.
No picture is displayed on the monitor.	Connection of video cable is incorrect.	Connect the cable correctly.
	Input selection of TV is incorrect.	Select correctly.
	Disc is not playable.	Use a playable disc. (See page 12.)
No picture is displayed in the monitor or the monitor screen is blue when using the COMPONENT or S-VIDEO output jack(s).	Jack(s) at use is (are) not active.	Make them active. (See page 13 and 14.)
Picture is noisy.	The unit is connected to a VCR directly and the copyguard function is activated.	Connect the unit so that the picture signal flows directly to the TV.
No audio is reproduced.	Connection is incorrect.	Check the connections.
	Input selection of amplifier is incorrect.	Select correctly.
No audio is reproduced when playing back a DVD disc recorded with 96 kHz, linear PCM audio.	The audio signal is not derived from the unit's DIGITAL OUT.	Use the AUDIO OUT when playing back such discs.
Sound is distorted or noise is generated.	Disc is dirty.	Wipe the disc surface.
Picture does not fit the television screen.	MONITOR TYPE is not correctly set.	Select monitor type correctly. (See page 41.)
	Television is not correctly set.	Set the television correctly.
Operation is not possible.	Microcomputer malfunction due to lightning or static electricity.	Turn off the power and unplug the power cord, then connect the power cord again.
	Moisture condensation caused by a sudden change of temperature or humidity.	Turn off the power, then turn it on a few hours later.

# Specifications

## General

Readable discs: DVD VIDEO, Audio CD, Video CD, SVCD, MP3 CD  
 Video format: NTSC

## Other

Power requirements: AC 120 V  $\sim$ , 60 Hz  
 Power consumption: 14 W (POWER ON), 1.2 W (STANDBY mode)  
 Mass: 2.4 kg (5.35 lbs)  
 Dimensions (W x H x D): 435 mm x 68 mm x 271 mm  
 (17-3/16 inch x 2-11/16 inch x 10-21/32 inch)

## Video output

COMPONENT (pin jacks): Y Output: 1.0 Vp-p (75  $\Omega$ )  
 Pb/Pr Output: 0.7 Vp-p (75  $\Omega$ )  
 VIDEO OUT (pin jack): 1.0 Vp-p (75  $\Omega$ )  
 S-VIDEO OUT (S jack): Y Output: 1.0 Vp-p (75  $\Omega$ )  
 C Output: 286 mVp-p (75  $\Omega$ )  
 Horizontal resolution: 500 Lines

## Audio outputs

ANALOG OUT (pin jack): 2.0 Vrms (10 k $\Omega$ )  
 DIGITAL OUT: (COAXIAL): 0.5 Vp-p (75  $\Omega$  termination)

## Audio characteristics

Frequency response: CD (sampling frequency 44.1 kHz): 2 Hz to 20 kHz  
 DVD (sampling frequency 48 kHz): 2 Hz to 22 kHz  
 DVD (sampling frequency 96 kHz): 2 Hz to 44 kHz  
 Dynamic range: 16 bit: More than 98 dB  
 20 bit: More than 106 dB  
 24 bit: More than 106 dB  
 Wow and flutter: Unmeasurable (less than  $\pm$  0.002%)  
 Total harmonic distortion: Less than 0.002%

\* Specifications and appearance subject to change without prior notice.

## Appendix A: Table of languages and their abbreviations

When you select the subtitle language or sound, the languages shown below are displayed as abbreviations. To select the desired language, select the abbreviation corresponding the language you want to.

AA	Afar
AB	Abkhazian
AF	Afrikaans
AM	Ameharic
AR	Arabic
AS	Assamese
AY	Aymara
AZ	Azerbaijani
BA	Bashkir
BE	Byelorussian
BG	Bulgarian
BH	Bihari
BI	Bislama
BN	Bengali, Bangla
BO	Tibetan
BR	Breton
CA	Catalan
CO	Corsican
CS	Czech
CY	Welsh
DA	Danish
DZ	Bhutani
EL	Greek
EO	Esperanto
ET	Estonian
EU	Basque
FA	Persian
FI	Finnish
FJ	Fiji
FO	Faroese
FY	Frisian
GA	Irish
GD	Scots Gaelic
GL	Galician
GN	Guarani
GU	Gujarati
HA	Hausa
HI	Hindi
HR	Croatian
HU	Hungarian
HY	Armenian
IA	Interlingua
IE	Interlingue

IK	Inupiak
IN	Indonesian
IS	Icelandic
IW	Hebrew
JI	Yiddish
JW	Javanese
KA	Georgian
KK	Kazakh
KL	Greenlandic
KM	Cambodian
KN	Kannada
KO	Korean (KOR)
KS	Kashmiri
KU	Kurdish
KY	Kirghiz
LA	Latin
LN	Lingala
LO	Laothian
LT	Lithuanian
LV	Latvian, Lettish
MG	Malagasy
MI	Maori
MK	Macedonian
ML	Malayalam
MN	Mongolian
MO	Moldavian
MR	Marathi
MS	Malay (MAY)
MT	Maltese
MY	Burmese
NA	Nauru
NE	Nepali
NL	Dutch
NO	Norwegian
OC	Occitan
OM	(Afan) Oromo
OR	Oriya
PA	Panjabi
PL	Polish
PS	Pashto, Pushto
PT	Portuguese
QU	Quechua
RM	Rhaeto-Romance

RN	Kirundi
RO	Rumanian
RU	Russian
RW	Kinyarwanda
SA	Sanskrit
SD	Sindhi
SG	Sangho
SH	Serbo-Croatian
SI	Singhalese
SK	Slovak
SL	Slovenian
SM	Samoaan
SN	Shona
SO	Somali
SQ	Albanian
SR	Serbian
SS	Siswati
ST	Sesotho
SU	Sundanese
SV	Swedish
SW	Swahili
TA	Tamil
TE	Telugu
TG	Tajik
TH	Thai
TI	Tigrinya
TK	Turkmen
TL	Tagalog
TN	Setswana
TO	Tonga
TR	Turkish
TS	Tsonga
TT	Tatar
TW	Twi
UK	Ukrainian
UR	Urdu
UZ	Uzbek
VI	Vietnamese
VO	Volapuk
WO	Wolof
XH	Xhosa
YO	Yoruba
ZU	Zulu

## Appendix B:Country/Area code list for parental lock

This list is used for the parental Lock operation. For details, see page 43.

AD	Andorra
AE	United Arab Emirates
AF	Afghanistan
AG	Antigua and Barbuda
AI	Anguilla
AL	Albania
AM	Armenia
AN	Netherlands Antilles
AO	Angola
AQ	Antarctica
AR	Argentina
AS	American Samoa
AT	Austria
AU	Australia
AW	Aruba
AZ	Azerbaijan
BA	Bosnia and
BB	Barbados
BD	Bangladesh
BE	Belgium
BF	Burkina Faso
BG	Bulgaria
BH	Bahrain
BI	Burundi
BJ	Benin
BM	Bermuda
BN	Brunei Darussalam
BO	Bolivia
BR	Brazil
BS	Bahamas
BT	Bhutan
BV	Bouvet Island
BW	Botswana
BY	Belarus
BZ	Belize
CA	Canada
CC	Cocos (Keeling) Islands
CF	Central African Republic
CG	Congo
CH	Switzerland
CI	Côte d'Ivoire
CK	Cook Islands
CL	Chile
CM	Cameroon
CN	China
CO	Colombia
CR	Costa Rica
CU	Cuba
CV	Cape Verde
CX	Christmas Island
CY	Cyprus
CZ	Czech Republic
DE	Germany
DJ	Djibouti
DK	Denmark
DM	Dominica
DO	Dominican Republic
DZ	Algeria
EC	Ecuador
EE	Estonia
EG	Egypt
EH	Western Sahara
ER	Eritrea
ES	Spain
ET	Ethiopia
FI	Finland
FJ	Fiji
FK	Falkland Islands
FM	Micronesia (Federated States of)
FO	Faroe Islands
FR	France
FX	France, Metropolitan
GA	Gabon
GB	United Kingdom
GD	Grenada
GE	Georgia
GF	French Guiana
GH	Ghana
GI	Gibraltar
GL	Greenland
GM	Gambia
GN	Guinea
GP	Guadeloupe
GQ	Equatorial Guinea
GR	Greece
GS	South Georgia and the South Sandwich
GT	Guatemala
GU	Guam
GW	Guinea-Bissau
GY	Guyana
HK	Hong Kong
HM	Heard Island and McDonald Islands
HN	Honduras
HR	Croatia
HT	Haiti
HU	Hungary
ID	Indonesia
IE	Ireland
IL	Israel
IN	India
IO	British Indian Ocean Territory
IQ	Iraq
IR	Iran (Islamic Republic of)
IS	Iceland
IT	Italy
JM	Jamaica
JO	Jordan
JP	Japan
KE	Kenya
KG	Kyrgyzstan
KH	Cambodia
KI	Kiribati
KM	Comoros
KN	Saint Kitts and Nevis
KP	Korea, Democratic People's Republic of
KR	Korea, Republic of
KW	Kuwait
KY	Cayman Islands
KZ	Kazakhstan
LA	Lao People's Democratic Republic
LB	Lebanon
LC	Saint Lucia
LI	Liechtenstein
LK	Sri Lanka
LR	Liberia
LS	Lesotho
LT	Lithuania
LU	Luxembourg
LV	Latvia
LY	Libyan Arab
MA	Morocco
MC	Monaco
MD	Moldova, Republic of
MG	Madagascar
MH	Marshall Islands
ML	Mali
MM	Myanmar
MN	Mongolia
MO	Macau
MP	Northern Mariana Islands
MQ	Martinique
MR	Mauritania
MS	Montserrat
MT	Malta
MU	Mauritius
MV	Maldives
MW	Malawi
MX	Mexico
MY	Malaysia
MZ	Mozambique
NA	Namibia
NC	New Caledonia
NE	Niger
NF	Norfolk Island
NG	Nigeria
NI	Nicaragua
NL	Netherlands
NO	Norway
NP	Nepal
NR	Nauru
NU	Niue
NZ	New Zealand
OM	Oman
PA	Panama
PE	Peru
PF	French Polynesia
PG	Papua New Guinea
PH	Philippines
PK	Pakistan
PL	Poland
PM	Saint Pierre and Miquelon
PN	Pitcairn
PR	Puerto Rico
PT	Portugal
PW	Palau
PY	Paraguay
QA	Qatar
RE	Réunion
RO	Romania
RU	Russian Federation
RW	Rwanda
SA	Saudi Arabia
SB	Solomon Islands
SC	Seychelles
SD	Sudan
SE	Sweden
SG	Singapore
SH	Saint Helena
SI	Slovenia
SJ	Svalbard and Jan Mayen
SK	Slovakia
SL	Sierra Leone
SM	San Marino
SN	Senegal
SO	Somalia
SR	Suriname
ST	Sao Tome and Principe
SV	El Salvador
SY	Syrian Arab Republic
SZ	Swaziland
TC	Turks and Caicos Islands
TD	Chad
TF	French Southern Territories
TG	Togo
TH	Thailand
TJ	Tajikistan
TK	Tokelau
TM	Turkmenistan
TN	Tunisia
TO	Tonga
TP	East Timor
TR	Turkey
TT	Trinidad and Tobago
TV	Tuvalu
TW	Taiwan
TZ	Tanzania, United Republic of
UA	Ukraine
UG	Uganda
UM	United States Minor Outlying Islands
US	United States
UY	Uruguay
UZ	Uzbekistan
VA	Vatican City State (Holy See)
VC	Saint Vincent and the Grenadines
VE	Venezuela
VG	Virgin Islands (British)
VI	Virgin Islands (U.S.)
VN	Vietnam
VU	Vanuatu
WF	Wallis and Futuna Islands
WS	Samoa
YE	Yemen
YT	Mayotte
YU	Yugoslavia
ZA	South Africa
ZM	Zambia
ZR	Zaire
ZW	Zimbabwe

# Authorized Service Centers

---

QUALITY **JVC**<sup>®</sup> SERVICE  
*HOW TO LOCATE YOUR JVC SERVICE CENTER*  
**TOLL FREE: 1 (800) 537-5722**  
**<http://www.jvc.com>**

Dear Customer,

In order to receive the most satisfaction from your purchase, please read the instruction booklet before operating the unit. In the event that repairs are necessary, please call 1 (800)537-5722 for your nearest authorized servicer or visit our website at **[www.JVC.com](http://www.JVC.com)**

Remember to retain your Bill of Sale for Warranty Service.

---

## **Do not service the television yourself**

---

### **Caution**

To prevent electrical shock, do not open the cabinet. There are no user serviceable parts inside. Please refer to qualified service personnel for repairs.

### **Accessories**

To purchase accessories for your JVC product, please call toll free: 1 (800)882-2345 or on the web at **[www.JVC.com](http://www.JVC.com)**

---



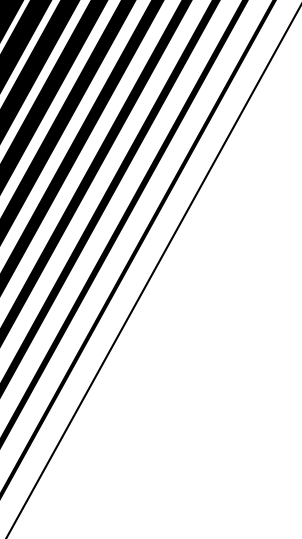

## Free Manuals Download Website

<http://myh66.com>

<http://usermanuals.us>

<http://www.somanuals.com>

<http://www.4manuals.cc>

<http://www.manual-lib.com>

<http://www.404manual.com>

<http://www.luxmanual.com>

<http://aubethermostatmanual.com>

Golf course search by state

<http://golfingnear.com>

Email search by domain

<http://emailbydomain.com>

Auto manuals search

<http://auto.somanuals.com>

TV manuals search

<http://tv.somanuals.com>