

JVC



DVD DIGITAL CINEMA SYSTEM

TH-V70

Consists of XV-THV70, SP-PWV70, SP-XSV70, and SP-XCV70

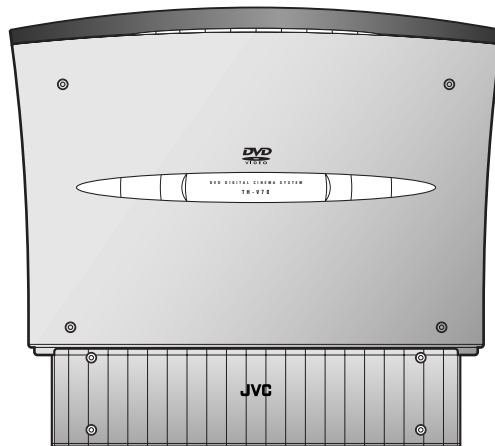
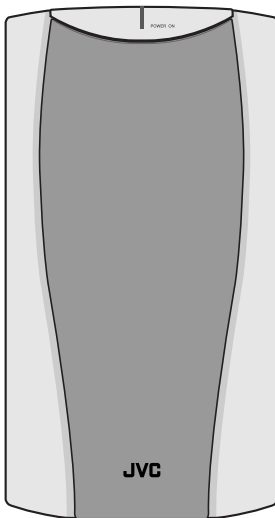
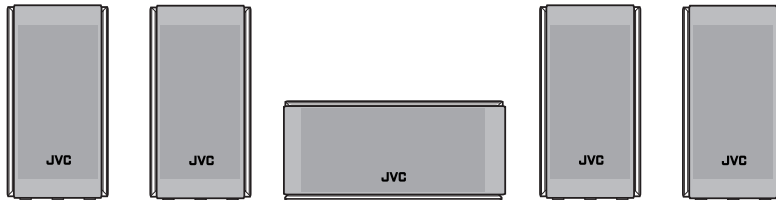

AV COMPU LINK *Digital Direct Progressive Scan*

INSTRUCTIONS

For Customer Use:

Enter below the Model No. and Serial No. which are located either on the rear, bottom or side of the cabinet. Retain this information for future reference.

Model No. _____

Serial No. _____

LVT0865-015A

[A]

Warnings, Cautions and Others

Caution — ⏻ button! (XV-THV70)

Disconnect the mains plug to shut the power off completely (the ⏻ goes off).

The ⏻ button in any position does not disconnect the mains line.

- When the system is on standby, the ⏻ lights red.
 - When the system is turned on, the operation lamps light red.
- The power can be remote controlled.

CAUTION

To reduce the risk of electrical shocks, fire, etc.:

1. Do not remove screws, covers or cabinet.
2. Do not expose this appliance to rain or moisture.

CAUTION

- Do not block the ventilation openings or holes.
(If the ventilation openings or holes are blocked by a newspaper or cloth, etc., the heat may not be able to get out.)
- Do not place any naked flame sources, such as lighted candles, on the apparatus.
- When discarding batteries, environmental problems must be considered and local rules or laws governing the disposal of these batteries must be followed strictly.
- Do not expose this apparatus to rain, moisture, dripping or splashing and that no objects filled with liquids, such as vases, shall be placed on the apparatus.

IMPORTANT FOR LASER PRODUCTS

REPRODUCTION OF LABELS

- ① CLASSIFICATION LABEL, PLACED ON EXTERIOR SURFACE

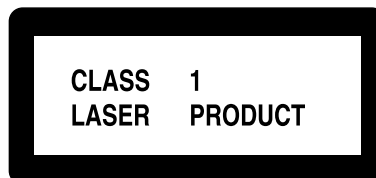

- ② WARNING LABEL, PLACED INSIDE THE UNIT

CAUTION : Visible and invisible laser radiation when open and interlock failed or defeated. AVOID DIRECT EXPOSURE TO BEAM. (e)	WARNING : Synlig och osynlig laserstrålning när den öppnas och spärren är urkopplad. Betrakta ej strålen. (s)
ADVARSEL : Synlig og usynlig laserstrålning når maskinen er åben eller interlocken fejler. Undgå direkte eksponering til stråling. (d)	VARO : Avattaessa ja suojalukitus ohitettuna tai viallisena olet alttiina näkyvälle ja näkymättömälle lasersäteilylle. Vältä säteen kohdistumista suoraan itseesi. (f)

1. CLASS 1 LASER PRODUCT
2. **DANGER**: Visible and invisible laser radiation when open and interlock failed or defeated. Avoid direct exposure to beam.
3. **CAUTION**: Do not open the top cover. There are no user serviceable parts inside the Unit; leave all servicing to qualified service personnel.

Caution: Proper Ventilation

To avoid risk of electric shock and fire and to protect from damage, locate the apparatus as follows:

Top: No obstructions and open spacing.

Sides/Front/Back: No obstructions should be placed in the areas shown by the dimensions below.

Bottom: Place on the level surface. Maintain adequate air path for ventilation by placing on a stand with a height of 10 cm more.

Front view

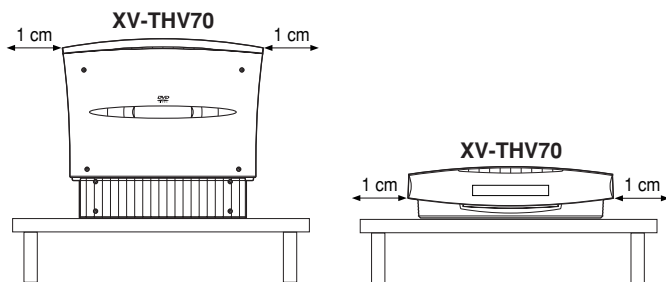

Side view

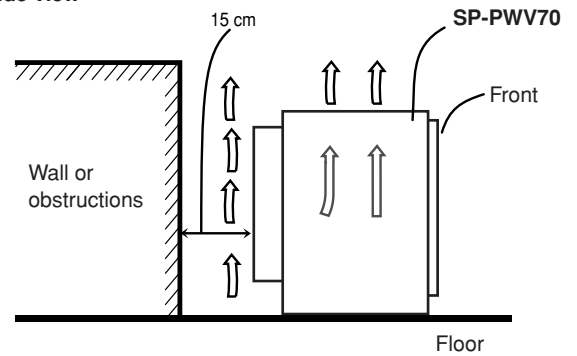

Table of Contents

Introduction	2	Advanced operations	37
Notes on handling	2	Using the on-screen bar	37
Checking the supplied accessories	2	Showing the on-screen bar	37
Names of parts and controls	3	Basic operation through the on-screen bar	38
About discs	6	Changing the time information	38
Playable disc types	6	Locating a desired scene from the disc menu	39
Disc structure	7	Locating a desired scene from the DVD menu	39
Playback Control function (PBC)	7	Locating a desired scene from the Video CD/SVCD menu with PBC	39
Getting started	8	Selecting a view angle of DVD	40
Setting the DISP.SET selector	8	Selecting a view angle	40
When placing the center unit vertically	9	Showing all view angles on the TV	41
Connections	10	Changing the subtitle languages and audio languages	41
Connecting a TV	10	Selecting the subtitle language	41
Connecting the FM and AM antennas	11	Selecting the audio language	42
Connecting the powered subwoofer	12	Selecting the audio channel	43
Connecting the satellite speakers	12	Playing from a specified position on a disc	44
Connecting to an analog component	14	Locating a desired chapter from the on-screen bar	44
Connecting to a digital component	14	Locating a desired position by specifying the time	45
Connecting the power cord	15	Locating a desired scene from the digest display	45
Installing the equipment on the wall	16	Special picture playback	46
When attaching the rear speakers to a wall	16	Frame-by-frame playback	46
When attaching the AM loop antenna to a wall	16	Showing continuous still pictures	46
When attaching the center unit to a wall	17	Playing back in slow-motion	47
Using the remote control	19	Zooming in/out	47
Putting batteries in the remote control	19	Changing the VFP setting	48
Operating the system from the remote control	19	Changing the track order	49
Using the remote control for TV operations	20	Playing back in the desired order	49
Basic operations	21	Playing back tracks in random order	49
Turning on/off the system	21	Repeat playback	50
Selecting the source to play	22	Repeating a current title, chapter, or all tracks	50
Adjusting volume	22	Repeating a desired part	50
Turning off the sound temporarily	23	MP3 disc playback	51
Adjusting the brightness	23	JPEG disc playback	53
Turning off the power with the timer	24	Setting DVD preferences	55
Setting the subwoofer	24	Using the choice menus	55
Changing the decode mode	25	Choice menus	55
Changing the scan mode	26	Basic procedure through the choice menus	56
Basic playback	27	LANGUAGE menu	57
Inserting and removing a disc	27	PICTURE menu	58
Stopping playback temporarily	28	AUDIO menu	59
Stopping playback completely	29	SPK. SETTING menu	60
Moving back the playback position during DVD playback	29	OTHERS menu	62
Searching for a particular point	30	Restricting playback by Parental Lock	63
Locating the beginning of a desired chapter or track ..	30	Setting Parental Lock	63
Locating a desired selection using Number buttons ...	30	Changing the setting of Parental Lock	64
Tuner operations	31	Releasing Parental Lock temporarily	64
Setting the AM tuner interval spacing	31	Setting the system through the display window	66
Tuning in to stations manually	31	AV COMPU LINK remote control system	67
Using preset tuning	31	Operating other manufacturers' video equipment	69
Selecting the FM reception mode	32	Using the remote control for CATV converter or DBS tuner operations	69
Reducing the noise of AM broadcast	32	Using the remote control for VCR	70
Creating the realistic sound fields	33	Maintenance	71
Dolby Surround	33	Troubleshooting	72
DTS Digital Surround	33	Glossary	75
DAP modes	34	Specifications	76
All Channel Stereo	34		
Selecting the surround mode	35		
Using Dolby Pro Logic II, Dolby Digital and DTS Digital Surround	35		
Using DAP Modes and All Channel Stereo	36		

Introduction

Notes on handling

Important cautions

Installation of the system

- Select a place which is level, dry and neither too hot nor too cold between 5°C and 35°C (41°F and 95°F).
- Leave sufficient distance between the system and the TV.
- Do not use the system in a place subject to vibrations.

Power cord

- Do not handle the power cord with wet hands!
- A small amount of power (1.7 watts) is always consumed while the power cord is connected to the wall outlet (the center unit only).
- When unplugging the power cord from the wall outlet, always pull the plug, not the power cord.

To prevent malfunction of the system

- There are no user-serviceable parts inside. If anything goes wrong, unplug the power cord and consult your dealer.
- Do not insert any metallic object into the system.
- Do not apply any shock to the moving panel when it is open.
- An 8 cm disc cannot be played back in this system. (Do not attempt to insert an 8 cm disc using an adaptor. Doing so will damage the system.)
- Do not use any non-standard shape disc (like a heart, flower, or credit card, etc.) available on the market, because it may damage the system.
- Do not use a disc with tape, stickers, or paste on it, because damage to the system may result.

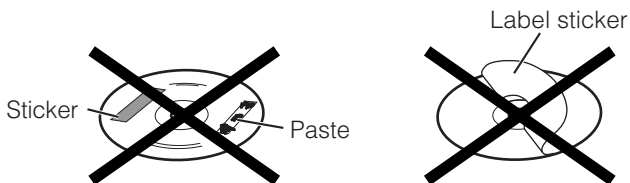

Note about copyright laws

Check the copyright laws in your country before recording from DVD Video, Super Video CD (SVCD), Video CD, and Audio CD discs. Recording of copyrighted material may infringe copyright laws.

Note about the copyguard system

The DVD Video discs are protected by the copyguard system. When you connect the system to your VCR directly, the copyguard system activates and the picture may not be played back correctly.

Safety precautions

Avoid moisture, water and dust

Do not place the system in moist or dusty places.

Avoid high temperatures

Do not expose the system to direct sunlight or do not place it near a heating device.

When you are away

When away on travel or otherwise for an extended period of time, remove the plug from the wall outlet.

Do not block the vents

Blocking the vents may damage the system.

Care of the cabinet

When cleaning the system, use a soft cloth and follow the relevant instructions on the use of chemically-coated cloths. Do not use benzene, thinner or other organic solvents including disinfectants. These may cause deformation or discoloring.

- Do not clean the moving panel when it is open.

If water gets inside the system

Turn the system off and remove the plug from the wall outlet, then call the store where you made your purchase. Using the system in this state may cause a fire or electrical shock.

Checking the supplied accessories

Check to be sure you have all of the supplied accessories. The number in the parentheses is the quantity of the pieces supplied.

If anything is missing, contact your dealer immediately.

- Remote control (1)
- Batteries (2)
- Stand (1) (for the center unit)
- Legs (2) (for the stand)
- FM antenna (1)
- AM loop antenna (1)
- Power cord (1)
- System cord (1)
- Video cord (1)
- AV COMPULINK cord (1)
- Speaker cords
 - 5 m (3): For the left front speaker, right front speaker, and center speaker
 - 10 m (2): For the left rear speaker and right rear speaker (The length of the above speaker cords are approximate.)
- Speaker wall brackets (2)
- Screws
 - For the stand (1)
 - For the speaker wall brackets (2)
- Paper pattern (1) (for attaching the center unit to a wall)

Names of parts and controls

See pages in the parentheses for details.

Center unit

Front panel

Placed vertically (with DISP.SET set to "V")

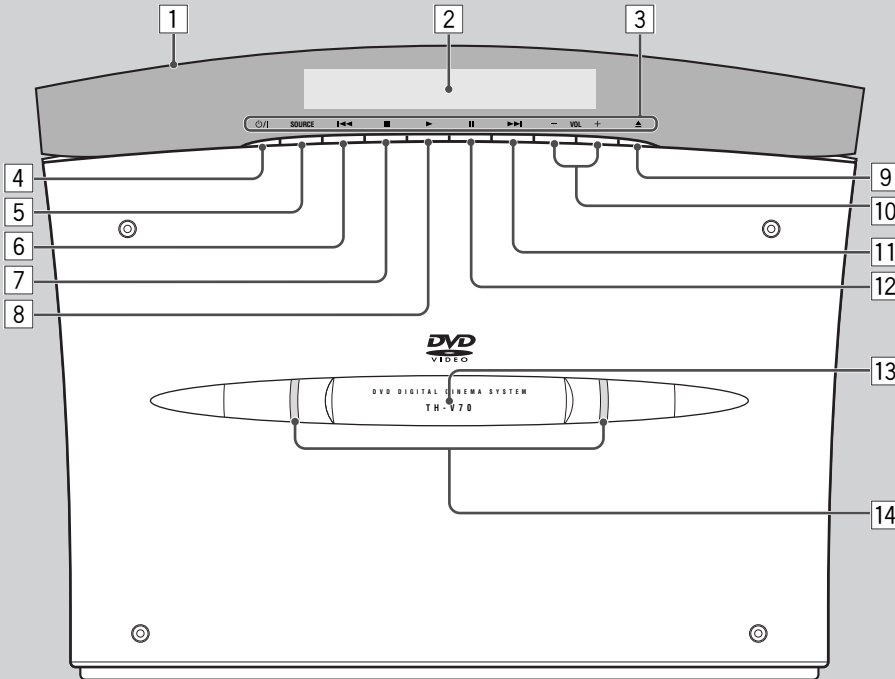

Front panel

- 1 Moving panel (21)
- 2 Display window
- 3 Button name indicators (21)
- 4 $\odot/|$ button (21)
- 5 SOURCE button (22)
- 6 \lll (reverse skip) button (30)
- 7 \blacksquare (stop) button (29)
- 8 \triangleright (play) button (29)
- 9 \blacktriangle (open/close) button (27)
- 10 VOLUME +/- buttons (22)
- 11 \ggg (forward skip) button (30)
- 12 $\|\$ (pause) button (28, 46)
- 13 Remote sensor (19)
- 14 Illumination lamps (21)

Placed horizontally (with DISP.SET set to "H")

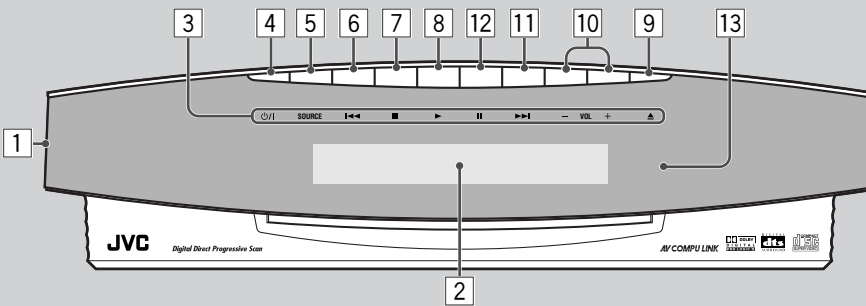

Rear panel

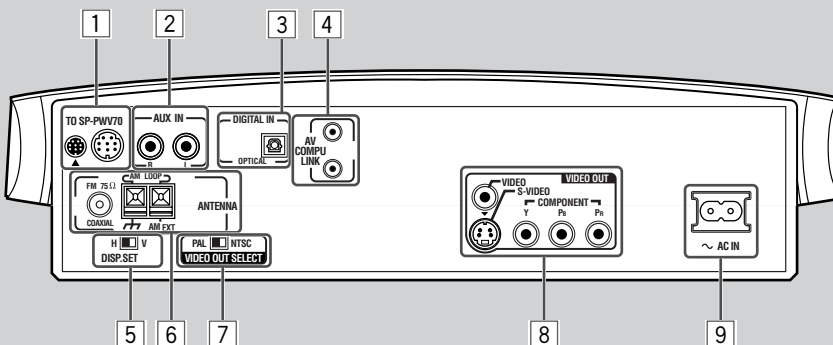

Rear panel

- 1 System cord CONNECTOR (12)
- 2 AUX IN jacks (14)
- 3 DIGITAL IN jack (14)
- 4 AV COMPU LINK jacks (67)
- 5 DISP.SET (Display set) selector (8)
- 6 ANTENNA terminals (11)
- 7 VIDEO OUT SELECT switch (10)
- 8 VIDEO OUT jacks (10)
VIDEO, S-VIDEO, COMPONENT
(Y, P_B, P_R)
- 9 \sim AC IN socket (15)

Display window

Placed vertically (with DISP.SET set to "V")*

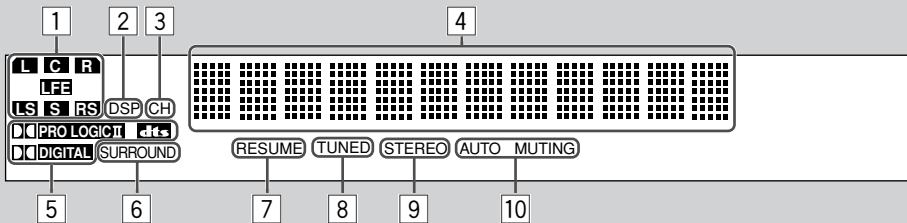

Placed horizontally (with DISP.SET set to "H")

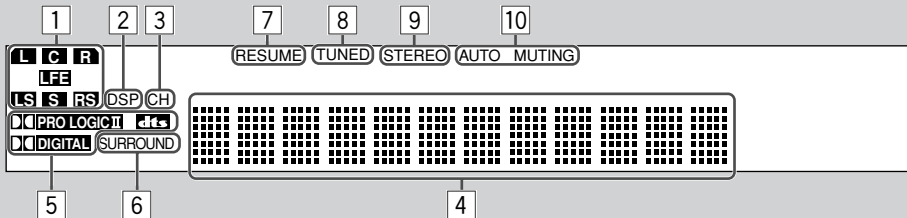

Display window

- 1 Signal indicators (34)
- 2 DSP indicator (34)
- 3 CH indicator (32)
- 4 Main display
- 5
 - PRO LOGIC II indicator (33)
 - Digital signal format indicators (33)
 - DOLBY DIGITAL and DTS
- 6 SURROUND indicator (36)
- 7 RESUME indicator (29)
- 8 TUNED indicator (31)
- 9 STEREO indicator (31, 32)
- 10 AUTO MUTING indicator (32)

* This manual explains operations using the illustrations of the display window that are shown when the center unit is placed vertically (the DISP.SET selector is set to "V").

Powered subwoofer

Rear

Front

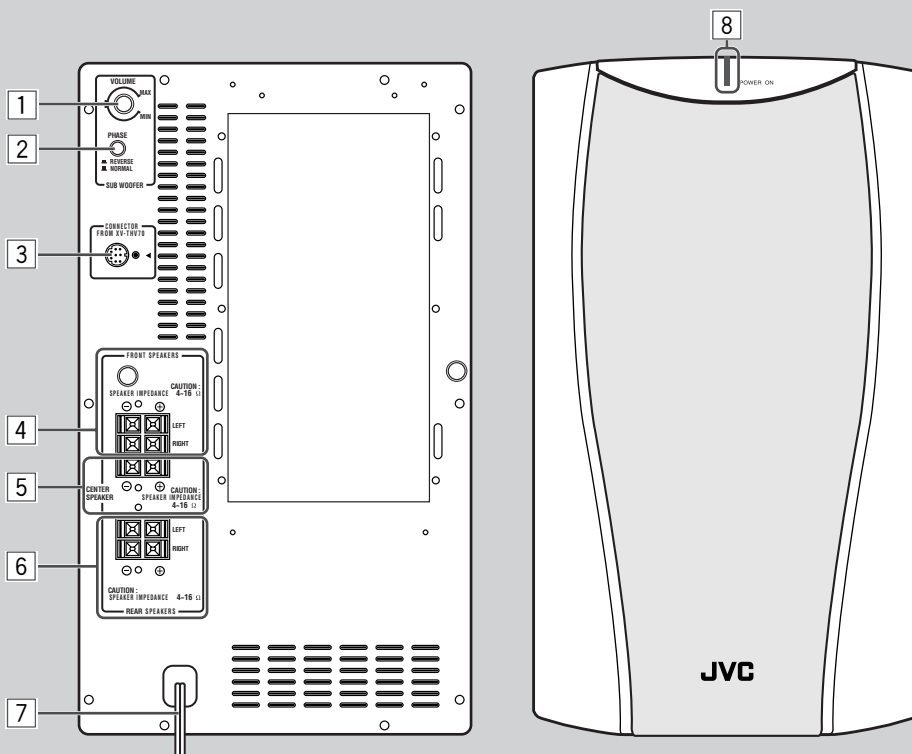

Powered subwoofer

- 1 VOLUME knob (24)
- 2 PHASE button (24)
- 3 System cord CONNECTOR (12)
- 4 FRONT SPEAKERS terminals (13)
- 5 CENTER SPEAKER terminals (13)
- 6 REAR SPEAKERS terminals (13)
- 7 Power cord (15)
- 8 POWER ON lamp (22)

Names of parts and controls

Remote control

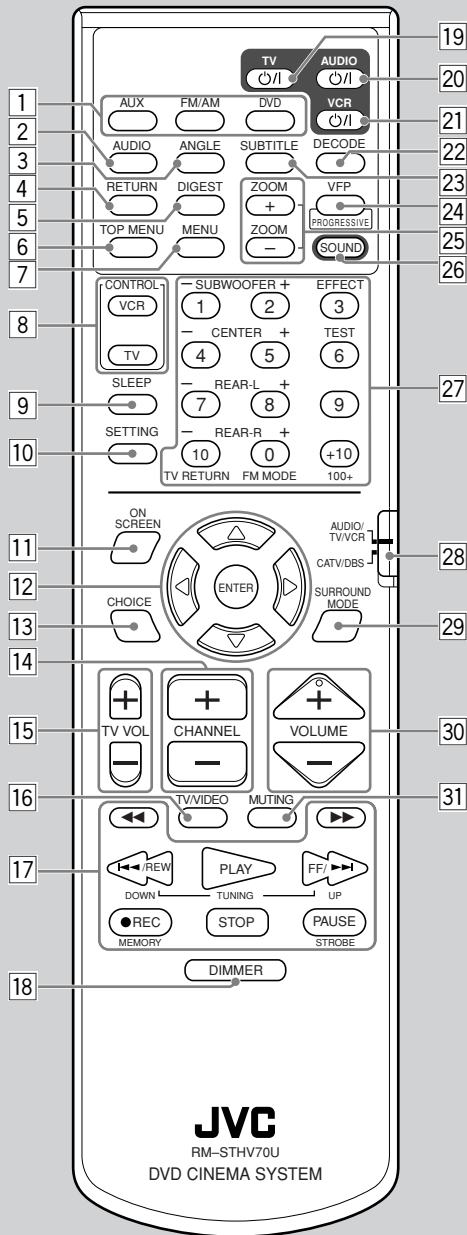

Remote control

- 1 Source selecting buttons (22)
AUX, FM/AM, DVD
- 2 AUDIO button (42, 43)
- 3 ANGLE button (40, 41)
- 4 RETURN button (39)
- 5 DIGEST button (45)
- 6 TOP MENU button (39)
- 7 MENU button (39, 54)
- 8 CONTROL buttons
VCR (70), TV (20)
- 9 SLEEP button (24)
- 10 SETTING button (66)
- 11 ON SCREEN button (37)
- 12 Cursor ◀/▶/▲/▼ and ENTER buttons
- 13 CHOICE button (56, 63)
- 14 CHANNEL +/- buttons (20, 69, 70)
- 15 TV VOL +/- buttons (20)
- 16 TV/VIDEO button (20)
- 17 Operating buttons
◀◀, ▶▶ (30, 47)
◀◀/REW (TUNING DOWN) (30, 31, 51, 53)
PLAY (29, 46, 51, 53)
FF/▶▶ (TUNING UP) (30, 31, 51, 53)
● REC (MEMORY) (31, 70)
STOP (29, 51, 53)
PAUSE (STROBE) (28, 46, 51, 53)
- 18 DIMMER button (23)
- 19 TV ⏻ button (20, 69)
- 20 AUDIO ⏻ button (21)
- 21 VCR ⏻ button (70)
- 22 DECODE button (25)
- 23 SUBTITLE button (41)
- 24 VFP (PROGRESSIVE) button (26, 48)
- 25 ZOOM +/- buttons (47, 53)
- 26 SOUND button (35, 36)
- 27 • Number buttons
• Sound setting buttons (24, 35, 36)
SUBWOOFER +/-, CENTER +/-, REAR-L +/-, REAR-R +/-
• EFFECT button (36)
• TEST button (35)
• FM MODE button (32)
- 28 Remote control mode selector
- 29 SURROUND MODE button (35)
- 30 VOLUME +/- buttons (22)
- 31 MUTING button (23)

About discs







Playable disc types

This system has been designed to play back the following discs:

DVD Video, Video CD, Super Video CD (SVCD), Audio CD, CD-R, and CD-RW.

- This system can also play back MP3 and JPEG files recorded on CD-Rs and CD-RWs. For in-depth information about MP3, see “MP3 disc playback” on page 51, and about JPEG, see “JPEG disc playback” on page 53.
- We refer to DVD Video as DVD in this manual.

Discs you can play:

Disc Type	DVD	Video CD	SVCD	Audio CD	CD-R	CD-RW
Mark (Logo)		 Video CD	 VIDEO CD			
Video Format	NTSC/PAL			_____	_____	_____
Region Code Number*	4 ALL	_____	_____	_____	_____	_____

- The following discs cannot be played back:
 - DVD Audio, DVD-ROM, DVD-RAM, DVD-R, DVD-RW, CD-ROM, CD-I (CD-I Ready), Photo CD, etc. Playing back these discs will generate noise and damage the speakers.
 - 8 cm disc
An 8 cm disc cannot be played back in this system. (Do not attempt to insert an 8 cm disc using an adaptor. Doing so will damage the system.)
- **On some DVD, Video CD, or SVCD discs, their actual operations may be different from what is explained in this manual. This is due to the disc programming and disc structure, but not a malfunction of this system.**
- **Notes on CD-R and CD-RW**
 - User-edited CD-Rs (Recordable) and CD-RWs (Rewritable) can be played back only if they are already “finalized.”
 - The system can play back CD-Rs or CD-RWs recorded on a personal computer if they have been recorded in the audio CD format.
The system can also play back CD-Rs or CD-RWs if MP3 files or JPEG files are recorded on them.
However, they may not be played back because of their disc characteristics, recording conditions, or damage or stain on them.
Especially, the configuration and characteristics of an MP3 disc or a JPEG disc is determined by the writing (encoding) software and hardware used for recording. Therefore, due to the software and hardware used, the following symptoms may occur:
 - Some discs may not be played back.
 - Some tracks on an MP3 disc are skipped and may not be played back normally.
 - Some files on a JPEG disc may be played back distortedly.
 - Before playing back CD-Rs or CD-RWs, read their instructions or cautions carefully.
 - CD-RWs may require a longer readout time. This is caused by the fact that the reflectance of CD-RWs is lower than for regular CDs.

* Note on Region Code

DVD players and DVDs have their own Region Code numbers. This system can play back only DVDs recorded with the color system of NTSC or PAL whose Region Code numbers include “4.”



If a DVD with the improper Region Code numbers is loaded, “REGION CODE ERROR” appears on the display and playback cannot start.

IMPORTANT: Before playing a disc, make sure of the following....

- Check the connection with the TV.
- Turn on the TV and select the correct input mode on the TV to view the pictures or on-screen indications on the TV screen.
- For DVD playback, you can change the initial setting to your preference. (See pages 55 to 65.)

If  appears on the TV screen when pressing a button, the disc cannot accept an operation you have tried to do, or information required for that operation is not recorded on the disc.

NOTICE: In some cases, without showing , operations will not be accepted.

Disc structure

A DVD Video disc consists of "titles," and each title may be divided into some "chapters." (See Example 1.) For example, if a DVD disc contains some movies, each movie may have its own title number, and it may be further divided into some chapters.

On the other hand, a Video CD, SVCD, and Audio CD consist of "tracks." (See Example 2.)

In general, each track has its own track number. (On some discs, each track may also be divided by Indexes.)

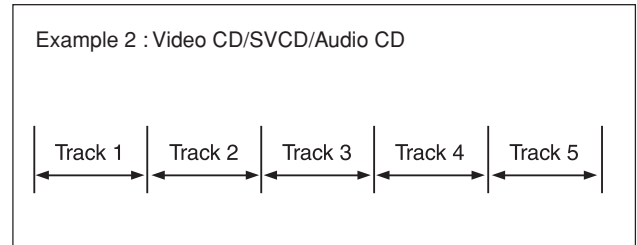
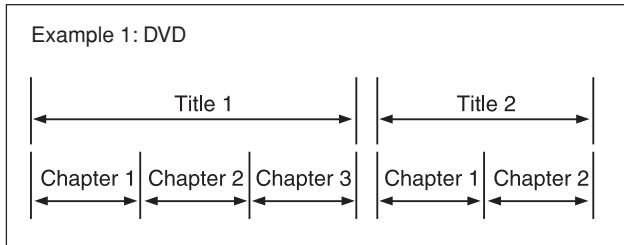

Playback Control function (PBC)

The Playback Control function allows you to enjoy menu-driven operation and high-resolution still images which have a resolution four times greater than moving pictures.

• High-resolution still image display

You can display high-quality images four times clearer than moving pictures.

• Menu-driven playback

A selection menu is displayed when you start playing a Video CD and SVCD disc with the Playback Control feature. The selection menu shows a list of numbers for selection. Some discs may show moving pictures or a divided screen.

You can interact with the screen using a menu display to select and play an entry.

See example illustration below about basic feature of menu-driven playback (for details about the operation through the menu, see also page 39).

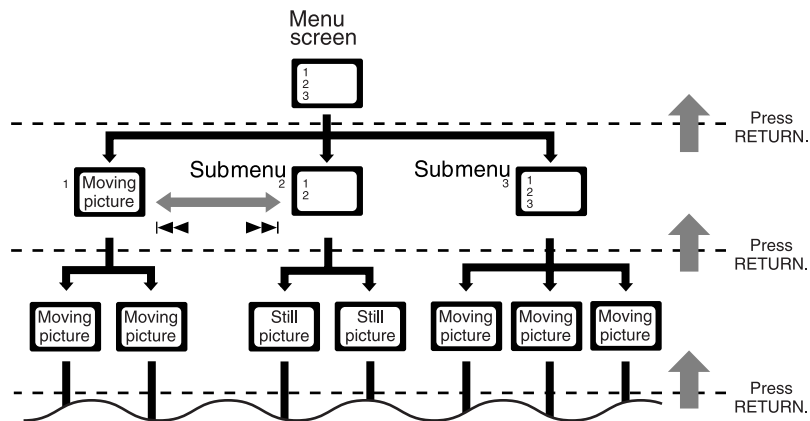

NOTE:

While operating a Video CD or SVCD using the menu, some of the functions such as repeat play may not work.

Getting started

Setting the DISP.SET selector

You can place the center unit either vertically (on the supplied stand) or horizontally (without the stand) as illustrated below. Before installing the center unit, set the DISP.SET selector according to your selection.

- The position of the remote control sensor also changes according to this setting. See page 19.

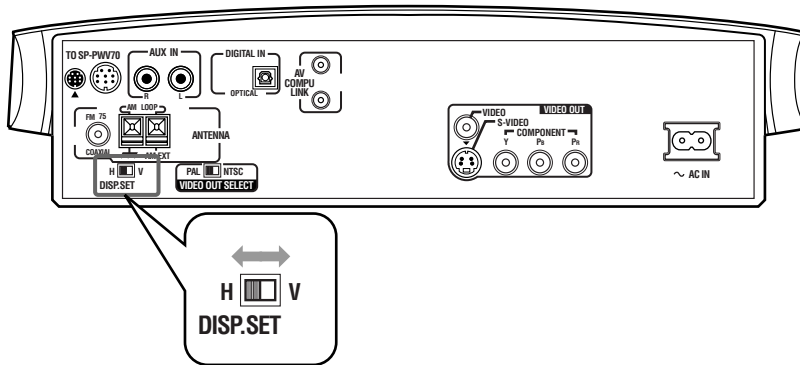

■ When placing the center unit vertically:

Slide the DISP.SET selector to "V" (vertically).

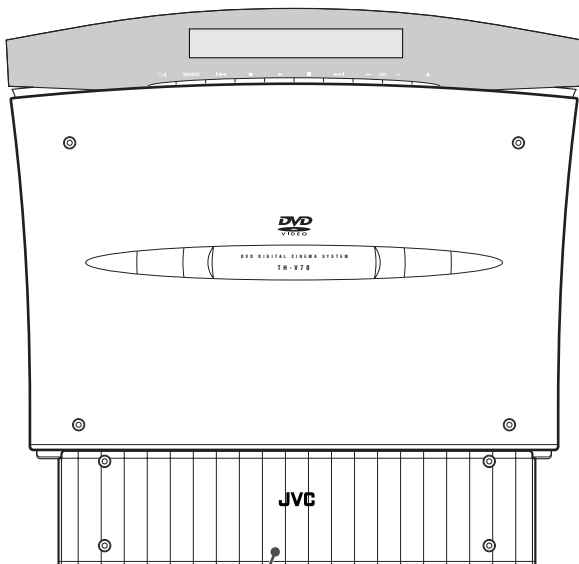

Stand (supplied)*

*To attach the stand, see page 9.

■ When placing the center unit horizontally:

Slide the DISP.SET selector to "H" (horizontally).

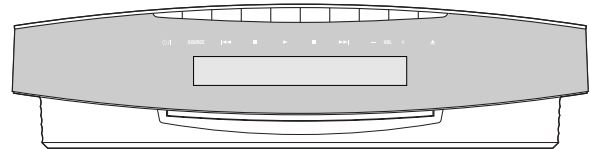

This manual explains operations using the illustrations of the display window that are shown when the center unit is placed vertically (the DISP.SET selector is set to "V").

When placing the center unit vertically

When placing the center unit vertically, attach the supplied stand.

- 1 Connect the cords by passing them through the holes of the stand as illustrated below.

For connections, see pages 10 to 15.

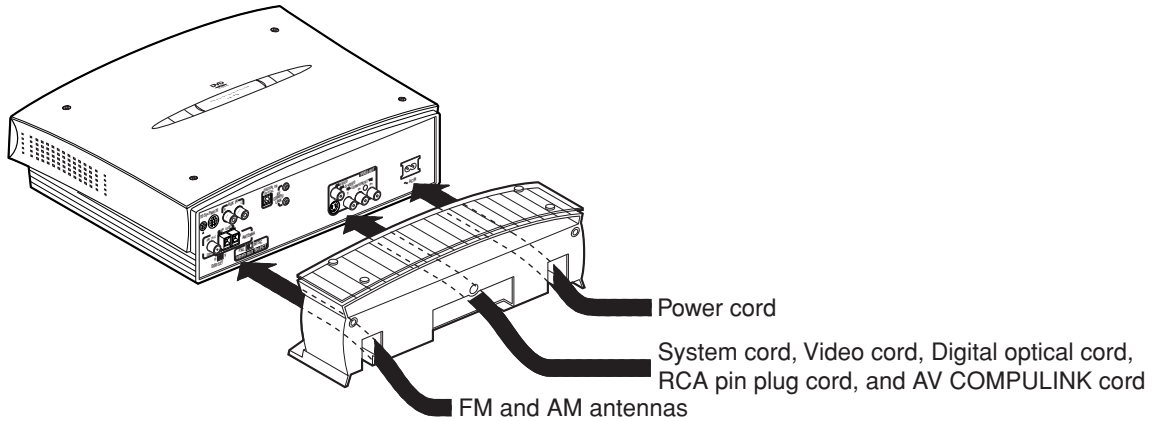

NOTE:

To avoid the interference from other cords, you had better separate three bundles of cords respectively.

- 2 Attach the stand to the center unit firmly using the supplied screw.

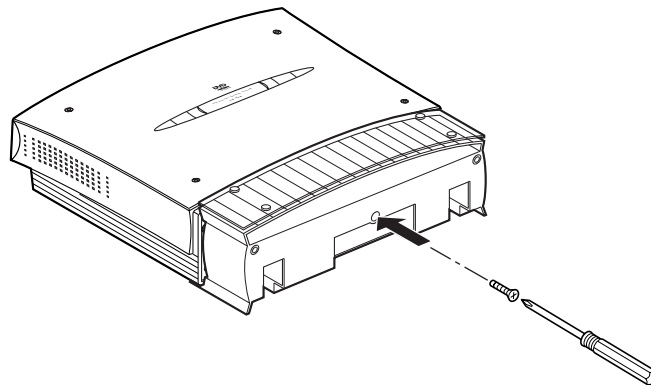

- 3 Attach the legs to the stand.

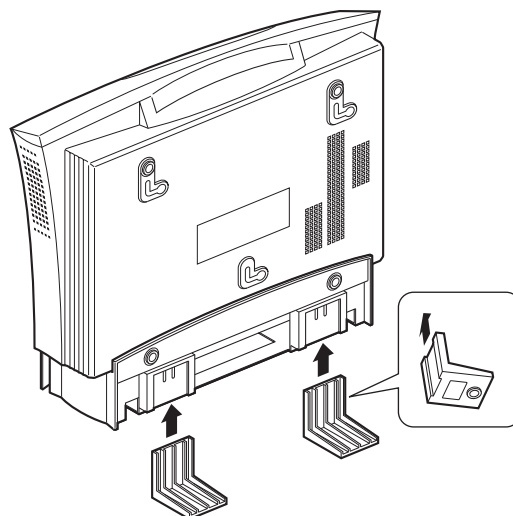

NOTE:

Avoid an unstable place when placing the center unit vertically. Make sure to place it on the level surface.

Connections

- Do not connect the AC power cord until all other connections have been made.
- Since different components often have different terminal names, carefully read the instructions supplied with the component you are going to connect.

Connecting a TV

To view pictures and on-screen displays, connect a TV to the center unit.

- Connecting to a TV through a VCR, or to a TV with a built-in VCR, may cause distortion of picture.
- You need to set "MONITOR TYPE" in the PICTURE menu correctly according to the aspect ratio of your TV. See page 58.

■ To connect a TV without the component video input jacks

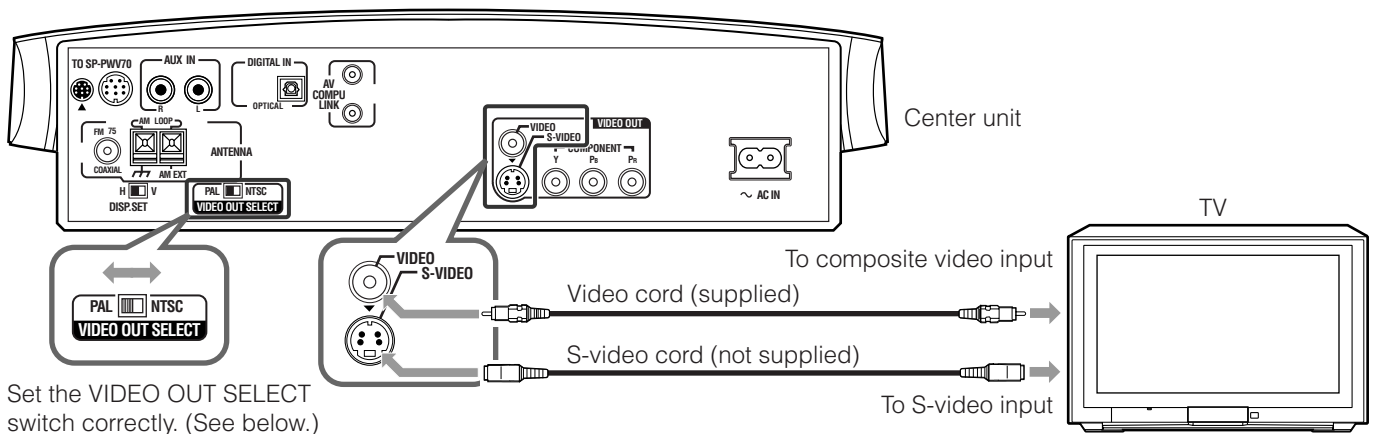

If your TV has S-video (Y/C-separation) jack, connect it using an S-video cord.

By using this jack, you can get a better picture quality than using composite video connection.

- Connect S-video cord by matching the ▼ mark on the plug to the one on the system.

■ To connect a TV with the component video input jacks

If your TV has the component video input jacks, connect it with the component video cord (not supplied) to view a high quality picture.

- Connect "Y" to "Y," "P_B" to "P_B," and "P_R" to "P_R" correctly.
- If your TV supports the progressive video input, you can enjoy a high quality picture by making the progressive scan mode active. See page 26.

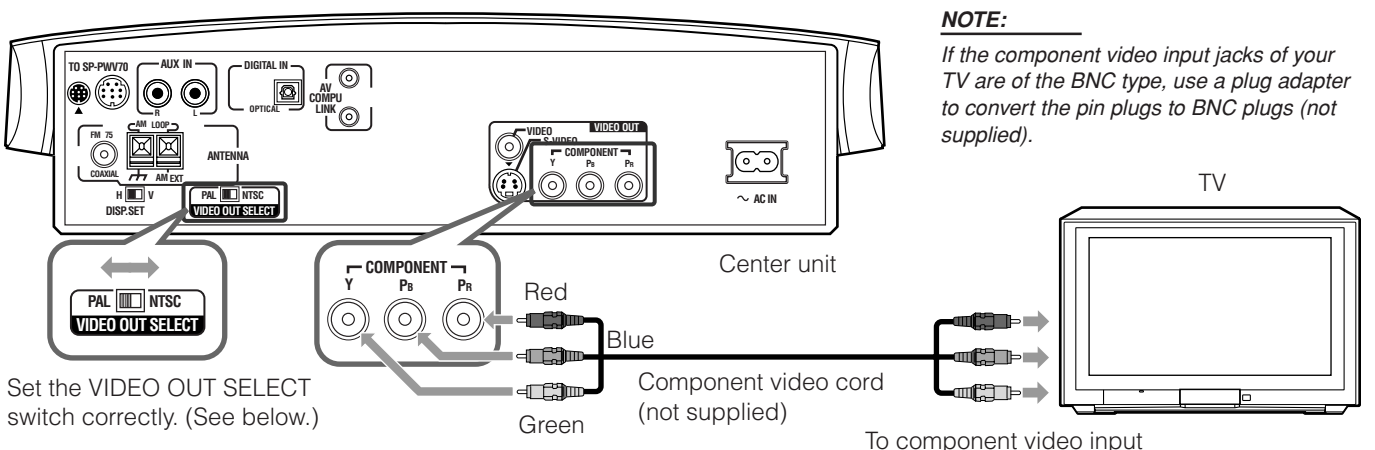

■ Selecting the color system

The center unit is compatible with the PAL and NTSC systems. Set the VIDEO OUT SELECT switch on the rear panel in standby mode to match the color system of your TV. Make sure that the color system of a DVD, Video CD, or SVCD disc labeled on the package matches your TV.

- If you use a multi-system TV, by setting "MONITOR TYPE" in the PICTURE menu to an appropriate "MULTI" option, the system outputs a video signal by the same format recorded on the disc (i.e. if you play an NTSC disc, the system outputs a signal by the NTSC format) regardless of the VIDEO OUT SELECT switch setting. See page 58.



Getting Started

Connecting the FM and AM antennas

- Make sure the antenna conductors do not touch any other terminals, connecting cords, and power cords. This could cause poor reception.

■ AM loop antenna

Setting up AM loop antenna

Attach the AM loop to its base by snapping the tabs on the loop into the slot in the base.

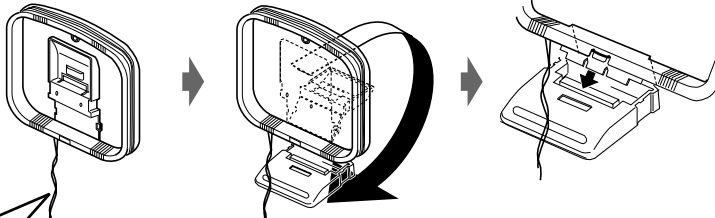

If the antenna cord is covered with vinyl, remove the vinyl by twisting it as shown.

Outdoor single vinyl-covered wire (not supplied)

If reception is poor:

Connect an outdoor single vinyl-covered wire to the AM EXT terminal. (Keep the AM loop antenna connected.)

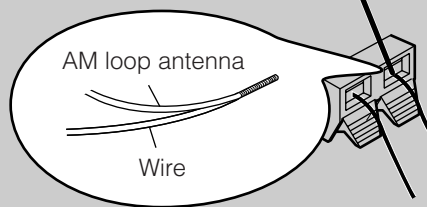

Connecting AM loop antenna

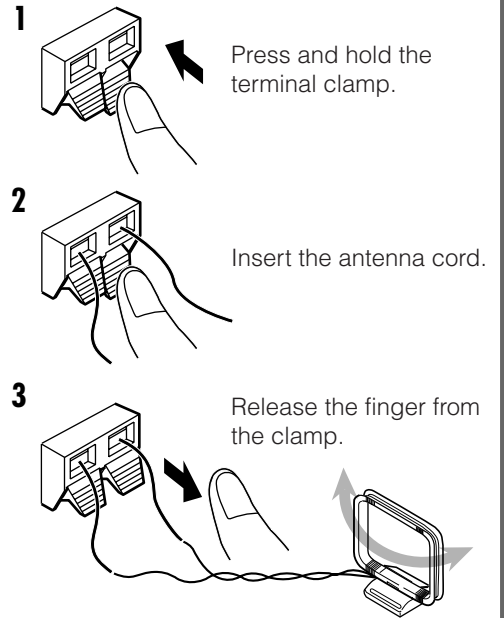

- Turn the loop until you have the best reception.

Center unit

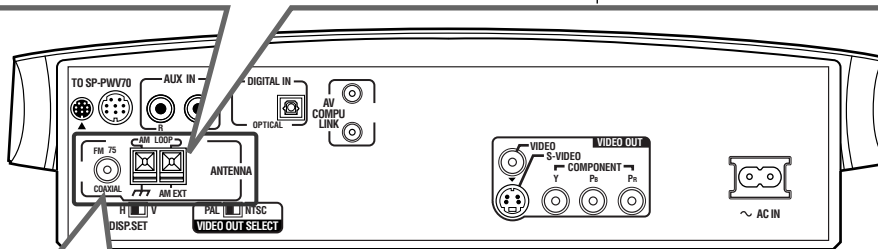

■ FM antenna

Connecting the supplied FM antenna

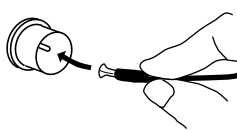

Extend the supplied FM antenna horizontally.

If reception is poor:

Connect an outdoor FM antenna with the standard type (coaxial) connector.



NOTES:

- Disconnect the supplied FM Antenna before attaching a 75 Ω coaxial connector (the kind with a round wire going to an outdoor antenna).
- We recommend that you use a coaxial cable to the FM antenna, since it is well-shielded against interference.

Connecting the powered subwoofer

Connect the supplied powered subwoofer (SP-PWV70) using the supplied system cord.

- Connect the system cord by matching the ▲ marks on the plugs to the ones on the system and powered subwoofer.

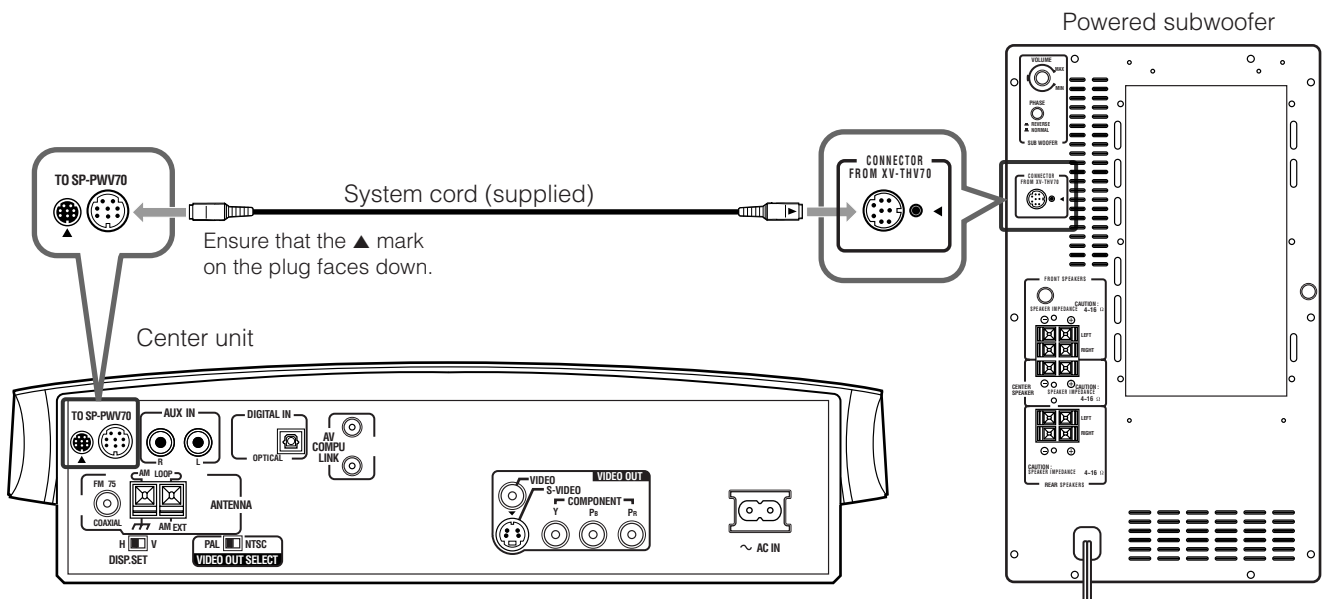

Connecting the satellite speakers

■ Speaker layout

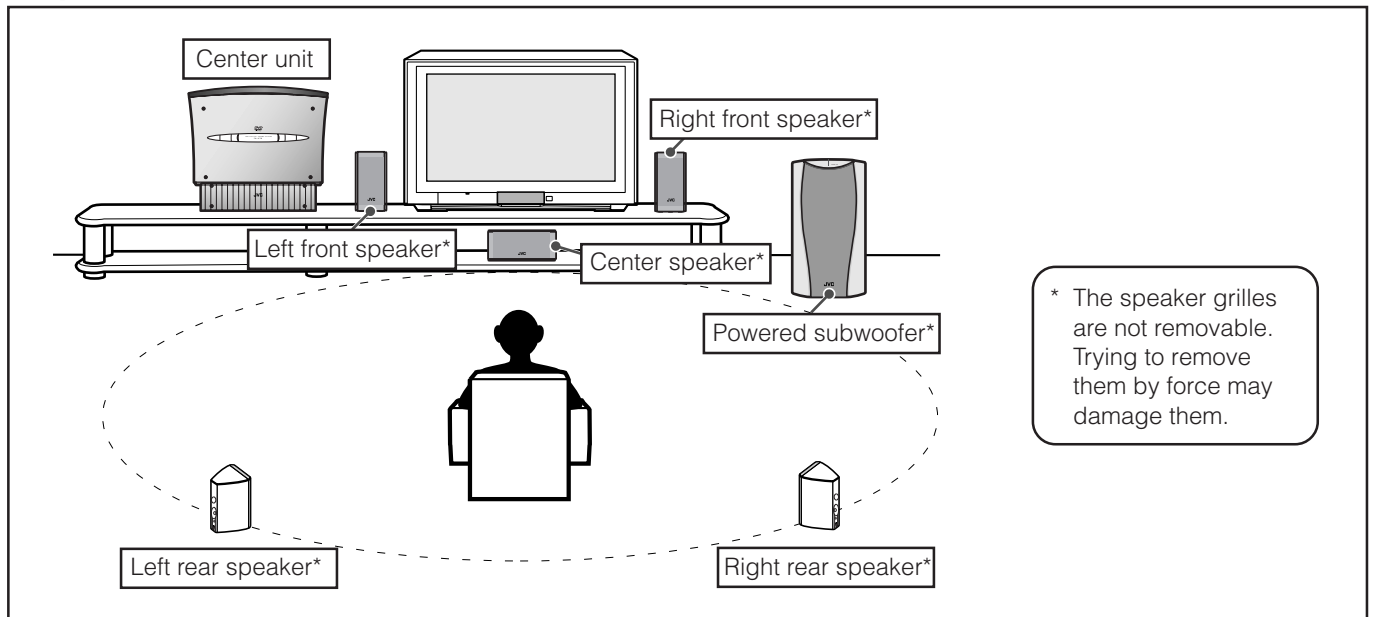

When placing the speakers, to obtain the best possible sound from this system, you need to place all satellite speakers at the same distance from the listening position with the front of each speaker faced toward the listener.

When you cannot place them at the same distance from the listening position, you can make adjustment as if those speakers are placed at the best position. See page 61.

- Normally, place the powered subwoofer in front of you. (Since bass sound is non-directional, you do not need to place it at the same distance as the satellite speakers.)

NOTES:

- Although the satellite speakers and the powered subwoofer are magnetically shielded, the TV screen may be mottled. In this case, keep the distance from them to the TV by over 10 cm.
- For safety reasons, always ensure that there is a sufficient space behind the subwoofer.
- When you place the satellite speakers on the relatively high position, such as the top of your bookshelf, place them on a flat and level surface.

Getting Started

■ Connecting the satellite (front, center, rear) speakers

Connect the satellite speakers to the powered subwoofer using the supplied speaker cords.

- Connect the white cord to the red (+) terminal and the black cord to the black (-) terminal.

CAUTION:

- When you do not connect the supplied speakers but connect other (larger) speakers, use the speakers with the SPEAKER IMPEDANCE indicated by the speaker terminals on the rear panel of the subwoofer.
- DO NOT connect more than one speaker to one speaker terminal.

Before connecting the speaker cord

1

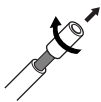

If the speaker cord is covered with vinyl, remove the vinyl by twisting it as shown above.

2



Fold the end of each speaker cord to avoid short-circuit.

Connecting the speaker cord to the satellite speakers

* The terminal of SP-XSV70

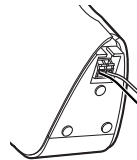

1

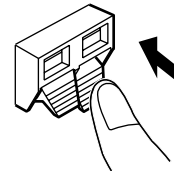

Press and hold the terminal clamp.

2

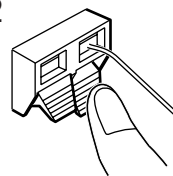

Insert the speaker cord.

3

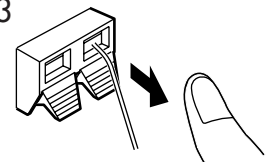

Release the finger from the terminal clamp.

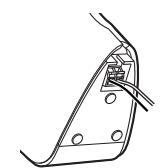
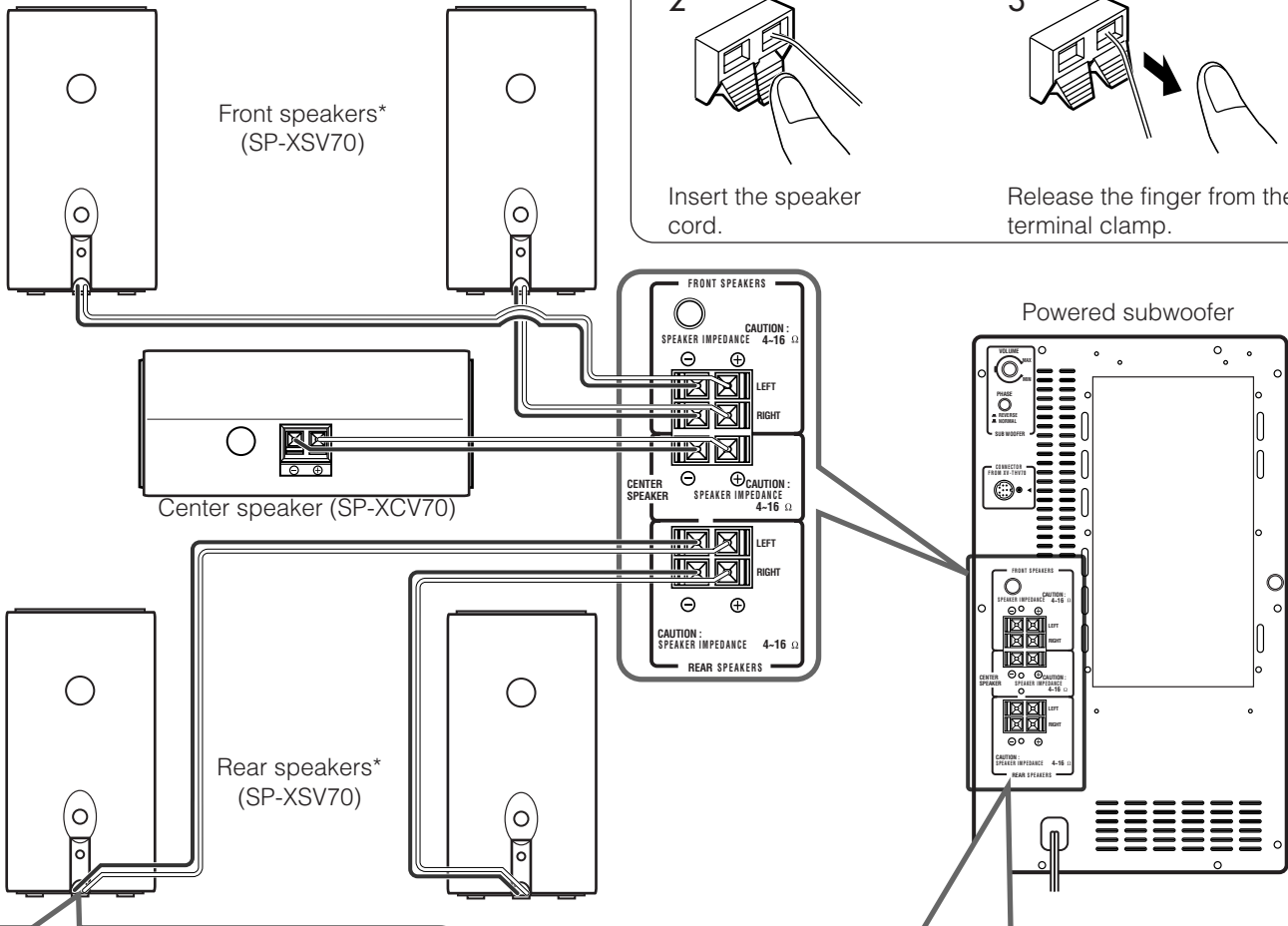

Connect the speaker cords.

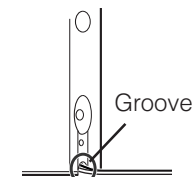

Let the cables pass through the groove.

Connecting the speaker cord to the powered subwoofer

1

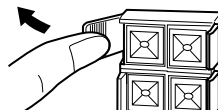

Open the terminal clamp.

2

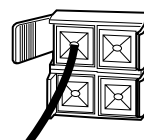

Insert the speaker cord.

3

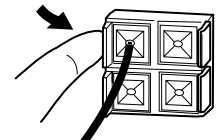

Close the terminal clamp.

Connecting to an analog component

You can enjoy the sound of an analog component such as a VCR, TV, or Cassette recorder through this system. Connect an analog component using the cord with RCA pin plugs (not supplied).

- Connect the white plug to "AUX IN L" (the left audio jack), the red to "AUX IN R" (the right audio jack).

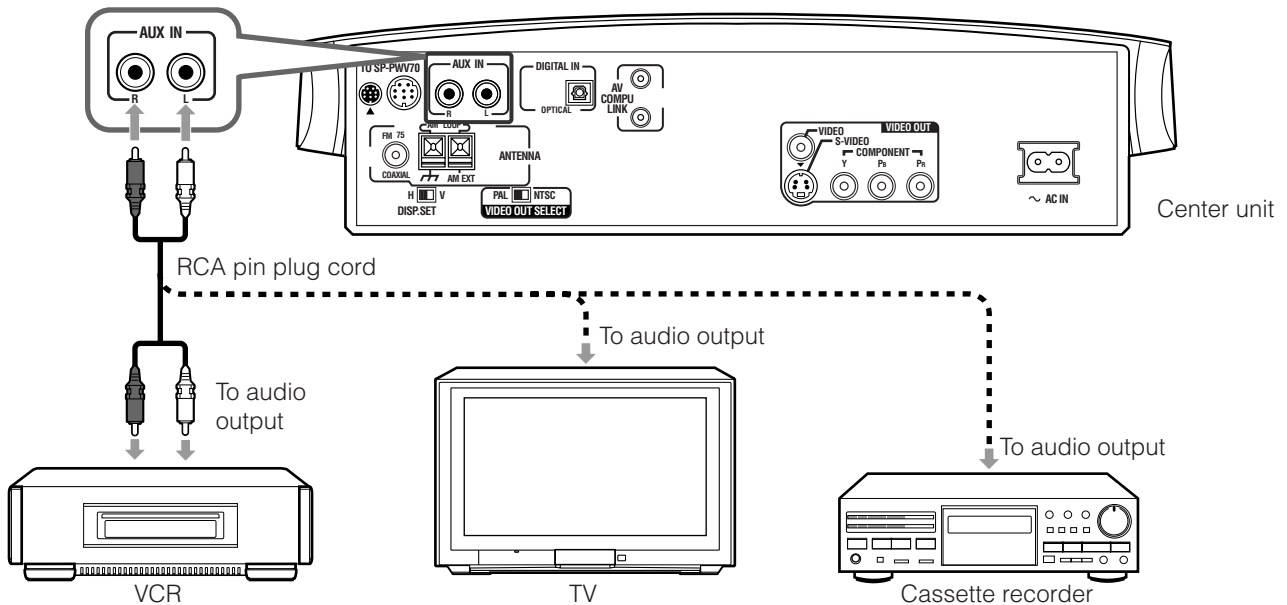

NOTES:

- If you connect a sound-enhancing device such as a graphic equalizer between the source components and this system, the sound output through this system may be distorted.
- When playing a video component such as a VCR:
 - To listen to the sound, operate this system. (Select "AUX" as the source to play. See page 22.)
 - To see the picture, connect the video output jack of the component to the video input jack of the TV, and select the correct input mode on the TV.

Connecting to a digital component

You can enjoy the sound of a digital component such as a DBS tuner or MD recorder through this system. Connect a digital component using the digital optical cord (not supplied).

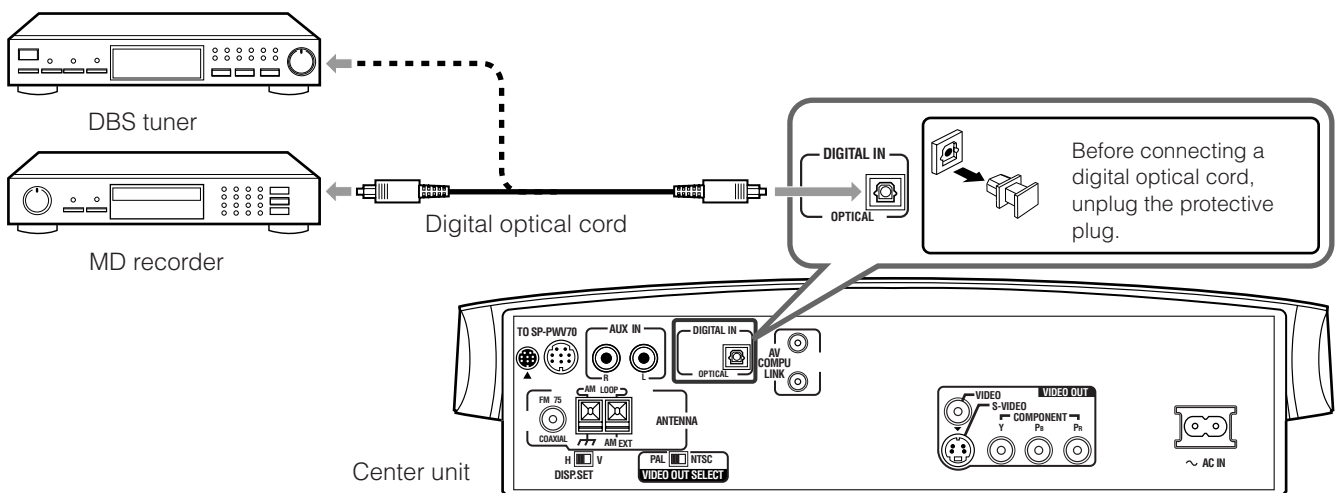

NOTES:

- When playing a video component such as a DBS tuner:
 - To listen to the sound, operate this system. (Select "AUX DIGITAL" as the source to play. See page 22.)
 - To see the picture, connect the video output jack of the component to the video input jack of the TV directly, and select the correct input mode on the TV.

Getting started

Connecting the power cord

Make sure that all connections have been made, before plugging the power cords of the center unit and powered subwoofer.

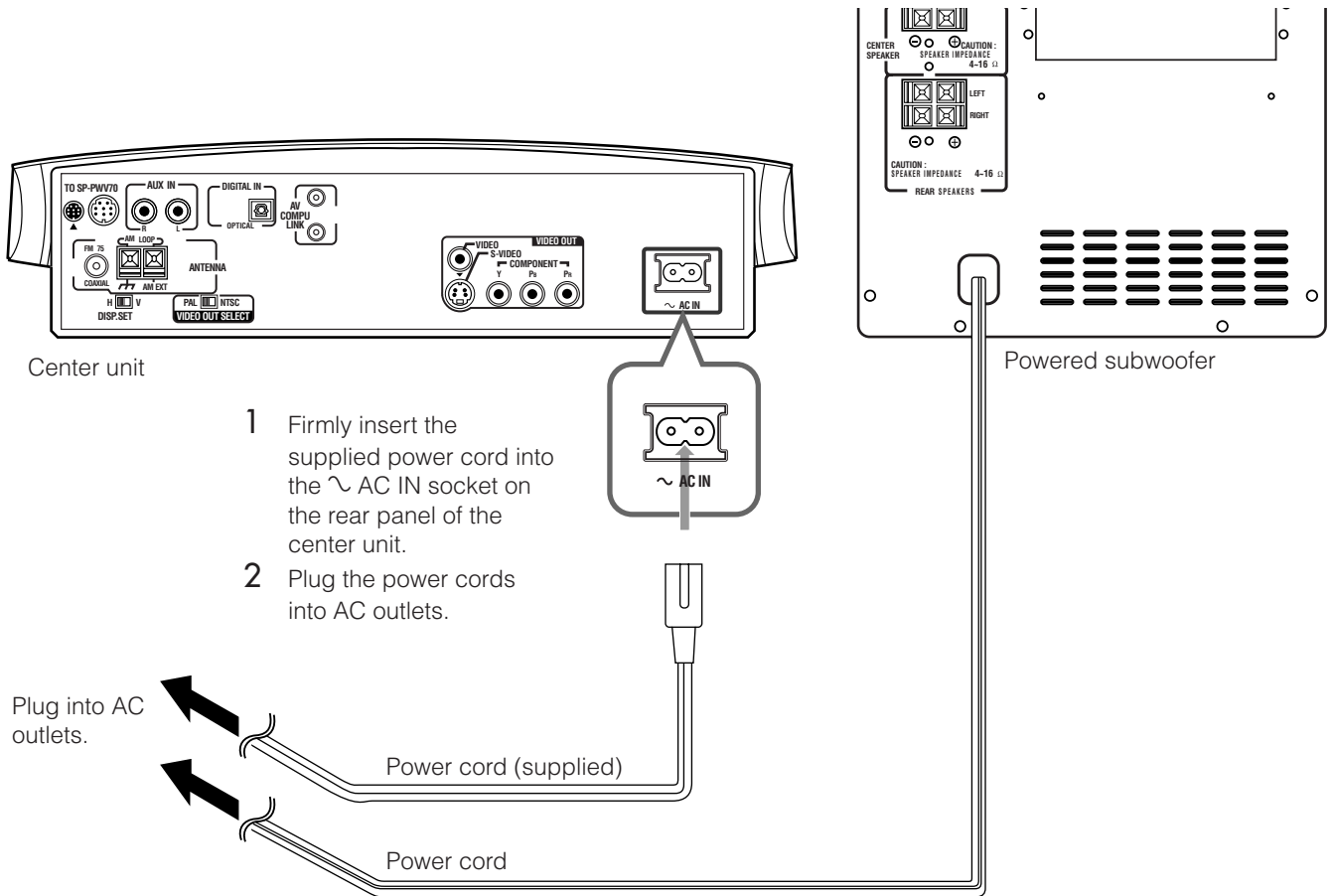

CAUTIONS:

- Disconnect the power cord before cleaning or moving the system.
- Do not touch the power cord with wet hands.
- Do not pull on the power cord to unplug the cord.
When unplugging the cord, always grasp the plug so as not to damage the cord.

NOTES:

- Keep the power cords away from the connecting cords. The power cords may cause noise or screen interference.
- The preset settings such as preset stations, and sound adjustment may be erased in a few days in the following cases:
 - When you unplug the power cord of the center unit.
 - When a power failure occurs.
- The speakers will not produce any sound if the power cord of the powered subwoofer is removed from the AC outlet while the center unit is turned on.
In this case, press AUDIO $\odot/|$ on the remote control or $\odot/|$ on the center unit to turn off the power, plug in the powered subwoofer, then press AUDIO $\odot/|$ or $\odot/|$ again.

Installing the equipment on the wall

When attaching the rear speakers to a wall

Using the supplied speaker wall brackets, you can fix the rear speakers to the wall.

CAUTION: Attaching the brackets to the wall

When attaching the brackets to the wall, have them attached to the wall by a qualified person. DO NOT attach the brackets to the wall by yourself to avoid an unexpected damage due to their falling from the wall, caused by incorrect attachment or weakness in the wall.

Location of attachment to wall:

Take care when selecting a location for attaching rear speakers to the wall. Injury to personnel, or damage to equipment, may result if the speakers are attached in a location which interferes with daily activities.

Attaching speakers to the brackets

- 1 Use the supplied screws to attach the brackets to the rear speakers.

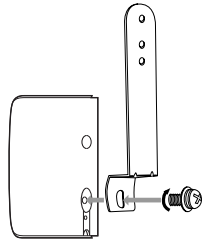

- 2 Adjust the angle of the rear speakers.

Loosen the screw slightly, make an adjustment, and then tighten the screw firmly.

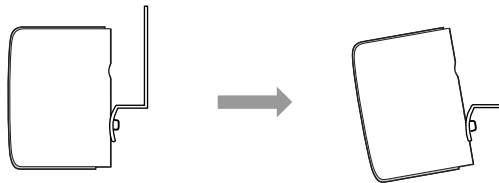

CAUTION:

If the screws are not tightened firmly, this may cause injury to personnel or damage to equipment.

When attaching the AM loop antenna to a wall

You can attach the AM loop antenna to the wall.

Mount the AM loop antenna to a wall using the screw (not supplied) as illustrated below.

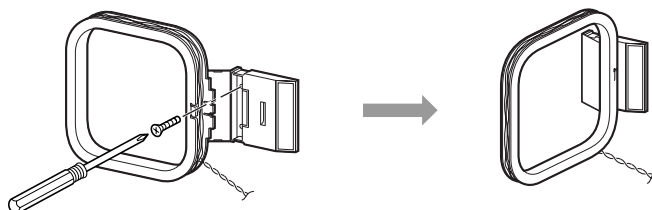

Getting started

When attaching the center unit to a wall

You can attach the center unit to a wall.

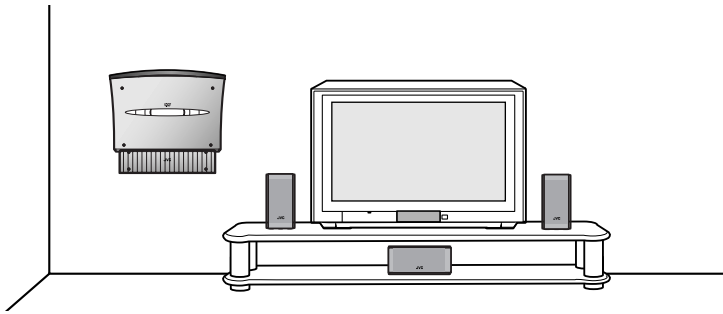

CAUTIONS: location of attachment to a wall

- Take care when selecting a location for attaching the center unit to the wall. Injury to personnel, or damage to the center unit, may result if the center unit is attached in a location which interferes with daily activities, or a location that the users are liable to knock their bodies or heads against the center unit.
- Avoid a location above a bed, sofa, water tank, sink, etc. or in a passage.

CAUTIONS: attachment to a wall

- The center unit weighs approximately 2.93 kg. When you operate the buttons on the center unit, an additional force will be applied to the center unit in downward direction. Therefore, sufficient care must be required when attaching the center unit to a wall to prevent any accidents caused by the unit's falling off.
- Before attaching the center unit to a wall, check the wall (or other related aspects) you want to attach it to, and verify whether the strength of the wall will be sufficient not only to support the weight of the center unit itself but also to withstand the additional downward force which will be applied to it during operations. (Do not attach the center unit to a plywood or plasterboard wall. The center unit will fall and sustain damage as a result.) If you cannot judge the strength of the wall or other aspects, consult a qualified person (such as a qualified constructor).
- The screws needed for attachment are not supplied. Use screws which are compatible with the strength and material of the pillar or wall.
- When attaching the center unit, the screws must be secured tightly in all three locations. Failure in attaching the center unit to the wall using all three holes on the back of the center unit makes for an unstable attachment, and it constitutes a safety hazard as the center unit may fall down.

Example of attachment

The procedure below is an example of how to attach the center unit to a wall:

It does not make any guarantee for safety while using the center unit on the wall. Take into account such factors as the material, strength, and the status of the wall as well as the reinforcing material, and the possible changes that will take place over time.

NOTES:

- You need to connect the cords to the center unit (and attach the supplied stand) before attaching it to the wall.
- DO NOT plug the power cord into an AC outlet before attaching the center unit to the wall.
- When attaching the supplied stand to the center unit, connect the video cords, system cord, and so on by passing them through the holes at the bottom of the stand, and do not attach the legs to the stand. See page 9.

- 1 Select the place where the center unit is to be attached.
- 2 Mount three screws (not supplied) to the wall.

Use the screws as illustrated below.

You can use the supplied paper pattern to mark the positions where the screws are mounted.

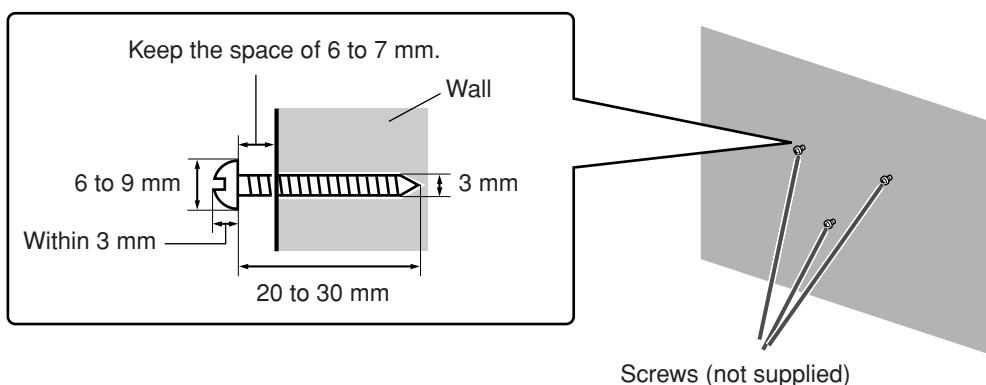

3 Hook the center unit onto the mounted screws, and slide it to left, then down.

Make sure that the center unit is attached securely.

- Adjust the screws if the center unit is not attached securely.

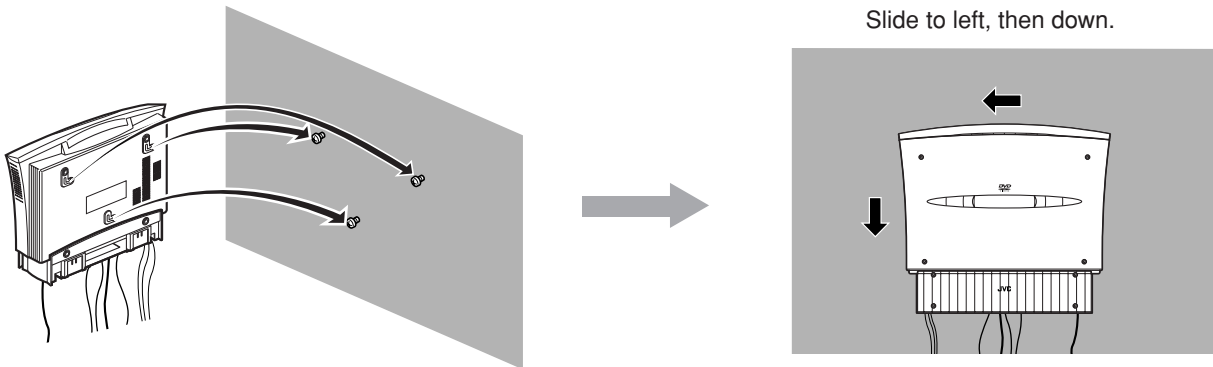

NOTES:

- Do not place anything on top of the center unit. Doing so may cause the center unit to fall down, and cause injury to the persons around.
- Do not climb onto the center unit or hang from it. Doing so may damage the center unit and/or cause injury to the person.
Take care specially when there are small children at the home.
- Avoid sandwiching the cords between the unit and wall. This may upset the balance of the center unit, and cause the center unit to fall down.
- Make sure that the connected cords will not interfere with daily activities and that the users will not be caught in the cords.
- Do not pull the connected cords with excessive force.
- Check regularly that none of the screws are loose.
- In the event that the center unit has fallen, turn the power off, disconnect the power plug from the AC outlet, and contact your dealer for an inspection and repairs. Using it in this state may cause a fire or electrical shock.
- Do not place valuables (breakables) underneath the location where the center unit is attached. They will be damaged if the center unit should fall.
- The manufacturer accepts absolutely no liability for any accidents or damage resulting from inadequate assembly or mounting, insufficient strength of attachment, misuse or abuse, or natural disasters.

Getting Started

Using the remote control

The remote control makes it easy to use many of the functions of the system at a distance of up to 7 m (23 feet) away.

- You can also operate other components from the remote control supplied with this system.
 - To operate your TV, see page 20.
 - To operate your VCR, CATV convertor, or DBS tuner, see page 69.

Putting batteries in the remote control

Before using the remote control, put two supplied batteries first.

- 1 On the back of the remote control, remove the battery cover.
- 2 Insert batteries.
 - Make sure to match the polarity: (+) to (+) and (-) to (-).
- 3 Replace the cover.

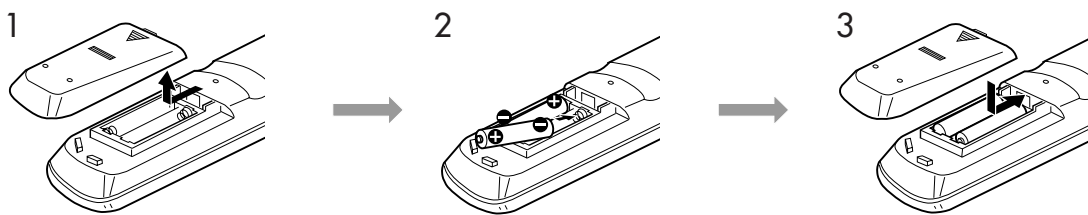

If the range or effectiveness of the remote control decreases, replace the batteries. Use two R6P (SUM-3)/AA (15F) type dry-cell batteries.

CAUTION:

Follow these precautions to avoid leaking or cracking batteries:

- Place batteries in the remote control so they match the polarity: (+) to (+) and (-) to (-).
- Use the correct type of batteries. Batteries that look similar may differ in voltage.
- Always replace both batteries at the same time.
- Do not expose batteries to heat or flame.

Operating the system from the remote control

Aim the remote control directly at the remote sensor on the center unit.

- To control other components, aim the remote control directly at the remote sensor on each component. Refer also to their instruction manuals .
- To operate the remote control properly, do not hide the remote sensor by placing any obstruction.

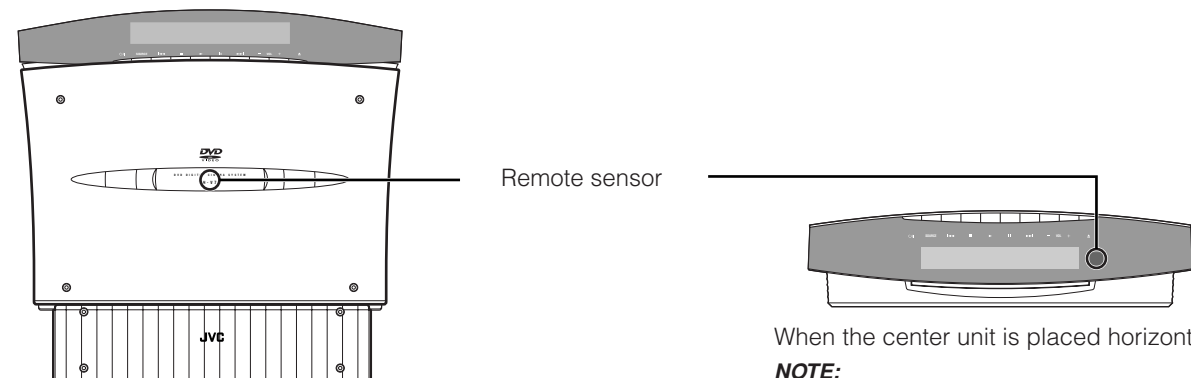

When the center unit is placed vertically

When the center unit is placed horizontally

NOTE:

When the moving panel is open, the remote sensor looks up, so the remote control may not work.
You can use the remote control while the moving panel is shut.

Using the remote control for TV operations

You can operate your TV using the remote control supplied with this system.

- Refer also to the instruction manuals supplied with your TV.

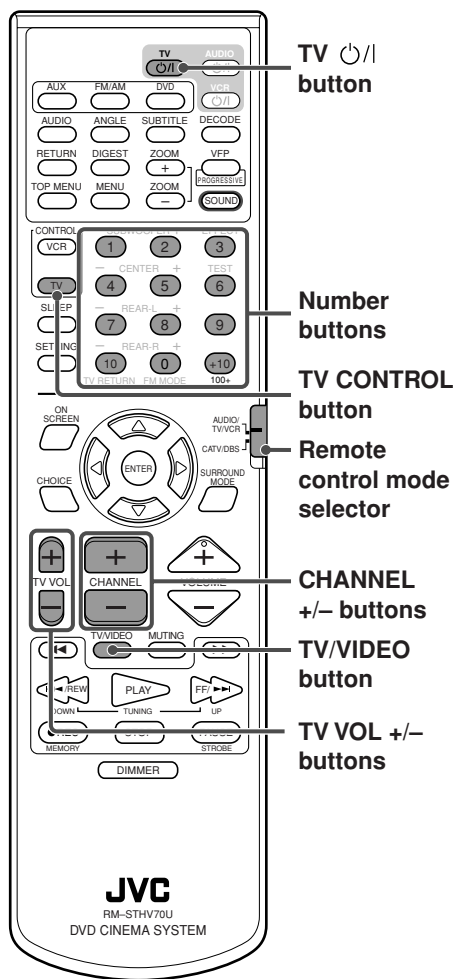

■ Setting the remote control signal for operating your TV.

- You can operate your TV without setting the remote control signal if your TV is a JVC TV.

- 1 Slide the remote control mode selector to "AUDIO/TV/VCR."
- 2 Press and hold TV On/Off.
 - Keep it pressed until step 4 is finished.
- 3 Press TV CONTROL.
- 4 Press Number buttons (1-9, 0) to enter a manufacturer's code (2 digit).

See the list below to find the codes.

- For a Hitachi TV, press 1, then 0.
- For a Toshiba TV, press 0, then 8.

- 5 Release TV On/Off.

- 6 Try to operate your TV by pressing TV On/Off.

When your TV turns on or off, you have entered the correct code.

If there are more than one code listed for your brand of TV, try each one until you enter the correct one.

Manufacturers' codes* for TV

Manufacturer	Code	Manufacturer	Code
JVC	01	Samsung	12
Hitachi	10	Sanyo	13
Magnavox	02	Sharp	06
Mitsubishi	03	Sony	07
Panasonic	04,11	Toshiba	08
RCA	05	Zenith	09

* Manufacturers' codes are subject to change without notice. If they are changed, this remote control cannot operate the equipment.

■ To operate your TV

You can use the following buttons for operating your TV:

IMPORTANT:

When using the remote control, check to see if its remote control mode selector is set to the correct position:

To operate TV, set it to "AUDIO/TV/VCR."

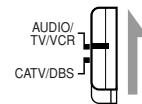

TV On/Off: Turns on and off your TV.

TV VOL +/-: Adjust the volume.

TV/VIDEO: Select the input mode (either TV or VIDEO).

- After pressing TV CONTROL, you can perform the following operations on the TV.

CHANNEL +/-: Changes the channels.

1-10, 0, +10 (100+): Selects the channel.

Basic operations

This section mainly explains operations commonly used when you enjoy this system.

- This manual mainly explains operations when the center unit is placed vertically (the DISP.SET selector is set to "V") as an example.
- Turn also on your TV and select the correct input mode on the TV.

IMPORTANT:

When using the remote control, check to see if its remote control mode selector is set to the correct position:

To operate this system, set it to "AUDIO/TV/VCR."

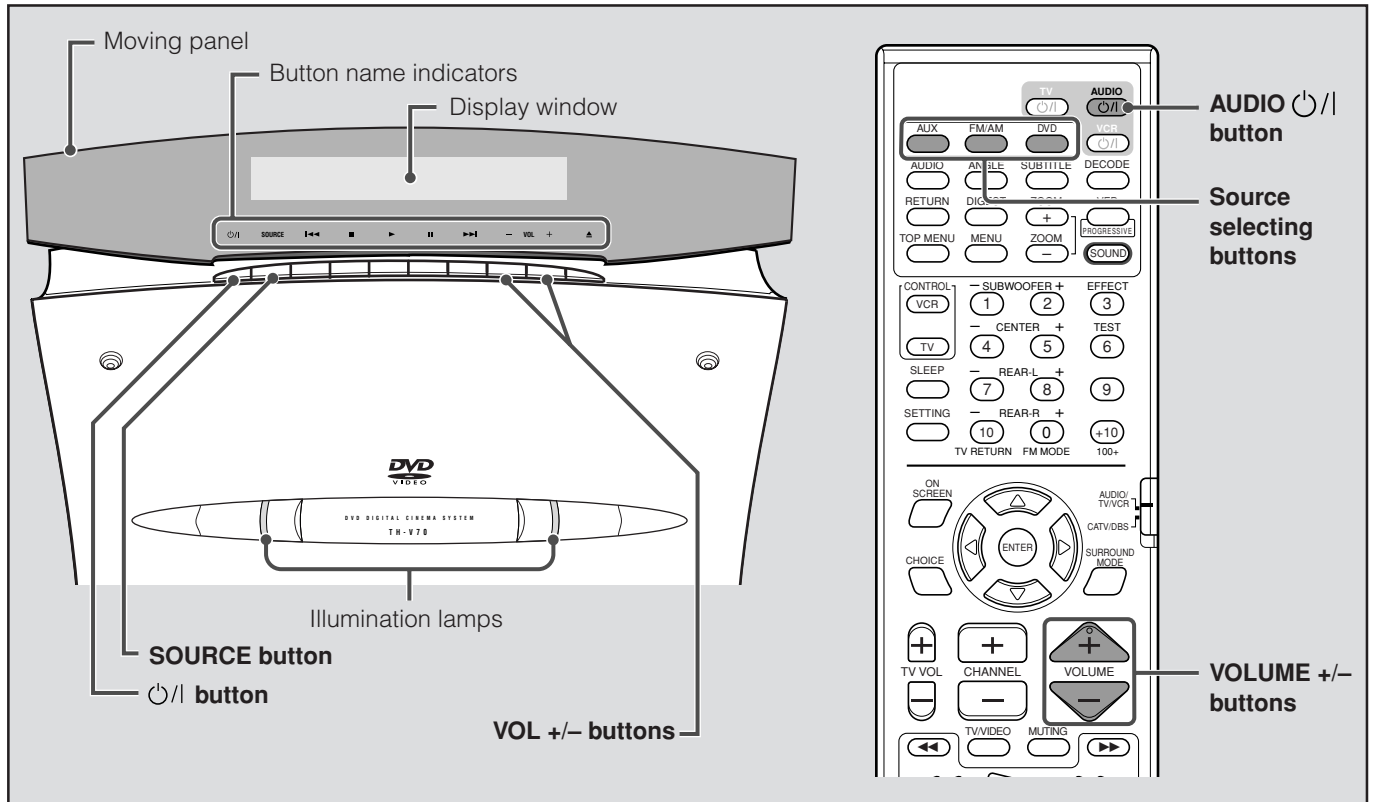
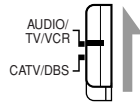

Turning on/off the system

From the remote control: Press AUDIO to turn the power on.

On the center unit: Press to turn the power on.

• When you place the center unit vertically:

The moving panel stands up.

The illumination lamps and the button name indicators light up, and the current source name appears on the display window.

• When you place the center unit horizontally:

The illumination lamps and the button name indicators light up, and the current source name appears on the display window.

- When DVD, AUX, or AUX DIGITAL is selected as the source (see page 22), the opening screen* appears on the TV screen.

* Opening screen

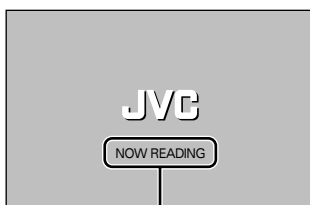

Message area

The following messages may appear in the message area depending on the status of this system.

- "LOADING"/"EJECT": Appears when inserting or removing a disc.
- "NOW READING": Appears when the system is reading the disc information.
- "REGION CODE ERROR!": Appears when the region code of the DVD does not match the system.
The DVD cannot be played back.
- "NO DISC": Appears when no disc is inserted.

To turn power off

From the remote control: Press AUDIO  again.

On the center unit: Press  again.

The illumination lamps and the button name indications (except the  indicator) go off.

- When placing the center unit vertically, the moving panel closes.

■ When the resume playback is set to “ON” (see page 62):

If you turn off the power while playing back a disc, playback stops and the position where playback has been stopped is stored.

To resume playback from the stored position, press DVD or PLAY on the remote control. (See below and page 29.)

If you press AUDIO  (or  on the center unit), the stored position is erased.

NOTES:

- The power supply to the subwoofer is linked to the center unit. The POWER ON lamp on the subwoofer lights in green when the power is turned on.
- A small amount of power is consumed even though the power is turned off (called standby mode). Remove the power cord from the AC outlet to turn off the power supply completely.
- You can also turn on the system by pressing  on the center unit or one of the source selecting buttons on the remote control. See below and page 28.
- The resume playback does not work for Audio CDs.

Selecting the source to play

From the remote control: Press one of the source selecting buttons (DVD, FM/AM, and AUX).

DVD: Select the DVD player, and the remote control can be used to operate the DVD player. (See pages 27 and 37.)

FM/AM: Select an FM or AM broadcast, and the remote control can be used to operate the tuner (FM/AM). (See page 31.)

- Each time you press the button, the band alternates between FM and AM.

AUX: Select a component connected to the AUX IN jacks or DIGITAL IN jack. (See page 14.)

- Each time you press the button, the source alternates between “AUX” and “AUX DIGITAL.”

On the center unit: Press SOURCE repeatedly until the source name you want appears on the display.

Each time you press the button, the source changes as follows.

⇒ DVD ⇒ AM ⇒ FM ⇒ AUX ⇒ AUX DIGITAL ⇒ (back to the beginning)

The selected source name appears on the display window.

Example: When “AUX” is selected.

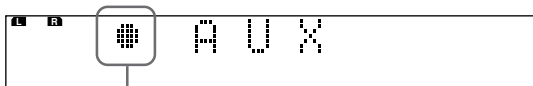

When AM, FM, AUX, or AUX DIGITAL is selected as the source to play, this indication appears if a disc is inserted. (See page 28.)

NOTES:

- When the system is in standby mode, pressing one of the source selecting buttons on the remote control also turns on the system.
- When the resume playback is set to “ON” (see page 62), if you change the source during playback, playback stops and the position where playback has been stopped is stored. Next time you select DVD as the source or if you press PLAY (or  on the center unit) to start playback, playback starts from the stored position (the resume playback).

Adjusting volume

You can adjust the volume level within the range from “0” (minimum) to “70” (maximum).

From the remote controls: Press VOLUME + or –.

On the center unit: Press VOL + or –.

- Press + to increase volume.
- Press – to decrease volume.

The volume level appears on the display window.

CAUTION:

Always set the volume to the minimum before starting any source.

If the volume is set at its high level, the sudden blast of sound energy can permanently damage your hearing and/or ruin your speakers.

Basic operations

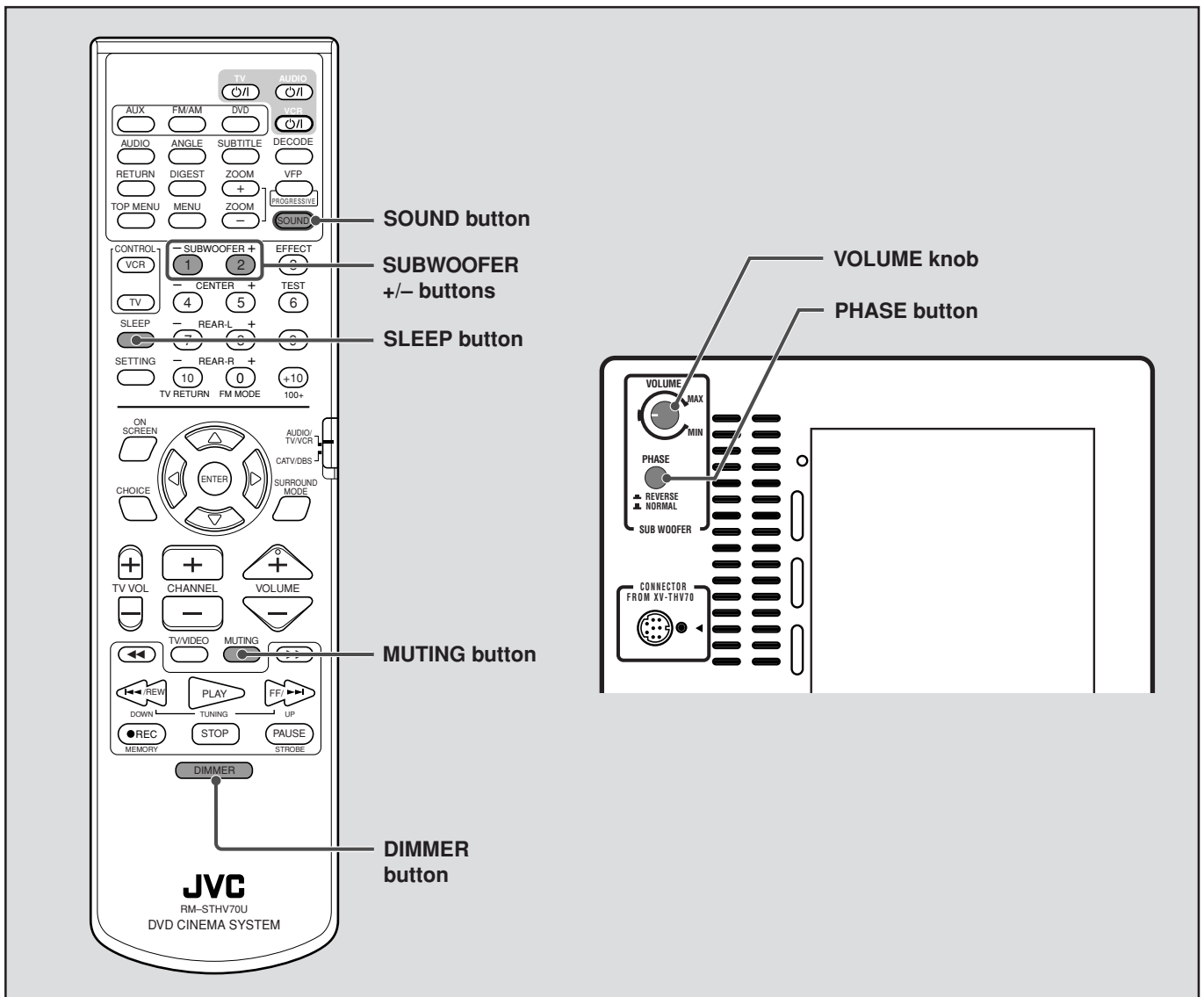

Turning off the sound temporarily

From the remote control **ONLY**:

Press **MUTING**.

"MUTING" appears on the display window and the volume turns off.



To restore the sound

Press **MUTING** again.

- Pressing **VOLUME +/-** (or **VOL +/-** on the center unit) also restores the sound.

Adjusting the brightness

You can dim the indications on the moving panel and the illumination lamps on the center unit.

From the remote control **ONLY**:

Press **DIMMER**.

Each time you press the button, the brightness level of the indications and the illumination lamps changes as follows.

⇒ Dimmer ⇒ The illumination lamps go off ⇒ Normal level ⇒ (back to the beginning)

NOTE:

The indications on the moving panel do not go off.

Turning off the power with the timer

Using the sleep timer, you can fall asleep while listening to music, and know the system will turn off by itself rather than play all night.

From the remote control ONLY:

Press **SLEEP**.

Each time you press the button, the shut-off time changes as follows:

- ⇒ **0min** (cancelled) ⇒ **10min (minutes)** ⇒ **20min** ⇒ **30min** ⇒ **60min** ⇒ **90min** ⇒ **120min** ⇒ **150min**
- ⇒ (back to the beginning)

To check the remaining time until the shut-off time

Press **SLEEP** once.

The remaining time until the shut-off time appears on the display window for a while.

To change the remaining time until the shut-off time

Press **SLEEP** repeatedly.

- Each time you press the button, the shut-off time changes.

To cancel the sleep timer

Press **SLEEP** repeatedly until "0min" appears on the display window.

- Turning off the power also cancels the sleep timer.

NOTES:

- When DVD is selected as the source to play, this system can also turn off automatically if playback is not restarted within the length of time you have specified (the auto standby function). See page 62.
- When both of the sleep timer and auto standby function are activated, if the shut-off time set by the auto standby function comes earlier than the one set by the sleep timer, the auto standby function takes effect.

Setting the subwoofer

■ Volume control

Adjust the volume of the subwoofer when you feel it is too high or low compared with that of the front speakers.

Turn **VOLUME** knob.

- The mark indicates the normal volume position.

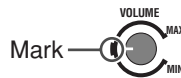

■ Phase setting

Play sound through the subwoofer and adjust the **PHASE** button to the position (◀ REVERSE or ▶ NORMAL) at which the lowest frequency is heard best.

NOTE:

Phase is closely related to the distance from the listening position to the front speakers and subwoofer. While listening, adjust until the lowest frequency is heard best.

■ Adjusting the output level of the subwoofer

You can adjust the output level of subwoofer.

1 Press **SOUND**.

2 Press **SUBWOOFER +/-** to adjust the output level of the subwoofer.

- You can adjust the output level within the range from -10 dB to 10 dB.

NOTES:

- You can also change the output level of the subwoofer through the choice menu shown on the TV screen. See page 61.
- Once you have adjusted the output level of the subwoofer, the adjustment is memorized for each source.

Basic adjustment of auto memory

This unit memorizes sound settings for each source:

- When you turn off the power
- When you change the source

When you change the source, the memorized settings for the newly selected source are automatically recalled.

The following can be stored for each source:

- The adjustment of front speakers—Balance, Bass, and Treble (see pages 59 and 66)
- Speaker output level (see pages 35 to 36, 61, and 66)
- Surround mode selection (see pages 35 to 36)
- Effect level (see page 36)

Note:

If the source is FM or AM, you can assign a different setting for each band.

Basic operations

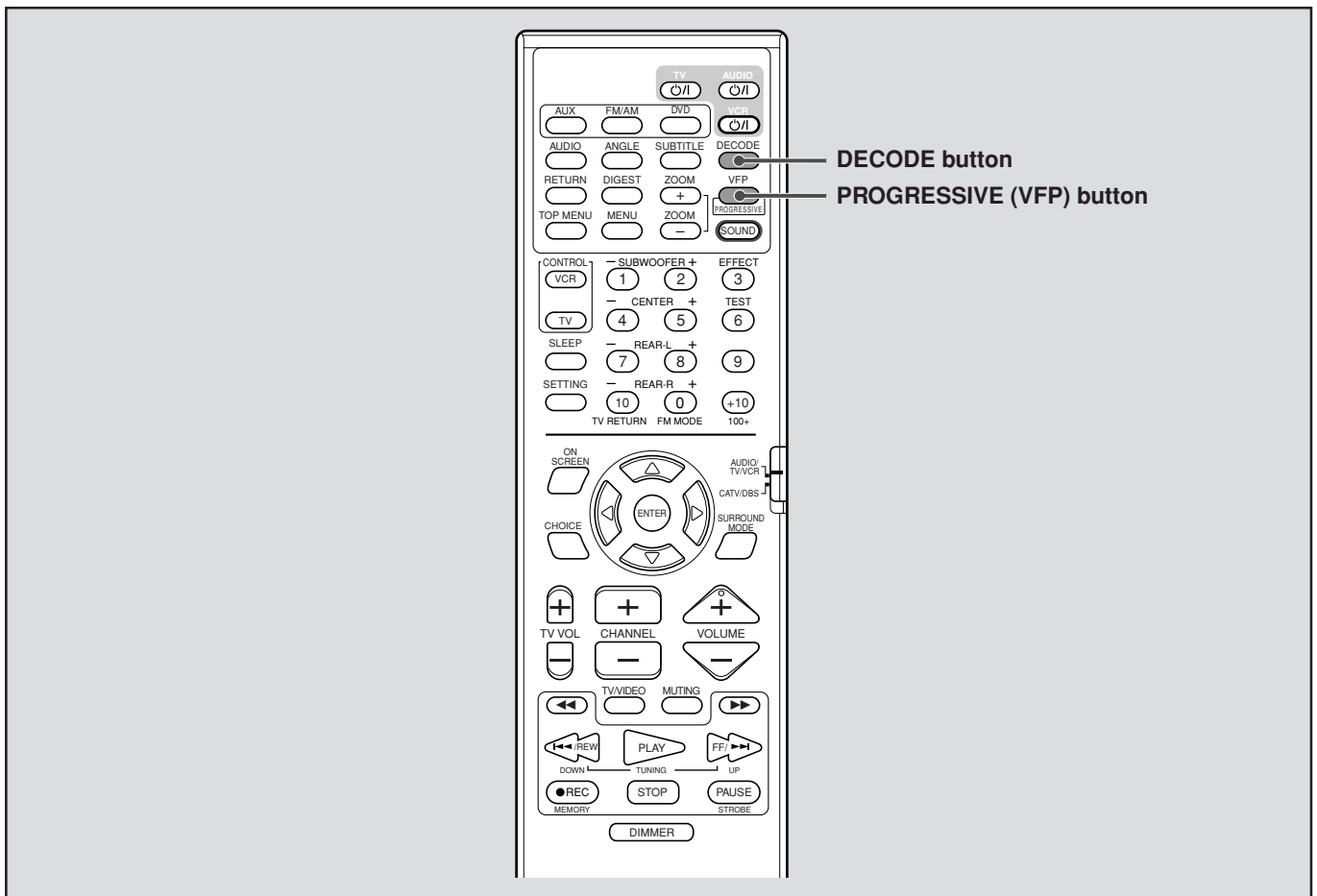

Changing the decode mode

When you play a disc (or software) encoded with Dolby Digital or DTS Digital Surround, the following symptoms may occur:

- Sound does not come out at the beginning of playback.
- Noise comes out while searching for or skipping chapters or tracks.

In these cases, change the decode mode to "DOLBY D" (for Dolby Digital) or "DTS" (for DTS Digital Surround).

From the remote control ONLY:

Press **DECODE** to select the decode mode when DVD or AUX DIGITAL is selected as the source.

The current decode mode appears on the display window.

Example: When "AUTO/PCM" is selected.



Each time you press the button, the decode mode changes as follows.

⇒ **AUTO/PCM** ⇒ **DOLBY D** ⇒ **DTS** ⇒ (back to the beginning)

- **AUTO/PCM:** Normally, select this.
This system automatically detects the incoming signals.
- **DOLBY D:** Select this if the cases above occur when playing a disc (or software) encoded with Dolby Digital.
- **DTS:** Select this if the cases above occur when playing a disc (or software) encoded with DTS Digital Surround.

NOTES:

- When "DOLBY D" or "DTS" is selected, if the signal encoded with another digital format comes in, you cannot listen to the sound. (□□ DIGITAL or **DTS** indicator flashes.)
- Changing the source returns the decode mode to "AUTO/PCM" automatically.

Changing the scan mode

This system supports the progressive scan system (525p*) as well as the conventional interlaced scan system (525i*). If your TV equipped with component jacks supports the progressive video input, you can enjoy a high quality picture by making the progressive scan mode active.

- Refer also to the instruction manuals supplied with your TV.
- If your TV equipped with component jacks does not support the progressive video input, do not change the scan mode to the progressive scan mode.

From the remote control ONLY:

Press and hold PROGRESSIVE (VFP) for 3 seconds.

Each time you perform this operation, the scan mode changes as follows.

INTERLACE ⇄ PROGRESSIVE

- **INTERLACE:** Select this if your TV equipped with component jacks supports the interlaced video input only.
- **PROGRESSIVE:** Select this if your TV equipped with component jacks supports the progressive video input.

The selected scan mode appears on the display window for a while.

NOTES:

- When "PAL" is selected on the VIDEO OUT SELECT switch (see page 10), the scan mode is fixed to "INTERLACE." So the scan mode cannot be changed.
- There are some progressive TVs and High-Definition TVs that are not fully compatible with this system, resulting in the unnatural picture when playing back a DVD in the progressive scan mode.
In such a case, change the scan mode to "INTERLACE."
To check the compatibility of your TV, contact your local JVC customer service center.
- All JVC progressive TVs and High-Definition TVs are fully compatible with this system.

* 525p and 525i indicate the number of scanning lines and scanning format of an image signal.

- 525p indicates 525 scanning lines with progressive format.
- 525i indicates 525 scanning lines with interlaced format.

About scan system

To display video on the TV screen, the conventional scanning method is called "Interlaced scan."

With this method, only half of the horizontal lines are displayed at a time. So two fields complete a single picture (frame); i.e., the first field, containing all the odd-numbered lines, is displayed followed by the second field, containing all the even-numbered lines.

On the other hand, the Progressive scan system scans all horizontal lines at a time, so you can double the number of scanning lines displayed at a time, resulting in a flicker-free, high-density picture.

To enjoy the progressive scanned video, a monitor (or TV or projector) to be connected to the unit must have the Progressive inputs.

Depending on the material source format, DVD VIDEO can be classified into two types; film source and video source (note that some DVD VIDEO contain both film source and video source). Film sources are recorded as 24-frame-per-second information, while (NTSC) video sources are recorded as 30-frame-per-second (60-field-per-second interlaced) information.

When this system plays back a film source material, uninterlaced progressive output signals are created using the original information. When a video source material is played back, the unit interleaves lines between the interlaced lines on each to create the pseudo uninterlaced picture and outputs as the progressive signal.

Basic playback

This section explains basic operations for playback of DVDs, VCDs, SVCDs, and Audio CDs. For MP3 playback, see page 51. For JPEG disc playback, see page 53.

-  shows the types of discs the operation is available for.
- Before operating the DVD player from the remote control, press DVD to use the remote control for the disc operations.
- Turn on your TV and select the correct input mode on the TV.

IMPORTANT:

When using the remote control, check to see if its remote control mode selector is set to the correct position:

To operate this system, set it to "AUDIO/TV/VCR."

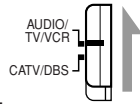











Preventing screen burn-out with the screen saver

A TV screen may be burned out if a static picture is displayed for a long time. To prevent this, the system automatically dims the screen if a static picture is displayed for over 5 minutes (the screen saver function).

- Pressing any button will cancel the screen saver function.
- If you do not want to use the screen saver function, see page 58.

On-screen guide icons

During DVD playback, the following guide icons may appear for a while on the TV screen:

- : appears at the beginning of a scene containing multi-subtitle languages.
- : appears at the beginning of a scene containing multi-audio languages.
- : appears at the beginning of a scene containing multi-angle views.
-  (Play),  (Pause),  /  (Fast forward/backward),  /  (Slow-motion forward/backward): appears when you perform each operation.
- If "" appears on the TV screen when pressing a button, the disc cannot accept an operation you have tried to do, or information required for that operation is not recorded on the disc.

NOTES:

- In some cases, without showing "" operations will not be accepted.
- If you do not want the on-screen guide icons to appear, see page 62.

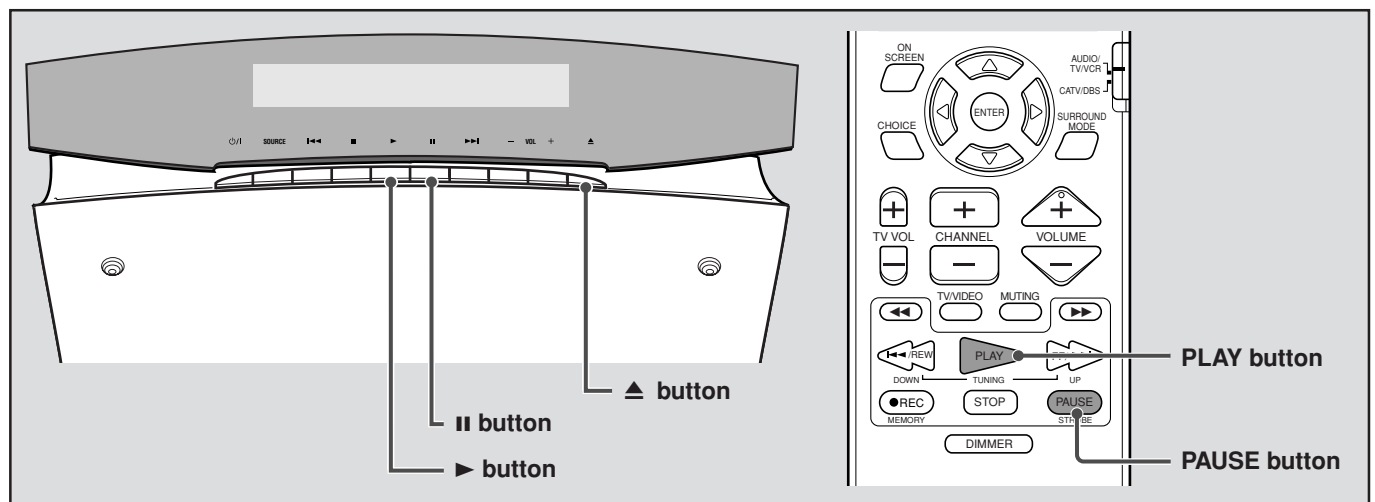

Inserting and removing a disc



IMPORTANT:

DO NOT insert a disc with your finger put in the hole of a disc.

- 1 When the center unit is placed horizontally, press .
The moving panel opens and the disc slot appears.

2 Insert a disc into the disc slot with the label side facing the front or up as shown below.

Insert a disc halfway, then it is pulled into the center unit automatically.

- When the center unit is placed vertically

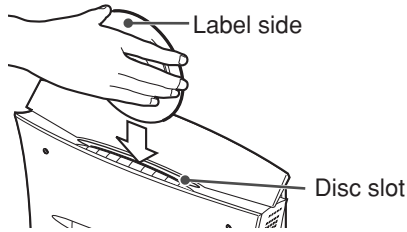

- When the center unit is placed horizontally

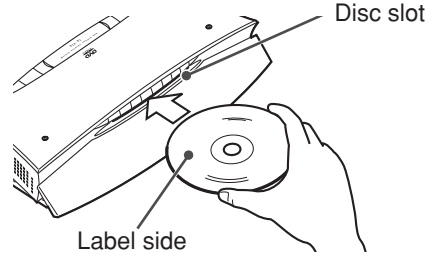

When the center unit is placed horizontally, the moving panel closes after inserting the disc.

After the system reads the disc information, playback starts.

To remove a disc

Press **▲** again. The disc comes out from the disc slot. "EJECT" appears on the display window and on the TV screen.

NOTE: When the center unit is placed vertically

When AM, FM, AUX, or AUX DIGITAL is selected as the source, if the indication as illustrated below appears on the display window, a disc is already inserted. Press **▲** to remove the disc before inserting another disc.

Example: When "AUX" is selected.

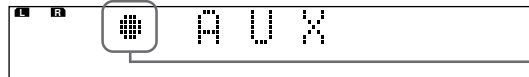

This indication shows that a disc is inserted.

NOTES:

- With Video CDs/SVCDs with PBC function (see page 7), or some DVD Video discs, the menu display may appear on the TV screen after starting playback. In such a case, select an item to be played back from the menu. See page 39.
- When the system is in standby mode, pressing **▲** also turns on the system.
- The stored position for the resume playback is canceled when removing a disc.
- You can check the playback information on the display window and the TV screen (see page 37).

Playback information on the display window

While loading and playing a disc, the current title/chapter/track numbers, time, and status information appear on the display window.

Playing back a DVD:

(EX. When a DVD encoded with Dolby Digital 5.1ch is played)

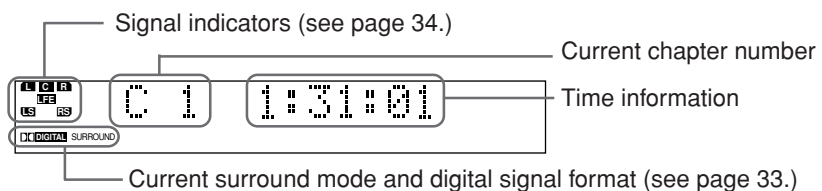

Playing back a VCD/SVCD/ Audio CD:

(EX. When a VCD is played)

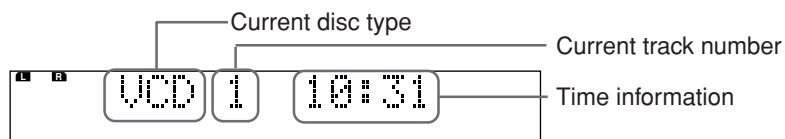

NOTES:

- You can change the time information mode. See page 38.
- You can also check the playback information on the TV screen. See page 37.
- The current disc type information appears as follows:
 - "VCD": shows a VCD or SVCD is loaded.
 - "CD": shows an Audio CD is loaded.
- When a Video CD or SVCD with PBC function is played, the time information does not appear, but "PBC" appears.

Stopping playback temporarily

From the remote control: Press **PAUSE**.

On the center unit: Press **II**.

To return to normal playback,

Press **PLAY** (or **▶** on the center unit).



Basic playback

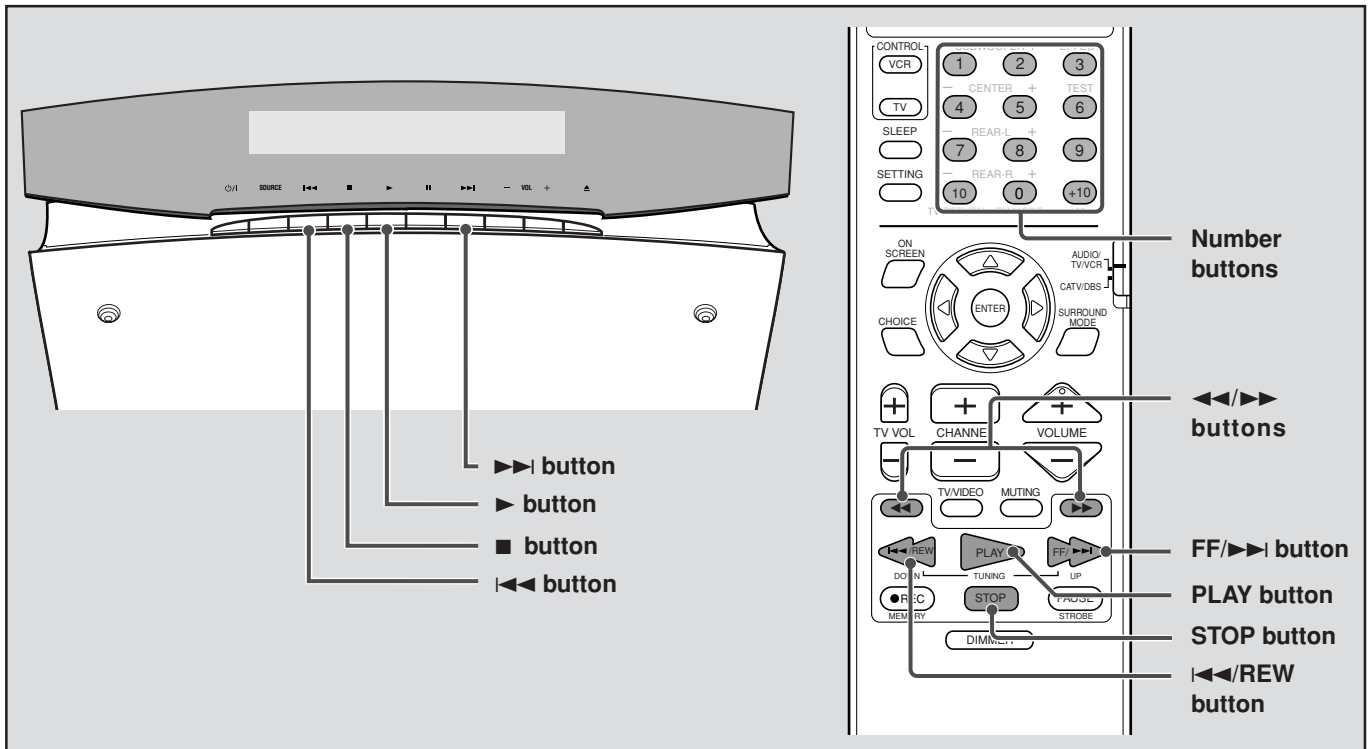

Stopping playback completely



From the remote control: Press STOP.

On the center unit: Press ■.

■ When the resume playback is set to "ON" (see page 62):

Once you press the button, playback stops and the position where playback has been stopped is stored. (The RESUME indicator lights up.)

To clear the stored position, press STOP (or ■ on the center unit) again.

■ Starting playback again

From the remote control: Press PLAY.

On the center unit: Press ▶.

■ When the resume playback is set to "ON" (see page 62):

When the system stored the position where playback has been stopped, playback starts from the stored position (the resume playback). (The RESUME indicator goes off.)

When the stored position has been cleared, playback starts from the beginning of the disc.

NOTE:

The resume playback does not work for Audio CDs.

Moving back the playback position during DVD playback

DVD

During playback of a DVD, you can move back the playback position by 10 seconds from the current position.

From the remote control: Press PLAY during playback of DVD.

On the center unit: Press ▶ during playback of DVD.

The playback position moves back by 10 seconds from the current position.

NOTES:

- This function works between chapters in the same title.
- This function may not work for some DVDs.

Searching for a particular point



You can search for a particular point while playing a disc.

■ Method 1 (from the remote control ONLY):

To fast-forward playback, press **▶▶** during playback.

Each time you press the button, the search speed changes as follows.

⇒ **▶▶ x2** ⇒ **▶▶ x5** ⇒ **▶▶ x10** ⇒ **▶▶ x20** ⇒ **▶▶ x60** *

To fast-reverse playback, press **◀◀** during playback.

Each time you press the button, the search speed changes as follows.

⇒ **◀◀ x2** ⇒ **◀◀ x5** ⇒ **◀◀ x10** ⇒ **◀◀ x20** ⇒ **◀◀ x60** *

* **▶▶ x60** and **◀◀ x60** are available to DVD only.

To return to the normal speed playback

Press PLAY (or **▶** on the center unit).

■ Method 2:

Press and hold **FF/▶▶** or **REW/◀◀** (or **▶▶** or **◀◀** on the center unit).

Continuously pressing **▶▶** or **◀◀** increases the fast-forward/reverse playback speed as follows:

x5 ⇒ **x20**

To return to the normal speed playback, release the button.

NOTES:

- When a DVD, Video CD, or SVCD is played back, no sound comes out during fast-forward/reverse playback.
- This function may not work for some DVDs.

Locating the beginning of a desired chapter or track



You can locate the beginning of a chapter (for DVD Video) or track (for Video CD/Audio CD) by pressing **▶▶** or **◀◀**.

- For DVD: During playback
- For Video CD/SVCD: During playback without PBC function
- For Audio CD: During playback or while stopped

Press **FF/▶▶** or **REW/◀◀** (or **▶▶** or **◀◀** on the center unit).

- To skip chapters or tracks forward, press **▶▶** as many times as required.
- To skip to the beginning of the current chapter or track, press **◀◀** once.
- To skip chapters or tracks backward, press **◀◀** as many times as required.

NOTES:

- This function may not work for some DVDs.
- While playing a VCD or SVCD with the PBC function, **▶▶** and **◀◀** may be used for the operations of menu-driven playback (see pages 7 and 39).

Locating a desired selection using Number buttons



You can locate the desired title, chapter (for DVD Video) or track (for Video CD/SVCD/Audio CD) by selecting its number.

- For DVD: While stopped (the title number is selected.)
During playback (the chapter number is selected.)
- For Audio CD: During playback or while stopped
- For Video CD/SVCD: During playback without PBC function

From the remote control ONLY:

Press **Number buttons (1-10, +10)** to select the desired title, chapter, or track number.

- To select 3, press 3.
- To select 14, press +10 then 4.
- To select 24, press +10, +10, then 4.
- To select 40, press +10, +10, +10 then 10.

The specified title, chapter, or track number appears on the display window, and playback begins from that location.

NOTES:

- While playing a DVD, if a menu is shown on the TV screen, Number buttons may be used for selecting an item in the menu (see page 39).
- While playing a VCD or SVCD with the PBC function, if a menu is shown on the TV screen, Number buttons are used for selecting an item in the menu (see page 39).

Tuner operations

You can browse through all the stations or use the preset function to go immediately to a particular station.

- Before operating the tuner from the remote control, press FM/AM to use the remote control for the tuner operations.

IMPORTANT:

When using the remote control, check to see if its remote control mode selector is set to the correct position:

To operate this system, set it to "AUDIO/TV/VCR."

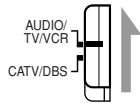

Setting the AM tuner interval spacing

Some countries space AM stations 9 kHz apart, and other countries use 10 kHz spacing.

- 9 kHz interval spacing is the initial setting.

On the center unit ONLY:

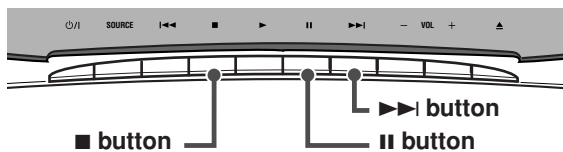

- When AM is selected as the source

To select the 10 kHz interval

Press and hold ■, then press ▶▶. "10k STEP" appears on the display window. Now the 10 kHz interval is selected.

To select the 9 kHz interval

Press and hold ■, then press ||. "9k STEP" appears on the display window. Now the 9 kHz interval is selected.

Tuning in to stations manually

From the remote control ONLY:

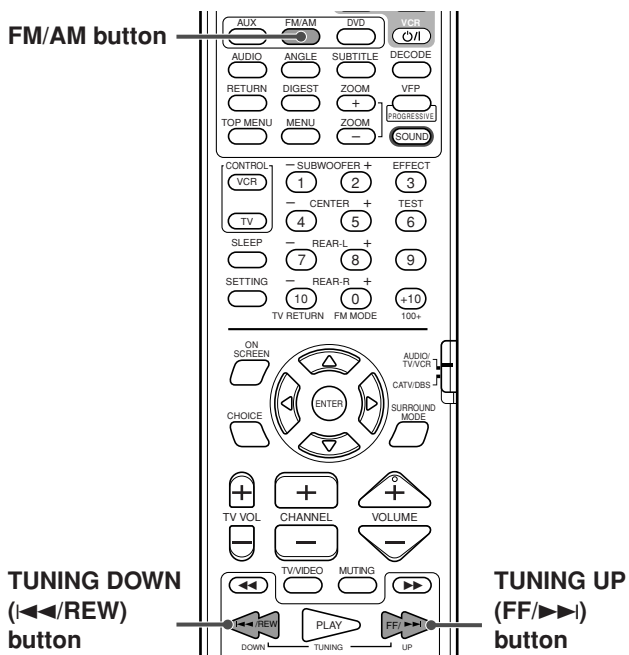

- 1 Press FM/AM repeatedly to select the band.

Each time you press the button, the band alternates between FM and AM.

The selected band appears on the display window, then the last received station appears.

- 2 Press TUNING UP (FF/▶▶) or DOWN (◀◀/REW) repeatedly until you find the frequency you want.

- **TUNING UP (FF/▶▶):** Increases the frequency.
- **TUNING DOWN (◀◀/REW):** Decreases the frequency.

When you hold down the button and then release it, the system starts searching for stations and stops when a station of sufficient signal strength is tuned in to.

NOTES:

- When a station of sufficient signal strength is tuned in, the TUNED indicator lights up on the display window.
- When an FM stereo program is received, the STEREO indicator lights up.

Using preset tuning

Once a station is assigned to a channel number, the station can be quickly tuned in. You can preset 30 FM and 15 AM stations.

■ To store the preset stations

Before you start, remember...

There is a time limit in doing the following steps. If the setting is cancelled before you finish, start from step 2 again.

From the remote control ONLY:

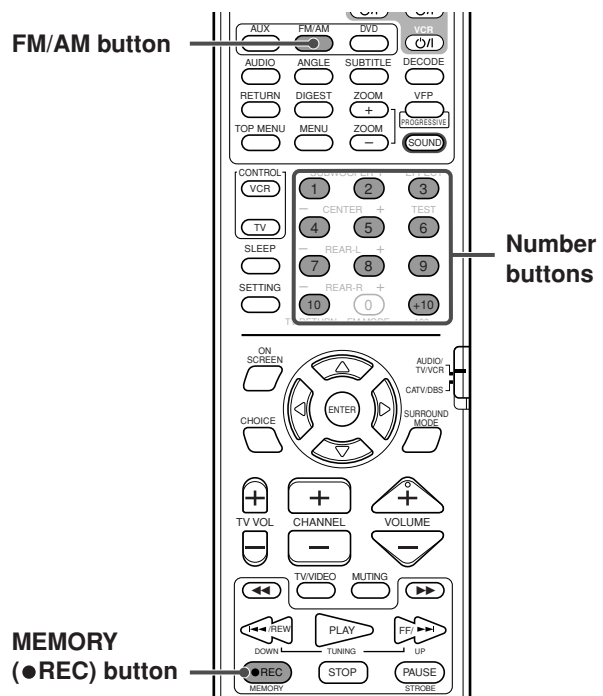

- 1 Tune in the station you want to preset (see "Tuning in to stations manually").

- If you want to store the FM reception mode for an FM station, select the reception mode you want. See "Selecting the FM reception mode" on page 32.



2 Press MEMORY (●REC).

The channel number position starts flashing on the display window for about 5 seconds.



3 Press Number button(s) (1-10, +10) to select a channel number while the channel number position is flashing.

The channel number and the CH indicator start flashing.

Examples:

- For channel number 3, press 3.
- For channel number 14, press +10 then 4.

(For FM stations only)

- For channel number 24, press +10, +10, then 4.
- For channel number 30, press +10, +10, then 10.



4 Press MEMORY (●REC) again while the selected number is flashing on the display window.

The selected number stops flashing.

The station is assigned to the selected preset number.

5 Repeat steps 1 to 4 until you store all the stations you want.

To erase a stored preset station

Storing a new station on a used number erases the previously stored one.

■ To tune in to a preset station

From the remote control ONLY:

1 Press FM/AM repeatedly to select the band.

Each time you press the button, the band alternates between FM and AM.

2 Press Number button(s) (1-10, +10) to select a preset channel number.

Examples:

- For channel number 3, press 3.
- For channel number 14, press +10 then 4.

(For FM stations only)

- For channel number 24, press +10, +10, then 4.
- For channel number 30, press +10, +10, then 10.

Selecting the FM reception mode

When a stereo FM program tuned in currently is noisy, you can change the FM reception mode to improve the reception.

- You can store the FM reception mode for each preset station. See "Using preset tuning" on page 31.

From the remote control ONLY:

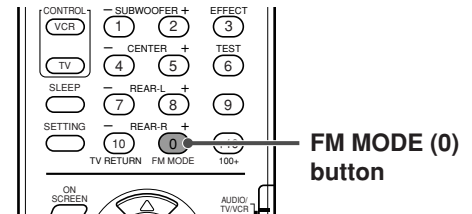

Press FM MODE (0) while listening to an FM station.

The FM reception mode appears on the display window. Each time you press the button, the FM reception mode alternates between "AUTO MUTING" and "MONO."

• AUTO MUTING:

When a program is broadcasted in stereo, you will hear stereo sounds. (The STEREO indicator lights up on the display window.) When in monaural, you will hear monaural sounds. This mode is also useful to suppress static noise between stations. The AUTO MUTING indicator lights up on the display window.

• MONO:

Reception will be improved although you will lose the stereo effect. (The STEREO indicator goes off.) In this mode, you will hear noise until you are tuned in to a station. (The AUTO MUTING indicator also goes off.)

Reducing the noise of AM broadcast

When listening to an AM broadcast with a lot of noise interference, you can change the Beat Cut mode to reduce the noise.

From the remote control ONLY:

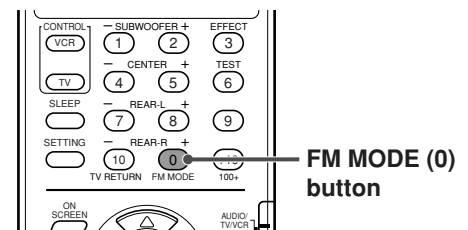

Press FM MODE (0) while listening to an AM station.

The current BEAT CUT mode appears on the display window. Each time you press the button, the Beat Cut mode alternates between "BEAT CUT 1" and "BEAT CUT 2."

- Choose "BEAT CUT 1" or "BEAT CUT 2" that will give clearer sound.

Creating the realistic sound fields

You can use the following Surround modes to reproduce a realistic sound field.

- **Dolby Surround**
 - **Dolby Pro Logic II**
 - **Dolby Digital**
- **DTS Digital Surround**
- **DAP modes**
- **All Channel Stereo**

■ **Dolby Surround** **Dolby Pro Logic II***

Dolby Pro Logic II has newly developed multichannel playback format to decode all 2 channel sources—stereo source and Dolby Surround encoded source—into 5.1 channel.

Matrix-based encoding/decoding method for Dolby Pro Logic II makes no limitation for the cutoff frequency of the rear treble and enables stereo rear sound compared to conventional Dolby Pro Logic.

Dolby Pro Logic II enables to reproduce spacious sound from original sound without adding any new sounds and tonal colorations.

Dolby Pro Logic II has two modes—**Movie mode** and **Music mode**:

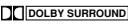
Pro Logic II Movie (PL II MOVIE)—suitable for reproduction of Dolby Surround encoded sources bearing the mark . You can enjoy soundfield very close to the one created with discrete 5.1 channel sounds.

Pro Logic II Music (PL II MUSIC)—suitable for reproduction of any 2 channel stereo music sources. You can enjoy wide and deep sound by using this mode.

- When Dolby Pro Logic II is activated, the  PRO LOGIC II indicator lights up on the display window.

■ **Digital signal format indicators on the display window**

 **DIGITAL** : Lights up when Dolby Digital signals come in.

 : Lights up when DTS Digital (Surround) signals come in.

No indication: No digital signal indicator lights up when Linear PCM signals or analog signals come in.

NOTE: MPEG Multichannel

MPEG Multichannel signals are converted into Linear PCM signals, then reproduced.

Dolby Digital*

Used to reproduce multichannel soundtracks of the software encoded with Dolby Digital ().

Dolby Digital 5.1 ch (DOLBY D) encoding method (so-called discrete multichannel digital audio format) records and digitally compresses the left front channel, right front channel, center channel, left rear channel, right rear channel, and LFE channel signals.

Since each channel is completely independent from the other channel signals to avoid interference, you can obtain much better sound quality with much stereo and surround effects.

NOTE:

Dolby Digital software can be roughly grouped into two categories—multichannel (up to “5.1” channel) and 2 channel software. To enjoy surround sounds while playing Dolby Digital 2 ch software, you can use Dolby Pro Logic II.

■ **DTS Digital Surround****

Used to reproduce multichannel soundtracks of the software encoded with DTS Digital Surround ().

DTS Digital Surround (DTS SURR) is another discrete multichannel digital audio format available on CD, LD, and DVD software.

Compared to Dolby Digital, audio compression ratio is relatively low. This fact allows DTS Digital Surround format to add breadth and depth to the reproduced sounds. As a result, DTS Digital Surround features natural, solid and clear sound.

Typical Multichannel (5.1 ch) reproduction

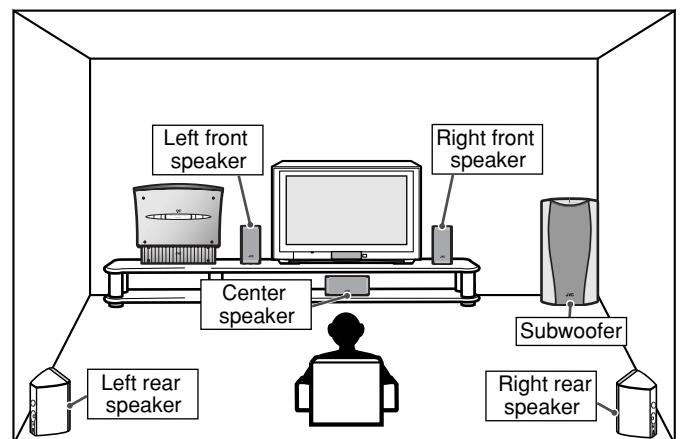

* Manufactured under license from Dolby Laboratories. “Dolby,” “Pro Logic,” and the double-D symbol are trademarks of Dolby Laboratories.

** Manufactured under license from Digital Theater Systems, Inc. US Pat. No. 5,451,942 and other world-wide patents issued and pending. “DTS” and “DTS Digital Surround” are trademarks of Digital Theater Systems, Inc. Copyright 1996 Digital Theater Systems, Inc. All rights reserved.

■ DAP (Digital Acoustic Processor) modes

DAP modes have been designed to create important acoustic surround elements.

The sound heard in a live club, dance club, hall or pavilion consists of direct sound and indirect sound—early reflections and reflections from behind. Direct sounds reach the listener directly without any reflection. On the other hand, indirect sounds are delayed by the distances of the ceiling and walls (see the diagram below).

These indirect sounds are important elements of the acoustic surround effects. The DAP mode can reproduce a realistic sound field by adding these indirect sounds.

The following DAP modes are provided with this system.

LIVE CLUB:	Gives the feeling of a live music club with a low ceiling.
DANCE CLUB:	Gives a throbbing bass beat.
HALL:	Gives clear vocal and the feeling of a concert hall.
PAVILION:	Gives the spacious feeling of a pavilion with a high ceiling.

These DAP modes can be used to add the acoustic surround effects while reproducing 2 channel stereo software, either analog or Linear PCM, and can give you a real “being there” feeling.

- When one of the DAP modes is selected, the DSP indicator lights up on the display window.

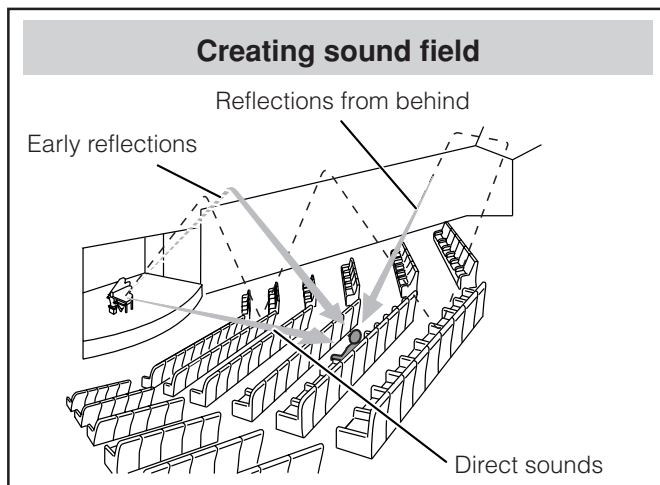

■ All Channel Stereo

All Channel Stereo (ALL CH ST.) mode can reproduce a larger stereo sound field using all the connected (and activated) speakers.

All Channel Stereo can be used while reproducing 2 channel stereo software, either analog or Linear PCM.

- When All Channel Stereo is selected, the DSP indicator lights up on the display.

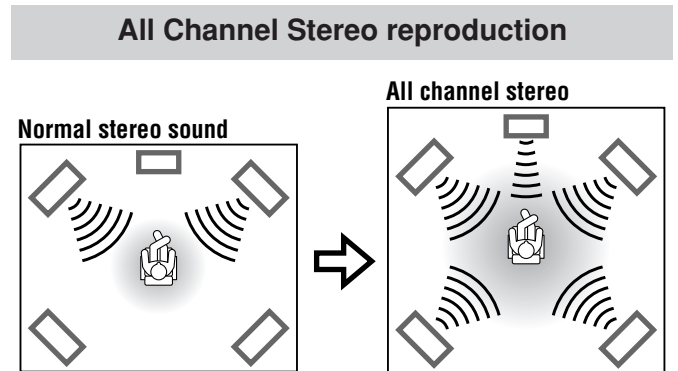

■ The signal indicators on the display window

Light up to indicate the incoming signals.

L C R
LFE
LS S RS

- L:** Lights up when the left channel signal comes in.
- C:** Lights up when the center channel signal comes in.
- R:** Lights up when the right channel signal comes in.
- LFE:** Lights up when the LFE channel signal comes in.
- LS:** Lights up when the left surround channel signal comes in.
- RS:** Lights up when the right surround channel signal comes in.
- S:** Lights up when the monaural rear channel signal or 2 channel Dolby Surround signal comes in.

Available Surround modes for each input signal

○: Possible / ×: Impossible

Mode \ Signals	SURROUND OFF (stereo)	DOLBY DIGITAL	DTS SURROUND	PLII MOVIE	PLII MUSIC	LIVE CLUB	DANCE CLUB	HALL	PAVILION	ALL CH ST.
Dolby Digital (Multichannel)	○	○	×	×	×	×	×	×	×	×
Dolby Digital (2 channel)	○	×	×	○	○	×	×	×	×	×
DTS Digital Surround (Multichannel)	○	×	○	×	×	×	×	×	×	×
DTS Digital Surround (2 channel)	○	×	×	○	○	×	×	×	×	×
Analog (AUX/FM/AM) or Linear PCM	○	×	×	○	○	○	○	○	○	○

Creating the realistic sound fields

IMPORTANT:

When using the remote control, check to see if its remote control mode selector is set to the correct position:

To operate this system, set it to "AUDIO/TV/VCR."

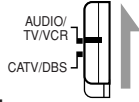

Selecting the surround mode

The system is so set up in its initial state that it automatically selects the optimal surround mode for each input signal (AUTO SURROUND MODE).

Only when you want to change a surround mode selected automatically, perform the following procedure.

- After having changed the surround mode, turning off the power or changing sources resumes the auto surround mode.

From the remote control ONLY:

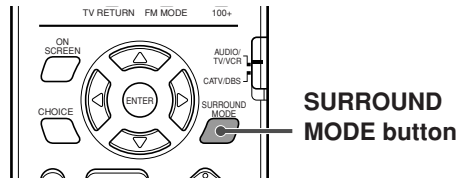

Press SURROUND MODE.

The current surround mode is called up and appears on the display window.

Each time you press the button, the surround mode changes as follows.

- ⇒ PL II MOVIE ⇒ PL II MUSIC ⇒ LIVE CLUB
- ⇒ DANCE CLUB ⇒ HALL ⇒ PAVILION
- ⇒ ALL CH ST. ⇒ STEREO (surround off)
- ⇒ (back to the beginning)

NOTES:

- When you have set the rear speakers to "NONE," you cannot use the DAP modes and All Channel Stereo. (See pages 60 and 66.)
- When the digital multichannel software such as Dolby Digital or DTS Digital Surround is played back, the appropriate multichannel Surround mode is automatically activated ("DOLBY D" or "DTS SURR"), and you can only turn on or off ("STEREO") the surround mode.
- For Dolby Digital 2 channel software, you can select "PLII MUSIC," "PLII MOVIE," or off ("STEREO") by pressing SURROUND MODE.

Using Dolby Pro Logic II, Dolby Digital and DTS Digital Surround

Once you have adjusted the sound, the adjustment is memorized for each source.

From the remote control ONLY:

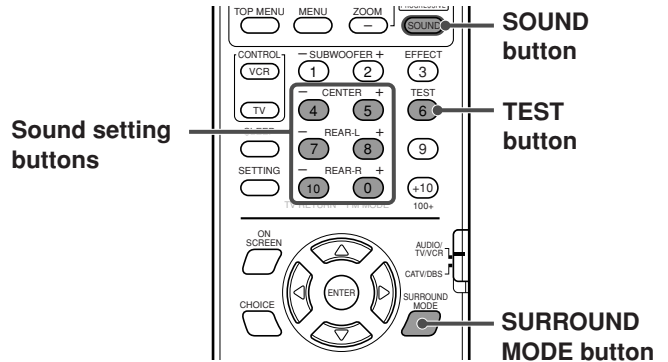

1 Start playing back software.

When playing a component connected to the AUX IN or the DIGITAL IN jack, change the source to AUX or AUX DIGITAL. (See page 22.)

2 Press SURROUND MODE to activate Surround mode.

Each time you press the button, Surround mode turns on and off (stereo) alternately.

- If you are playing back software encoded with Dolby Digital multichannel, "DOLBY D" is selected.
- If you are playing back software encoded with DTS Digital Surround, "DTS SURR" is selected.
- If you are playing back any software other than the above, you can select "PL II MUSIC" or "PL II MOVIE" according to the source by pressing SURROUND MODE.

If you like to adjust sound, go to step 3.

3 Press SOUND.

The 10 keys are activated for sound adjustments.

4 Press TEST to check if you can hear the sounds through all the speakers at the equal level.

"TEST TONE L" and the corresponding signal indicator starts flashing on the display window, and the test tone comes out of the speakers in the following order:

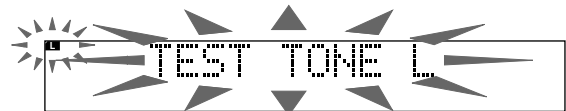

- ⇒ Left front speaker ⇒ Center speaker ⇒ Right front speaker ⇒ Right rear speaker ⇒ Left rear speaker
- ⇒ (back to the beginning)

5 Adjust the speaker output levels (-10 dB to +10 dB).

Adjust the center speaker and rear speaker levels comparing to the sound from the front speakers.

- To adjust the center speaker level, press CENTER +/-.
- To adjust the left rear speaker level, press REAR-L +/-.
- To adjust the right rear speaker level, press REAR-R +/-.

6 Press TEST again to stop the test tone.

NOTES:

- When selecting "PL II MUSIC," "PL II MOVIE," "DOLBY D," or "DTS SURR" as the surround mode, the SURROUND indicator lights up.
- You can adjust the speaker output levels without outputting the test tone.
- When selecting DVD, AUX, or AUX DIGITAL as the source, you can also adjust the speaker output levels using the choice menu. See pages 55 and 61.
- When you have set the center speaker and rear speakers to "NONE," the test tone does not come out from those speakers, and you cannot adjust the output level of those speakers. (See pages 60 and 66.)
- You can output the test tone in any surround mode, or even when surround mode is not activated.

Using DAP Modes and All Channel Stereo

Once you have adjusted the sound, the adjustment is memorized for each source.

- You cannot use the DAP modes and All Channel Stereo if the rear speakers are deactivated.
- You cannot adjust the effect level for "ALL CH ST."

From the remote control ONLY:

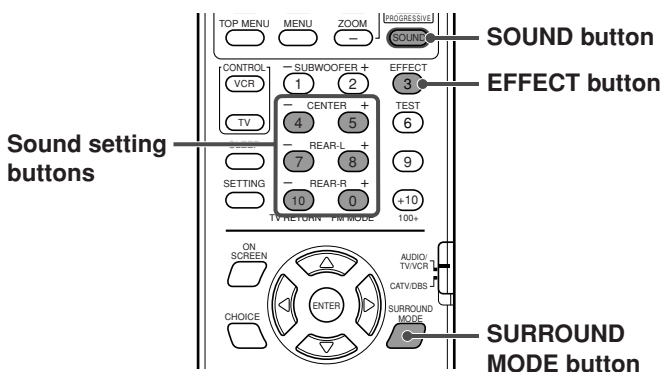

1 Start playing 2 channel software—either analog or Linear PCM.

When playing a component connected to the AUX IN or the DIGITAL IN jack, change the source to AUX or AUX DIGITAL.

2 Press SURROUND MODE repeatedly until one of the DAP modes—"LIVE CLUB," "DANCE CLUB," "HALL," "PAVILION"—or "ALL CH ST." appears on the display.

The DSP indicator also lights up on the display window.

If you like to adjust sound, go to step 3.

3 Press SOUND.

The 10 keys are activated for sound adjustments.

4 Adjust the speakers output levels (-10 dB to +10 dB).

- To adjust the left rear speaker level, press REAR-L +/-.
- To adjust the right rear speaker level, press REAR-R +/-.

For "ALL CH ST." only:

- To adjust the center speaker level, press CENTER +/-.

5 For DAP modes only: Press EFFECT to select the effect level (1 to 5) you want.

Each time you press the button, the effect level changes as follows:

⇒ DSP EFFECT 1 ⇒ DSP EFFECT 2 ⇒ DSP EFFECT 3
⇒ DSP EFFECT 4 ⇒ DSP EFFECT 5 ⇒ (back to the beginning)



As the number increases, the selected mode becomes stronger (normally, set it to "EFFECT 3").

NOTES:

- When selecting DVD, AUX, or AUX DIGITAL as the source, you can also adjust the speaker output level using the choice menu. See pages 55 and 61.
- You cannot select any DAP mode and All Channel Stereo when software encoded with Dolby Digital or DTS Digital Surround is played back.

Advanced operations

This section explains advanced operations of DVD, Video CD, SVCD, and Audio CD playback using the remote control. For MP3 playback, see page 51, and for JPEG playback, see page 53.

-  shows the types of discs the operation is available for.
- Before operating the DVD player from the remote control, press DVD to use the remote control for the disc operations.
- Turn on your TV, and select the correct input mode on the TV.
- If “” appears on the TV screen when pressing a button, the disc cannot accept an operation you have tried to do, or information required for that operation is not recorded on the disc.

IMPORTANT:

When using the remote control, check to see if its remote control mode selector is set to the correct position:

To operate this system, set it to “AUDIO/TV/VCR.”

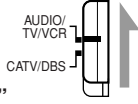

Using the on-screen bar

You can check the information of a disc while the disc is loaded, and you can use some functions through the on-screen bar.

Showing the on-screen bar

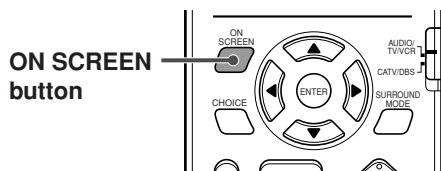

- Whenever a disc is loaded

Press ON SCREEN.

Each time you press the button, the on-screen bar appears on the TV.

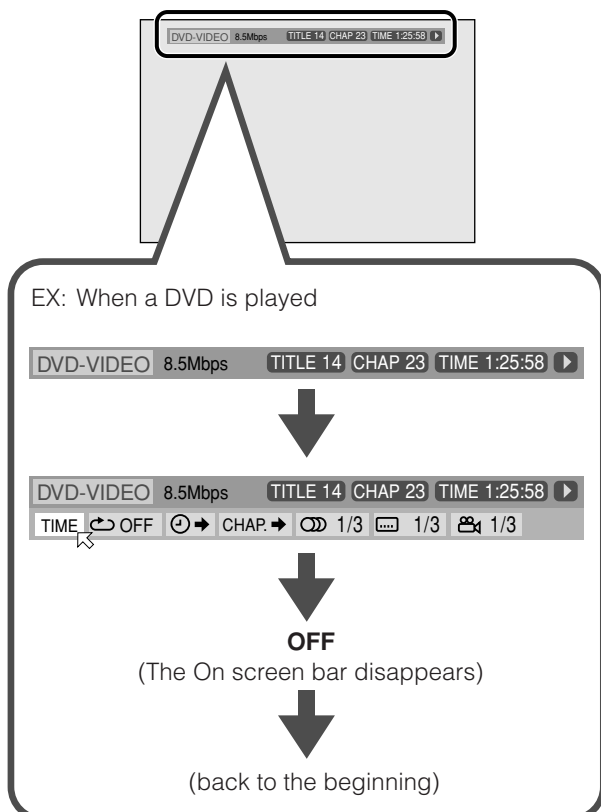

Contents of the on-screen bar

- When a DVD is played

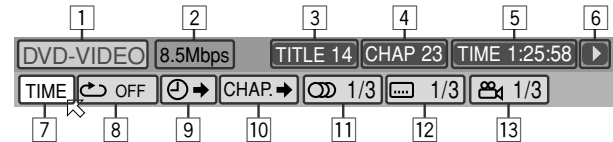

- When an SVCD is played

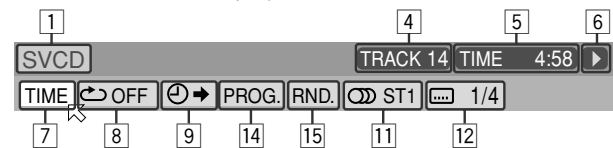

- When a VCD is played

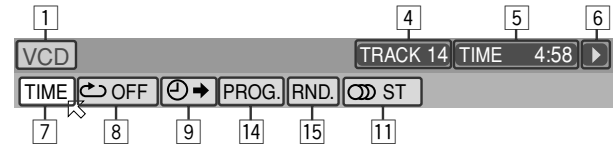

- When a CD is played

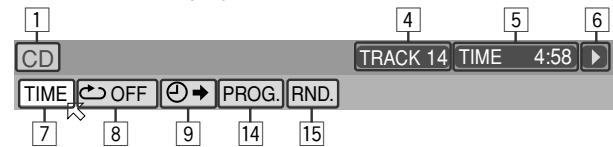

- 1: shows a disc type.
- 2: shows the current transfer rate (Megabits per second).
- 3: shows the current title number.
- 4: shows the current chapter number (for DVD) or track number (for Video/Audio CD and SVCD).
- 5: shows the time information. See page 38.
- 6: shows the playback condition.
 - ▶: appears during playback.
 - ▶▶/◀◀: appears during fast forward/reverse.
 - ▶▶/◀◀: appears during playback in forward slow-motion/reverse slow-motion.
 - ⏸: appears while paused.
 - ⏹: appears while stopped.
- 7: Select this to change the time information (5). See page 38.
- 8: Select this to repeat playback. See page 50.
- 9: Select this for the time search function. See page 45.
- 10: Select this for the chapter search function. See page 44.
- 11: Select this to change the audio language or channel. See pages 43 and 44.
- 12: Select this to change the subtitle language. See page 42.
- 13: Select this to change the view angle. See page 40.

- 14: Select this to play back tracks in your desired order. See page 49.
- 15: Select this to play back tracks in random order. See page 49.

Basic operation through the on-screen bar

EX.: When selecting the repeat mode:

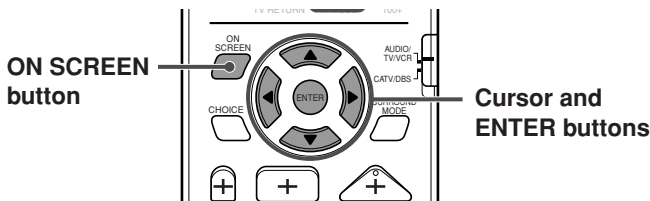

■ During playback or while stopped.

1 Press ON SCREEN twice.

The on-screen bar appears on the TV.



2 Press Cursor ▶/◀ to move to the icon you want to use, then press ENTER.

The pop-up window appears under the on-screen bar.



- The current setting appears in the pop-up window.

3 Press Cursor ▼/▲ to select the desired option.

Each time you press the button, the options change.



4 Press ENTER.

The setting changes and the pop-up window goes off.



To turn off the on-screen bar

Press ON SCREEN.

NOTE:

See the corresponding pages for the detail of each function.

Changing the time information



You can change the time information in the on-screen bar and the display window on the center unit.

■ During playback or while stopped.

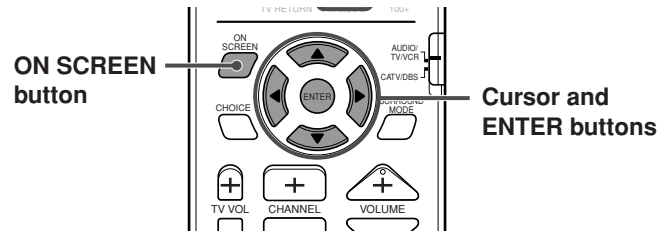

1 Press ON SCREEN twice.

The on-screen bar appears on the TV.

2 Press Cursor ▶/◀ to move to the icon you want to use, then press ENTER.

3 Press ENTER.

Each time you press the button, the time information changes as follows.

⇒ TIME ⇒ REM ⇒ TOTAL ⇒ T.REM
⇒ (back to the beginning)

- **TIME:** Elapsed playing time of the current chapter/track
- **REM:** Remaining time of the current chapter/track
- **TOTAL:** Elapsed time of the disc
- **T.REM:** Remaining time of the disc

To turn off the on-screen bar

Press ON SCREEN.

NOTES:

- The time indication in the on-screen bar changes as follows.

EX.:

⇒ TIME 0:25:58 ⇒ REM 0:18:14 ⇒ TOTAL 1:25:58

⇒ T.REM 0:45:41 ⇒ (back to the beginning)

- While playing a Video CD, SVCD, or Audio CD, the indication of the hour digit does not appear.

Advanced operations

Locating a desired scene from the disc menu

Using the disc menu, you can start playing a title, chapter, or track you specify.

Locating a desired scene from the DVD menu

DVD

DVD discs generally have their own menus which show the disc contents. These menus contain various items such as titles of movies, names of songs, or artist information, and display them on the TV screen. You can locate a desired scene by using these menus.

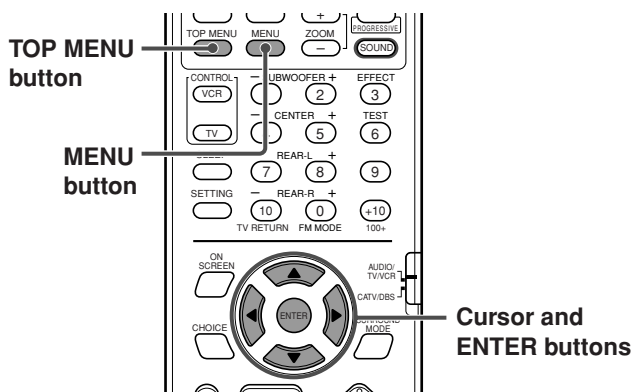

- Whenever a DVD disc is loaded
- Press **TOP MENU** or **MENU**.
The menu appears on the TV.

Example:

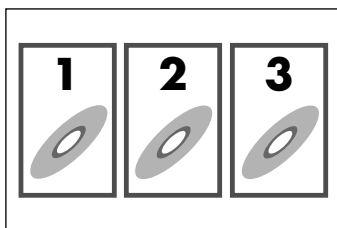

Normally, a DVD disc which contains more than one title may have a "title" menu which lists the titles. Press **TOP MENU** to show the title menu. Some DVD discs may also have a different menu which is shown by pressing the **MENU** button. See the instructions of each DVD disc for its particular menu.

- Use **Cursor** $\leftarrow/\rightarrow/\uparrow/\downarrow$ to select a desired item, then press **ENTER**.

The system starts playback of the selected item.

- With some discs, you can also select items by entering the corresponding number using **Number** buttons.

Locating a desired scene from the Video CD/SVCD menu with PBC

VIDEO CD SUPER VCD

A Video CD or SVCD disc recorded with PBC has its own menus such as a list of the songs. You can locate the specific scene by using the menu. (See also page 7.)

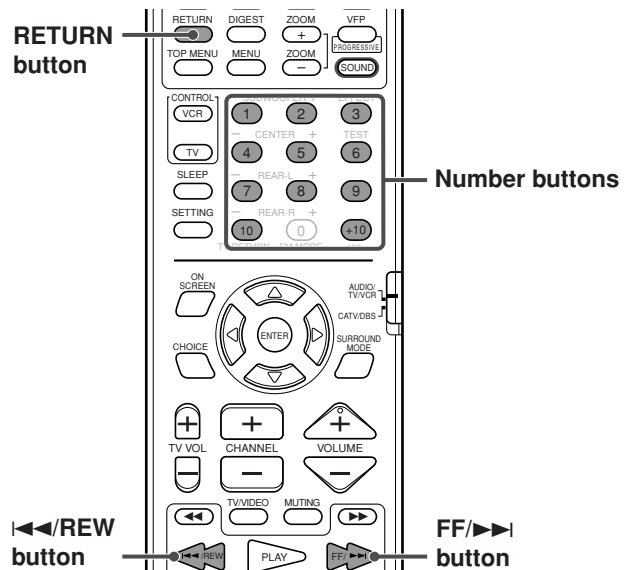

- When the menu appears on the TV during playback with PBC

Press **Number** buttons (1-10, +10) to select the number of the desired item.

The system starts playback from the selected item.

Example:

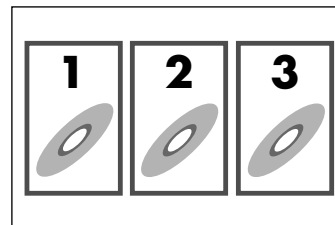

To select the number

Example: To select 3, press 3.
To select 11, press +10, then 1.

To return to the menu

Press **RETURN**.

When "NEXT" or "PREVIOUS" is shown on the TV screen:

- To go to the next page, press **FF/▶▶**.
- To return to the previous page, press **◀◀/REW**.

NOTES:

- If you want to play a PBC-compatible Video CD/SVCD without using the PBC function, perform any of the following:
 - Start playback by pressing **Number** buttons when playback is stopped.
 - Start playback by pressing **PLAY** (or \blacktriangleright on the center unit) when playback is stopped and the track number appears on the display window instead of "PBC."
- To activate the PBC function when playing a PBC-compatible Video CD/SVCD without using the PBC function, perform any of the following:
 - Press **TOP MENU** or **MENU**.
 - Press **STOP** (or \blacksquare on the center unit) to stop playback, then press **PLAY** (or \blacktriangleright on the center unit).

Selecting a view angle of DVD

While playing back a DVD containing multi-view angles, you can enjoy the same scene at different angles.

Selecting a view angle

DVD

Using the direct button:

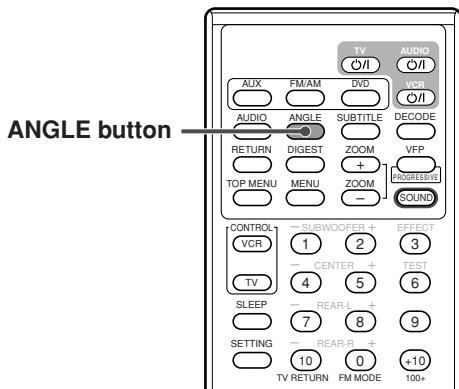

■ During playback

1 Press ANGLE.

The following pop-up window appears on the TV.

Example: The first view angle is selected out of 3 view angles recorded.

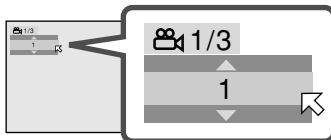

2 Press ANGLE repeatedly to select the desired view angle.

Each time you press the button, the angle of the scene changes.

Example:

⇒ 1/3 ⇒ 2/3 ⇒ 3/3 ⇒ (back to the beginning)

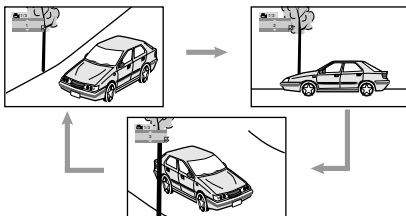

The pop-up window goes off if no operation is done for about 5 seconds.

Using the on-screen bar:

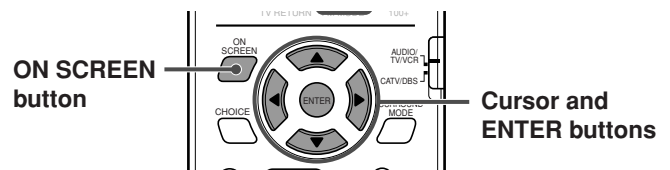

■ During playback

1 Press ON SCREEN twice.

The on-screen bar appears on the TV.

2 Press Cursor ►/◀ to move to the camera icon in the on-screen bar, then press ENTER.

The following pop-up window appears under the on-screen bar.

Example: The first view angle is selected out of 3 view angles recorded.



3 Press Cursor ▼/▲ repeatedly to select the desired view angle.

Each time you press the button, the angle of the scene changes.

4 Press ENTER.

The pop-up window goes off.

To turn off the on-screen bar

Press ON SCREEN.

Advanced operations

Showing all view angles on the TV

DVD

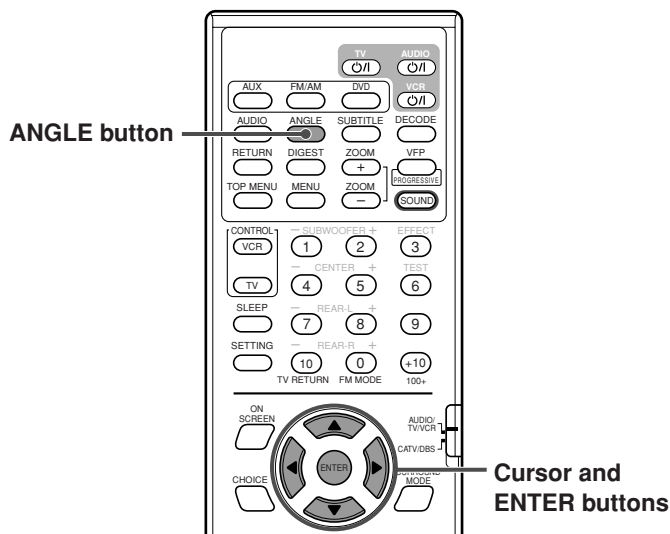

■ During playback

- 1 Press and hold **ANGLE** for more than 1 second.

Up to 9 pictures of the different camera angles recorded on a disc appear on the TV screen.

Example: when 3 view angles are recorded.

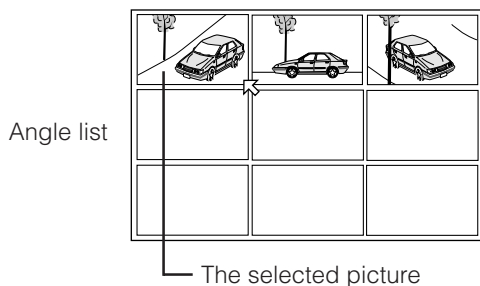

- 2 Press **Cursor** $\leftarrow/\rightarrow/\uparrow/\downarrow$ repeatedly to move \leftarrow to the desired view.
- 3 Press **ENTER**.
The angle list goes off, and playback starts at the selected view angle.

NOTE:

While the angle list is shown on the TV, you cannot listen to the sound.

Changing the subtitle languages and audio languages

While playing back a DVD (or SVCD) containing subtitles in different languages, you can select the subtitle language to be displayed on the TV.

When a DVD contains audio languages (soundtrack), you can select the language (soundtrack) to listen to.

- You can also select the audio channel(s) of a Video CD/ SVCD disc.

Selecting the subtitle language

DVD SUPER VCD

Using the direct button:

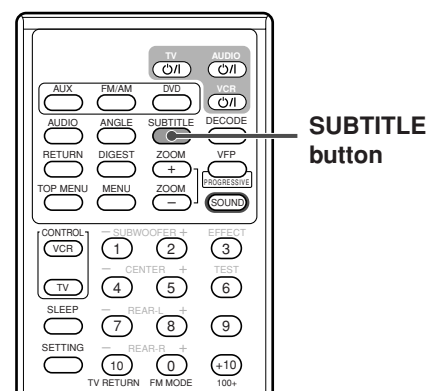

■ During playback

- 1 Press **SUBTITLE**.

The following pop-up window appears on the TV.

Example (DVD): "ENGLISH" is selected out of 3 subtitle languages recorded.

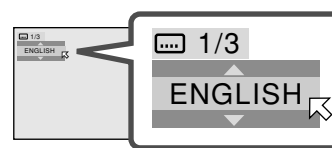

- 2 Press **SUBTITLE** repeatedly to select the desired subtitle language.

Each time you press the button, the subtitle languages change.

For SVCD

- An SVCD can contain up to four subtitles. Pressing **SUBTITLE** changes the subtitles regardless of whether the subtitles are recorded or not. (Subtitles will not change if no subtitle is recorded.)

The pop-up window goes off if no operation is done for about 5 seconds.

NOTE:

Some subtitle languages are abbreviated in the pop-up window. See "The language codes list" on page 57.

Using the on-screen bar:

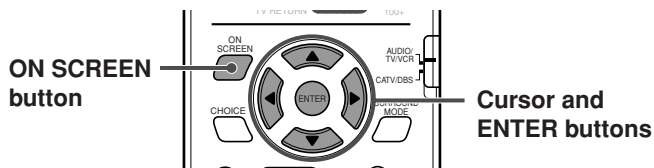

■ During playback

1 Press ON SCREEN twice.

The on-screen bar appears on the TV screen.

2 Press Cursor ►/◄ to move to in the on-screen bar, then press ENTER.

The following pop-up window appears under the on-screen bar.

Example (DVD): "ENGLISH" is selected out of 3 subtitle languages recorded.



3 Press Cursor ▼/▲ repeatedly to select the desired subtitle language.

Each time you press the button, the subtitle languages change.

4 Press ENTER.

The pop-up window goes off.

To turn off the on-screen bar

Press ON SCREEN.

Selecting the audio language

DVD

Using the direct button:

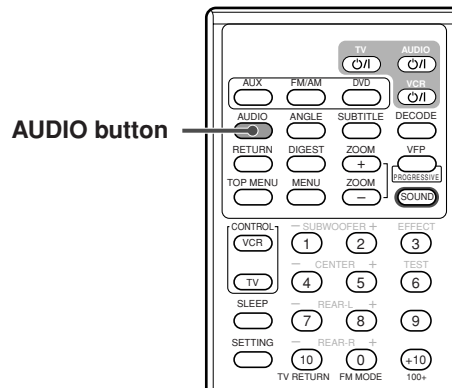

■ During playback

1 Press AUDIO.

The following pop-up window appears on the TV.

Example: "ENGLISH" is selected out of 3 audio languages recorded.

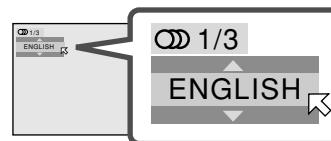

2 Press AUDIO repeatedly to select the desired audio language.

Each time you press the button, the audio languages change.

The pop-up window goes off if no operation is done for about 5 seconds.

NOTE:

Some audio languages are abbreviated in the pop-up window. See "The language codes list" on page 57.

Advanced operations

Using the on-screen bar:

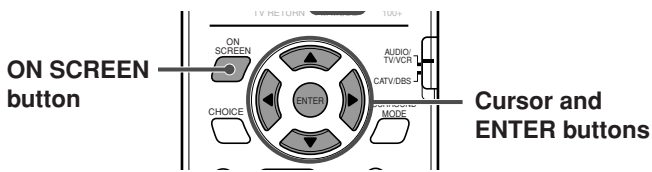

■ During playback

1 Press ON SCREEN twice.

The on-screen bar appears on the TV.

2 Press Cursor ►/◄ to move to in the on-screen bar, then press ENTER.

The following pop-up window appears under the on screen bar.

Example: "ENGLISH" is selected out of 3 audio languages recorded.



3 Press Cursor ▼/▲ to select the desired audio language.

Each time you press the button, the audio languages change.

4 Press ENTER.

The pop-up window goes off.

To turn off the on-screen bar

Press ON SCREEN.

NOTE:

Some audio languages are abbreviated in the pop-up window. See "The language codes list" on page 57.

Selecting the audio channel



When you play some Karaoke Video CDs or SVCDs, you can enjoy karaoke by selecting the audio channel to play.

- The sounds of each audio channel depends on the contents of the disc.

Using the direct button:

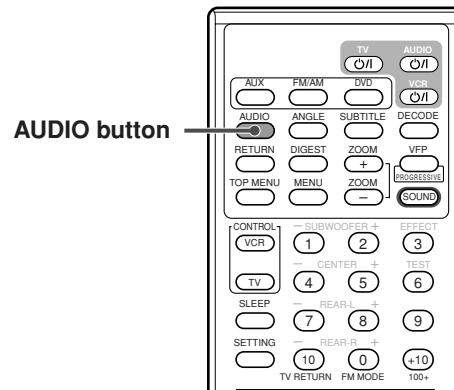

■ During playback

1 Press AUDIO.

The following pop-up window appears on the TV.

Example: "ST" (stereo) is selected out of 3 audio channels recorded.

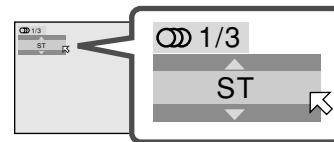

2 Press AUDIO repeatedly to select the desired audio channel.

Each time you press the button, the audio channels change.

Example for VCD:

⇒ ST ⇒ L ⇒ R ⇒ (back to the beginning)

- **ST:** To listen to normal stereo playback.
- **L:** To listen to the L (left) audio channel.
- **R:** To listen to the R (right) audio channel.

Example for SVCD:

⇒ ST 1 ⇒ ST 2 ⇒ L 1 ⇒ R 1 ⇒ L 2 ⇒ R 2

⇒ (back to the beginning)

- **ST 1/ST 2:** To listen to normal stereo playback of ST 1 or 2 channel.
- **L 1/L 2:** To listen to the L (left) 1 or 2 audio channel.
- **R 1/R 2:** To listen to the R (right) 1 or 2 audio channel.

The pop-up window goes off if no operation is done for about 5 seconds.

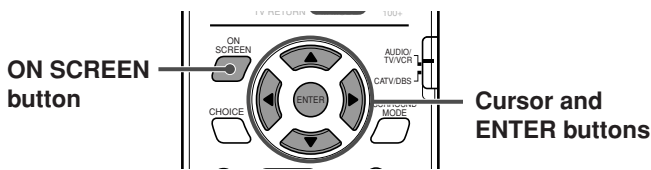

Using the on-screen bar:



■ During playback

- 1 Press ON SCREEN twice.

The on-screen bar appears on the TV.

- 2 Press Cursor ►/◄ to move  to  in the on-screen bar, then press ENTER.

The following pop-up window appears under the on-screen bar.

Example: "ST" (stereo) is selected out of 3 audio channels recorded.

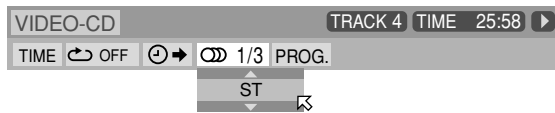

- 3 Press Cursor ▼/▲ to select the desired audio channel(s).

Each time you press the button, the audio channels change.

- 4 Press ENTER.

The pop-up window goes off.

To turn off the on-screen bar

Press ON SCREEN.

Playing from a specified position on a disc

You can start playing a title, chapter, or track you specify. You can also play a disc from the specified time.

Locating a desired chapter from the on-screen bar

DVD

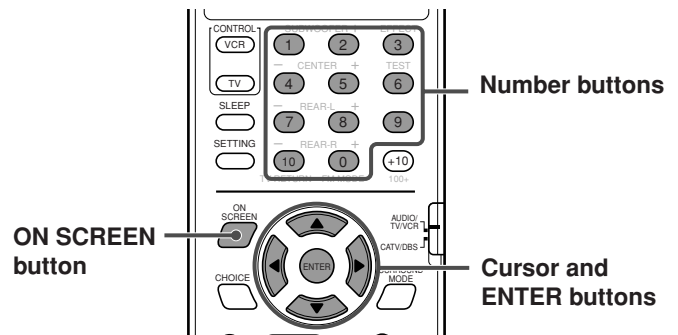

When playing back a DVD disc, you can locate the chapter number to be played from the on-screen bar.



■ During playback

- 1 Press ON SCREEN twice.

The on-screen bar appears on the TV.

- 2 Press Cursor ►/◄ to move  to  in the on-screen bar, then press ENTER.

The following pop-up window appears under the on-screen bar.

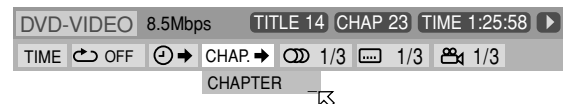

- 3 Press Number buttons (0-10) to enter the desired chapter number.

Example:

To select chapter number 8: Press 8.

To select chapter number 10: Press 10.

To select chapter number 37: Press 3 then 7.

To correct a mis-entry

Repeat step 3 until the correct number appears in the pop-up window.

- 4 Press ENTER.

The system starts playback from the selected chapter.

To turn off the on-screen bar

Press ON SCREEN.

NOTES:

- The +10 button is not used in this function.
- You can select up to the 99th chapter.

Advanced operations

Locating a desired position by specifying the time



You can start playing at your desired position by specifying the elapsed playing time from the beginning of the current title (for DVD Video), or from the beginning of the disc (for Video CD/SVCD/Audio CD).

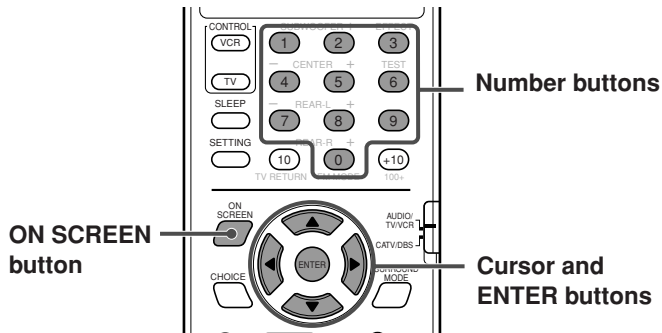

- For DVD: During playback
- For Video CD/SVCD: While stopped or during playback without PBC function.
- For Audio CD: During playback or while stopped

1 Press ON SCREEN twice.

The on-screen bar appears on the TV.

2 Press Cursor ►/◄ to move to in the on-screen bar, then press ENTER.

The following pop-up window appears under the on-screen bar.



3 Use Number buttons (0-9) to enter the time.

Example:

To play back from a point 2 (hours): 34 (minutes): 08 (seconds) elapsed



To correct a mis-entry

Press Cursor ◀ repeatedly until the wrong number is erased, then press Number buttons to enter the correct number.

4 Press ENTER.

The system starts playback from the specified time.

To turn off the on-screen bar

Press ON SCREEN.

NOTES:

- You can also use the 10 button to enter "0."
- The +10 button is not used in this function.
- You can specify the time in hours/minutes/seconds for DVD, and in minutes/seconds for Video CD/SVCD/Audio CD.

Locating a desired scene from the digest display



The system can display the opening scene of each title or chapter on a DVD or each track of a Video CD/SVCD. You can select a desired title or track from the opening scenes shown on the TV screen.

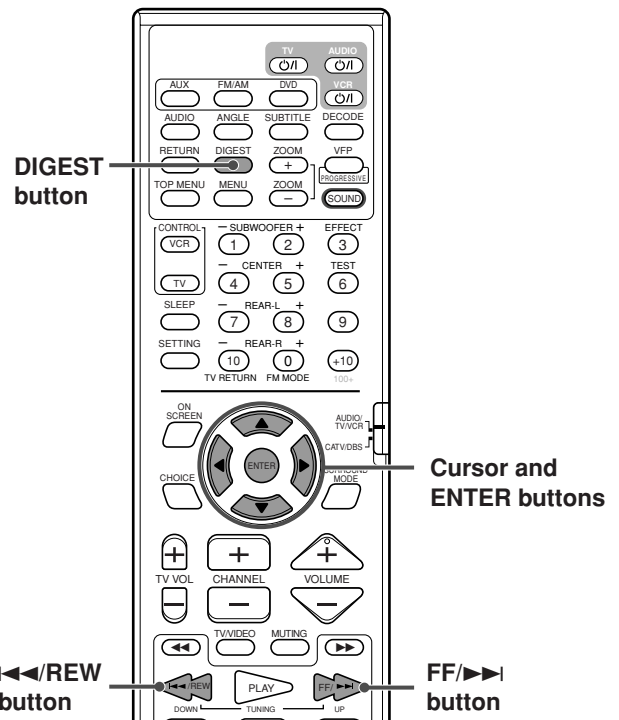

- For DVD: While stopped or during playback
- For Video CD/SVCD: While stopped or during playback without PBC function.

1 Press DIGEST.

Up to 9 opening scenes are displayed.

This scene is selected.



- **While a DVD is stopped:**

The opening scene of each title appears on the TV screen .

- **During DVD playback:**

The opening scene of each chapter in the current title appears on the TV screen.

- **When a Video CD or SVCD is loaded:**

The opening scene of each track appears on the TV screen.

2 Press Cursor ◀/▶/▲/▼ to move to the desired scene.

- If there are more than 9 scenes, the digest screen will have more than one page.

To show other pages of the digest screen

Press ▶▶, to display the next page.

Press ◀◀, to display the previous page.

OR

To display the previous page, press Cursor ◀/▶/▲/▼ to select the left top scene, then press Cursor ◀.

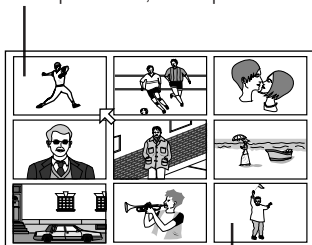

To display the next page, press Cursor ◀/▶/▲/▼ to select the right bottom scene, then press Cursor ▶.

3 Press ENTER.

The system starts playback from the selected scene.

NOTE:

With some discs, depending on the contents, it may take some time before all the scenes appear on the TV screen.

Special picture playback

This system provides special picture playback functions including frame-by-frame, strobe, slow-motion and zoom.

Frame-by-frame playback

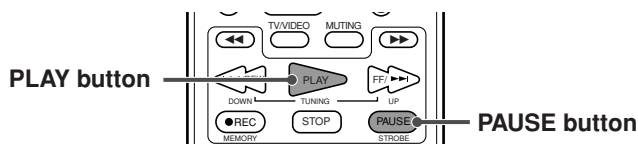

■ During playback

Press PAUSE repeatedly.

Each time you press the button, the still picture advances to the next frame.

To return to normal playback

Press PLAY (or ▶ on the center unit).

NOTE:

You can perform the above operation using  on the center unit.

Showing continuous still pictures

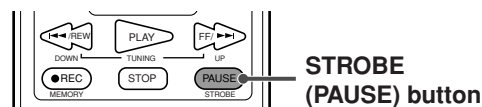

■ During playback

1 Press STROBE (PAUSE) at the point you want to view as continuous pictures.

Playback pauses.

2 Press and hold STROBE (PAUSE) for more than 1 second.

The same 9 frames (still pictures) appear on the TV screen.

You can advance the frames one by one in the following step.

3 Press STROBE (PAUSE) once.

The picture in the middle on the top row shows an advanced frame from the one on the left.



Advanced frame

Each press of STROBE (PAUSE) advances the frame one by one.

Pressing PLAY instead of STROBE (PAUSE) advances each frame in normal playback speed with a time delay over the whole 9 frames. (The sound is muted.)

TO BE CONTINUED ON THE NEXT PAGE

Advanced operations

To return to the normal screen

Press and hold STROBE (PAUSE) for more than 1 second.

NOTES:

- If you press and hold STROBE (PAUSE) for more than 1 second during playback, 9 still pictures also appear but they advance in normal playback speed with a time delay. (The sound is muted.)
- You can perform the above operation using **II** on the center unit.

Playing back in slow-motion

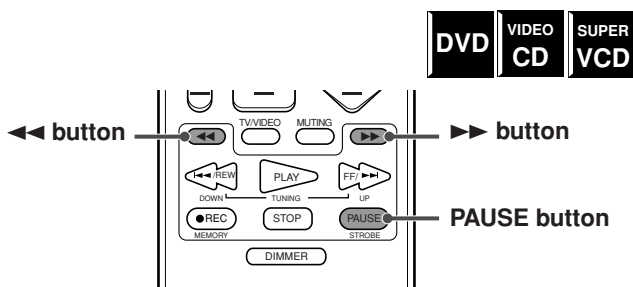

■ During playback

- 1 Press PAUSE at the point where you want to start playback in slow-motion.

The system pauses playback.

- 2 Press **▶▶** or **◀◀**.

- To play back in forward slow-motion, press **▶▶**.
- To play back in reverse slow-motion, press **◀◀**.

Each time you press the button, the playback speed changes as follows.

Forward:

▶▶ 1/32 ⇒ **▶▶ 1/16** ⇒ **▶▶ 1/8** ⇒ **▶▶ 1/4**
 ⇒ **▶▶ 1/2**

Reverse:

◀◀ 1/32 ⇒ **◀◀ 1/16** ⇒ **◀◀ 1/8** ⇒ **◀◀ 1/4**
 ⇒ **◀◀ 1/2**

To pause slow-motion playback

Press PAUSE.

To return to normal playback

Press PLAY.

NOTES:

- You cannot listen to the sound during slow-motion playback.
- Reverse slow-motion playback is not possible for Video CDs and SVCDs.

Zooming in/out

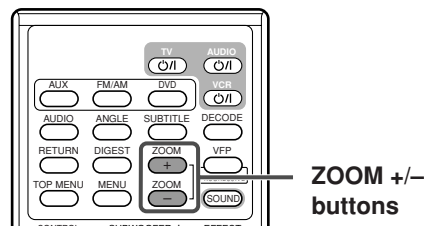

■ During playback or while paused

- 1 Press ZOOM + or -.

- To zooms in, press ZOOM +. Each time you press ZOOM +, the magnification changes as follows.

x 2 ⇒ **x 4** ⇒ **x 8** ⇒ **x 16** ⇒ **x 32** ⇒ **x 64** ⇒ **x 128**
 ⇒ **x 256** ⇒ **x 512** ⇒ **x 1024**

- To zooms out, press ZOOM -. Each time you press ZOOM -, the magnification changes as follows.

x 1/2 ⇒ **x 1/4** ⇒ **x 1/8**

Example: when x4 zoom is selected.

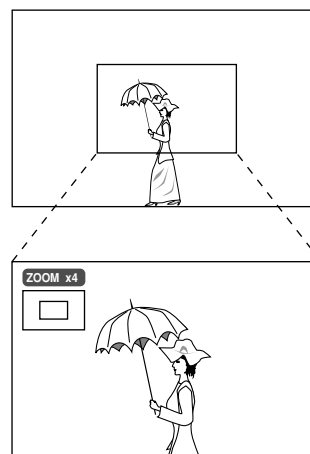

While zoomed in, the current magnification and the zoomed-in position of the scene appears at the left top of the screen. (While zoomed out, only the current magnification appears.)

- 2 While zoomed in, press Cursor **◀/▶/▲/▼** to move the zoomed-in position.

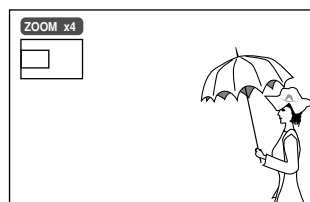

To return to normal playback

Press ENTER.

NOTES:

- While zoomed in, the picture may look coarse.
- While zoomed out, Cursor **◀/▶/▲/▼** do not work.

Changing the VFP setting



The VFP (Video Fine Processor) function enables you to adjust the picture character according to the type of programming, picture tone or personal preferences.

Before you start, remember...

There is a time limit in doing the following steps. If the setting is canceled before you finish, start from step 1 again.

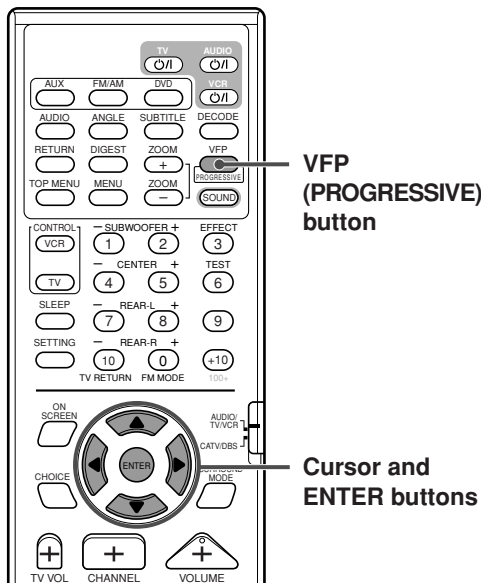

During playback

1 Press VFP (PROGRESSIVE).

The current VFP settings appear on the TV.

Example: When "NORMAL" is selected.

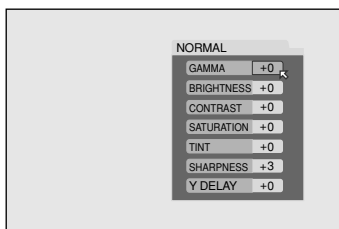

2 Press Cursor ►/◀ repeatedly to select the VFP mode.

Each time you press the button, the VFP mode changes as follows.

⇄ **NORMAL** ⇄ **CINEMA** ⇄ **USER 1** ⇄ **USER 2**
⇄ (back to the beginning)

- **NORMAL:** Normally, select this.
- **CINEMA:** Suitable for a movie source.
- **USER 1 and USER 2:** You can adjust parameters that affect the appearance of picture and store the settings.

NOTE:

You cannot adjust "NORMAL" and "CINEMA."

To adjust USER 1 or USER 2

- 1 Press VFP (PROGRESSIVE), then press Cursor ►/◀ repeatedly to select "USER 1" or "USER 2."

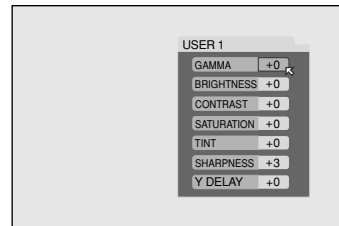

- 2 Press Cursor ▼/▲ repeatedly to select a parameter you want to adjust.

- Adjust gradually to show preferable appearance by confirming the picture.
- **GAMMA:** Controls the brightness of neutral tints while maintaining the brightness of dark and bright portions (-4 to +4).
- **BRIGHTNESS:** Controls the brightness of the screen (-16 to +16).
- **CONTRAST:** Controls the contrast of the screen (-16 to +16).
- **SATURATION:** Controls the color depth of the screen (-16 to +16).
- **TINT:** Controls the tint of the screen (-16 to +16).
- **SHARPNESS:** Controls the sharpness of the screen (+0 to +3).
- **Y DELAY:** Controls the color gap of the screen (-2 to +2).

- 3 Press ENTER.

VFP menu disappears, and the following pop-up window appears on the TV.

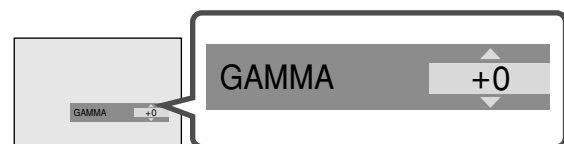

- 4 Press Cursor ▲/▼ repeatedly to change the setting.

- 5 Press ENTER.

The current VFP settings appear again.

- 6 Repeat steps 2-5 to adjust other parameters.

To return to the normal screen

Press VFP (PROGRESSIVE).

To activate your setting

Press VFP (PROGRESSIVE), then press Cursor ►/◀ repeatedly to select "USER 1" or "USER 2."

NOTE:

The VFP settings disappear if no operations are done for more than about 10 seconds.

Advanced operations

Changing the track order

You can play tracks on a Video CD, SVCD or Audio CD in the desired order or in random order.

Playing back in the desired order



You can play up to 99 tracks in desired order.

- You may program the same tracks more than once.

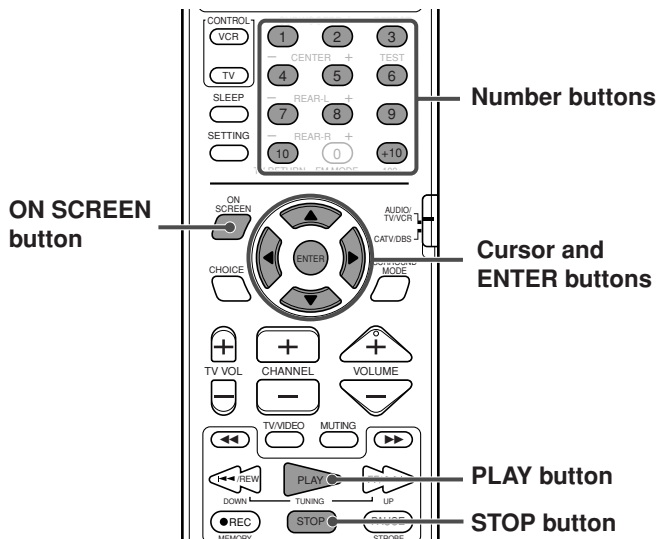

■ While stopped

- 1 Press ON SCREEN twice.

The on-screen bar appears on the TV.

- 2 Press Cursor ►/◄ to move to **PROG.** in the on-screen bar, then press ENTER.

The program menu appears on the TV.

- 10 steps appear at a time.

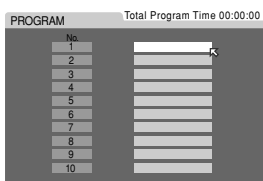

- 3 Press Number buttons (1-10, +10) to enter a track number you want to program.

Examples:

To select 3, press 3.

To select 14, press +10 then 4.

To select 40, press +10, +10, +10 then 10.

- The total program time is shown on the top of the program menu.

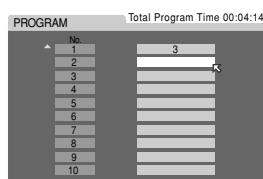

- 4 Repeat step 3 to program the next steps.

- Each time you enter a track number in the step at the bottom of the program menu, the next steps appear.

To erase a step

Press Cursor ▲/▼ to move to the desired step, then press STOP.

To program the next steps again, press Cursor ▼ repeatedly to move to the blank step, then repeat step 3.

- 5 Press PLAY.

When playing a VCD or SVCD, the program menu goes off. Playback starts in the programmed order.

To stop the program playback

Press STOP.

When playing a VCD or SVCD, the program menu resumes.

- To edit your program, repeat steps 3 and 4.

To clear all steps and quit the program playback

When the program playback is stopped, press ON SCREEN to turn off the program menu (the on-screen bar appears), then press STOP.

All steps are cleared and the system quits the program playback.

The total program time indication on the display window returns to normal indication.

To turn off the on-screen bar

Press ON SCREEN.

NOTE:

When all of the programmed tracks have been played, the program playback stops.

Playing back tracks in random order

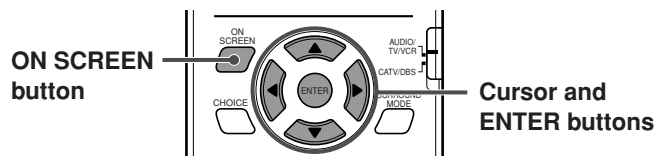

■ While stopped

- 1 Press ON SCREEN twice.

The on-screen bar appears on the TV.

- 2 Press Cursor ►/◄ to move to **RND.** in the on-screen bar, then press ENTER.

Playback starts in random order.

To turn off the on-screen bar

Press ON SCREEN.

To quit random playback

Press STOP. Playback stops and random playback mode is canceled.

NOTES:

- When all tracks have been played once, random play ends.
- The same track will not be played more than once during random play.
- During the random playback, you can skip back to the beginning of the current track by pressing ◀◀/REW, but cannot skip back to the tracks that have been played.
- During the random playback, pressing ENTER when **RND.** in the on-screen bar is selected quits random playback mode and continues playback in the normal order.

Repeat playback

You can repeat playback of the current title or chapter (for DVD Video) or track (for Video CD/SVCD/Audio CD). You can also repeat playback of a desired part.

Repeating a current title, chapter, or all tracks

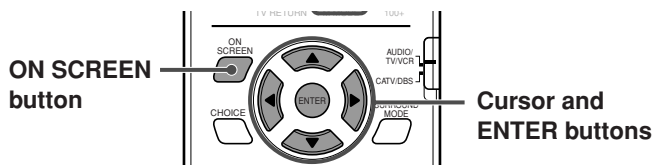

- For DVD/Audio CD: During playback or while stopped
- For Video CD/SVCD: During playback or while stopped without PBC function

- 1 Press ON SCREEN twice.
The on-screen bar appears on the TV.
- 2 Press Cursor ▶/◀ to move to in the on-screen bar, then press ENTER.

The following pop-up window appears under the on-screen bar.



- 3 Press Cursor ▼/▲ repeatedly to select the repeat mode.

- You can select the repeat modes as follows.

■ For DVD

⇐ CHAPTER ⇐ TITLE ⇐ A-B ⇐ OFF

⇐ (back to the beginning)

■ For Video CD/SVCD/Audio CD

⇐ TRACK ⇐ ALL ⇐ A-B ⇐ OFF

⇐ (back to the beginning)

- **CHAPTER:** The current chapter is played repeatedly.
- **TITLE:** The current title is played repeatedly.
- **TRACK:** The current track is played repeatedly.
- **ALL:** The all tracks of the disc (or of the program) are played repeatedly.
- **A-B:** The selected portion is played repeatedly.
- **OFF:** Select this to cancel the repeat mode.

NOTES:

- If you select "ALL" during random playback, the all tracks of the disc are played repeatedly in random order.
- "A-B" cannot be selected during the program and random playback.
- "A-B" cannot be selected while stopped.

- 4 Press ENTER.

To turn off the on-screen bar

Press ON SCREEN.

To cancel the repeat playback

Repeat from step 1, select "OFF" in step 3, then press ENTER.

Repeating a desired part



You can repeat playback of a desired part by specifying the beginning (point A) and the ending (point B).

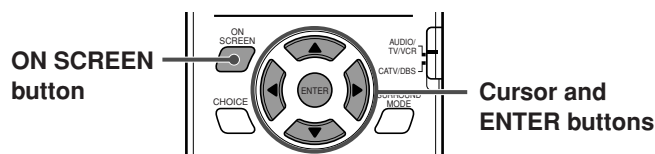

- During playback

- 1 Press ON SCREEN twice.
The on-screen bar appears on the TV.
- 2 Press Cursor ▶/◀ to move to in the on-screen bar, then press ENTER.

The following pop-up window appears under the on-screen bar.



- 3 Press Cursor ▼/▲ repeatedly to select "A-B."
- 4 Press ENTER at the beginning of the part you want to repeat (point A).

The following display appears in the on-screen bar.



- 5 Press ENTER at the end of the part you want to repeat (point B).

A-B repeat playback starts. The selected part of the disc (between point A and B) is played repeatedly.



To turn off the on-screen bar

Press ON SCREEN.

To cancel the A-B repeat playback

Repeat from step 1, select "OFF" in step 3, then press ENTER.

NOTE:

While playing back a DVD disc, A-B repeat playback is possible only within the same title.

MP3 disc playback

This system can play MP3 files recorded on a CD-R or CD-RW (MP3 disc).

- Before performing the operation in this section from the remote control, press DVD to use the remote control for the MP3 disc operations.
- Turn on your TV, and select the correct input mode on the TV.
- If “⊘” appears on the TV screen when pressing a button, the disc cannot accept an operation you have tried to do.

IMPORTANT:

When using the remote control, check to see if its remote control mode selector is set to the correct position:

To operate this system, set it to “AUDIO/TV/VCR.”

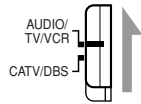

What is MP3?

MP3 is an abbreviation of Motion Picture Experts Group 1 (or MPEG-1) Audio Layer 3. MP3 is simply a file format with a data compression. By using MP3 format, one CD-R or CD-RW can contain 10 times as much data volume as a regular CD can.

Disc structure

On an MP3 disc, each song (material) is recorded as a file. Files are usually grouped into a folder. Folders can also include other folders, creating hierarchical folder layers.

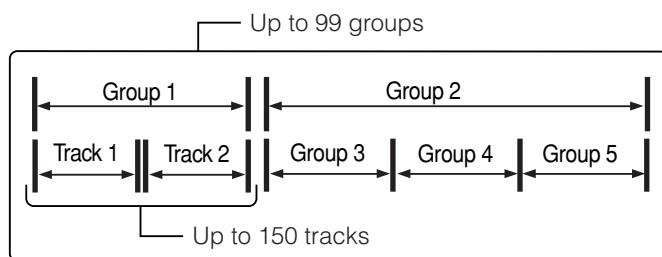

This system simplifies the hierarchical construction of a disc and manages files and folders by “tracks” and “groups.” This system can recognize up to 150 tracks per group, and up to 99 groups per disc (up to 14,850 tracks). The system ignores those exceeding the maximum numbers and cannot play them.

- If there is any type of files other than MP3 files in a folder, those files are also counted in the total number of 150.

NOTES for MP3 disc

- MP3 discs (either CD-R or CD-RW) require a longer readout time. (It differs due to the complexity of the directory/file configuration.)
- When making an MP3 disc, select ISO 9660 Level 1 or Level 2 as the disc format.
- This system supports “multi-session” discs (up to 5 sessions).
- This system can not play “packet write” discs.
- The system can play MP3 files only with the following file extensions: “.MP3,” “.Mp3,” “.mP3,” and “.mp3.”
- ID3* tags cannot be shown on the display.
* An MP3 file can contain file information called “ID3 Tag” where its album name, performer, track title, etc. are recorded. There are two versions—ID3v1 (ID3 Tag version 1) and ID3v2 (ID3 Tag version 2).
- We recommended to record each song (material) at a samplerate of 44.1 kHz and at a data transfer rate of 128 kbps.
- If both MP3 files and JPEG files are recorded on a disc, set the MP3/JPEG setting in the PICTURE menu to “MP3.” (See page 58.)
- Some MP3 discs may not be played back because of their disc characteristics or recording conditions.

Basic operations

Insert an MP3 disc.

Playback starts.

The MP3 control display appears on the TV. (See page 52.) When all tracks in a group have been played, the system plays tracks in the next group.

You can perform the following operations.

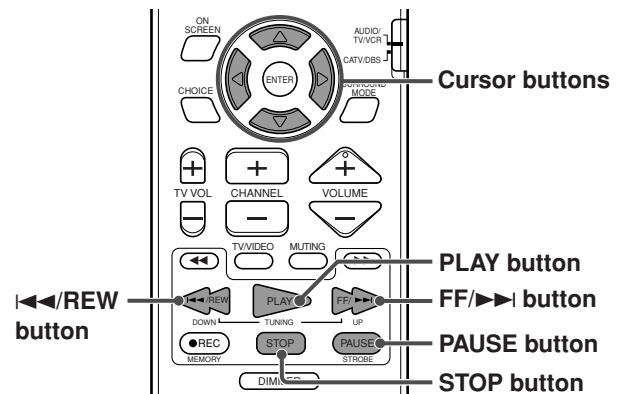

To stop playback temporarily

Press PAUSE (or **||** on the center unit).

To start playback again

Press PLAY (or **▶** on the center unit).

To skip tracks forward

Press FF/▶▶ (or **▶▶** on the center unit) as many times as required.

To skip to the beginning of the current track

Press ◀◀/REW (or **◀◀** on the center unit) once.

To skip tracks backward

Press ◀◀/REW or Cursor ▲ (or **◀◀** on the center unit) as many times as required.

To skip groups

Press Cursor ▶/◀.

To skip groups forward: Press Cursor ▶ repeatedly.

To skip groups backward: Press Cursor ◀ repeatedly.

To stop playback completely

Press STOP (or **■** on the center unit).

NOTES:

- The following functions are not available to MP3 disc playback: Program playback, random playback, repeat playback, fast-forward/reverse playback, on-screen bar, and choice menus
- Some tracks on an MP3 disc are skipped and may not be played back normally.

Operations through the MP3 control display

You can search and play the desired groups and tracks through the MP3 control display.

MP3 control display

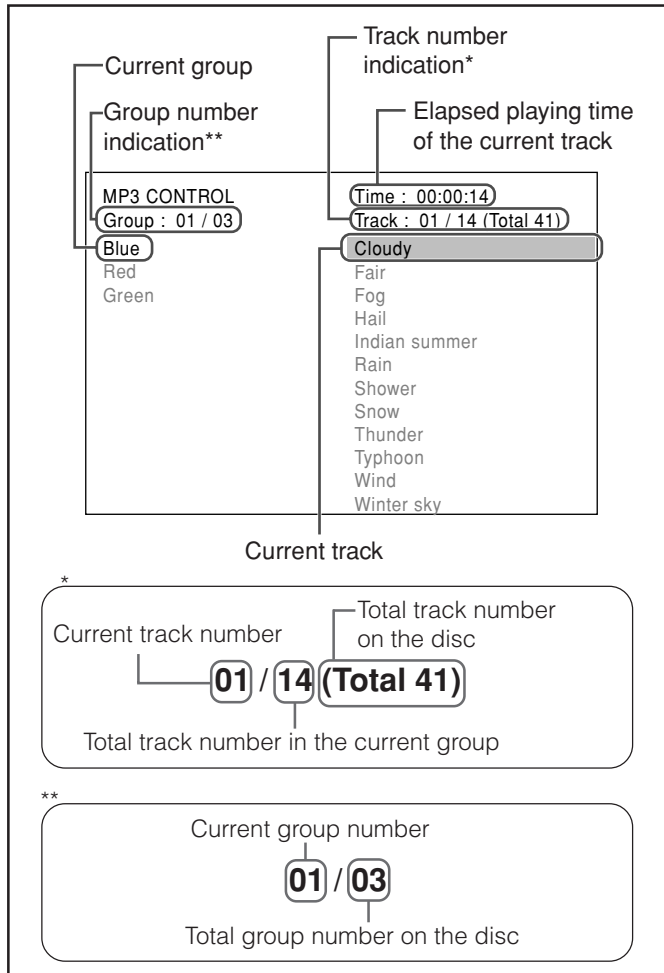

The elapsed playing time is shown only during playback.

NOTES:

You can also check the playback information on the display window.

Ex.:

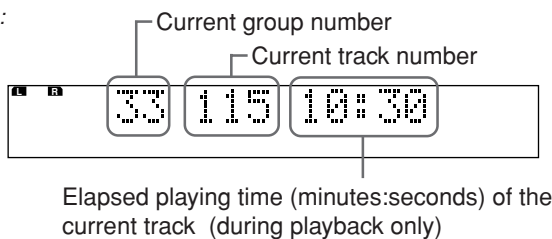

- Some group and track names may not be displayed correctly because of the recording condition.
- The order of groups and tracks on a MP3 disc may be displayed differently from the order displayed on your personal computer.

Operations

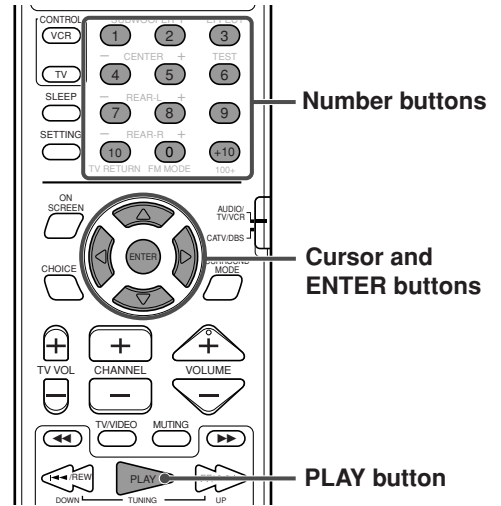

To select groups (or skip groups during playback)

Press Cursor **▶/◀**.

To select the next groups (or skip groups forward):

Press Cursor **▶** repeatedly.

To select the previous groups (or skip groups backward):

Press Cursor **◀** repeatedly.

To select tracks (or skip tracks during playback)

Press Cursor **▼/▲**.

To select the next tracks (or skip tracks forward):

Press Cursor **▼** repeatedly.

To select the previous tracks (or skip tracks backward):

Press Cursor **▲** repeatedly.

NOTE:

Groups and tracks are displayed up to 12 each at once. Pressing Cursor **▶/◀/▼/▲** repeatedly shows the hidden groups and tracks one by one.

To start playback of the selected track

Press ENTER or PLAY.

To start playback by specifying the track number

Press Number buttons (0-10, +10) to enter the track number.

Example:

- To select 3, press 3.
- To select 14, press +10 then 4.
- To select 24, press +10, +10, then 4.
- To select 110, press +10 ten times, then 10.

The entered number appears in the track number indication, then playback starts from the track you have specified.

JPEG disc playback

This system can play JPEG files such as the digital photographs recorded on a CD-R and CD-RW (JPEG disc).

- Before performing the operation in this section from the remote control, press DVD to use the remote control for the JPEG disc operations.
- Turn on your TV, and select the correct input mode on the TV.
- If “” appears on the TV screen when pressing a button, the disc cannot accept an operation you have tried to do.

IMPORTANT:

When using the remote control, check to see if its remote control mode selector is set to the correct position:

To operate this system, set it to “AUDIO/TV/VCR.”

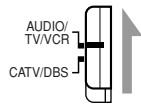

What is JPEG?

A still-picture data compression system proposed by the Joint Photographic Expert Group, which features small decrease in image quality in spite of its high compression ratio.

Disc structure

On a JPEG disc, each still picture (material) is recorded as a file. Files are usually grouped into a folder. Folders can also include other folders, creating hierarchical folder layers.

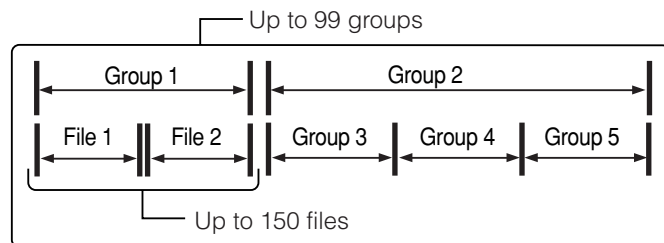

This system simplifies the hierarchical construction of a disc and manages folders by “groups.”

This system can recognize up to 150 files per group, and up to 99 groups per disc (up to 14,850 files). The system ignores those exceeding the maximum numbers and cannot play them.

- If there is any type of files other than JPEG files in a folder, those files are also counted in the total number of 150.

NOTES for JPEG disc

- JPEG discs (either CD-R or CD-RW) require a longer readout time. (It differs due to the complexity of the directory/file configuration.)
- When making a JPEG disc, select ISO 9660 Level 1 or Level 2 as the disc format.
- This system supports “multi-session” discs (up to 5 sessions).
- This system cannot play “packet write” discs.
- The system can play JPEG files only with the following file extensions: “.jpg,” “.jpeg,” “.JPG,” “.JPEG” and any uppercase and lowercase combination (such as “.Jpg”).
- We recommend to record a file at 640 x 480 resolution. (If a file has been recorded at a resolution of more than 640 x 480, it will take a longer time to be shown.)
- If both JPEG files and MP3 files are recorded on a disc, set the MP3/JPEG setting in the PICTURE menu to “JPEG.” (See page 58.)
- This system can play only baseline JPEG files*. Progressive JPEG files* or lossless JPEG files* cannot be played.
- Some JPEG discs may not be played back because of their disc characteristics or recording conditions.

* • Baseline JPEG format: Used for digital cameras, web, etc.
• Progressive JPEG format: Used for web.
• Lossless JPEG format: An old type and rarely used now.

Slide-show

You can see the still pictures one after another automatically in the slide-show playback.

Insert a JPEG disc.

The slide-show starts.

Each file (still picture) is shown on the TV for about 3 seconds, then changed to the next file one after another. When all files in a group have been played, the system play files in the next group.

You can perform the following operations during the slide-show playback.

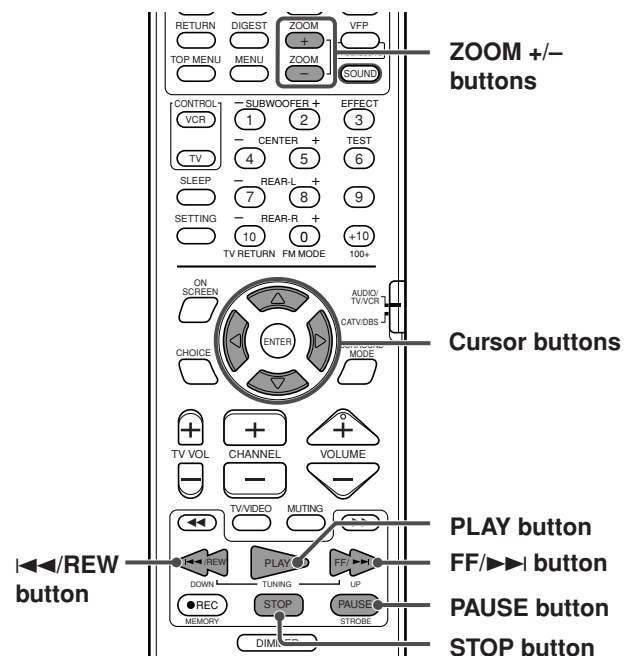

- You can perform the following operations after the still picture has been shown on the TV thoroughly.

To stop the slide-show playback temporarily

Press PAUSE (or on the center unit).

To resume the slide-show playback

Press PLAY (or on the center unit).

To zoom in or out a still picture

Press ZOOM + or - while the slide-show is paused. (See also page 47.)

To skip files forward

Press FF/▶▶▶ or Cursor (or on the center unit) as many times as required.

To skip files backward

Press /REW or Cursor (or on the center unit) as many times as required.

■ To stop the slide-show playback completely

Press **STOP** (or ■ on the center unit).

The JPEG control display appears on the TV screen.

- For how to operate through the JPEG control display, see "Operations through the JPEG control display."

NOTES:

- The following functions are not available to JPEG disc playback:
Program playback, random playback, repeat playback, fast-forward/reverse playback, on-screen bar, and choice menus
- If a black screen continuously appears in the slide-show playback:
The file currently played may be non-baseline JPEG file. In this case, select a playable file (a baseline JPEG file) again. (e.g., pressing **STOP** or **MENU** to open the JPEG control display, etc.)
Note that it may take a long time to select another file.
- Some files on a JPEG disc may be played back distortedly.

Operations through the JPEG control display

You can search and show the desired groups and files through the JPEG control display.

■ JPEG control display

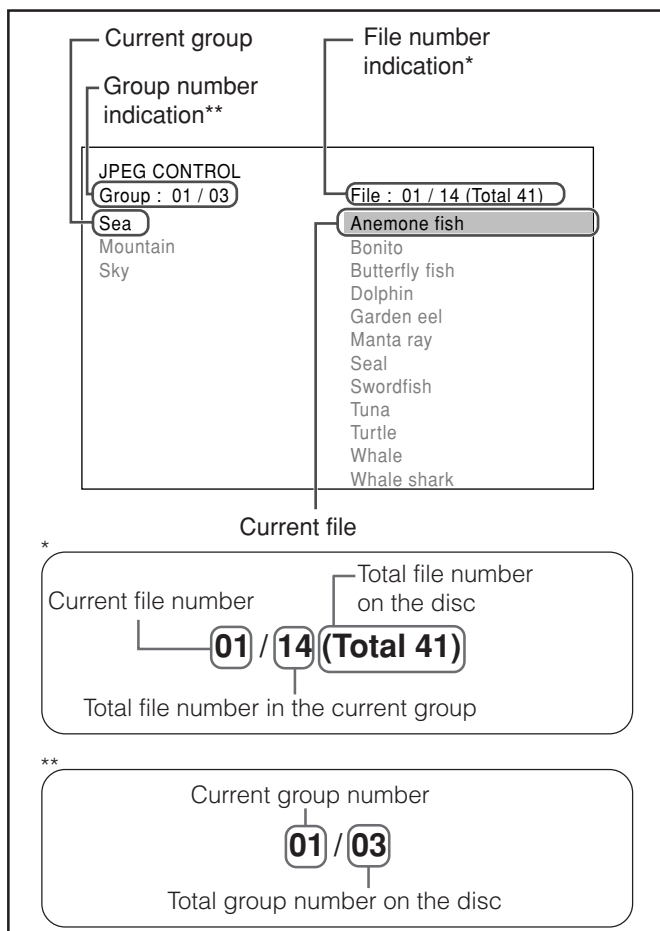

NOTES:

- You can check only the current file number on the display window.
- Some group and file names may not be displayed correctly because of the recording condition.
- The order of groups and files on a JPEG disc may be displayed differently from the order displayed on your personal computer.

■ Operations

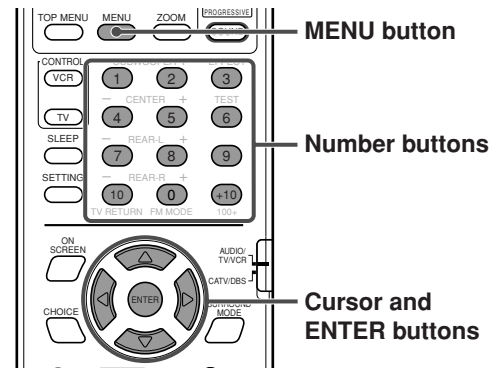

• To select groups (or skip groups during the slide-show playback)

Press **Cursor** ▶/◀.

To select the next groups (or skip groups forward):

Press **Cursor** ▶ repeatedly.

To select the previous groups (or skip groups backward):

Press **Cursor** ◀ repeatedly.

• To select files (or skip files during the slide-show playback)

Press **Cursor** ▼/▲.

To select the next files (or skip files forward):

Press **Cursor** ▼ repeatedly.

To select the previous files (or skip files backward):

Press **Cursor** ▲ repeatedly.

NOTE:

Groups and files are displayed up to 12 each at once. Pressing **Cursor** ▶/◀/▼/▲ repeatedly shows the hidden groups and files one by one.

• To show the selected file only

Press **ENTER**.

- When the still picture has been shown on the TV screen thoroughly, you can zoom in or out the still picture. See page 53.
- If you press **PLAY** (or ▶ on the center unit), the slide-show playback starts from the selected file.

• To start the slide-show playback by specifying the file number

Press **Number buttons** (0-10, +10) to enter the file number.

Example:

- To select 3, press 3.
- To select 14, press +10 then 4.
- To select 24, press +10, +10, then 4.
- To select 110, press +10 ten times, then 10.

The selected file number appears in the file number indication, then the slide-show playback starts from the file you have specified.

• To return to the JPEG control display

Press **MENU**.

Setting DVD preferences

You can adjust the initial setting of DVD player according to your preference or needs through the choice menus shown on the TV screen. Before performing the operations in this section, press DVD on the remote control to change the source to DVD.

- You can also adjust the initial setting through the choice menus when selecting AUX or AUX DIGITAL as the source (except when an MP3 disc or a JPEG disc is inserted). In this case, the adjustment of front speakers (L/R BALANCE, BASS, and TREBLE: see page 59) and the adjustment of speaker level (see page 61) take effect for AUX or AUX DIGITAL.

IMPORTANT:

When using the remote control, check to see if its remote control mode selector is set to the correct position:
To operate this system, set it to "AUDIO/TV/VCR."

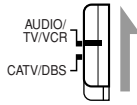

Using the choice menus

You can adjust the initial setting of DVD playback according to your preference or needs through five choice menus.

- You need to turn on your TV and select the correct input mode on the TV.
- You can only use the remote control for the choice menu operations.
- You can change the language used in the choice menus. See page 57.
- You cannot show the choice menus when an MP3 disc or a JPEG disc is inserted.

Choice menus

LANGUAGE menu (see page 57)

You can select the initial languages for the disc menu, audio, and subtitle.

You can also select the language used on the TV screen while operating this system.

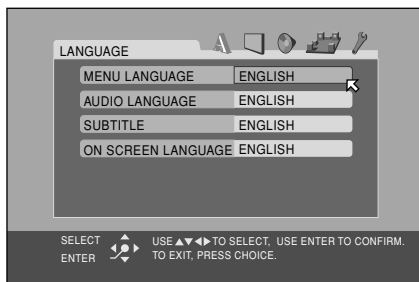

PICTURE menu (see page 58)

You can select the desired options concerning a picture or monitor screen.

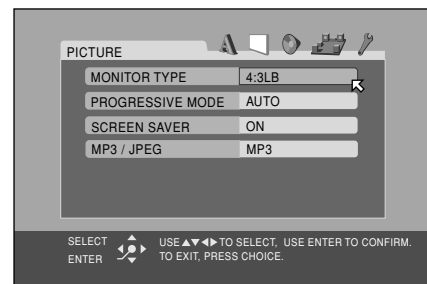

AUDIO menu (see page 59)

You can adjust the sound settings of this system through this menu.

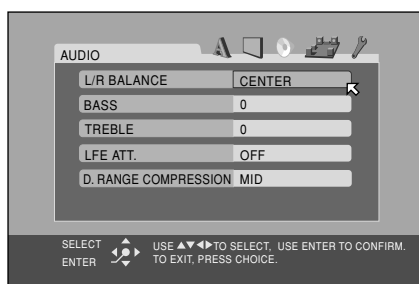

SPK. SETTING menu (see page 60)

You can make the speaker settings according to the size and layout of your speakers.

You can also adjust the output level of the subwoofer, center speaker, and rear speakers.

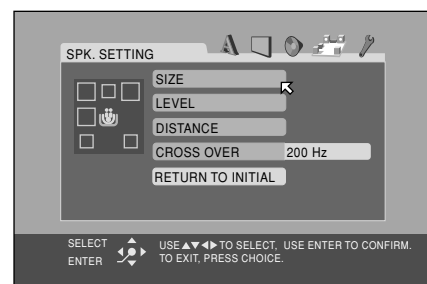

OTHERS menu (see page 62)

You can change the settings for some of the functions. To set AV COMPU LINK mode and Parental Lock, also use this menu.

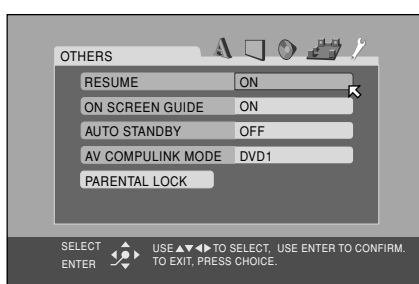

Basic procedure through the choice menus

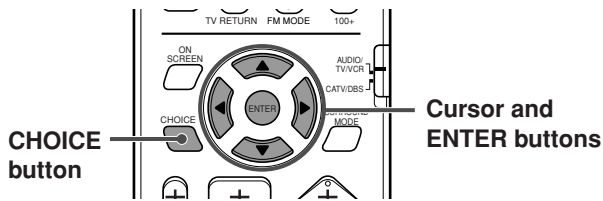

1 Press CHOICE.

The LANGUAGE menu appears on the TV.

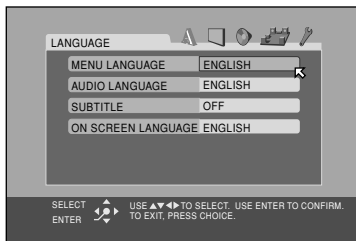

2 Press Cursor ▶/◀ repeatedly to display one of the choice menus—LANGUAGE, PICTURE, AUDIO, SPK. SETTING, or OTHERS.

Each time you press the button, the choice menus change.

Example: When the PICTURE menu is selected.

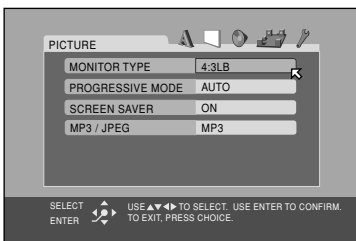

3 Press Cursor ▼/▲ repeatedly to move to the item you want to set up.

Example: When "PROGRESSIVE MODE" is selected.

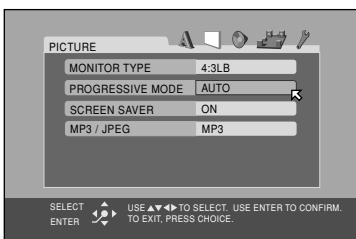

4 Press ENTER.

The pop-up window, listing the selectable options, appears on the choice menu.

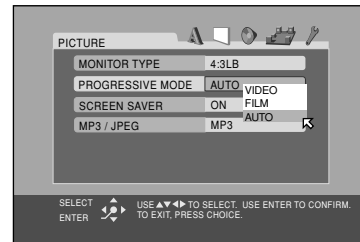

5 Press Cursor ▲/▼ repeatedly to select the desired option.

Example: When "FILM" is selected.

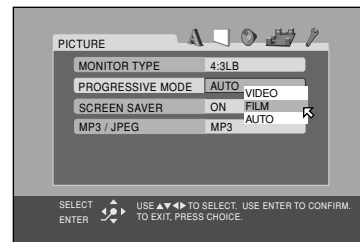

6 Press ENTER.

Your choice is stored.

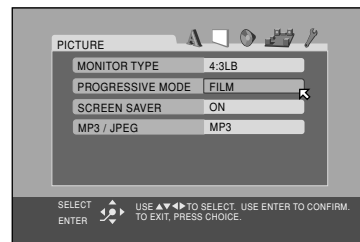

To set other items on the same choice menu

Repeat steps 3 to 6.

To move to another choice menu

Press Cursor ◀▶ repeatedly to select a choice menu you want to set up.

To return to the normal screen

Press CHOICE.

NOTE:

Some items in the choice menus consist of sub-menus to set up. Selecting them and pressing ENTER makes its sub-menu appear on the TV. You can set them using Cursor ◀▶/▲▼ and ENTER (as explained in this basic procedure).

Setting DVD preferences

LANGUAGE menu

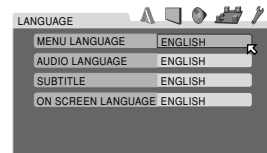

NOTE:

You can select "MENU LANGUAGE," "AUDIO LANGUAGE," and "SUBTITLE" only while playback is stopped.



Items	Contents and guidelines
<p>MENU LANGUAGE Some DVDs have their own menus in multiple languages.</p> <ul style="list-style-type: none"> Select the initial language shown in the menus. <p>AUDIO LANGUAGE Some DVDs have multiple audio languages.</p> <ul style="list-style-type: none"> Select the initial audio language. 	<p>ENGLISH, SPANISH, FRENCH, CHINESE, GERMAN, ITALIAN, JAPANESE, and language codes from AA to ZU (see below)</p> <p>Note: when the language you have selected is not recorded on a disc, the original language is automatically used as the initial language.</p>
<p>SUBTITLE Some DVDs have multiple subtitle languages.</p> <ul style="list-style-type: none"> Select the initial subtitle language. 	<p>OFF (no indication of subtitles), ENGLISH, SPANISH, FRENCH, CHINESE, GERMAN, ITALIAN, JAPANESE, and language codes from AA to ZU (see below)</p> <p>Note: when the language you have selected is not recorded on a disc, the original language is automatically used as the initial language.</p>
<p>ON SCREEN LANGUAGE Select the language shown on the TV screen while operating this system.</p>	<p>ENGLISH, CHINESE, and SPANISH</p>

The language codes list

AA	Afar	GL	Galician	ML	Malayalam	SO	Somali
AB	Abkhazian	GN	Guarani	MN	Mongolian	SQ	Albanian
AF	Afrikaans	GU	Gujarati	MO	Moldavian	SR	Serbian
AM	Ameharic	HA	Hausa	MR	Marathi	SS	Siswati
AR	Arabic	HI	Hindi	MS	Malay (MAY)	ST	Sesotho
AS	Assamese	HR	Croatian	MT	Maltese	SU	Sundanese
AY	Aymara	HU	Hungarian	MY	Burmese	SV	Swedish
AZ	Azerbaijani	HY	Armenian	NA	Nauru	SW	Swahili
BA	Bashkir	IA	Interlingua	NE	Nepali	TA	Tamil
BE	Byelorussian	IE	Interlingue	NL	Dutch	TE	Telugu
BG	Bulgarian	IK	Inupiak	NO	Norwegian	TG	Tajik
BH	Bihari	IN	Indonesian	OC	Occitan	TH	Thai
BI	Bislama	IS	Icelandic	OM	(Afan) Oromo	TI	Tigrinya
BN	Bengali, Bangla	IW	Hebrew	OR	Oriya	TK	Turkmen
BO	Tibetan	JI	Yiddish	PA	Panjabi	TL	Tagalog
BR	Breton	JW	Javanese	PL	Polish	TN	Setswana
CA	Catalan	KA	Georgian	PS	Pashto, Pushto	TO	Tonga
CO	Corsican	KK	Kazakh	PT	Portuguese	TR	Turkish
CS	Czech	KL	Greenlandic	QU	Quechua	TS	Tsonga
CY	Welsh	KM	Cambodian	RM	Rhaeto-Romance	TT	Tatar
DA	Danish	KN	Kannada	RN	Kirundi	TW	Twi
DZ	Bhutani	KO	Korean (KOR)	RO	Rumanian	UK	Ukrainian
EL	Greek	KS	Kashmiri	RU	Russian	UR	Urdu
EO	Esperanto	KU	Kurdish	RW	Kinyarwanda	UZ	Uzbek
ET	Estonian	KY	Kirghiz	SA	Sanskrit	VI	Vietnamese
EU	Basque	LA	Latin	SD	Sindhi	VO	Volapuk
FA	Persian	LN	Lingala	SG	Sangho	WO	Wolof
FI	Finnish	LO	Laothian	SH	Serbo-Croatian	XH	Xhosa
FJ	Fiji	LT	Lithuanian	SI	Singhalese	YO	Yoruba
FO	Faroese	LV	Latvian, Lettish	SK	Slovak	ZU	Zulu
FY	Frisian	MG	Malagasy	SL	Slovenian		
GA	Irish	MI	Maori	SM	Samoan		
GD	Scots Gaelic	MK	Macedonian	SN	Shona		

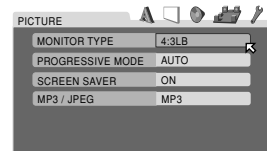
PICTURE menu



Items	Contents and guidelines
<p>MONITOR TYPE You can select the monitor type to match your TV when you play DVDs recorded in the picture's height/width ratio of 16:9.</p>	<ul style="list-style-type: none"> • 16:9 NORMAL (Wide television conversion) Select this when the aspect ratio of your TV is fixed to 16:9 (wide TV). The system automatically adjusts the screen width of the output signal correctly when playing back a picture whose aspect ratio is 4:3. • 16:9 AUTO (Wide television conversion) Select this when the aspect ratio of your TV is 16:9 (wide TV). • 4:3 LB (Letter Box conversion) Select this when the aspect ratio of your TV is 4:3 (conventional TV). While viewing a wide screen picture, the black bars appear on the top and the bottom of the screen. • 4:3 PS (Pan Scan conversion) Select this when the aspect ratio of your TV is 4:3 (conventional TV). While viewing a wide screen picture, the black bars do not appear, however, the left and right edges of the pictures will not be shown on the screen. • 16:9 MULTI NORMAL • 16:9 MULTI AUTO • 4:3 MULTI LB • 4:3 MULTI PS <p>These "MULTI" options should be selected when you connect the system to a multi-color system TV. If you select one of these options, the system outputs a PAL or NTSC video signal according to the disc, regardless of the VIDEO OUT SELECT switch setting (see page 10).</p> <div style="display: flex; justify-content: space-around; align-items: flex-start;"> <div style="text-align: center;">  <p>Ex.: 16:9</p> </div> <div style="text-align: center;">  <p>Ex.: 4:3 LB</p> </div> <div style="text-align: center;">  <p>Ex.: 4:3 PS</p> </div> </div>
<p>PROGRESSIVE MODE You can select the progressive mode according to the picture type (film or video source). Normally, set to "AUTO." This mode is available only when "NTSC" is selected on the VIDEO OUT SELECT switch (see page 10).</p>	<ul style="list-style-type: none"> • VIDEO Suitable for playing back a video source disc. • FILM Suitable for playing back a film or progressive source disc. • AUTO Used to play a disc containing both video and film source materials. This system recognizes the picture type (film or video source) of the current disc according to the disc information. <ul style="list-style-type: none"> • If the playback picture is unclear or noisy, or the oblique lines of the picture are rough, try to change to other modes.
<p>SCREEN SAVER You can activate or deactivate the screen saver function. (See page 27.)</p>	<ul style="list-style-type: none"> • ON The picture on the TV screen becomes dark. • OFF The screen saver function does not work.
<p>MP3/JPEG If both MP3 files and JPEG files are recorded on a disc, you can select which files to play.</p>	<ul style="list-style-type: none"> • MP3 The system plays MP3 files. • JPEG The system plays JPEG files.

NOTES:

- Even if "4:3 PS" is selected, the screen size may become "4:3 LB" with some DVDs. This depends on how they are recorded.
- When you select "16:9 NORMAL" for a picture whose aspect ratio is 4:3, the picture slightly changes due to the process for converting the picture width.

Setting DVD preferences

AUDIO menu

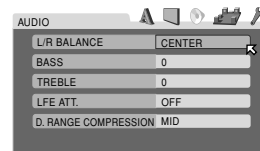

Items	Contents and guidelines
<p>L/R BALANCE Adjust the balance between the left front speaker and right front speaker.</p>	<p>L -21 to L -1 ⇄ CENTER ⇄ R -1 to R -21 (by 1 step)</p> <ul style="list-style-type: none"> • CENTER The outputs of the left and right front speakers are identical. • L -21 to L -1 and R -1 to R -21 As the number increases, the output from one speaker becomes smaller than the other speaker's. (When you select "-21," you cannot output the sound from the speaker.)
<p>BASS Adjust the enhancement level for bass sound from the front speakers.</p>	<p>Within the range from -10 to +10 (by 2 step).</p>
<p>TREBLE Adjust the enhancement level for treble sound from the front speakers.</p>	
<p>LFE ATT. The Low Frequency Effect attenuator diminishes the distortion of the bass sound from the subwoofer while playing back a disc with Dolby Digital or DTS Digital Surround.</p>	<ul style="list-style-type: none"> • ON Select this to diminish the distortion of the bass sound from the subwoofer. • OFF To cancel this function.
<p>D. RANGE COMPRESSION You can enjoy a powerful sound at night even at a low volume level when listening to the sound with Dolby Digital.</p>	<ul style="list-style-type: none"> • MAX Select this when you want to apply the compression effect fully (useful at midnight). • MID Select this when you want to reduce the dynamic range a little. • OFF Select this when you want to enjoy surround with its full dynamic range (no effect applied).

SPK. SETTING menu



Items	Contents and guidelines
SIZE	Enters the SIZE sub-menu (the speaker size setting menu). (See below.)
LEVEL	Enters the LEVEL sub-menu (the speaker level setting menu). (See page 61.)
DISTANCE	Enters the DISTANCE sub-menu (the speaker distance setting menu). (See page 61.)
CROSS OVER* Small speakers cannot reproduce the bass sounds efficiently. If you use a small speaker in any position, this unit automatically reallocates the bass sound elements assigned to the small speaker to the large speakers. To use this function properly, set this crossover frequency level according to the size of the smallest speaker connected.	<ul style="list-style-type: none"> • 200 Hz (Select this when using the supplied speakers.) Select this when the cone speaker unit built in the smallest speaker connected is about 4 cm. • 150 Hz Select this when the cone speaker unit built in the smallest speaker connected is about 6 cm. • 120 Hz Select this when the cone speaker unit built in the smallest speaker connected is about 8 cm. • 100 Hz Select this when the cone speaker unit built in the smallest speaker connected is about 10 cm. • 80 Hz Select this when the cone speaker unit built in the smallest speaker connected is about 12 cm.
RETURN TO INITIAL	Resets all speaker settings to the initial settings

* If you have selected "LARGE" for all speakers in the SIZE menu, this function will not take effect.

SIZE menu

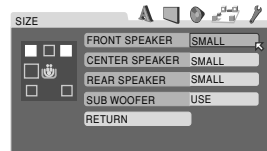

CAUTION:

When using the supplied speakers, select "SMALL" for each. Selecting "LARGE" may damage the speakers.

NOTE:

When "SMALL" is selected for the front speakers, you cannot select "LARGE" for the center speaker and rear speakers.

Items	Contents and guidelines
FRONT SPEAKER CENTER SPEAKER REAR SPEAKER Select the speaker size according to the size of your speakers. (You cannot select "NONE" for the front speakers.)	<ul style="list-style-type: none"> • LARGE Select this when the cone speaker unit built in the speaker is larger than 12 cm. • SMALL (Select this when using the supplied speakers.) Select this when the cone speaker unit built in the speaker is smaller than 12 cm. • NONE Select this when the center speaker and/or rear speakers are not connected or not in use.
SUB WOOFER	USE You cannot select this item.
RETURN	Returns to the SPK. SETTING menu.

Setting DVD preferences

LEVEL menu



NOTE:

When "NONE" is selected for the center speaker or rear speakers in the SIZE menu, you cannot enter the LEVEL menu. (See page 60.)

Items	Contents and guidelines
CENTER SPEAKER* LEFT REAR SPEAKER* RIGHT REAR SPEAKER* SUB WOOFER Adjust the output level of those speakers.	Within the range from -10 dB to +10 dB. (by 1 dB step)
TEST TONE**	Outputs the test tone.
RETURN	Returns to the SPK. SETTING menu.

- * You cannot select "CENTER SPEAKER" when one of the DAP modes is selected as the surround mode. (See page 35.)
- * You cannot select "CENTER SPEAKER," "LEFT REAR SPEAKER," and "RIGHT REAR SPEAKER" when the surround mode is off (stereo). (See page 35.)

DISTANCE menu

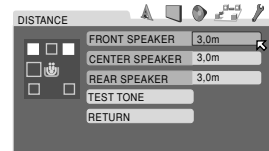

NOTE:

When "NONE" is selected for the center speaker and rear speakers in the SIZE menu, you cannot adjust the speaker distance of those speakers. (See page 60.)

Items	Contents and guidelines
FRONT SPEAKER CENTER SPEAKER REAR SPEAKER Select the distance from the listening position.	Within the range from 0.3 m to 9.0 m. (by 0.3 m step)
TEST TONE**	Outputs the test tone.
RETURN	Returns to the SPK. SETTING menu.

Example:

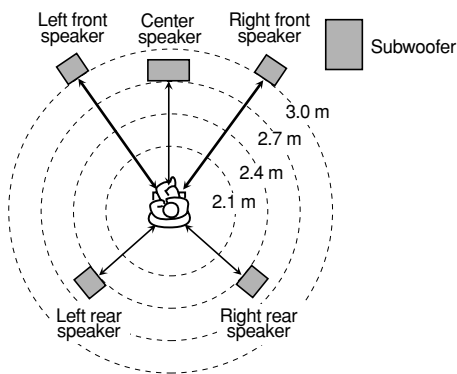

In this case, set the distance of each speaker as follows:

- The distance of the front speakers: 3.0 m
- The distance of the center speaker: 2.7 m
- The distance of the rear speakers: 2.4 m

** The test tone comes out of all the activated speakers in the following sequence.

⇒ **Left front speaker** ⇒ **Center speaker** ⇒ **Right front speaker** ⇒ **Right rear speaker** ⇒ **Left rear speaker**
 ⇒ (back to the beginning)

NOTE:

When "NONE" is selected for the center speaker and rear speakers in the SIZE menu, the test tone does not come out of those speakers. (See page 60.)

OTHERS menu

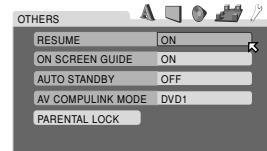

NOTE:

You can select "PARENTAL LOCK" only while playback is stopped.

Items	Contents and guidelines
<p>RESUME You can activate or deactivate the resume playback function.</p>	<ul style="list-style-type: none"> • ON Select this to activate this function. • OFF Select this to deactivate.
<p>ON SCREEN GUIDE You can activate or deactivate the on-screen guide icons. (See page 27.)</p>	<ul style="list-style-type: none"> • ON Select this to activate this function. • OFF Select this to deactivate.
<p>AUTO STANDBY* When playback ends and does not restart for more than the time you specify, this system turns off by itself.</p>	<ul style="list-style-type: none"> • 60 This system turns off by itself if playback does not restart within 60 minutes. • 30 This system turns off by itself if playback does not restart within 30 minutes. • OFF Select this to deactivate.
<p>AV COMPULINK MODE When you use AV COMPU LINK remote control, you need to set this item correctly.</p>	<ul style="list-style-type: none"> • DVD 1 • DVD 2 • DVD 3 <p>See page 67 for more details.</p>
<p>PARENTAL LOCK You can restrict playback of a DVD containing violent scenes and those not suitable for your family members.</p>	<p>Enter the PARENTAL LOCK sub-menu. (See page 63.)</p>

* When both of the auto standby function and the sleep timer are activated, if the shut-off time set by the sleep timer comes earlier than the one set by the auto standby function, the sleep timer takes effect.

Setting DVD preferences

Restricting playback by Parental Lock

Using this function, you can restrict playback of a DVD containing violent scenes and those not suitable for your family members. Nobody can play such a disc unless this function is canceled.

- This setting takes effect only for the DVDs containing the parental lock level information—Level 1 (most restrictive) to Level 8 (least restrictive).
- You can set the Parental Lock only while playback is stopped.

Setting Parental Lock

From the remote control ONLY:

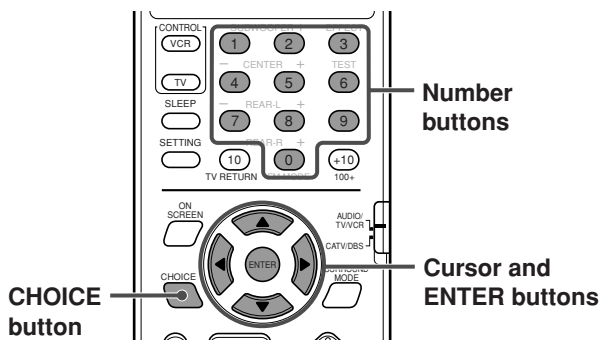

- 1 Press CHOICE, then press Cursor $\blacktriangleright/\blacktriangleleft$ to display the OTHERS menu.
- 2 Press Cursor $\blacktriangledown/\blacktriangleup$ repeatedly to move \blacktriangleright to "PARENTAL LOCK," then press ENTER.
The PARENTAL LOCK sub-menu appears on the TV.

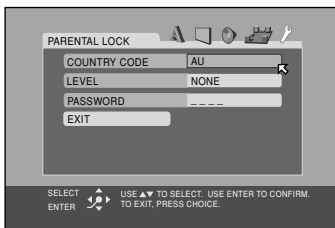

- 3 Press Cursor $\blacktriangledown/\blacktriangleup$ repeatedly to move \blacktriangleright to "COUNTRY CODE," then press ENTER.

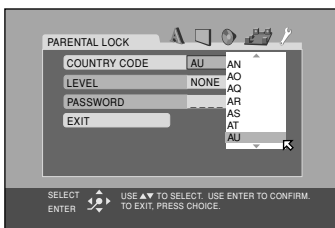

- 4 Press Cursor $\blacktriangledown/\blacktriangleup$ repeatedly to select the country code, then press ENTER.

See "Country/Area codes list for Parental Lock" on page 65.

The \blacktriangleright moves to "LEVEL."

- 5 Press ENTER.

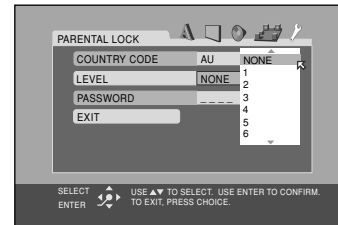

- 6 Press Cursor $\blacktriangledown/\blacktriangleup$ repeatedly to select the level of restriction, then press ENTER.

The \blacktriangleright moves to "PASSWORD."

- Select "NONE" to cancel this function.

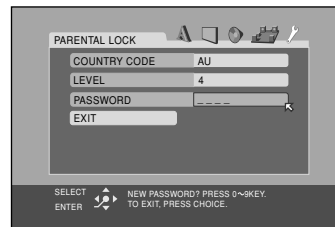

- 7 Press Number buttons (0-9) to enter a four digit number as your password, then press ENTER.

The \blacktriangleright moves to "EXIT."

- 8 Press ENTER.

The OTHERS menu resumes.

To return to the normal screen
Press CHOICE.



NOTE:

Remember your password or make a note of it.
You need to enter your password to change the setting or release the lock. To change the setting, see page 64.

Changing the setting of Parental Lock

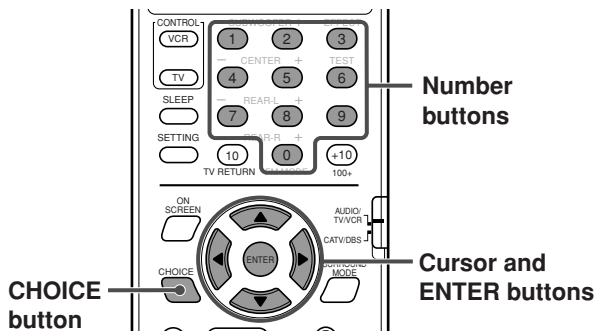
From the remote control ONLY:



- 1 Press CHOICE, then press Cursor ►/◄ to display the OTHERS menu.
- 2 Press Cursor ▼/▲ repeatedly to move  to "PARENTAL LOCK," then press ENTER.
The PARENTAL LOCK sub-menu appears on the TV.
 - You can only move  to "PASSWORD" or to "EXIT" before you enter your password.

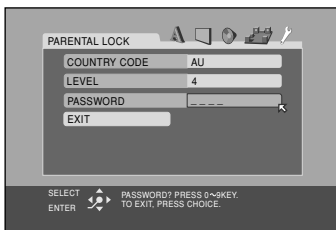

- 3 Press Number buttons (0-9) to enter your password, then press ENTER.
 - If you enter a wrong password, "WRONG! RETRY..." appears under the PARENTAL LOCK sub-menu. You cannot go to next steps before you enter the correct password.
- 4 Press Cursor ▲/▼ repeatedly to move  to the item you want to change, then press ENTER.
- 5 Press Cursor ▲/▼ repeatedly to change the setting, then press ENTER.
- 6 Press Number buttons (0-9) to enter your password, then press ENTER.
The new setting is stored.

NOTES:

- You cannot set the Parental Lock before you set your password. (See page 63.)
- If you go out of the PARENTAL LOCK sub-menu before setting your password in step 6, the new country code and parental level will not become effective, but the old country code and parental level remain effective.
- When you enter wrong passwords more than three times, the  moves to "EXIT" automatically and Cursor ▲/▼ do not work. Press ENTER to exit from the PARENTAL LOCK sub-menu, then repeat from step 1.
- If you forget your password, enter "8888."

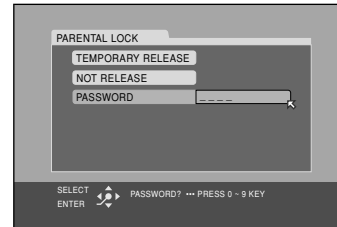

Releasing Parental Lock temporarily

When you set a strict parental level, some discs may not be played back at all. When you load such a disc and try to play it, the following display appears on the TV screen. You can release Parental Lock temporarily.

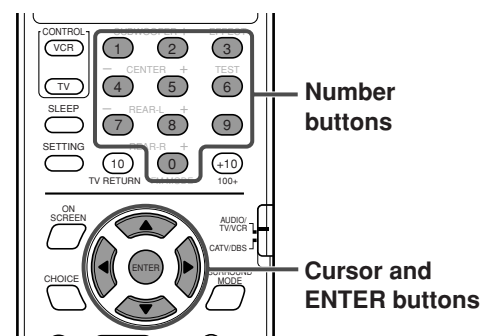

From the remote control ONLY:



- 1 Press Cursor ▲/▼ repeatedly move  to "TEMPORARY RELEASE", then press ENTER.
The  moves to "PASSWORD."
 - When selecting "NOT RELEASE," press ▲ to remove the disc.
- 2 Press Number buttons (0-9) to enter your password.
Playback starts.
 - If you enter a wrong password, "WRONG! RETRY..." appears under the PARENTAL LOCK sub-menu. You cannot play the disc before you enter the correct password.

NOTE:

When you enter wrong passwords more than three times, the  moves to "NOT RELEASE" automatically and Cursor ▲/▼ do not work. Press ▲ to remove the disc.

Setting DVD preferences

Country/Area codes list for Parental Lock

AD	Andorra	ER	Eritrea	LA	Lao People's Democratic Republic	RW	Rwanda
AE	United Arab Emirates	ES	Spain			SA	Saudi Arabia
AF	Afghanistan	ET	Ethiopia	LB	Lebanon	SB	Solomon Islands
AG	Antigua and Barbuda	FI	Finland	LC	Saint Lucia	SC	Seychelles
AI	Anguilla	FJ	Fiji	LI	Liechtenstein	SD	Sudan
AL	Albania	FK	Falkland Islands (Malvinas)	LK	Sri Lanka	SE	Sweden
AM	Armenia	FM	Micronesia (Federated States of)	LR	Liberia	SG	Singapore
AN	Netherlands Antilles			LS	Lesotho	SH	Saint Helena
AO	Angola	FO	Faroe Islands	LT	Lithuania	SI	Slovenia
AQ	Antarctica	FR	France	LU	Luxembourg	SJ	Svalbard and Jan Mayen
AR	Argentina	FX	France, Metropolitan	LV	Latvia	SK	Slovakia
AS	American Samoa	GA	Gabon	LY	Libyan Arab Jamahiriya	SL	Sierra Leone
AT	Austria	GB	United Kingdom	MA	Morocco	SM	San Marino
AU	Australia	GD	Grenada	MC	Monaco	SN	Senegal
AW	Aruba	GE	Georgia	MD	Moldova, Republic of	SO	Somalia
AZ	Azerbaijan	GF	French Guiana	MG	Madagascar	SR	Suriname
BA	Bosnia and Herzegovina	GH	Ghana	MH	Marshall Islands	ST	Sao Tome and Principe
BB	Barbados	GI	Gibraltar	ML	Mali	SV	El Salvador
BD	Bangladesh	GL	Greenland	MM	Myanmar	SY	Syrian Arab Republic
BE	Belgium	GM	Gambia	MN	Mongolia	SZ	Swaziland
BF	Burkina Faso	GN	Guinea	MO	Macau	TC	Turks and Caicos Islands
BG	Bulgaria	GP	Guadeloupe	MP	Northern Mariana Islands	TD	Chad
BH	Bahrain	GQ	Equatorial Guinea	MQ	Martinique	TF	French Southern Territories
BI	Burundi	GR	Greece	MR	Mauritania	TG	Togo
BJ	Benin	GS	South Georgia and the South Sandwich Islands	MS	Montserrat	TH	Thailand Code Language
BM	Bermuda			MT	Malta	TJ	Tajikistan
BN	Brunei Darussalam	GT	Guatemala	MU	Mauritius	TK	Tokelau
BO	Bolivia	GU	Guam	MV	Maldives	TM	Turkmenistan
BR	Brazil	GW	Guinea-Bissau	MW	Malawi	TN	Tunisia
BS	Bahamas	GY	Guyana	MX	Mexico	TO	Tonga
BT	Bhutan	HK	Hong Kong	MY	Malaysia	TP	East Timor
BV	Bouvet Island	HM	Heard Island and McDonald Islands	MZ	Mozambique	TR	Turkey
BW	Botswana			NA	Namibia	TT	Trinidad and Tobago
BY	Belarus	HN	Honduras	NC	New Caledonia	TV	Tuvalu
BZ	Belize	HR	Croatia	NE	Niger	TW	Taiwan
CA	Canada	HT	Haiti	NF	Norfolk Island		
CC	Cocos (Keeling) Islands	HU	Hungary	NG	Nigeria	TZ	Tanzania, United Republic of
CF	Central African Republic	ID	Indonesia	NI	Nicaragua	UA	Ukraine
CG	Congo	IE	Ireland	NL	Netherlands	UG	Uganda
CH	Switzerland	IL	Israel	NO	Norway	UM	United States Minor Outlying Islands
CI	Côte d'Ivoire	IN	India	NP	Nepal		
CK	Cook Islands	IO	British Indian Ocean Territory	NR	Nauru	US	United States
CL	Chile			NU	Niue	UY	Uruguay
CM	Cameroon	IQ	Iraq	NZ	New Zealand	UZ	Uzbekistan
CN	China	IR	Iran (Islamic Republic of)	OM	Oman	VA	Vatican City State (Holy See)
CO	Colombia	IS	Iceland	PA	Panama		
CR	Costa Rica	IT	Italy	PE	Peru	VC	Saint Vincent and the Grenadines
CU	Cuba	JM	Jamaica	PF	French Polynesia		
CV	Cape Verde	JO	Jordan	PG	Papua New Guinea	VE	Venezuela
CX	Christmas Island	JP	Japan	PH	Philippines	VG	Virgin Islands (British)
CY	Cyprus	KE	Kenya	PK	Pakistan	VI	Virgin Islands (U.S.)
CZ	Czech Republic	KG	Kyrgyzstan	PL	Poland	VN	Viet Nam
DE	Germany	KH	Cambodia	PM	Saint Pierre and Miquelon	VU	Vanuatu
DJ	Djibouti	KI	Kiribati	PN	Pitcairn	WF	Wallis and Futuna Islands
DK	Denmark	KM	Comoros	PR	Puerto Rico	WS	Samoa
DM	Dominica	KN	Saint Kitts and Nevis	PT	Portugal	YE	Yemen
DO	Dominican Republic	KP	Korea, Democratic People's Republic of	PW	Palau	YT	Mayotte
DZ	Algeria			PY	Paraguay	YU	Yugoslavia
EC	Ecuador	KR	Korea, Republic of	QA	Qatar	ZA	South Africa
EE	Estonia	KW	Kuwait	RE	Réunion	ZM	Zambia
EG	Egypt	KY	Cayman Islands	RO	Romania	ZR	Zaire
EH	Western Sahara	KZ	Kazakhstan	RU	Russian Federation	ZW	Zimbabwe

Setting the system through the display window

You can adjust the sound and speaker settings of this system through the display window.

- You can adjust the sound setting of front speakers ("BAL," "BASS," and "TREBLE") for each source.
- The adjustments of the speaker size, speaker distance, "LFE ATT," "CROSS," and "D. COMP" take effect for all sources.

IMPORTANT:

When using the remote control, check to see if its remote control mode selector is set to the correct position:

To operate this system, set it to "AUDIO/TV/VCR."

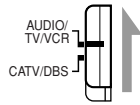

Before you start, remember...

- There is a time limit in doing the following steps. If the setting is cancelled before you finish, start from step 1 again.
- When selecting DVD, AUX, or AUX DIGITAL as the source, the settings of the corresponding items in the choice menus also change.

From the remote control ONLY:

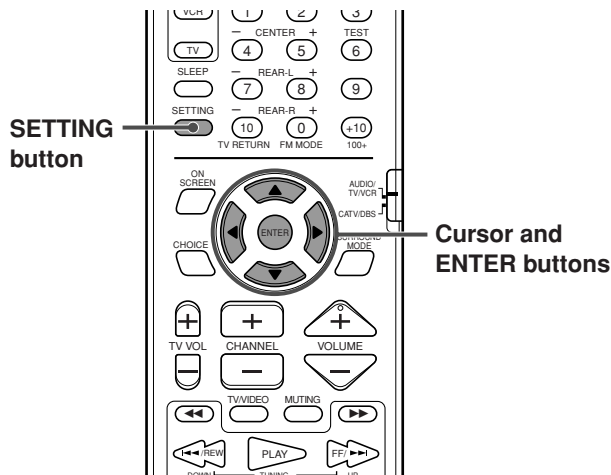

See the corresponding pages for the detail of adjustments.

- **BAL (Balance):**
Adjust the balance between the left and right front speakers. (See page 59.)
- **BASS, TREBLE:**
Adjust the enhancement level for bass or treble sound from the front speakers. (See page 59.)
- **FRNT SP (front speakers), CNTR SP (center speaker), REAR SP (rear speakers):**
Select the size of each speaker. (See page 60.)
- **FRNT D (front speakers distance), CNTR D (center speaker distance), REAR D (rear speakers distance):**
Set the distance from the listening position to the speakers. (See page 61.)
- **CROSS (CROSS OVER):**
Select the cutoff frequency of the subwoofer according to the front speakers used with this system. (See page 60.)
- **LFE ATT.:**
Diminish the distortion of the bass sound from the subwoofer while playing back a disc with Dolby Digital or DTS Digital Surround. (See page 59.)
- **D.COMP (D. RANGE COMPRESSION):**
Enjoy a powerful sound at night even at a low volume level when listening to the sound with Dolby Digital. (See page 59.)

3 Press Cursor ◀/▶ to make an adjustment.

Example:

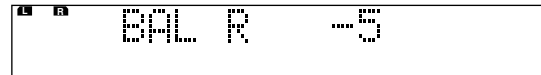

1 Press SETTING.

The item you last selected appears on the display window.

Example: "BAL" has been selected.



2 Press Cursor ▼/▲ repeatedly to select the item you want to set.

Each time you press the button, the items shown on the display window change as follows:

- ⇒ BAL ⇒ BASS ⇒ TREBLE ⇒ FRNT SP
 ⇒ CNTR SP ⇒ REAR SP ⇒ FRNT D ⇒ CNTR D
 ⇒ REAR D ⇒ CROSS ⇒ LFE ATT. ⇒ D.COMP
 ⇒ (back to the beginning)

4 Repeat steps 2 and 3 to set other items.

NOTES:

- If you have selected "SML" for the front speakers, you cannot select "LRG" for the center and rear speakers.
- You can confirm your adjustment of speaker settings by listening to the test tone. To output the test tone, press SOUND, then TEST. (See page 35.)

AV COMPU LINK remote control system

The AV COMPU LINK remote control system allows you to operate JVC TVs through the center unit. To use this remote control system, follow the diagrams and procedure explained here.

AV COMPU LINK

- The AV COMPU LINK setting is performed in the OTHERS menu of the choice menus. See page 62 for operations.
- Refer also to the manual supplied with your TV.

Connection and setup

Connecting a TV

- 1 Connect the center unit to a TV via the AV COMPU LINK jacks using the supplied AV COMPU LINK cord.

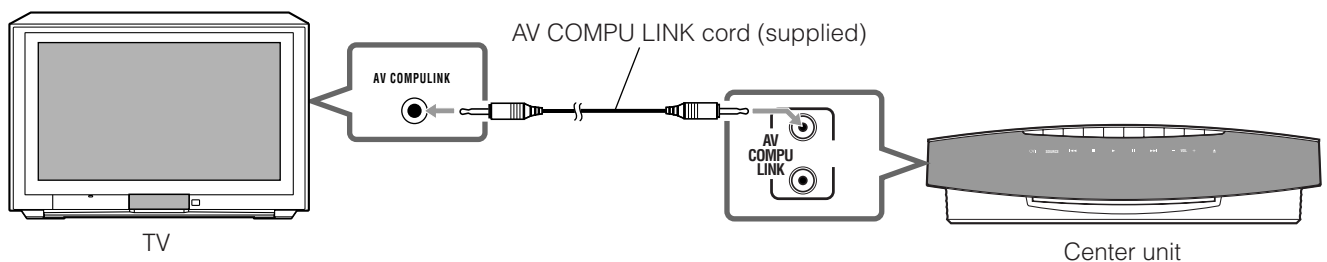

- 2 Set the AV COMPU LINK setting in the OTHERS menu as follows.

See page 62 to set the AV COMPU LINK setting.

- When connecting to the VIDEO-3 (DVD) input jack of the TV: Select "DVD1" (Initial setting).
- When connecting to the VIDEO-1 input jack of the TV: Select "DVD2."
- When connecting to the VIDEO-2 input jack of the TV: Select "DVD3."

Connecting a TV and VCR

- Refer also to the manual supplied with your VCR.

- 1 Connect the center unit to a TV and VCR via the AV COMPU LINK jacks using the AV COMPU LINK cords.

- You need two AV COMPU LINK cords to make these connections. (Only one cord is supplied with this system.)

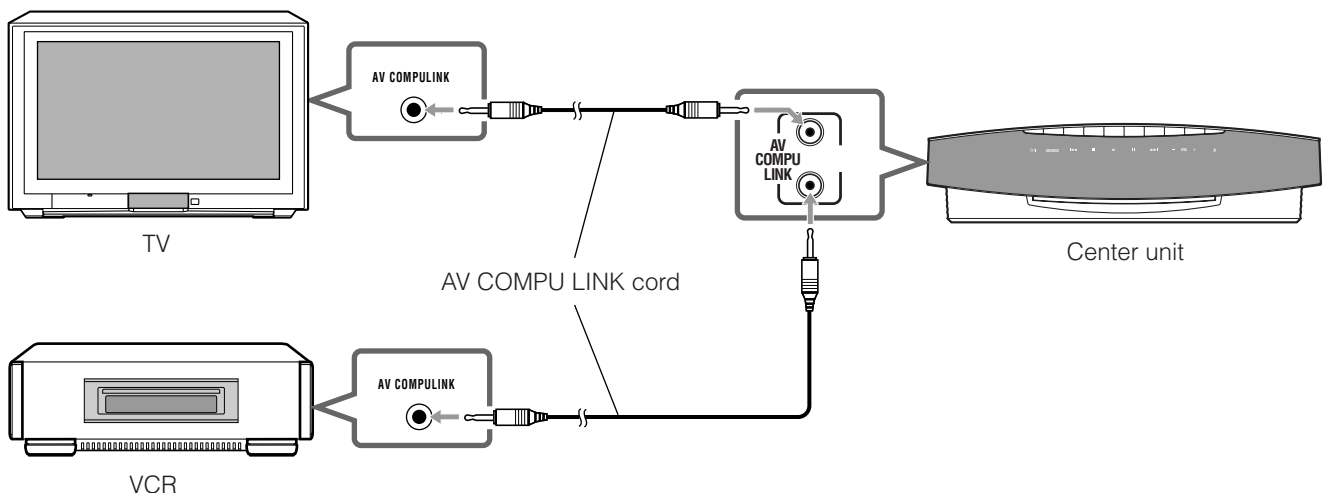

2 Set the AV COMPU LINK setting in the OTHERS menu, and the VCR's remote control code setting as follows.

See page 62 to set the AV COMPU LINK setting.

- When connecting to the VIDEO-3 (DVD) input jack of the TV:
Select "**DVD1**" (Initial setting).
Set VCR's remote control code to **A**
- When connecting to the VIDEO-1 input jack of the TV:
Select "**DVD2**."
Set VCR's remote control code to **B**
- When connecting to the VIDEO-2 input jack of the TV:
Select "**DVD3**."
Set VCR's remote control code to **A**

NOTES:

- *There may be no description about connections to a DVD player in the instruction manual of a TV or VCR. However, a TV or VCR with AV COMPU LINK II, AV COMPU LINK III, or AV COMPU LINK EX jack can be connected to the center unit.*
- *When the VCR's audio output jacks are connected to the AUX IN jacks on the center unit (see page 14):
The AV COMPU LINK remote control system automatically changes the input mode on the TV to the appropriate position, but does not change the source to play on the system.
To listen to the sound from the VCR, select AUX as the source by pressing AUX on the remote control or SOURCE on the center unit (see page 22).*
- *When the VCR's audio output jacks are connected to the TV's audio input jacks:
Turn off the system (into standby mode). To listen to the sound from the VCR, operate the TV. (Refer to the manual supplied with the TV.)*

One-touch DVD play

Simply by starting playback on the center unit, you can enjoy the DVD playback on the TV without setting other switches manually.

Insert a disc into the center unit.

Playback starts and the TV automatically turns on and changes the input mode to the appropriate position so that you can view the playback picture.

NOTE:

When the main power of the TV is off or the power cord of the TV is unplugged, you cannot use the one-touch play.

Operating other manufacturers' video equipment

By changing the remote control signals from preset ones to the other manufacturers', you can use the remote control supplied for this system to operate other manufacturers' VCRs, CATV converters, DBS tuners, and TVs. (For TVs, see page 20.)

- When operating other video equipment, aim the remote control directly at the remote control sensor on each equipment. Refer also to the instruction manuals supplied with your equipment.
- Manufacturers' codes are subject to change without notice. If they are changed, this remote control cannot operate the equipment.

Using the remote control for CATV converter or DBS tuner operations

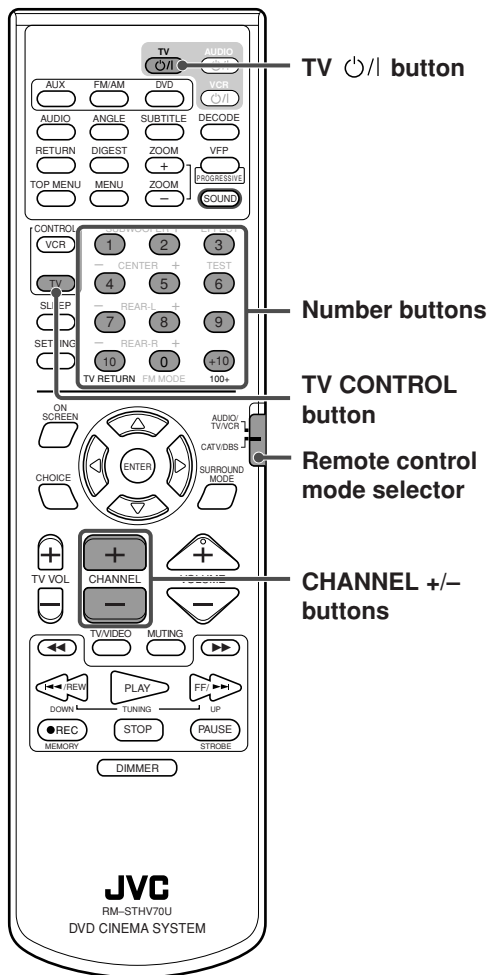

■ For operating your CATV converter or DBS tuner

- 1 Slide the remote control mode selector to "CATV/DBS."
- 2 Press and hold TV \odot/I .
Keep it pressed until step 4 is finished.
- 3 Press TV CONTROL.
- 4 Press Number buttons (1-9, 0) to enter a manufacturer's code (2 digit).
See the list below to find the code.
Examples: For a GI Jerrold product, press 0, then 1.
For a Sony, press 2, then 0.
- 5 Release TV \odot/I .
- 6 Try to operate your CATV converter or DBS tuner by pressing TV \odot/I .

When your CATV converter or DBS tuner turns on or off, you have entered the correct code.

If there are more than one code listed for your brand of CATV converter or DBS tuner, try each one until you enter the correct one.

Manufacturers' codes for CATV converter or DBS tuner

Manufacturer	Code
Echostar	21
GI Jerrold	01, 02, 03, 04, 05, 06, 07, 08
Hamlin/Regal	15, 16, 17, 18
Pioneer	13, 14
RCA	19
Scientific Atlanta	09, 10
Sony	20
Zenith	11, 12

You can use the following buttons for operating your CATV converter or DBS tuner:

IMPORTANT:

When using the remote control, check to see if its remote control mode selector is set to the correct position:

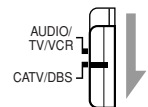

To operate CATV converter or DBS tuner, set it to "CATV/DBS."



- TV \odot/I :** Turns on and off the CATV converter or DBS tuner.
- CHANNEL +/-:** Changes the channels.
- 1-10, 0, +10 (100+):** Selects the channel.

Using the remote control for VCR

■ For operating your VCR

- 1 Slide the remote control mode selector to "AUDIO/TV/VCR."
- 2 Press and hold VCR .
- 3 Press VCR CONTROL.
- 4 Press Number buttons (1-9, 0) to enter a manufacturer's code (2 digit).
- 5 Release VCR .
- 6 Try to operate your VCR by pressing VCR .

Keep it pressed until step 4 is finished.

See the list below to find the code.

Examples: For a Philips VCR, press 0, then 9.
For an NEC VCR, press 2, then 5.

When your VCR turns on or off, you have entered the correct code.

If there are more than one cord listed for your brand of VCR, try each one until you enter the correct one.

Manufacturers' codes for VCR

Manufacturer	Code	Manufacturer	Code
JVC	01, 02, 03	Philips	09
Emerson	11, 26	RCA	05, 06
Fisher	29	Samsung	24
Funai	10, 14, 15, 16	Sanyo	21, 22, 23
Gold Star	12	Sharp	27, 28
Hitachi	04	Shintom	30
Mitsubishi	13	Sony	18, 19, 20
NEC	25	Zenith	08
Panasonic	07, 17		

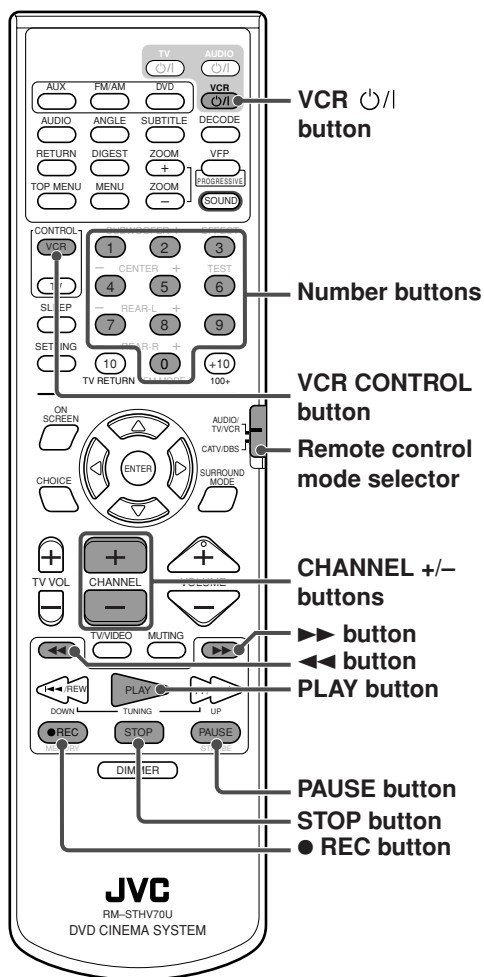

You can use the following buttons for operating your VCR:

IMPORTANT:

When using the remote control, check to see if its remote control mode selector is set to the correct position:

To operate VCR, set it to "AUDIO/TV/VCR."

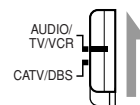

VCR : Turns on and off the VCR.

- After pressing VCR CONTROL, you can use the following buttons for operating your VCR:

- PLAY:** Starts playback.
- STOP:** Stops operation.
- PAUSE:** Pauses playback.
- ▶▶:** Fast forwards a video tape.
- ◀◀:** Rewinds a video tape.
- REC:** Press this button together with PLAY to start recording. Press this button together with PAUSE to pause recording.
- CHANNEL +/-:** Changes the TV channels on the VCR.

Maintenance

To get the best performance of the system, keep your discs and mechanism clean.

General Notes

In general, you will have the best performance by keeping your discs, and the mechanism clean.

- Store discs in their cases, and keep them in cabinets or on shelves.

Handling Discs



- Remove the disc from its case by holding it at the edge while pressing the center hole lightly.
- Do not touch the shiny surface of the disc, or bend the disc.
- Put the disc back in its case after use to prevent warping.

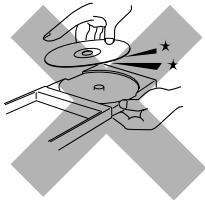

- Be careful not to scratch the surface of the disc when placing it back in its case.
- Avoid exposure to direct sunlight, temperature extremes, and moisture.



To clean the disc

Wipe the disc with a soft cloth in a straight line from center to edge.

DO NOT use any solvent—such as conventional record cleaner, spray, thinner, or benzine—to clean the disc.

Cleaning the system

• Stains on the system





Should be wiped off with a soft cloth. If the unit is heavily stained, wipe it with a cloth soaked in water-diluted neutral detergent and wrung well, then wipe clean with a dry cloth.

• Since the unit may deteriorate in quality, become damaged or get its paint peeled off, be careful about the following.

- DO NOT wipe it with a hard cloth.
- DO NOT wipe it strong.
- DO NOT wipe it with thinner or benzine.
- DO NOT apply any volatile substance such as insecticides to it.
- DO NOT allow any rubber or plastic to remain in contact with it for a long time.
- DO NOT clean the moving panel when it is open.

Troubleshooting

Use this chart to help you solve daily operational problems. If there is any problem you cannot solve, contact your JVC service center.

PROBLEM	POSSIBLE CAUSE	SOLUTION
Power does not come on.	The power cord is not connected to an AC outlet or the center unit.	Insert the plug into the socket.
Power is not supplied to the powered subwoofer.	The power cord of the subwoofer is not connected to an AC outlet.	Press  on the center unit or AUDIO  on the remote control to turn off the system, insert the plug firmly into an AC outlet, and press  on the center unit or AUDIO  on the remote control again.
	The system cable is not connected.	Connect the system cable.
The remote control does not work.	It is too far from the center unit, or is not facing the center unit.	Come closer to the center unit. (Operate the remote control within 7 m from the center unit.)
	There is something obstructing the remote sensor.	Avoid any obstacles. (See page 19.)
	The remote control is not aimed at the remote sensor on the center unit or components.	Aim the remote control at the remote sensor on each equipment you want to operate.
	The remote control mode selector is set at an incorrect position.	Set it to the correct position.
	The batteries are exhausted.	Replace the batteries.
	The batteries have been inserted the wrong way round (+/-).	Insert the batteries correctly.
	The remote control is not set to operate the DVD player, tuner (FM/AM), or sound setting.	For the DVD player, press DVD before you perform the operations. For the tuner, press FM/AM before you perform the operations. For using the sound setting buttons to adjust the output level of the speakers, press SOUND before you perform the operations.
	Sunlight is falling directly on the remote sensor.	Cover the remote sensor from direct sunlight.
	The remote control signals are not set correctly.	Enter the correct manufacturer's code. (See pages 20, 69, 70.)
No sound.	The system cable and/or speaker cord is not connected.	Check the connection.
	There is a short in the speaker cord.	Reconnect the speaker cord.
	The audio cord is not connected to AUX IN and/or DIGITAL IN correctly.	Connect the cord correctly. (See page 14.)
	An incorrect source has been selected.	Select the correct source. (See page 22.)
	Muting is on.	Press MUTING to cancel muting.
	The decode mode is not set correctly.	Select the proper decode mode. (See page 25.)

Troubleshooting

	PROBLEM	POSSIBLE CAUSE	SOLUTION
General	Sound from one front speaker only.	The speaker cord is not connected correctly. Left-right balance is not set properly.	Connect the cord correctly. (See page 13.) Adjust the balance properly. (See pages 59 and 66.)
	No sound from the center and/or rear speakers.	The speaker setting is incorrect.	Set the speaker setting properly. (See pages 60 and 66.)
	The system does not work correctly.	Lightning or electronic noise interferes with operation of the microcomputer. Immediately after beginning to heat the room, the system was moved to a cold location causing condensation to form inside.	Switch the power off, and remove and re-insert the power plug in the socket. Switch the power off and leave the unit a few hours before switching the power on again.
DVD Playback	No picture is displayed on the TV screen.	The video cord is not connected correctly. TV input selection is incorrect. The disc is not playable.	Connect the cord correctly. (See page 10.) Select the correct input on the TV. Use a playable disc. (See page 6.)
	No picture is displayed on the TV screen, the picture is blurred, or the picture is divided into two parts.	The scan mode is set to "PROGRESSIVE" though the system is connected to the TV which does not support the progressive video input such as a conventional TV.	Change the scan mode to "INTERLACE." (See page 26.)
	A disc cannot be played.	The system's and disc's Region Code numbers are incompatible. Parental Lock is in use.	Replace the disc. (See page 6.) Enter password to change the parental level. (See page 64.)
	A disc cannot be played and "0:00" is displayed on the display window.	The disc is inserted with its label and data sides inverted. The unplayable disc is inserted.	Insert the disc correctly. (See page 27.) Replace the disc. (See page 6.)
	Video and audio are distorted.	The disc is scratched or dirty. A VCR is connected between the center unit and the TV. With some discs, a picture may be blurred when setting "PROGRESSIVE MODE" to "FILM" or "AUTO."	Replace or clean the disc. (See page 71.) Connect the center unit and TV directly. Set "PROGRESSIVE MODE" to "VIDEO." (See page 58.)
	The picture does not fit the TV screen.	"MONITOR TYPE" is not set correctly. The TV is not set correctly.	Set the monitor type correctly. (See page 58.) Set the TV correctly.
	No subtitle appears on the TV screen though you have selected as your initial subtitle language.	_____	Some DVDs are programmed to always display no subtitle initially. If this happens, press SUBTITLE on the remote control after starting play. (See page 41.)
	Audio language is different from the one you have selected as your initial audio language.	_____	Some DVDs are programmed to always use the original language initially. If this happens, press AUDIO on the remote control after starting play. (See page 42.)

PROBLEM	POSSIBLE CAUSE	SOLUTION	
A disc cannot be played.	No MP3 files are recorded on the disc.	Replace the disc.	MP3 Playback
	MP3 files do not have the file extension—.mp3, .Mp3, .mP3, or .MP3 in their file names.	Add the file extension—.mp3, .Mp3, .mP3, or .MP3—to their file names. (See page 51.)	
	MP3 files are not recorded in the format compliant with ISO 9660 Level 1 or 2.	Replace the disc. (Record MP3 files using a compliant application.)	
	The different types of files are recorded on a disc.	The disc which contains the different types of files may not be played because of its disc characteristics or recording conditions.	
Not MP3 files but JPEG files are played.	The MP3/JPEG setting is set to “JPEG.”	When both MP3 files and JPEG files are recorded on a disc, to play MP3 files, set the setting to “MP3.” (See page 58.)	
The MP3 control display appears on the TV screen, but any operation cannot be performed.	Any MP3 files or JPEG files are not recorded on the disc, or the disc is the unplayable disc (such as CD-ROM).	Replace the disc. (See page 6.)	
A disc cannot be played.	No JPEG files are recorded on the disc.	Replace the disc.	JPEG Playback
	JPEG files do not have the correct file extension in their file names.	Add the file extension—.jpg, .jpeg, .JPG, .JPEG or any uppercase and lowercase combination (such as “.Jpg”)—to their file names. (See page 53.)	
	JPEG files are not recorded in the format compliant with ISO 9660 Level 1 or 2.	Replace the disc. (Record JPEG files using a compliant application.)	
Not JPEG files but MP3 files are played.	The MP3/JPEG setting is set to “MP3.”	When both MP3 files and JPEG files are recorded on a disc, to play JPEG files, set the setting to “JPEG.” (See page 58.)	
Hard to listen to broadcast because of noise.	Antennas are disconnected.	Reconnect the antennas correctly and securely.	FM/AM
	The AM loop antenna is too close to the center unit.	Change the position and direction of the AM loop antenna.	
	The supplied FM antenna is not properly extended and positioned.	Extend the FM antenna at the best position.	
	Beat Cut mode is not set properly while listening to an AM broadcast.	Try to change the Beat Cut mode. (See page 32.)	
Continuous static during FM broadcasts.	The received signal is too weak.	Connect an external FM antenna (see page 11), or contact your dealer.	
	The station is too far away.	Select another station.	
One-touch DVD play does not work though you have connected AV COMPU LINK cord correctly.	AV COMPULINK MODE setting is incorrect.	Set it correctly according to the video input jack on the TV you use. (See page 67.)	Others
Suddenly, the system turns off by itself.	The Sleep or Auto Standby function is activated.	Turn the functions off. (See pages 24 and 62.)	
The indications on the moving panel is displayed upside-down.	DISP.SET selector is not set correctly.	Set it correctly. (See page 8.)	

NOTE:

Problems may be caused by the components connected to the system. So read also the manuals for the components carefully.

Aspect ratio

The ratio of vertical and horizontal sizes of a displayed image. The horizontal vs. vertical ratio of conventional TVs is 4:3, and that of wide-screens is 16:9.

Chapter

Refers to individual chapters included in a title.

Composite video signal

Refers to video signal comprised of three kinds of signals combined: an image signal made up of luminance and chrominance signals using the frequency multiplication technique; burst signal providing the basis for color reproduction; and synchronization signal.

Component video signal

A video signal system where parts of information necessary for reproducing image signal comprised of the three primary colors of light are transmitted via separate signal lines. Types of signal, such as R/G/B, Y/P_B/P_R, etc., are available.

Disc menu

A screen display prepared for allowing selection of images, sounds, subtitles, multiangles, etc. recorded on a DVD.

Interlaced scan

In the conventional video system, a picture is shown on the display monitor in two halves. The Interlaced scan system places lines of the second half of the picture in-between lines of the first half of the picture.

JPEG

A still-picture data compression system proposed by the Joint Photographic Expert Group, which features small decrease in image quality in spite of its high compression ratio.

Linear PCM (PCM: Pulse Code Modulation)

A system for converting analog sound signal to digital signal for later processing, with no data compression used in conversion.

Letter box

A method of displaying wide images like movies in the center of a 4:3 TV screen with no part of the image deleted, by placing black bands on the top and bottom of the screen. This name has resulted from the screen form looking literally like a letter box.

MP3

A file format with a sound data compression system. "MP3" is the abbreviation of Motion Picture Experts Group 1 (or MPEG-1) Audio Layer 3. By using MP3 format, one CD-R or CD-RW can contain about 10 times as much data volume as a regular CD can.

Multi-angle

By recording multiple scenes progressing at the same time in a single title, the user can select view angles. This feature is called the multiangle function.

Multichannel

DVD is specified to have each sound track constitute one sound field. Multichannel refers to a structure of sound tracks having three or more channels.

Multilanguage

When a title is created to cope with multiple languages, it is generally called a multilanguage title.

Parental lock

A feature of this system to automatically determine whether or not to reproduce particular DVD software by comparing its parental level (a measure of undesirability of scenes, etc. from educational viewpoint) set for the software beforehand with that set on this system by the user; if the software's level is less restrictive than the user-set level, it will be reproduced.

Playback control (PBC)

Refers to the signal recorded on video CDs or SVCDs for controlling reproduction. By using menu screens recorded on a Video CD or SVCD that supports PBC, you can enjoy interactive-type software as well as software having a search function.

Progressive scan

Progressive scan displays all the horizontal lines of a picture at one time, as a single frame. This system can convert the interlaced video from DVD into progressive format for connection to a progressive display. It dramatically increases the vertical resolution.

Region code

A system for allowing discs to be played back only in the regions designated beforehand. All the countries in the world are divided into six regions, each region being identified by a specified region code (or region number). If the region code given to a disc includes a numeral which matches one in the region code of a player, the player can play back the disc.

Surround

A system for creating three-dimensional sound fields full of realism by arranging multiple speakers around the listener.

Sampling frequency

Frequency of sampling data when analog data is converted to digital data. Sampling frequency numerically represents how many times the original analog signal is sampled per second.

Transfer rate

The rate of transferring digital data. Usually the measure is in baud per second. The DVD system applies a variable transfer rate system for high efficiency.

Specifications

■ Center unit (XV-THV70)

Audio section

Total Harmonic Distortion 0.02 %
 NOTE: This value is measured at System cord CONNECTOR for reference.

Audio input sensitivity/Impedance (at 1 kHz)

Analog input:
 AUX IN : 290 mV/47 k Ω

Digital input*:
 DIGITAL IN (OPTICAL): -21 dBm to -15 dBm (660 nm \pm 30 nm)

* Corresponding to Linear PCM, Dolby Digital, and DTS Digital Surround (with sampling frequency — 32 kHz, 44.1 kHz, 48 kHz)

Video section

Color System: NTSC/PAL selectable
 Horizontal Resolution: 500 lines
 Signal-to-Noise Ratio: 64 dB
 Output Level
 Composite: 1.0 V(p-p)/75 Ω
 S-video-Y: 1.0 V(p-p)/75 Ω
 S-video-C: 0.286 V(p-p)/75 Ω
 Component-Y: 1.0 V(p-p)/75 Ω
 Component-P_B/P_R: 0.7 V(p-p)/75 Ω

Tuner section

Tuning Range
 FM: 87.50 MHz – 108.00 MHz
 531 kHz – 1 602 kHz
 (at 9 kHz intervals)
 AM: 530 kHz – 1 600 kHz
 (at 10 kHz intervals)

General

Power Requirements: AC 230 V \sim , 50 Hz
 Power Consumption: 23 W (at operation)
 1.7 W (in standby mode)
 Dimensions** (W x H x D): 325 mm x 86 mm x 237 mm
 Mass**: 2.93 kg

** Without Stand and Legs

Dimensions for installation

Placed vertically

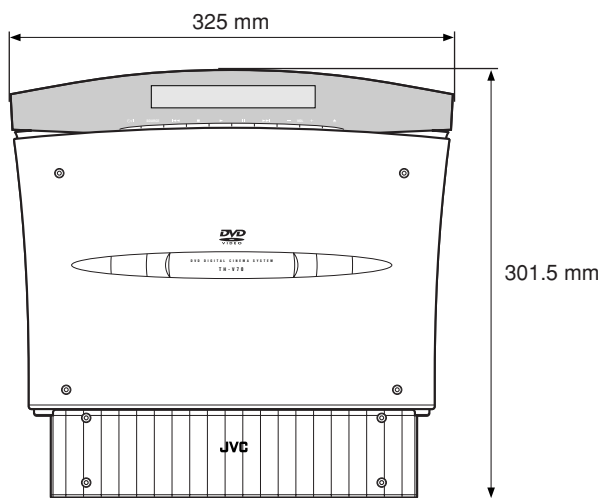

(On a wall)

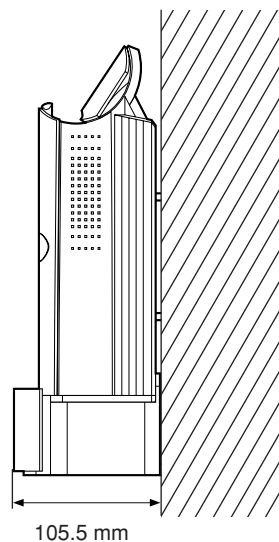

(With the legs)

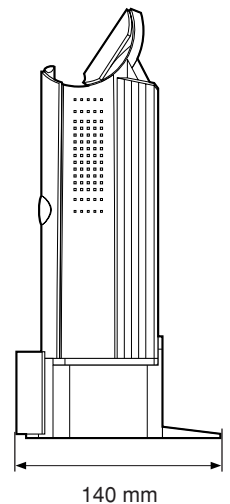

Placed horizontally

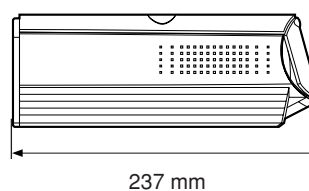
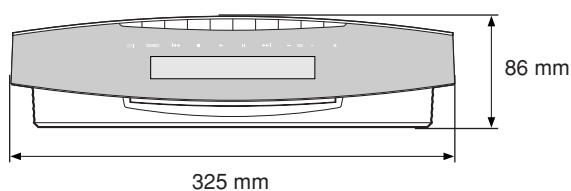

Specifications

■ Subwoofer (SP-PWV70)

Amplifier section

Front/Center/Rear:	30 W per channel, RMS at 4 Ω at 1 kHz, with 10 % total harmonic distortion.
Subwoofer:	140 W, RMS at 4 Ω at 100 Hz, with 10 % total harmonic distortion.
Speaker:	20 cm Bass-reflex, Magnetically Shielded
Power Requirements:	AC 230 V \sim , 50 Hz
Power Consumption:	120 W (at operation) 0 W (in standby mode)
Frequency Range:	25 Hz to 200 Hz
Dimensions (W \times H \times D):	240 mm \times 435 mm \times 496 mm
Mass:	16.5 kg

■ Satellite Speakers (SP-XSV70)

Speakers:	7 cm \times 4 cm Bass-reflex, Magnetically Shielded
Power Handling Capacity:	30 W
Impedance:	4 Ω
Frequency Range:	95 Hz to 20 kHz
Dimensions (W \times H \times D):	68 mm \times 134 mm \times 109 mm
Mass:	410 g

■ Center Speaker (SP-XCV70)

Speakers:	7 cm \times 4 cm Bass-reflex, Magnetically Shielded
Power Handling Capacity:	30 W
Impedance:	4 Ω
Frequency Range:	90 Hz to 20 kHz
Dimensions (W \times H \times D):	153 mm \times 70 mm \times 109 mm
Mass:	430 g

■ Accessories

Remote control (1)
Batteries (2)
Stand (1) (for the center unit)
Legs (2) (for the stand)
FM antenna (1)
AM loop antenna (1)
Power cord (1)
System cord (1)
Video cord (1)
AV COMPULINK cord (1)
Speaker cords
5 m (3): For the left front speaker, right front speaker, and center speaker
10 m (2): For the left rear speaker and right rear speaker (The length of the speaker cords above are approximate.)
Speaker wall brackets (2)
Screws
For the stand (1)
For the speaker wall brackets (2)
Paper pattern (1)

Designs & specifications are subject to change without notice.



Free Manuals Download Website

<http://myh66.com>

<http://usermanuals.us>

<http://www.somanuals.com>

<http://www.4manuals.cc>

<http://www.manual-lib.com>

<http://www.404manual.com>

<http://www.luxmanual.com>

<http://aubethermostatmanual.com>

Golf course search by state

<http://golfingnear.com>

Email search by domain

<http://emailbydomain.com>

Auto manuals search

<http://auto.somanuals.com>

TV manuals search

<http://tv.somanuals.com>