

# JVC

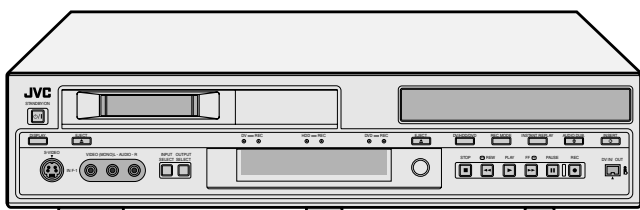

## Mini DV & HDD & DVD VIDEO RECORDER

# SR-DVM700ER



## INSTRUCTIONS

LPT1137-001A

# EN

# Safety Precautions

The rating plate and the safety caution are on the rear of the unit.

**WARNING: DANGEROUS VOLTAGE INSIDE**  
**WARNING: TO PREVENT FIRE OR SHOCK HAZARD, DO NOT EXPOSE THIS UNIT TO RAIN OR MOISTURE.**

**CAUTION:**

A UNIT IS A CLASS 1 LASER PRODUCT. HOWEVER THIS UNIT USES A VISIBLE LASER BEAM WHICH COULD CAUSE HAZARDOUS RADIATION EXPOSURE IF DIRECTED. BE SURE TO OPERATE THE UNIT CORRECTLY AS INSTRUCTED. WHEN THIS UNIT IS PLUGGED INTO THE WALL OUTLET, DO NOT PLACE YOUR EYES CLOSE TO THE OPENING OF THE DISC TRAY AND OTHER OPENINGS TO LOOK INTO THE INSIDE OF THIS UNIT. USE OF CONTROLS OR ADJUSTMENTS OR PERFORMANCE OF PROCEDURES OTHER THAN THOSE SPECIFIED HEREIN MAY RESULT IN HAZARDOUS RADIATION EXPOSURE. DO NOT OPEN COVERS AND DO NOT REPAIR YOURSELF. REFER SERVICING TO QUALIFIED PERSONNEL.

**IMPORTANT:**

- Please read the various precautions on page 2 and 3 before installing or operating the unit.
- It should be noted that it may be unlawful to re-record pre-recorded tapes, DVDs, or discs without the consent of the owner of copyright in the sound or video recording, broadcast or cable programme and in any literary, dramatic, musical, or artistic work embodied therein.

**CAUTION:**

- When you are not using the unit for a long period of time, it is recommended that you disconnect the power cord from the mains outlet.
- Dangerous voltage inside. Refer internal servicing to qualified service personnel. To prevent electric shock or fire hazard, remove the power cord from the mains outlet prior to connecting or disconnecting any signal lead or aerial.
- The mains plug shall remain readily operable.

CLASS 1 LASER PRODUCT  
 REPRODUCTION OF LABELS  
 WARNING LABEL INSIDE OF THE UNIT

CAUTION VISIBLE AND/OR INVISIBLE CLASS 1M LASER RADIATION WHEN OPEN, DO NOT STARE INTO BEAM OR VIEW DIRECTLY WITH OPTICAL INSTRUMENTS.	ATTENTION RAYONNEMENT LASER VISIBLE ET/OU INVISIBLE DE CLASSE 1M LORSQUE COUVERT. NE PAS FIXER LE FASCEAU NI REGARDER DIRECTEMENT AVEC DES INSTRUMENTS OPTIQUES.	ADVARSEL SYNLIG OG/ELLER USYNLIG KLASSE 1M LASERSTRÅLING VED ÅBNING. SE IKKE IND I STRÅLEN - HELLER IKKE MED OPTISKE INSTRUMENTER.	ADVARSEL SYNLIG OG/ELLER USYNLIG KLASSE 1M NÅR DEKSEL ÅPNES. IKKE STIRP INN I STRÅLEN ELLER SE DIREKTE MED OPTISKE INSTRUMENTER.	VARO! HÄTTÄSSÄ OLET ALTUINKÄ NÄKYVÄLLE JÄI TAI NÄKYMÄTTÖMÄLLE LUOKAN 1M LASERISÄTELYLLE. ÄLÄ KATSO SUORAAN SÄTEESEEN TAI TÄRKAESTELE SIFÄ OPTISEN LAITTEEN LÄPI.	VARNING SYNLIG OCH/ELLER OSYNLIG KLASS 1M NÅR DESKAN DEL ÄR ÖPPNAD. STIRRA EJ IN I STRÅLEN OCH BETRÄKTA EJ STRÅLEN MED OPTISKA INSTRUMENT.
---	--	--	---	--	---

OR

CAUTION CLASS 1M LASER RADIATION WHEN OPEN, DO NOT VIEW DIRECTLY WITH OPTICAL INSTRUMENTS.	ATTENTION EMET UN RAYONNEMENT LASER DE CLASSE 1M LORSQUE COUVERT. NE PAS REGARDER DIRECTEMENT A TRAVERS DES INSTRUMENTS OPTIQUES.	ADVARSEL KLASSE 1M LASERSTRÅLING NÅR ÅPNET. IKKE SE DIREKTE INN I OPTISKE INSTRUMENTER.	ADVARSEL KLASSE 1M LASERSTRÅLING NÅR APPARATET ÅPNES. KIG IKKE DIREKTE PÅ STRÅLEN MED OPTISKE INSTRUMENTER.	VARO! LUOKAN 1M LASERISÄTELY LÄITTEEN SISÄLLÄ. ÄLÄ KATSO SUORAAN OPTISELLA LAITTEELLA.	VARNING KLASS 1M LASERSTRÅLING NÅR DEN ÄR ÖPPEN. TITTA INTE DIREKT PÅ DEN MED OPTISKA INSTRUMENT.
---	--	--	--	--	---

This unit apply to the standard "IEC60825-1:2001" for laser products.



- Manufactured under licence from Dolby Laboratories. "Dolby" and the double-D symbol are trademarks of Dolby Laboratories.
- "DTS" and "DTS DIGITAL OUT" are trademarks of Digital Theater Systems, Inc.
- This unit plays back and records PAL and SECAM signals in PAL format. NTSC signals can also be played back on the DVD deck.
- This product incorporates copyright protection technology that is protected by U.S. patents and other intellectual property rights. Use of this copyright protection technology must be authorized by Macrovision, and is intended for home and other limited viewing uses only unless otherwise authorized by Macrovision. Reverse engineering or disassembly is prohibited.

The STANDBY/ON  $\odot$ /I button does not completely shut off mains power from the unit, but switches operating current on and off. " $\odot$ " shows electrical power standby and "I" shows ON.

When the equipment is installed in a cabinet or a shelf, make sure that it has sufficient space on all sides to allow for ventilation (10 cm or more on both sides, on top and at the rear).

When discarding batteries, environmental problems must be considered and the local rules or laws governing the disposal of these batteries must be followed strictly.

**Failure to heed the following precautions may result in damage to the unit, remote control or disc/cassette.**

1. **DO NOT place the unit** —
  - in an environment prone to extreme temperatures or humidity.
  - in direct sunlight.
  - in a dusty environment.
  - in an environment where strong magnetic fields are generated.
  - on a surface that is unstable or subject to vibration.
2. **DO NOT block the unit's ventilation openings or holes.** (If the ventilation openings or holes are blocked by a newspaper or cloth, etc., the heat may not be able to get out.)
3. **DO NOT place heavy objects on the unit or remote control.**
4. **DO NOT place anything which might spill on top of the unit or remote control.** (If water or liquid is allowed to enter this equipment, fire or electric shock may be caused.)
5. **DO NOT expose the apparatus to dripping or splashing.**
6. **DO NOT use this equipment in a bathroom or places with water.** Also **DO NOT** place any containers filled with water or liquids (such as cosmetics or medicines, flower vases, potted plants, cups, etc.) on top of this unit.
7. **DO NOT place any naked flame sources, such as lighted candles, on the apparatus.**
8. **AVOID violent shocks to the unit during transport.**

## MOISTURE CONDENSATION

Moisture in the air will condense on the unit when you move it from a cold place to a warm place, or under extremely humid conditions—just as water droplets form on the surface of a glass filled with cold liquid. In conditions where condensation may occur, disconnect the unit's power plug from the wall and keep it disconnected for a few hours to let the moisture dry, then turn on the unit.

## DISCLAIMER OF LIABILITY

JVC shall not be liable for any loss relating to the unit's failure to properly record, store or playback any content (video, audio or otherwise) for any reason whatsoever. Any applicable warranties shall only cover replacement or repair of the effected unit, and shall not apply to recovery or replacement of lost content.

## ATTENTION:

- Using a mobile phone in the vicinity of the unit may cause picture vibration on the TV screen or change the screen to a black back display.
- Some TVs or other appliances generate strong magnetic fields. Do not place such appliances on top of the unit as it may cause picture disturbance.
- When moving the product, press  $\odot$ /I to turn off the power, and wait at least 30 seconds before unplugging the power cord. Then, wait at least 2 minutes before moving the product.
- If there is a power outage when using the unit, the recorded data may be erased.
- It is recommended to back up discs which contain important recordings periodically (every few years). As digital signals do not deteriorate, failure to play back or record might arise due to the effects of the disc aging through the years depending on the storage environment.
- Recorded programmes and data cannot be restored once the disc or tape is damaged.

## Information for Users on Disposal of Old Equipment

### [European Union]

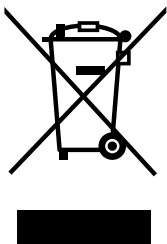

This symbol indicates that the electrical and electronic equipment should not be disposed as general household waste at its end-of-life. Instead, the product should be handed over to the applicable collection point for the recycling of electrical and electronic equipment for proper treatment, recovery and recycling in accordance with your national legislation.

By disposing of this product correctly, you will help to conserve natural resources and will help prevent potential negative effects on the environment and human health which could otherwise be caused by inappropriate waste handling of this product. For more information about collection point and recycling of this product, please contact your local municipal office, your household waste disposal service or the shop where you purchased the product.

Penalties may be applicable for incorrect disposal of this waste, in accordance with national legislation.

### ATTENTION:

This symbol is only valid in the European Union.

### (Business users)

If you wish to dispose of this product, please visit our web page [www.jvc-europe.com](http://www.jvc-europe.com) to obtain information about the take-back of the product.

### [Other Countries outside the European Union]

If you wish to dispose of this product, please do so in accordance with applicable national legislation or other rules in your country for the treatment of old electrical and electronic equipment.

<b>SAFETY FIRST</b>	<b>2</b>	<b>EDITING</b>	<b>44</b>
Safety Precautions .....	2	Dubbing .....	44
<b>DISC INFORMATION</b>	<b>5</b>	DV Dubbing (HDD & DVD Deck Only) .....	48
About Discs .....	5	Edit From A Camcorder .....	50
Life Span Of Parts .....	9	Edit To Or From Another Recorder .....	51
<b>INDEX</b>	<b>10</b>	Dubbing DV Format Contents To A DV Device (HDD Deck Only) .....	52
<b>INSTALLING YOUR NEW UNIT</b>	<b>16</b>	Digital Audio Dubbing .....	52
Basic Connections .....	16	Audio Dubbing (DV Deck Only) .....	53
<b>INITIAL SETTINGS</b>	<b>17</b>	Insert Editing (DV Deck Only) .....	54
Clock Set .....	17	<b>REMOTE CONTROL</b>	<b>55</b>
Language .....	18	Remote Control Functions .....	55
Monitor Set .....	19	<b>SYSTEM CONNECTIONS</b>	<b>56</b>
<b>BASIC OPERATIONS ON DVD DECK</b>	<b>20</b>	Connecting To A Dolby Digital Decoder Or An Amplifier With Built-in DTS .....	56
Basic Playback .....	20	<b>SUBSIDIARY SETTINGS</b>	<b>57</b>
Playback Features .....	21	Mode Set .....	57
Using The On-screen Bar .....	25	Format A Disc (DVD Deck Only) .....	60
<b>BASIC OPERATIONS ON HDD DECK</b>	<b>29</b>	Finalise A Disc (DVD Deck Only) .....	61
Basic Playback .....	29	User-Customisable Background And Text Colour .....	63
Playback Features .....	29	Setting The Background And Text Colour .....	64
<b>BASIC OPERATIONS ON DV DECK</b>	<b>31</b>	Scan Mode Set (HDD & DVD Deck Only) .....	65
Basic Playback .....	31	Tray Lock (DVD Deck Only) .....	65
Playback Features .....	32	Mode Lock .....	65
<b>LIVE MEMORY PLAYBACK ON HDD/DVD DECK</b>	<b>33</b>	Last Function Memory .....	65
Live Memory Playback .....	33	<b>TROUBLESHOOTING</b>	<b>66</b>
<b>NAVIGATION ON HDD/DVD DECK</b>	<b>36</b>	<b>APPENDIX</b>	<b>69</b>
Library Database Navigation .....	36	<b>RS-232C INTERFACE</b>	<b>70</b>
Edit Original Information .....	37	RS-232C Interface – Command Table – .....	70
Edit Play List Information .....	40	RS-232C Interface – Specifications – .....	70
Navigate Library Information .....	42	RS-232C Interface – Command – .....	71
Playback With MP3/WMA/JPEG Navigation .....	43	<b>SPECIFICATIONS</b>	<b>82</b>
		<b>LIST OF TERMS</b>	<b>83</b>



## HOW TO USE THIS INSTRUCTION MANUAL

- All major sections and subsections are listed in the Table Of Contents on page 4. Use this when searching for information on a specific procedure or feature.
- The Index on pages 10 – 13 illustrates the controls and connections on the front and rear panel, the front display panel and the remote control.
- The list of terms on page 83 lists frequently-used terms, and the number of the page on which they are used or explained in the manual.
- The  mark signals a reference to another page for instructions or related information.
- Operation buttons necessary for the various procedures are clearly indicated through the use of illustrations at the beginning of each major section.

# About Discs

## Recordable/Playable Discs

You can use discs with the following logos for recording and playback.

 <p><b>DVD-RAM</b> 12 cm: 4.7 GB/9.4 GB 8 cm: 1.4 GB/2.8 GB Ver. 2.0/2x speed Ver. 2.1/1x – 3x speed</p>	 <p><b>DVD-RW</b> 12 cm: 4.7 GB/9.4 GB Ver. 1.1/1x – 2x speed (Video mode/VR mode) Ver. 1.2/4x speed (Video mode/VR mode)</p>
 <p><b>DVD-R</b> 12 cm: 4.7 GB 8 cm: 1.4 GB Ver. 2.0/1x – 4x/8x speed (Video mode/VR mode) Ver. 2.1/16x speed (Video mode/VR mode)</p>	

- The above table is based on the information as of June 2006.
- Recording and playback may not be performed depending on the characteristics and condition of the disc used, leading to unsatisfactory results. Using discs manufactured by JVC is recommended since they have been tested to be compatible with this unit.

### DVD-RAM Discs

It is only possible to use discs which conform with DVD-RAM standard Version 2.0 or 2.1.

- It is impossible to record on DVD-RAM discs which do not conform to this standard. If you use a disc formatted under a different standard version, format it on this unit before use.
- It may not be possible to record, play back, edit or dub a DVD-RAM disc even if it conforms to the standard if it was recorded or edited on the devices from other manufacturers or on a PC, or if it has far too many titles, or if there is very little available capacity remaining on the disc.
- DVD-RAM discs recorded on this unit cannot be played back on an incompatible DVD player.
- It is possible to record copy-once programmes of digital broadcasts only onto 4.7/9.4 GB DVD-RAM discs (2.8 GB DVD-RAM discs are not compatible).

### DVD-R/RW Discs

It is only possible to use DVD-R discs which conform with DVD-R standard Version 2.0.

When a DVD-R/RW disc (Video mode) is finalised (see pg. 61), it can be played back on a standard DVD player as a DVD VIDEO disc.

When a DVD-R/RW disc (VR mode) is finalised (see pg. 61), it can be played back on a standard DVD player compatible with the VR mode of DVD-R/RW discs.

#### Before finalising —

- it is possible to record on unrecorded areas of the disc, edit the disc title and programme titles, and delete programmes.
- It is impossible to record or edit DVD-R/RW discs recorded on other devices even if they have not been finalised.
- It is impossible to overwrite recorded areas of DVD-R discs.
- Available recording capacity does not increase even if a recorded programme is deleted from a DVD-R disc.

#### After finalising —

After a DVD-R/RW disc (Video mode) has been finalised, it is possible to play back the recorded programmes (video and/or audio) on a standard DVD video player as a DVD VIDEO disc.

- Edited titles are displayed as the “DVD menu” in video mode.
- It is impossible to record, edit or delete the data either in video mode or in VR mode.
- Either in video mode or in VR mode, although the disc can be played back on DVD players from other manufacturers, sometimes it may not be possible to play back depending on the disc and recording conditions.
- It is impossible to record on CD-R/RW or DVD-R discs used for authoring.
- It is impossible to record onto DVD-R/RW (Video mode) discs broadcasts that allow you to copy once. The copy once programmes can only be recorded onto DVD-R/RW discs formatted in VR mode.

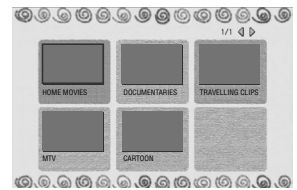











#### NOTES:

- The following may result if you play back a DVD-R disc recorded on another unit.
  - The disc does not play.
  - A mosaic pattern (block noise) appears on the screen.
  - Video or audio may be dropped out.
  - The unit stops during playback.
- 6x speed DVD-RW disc cannot be used on this unit.

## Discs For Playback Only

You can use discs with the following logos for playback only.

 DVD VIDEO (example of region code indications)  	Video CD/Super Video CD    
 Audio CD CD-DA files	 CD-R CD-DA/JPEG/ MP3/WMA files
 CD-RW CD-DA/JPEG/ MP3/WMA files	 CD-ROM JPEG/MP3/ WMA files

- Playback may not be performed depending on the characteristics and condition of the disc used.
  - DTS Audio CDs can also be played back (An optional DTS decoder is required).
  - MP3 and JPEG discs can be played back on this unit only when they have been recorded in the ISO9660 or Joliet format and finalised.
  - JPEG files that can be played back on this unit must conform to JFIF/Baseline process, and the maximum resolution of a JPEG file is 2,812 pixels in width and 2,112 pixels in height.
  - CD-R/RW discs recorded in music CD format need to be finalised to play back on this unit.
  - Operation and audio quality of this unit are not guaranteed for discs that do not conform to the Compact Disc specification (CD-DA).
- Before you play back a CD, check for the CD logo and read the notes on the package to confirm that it conforms to the Compact Disc specification.
- Depending on the intentions of the author of the software, recording conditions of DVD discs and Video CD/SVCD discs may be restricted. Since this unit plays back discs according to the intentions of the author of the software as indicated on the disc, some functions may not operate as commanded.
  - When switching from the first layer to the second layer of double-layered DVD VIDEO discs, the image and sound may be momentarily distorted. This is not a malfunction.
  - DVD-AUDIO discs compatible with DVD video players can be played.
  - Super Audio CDs (SACD) compatible with conventional CD players can be played.
  - +R/+RW discs recorded and finalised in Video mode can be played. "DVD" will light on the front display panel.

## Unplayable Discs

The following types of discs cannot be played using this unit. Do not attempt to play back any kind of disc that is damaged (cracked, warped, or repaired with adhesive tape) or discs in unusual shapes (heart-shaped, octagonal, or other forms). If such discs are accidentally played back, it may cause noise that can lead to speaker damage.

- CD-ROM discs (including PHOTO-CD and CD-G)
- Discs recorded in Packet Write (UDF) format
- 1.3-GB double density CDs (DDCD)
- High density CDs (HDCD)

**The following discs also cannot be played back.**

- Discs of a region number other than "5"
- DVD-RAM (2.6 GB/5.2 GB)
- DVD-RAM (TYPE1)

### Caution for DualDisc playback

The Non-DVD side of a "DualDisc" does not comply with the "Compact Disc Digital Audio" standard. Therefore, the use of Non-DVD side of a DualDisc on this product may not be recommended.

## Region Number

The world is divided into 6 regions for DVD VIDEO discs. DVD VIDEO discs are assigned a region number to indicate which region they may be played back in. A disc cannot be played back on this unit unless the region number of the disc matches that of the unit. The region number for this unit is "5". Only discs whose region number includes "5" or "ALL" can be played back such as shown below.

**Examples of DVD VIDEO labels which can be played back using this unit.**



### Marks of discs in this instruction manual

	Allows operation with a DVD-RAM disc.		Allows operation with a Video CD/Super Video CD (SVCD) disc.
	Allows operation with a DVD-R disc.		Allows operation with an Audio CD disc.
	Allows operation with a DVD-RW disc.		Allows operation with a disc including MP3 files.
	Allows operation with a DVD VIDEO disc.		Allows operation with a disc including JPEG files.

## Recording Medium And Format

### DVD-RAM

- Recording and erasing can be performed as many times as possible on a disc.
- Editing can be performed after recording, such as deleting unwanted parts.
- While recording, it is possible not only to start playback of a programme currently being recorded, but also to watch another programme previously recorded.

### DVD-RW (VR mode)

- Recording and erasing can be performed as many times as possible on a disc.
- Editing can be performed after recording, such as deleting unwanted parts.
- Recording of copy once programmes are possible using a CPRM compatible disc.

### DVD-RW (Video mode)

- Can be played back on other DVD players.
- New recording can be performed by erasing all the data on a disc once played back.

### DVD-R (VR mode)

- Editing can be performed after recording, such as deleting unwanted parts.
- Recording of copy once programmes are possible using a CPRM compatible disc.

### DVD-R (Video mode)

- Can be played back on other DVD players.
- Suitable when keeping a recorded disc for a long time.

## File Structure Of Discs

### DVD VIDEO

Typically, DVD VIDEO discs are made up of larger units called "titles". Each title has a number (title number) that can be used to select desired titles. Titles are further divided into units called "chapters". Each chapter has a number (chapter number) that can also be used to select desired chapters. Note that some discs are not divided into titles and chapters.

### When you record a programme on a DVD-RAM/R/RW (VR mode) disc

A single recording session results in a single title (a single chapter). However, chapter marks are automatically inserted when recording is paused, or audio changes from monaural to stereo due to commercial breaks, etc. It is also possible to insert chapter marks at desired locations during playback. (pg. 23)

### When you record a programme on a DVD-R/RW (Video mode) disc

A single recording session results in a single title (a single chapter). However, chapter marks are automatically inserted when recording is paused, or audio changes due to commercial breaks, etc. It is also possible to insert chapter marks at desired locations during either recording or playback. Once the disc has been finalised, these chapter marks are deleted and new chapter marks are assigned automatically approximately every 5 minutes.

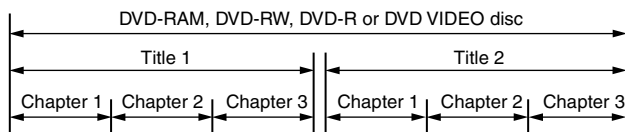

- In Video mode, even before finalising, it is impossible to perform editing operations other than changing the disc name and/or title names and deleting programmes and/or titles.
- After finalising, it is impossible to perform editing operations.

### Audio CD/Video CD/SVCD

Typically, Audio CD discs are divided into separate tracks each containing one song. Each track is assigned a number. For example, the third track is Track 3. The same is true for Video CD/SVCD discs.

However, some discs are not divided into tracks.

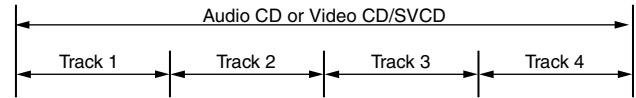

### JPEG/MP3 Disc (CD-R/RW/ROM)

MP3/JPEG files put in directories nested in several levels on a disc will be organized as if they were put in single level directories (groups) by the MP3/JPEG Navigation of this unit. (pg. 43)

### File structure of a disc before starting the MP3/JPEG Navigation

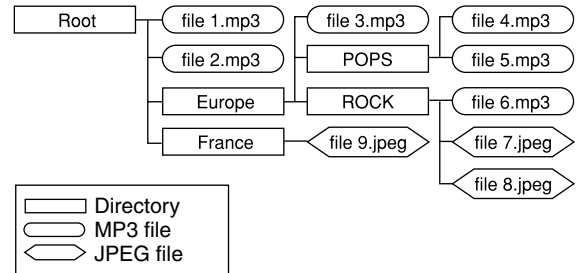

### File structure of the disc after starting the MP3/JPEG Navigation

Files are automatically grouped as follows and displayed on the MP3/JPEG Navigation screen. Data is displayed in the alphabetical order of file name. Files are grouped based on roots.

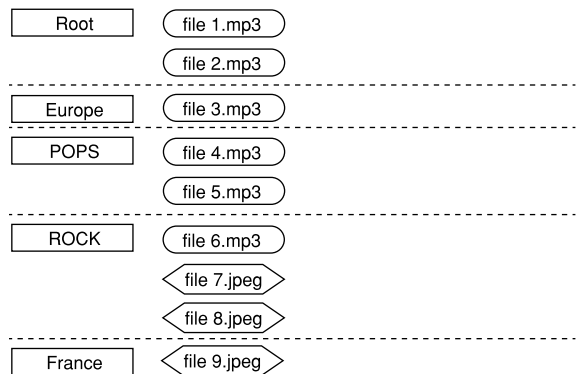

- This unit can recognise up to 9 hierarchies including directories and files. Also, it can recognise up to 250 files in each group, and up to 99 groups on a disc.









### NOTES:

- **Video CD/SVCD discs that support Playback Control (PBC)**  
The contents of a disc are recorded into several hierarchies, and played back according to the instructions on the screen while navigating through the hierarchies. It is also possible to playback recorded tracks consecutively without activating the PBC function even when playing a PBC-compatible disc. (pg. 24)
- **Regarding the contents recorded on discs**  
Some files may not be played back depending on the file types and other factors.



## DVD VIDEO Marks

Sometimes marks are printed on a DVD disc and/or on its packaging to indicate information regarding the contents and functions of the disc. Check the marks indicating the contents and functions of the disc. Note, however, that in some cases a disc may not include a mark even for a function it supports.

### Marks related to video

	Number of subtitles		Number of angles
	Recorded under the standard 4:3 aspect ratio		Screen includes black bands at the top and the bottom of image which has a standard 4:3 aspect ratio (letter box)
 	Video playback is in Wide video mode (16:9) on wide televisions, but in letter box on televisions with standard 4:3 aspect ratio.		
 	Video playback is in Wide video mode (16:9) on wide televisions, but pan and scan is used on televisions with standard 4:3 aspect ratio (either the left or right side of the image is cut-out).		

### Marks related to audio

	Number of audio tracks
	Dolby Digital Stereo Creator mark Developed by Dolby Laboratories. It enables audio recording in high-quality stereo Dolby Digital.
	DTS (Digital Theater Systems) You can enjoy DTS audio if you connect an amplifier with a built-in DTS decoder to the DIGITAL OUT connector of the unit.

## Placing A Disc

### Opening the disc tray

Press  to open the disc tray.

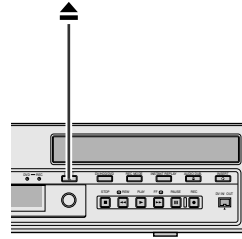

- Pressing the button again closes the disc tray.
- Use the button to open and close the disc tray.
- Do not block the disc tray with your hand while it is opening or closing as this may result in hardware failure.
- Do not place unplayable discs or any object other than a disc on the disc tray.
- Do not press down strongly on the disc tray or place any heavy objects on it.

### Discs without cartridges

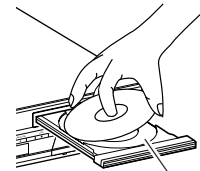

Disc tray

Place the disc on the disc tray with the label side facing up. Since disc size changes depending on the disc to be played back, be sure to correctly align the disc with the grooves for its size. If the disc is not in its groove, it may be scratched or otherwise damaged. To insert an 8 cm disc, place it according to the inner groove.

### DVD-RAM discs contained in cartridges

#### Double-sided discs:

Remove the disc from the cartridge. Align the disc with the grooves on the disc tray as shown in the illustration and insert with the side you wish to play back or record facing down. If you insert the disc with "Side A" facing down, programmes are recorded on the side A.

#### Single-sided discs:

Remove the disc from the cartridge. Align the disc with the grooves on the disc tray as shown in the illustration and insert with the label side facing up.



## Care And Handling Of Discs

### How to handle discs

When handling a disc, do not touch the surface of the disc. Since discs are made of plastic, they are easily damaged. If a disc gets dirty, dusty, scratched or warped, the images and sound will not be picked up correctly, and such a disc may cause the unit to malfunction.

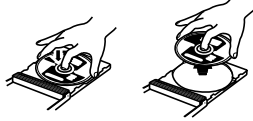

### Label side

Do not damage the label side, stick paper to or use any adhesives on its surface.

### Recording side

Make sure that discs are not scratched or dirty on the recording side before use. Scratches and dirt on the recording side of a disc may hinder proper playback and recording. Also be careful that a DVD-RAM disc may get scratched or dirty when removed from cartridge then put back in after use.

### Storage

Make sure that discs are kept in their cases. If discs are piled on top of one another without their protective cases, they can be damaged. Do not put discs in a location where they may be exposed to direct sunlight, or in a place where the humidity or temperature is high. Avoid leaving discs in your car!

### Maintenance of discs

If there are fingerprints or other dirt adhering to a disc, wipe with a soft dry cloth, moving from the centre outwards.

If a disc is difficult to clean, wipe with a cloth moistened with water. Never use record cleaners, petrol, alcohol or any anti-static agents.



### CAUTION:

Sometimes during playback, noise may appear or images may be garbled. This is sometimes due to the disc. (It may not be up to industry standards.)

These symptoms are caused by the discs, not by the malfunction of the unit.

## Life Span Of Parts

### Cooling fan

Periodical inspection and maintenance are requisite to maintain the initial performance and reliability of the product. We recommend the exchange of the fan motor every three years.

### HDD

The HDD is a consumable part. Please arrange for maintenance after an estimated usage of 10,000 hours (this estimation is based on usage under the environment of 25°C, it may differ depending on the usage environment).

Please consult your authorised dealer or nearest JVC service centre on the maintenance and cost.

## Front View

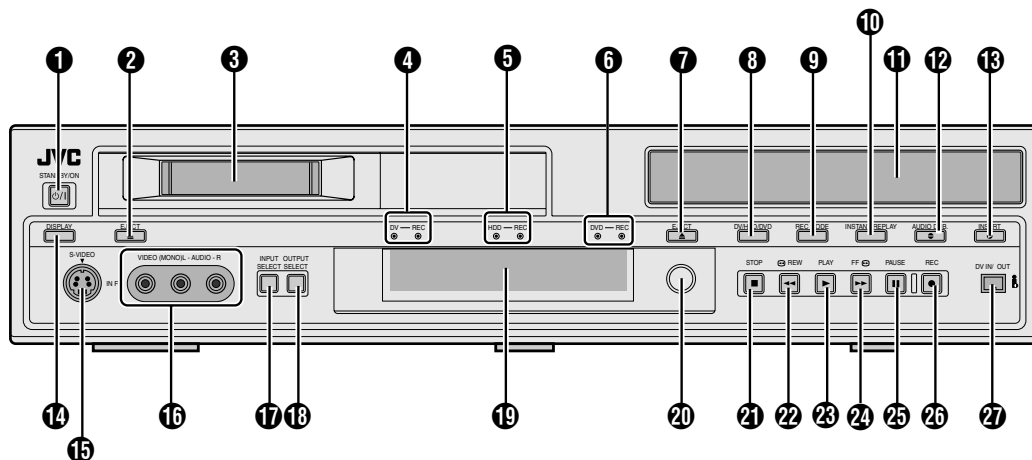

- 1 **STANDBY/ON Button** (⏻/⏻) pg. 31
- 2 **Eject Button** (⏏) (DV) pg. 31
- 3 **Mini DV Cassette Loading Slot**
- 4 **DV Lamp (DV)** pg. 31
- 5 **DV Recording Lamp (REC)**
- 6 **HDD Lamp (HDD)** pg. 18
- 7 **HDD Recording Lamp (REC)**
- 8 **DVD Lamp (DVD)** pg. 18, 20
- 9 **DVD Recording Lamp (REC)**
- 10 **Eject Button** (⏏) (DVD) pg. 8
- 11 **DV/HDD/DVD Select Button (DV/HDD/DVD)** pg. 20, 29, 31
  - This button will not function during navigation mode or set up mode.
- 12 **Recording Mode Button (REC MODE)** pg. 48
- 13 **Instant Replay Button (INSTANT REPLAY)** pg. 22, 30, 32
- 14 **Disc Tray**
- 15 **Audio Dubbing Button (AUDIO DUB.)** pg. 53
- 16 **Insert Button (INSERT)** pg. 54
- 17 **Display Button (DISPLAY)** pg. 23
- 18 **S-video Input Connector [S-VIDEO]** pg. 50
- 19 **Video/Audio Input Connectors [VIDEO/AUDIO ((MONO) L/R)]** pg. 50
- 20 **Input Select Button (INPUT SELECT)** pg. 48, 50

### 21 **Output Select Button (OUTPUT SELECT)**

- Switches between “ALL” (DV/HDD/DVD output) and “DV” (DV output) when pressed. When “ALL” is selected, DV, HDD or DVD signals are output from the [DV/HDD/DVD OUTPUT] connectors on the rear panel depending on the deck selected. When “DV” is selected, DV signals are output regardless of the deck selected.

#### ATTENTION:

If “DV” is selected, “DV” and “OUTPUT DV” blink on the front display panel and TV screen respectively when **EDIT** or **NAVIGATION** is pressed while in the HDD/DVD deck mode. Press **OUTPUT SELECT** to stop the blinking and return to the previous display.

- 21 **Front Display Panel** pg. 12
- 22 **Infrared Beam Receiving Window**
- 23 **Stop Button** (■) pg. 20, 29
- 24 **Reverse Search Button** (◀◀) (HDD & DVD deck) pg. 21, 34
- 25 **Rewind Button** (◀◀) (DV deck) pg. 31, 32
- 26 **Play Button** (▶) pg. 20, 29
- 27 **Forward Search Button** (▶▶) (HDD & DVD deck) pg. 21, 34
- 28 **Fast Forward Button** (▶▶) (DV deck) pg. 31, 32
- 29 **Pause Button** (||) pg. 20, 29
- 30 **Record Button** (●)
- 31 **DV Input/Output Connector [DV IN/OUT (i.Link)]** pg. 48
  - This connector can also be used as a direct connection to NLE (Non-Linear Editing) systems or to a PC for downloading, editing and archiving.
  - \* i.Link refers to the IEEE1394-1995 industry specification and extensions thereof. The i.Link logo is used for products compliant with the i.Link standard.

## Rear View

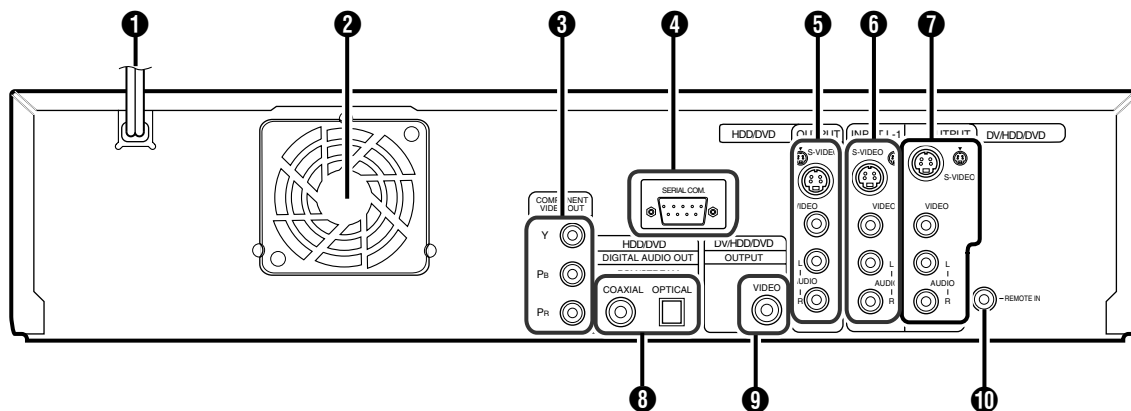
**1 AC Power Cord** pg. 16**2 Cooling Fan**

- This prevents the temperature from rising inside the unit. Do not remove it.
- Install the unit so as not to block the area around the fan.
- The unit may become hot when it is turned off, as the cooling fan on the rear of the unit is not activated. However, the cooling fan may be activated in the standby mode when "QUICK STARTUP" is set to "ON".

**3 Component Video Output Connectors [COMPONENT VIDEO OUT (Y/Pb/Pr)] (HDD & DVD deck only)** pg. 16**4 Serial Command Connector (D-SUB 9-PIN) [SERIAL COM.]** pg. 70

- Use this connector when controlling this unit via a computer. The cable to be used should be a RS-232C interface cable (straight type). For details on the RS-232C interface command, refer to page 70.

**5 S-VIDEO/VIDEO/AUDIO OUTPUT Connectors (HDD & DVD deck only)**

- These connectors only output DVD/HDD signals and can be used to connect to a second monitor.

**6 S-VIDEO/VIDEO/AUDIO INPUT Connectors (L-1)** pg. 51**7 S-VIDEO/VIDEO/AUDIO OUTPUT Connectors** pg. 16**8 Digital Audio Output Connectors [DIGITAL AUDIO OUTPUT (OPTICAL/COAXIAL)] (HDD & DVD deck only)** pg. 52, 56**9 BNC Video Output Connector [VIDEO OUTPUT]** pg. 16**10 Remote Input Connector\* [REMOTE IN]**

\* There is currently no compatible remote control unit available.

## Front Display Panel

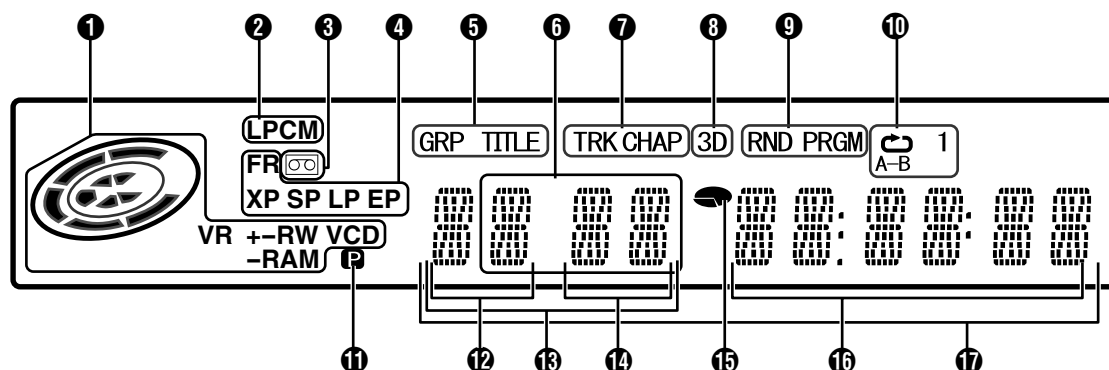
**1 Disc Type Indicator**

When a disc is loaded, the type of the disc is indicated.

**Disc Status Indicator**

When a disc is running, the disc marks rotate.

**VR Mode Indicator (VR)** [pg. 60](#)

Lights when a DVD-R/RW disc is formatted in VR mode.

**2 Linear PCM Indicator (LPCM)**

Lights when "XP MODE REC AUDIO" is set to "LINEAR PCM" ([pg. 58](#)) for recording with HDD, DVD-RAM, DVD-R and DVD-RW discs, and when Linear PCM audio is played.

**3 Cassette Loaded Mark (FR)**

Indicates the present of a cassette in the DV deck.

Lights when a cassette is loaded into the DV deck. It will remain lit as long as the cassette is loaded, even if the HDD or DVD deck is being selected.

**4 Recording Mode Indicator (XP/SP/LP/EP/FR)** [pg. 49](#)

Blinks when recording mode is being set.

While "FR" is blinking, the left 3 digits of the Multi Display (**17**) indicate setting values ranging from "60" to "480". After the value has been set, only "FR" lights.

**5 Group/Title Indicator (GRP/TITLE)**

"GRP" or "TITLE" lights depending on a disc loaded while the left 2 digits of the Multi Display (**12**) indicate the numbers explained below.

"GRP": Total number of groups or group number being played back are displayed on the Multi Display.

"TITLE": Total number of titles or title number being played back are displayed on the Multi Display.

**6 External Input Indicator**

Indicates the external input selected.

**7 Track/Chapter Indicator (TRK/CHAP)**

"TRK" or "CHAP" lights depending on a disc loaded while the 3rd and 4th digits from the left of the Multi Display (**14**) indicate the numbers explained below.

"TRK": Total number of tracks or track number being played back are displayed on the Multi Display.

"CHAP": Chapter number being played back are displayed on the Multi Display.

**8 Simulated Surround Effect Indicator (3D)** [pg. 27](#)

Lights when a simulated surround effect is set to "3D-ON" on the on-screen bar.

**9 Random/Programme Playback Mode Indicator (RND/PRGM)** [pg. 28](#)

"RND": Lights when Random Playback mode is set.

"PRGM": Lights when Programme Playback mode is set.

**10 Repeat Mode Indicator (A-B/1)** [pg. 25](#)

Select Repeat Playback mode on the on-screen bar.

"A-B": Whole disc is played back repeatedly.

"1": A single title/chapter/track is played back repeatedly.

"A-B": The selected part (A-B) is played back repeatedly.

No display: Repeat Playback mode is off.

**11 Video Output Indicator (P)** [pg. 65](#)

No display: Indicates that interface mode is engaged.

"P": Indicates that progressive mode is engaged.

(Example) "P" lights when video output mode is in progressive mode.

**12 Group/Title Number Display****13 Audio Dubbing/Insert Editing Indicator**

"ADUB" or "INS" lights up during Audio Dubbing or Insert Editing respectively.

**14 Track/Chapter Number Display****15 Remaining Time/Elapsed Time Indicator** [pg. 23](#)

Lights when remaining time of HDD, DVD-RAM, DVD-R and DVD-RW discs is displayed, and lights out when elapsed time is displayed.

The right 6 digits of the Multi Display (**16**) indicate elapsed or remaining time of each track.

No display: Indicates elapsed time of the disc.

Displayed: Indicates remaining time of the disc.

**16 Remaining Time/Elapsed Time Display** [pg. 23](#)**Time Code Display** [pg. 32](#)**17 Multi Display**

Displays clock, received channel, elapsed time, and remaining time.

Also displays status of the unit (NO DISC/OPEN/CLOSE/READING).

## Remote Control

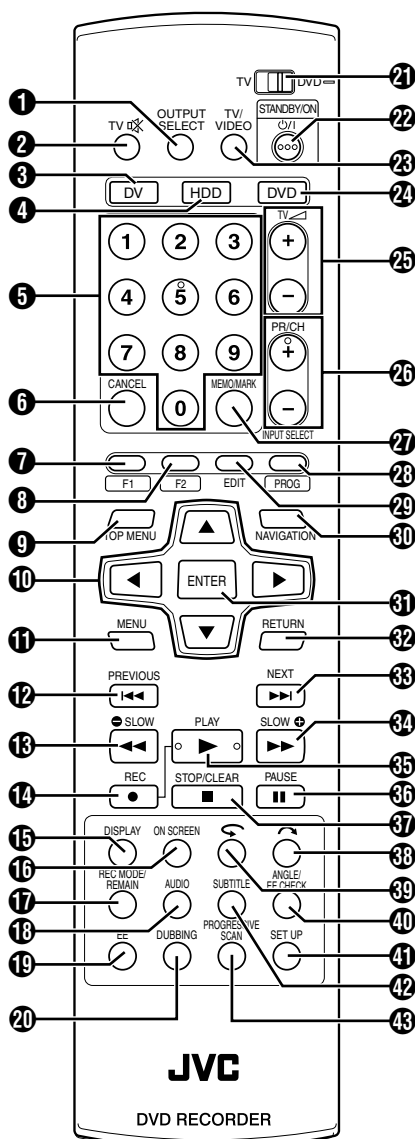
**1 Output Select Button (OUTPUT SELECT)**

- Switches between "ALL" (DV/HDD/DVD output) and "DV" (DV output) when pressed. When "ALL" is selected, DV, HDD or DVD signals are output from the [DV/HDD/DVD OUTPUT] connectors on the rear panel depending on the deck selected. When "DV" is selected, DV signals are output regardless of the deck selected.

**ATTENTION:**

If "DV" is selected, "DV" and "OUTPUT DV" blink on the front display panel and TV screen respectively when **EDIT** or **NAVIGATION** is pressed while in the HDD/DVD deck mode. Press **OUTPUT SELECT** to stop the blinking and return to the previous display.

**2 TV Muting Button (TV MUTE)** pg. 55**3 DV Button\*** pg. 31

\* This button will not function during navigation mode or set up mode.

**4 HDD Button\*** pg. 29

\* This button will not function during navigation mode or set up mode.

**5 Number Keys** pg. 55**6 Cancel Button (CANCEL)** pg. 28**7 F1 Button** pg. 65**8 F2 Button** pg. 61, 62**9 Top Menu Button (TOP MENU)** pg. 21**10 Selection Keys (Δ▽◀▶)** pg. 17**11 Menu Button (MENU)** pg. 21**12 Reverse Skip Button (◀◀)** pg. 21, 30, 34

Previous Button (PREVIOUS) pg. 24

**13 Reverse Search Button (◀◀) (HDD & DVD deck)** pg. 21, 34

Rewind Button (◀◀) (DV deck) pg. 31

Reverse Slow Button (SLOW-) pg. 21

**14 Record Button (●)****15 Display Button (DISPLAY)** pg. 23, 32**16 On-Screen Button (ON SCREEN)** pg. 14, 25**17 Recording Mode Button (REC MODE)** pg. 48

Remain Button (REMAIN) pg. 23

**18 Audio Button (AUDIO)** pg. 24**19 EE Button** pg. 34**20 Dubbing Button (DUBBING)** pg. 44**21 TV/DVD switch** pg. 18, 55**22 STANDBY/ON Button (⏻/⏻)****23 TV/VIDEO Button** pg. 55**24 DVD Button\*** pg. 20

\* This button will not function during navigation mode or set up mode.

**25 TV Volume Buttons (TV ▲/▼)** pg. 55**26 TV Programme Buttons (PR/CH +/-)** pg. 55**27 Input Select Button (INPUT SELECT +/-)** pg. 48, 50**28 Memo Button (MEMO)** pg. 37, 41**29 Mark Button (MARK)** pg. 23**28 Programming Button (PROG):** Not use on this unit.**29 Edit Button (EDIT)** pg. 37**30 Navigation Button (NAVIGATION)** pg. 36, 43**31 Enter Button (ENTER)** pg. 18**32 Return Button (RETURN)** pg. 24, 26**33 Forward Skip Button (▶▶)** pg. 21, 34**34 Next Button (NEXT)** pg. 24**34 Forward Search Button (▶▶) (HDD & DVD deck)** pg. 21, 34

Fast Forward Button (▶▶) (DV deck) pg. 31

Forward Slow Button (SLOW+) pg. 21

**35 Play Button (▶)** pg. 20, 29**36 Pause Button (⏸)** pg. 20, 29**37 Stop Button (■)** pg. 20, 29**38 Clear Button (CLEAR)** pg. 28**38 Skip Search Button (↶)** pg. 22, 29, 32, 34**39 Instant Replay Button (↶)** pg. 22, 30, 32, 34, 35**40 Angle Button (ANGLE) (DVD deck only)** pg. 23**EE Check Button (EE CHECK)** pg. 34**41 Set Up Button (SET UP)** pg. 18, 57**42 Subtitle Button (SUBTITLE)** pg. 24**43 Progressive Scan Button (PROGRESSIVE SCAN)** pg. 65**How To Use**

Before use, insert two R6 size batteries into the remote control with the polarity (+) and (-) matched correctly as indicated on the battery compartment or on the lid.

The remote control can operate most of your unit's functions, as well as basic functions of TV sets of JVC and other brands. (pg. 55)

- Point the remote control toward the receiving window.

- The maximum operating distance of the remote control is about 8 m.

**NOTE:**

If the remote control doesn't work properly, remove its batteries, wait a short time, replace the batteries and then try again.

## On-Screen Display (HDD & DVD deck)

When "SUPERIMPOSE" is set to "ON" or "AUTO" and **ON SCREEN** on the remote control is pressed, various operational indicators appear on the TV screen. To clear the operational indicators, press **ON SCREEN** twice.

### When playing back a recorded title

#### HDD

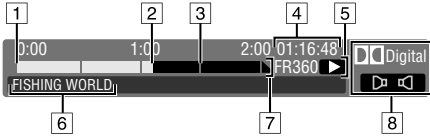

- 1 Title start
- 2 Current playback point
- 3 Title end
- 4 Elapsed playing time
- 5 Play mode
- 6 Name of title currently being played back
- 7 Time scale (This title is an hour and a half long.)
- 8 Audio mode

#### DVD

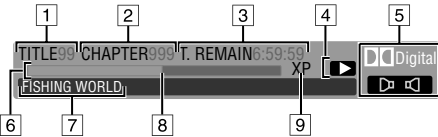

- 1 Playback title number
- 2 Playback chapter number
- 3 Disc remaining time
- 4 Current status (playback)
- 5 Audio mode
- 6 Bar meter
- 7 Name of title (or play list) currently being played back
- 8 Current playback point
- 9 Recorded mode\*

\* Depending on the recording condition, the recorded mode may not always be displayed.

### When recording

#### HDD

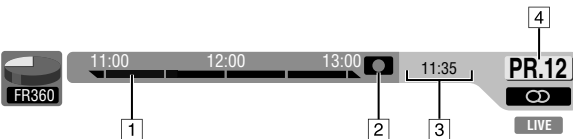

#### DVD

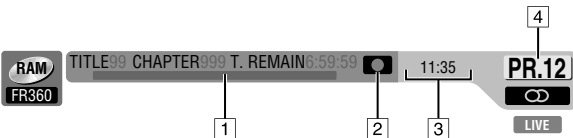

- 1 Recording point
- 2 Current status (recording)
- 3 Current time
- 4 Recording channel number

### When pressing REC MODE

(Appears for eight seconds.)

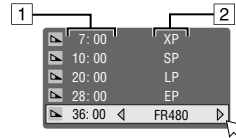

- 1 Remaining disc time for each recording speed
- 2 Recording speed

### When using Live Memory playback

#### HDD

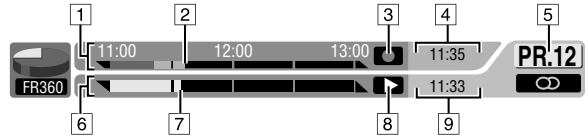

#### DVD

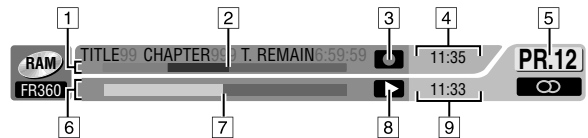

- 1 Time scale for recording (HDD deck)  
Bar meter for recording (DVD deck)
- 2 Current recording point
- 3 Recording mode
- 4 Current time
- 5 Current playback channel position number
- 6 Time scale for Live Memory Playback (HDD deck)  
Bar meter for Live Memory Playback (DVD deck)
- 7 Current playback point
- 8 Live Memory playback mode
- 9 Current playback time

## On-Screen Display (DV Dubbing)

When capturing images from the external DV equipment

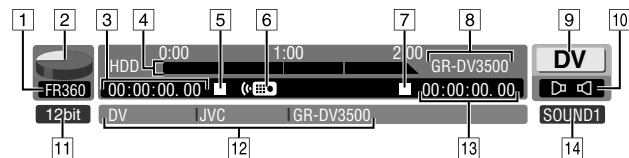

- 1 Recording speed
- 2 HDD capacity graph
- 3 HDD time counter
- 4 Recording time scale
- 5 HDD mode
- 6 Remote control mode
- 7 Connected DV equipment mode
- 8 Connected DV equipment model information
- 9 Input channel
- 10 Sound mode
- 11 Sound input bit-rate\*  
*\* Indicates the sound bit-rate of the connected DV equipment*
- 12 Connected DV equipment information\*  
*\* Maker name and model name, etc. may not appear depending on the connected equipment.*
- 13 Time counter for the connected DV equipment
- 14 Sound monitor mode

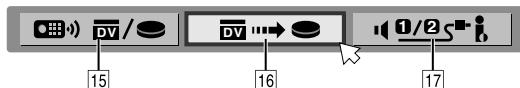

- 15 Remote control switch
- 16 Auto capture button
- 17 Sound monitor switch



- 18 Elapsed recording time

## On-Screen Display (DV deck)

When "SUPERIMPOSE" is set to "ON" or "AUTO" and **ON SCREEN** on the remote control is pressed, various operational indicators appear on the TV screen. To clear the operational indicators, press **ON SCREEN** again.

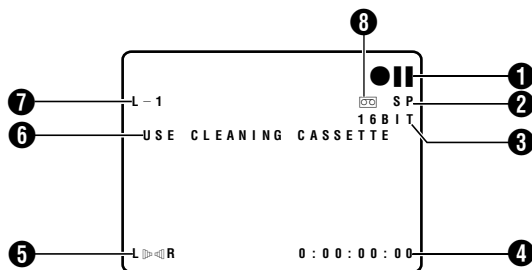

- 1 Operation Mode Indicators
- 2 Tape Speed (SP/LP)
- 3 Sound Mode Display pg. 59
- 4 Current Day/Month/Year/Clock Display/Time Code Display pg. 32
- 5 Audio Mode Display pg. 32
- 6 Warning Message
- 7 Auxiliary Input Indicator (L-1, F-1 or DV)
- 8 "Cassette Loaded" Mark

## Basic Connections

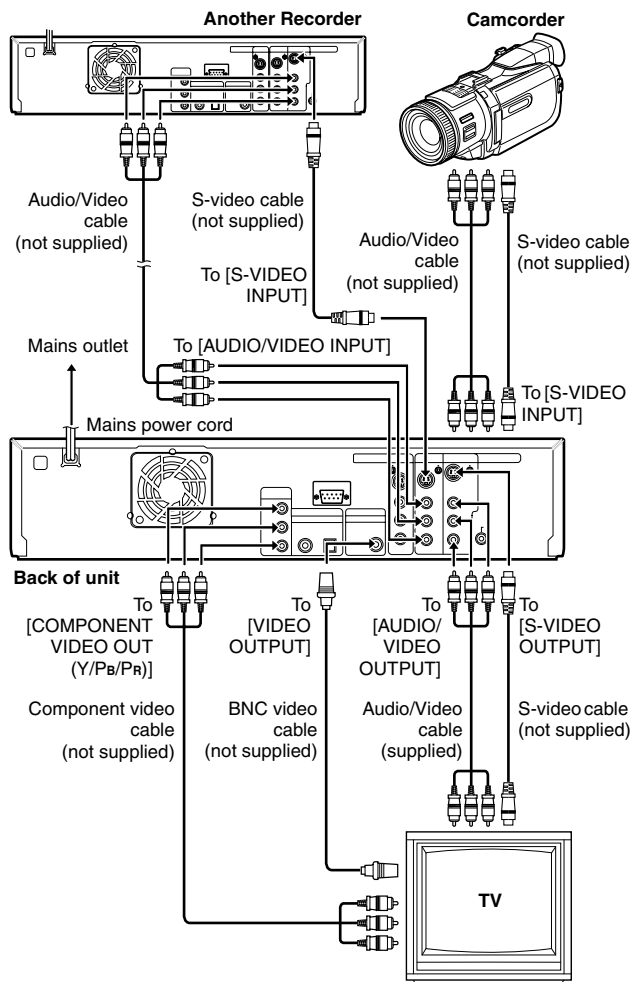

It's essential that your unit be properly connected.

### ATTENTION:

Connect the AC plug only after all connections to the TV has been completed.

- Make sure the package contains all of the accessories listed in "SPECIFICATIONS" (pg. 82).
- Place the unit on a stable, horizontal surface.

THESE STEPS MUST BE COMPLETED BEFORE ANY VIDEO OPERATION CAN BE PERFORMED.

## Connecting to a TV Monitor

Connect the unit to a TV depending on the TV and cables you use.

### ■ AV Connection

To connect to a TV with AV connector —

- 1 Connect the [AUDIO/VIDEO OUTPUT] connectors on the rear panel of the unit and the TV's audio/video input connectors with the supplied Audio/Video cable.

To connect to a TV with BNC connector —

- 1 Connect an optional audio cable between the [AUDIO OUTPUT] connectors on the rear panel of the unit and the TV's audio input connectors.
- 2 Connect an optional BNC video cable between the unit's BNC [VIDEO OUTPUT] connector and the TV's BNC VIDEO input connector.

### ■ S-Video Connection

To connect to TV's S-VIDEO input and AUDIO input connectors —

- 1 Connect the unit's [S-VIDEO OUTPUT] connector to the TV's S-VIDEO input connector.
- 2 Connect the unit's [AUDIO OUTPUT] connectors to the TV's AUDIO input connectors.
  - If your TV is not stereo-capable, use the unit's [AUDIO OUTPUT] connectors to connect to an audio amplifier for Hi-Fi stereo sound reproduction.

### ■ Component Video Connection

To connect to TV's component video input connectors —

- 1 Connect the unit's [COMPONENT VIDEO OUT (Y/Pb/Pr)] connectors to the TV's component video input connectors.
- 2 Connect the unit's [AUDIO OUTPUT] connectors to the TV's AUDIO input connectors.
  - You can obtain high-quality component video pictures.
  - The [COMPONENT VIDEO OUT (Y/Pb/Pr)] connectors do not output DV signals.
  - If your TV is not stereo-capable, use the unit's [AUDIO OUTPUT] connectors to connect to an audio amplifier for Hi-Fi stereo sound reproduction.
  - By using the component video connection, you can view the images in the progressive mode. For switching to the progressive mode, refer to "Scan Mode Set (HDD & DVD Deck Only)" (pg. 65).

## Connecting to a DV Device

- 1 Connect the unit's [S-VIDEO INPUT] or [VIDEO INPUT] connector on the front panel to the camcorder's s-video or video output connector.
- 2 Connect the unit's [AUDIO INPUT] connectors on the front panel to the camcorder's audio output connectors.

## Connecting to Another Recorder

- 1 Connect the unit's [S-VIDEO INPUT] or [VIDEO INPUT] connector to another recorder's s-video or video output connector.
- 2 Connect the unit's [AUDIO INPUT] connectors to another recorder's audio output connectors.

Plug the end of the mains power cord into a mains outlet.

- "PLEASE" and "WAIT" blink alternately on the front display panel when the AC plug of the mains power cord is connected into a mains outlet. After a short while, "32\*\*" blinks on the front display panel and starts to count down. It takes approximately 50 seconds for the unit to be turned on. This is not a malfunction.



# Clock Set

- Turn on the unit.
- Turn on the TV and select the AV mode.
- Slide the **TV/DVD** switch to **DVD**.

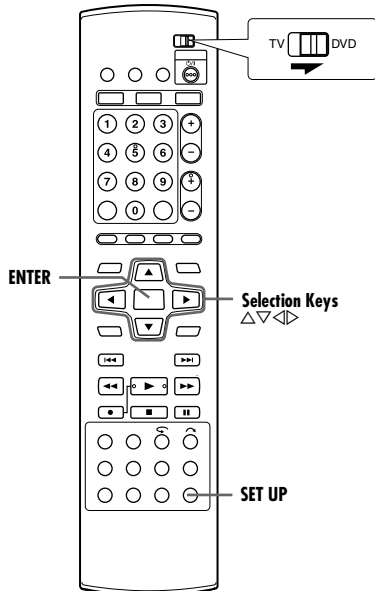

- 1 Press **SET UP** to access the Main Menu screen.
- 2 Press **selection keys** to select "INITIAL SET UP", then press  $\nabla$ .
- 3 Press **selection keys** to select "CLOCK SET", then press  $\nabla$ .
- 4 Press **selection keys** to select "YEAR", then press **ENTER**. Press **selection keys** to set the year, then press **ENTER**.
  - Repeat the same procedure to set the date and time.
  - When you set the date, press and hold  $\Delta \nabla$  to change the date by 15-day intervals.
  - When you set the time, press and hold  $\Delta \nabla$  to change the time by 30-minute intervals.
- 5 Press **SET UP** to start the clock operation.

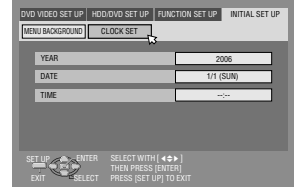

## Language

- Turn on the unit.
- Turn on the TV and select the AV mode.
- Slide the **TV/DVD** switch to **DVD**.

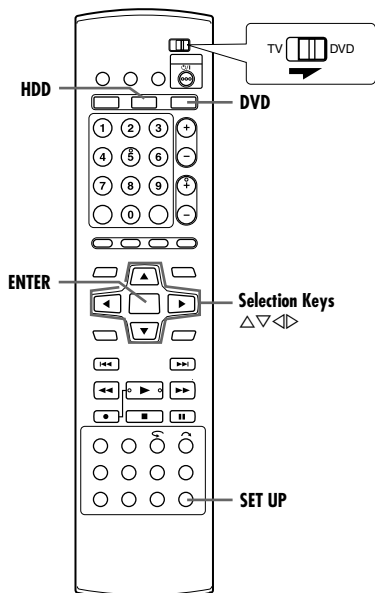

## On-screen Language Set

This unit offers you the choice to view on-screen messages in 11 different languages.

- 1 Press **HDD** or **DVD** so that the HDD or DVD lamp lights up on the unit.
- 2 Press **SET UP** to access the Main Menu screen.
- 3 Press **selection keys** to select "FUNCTION SET UP", then press  $\nabla$ .
- 4 Press **selection keys** to select "DISPLAY SET", then press  $\nabla$ .
- 5 Press **selection keys** to select "ON SCREEN LANGUAGE", then press **ENTER**.
- 6 Press **selection keys** to select your desired language, then press **ENTER**.
- 7 Press **SET UP** to complete the setting.

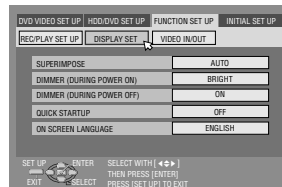

## Menu/Audio/Subtitle Language Set (DVD deck only)

Some DVD discs contain the DVD menu display, audio and subtitles in multiple languages. With these discs, you can set the default language as you like.

- The procedure shows how to set "MENU LANGUAGE" as an example.
- 1 Press **DVD** so that the DVD lamp lights up on the unit.
  - 2 Press **SET UP** to access the Main Menu screen.
  - 3 Press **selection keys** to select "DVD VIDEO SET UP", then press  $\nabla$ .
  - 4 Press **selection keys** to select "LANGUAGE SET", then press  $\nabla$ .
  - 5 Press **selection keys** to select "MENU LANGUAGE", then press **ENTER**.
  - 6 Press **selection keys** to select your desired language, then press **ENTER**.
    - See "Language Code List" (pg. 69).
  - 7 Press **SET UP** to complete the setting.



### NOTE:

When the selected language is not available on the disc, the disc's default menu language is played back.

## Monitor Set

You can select the monitor type depending on the TV used when you play back DVD VIDEO discs recorded for wide-screen TVs.

- Turn on the unit.
- Turn on the TV and select the AV mode.
- Slide the **TV/DVD** switch to **DVD**.

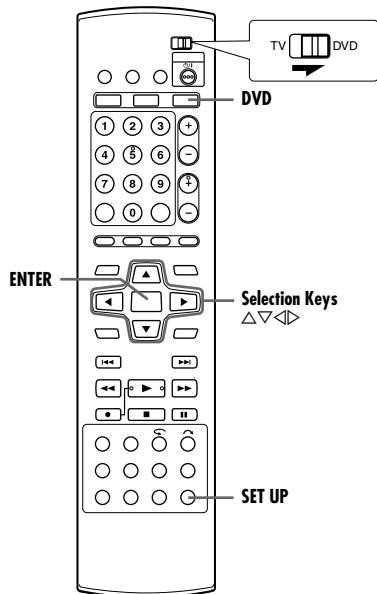

- 1 Press **DVD** so that the DVD lamp lights up on the unit.
- 2 Press **SET UP** to access the Main Menu screen.
  - You cannot set the monitor type during recording or playback.
- 3 Press **selection keys** to select "FUNCTION SET UP", then press **▽**.
- 4 Press **selection keys** to select "VIDEO IN/OUT", then press **▽**.
- 5 Press **selection keys** to select "MONITOR TYPE", then press **ENTER**.
- 6 Press **selection keys** to select the desired option, then press **ENTER**.
- 7 Press **SET UP** to complete the setting.

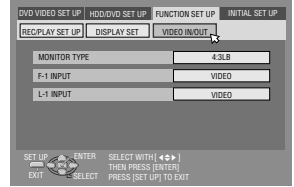

\* The **boldface** settings below indicate the settings at your purchase.

### ■ MONITOR TYPE – **4:3LB** / 4:3PS / 16:9AUTO / 16:9FIX

#### **4:3LB** (Letter Box conversion):

Select this when the aspect ratio of your TV is 4:3 (conventional TV). While viewing a wide screen picture, the black bars appear on the top and the bottom of the screen.

#### 4:3PS (Pan&Scan):

Select this when the aspect ratio of your TV is 4:3 (conventional TV). While viewing a wide screen picture, the black bars do not appear; however, the left and right edges of the pictures will not be shown on the screen.

#### 16:9AUTO (Wide television conversion):

Select this when the aspect ratio of your TV is 16:9 (wide TV).

#### 16:9FIX (Wide television conversion):

Select this when the aspect ratio of your TV is fixed to 16:9 (wide TV). The unit automatically adjusts the screen width of the output signal correctly when playing back a picture whose aspect ratio is 4:3.

### **Pan&Scan/Letter Box**

In general, DVD VIDEO disc are produced for a wide-screen TV with 16:9 aspect ratio.

Material with this ratio will not fit to a TV with 4:3 aspect ratio.

There are two styles to display the image, "Pan&Scan" (PS) and "Letter Box" (LB).

#### **Pan&Scan**

The right and left side of the image are cut off. The image fills the screen.

- The picture will be shown in the "4:3LB" mode depending on the disc even if the "4:3PS" mode is selected.



#### **Letter Box**

Black bands appear at the top and bottom of the image. The image itself appears in 16:9 aspect ratio.



## Basic Playback



- Turn on the unit.
- Turn on the TV and select the AV mode.
- Slide the TV/DVD switch to DVD.

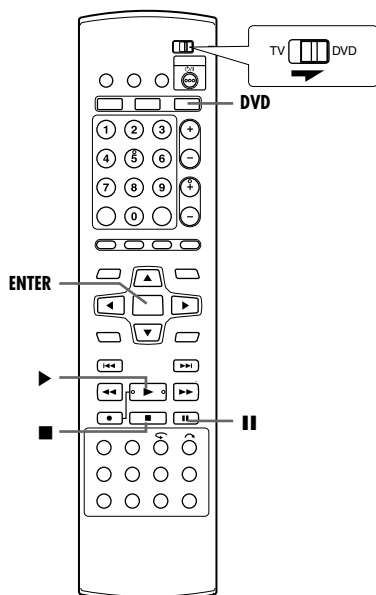
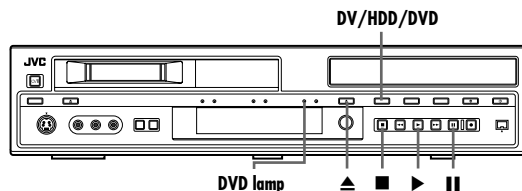

### ATTENTION:

- It takes approximately 30 seconds to read a disc depending on the type and condition of the disc since this unit is multi-disc compatible (DVD-RAM, DVD-RW, DVD-R). It may even take several minutes when a disc is dirty, scratched or warped.
- It may take a few seconds to start playback. This is not a malfunction.
- Forward/reverse high-speed search and other operations cannot be performed while playback is stopped.

To play back an MP3/JPEG disc, see “Playback With MP3/WMA/JPEG Navigation” (pg. 43).

- 1 Load a disc.
  - For details, refer to “Placing A Disc” (pg. 8).
  - Pressing ▶ also closes the disc tray.
  - Playback begins automatically if an auto-playback DVD disc is loaded.
- 2 Press DV/HDD/DVD on the unit repeatedly or DVD on the remote control so that the DVD lamp lights up on the unit.
- 3 Press ▶ to start playback.
  - If you load a DVD disc whose region code does not match the unit, “REGION CODE ERROR” appears on the TV screen. For details, refer to “Region Number” (pg. 6).
  - With Video CD/SVCD discs with PBC control or some DVD discs, the menu display may appear on the TV screen after starting playback. In this case, select an item which you want to play back from the menu. Otherwise, the playback cannot go forward. Refer to “Playback Control (PBC) Function” (pg. 24) or “Locating A Desired Scene Using The DVD Menu” (pg. 21).
  - The Library Database Navigation also enables you to search and select the desired titles. (pg. 37)
- 4 Press || to pause playback.
  - To resume normal playback, press ▶.
- 5 Press ■ to stop playback.
  - When a recordable disc is played, playback stops and AV input (from external AV source) resumes on the TV screen.
  - When a playback-only disc is played, playback stops and the TV screen becomes all black when you press ■. Pressing ■ again resumes the AV input (from external AV source).
  - If ▲ is pressed during playback, playback stops, then the disc tray opens.

### NOTES:

- When the Library Database Navigation screen appears, choose a thumbnail image of the desired title on the TV screen, then press ENTER. (pg. 37)
- It is not possible to playback the DVD disc recorded in 96 kHz on DVD during recording or Live Memory Playback on HDD.
- It is possible to play back on the DV deck and the HDD/DVD deck simultaneously. However, either DVD or HDD can be played at the same time.

# Playback Features

- Turn on the unit.
- Turn on the TV and select the AV mode.
- Slide the TV/DVD switch to DVD.
- Press DVD so that the DVD lamp lights up on the unit.

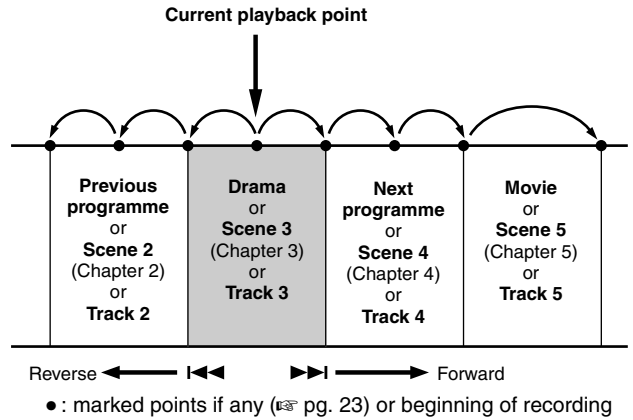
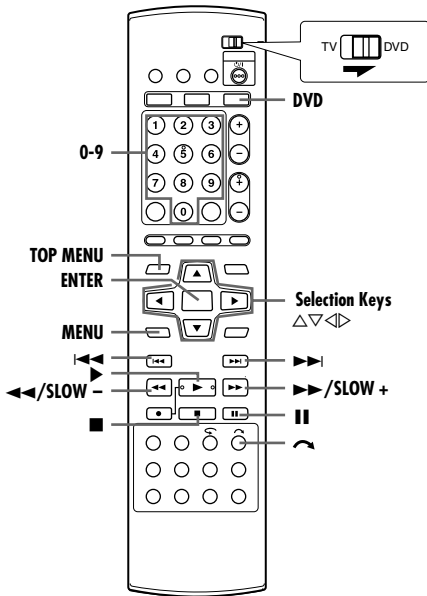

## Variable Speed Search



During playback, press ►► for forward variable speed search, or ◀◀ for reverse variable speed search.

- Each press of the button increases the search speed for each direction.
- To resume normal playback, press ►.

### For Audio CD

You can perform 4 levels of speed search with ►► and ◀◀. (Audio is active also during variable speed search.) You cannot perform slow motion for each direction.

Reverse ◀◀				▶▶ Forward											
Reverse Search 4 steps	Reverse Play	Reverse Slow Motion 3 steps	Slow Motion 3 steps	Normal Play	Forward Search 4 steps										
-60 -15 -5 -3	-1	-1/2 -1/4 -1/16	1/16 1/4 1/2	1	3 5 15 60										

### NOTE:

Reverse play (-1x) is not possible with Video CD/SVCD discs.

## Still Picture/Frame-By-Frame Playback



- 1 Press **II** to pause during playback.
- 2 Press **SLOW -** (◀◀) or **SLOW +** (▶▶) to activate frame-by-frame playback.
  - Each press of **SLOW -** (◀◀) or **SLOW +** (▶▶) advances/reverses the still picture frame by frame.
  - Frame-by-frame playback for reverse direction cannot be performed with Video CD/SVCD discs.
  - To resume normal playback, press ►.

## Slow Motion



- 1 Press **II** to pause during playback.
- 2 Press **SLOW -** (◀◀) or **SLOW +** (▶▶) for 2 or more seconds.
  - Each press of **SLOW -** (◀◀) or **SLOW +** (▶▶) increases the slow motion speed for each direction.
  - Slow motion for reverse direction cannot be performed with Video CD/SVCD discs.

## Locating A Desired Scene Using The DVD Menu



DVD VIDEO discs may have top menu and disc menu.

### Top menu

DVD discs generally have their own menus which show the disc contents. These menus contain various items such as titles of a movie, names of songs, or artist information. You can locate a desired scene by using the top menu displayed on the TV screen. Press **TOP MENU** to access the top menu.

### Disc menu

Disc menus include playback data (angle menu, subtitle menu, etc.) specific to each title. Press **MENU** to access the disc menu.

- 1 Press **TOP MENU** or **MENU** to access the DVD menu.

Example:

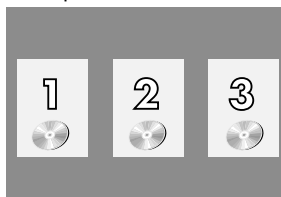

- 2 Press **selection keys** to select a desired title, then press **ENTER**. Playback starts.
  - It may be possible to select the desired item using the **number keys** depending on the menu display.

### NOTE:

When "⊙" appears on the TV screen in step 1, the disc does not have a top menu or disc menu.

## Locating The Start Point Of The Item Or Skip The Item



Press ◀◀ or ▶▶ during playback.

- Pressing ▶▶ locates the start point or marked points of the item or skips the item in the forward direction, then resumes playback.
- Pressing ◀◀ locates the start point or marked points of the item or skips the item in the reverse direction, then resumes playback.

## Skip Search



During playback, press .

- Each press initiates an approximately 30-second period of fast-motion playback. Normal playback resumes automatically.
- Skip search cannot be performed when a VCD/SVCD disc is being played back with the PBC function.

## Instant Replay



You can move back the playback position slightly.

Press  on the remote control or **INSTANT REPLAY** on the unit.









- Each press skips back for approximately 7 seconds and resumes playback.
- Pressing while paused skips back for approximately 7 seconds and resumes pause.
- Instant replay cannot be performed when a VCD/SVCD disc is being played back with the PBC function.

## Jump Search





You can locate a scene ahead or behind the current one by jumping scenes according to selected time intervals (see pg. 58) during playback (or Live Memory Playback).

Press  or .

- To advance forward or back, press  or  repeatedly within 5 seconds of each press to continue jump.
- Depending on the time from where you want to start jump search, the first press of  or  will not necessarily lead to a jump of the selected time interval. The first press will lead to a jump to the nearest quarter points of an hour (15 min/ 30 min/ 45 min/ 00 min). The subsequent jumps will then be in accordance to the selected time interval.
- When you cannot advance any further (beginning or end of programme reached), the message "UNABLE TO GO BACK ANY MORE" or "UNABLE TO GO FORWARD ANY MORE" appears on the screen. In such a case, press , , ,  or .

### Example:

Playback search when jump interval is set to 15 MIN jumps. Taking for instance, you want to start jump search 40 minutes after the beginning of the programme. Pressing  or  will result in a jump to the scene at the 30 minutes point or 45 minutes point respectively as illustrated below. At the subsequent press, the scene will jump to the 15 minutes point or 1 hour point respectively, according to the selected time interval, which in this case is "15 MIN".

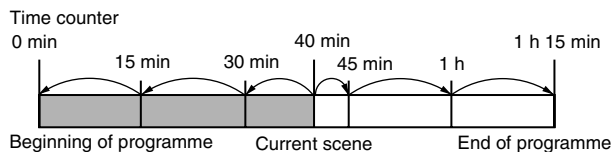

### NOTES:

- Jump search cannot be performed with finalised DVD-R/DVD-RW (video mode) discs.
- Jump search functions only when chapters (marks) are not set.

## Resume Function







It is possible to memorise the position where you stop playback and resume playback from that position.

- Be sure to set "RESUME" to "ON" or "DISC RESUME". (see pg. 58)
- Resume function always works for DVD-R/DVD-RW discs that have not been finalised and DVD-RAM regardless of the setting of "RESUME".

**1** Press  during playback to memorise a resume point.

- The unit enters Resume Stop mode and memorises the position where you have stopped playback as a resume point. (The inside of the disc status indicator on the front display panel blinks while memorising.)
- The unit retains a memory of the resume points of the last 30 discs played back, even though they have been ejected if "RESUME" is set to "DISC RESUME". (see pg. 58)
- Performing the following steps would erase the resume points: (The inside of the disc status indicator stops blinking and lights.)

**When "RESUME" is set to "ON":**

- Press  to turn off the unit.
  - Press  to take out the disc.
  - Press  in stop mode.
  - Press **TOP MENU** to display the top menu, then start playback by selecting an item, etc.
  - Press **MENU** to display the disc menu, then start playback by selecting an item, etc.
- When "RESUME" is set to "DISC RESUME":**
- Set "RESUME" to "OFF". (see pg. 58)
  - Press  in stop mode.
  - Press **TOP MENU** to display the top menu, then start playback by selecting an item, etc.
  - Press **MENU** to display the disc menu, then start playback by selecting an item, etc.

**2** Press  in stop mode to resume playback. The unit starts playback from the resume point.

### NOTES:

- "DISC RESUME" setting works on DVD VIDEO, VCD, SVCD and already finalised DVD-R/DVD-RW (video mode) discs. For other types of discs, the function under "ON" setting will be applied even if "RESUME" is set to "DISC RESUME". (see pg. 58)
- If you stop the playback of a disc for which a resume point has already been memorised, the memory will be updated with the new resume point.
- After the unit has memorised the resume points for 30 discs, remembering a new resume point will cause the unit to delete the oldest memorised point. Stopping playback of a disc for which a resume point is already stored may change the order in which the points are stored. This may potentially change the order in which points are deleted.
- When the unit memorises a resume point for a disc, it also remembers audio language, subtitle and angle settings.
- This function may not work for some Video CD/SVCDs.
- When "RESUME" is changed to "ON" or "OFF" (see pg. 58), resume points of the discs memorised with "RESUME" set to "DISC RESUME" will be cleared.
- Resume points are memorised for each side of a double-sided disc.
- When you switch to HDD while playing back JPEG/MP3 files, playback stops. The Resume Function doesn't work when you switch to DVD thereafter to playback the disc.

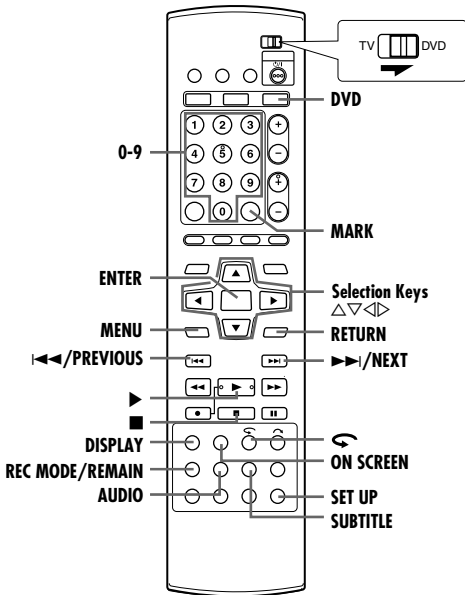

### Marking Positions To Play Back Again Later



It is possible to mark positions (up to 999 points) where you want to play back once again later, and start playback from a marked position. Marking onto DVD-RAM/R/RW (VR mode only) discs when recording is helpful to locate a start point when you play back the discs later.

#### To mark positions:

During playback, press **MARK** at positions you want to mark.

- “MARK” appears on the TV screen. You can easily locate the marked positions using **<=>** or **>=>** when you play back the disc.

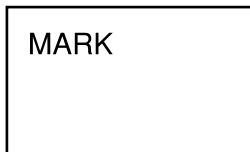

#### To delete the marked positions:

While paused, press **<=>** or **>=>** to locate a marked position you want to delete, then press **MARK**.

- Crossed “MARK” appears on the TV screen, and the marked position is deleted.



#### NOTES:

- For DVD-R/RW (Video mode) discs, marks are assigned automatically every 5 minutes.
- If **MARK** is pressed when playing back a disc that does not allow marks to be inserted, “⊙” appears on the TV screen.

### Checking The Time Information



You can check time information of a disc on the front display panel and the TV screen.

#### ■ DVD-RAM/DVD-R/DVD-RW

Each press of **DISPLAY** on the remote control or the unit changes the display as follows:

##### During recording

Clock time (front display panel only) → Current title elapsed time → Disc remaining time → (back to the beginning)

##### During playback

Each title elapsed time → Total remaining time → Remaining time\* → (back to the beginning)

\* only discs before finalising

##### During recording/playback or in stop mode

Press **REC MODE**.

- The disc remaining time according to recording modes appears on the TV screen.
- It is possible to check disc remaining time according to recording modes also by pressing **REMAIN**.
- In FR mode, it is possible to set recording time in detail. While the recording mode and the disc remaining time are displayed by pressing **REMAIN**, press **selection keys** to select “FR”, then press **<>** to select the desired recording time. (pg. 49)
- It is not possible to switch the recording mode during playback or while recording.

#### ■ Video CD/SVCD/Audio CD

##### During playback or in stop mode

Current track elapsed time → Current track remaining time → Total elapsed time → Total remaining time → (back to the beginning)

#### NOTES:

- When a PBC-compatible Video CD/SVCD disc is loaded, deactivate the PBC function. (pg. 24)
- For pre-recorded DVD VIDEO, only the title, chapter and elapsed time are displayed when **ON SCREEN** is pressed.

### Angle Selection



You can enjoy a variety of scene angles if a DVD VIDEO disc contains “multi-angle” parts, where the same scene was shot from different angles.

If the disc contains “multi-angle” parts, “⊞” appears on the TV screen at the beginning of the “multi-angle” part.

#### 1 Press **ANGLE** during playback.

The angle selection display appears on the TV screen.



When 3 scene angles are contained.

#### 2 Press **ANGLE** or **selection keys** to select your desired angle.

- Each time you press **ANGLE** or the **selection keys**, the angle changes.
- When “⊞” appears on the TV screen, the current scene is not recorded from multiple angles. In addition, some discs prohibit angle selection.
- To clear the angle selection display, press **ENTER**. In addition, the angle selection display disappears automatically if no operation is done for 10 seconds.

## Subtitle Selection



Some DVD VIDEO discs contain more than one subtitle language, from among which you can choose the desired subtitle language. “” appears on the TV screen at the beginning of the part where more than one subtitle language are recorded.

**1** Press **SUBTITLE** during playback. The subtitle selection display appears on the TV screen.



When 3 subtitle languages are contained.

- Each time you press **SUBTITLE**, the subtitle display is switched on and off.

**2** Press **selection keys** to select your desired language.  
 • To clear the subtitle selection display, press **ENTER**.

### NOTES:

- When “” appears on the TV screen, no subtitle language is recorded.
- When the subtitle language won't be changed with the procedure above, change the subtitle on a disc menu displayed by pressing **MENU**.

## Audio Channel Selection



When watching bilingual programmes or playing discs on which you recorded bilingual or stereo programmes, you can choose the desired audio channel.

- When “SUPERIMPOSE” is set to “ON” or “AUTO”, you can confirm on the TV screen the audio channel you have chosen. (pg. 58)
- Each time you press **AUDIO**, the audio channel changes.



TRACK	USE
<b>On-Screen Display</b>	
	For main audio of bilingual programme
	For sub audio of bilingual programme
	For stereo discs
	For audio of left channel
	For audio of right channel

### NOTE:

It is not possible for DVD-R/DVD-RW (Video mode) disc playback to switch the audio channel.

### When you can't switch the audio channel of a bilingual programme

When the unit is connected with a digital audio device using an optional optical cable and “DIGITAL AUDIO OUT” is set to “DOLBY DIGITAL/PCM”, it is not possible to switch the audio channel of a bilingual programme recorded on a DVD-RAM or DVD-R/RW (VR mode) disc. (pg. 56) In this case, perform the following steps using the remote control to switch “DIGITAL AUDIO OUT” from “DOLBY DIGITAL/PCM” to “PCM ONLY”.

- Press **SET UP** to access the Main Menu screen.
- Press **selection keys** to select “DVD VIDEO SET UP”, then press **▽**.
- Press **selection keys** to select “AUDIO OUTPUT”, then press **▽**.
- Press **selection keys** to select “DIGITAL AUDIO OUT”, then press **ENTER**.
- Press **selection keys** to select “PCM ONLY”, then press **ENTER**. (pg. 57)
- Press **SET UP** to complete the setting.
- Press **AUDIO** to select the desired audio channel.

## Audio Language/Sound Selection



Some DVD VIDEO discs contain the multiple audio language or sound. You can select the desired audio language or sound. For some Video CD/SVCD discs, you can switch the audio channel to choose Karaoke either with or without the vocal.

**1** Press **AUDIO** during playback. **For example: DVD VIDEO**  
 The Audio Language/Sound selection display appears.



When 3 audio languages are contained.

**2** Press **AUDIO** or **selection keys** to select your desired audio language/sound.  
 • Each time you press **AUDIO** or the **selection keys**, the audio language/sound changes.  
 • To clear the Audio Language/Sound selection display, press **ENTER**.

### NOTES:

- When “” appears on the TV screen, no other audio language is recorded.
- When the audio language won't be changed with the procedure above, change the audio on a disc menu displayed by pressing **MENU**.
- Pressing **AUDIO** to select the audio language/sound is only possible during playback. It is not possible to select by pressing **AUDIO** in stop mode. However, you can select the desired audio language/sound from the setup menu while in stop mode.

## Playback Control (PBC) Function



Some Video CD/SVCD discs support the PBC function. PBC is an abbreviation of “Play Back Control”. A Video CD/SVCD disc recorded with PBC has its own menus, such as a list of the songs on the disc. You can locate a specific scene by using the menu.

- Press **▶** in stop mode. The PBC menu appears.
- Press the **number keys** to enter the number of the desired scene, then press **ENTER**. The unit starts playback of the selected item.
  - “PBC” appears on the front display panel.
  - When “NEXT” or “PREVIOUS” appears on the TV screen: Pressing **NEXT** (**▶▶**) advances to the next page. Pressing **PREVIOUS** (**◀◀**) returns to the previous page.
  - You can return to the menu by pressing **RETURN**.
  - The method of the operation is different depending on the disc.

### NOTE:

If you want to playback a PBC-compatible Video CD/SVCD disc without activating the PBC function, start playback with the PBC function, then press **■** to stop playback. The TV screen becomes all black. Then start playback in stop mode by using the **number keys** to choose the track, then press **ENTER**.



# Using The On-screen Bar



The on-screen bar allows you to control various playback functions. Some of the functions operated on Navigation Menu can be controlled on the On-screen bar.

**ATTENTION:**

The on-screen bar can also be used for the HDD deck.

Be sure to clear Library Database Navigation screen by pressing **NAVIGATION**.

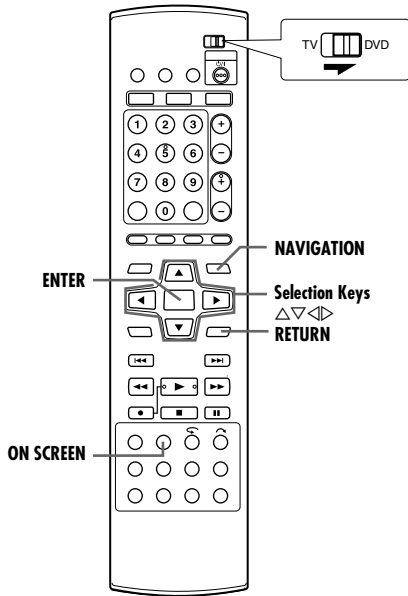

## How To Access The On-screen Bar

**1** Press **ON SCREEN** twice whenever a disc is loaded.

### Contents of the on-screen bar during playback

**DVD VIDEO**

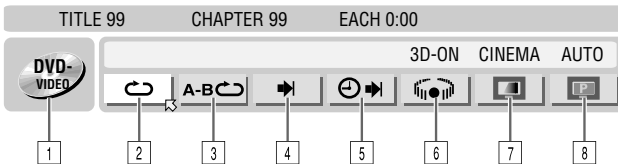

### Video CD/SVCD

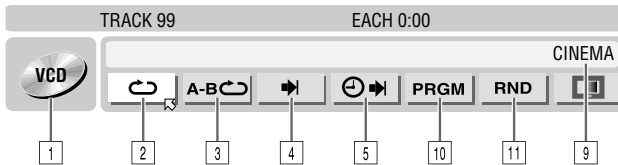

### JPEG disc

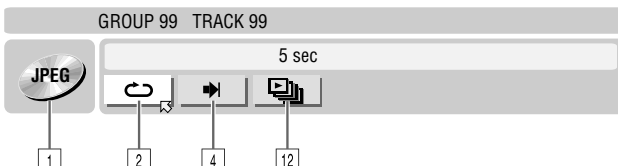

- 1 Disc type.
- 2 Select this for Repeat Playback. (See below)
- 3 Select this for A-B Repeat Playback. (See pg. 26)
- 4 Select this for search function. (See pg. 26)
- 5 Select this for time search function. (See pg. 27)
- 6 Select this to switch Simulated Surround Effect function. (See pg. 27)
- 7 Select this for Picture Control function. (See pg. 27)
- 8 Select this to switch picture source type. (See pg. 28)
- 9 Current status area for the selected item.
- 10 Select this for Programme Playback. (See pg. 28)
- 11 Select this for Random Playback. (See pg. 28)
- 12 Select this to control the switching interval of the slide show. (See pg. 28)

**NOTE:**

Although examples of the on-screen bar are provided here only for 3 types of discs, the on-screen bar will be displayed for whichever disc indicated in the left column.

## Basic Operation On The On-screen Bar

Example: When selecting Picture Control function of DVD

### During playback or while stopped

**1** Press **ON SCREEN** twice to access the on-screen bar. The item currently selected is highlighted and pointed by .



**2** Press **selection keys** to select "", then press **ENTER**. The pop-up window appears under the selected item.



**3** Press **selection keys** to select the desired option, then press **ENTER**.

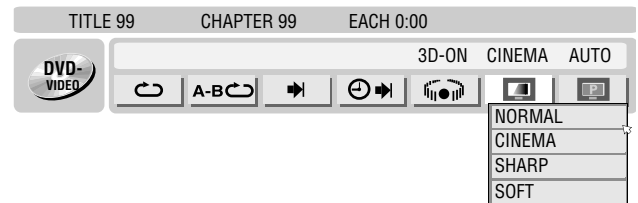

### To clear the on-screen bar

Press **ON SCREEN**.

**NOTE:**

See the corresponding pages for details on each menu item.

## Repeat Playback



You can repeat playback as you like according to the type of disc.

**1** Press **ON SCREEN** twice to access the on-screen bar.

**2** Press **selection keys** to select "", then press **ENTER**. The pop-up window appears under the selected item.



**3** Press **selection keys** repeatedly to select the desired Repeat mode, then press **ENTER**.

**DVD-RAM/RW/R**

- OFF:  
Repeat playback is not performed.
- ALL REPEAT:  
The whole disc is played back repeatedly.
- TITLE REPEAT:  
The current title is played back repeatedly.

**DVD VIDEO**

- OFF:  
Repeat playback is not performed.
- TITLE REPEAT:  
The current title is played back repeatedly.
- CHAPTER REPEAT:  
The current chapter is played back repeatedly.

**Audio CD/Video CD/SVCD**

- OFF:  
Repeat playback is not performed.
- ALL REPEAT:  
The whole disc is played back repeatedly.
- TRACK REPEAT:  
The current track is played back repeatedly.

**JPEG/MP3**

- OFF:  
Repeat playback is not performed.
- FOLDER REPEAT:  
The whole folder is played back repeatedly.
- TRACK REPEAT\*:  
The current track is played back repeatedly.

\* "TRACK REPEAT" cannot be selected for JPEG discs.

**To clear the on-screen bar**

Press **ON SCREEN**.

**To cancel Repeat Playback**

Repeat the above procedure from step 1, select "OFF" in step 3, then press **ENTER**.

**NOTES:**

- Repeat Playback is not possible for a Video CD/SVCD with PBC function.
- Repeat Playback may not work properly depending on the type of the disc being used.
- It is possible to use the Mode Lock function. (pg. 65)

**A-B Repeat Playback**



You can repeat the desired part.

**During playback**

- 1 Press **ON SCREEN** twice to access the on-screen bar.
- 2 Press **selection keys** to select "A-B".
- 3 Press **ENTER** at the beginning of the desired part you want to repeat (point A). The elapsed playing time of the point A appears.

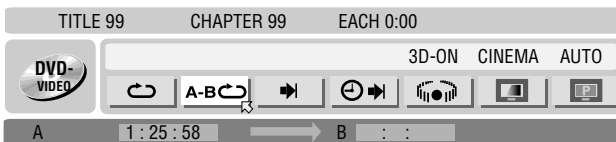

- 4 Press **ENTER** at the end of the desired part you want to repeat (point B). The elapsed playing time of the point B appears.
- The selected part of the disc (between point A and B) is played repeatedly.

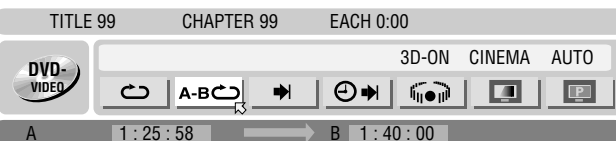

**To clear the on-screen bar**

Press **ON SCREEN**.

**To cancel A-B Repeat Playback**

Press **selection keys** to select "A-B", then press **ENTER**.

**NOTES:**

- A-B Repeat Playback may not work properly depending on the type of disc being used.
- The subtitles recorded around the A-B point may not appear.
- When the end of the item is reached before the end point is set, the pop-up window disappears from the TV screen. In such a case, repeat the procedure from step 2.
- The point B must be set at least 3 seconds after the point A.
- When playing back a DVD, A-B Repeat Playback is possible only within the same title.
- "A-B" cannot be selected during Programme and Random Playback.
- "A-B" cannot be selected while stopped.

**Locating The Beginning Of A Desired Selection**



You can locate the beginning of a title, chapter, group or track.

**During playback or while stopped**

- 1 Press **ON SCREEN** twice to access the on-screen bar.
- 2 Press **selection keys** to select "▶", then press **ENTER**.
- 3 Press **selection keys** to select the desired item, then press **ENTER**.
  - Skip this step for Video CD/SVCD and Audio CD.

**For DVD-RAM/RW/R, DVD VIDEO**

"TITLE SEARCH" or "CHAPTER SEARCH" is selectable. (However, "CHAPTER SEARCH" is not selectable while stopped.)

**For Video CD/SVCD, Audio CD, JPEG, MP3**

"TRACK" is selectable.

**NOTE:**

Settings that are selectable during playback and stop mode differ depending on the type of disc and search used.

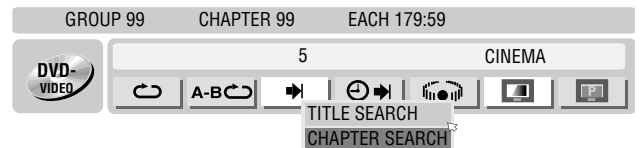

- 4 Press the **number keys** to enter the desired item number, then press **ENTER**.
  - Playback starts from the selected section.

**Examples:**

- 1 To select track 5, press the **number key "5"**.
- 2 To select track 15, press the **number key "1"** and **"5"**.
- 3 To select track 25, press the **number key "2"** and **"5"**.

**If you have specified a wrong selection**

Press **RETURN** on the remote control and repeat the above procedures from step 2.

**To clear the on-screen bar**

Press **ON SCREEN**.

**NOTES:**

- When "⊙" is displayed on the TV screen in step 4, the chapter you have selected is not contained in the disc, or chapter search does not work on the disc.
- Before you press **ENTER**, playback may start automatically when you enter the section's number depending on the disc.
- This function is not possible for a Video CD/SVCD with PBC function.

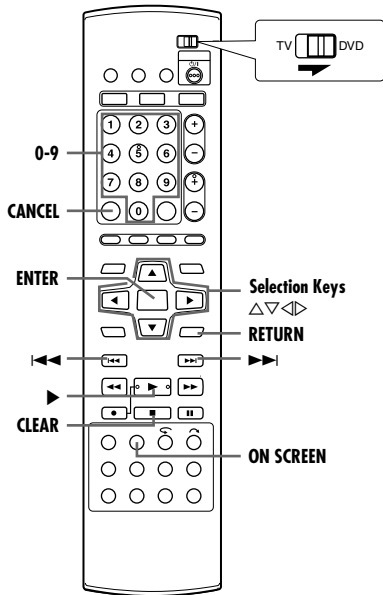

### Time Search



You can play back a disc from the desired point by specifying the elapsed playing time from the beginning of a programme (DVD-RAM, DVD-R, DVD-RW, DVD VIDEO and HDD) or a disc (Video CD/SVCD and Audio CD).

- 1 Press **ON SCREEN** twice to access the on-screen bar.
- 2 Press **selection keys** to select “”, then press **ENTER**. The pop-up window appears under the selected item.

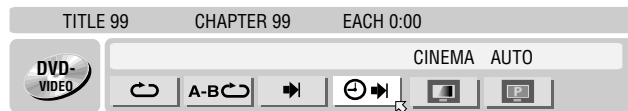

- 3 Press the **number keys** to enter the time, then press **ENTER**. Playback starts from the specified time.

Example:  
To play back from a point 12 (minutes): 50 (seconds) elapsed.

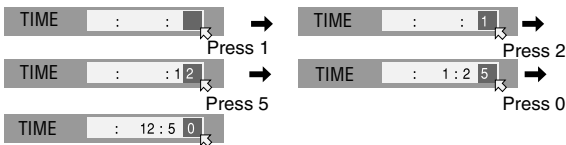

**If you have specified a wrong selection,**  
Press **RETURN** on the remote control and repeat the above procedures from step 2.

**To clear the on-screen bar**  
Press **ON SCREEN**.

- NOTES:**
- When “” is displayed on the TV screen in step 3, you have selected a point that exceeds the recording time of the disc. However, for HDD; DVD-R/RW (Video mode) discs that have not been finalised; and DVD-R/RW (VR mode) discs, “” will not be displayed and the last image (still) of the programme appears on the TV screen.
  - Some DVD VIDEO discs do not contain time information, and it is not possible to use the Time Search function. In such cases, “” is displayed on the TV screen as well.
  - This function is not possible for a Video CD/SVCD with PBC function.

### Simulated Surround Effect



It is possible to get a simulated surround effect from your stereo system. You can enjoy the virtual surround sound with your 2-channel stereo system.

- 1 Press **ON SCREEN** twice to access the on-screen bar.
- 2 Press **selection keys** to select “”, then press **ENTER**.
- 3 Press **selection keys** to select “ON”, then press **ENTER**.
  - “3D-ON” appears above the selected item and Simulated Surround Effect is activated.

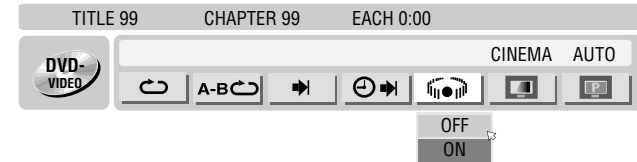

**To clear the on-screen bar**  
Press **ON SCREEN**.

**To cancel the simulated surround effect**  
Press **selection keys** to select “OFF”, then press **ENTER** to clear “3D-ON” from the screen.

- NOTES:**
- Simulated Surround Effect works correctly only when playing back a title recorded in multichannels.
  - Simulated Surround Effect does not affect the DVD VIDEO bitstream signal from the [DIGITAL AUDIO OUTPUT] connectors.
  - When Simulated Surround Effect is activated, the settings of “ANALOG AUDIO OUT” and “D. RANGE CONTROL” are disabled. (pg. 57)
  - Simulated Surround Effect cannot be activated under the following conditions:
    - When the HDD deck is in the recording mode.
    - When a disc containing both the Dolby Digital 5.1 CH and 2CH sound formats is playing back a scene that is not in the 5.1CH sound format.

### Adjusting The Picture Quality



You can obtain optimal picture quality by selecting an appropriate picture mode.

- 1 Press **ON SCREEN** twice to access the on-screen bar.
- 2 Press **selection keys** to select “”, then press **ENTER**. The pop-up window appears under the selected item.



- 3 Press **selection keys** to select the desired option, then press **ENTER**.
  - NORMAL:**  
Normally select this option.
  - CINEMA:**  
Suitable for a movie disc, etc.
  - SHARP:**  
Clearer, sharper-edged picture when viewing images with lots of flat, same-coloured surfaces such as cartoons.
  - SOFT:**  
Select this option when too much noise appears.

**To clear the on-screen bar**  
Press **ON SCREEN**.

## Setting The Progressive Mode



You can obtain optimal picture quality by selecting whether the content on the disc is processed by field (video source) or by frame (film source).

- 1 Set the unit to the progressive scan mode. (pg. 65)
- 2 Press **ON SCREEN** twice to access the on-screen bar.
- 3 Press **selection keys** to select "P", then press **ENTER**. The pop-up window appears under the selected item.



- 4 Press **selection keys** to select the desired option, then press **ENTER**.

### AUTO:

This mode automatically detects film and video content for progressive playback. When film content is found, flag detection is used to invoke playback of film data in full screen. When video content is found, pictures from multiple fields are used to detect sections with movement, and then this movement undergoes advanced image processing for output of sharp, detailed progressive images without any reduction in image quality where movement occurs. Normally, operation in this mode is recommended.

### FILM:

Suitable for playing back a progressive scanned film source disc.

### VIDEO:

Suitable for playing back a video source disc. The outlines on the played back pictures will be soft.

### To clear the on-screen bar

Press **ON SCREEN**.

### NOTE:

Progressive scan is output only from [COMPONENT VIDEO OUT] connectors.

## Programme Playback



You can programme up to 30 tracks (Video CD/SVCD or Audio CD) to play back in the desired order.

### While stopped

- 1 Press **ON SCREEN** twice to access the on-screen bar.
- 2 Press **selection keys** to select "PRGM", then press **ENTER**. The programme table appears under on-screen bar.



- 3 Press the **number keys** to enter the track numbers in the desired order.

### Examples:

- 1 To select track 5, press the **number key "5"** and **ENTER**.
- 2 To select track 15, press the **number key "1"** and **"5"**.
- 3 To select track 25, press the **number key "2"** and **"5"**.

### If you have specified a wrong selection

Press **CANCEL**. The last selection is erased.

Or press **CLEAR** (■). The whole selection is erased.

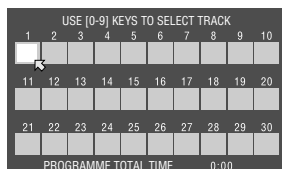

- 4 Press **▶**. Playback starts in the programmed order.

- When all of the programmed tracks have been played back, Programme Playback stops, but the programmed information remains.
- To add tracks to the end of the programme, perform step 3.
- During Programme Playback, pressing **▶▶** skips to the next selection of the programme. Pressing **◀◀** returns to the beginning of the current selection.

**To clear the on-screen bar and the contents of the programme**  
Press **ON SCREEN**.

### To cancel Programme Playback

Press **selection keys** to select "PRGM", then press **ENTER**.

### NOTE:

Programme Playback is not possible depending on the type of disc.

## Random Playback



You can play back all the tracks on the disc in random order.

### While stopped

- 1 Press **ON SCREEN** twice to access the on-screen bar.
- 2 Press **selection keys** to select "RND", then press **ENTER**.
- 3 Press **selection keys** to select "ON", then press **ENTER**. Playback starts in random order.

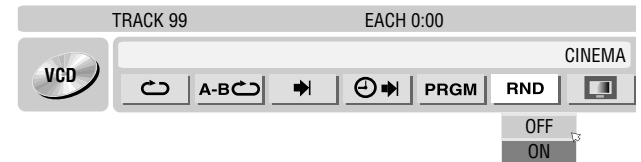

### To clear the on-screen bar

Press **ON SCREEN**.

### To cancel Random Playback

Press **selection keys** to select "OFF", then press **ENTER**.

### NOTE:

The same track will not be played back more than once during Random Playback.

## Select The Switching Interval Of The Slide Show



You can control the switching interval of the slide show.

- 1 Press **ON SCREEN** twice to access the on-screen bar.
- 2 Press **selection keys** to select "5 sec", then press **ENTER**. The pop-up window appears under the selected item.

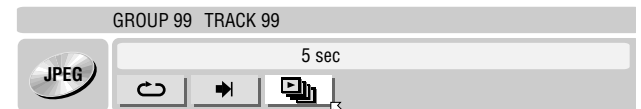

- 3 Press **selection keys** to select the desired option, then press **ENTER**.

- Each time you press the **selection keys**, the interval changes as follows:  
5 sec ↔ 10 sec ↔ 15 sec ↔ 20 sec ↔ 25 sec ↔ 30 sec ↔  
(Back to the beginning)

### To clear the on-screen bar

Press **ON SCREEN**.

### NOTE:

JPEG files are played back as a slide show. It may take more time to display an image with larger file size.

## Basic Playback

- Turn on the unit.
- Turn on the TV and select the AV mode.
- Slide the **TV/DVD** switch to **DVD**.

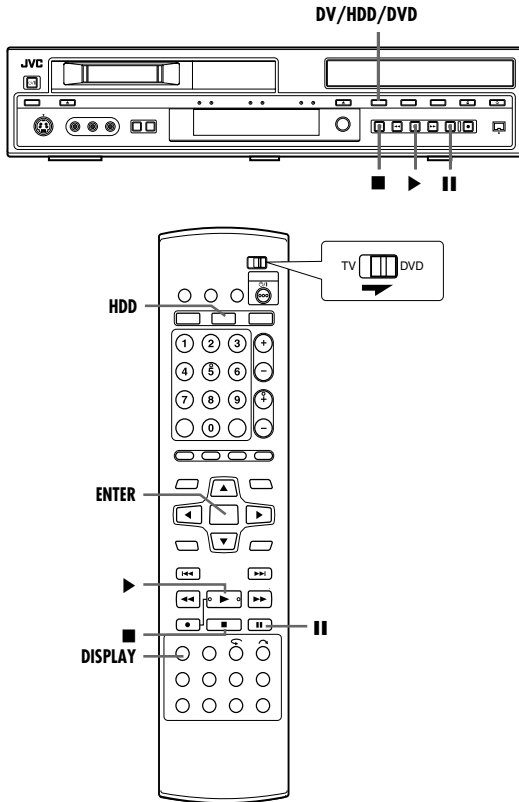

### ATTENTION:

- It may take a few seconds to start playback. This is not a malfunction.
- Forward/reverse high-speed search and other operations cannot be performed while playback is stopped.

- 1 Press **DV/HDD/DVD** on the unit repeatedly or **HDD** on the remote so that the HDD lamp lights up on the unit.
- 2 Press **▶** to start playback.
  - The Library Database Navigation also enables you to search and select the desired programmes. (see pg. 37)
- 3 Press **⏸** to pause playback.
  - To resume normal playback, press **▶**.
- 4 Press **■** to stop playback.

### NOTES:

- When the Library Database Navigation screen appears, choose a thumbnail image of the desired title on the TV screen, then press **ENTER**. (see pg. 37)
- During HDD playback, the current title elapsed time is displayed on the TV screen when **ON SCREEN** is pressed. However, each press of **DISPLAY** changes the time display on the front display panel as follows:  
Current title elapsed time → Disc remaining time → Current title remaining time → (back to the beginning)
- It is possible to play back on the DV deck and the HDD/DVD deck simultaneously. However, either DVD or HDD can be played at the same time.

## Playback Features

- Turn on the unit.
- Turn on the TV and select the AV mode.
- Slide the **TV/DVD** switch to **DVD**.
- Press **HDD** so that the HDD lamp lights up on the unit.

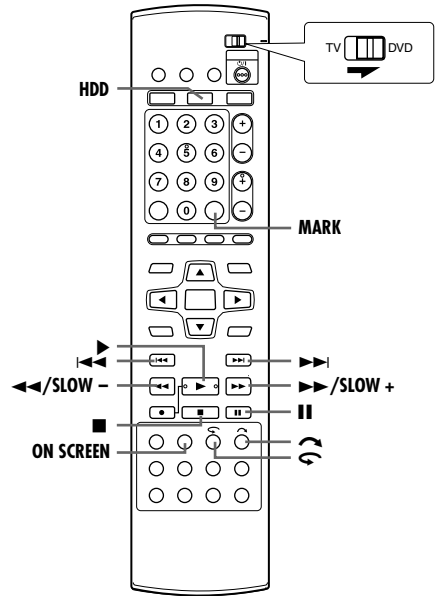

## Variable Speed Search

- During playback, press **▶▶** for forward variable speed search, or **◀◀** for reverse variable speed search.
- Each press of the button increases the search speed for each direction.
  - To resume normal playback, press **▶**.

Reverse ◀◀					▶▶ Forward													
Reverse Search 5 steps					Reverse Play	Reverse Slow Motion 3 steps			Slow Motion 3 steps			Normal Play	Forward Search 6 steps					
-360	-60	-15	-5	-3	-1	-1/2	-1/4	-1/16	1/16	1/4	1/2	1	1.5	3	5	15	60	360

## Still Picture/Frame-By-Frame Playback

- 1 Press **⏸** to pause during playback.
- 2 Press **SLOW -** (◀◀) or **SLOW +** (▶▶) to activate frame-by-frame playback.
  - Each press of **SLOW -** (◀◀) or **SLOW +** (▶▶) advances/reverses the still picture frame by frame.
  - To resume normal playback, press **▶**.

## Slow Motion

- 1 Press **⏸** to pause during playback.
- 2 Press **SLOW -** (◀◀) or **SLOW +** (▶▶) for 2 or more seconds.
  - Each press of **SLOW -** (◀◀) or **SLOW +** (▶▶) increases the slow motion speed for each direction.

## Skip Search

- During playback, press **↶**.
- Each press initiates an approximately 30-second period of fast-motion playback. Normal playback resumes automatically.

## Instant Replay

You can move back the playback position slightly.



Press  on the remote control or **INSTANT REPLAY** on the unit.

- Each press skips back for approximately 7 seconds and resumes playback.
- Pressing while paused skips back for approximately 7 seconds and resumes pause.

## 1.5x Speed Playback

You can play back a title quickly. The sound will also be played back faster than normal speed during 1.5x speed playback.

1.5x speed playback cannot be performed during recording on HDD or DVD.

- 1 Press  to locate the point to start 1.5x speed playback from.
- 2 Press  to resume playback.
- 3 Press  once.
  - Pressing **ON SCREEN** displays “X1.5” on the top right corner of the screen.









### NOTES:

- When the unit is connected with a digital audio device using an optical cable, set “DIGITAL AUDIO OUT” to “PCM ONLY”. (pg. 24)
- For programmes recorded in DV mode, 1.5x speed playback with sound is not possible.

## Jump Search



You can locate a scene ahead or behind the current one by jumping scenes according to selected time intervals (pg. 58) during playback (or Live Memory Playback).

Press  or .

- To advance forward or back, press  or  repeatedly within 5 seconds of each press to continue jump.
- Depending on the time from where you want to start jump search, the first press of  or  will not necessarily lead to a jump of the selected time interval. The first press will lead to a jump to the nearest quarter points of an hour (15 min/ 30 min/ 45 min/ 00 min). The subsequent jumps will then be in accordance to the selected time interval.
- When you cannot advance any further (beginning or end of programme reached), the message “UNABLE TO GO BACK ANY MORE” or “UNABLE TO GO FORWARD ANY MORE” appears on the screen. In such a case, press , ,  or .

### Example:

Playback search when jump interval is set to 15 MIN jumps.

Taking for instance, you want to start jump search 40 minutes after the beginning of the programme. Pressing  or  will result in a jump to the scene at the 30 minutes point or 45 minutes point respectively as illustrated below. At the subsequent press, the scene will jump to the 15 minutes point or 1 hour point respectively, according to the selected time interval, which in this case is “15 MIN”.

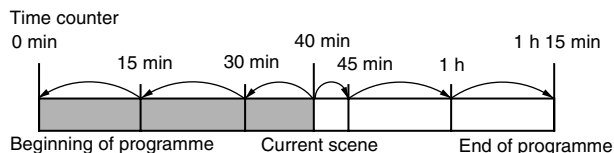

### NOTE:



Jump search functions only when chapters (marks) are not set.

## Marking Positions To Play Back Again Later

It is possible to mark positions (up to 999 points) where you want to play back once again later, and start playback from a marked position. Marking onto the disc when recording is helpful to locate a start point when you play back the disc later.



### To mark positions:

During playback, press **MARK** at positions you want to mark.

- “MARK” appears on the TV screen. You can easily locate the marked positions using  or  when you play back the disc.



### To delete the marked positions:

While paused, press  or  to locate a marked position you want to delete, then press **MARK**.

- Crossed “MARK” appears on the TV screen, and the marked position is deleted.



# Basic Playback

- Turn on the unit.
- Turn on the TV and select the AV mode.
- Slide the **TV/DVD** switch to **DVD**.

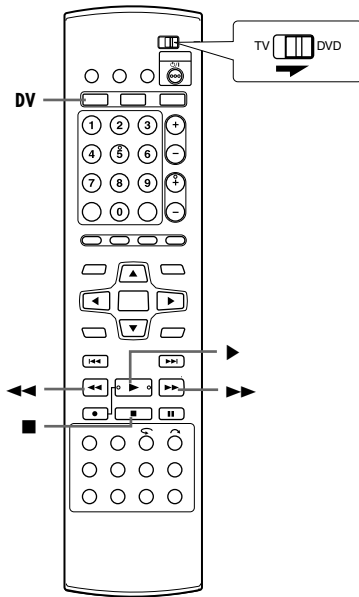
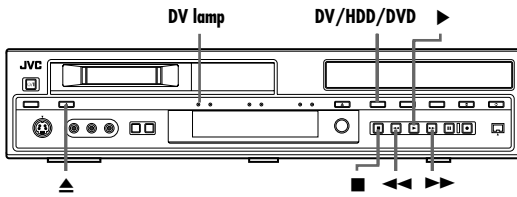

- 1 Load a cassette. Make sure the window side is up, the rear label side is facing you and the arrow on the front of the cassette is pointed toward the unit.
  - Do not apply too much pressure when inserting.
  - If the erase protection switch is set to "SAVE", playback begins automatically. It takes about 15 seconds until the playback picture appears.
  - The unit's power comes on automatically.
- 2 Press **DV/HDD/DVD** on the unit repeatedly or **DV** on the remote control so that the DV lamp lights up on the unit.
- 3 Find the programme start point. If the tape is advanced past the start point, press ◀. To go forward, press ▶▶.
- 4 Press ▶ to start playback.
- 5 Press ■ to stop playback.
  - To eject the cassette, press ▲ (DV). You can also eject the cassette when the unit is turned off.

### Clean the video heads using a dry cleaning cassette - M-DV12CL - when:

- No picture during playback.
- Block noise appears during playback.
- "USE CLEANING CASSETTE" appears on the screen.
- "U01" lights on the front display panel.

#### NOTES:

- The heads get dirty in the following cases:
  - in an environment prone to extreme temperature or humidity
  - in a dusty environment
  - flaw, dirt or mould on video tapes
  - continuous usage for a long time
- "U01" will also light on the front display panel when you attempt to play back a tape recorded with NTSC signals. This unit cannot play back tapes recorded with NTSC signals.

#### Usable cassettes

- Cassettes marked **Mini DV** can be used with the DV deck.
- Tapes recorded in the DVCAM format can be played.

#### NOTES:

- When you record a tape on the DV deck with the recording speed set to "LP", it is recommended to play back that tape back on this DV deck. Digital video recorder from other manufacturers may not be able to play back the tape properly.
- It is possible to play back on the DV deck and the HDD/DVD deck simultaneously. However, either DVD or HDD can be played at the same time.

#### Accidental erasure prevention

To prevent accidental recording on a recorded cassette, set its erase protection switch to "SAVE". To record on it later, set the switch to "REC".

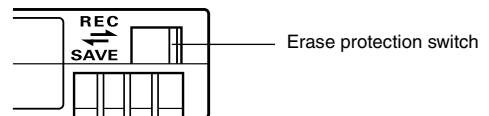

## Playback Features

- Turn on the unit.
- Turn on the TV and select the AV mode.
- Slide the **TV/DVD** switch to **DVD**.
- Press **DV/HDD/DVD** on the unit repeatedly or **DV** on the remote so that the DV lamp lights up on the unit.

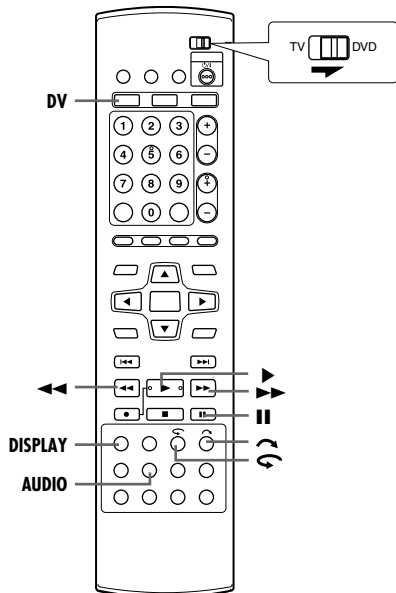

### ATTENTION:

In the search, still, slow-motion or frame-by-frame playback mode, a slight mosaic effect appears on screen.

## Variable Speed Search

During playback, press **▶▶** for forward variable speed search, or **◀◀** for reverse variable speed search.

- Each press of the button increases the search speed for each direction.
- To resume normal playback, press **▶**.



Reverse Search 3 steps			Reverse Slow Motion 1 step	Slow Motion 1 step	Normal Play	Forward Search 3 steps		
-12	-4	-2	-1/5	1/5	1	2	4	12

## Still Picture/Frame-By-Frame Playback

- 1 Press **||** to pause during playback.
- 2 Press **||** to activate frame-by-frame playback.
  - To resume normal playback, press **▶**.

## Slow Motion

- 1 Press **||** to pause during playback.
- 2 Press and hold **||** for 2 seconds, then release. Press **||** and release again to return to still picture.
  - Press **▶▶** for forward slow motion or **◀◀** for reverse slow motion.
  - To resume normal playback, press **▶**.

## Skip Search

During playback, press **↶**.

- Each press initiates an approximately 30-second period of fast-motion playback. Normal playback resumes automatically.

## Instant Replay

During playback, press **↶** on the remote control or **INSTANT REPLAY** on the unit. The unit rewinds the picture a little (about 7 seconds) and resumes playback.

## Next Function Memory

The Next Function Memory "tells" the unit what to do after rewinding. Before continuing, make sure the unit is in the Stop mode.

### For Automatic Start Of Playback

Press **◀◀**, then press **▶** within 2 seconds.

### For Automatic Cassette Ejection After Tape Rewind

Press **◀◀**, then press **▲** (DV) within 2 seconds.

## Soundtrack Selection

Your unit is capable of recording two soundtracks (L and R) and will play back the one you select.

### During Playback

Pressing **AUDIO** changes the soundtrack as follows:

TRACK	USE
<b>On-Screen Display</b>	
L  R	For stereo or Bilingual tapes
L	For main audio of Bilingual tapes
R	For sub audio of Bilingual tapes

To select the audio mode (**SOUND1/SOUND2/MIX**), refer to "AUDIO MODE" under "DV SET UP" (pg. 59).

## Time Code

During recording, a time code is recorded on the tape. This time code is used to confirm the position on the tape when playing back or editing a tape.

- 1 Press **DISPLAY** on the remote control or the unit until the time code on the tape appears on the front display panel and the TV screen.
  - Each time you press **DISPLAY**, the indication changes as follows:  
Time code → Tape remaining time → Clock time → (Back to the beginning)



## Live Memory Playback

HDD DVD RAM DVD R DVD RW DVD VIDEO VCD SVCD Audio CD MP3 JPEG

- Turn on the unit.
- Turn on the TV and select the AV mode.
- Slide the **TV/DVD** switch to **DVD**.
- Press **DV/HDD/DVD** on the unit repeatedly to select the HDD or DVD deck.

This unit records pictures onto the hard disk and DVD-RAM disc, instead of video tapes, then plays back the pictures recorded on the disc. This makes it possible to achieve high-speed writing and read-out that has not been possible with conventional VCRs, enabling recording and playback simultaneously.

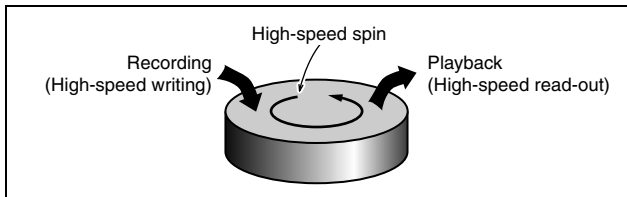

It is called "Live Memory Playback" to start playback of the programme being recorded, with a time-lag between a recording point and a playback point, as shown in the figure below.

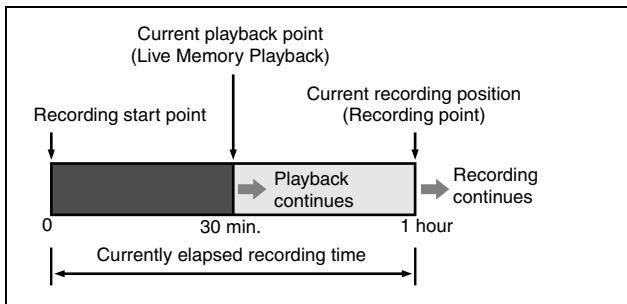

Not only can this unit play back a programme previously recorded while recording another programme, but the unit also allows you to play back from the beginning of a programme while continuing to record the same programme.

## Recording/playback Status Display

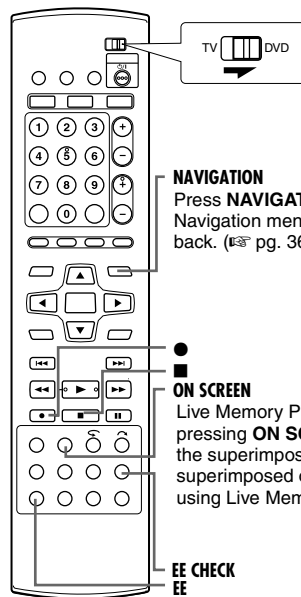

### NAVIGATION

Press **NAVIGATION** to display Library Database Navigation menu, then choose a programme to play back. (pg. 36)

### ON SCREEN

Live Memory Playback status can be checked by pressing **ON SCREEN** to display the bar meter on the superimpose display. The current status is superimposed on the TV screen. (pg. 14, "When using Live Memory playback")

### EE CHECK

### NOTES:

- Live Memory Playback could be performed approximately 30 seconds after recording has started on the DVD-RAM disc. However, for HDD, Live Memory Playback is possible right after recording has started.
- Although high-speed search up to approximately 30 seconds before the current recording point is possible during Live Memory Playback, once the current recording point is reached, the unit resumes normal playback and maintains a delay of approximately 30 seconds so that recording and playback can continue.
- Playback may be paused for a moment during Live Memory Playback, which does not interfere with recording.
- Live Memory Playback cannot be performed while recording the source from DV input. (pg. 48, "DV Dubbing (HDD & DVD Deck Only)")
- When **EE CHECK** is pressed to display the picture currently being recorded, the picture size may not be correct.
- Press **■** or **EE** to stop Live Memory Playback.
- Live Memory Playback cannot be performed while the DVD deck is recording as temporary recording on HDD stops during recording on DVD.

## Buttons To Be Used During Live Memory Playback

- Turn on the unit.
- Turn on the TV and select the AV mode.
- Slide the **TV/DVD** switch to **DVD**.
- Press **HDD** or **DVD** to select the desired deck for Live Memory Playback.

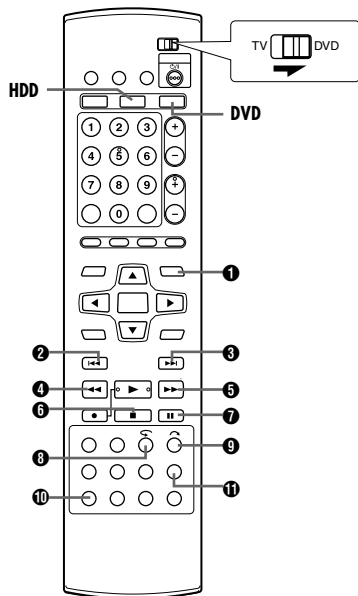

### 1 NAVIGATION

Displays Library Database Navigation menu. You can choose a title to play back.

### 2 ◀◀

- Pressing once skips back to the beginning of the chapter being played back.
- Pressing down for 2 or more seconds during playback reverses playback at 5 times the normal speed while pressed. Releasing the button resumes normal playback.

#### Available only when paused

- Pressing down for 2 or more seconds reverses playback at 1/16 times the normal speed. Releasing the button resumes normal playback.

#### Backward Jump

- Each press of the button during Live Memory Playback jumps back for the selected time interval and resumes playback. (see pg. 30, "Jump Search")

### 3 ▶▶

- Pressing once skips forward to the beginning of the next chapter being played back.
- Pressing down for 2 or more seconds during playback advances playback at 5 times the normal speed while pressed. Releasing the button resumes normal playback.

#### Available only when paused

- Pressing down for 2 or more seconds advances playback at 1/16 times the normal speed. Releasing the button resumes normal playback.

#### Forward Jump

- Each press of the button during Live Memory Playback jumps forward for the selected time interval and resumes playback. (see pg. 30, "Jump Search")

### 4 ◀◀

- Each press of the button during playback advances the playback speed in 6 steps in the reverse direction.

#### Available only when paused

- Each press of the button reverses the still picture frame by frame.
- Pressing down for 2 or more seconds reverses playback at 1/16 times the normal speed. Then, each press of the button reverses slow-motion at 1/16 times, 1/4 times and 1/2 times the normal playback.

### 5 ▶▶

- Each press of the button during playback advances the playback speed in 5 steps in the forward direction.

#### Available only when paused

- Each press of the button advances the still picture frame by frame.
- Pressing down for 2 or more seconds advances playback at 1/16 times the normal speed. Then, each press of the button advances slow-motion at 1/16 times, 1/4 times and 1/2 times the normal playback.

### 6 ■

- Pressing once during Live Memory Playback or RetroActive Recording returns to the external input screen.
- Pressing twice during recording stops recording and returns to the external input screen.

### 7 ||

- Pressing once pauses playback (still picture playback).
- Pressing repeatedly advances the still picture frame by frame.

### 8 ↶

- It is useful when watching sports programmes, etc.
- Each press skips back for approximately 7 seconds and resumes playback.
- Pressing repeatedly skips back for approximately 7 seconds continuously as many times as pressed.

### 9 ↷

- It is useful when skipping over unwanted sections.
- Pressing once skips forward for approximately 30 seconds and resumes playback.
- Pressing repeatedly skips forward continuously as many times as pressed.

### 10 EE

- Returns to an external input screen. When a confirmation message appears by pressing this button during title editing, etc., follow the instruction to return to the previous screen.

### 11 EE CHECK

- You can check, for example, if the programme you are recording has already finished.

- Pressing once displays the picture currently being recorded and the one being played back simultaneously.
- Pressing successively clears the Live Check window and displays only the picture currently being played back.

## Temporary recording for Live Memory (HDD deck only)

This unit automatically records the AV input being received, within the specified range of time, to the reserved space on the hard disk. The time range can be set for 30 minutes, 1 hour, and 3 hours. (pg. 58)

### NOTE:

Previous temporary recordings will be overwritten since the unit is always recording the AV input being received. Thus, it is not possible to play back programmes recorded beyond the specified range of time since they are already overwritten. To avoid this in order to save titles, perform normal recording or RetroActive Recording (See below).

### About limitation on temporary recording

The temporary recording for Live Memory is cancelled in the following cases, and will start all over again when it is to resume.

- When the power is turned off
- When the system is powered again after a power failure was occurred
- When normal recording or RetroActive Recording is performed
- When the "LIVE MEMORY" setting is changed (pg. 58)
- When dubbing is performed by pressing **DUBBING** (pg. 44)
- When "DV" is selected by pressing **INPUT SELECT +/-** (pg. 48)

## RetroActive Recording (HDD deck only)

You can start recording from the previous part of the AV input you are currently watching (temporarily recorded on the background). (See "Temporary recording for Live Memory (HDD deck only)" above.)

- 1** Press **◀◀** or **◀◀** to locate the point to start recording from.
  - Each press of **◀◀** increases the reverse search speed.
- 2** Press **●** on the unit to start RetroActive Recording. Or while holding **●**, press **▶** on the remote control.
- 3** Press **■** twice to stop RetroActive Recording.
  - The external input screen resumes.

### NOTES:

- You cannot use RetroActive Recording for inputs other than the one you are currently watching.
- Recording speed is automatically set to FR65 mode when RetroActive Recording is started.
- Temporarily recorded data prior to the beginning of RetroActive Recording is erased when RetroActive Recording started.

## Simultaneous Recording and Playback

You can play back the previous part of the AV input you are recording or other programmes available in the Library Database.

- 1** Press **NAVIGATION**. The Library Database Navigation screen appears.
- 2** Press **selection keys** to select "ORIGINAL", then press **ENTER**.
- 3** Press **selection keys** to select the desired title, then press **ENTER**.
  - For DVD-RAM, playback starts from the beginning of the title if "CONTINUOUS PLAY" in "DVD SET UP" is set to "ON" (pg. 58).
- 4** Press **selection keys** to select the desired playback method ("BEGINNING", "RESUME" or "REPEAT"), then press **ENTER**.
  - Playback of the selected title begins automatically.
- 5** Press **■** to stop playback.
  - The external input screen resumes.

### NOTES:

- You can use various playback features during Live Memory Playback.
- To stop simultaneous playback, press **■**. The external input screen resumes. To stop actual recording, press **■** twice again.

## Instant Replay

You can move back the playback position slightly during recording or Live Memory Playback.

Press **↶** on the remote control or **INSTANT REPLAY** on the unit.

### ■ DVD-RAM

- Pressing once during recording skips back for approximately 30 seconds and starts Live Memory Playback. While pressing once during Live Memory Playback skips back for approximately 7 seconds and resumes playback.
- Each subsequent press skips back for approximately 7 seconds and resumes playback.
- Pressing while paused skips back for approximately 7 seconds and resumes pause.

### ■ HDD

- Pressing during recording skips back for approximately 7 seconds and starts Live Memory Playback. While pressing during Live Memory Playback skips back for approximately 7 seconds and resumes playback.
- Each press skips back for approximately 7 seconds and resumes playback.
- Pressing while paused skips back for approximately 7 seconds and resumes pause.

## Resuming Playback (HDD deck only)

You can resume playback of an AV input you were recording or watching from the point you have paused.

- 1** Press **||** to pause an AV input.
  - Recording continues when recording.
- 2** Press **▶** to start Live Memory Playback.
  - Playback resumes from the paused position.
- 3** Press **■** to resume the external input screen.

## Library Database Navigation



The Library Database Navigation enables you to search and select the desired titles recorded on the HDD deck and the DVD deck very easily.

You can record up to 99 titles on a disc.

Each time a title is recorded, the information of the title is registered for the Library Database Navigation automatically.

So, you can confirm the information of the titles recorded with the Library Database Navigation screen. And, you can also select one of the titles recorded using the Library Database Navigation.

The following screen appears as the Library Database Navigation screen when you press **NAVIGATION**. You can move the arrow to select the desired position on the screen by pressing **selection keys** on the remote control.

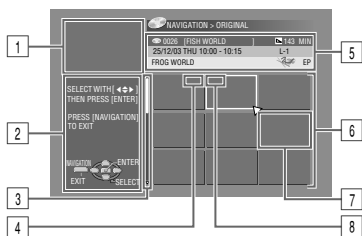

- 1 Playback screen  
(Indicates currently received AV input.)
- 2 Guidance for operations
- 3 Scroll bar  
(Appears when there are over nine registered titles (or play lists). The scroll bar only indicates that there are more titles (or play lists) hidden off the current screen display. To show hidden titles (or play lists), press **selection keys** repeatedly.)
- 4 Title number ( 001, 002, ...)  
(Number assigned to titles for selecting directly via RS-232C the desired title to be played. (pg. 71))
- 5 Recording information for the title indicated by the arrow
- 6 Index list  
(Thumbnail still of each title)  
Thumbnail still is not to be played back.
- 7 Index  
: Indicates no index is registered.  
: Indicates no title is registered.
- 8 Icons  
(Indicate the record condition of each title.)

### The Icons and their meanings

	This title is write-protected.
	This title has not been played back.
	This title is copy-protected.
	This title can only be recorded once (copy-once title).

Using Library Database Navigation system, you can easily modify registered information, edit the title or play list, as well as search for the beginning of each title.

### About registration of information

The following information is automatically registered for each title when ordinary recording is performed, then stored in an area specified on the unit.

- index\* (reduced pictures to show programme titles)
- programme title\*
- category\*
- date and time
- channel
- recording mode
- length of recording time

The items marked with an asterisk (\*) can be easily modified and registered again after recording by using Library Database Navigation system.

### The limitations of registration

You can register information up to 99 titles for the DVD deck and 500 titles for the HDD deck.

When the amount of information is at the limits of registration, you cannot record new titles any more. In this case, you need to delete old titles to register new ones. (pg. 38)

### NOTES:

- Once a DVD-R/RW (Video mode) disc has been finalised, the display for original does not appear. Only display for library appears.
- When a copy-once title recorded on the HDD is dubbed to a DVD disc (DVD-RAM/R/RW (VR mode)), the original data will be moved from the HDD to the DVD disc. In additional, the title that was moved to the DVD disc will become a copy-protected title, and the icon changes from to .
- Sound of received channel may be interrupted while the Library Database Navigation screen is displayed.
- The order of index which are displayed by pressing **DUBBING** differs from the images displayed by pressing **NAVIGATION** or **EDIT**.

## Scan For Beginning Of Title

- Turn on the TV and select the AV mode.
- Slide the **TV/DVD** switch to **DVD**.
- Press **HDD** or **DVD** to choose the corresponding deck.
- Load a DVD disc to scan.

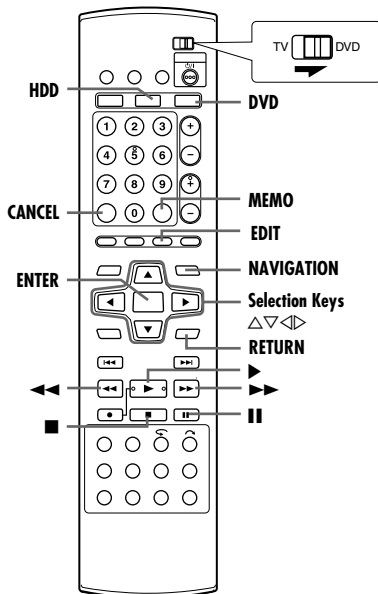

You can scan the beginning of the title easily with the Library Database Navigation.

- 1 Press **NAVIGATION**. The Library Database Navigation screen appears.
- 2 Press **selection keys** to select "ORIGINAL", then press **ENTER**.
- 3 Press **selection keys** to select the index (small pictures) of the desired title, then press **ENTER**.
  - When you want the plural titles to be played back continuously, press **MEMO** after selecting the desired title. The numbers of the playback order appear on the index. You can select up to 8 titles.
  - When you want to correct the order, move the arrow to the desired index and press **MEMO**. The number disappears and the unit re-numbers the other programmes automatically.
  - When you want to cancel the order, press **CANCEL**.
- 4 Press **selection keys** to select "BEGINNING", then press **ENTER**.
  - To resume playback from the point where playback was previously stopped, press **selection keys** to select "RESUME", then press **ENTER**.
  - To repeat playback of a selected title, press **selection keys** to select "REPEAT", then press **ENTER**.
- 5 Press **II** to pause playback.
- To resume normal playback, press **▶**.
- 6 Press **■** to stop playback.



## Edit Original Information



- Turn on the TV and select the AV mode.
- Slide the **TV/DVD** switch to **DVD**.
- Press **HDD** or **DVD** to choose the corresponding deck.
- Load a DVD disc to modify.

### ATTENTION:

It is not possible to modify discs recorded on DVD units from other manufacturers.

## Modify Index

- 1 Press **EDIT**. The Editing screen appears.
- 2 (DVD deck only) Press **selection keys** to select "MODIFY" under "ORIGINAL/PLAY LIST", then press **ENTER**.
- 3 Press **selection keys** to select "MODIFY" under "ORIGINAL", then press **ENTER**.
- 4 Press **selection keys** to select a title you want to modify, then press **ENTER**.
- 5 Press **selection keys** to select "INDEX", then press **ENTER**.
- 6 Press **▶** to start playback. Press **◀◀** or **▶▶** to search for the picture from the title, then press **II**.
  - The pictures of the title appear on the left window.
- 7 Confirm the arrow is on "REPLACE", then press **ENTER** to register new index. New index appears on the right window.
  - When you press **ENTER** with the arrow on "RETURN" you can return to the previous screen.
- 8 Press **EDIT** to return to the normal screen.

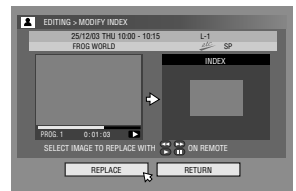

## Modify Title Name

- 1 Perform steps 1 – 4 of "Modify Index" above before continuing.
- 2 Press **selection keys** to select "NAME", then press **ENTER**.
- 3 Press **selection keys** to select "ALPHABET", "SYMBOL1", "SYMBOL2" or "RUSSIAN".
- 4 Press **selection keys** to select the desired letter or symbol, then press **ENTER**. Repeat this process to complete the name.
  - To correct a letter, press **selection keys** to select "DELETE", then press **ENTER**.
  - You can enter the letters up to 64.
- 5 Press **selection keys** to select "SAVE", then press **ENTER**.
- 6 Press **EDIT** to return to the normal screen.



### NOTE:

For DVD-RAM and DVD-R/RW (VR mode) discs, it is not possible to use Russian characters when modifying the title name. The "RUSSIAN" selection will not be selectable and a warning message will appear below the playback screen.

## Modify Category

- 1 Perform steps 1 – 4 of “Modify Index” (pg. 37) before continuing.
- 2 Press **selection keys** to select “CATEGORY”, then press **ENTER**.
- 3 Press **selection keys** to select the desired category, then press **ENTER**.
- 4 Press **EDIT** to return to the normal screen.



## Protect Title

### (DVD-RAM & DVD-R/RW (VR mode) only)

You can protect titles to prevent accidental erasure of the important titles.

- 1 Perform steps 1 – 2 of “Modify Index” (pg. 37) before continuing.
- 2 Press **selection keys** to select “PROTECT”, then press **ENTER**.
- 3 Press **selection keys** to select a title you want to protect, then press **ENTER**.
- 4 Press **selection keys** to select “PROTECT”, then press **ENTER**. “” appears.
  - To cancel the protection, repeat 3 – 4 again. In step 4, select “CANCEL PROTECT”, then press **ENTER**.
- 5 Press **EDIT** to return to the normal screen.

#### NOTE:

All the titles on a disc will be deleted once the disc is formatted even if they are protected titles.

## Delete Title

You cannot record any more with Library Database Navigation once the registered titles on the disc reach 99 titles for the DVD deck and 500 titles for the HDD deck. Deleting unnecessary titles after dubbing or other operations can increase remaining time and available recording capacity. (For DVD-R discs, although it is possible to delete recorded titles, available recording capacity does not increase.) The deleted title is never resumed. Play lists and title information in the unit’s library are also deleted.

- 1 Press **EDIT**. The Editing screen appears.
- 2 (DVD deck only) Press **selection keys** to select “MODIFY” under “ORIGINAL/PLAY LIST”, then press **ENTER**.
- 3 Press **selection keys** to select “DELETE” under “ORIGINAL”, then press **ENTER**.
- 4 Press **selection keys** to select a title you want to delete, then press **ENTER**.
- 5 Press **selection keys** to select “DELETE”, then press **ENTER**.
  - When you cancel the deletion, select “CANCEL”, then press **ENTER**.
- 6 Press **EDIT** to return to the normal screen.

## Delete Unwanted Part Of The Title (HDD, DVD-RAM & DVD-R/RW (VR mode) only)

You can delete unwanted part of the title.

- 1 Perform steps 1 – 2 of “Modify Index” (pg. 37) before continuing.
- 2 Press **selection keys** to select “DEL SCEN”, then press **ENTER**.
- 3 Press **selection keys** to select a title whose unwanted part you want to delete, then press **ENTER**.
- 4 Press **▶** to start playback. Press **◀◀** or **▶▶** to find the point where you want the deletion to begin, then press **II**.
- 5 Confirm the arrow is on “IN”, then press **ENTER**.
- 6 Press **▶** to start playback. Press **◀◀** or **▶▶** to find the point where you want the deletion to end, then press **II**.
- 7 Press **selection keys** to select “OUT”, then press **ENTER**.
  - Select “PREVIEW”, then press **ENTER** to preview the edited title.
- 8 Press **selection keys** to select “OK”, then press **ENTER**.
  - If you do not want to delete the scene, press **RETURN**.

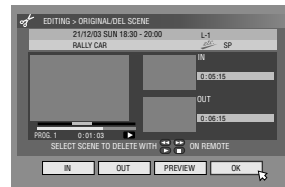

#### To modify the points

- 1 Press **RETURN**.
- 2 Repeat steps 4 – 8 as necessary.
- 9 Press **selection keys** to select “DELETE”, then press **ENTER**. The selected scene is deleted.
  - To cancel the deletion, press **selection keys** to select “CANCEL”, then press **ENTER**.
- 10 Press **EDIT** to return to the normal screen.

#### NOTES:

- There may be a discrepancy of several seconds between the scene you intend to edit, and the scene which is actually edited.
- Available recording capacity may not match the deleted part after deletion.
- For DVD-R discs, although it is possible to delete unwanted part of a title, available recording capacity does not increase.

## Divide Title (HDD deck only)

You can divide titles that are recorded continuously.

- 1 Press **EDIT**. The Editing screen appears.
- 2 Press **selection keys** to select "DIVIDE", then press **ENTER**.
- 3 Press **selection keys** to select a title to divide, then press **ENTER**.
- 4 Press **▶** to start playback. Press **◀◀** or **▶▶** to locate a point to divide, then press **II**.
- 5 Confirm the arrow is on "DIVIDE", then press **ENTER**.
  - The first picture (start) of the newly created title appears in the bottom right window.
  - Select "PREVIEW", then press **ENTER**. The first several seconds of the newly created title is played back, then the playback pauses at the dividing point.
  - To undo the division, press **selection keys** to select "RETRY", then press **ENTER**. Repeat the above procedure to locate another point to divide.
- 6 Press **selection keys** to select "OK", then press **ENTER**.
- 7 Press **selection keys** to select "DIVIDE", then press **ENTER**.
  - Select "CANCEL", then press **ENTER** to return to the previous screen.
- 8 Press **EDIT** to return to the normal screen.

### NOTES:

- There may be a discrepancy of several seconds between the scene you intend to edit, and the scene which is actually edited.
- It is not possible to divide titles that are used in the play list.

## Modify Chapter (HDD, DVD-RAM & DVD-R/RW (VR mode) only)

You can create and delete chapter marks in titles.

- 1 Perform steps 1 – 4 of "Modify Index" (pg. 37) before continuing.
- 2 Press **selection keys** to select "CHAPTER", then press **ENTER**.
- 3 Press **▶** to start playback. Press **◀◀** or **▶▶**, then press **II** at the positions you want to mark.
- 4 Press **selection keys** to select "MARK", then press **ENTER**.
  - To undo the marking, press **selection keys** to select "RETRY", then press **ENTER**.
  - Repeat the above steps 3 and 4 to locate another point to mark.
- 5 Press **◀◀** or **▶▶** to select one chapter you want to delete, press **selection keys** to select "ERASE", then press **ENTER**.
  - To undo the deletion, press **selection keys** to select "RETRY", then press **ENTER**.
- 6 Press **EDIT** to return to the normal screen.

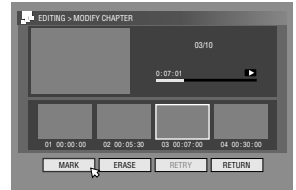

### NOTE:

There may be a discrepancy of several seconds between the scene you intend to edit, and the scene which is actually edited.

## Edit Play List Information



- Turn on the TV and select the AV mode.
- Slide the TV/DVD switch to DVD.
- Press HDD or DVD to choose the corresponding deck.
- Load a DVD disc to modify.

### ATTENTION:

It is not possible to modify discs recorded on DVD units from other manufacturers.

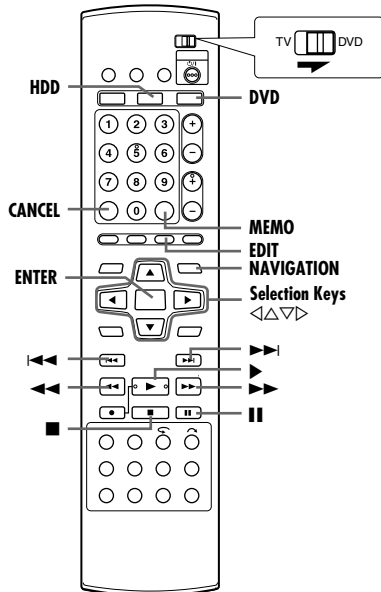

### Play List

It is a collection of the scenes. A play list can be freely edited and played back without ever changing any original recording data. Using the random access of a disc (which allows video data to be instantly read no matter where it is on the disc), a play list includes information such as the timer counter for the playback start point and end point, indexes for checking the contents of recorded data, category information, and more. Playback according to a play list you have created allows you to enjoy various combinations of video images from a single title.

## Create Play List

- 1 Press **EDIT**. The Editing screen appears.
- 2 (DVD deck only) Press **selection keys** to select "MODIFY" under "ORIGINAL/PLAY LIST", then press **ENTER**.
- 3 Press **selection keys** to select "CREATE", then press **ENTER**.
- 4 Press **selection keys** to select a title that includes scenes to be included in a play list, then press **ENTER**.
- 5 Press **▶** to start playback. Press **◀** or **▶▶** to find the point where you want the created play list to begin, then press **||**.
- 6 Confirm the arrow is on "IN/OUT", then press **ENTER**.
  - The edit-in time is displayed on the screen.
  - To undo, press **selection keys** to select "RETRY", then press **ENTER**.
- 7 Press **▶** to start playback. Press **◀** or **▶▶** to find the point where you want the created play list to end, then press **||**.
- 8 Confirm the arrow is on "IN/OUT", then press **ENTER**.
  - The edit-out time is displayed on the screen.
  - The edit-out point must come after the edit-in point.
  - Select "PREVIEW", then press **ENTER** to preview the play list.
- 9 Press **selection keys** to select "OK", then press **ENTER**.
- 10 Press **selection keys** to select "EXIT", then press **ENTER**.
- 11 Press **EDIT** to return to the normal screen.



### NOTES:

- There may be a discrepancy of several seconds between the scene you intend to edit, and the scene which is actually edited.
- The title, index and category of the play list can be modified in the same way as "ORIGINAL". (pg. 37)
- You can modify the play list that has just been created here by adding, moving, or deleting unwanted parts to create a digest edition, etc.

## Edit Scenes

- 1 Press **EDIT**. The Editing screen appears.
- 2 (DVD deck only) Press **selection keys** to select "MODIFY" under "ORIGINAL/PLAY LIST", then press **ENTER**.
- 3 Press **selection keys** to select "MODIFY" under "PLAY LIST", then press **ENTER**.
- 4 Press **selection keys** to select a play list to modify, then press **ENTER**.
- 5 Press **selection keys** to select "SCENE", then press **ENTER**.
- 6 Press **selection keys** to select "MODIFY", then press **ENTER**.
- 7 Press **selection keys** to select the start or end point of a scene to modify, then press **ENTER**.
- 8 Perform steps 5 – 11 of "Create Play List" above.



## Add scenes

- 1 Perform steps 1 – 5 of “Edit Scenes” (pg. 40) before continuing.
- 2 Press **selection keys** to select “SEL. TITLE”, then press **ENTER**.
- 3 Perform steps 4 – 11 of “Create Play List” (pg. 40).

## Move Scenes

- 1 Perform steps 1 – 5 of “Edit Scenes” (pg. 40) before continuing.
- 2 Press **selection keys** to select “MOVE”, then press **ENTER**.
- 3 Press **selection keys** to select a scene to move, then press **ENTER**.
- 4 Press **selection keys** to select another scene to which the scene is to be moved, then press **ENTER**.
  - To cancel the move, press **selection keys** to select “RETRY”, then press **ENTER**.
- 5 Perform steps 9 – 11 of “Create Play List” (pg. 40).

## Delete Scenes

- 1 Perform steps 1 – 5 of “Edit Scenes” (pg. 40) before continuing.
- 2 Press **selection keys** to select “DELETE”, then press **ENTER**.
- 3 Press **selection keys** to select a scene to delete, then press **ENTER**.
- 4 Perform steps 9 – 11 of “Create Play List” (pg. 40).

## Play Back Play List

- 1 Press **NAVIGATION**. The Library Database Navigation screen appears.
- 2 Press **selection keys** to select “PLAY LIST”, then press **ENTER**.
- 3 Press **selection keys** to select the index (small pictures) of the desired play list, then press **ENTER**.
  - When you want the plural play lists to be played back continuously, press **MEMO** after selecting the desired play lists. The numbers of the playback order appear on the index. You can select up to 8 play lists.
  - When you want to correct the order, move the arrow to the desired index and press **MEMO**. The number disappears and the unit re-numbers the other play lists automatically.
  - When you want to cancel the order, press **CANCEL**.
- 4 Press **selection keys** to select “BEGINNING”, then press **ENTER**. The playback starts.
  - Upon completing play list playback, the normal screen will resume.
  - The normal screen will also resume when **■** is pressed to stop play list playback.



Play list number

### NOTE:

The play list number on the top right corner of the index is for selecting directly via RS-232C the desired play list to be played. (pg. 71)

## Delete Play List

- 1 Press **EDIT**. The Editing screen appears.
- 2 (DVD deck only) Press **selection keys** to select “MODIFY” under “ORIGINAL/PLAY LIST”, then press **ENTER**.
- 3 Press **selection keys** to select “DELETE” under “PLAY LIST”, then press **ENTER**.
- 4 Press **selection keys** to select one play list you want to delete, then press **ENTER**.
- 5 Press **selection keys** to select “DELETE”, then press **ENTER**.
  - When you cancel the deletion, select “CANCEL”, then press **ENTER**.
- 6 Press **EDIT** to return to the normal screen.

### NOTE:

Even if a play list is deleted, the titles recorded and the library information are not affected at all.

## Modify Index

- 1 Perform steps 1 – 4 of “Edit Scenes” (pg. 40) before continuing.
- 2 Perform steps 5 – 8 of “Modify Index” (pg. 37).

## Modify Play List Name

- 1 Perform steps 1 – 4 of “Edit Scenes” (pg. 40) before continuing.
- 2 Perform steps 2 – 6 of “Modify Title Name” (pg. 37).

## Modify Category

- 1 Perform steps 1 – 4 of “Edit Scenes” (pg. 40) before continuing.
- 2 Perform steps 2 – 4 of “Modify Category” (pg. 38).

## Navigate Library Information



Title information can be registered in the unit's memory for up to 600 DVD discs, 2,000 titles. It is helpful when finding a desired title (or play list) by sorting according to the sort options registered during (or after) recording.

- Turn on the TV and select the AV mode.
- Slide the **TV/DVD** switch to **DVD**.
- Press **HDD** or **DVD** to choose the corresponding deck.

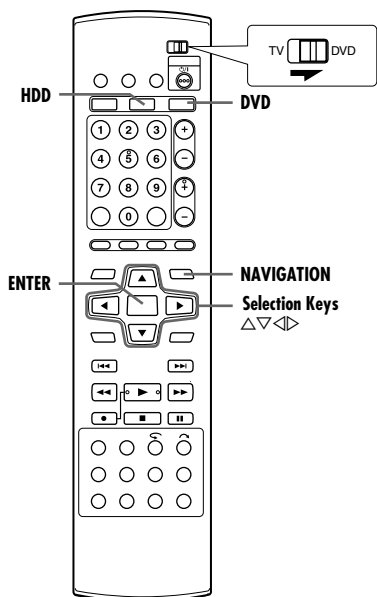

## Scan For Title From Library

- 1 Press **NAVIGATION**. The Library Database Navigation screen appears.
- 2 Press **selection keys** to select the appropriate sort button to sort the information, then press **ENTER**.
  - “DATE”:  
Sort by date
  - “DISC No.”:  
Sort by disc number
  - “CATEGORY”:  
Sort by category
  - “NAME”:  
Sort by name
  - “DATE” and “DISC No.” are available for the DVD deck only.
- 3 Press **selection keys** to select the desired title, then press **ENTER**.
  - For HDD deck, playback begins automatically after the selected title is located.
  - For DVD deck, the title information will be displayed after the selected title is located. However, playback will not begin automatically.

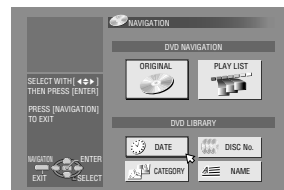

### NOTE:

If a disc registered in the library is recorded or modified on DVD units from other manufacturers, it may become impossible to operate properly.

## Register Disc

When a disc that is not registered in the library is loaded, a message appears confirming if the disc should be registered. If registering, perform the following procedure.

- 1 Press **selection keys** to select “REGISTER”, then press **ENTER** to confirm the registration.
- 2 Press **NAVIGATION** to return to the normal screen.

### NOTES:

- It is not possible to register discs formatted on devices other than JVC's DVD recorders.
- It is not possible to register discs recorded on devices other than JVC's DVD recorders.
- It is not possible to register discs when “SAVE AS LIBRARY” is set to “OFF”. (pg. 58)

# Playback With MP3/WMA/JPEG Navigation



This unit can play back discs that MP3/WMA sound files and JPEG image files taken with digital still cameras or other devices are recorded.

The MP3/WMA/JPEG Navigation enables you to search and select the desired files recorded on CD-R/RW or CD-ROM discs very easily.

- Turn on the TV and select the AV mode.
- Slide the TV/DVD switch to DVD.
- Press DVD to select the DVD deck.

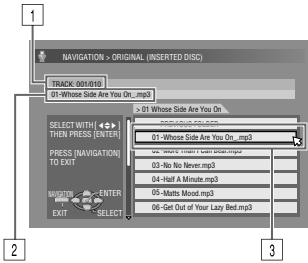

- 1 Selected file number/total number of files in the group that contains the selected file
- 2 Name of the selected file
- 3 Selected file

**NOTES:**

- If there are more than 100 files, the rest of the files are not displayed. In this case, press **ON SCREEN** to display them on the TV screen.
- The on-screen bar will display “MP3/WMA” regardless of whether MP3 or WMA files are played.
- If both MP3/WMA files and JPEG files are recorded on the same disc, you can select to play back either of the file types using the “MP3&WMA/JPEG” setting. (pg. 58)

## Locating The Desired Folders And Tracks

- 1 Load a disc.
- 2 Press **NAVIGATION**.
- 3 Press **selection keys** to select “ORIGINAL”, then press **ENTER**.
- 4 Press **selection keys** to select the desired folder, then press **ENTER**.
  - A list of files in the selected folder appears.

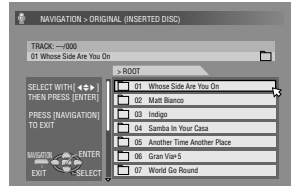

- 5 Press **selection keys** to select the desired item, then press **ENTER**. The unit starts playback from the selected item.
  - The unit stops when all items in the selected folder are played back.

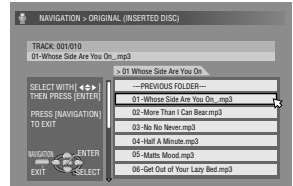

**NOTES:**

- If you press **▶** instead of **ENTER** in step 4, the unit starts playback from the first file of the folder.
- JPEG files are played back as a slide show at the set intervals. (pg. 28)
- If a file name includes any 2-byte character, the unit may not show the file name correctly.
- The order of the folders and items shown in steps 4 and 5 may differ from the order shown on your PC.

## Dubbing

- Turn on the unit.
- Turn on the TV and select the AV mode.
- Slide the TV/DVD switch to DVD.

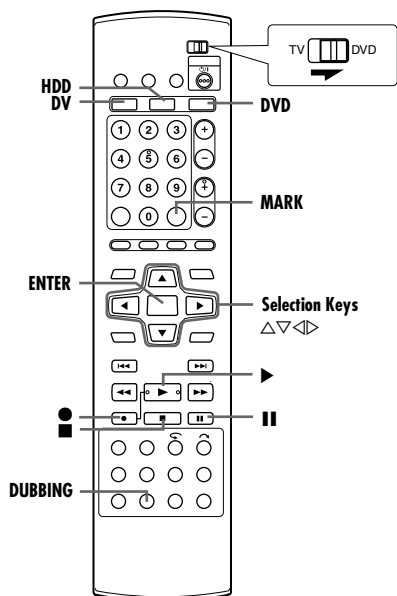

### Auto Finalising

When dubbing from a Mini DV or HDD to a DVD-R/RW (Video mode) disc, you can select whether to finalise the disc automatically after dubbing has been completed. It is also possible to set the operation method of a DVD-R/RW (Video mode) disc when finalising the disc. Each time the finalised disc is played back, it will be played back in accordance to the setting you have selected during finalisation. For details, refer to "DISC TYPE" (pg. 61).

#### NOTE:

You can select and set the background to be used when Auto Finalising a DVD-R/RW (Video mode) disc. For details, refer to "Setting The Background And Text Colour" (pg. 64).

#### NOTES:

- It is not possible to dub copy-protected contents. An error message will appear on the TV screen.
- The order of the index which is displayed by pressing **DUBBING** differs from the images displayed by pressing **NAVIGATION** or **EDIT**.

## High Speed Dubbing (From HDD To DVD)

It is possible to dub the original recordings and/or play lists on the HDD deck to DVD discs. The dubbing is performed in high speed, keeping the original transfer rate.

#### NOTES:

- After accessing the Dubbing Menu screen, it is not possible to take out a disc.
- It is not possible to dub copy-once titles in Video mode.
- When dubbing a copy-once title, the data will be moved from HDD to DVD upon completing dubbing.
- When you cancel dubbing a copy-once title during dubbing, the original recording on the HDD deck remains and the title copied to a DVD disc is deleted.
- It is not possible to dub play lists which contain copy-once titles.
- It is not possible to dub the following programmes to DVD-R/RW disc (Video mode):
  - which contains more than one audio language.
  - which is on the play list.
  - which is edited (also RetroActive Recording).
  - which is recorded in LP mode or FR155-FR240 mode.

- Recording may not be performed in the highest speed depending on the characteristics of the disc used.

- 1 Load a recordable disc.
- 2 Press **DUBBING** to access the Dubbing Menu screen.
- 3 Press **selection keys** to select "HDD→DVD", then press **ENTER**.
- 4 Press **selection keys** to select "HIGH SPEED", then press **ENTER**.
- 5 Press **selection keys** to select indexes (small pictures) of desired original recordings and/or play lists, then press **MARK**. After selecting all indexes you want to dub, press **ENTER**.
  - You can select up to 8 original recordings and/or play lists.
  - The recordable time of the disc is displayed on the bar meter. For details, refer to "About Disc Remaining Display" (pg. 47).
  - When dubbing to a DVD-RAM or DVD-R/RW (VR mode) disc, if there are Russian characters in the title names, a warning message will appear on the TV screen. If you choose to continue with the dubbing, the Russian characters in the title names will be deleted after dubbing is completed.
- 6 Press **selection keys** to select "EXECUTE" or "AUTO FINALISE", then press **ENTER** to start dubbing.

#### NOTES:

- Play lists are dubbed as programmes.
- In Video mode, if the selected play list includes the scenes recorded in the different transfer rate, the dubbing is performed in the highest transfer rate of the scenes in the selected play list.
- During dubbing, it is not possible to play back on HDD or DVD.
- It is not possible to discontinue dubbing once it has been started.

## Just Dubbing (From HDD To DVD)

By using Just Dubbing function, when dubbing all selected original recordings and/or play lists, the unit automatically sets the appropriate recording mode depending on the combination of the total time of the selected recordings and/or play lists to be dubbed and the available disc space.

- 1 Load a recordable disc.
- 2 Press **DUBBING** to access the Dubbing Menu screen.
- 3 Press **selection keys** to select "HDD→DVD", then press **ENTER**.
- 4 Press **selection keys** to select "JUST", then press **ENTER**.
- 5 Perform steps 5 – 6 of "High Speed Dubbing (From HDD To DVD)".

#### NOTES:

- Play lists are dubbed as programmes.
- In Video mode, if the selected play list includes the scenes recorded in the different transfer rate, the dubbing is performed in the highest transfer rate of the scenes in the selected play list. However, the lower transfer rate cannot be dubbed in the higher transfer rate.
- The recordable time of the disc is displayed on the bar meter. For details, refer to "About Disc Remaining Display" (pg. 47).
- During dubbing, it is not possible to play back on HDD or DVD.
- It is not possible to discontinue dubbing once it has been started.

## Manual Dubbing (From HDD To DVD)

It is possible to perform dubbing in the desired transfer rate.

- 1 Load a recordable disc.
- 2 Press **DUBBING** to access the Dubbing Menu screen.
- 3 Press **selection keys** to select "HDD→DVD", then press **ENTER**.
- 4 Press **selection keys** to select "MANUAL", then press **ENTER**.
- 5 Perform step 5 of "High Speed Dubbing (From HDD To DVD)". The Manual Dubbing screen appears.
- 6 Press **selection keys** to select "REC MODE", then press **ENTER**. Press **selection keys** to select the desired option, then press **ENTER**.

- For details on the recording mode, see “Recording Mode” (pg. 49)

**7** Press  $\nabla$  to select “CONFIRM”, then press **ENTER**.

**8** Press **selection keys** to select “EXECUTE” or “AUTO FINALISE”, then press **ENTER** to start dubbing.

#### NOTES:

- In Video mode, if the selected play list includes the scenes recorded in the different transfer rate, the dubbing is performed in the highest transfer rate of the scenes in the selected play list. However, the lower transfer rate cannot be dubbed in the higher transfer rate.
- The recordable time of the disc is displayed on the bar meter. For details, refer to “About Disc Remaining Display” (pg. 47).
- During dubbing, it is not possible to play back on HDD or DVD.
- It is not possible to discontinue dubbing once it has been started.

## Dubbing From HDD To DV

It is possible to perform dubbing from the HDD deck to the DV deck.

**1** Load a Mini DV cassette with the erase protection switch set to “REC”.

**2** Press **DUBBING** to access the Dubbing Menu screen.

**3** Press **selection keys** to select “HDD→DV”, then press **ENTER**.

**4** Press **selection keys** to select indexes (small pictures) of desired original recordings and/or play lists, then press **MARK**. After selecting all indexes you want to dub, press **ENTER**.

- You can select up to 8 original recordings and/or play lists.

**5** Press **selection keys** to select “SELECT REC. MODE”, then press **ENTER**. Press **selection keys** to select the desired option, then press **ENTER**.

**6** Press **selection keys** to select “SELECT SND. MODE”, then press **ENTER**. Press **selection keys** to select the desired option, then press **ENTER**.

**7** Press  $\nabla$  to select “CONFIRM”, then press **ENTER**. The confirmation screen appears.

**8** Press  $\blacktriangleright$  to locate the point from where you want to start dubbing, press  $\blacksquare$  or  $\blacksquare$  then press  $\bullet$  and  $\blacksquare$  simultaneously so that the DV deck enters the record pause mode.

- The dubbing screen will appear.

**9** Press **selection keys** to select “EXECUTE”, then press **ENTER** for confirmation.

- To cancel the dubbing, press  $\blacksquare$  then **selection keys** to select “CANCEL” and press **ENTER** to confirm.

**10** Upon completing dubbing, the tape stops and “DUBBING COMPLETED” appears on the TV screen. Press **ENTER** to end.

## Original Dubbing (From DVD To HDD)

It is possible to dub the original recordings on DVD discs to the HDD deck.

**1** Load a disc you want to dub.

**2** Press **DUBBING** to access the Dubbing Menu screen.

**3** Press **selection keys** to select “DVD→HDD”, then press **ENTER**.

**4** Press **selection keys** to select indexes (small pictures) of desired original recordings, then press **MARK**. After selecting all indexes you want to dub, press **ENTER**.

- You can select up to 8 original recordings.

**5** Press **selection keys** to select “EXECUTE”, then press **ENTER** to start dubbing.

#### NOTES:

- It is not possible to dub play lists on DVD discs.
- It is not possible to dub pre-recorded DVD VIDEO discs.
- It is not possible to dub Video CDs/SVCDs or Audio CDs.
- It is not possible to dub from +R/+RW discs.
- It is not possible to discontinue dubbing once it has been started.

## Dubbing From DVD To DV

It is possible to perform dubbing from the DVD deck to the DV deck.

**1** Load the disc you want to dub onto the DVD deck, and a Mini DV cassette with the erase protection switch set to “REC” to the DV deck.

**2** Press **DUBBING** to access the Dubbing Menu screen.

**3** Press **selection keys** to select “DVD→DV”, then press **ENTER**.

**4** Press **selection keys** to select indexes (small pictures) of desired original recordings, then press **MARK**. After selecting all indexes you want to dub, press **ENTER**.

- You can select up to 8 original recordings.

**5** Press **selection keys** to select “SELECT REC. MODE”, then press **ENTER**. Press **selection keys** to select the desired option, then press **ENTER**. The confirmation screen appears.

**6** Press **selection keys** to select “SELECT SND. MODE”, then press **ENTER**. Press **selection keys** to select the desired option, then press **ENTER**.

- Sound mode selection is not available when dubbing a DVD-R/RW (Video mode) disc.

**7** Press  $\nabla$  to select “CONFIRM”, then press **ENTER**. The confirmation screen appears.

**8** Press  $\blacktriangleright$  to locate the point from where you want to start dubbing, press  $\blacksquare$  or  $\blacksquare$  then press  $\bullet$  and  $\blacksquare$  simultaneously so that the DV deck enters the record pause mode.

- The dubbing screen will appear.

**9** Press **selection keys** to select “EXECUTE”, then press **ENTER** to confirm.

- To cancel the dubbing, press  $\blacksquare$  then **selection keys** to select “CANCEL” and press **ENTER** to confirm.

**10** Upon completing dubbing, the tape stops and “DUBBING COMPLETED” appears on the TV screen. Press **ENTER** to end.

#### NOTES:

- It is not possible to dub play lists on DVD discs.
- It is not possible to dub Video CDs/SVCDs or Audio CDs.
- It is not possible to dub from +R/+RW discs.
- When dubbing is in progress, only  $\blacksquare$  is functional.

## Dubbing From DV To HDD (Dubbing An Entire Cassette)

It is possible to perform automatic dubbing of all the recorded programmes of a cassette from the DV deck to the HDD deck using the "ENTIRE" dubbing. You cannot select the images to be dubbed; all recorded images on the DV cassette will be dubbed.

- 1 Load the Mini DV cassette you want to dub. Make sure its erase protection switch is set to "SAVE".
  - Set "DV AUDIO REC" to the appropriate mode. (Ⓝ pg. 59)
- 2 Press **DUBBING** to access the Dubbing Menu screen.
- 3 Press **selection keys** to select "DV→HDD", then press **ENTER**.
- 4 Select "ENTIRE", then press **ENTER**.
- 5 Press **selection keys** to select "SELECT REC. MODE", then press **ENTER**. Press **selection keys** to select the desired option, then press **ENTER**.
  - To dub DV format contents in its original DV format, select "DV".
- 6 Press **selection keys** to select "SELECT SND. MODE", then press **ENTER**. Press **selection keys** to select the desired option, then press **ENTER**.
- 7 Press  $\nabla$  to select "CONFIRM", then press **ENTER**. The confirmation screen appears.
- 8 Press **selection keys** to select "EXECUTE", then press **ENTER** for confirmation.
  - Once dubbing starts, it will continue dubbing until the end of the tape is reached.
  - To cancel the dubbing, press  $\blacksquare$  then **selection keys** to select "CANCEL" and press **ENTER** to confirm.
  - If the tape is not rewind, the unit will start dubbing after automatically rewinding the tape to the beginning.
- 9 Upon completing dubbing, the tape stops and "DUBBING COMPLETED" appears on the TV screen. Press **ENTER** to end.
  - The tape will automatically be rewind.

### NOTES:

- When there are blanks on the tape of more than 2 seconds, the HDD deck will enter into pause mode while playback on DV deck continues. This also applies to portions of the DV tape that are damaged or unreadable. The last image is displayed on the TV screen. Dubbing will resume once recorded portion is detected. If the blank portion continues until the end of the tape, "DUBBING COMPLETED" appears on the TV screen when the tape end is reached and the tape rewinds automatically.
- Dubbing copyright guarded tape is not possible.
- When dubbing is in progress,  $\blacksquare$ , **ON SCREEN** and **AUDIO** buttons are functional.

## Dubbing From DV To HDD (Dubbing A Part A Cassette)

It is possible to select the images on the DV cassette to be dubbed from the DV deck to the HDD deck using "MANUAL" dubbing.

- 1 Load the Mini DV cassette you want to dub. Make sure its erase protection switch is set to "SAVE".
  - Set "DV AUDIO REC" to the appropriate mode. (Ⓝ pg. 59)
- 2 Press **DUBBING** to access the Dubbing Menu screen.
- 3 Press **selection keys** to select "DV→HDD", then press **ENTER**.
- 4 Select "MANUAL", then press **ENTER**.
- 5 Press **selection keys** to select "SELECT REC. MODE", then press **ENTER**. Press **selection keys** to select the desired option, then press **ENTER**.
  - To dub DV format contents in its original DV format, select "DV".
- 6 Press **selection keys** to select "SELECT SND. MODE", then press **ENTER**. Press **selection keys** to select the desired option, then press **ENTER**.

- 7 Press  $\nabla$  to select "CONFIRM", then press **ENTER**. The confirmation screen appears.
- 8 Press **selection keys** to select "EXECUTE", then press **ENTER** for confirmation.
  - If the DV deck is in the stop mode, the unit will start dubbing from the current tape position.
  - If the DV deck is in the pause mode, the unit will start dubbing from the point where the tape was paused after automatically rewinding the tape for 2 seconds.
  - To cancel the dubbing, press  $\blacksquare$  then **selection keys** to select "CANCEL" and press **ENTER** to confirm.
- 9 Upon completing dubbing, the tape stops and "DUBBING COMPLETED" appears on the TV screen. Press **ENTER** to end.
  - The tape will automatically be rewind.

### NOTES:

- When there are blanks on the tape of more than 2 seconds, the HDD deck will enter into pause mode while playback on DV deck continues. This also applies to portions of the DV tape that are damaged or unreadable. The last image is displayed on the TV screen. Dubbing will resume once recorded portion is detected. If the blank portion continues until the end of the tape, "DUBBING COMPLETED" appears on the TV screen when the tape end is reached and the tape rewinds automatically.
- Dubbing copyright guarded tape is not possible.
- When dubbing is in progress,  $\blacksquare$ , **ON SCREEN** and **AUDIO** buttons are functional.

## Dubbing From DV To DVD (Dubbing An Entire Cassette)

It is possible to perform automatic dubbing of all the recorded programmes of a cassette from the DV deck to the DVD deck using the "ENTIRE" dubbing. You cannot select the images to be dubbed; all recorded images on the DV cassette will be dubbed.

- 1 Load the Mini DV cassette you want to dub. Make sure its erase protection switch is set to "SAVE".
  - Set "DV AUDIO REC" to the appropriate mode. (Ⓝ pg. 59)
- 2 Press **DUBBING** to access the Dubbing Menu screen.
- 3 Press **selection keys** to select "DV→DVD", then press **ENTER**.
- 4 Select "ENTIRE", then press **ENTER**.
- 5 Press **selection keys** to select "SELECT REC. MODE", then press **ENTER**. Press **selection keys** to select the desired option, then press **ENTER**.
- 6 Press **selection keys** to select "SELECT SND. MODE", then press **ENTER**. Press **selection keys** to select the desired option, then press **ENTER**.
- 7 Press  $\nabla$  to select "CONFIRM", then press **ENTER**. The confirmation screen appears.
- 8 Press **selection keys** to select "EXECUTE" or "AUTO FINALISE", then press **ENTER** for confirmation.
  - Once dubbing starts, it will continue dubbing until the end of the tape is reached.
  - To cancel the dubbing, press  $\blacksquare$  then **selection keys** to select "CANCEL" and press **ENTER** to confirm.
  - If the tape is not rewind, the unit will start dubbing after automatically rewinding the tape to the beginning.
- 9 Upon completing dubbing, the tape stops and "DUBBING COMPLETED" appears on the TV screen. Press **ENTER** to end.
  - The tape will automatically be rewind.

### NOTES:

- The programme information at the DV deck will not be dubbed.
- When there are blanks on the tape of more than 2 seconds, the DVD deck will enter into pause mode while playback on DV deck continues. This also applies to portions of the DV tape that are damaged or unreadable. The last image is displayed on the TV screen. Dubbing will resume once recorded portion is detected. If the blank portion continues until the end of the tape, "DUBBING

COMPLETED" appears on the TV screen when the tape end is reached and the tape rewinds automatically.

- Dubbing copyright guarded tape is not possible.
- When dubbing is in progress, **■** and **ON SCREEN** buttons are functional.

## Dubbing From DV To DVD (Dubbing A Part Of A Cassette)

It is possible to select the images on the DV cassette to be dubbed from the DV deck to the DVD deck using "MANUAL" dubbing.

- 1 Load the Mini DV cassette you want to dub. Make sure its erase protection switch is set to "SAVE".
  - Set "DV AUDIO REC" to the appropriate mode. (pg. 59)
- 2 Press **DUBBING** to access the Dubbing Menu screen.
- 3 Press **selection keys** to select "DV→DVD", then press **ENTER**.
- 4 Select "MANUAL", then press **ENTER**.
- 5 Press **selection keys** to select "SELECT REC. MODE", then press **ENTER**. Press **selection keys** to select the desired option, then press **ENTER**.
- 6 Press **selection keys** to select "SELECT SND. MODE", then press **ENTER**. Press **selection keys** to select the desired option, then press **ENTER**.
- 7 Press **▽** to select "CONFIRM", then press **ENTER**. The confirmation screen appears.
- 8 Press **selection keys** to select "EXECUTE" or "AUTO FINALISE", then press **ENTER** for confirmation.
  - If the DV deck is in the stop mode, the unit will start dubbing from the current tape position.
  - If the DV deck is in the pause mode, the unit will start dubbing from the point where the tape was paused after automatically rewinding the tape for 2 seconds.
  - To cancel the dubbing, press **■** then **selection keys** to select "CANCEL" and press **ENTER** to confirm.
- 9 Upon completing dubbing, the tape stops and "DUBBING COMPLETED" appears on the TV screen. Press **ENTER** to end.
  - The tape will automatically be rewound.

### NOTES:

- The programme information at the DV deck will not be dubbed.
- When there are blanks on the tape of more than 2 seconds, the DVD deck will enter into pause mode while playback on DV deck continues. This also applies to portions of the DV tape that are damaged or unreadable. The last image is displayed on the TV screen. Dubbing will resume once recorded portion is detected. If the blank portion continues until the end of the tape, "DUBBING COMPLETED" appears on the TV screen when the tape end is reached and the tape rewinds automatically.
- Dubbing copyright guarded tape is not possible.
- When dubbing is in progress, **■** and **ON SCREEN** buttons are functional.

### About Disc Remaining Display

When dubbing from HDD to DVD, the unit displays the time information for dubbing by bar meter. By comparing the disc remaining time and the necessary time for dubbing of the selected items, it is possible to check if the dubbing can be performed completely or not.

#### When performing the High Speed Dubbing

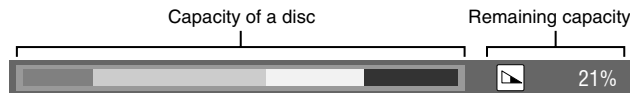

Dark green: Length of already recorded item  
 Light green: Length of selected item  
 Yellow: Length of the item now being selected by arrow  
 Red: Excess over the capacity

#### When performing the Just Dubbing



- The unit displays the status on the assumption that the selected items are dubbed in the lowest transfer rate.
- The total time of a loaded disc is displayed on the right of the bar meter.

#### When performing the Manual Dubbing



- The unit displays the status on the assumption that the selected items are dubbed in the lowest transfer rate.
- The available highest transfer rate is displayed on the right of the bar meter.

## DV Dubbing (HDD & DVD Deck Only)

You can dub programmes from a camcorder or DV equipment connected to the unit with a DV cable. The unit's remote control allows you the limited control of the connected camcorder or DV equipment functions during dubbing.

### NOTE:

When connecting the unit to a device equipped with a DV input connector, be sure to use the optional DV cable (VC-VDV 204U).

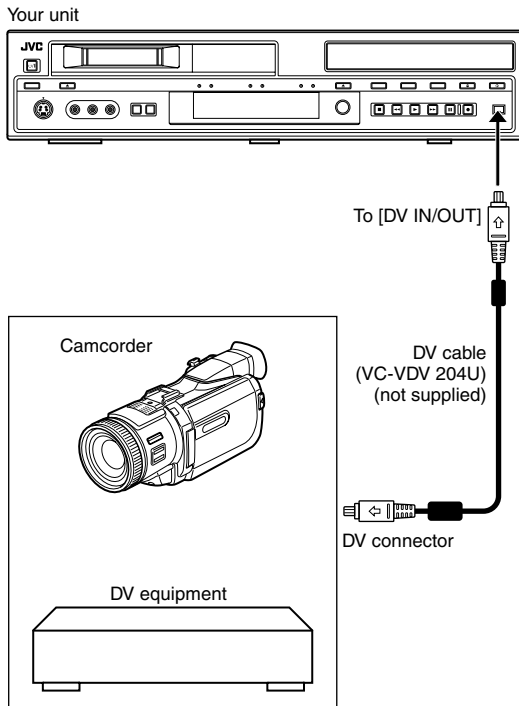

The following on-screen display for DV dubbing appears when **ON SCREEN** is pressed while the channel has been set to "DV".

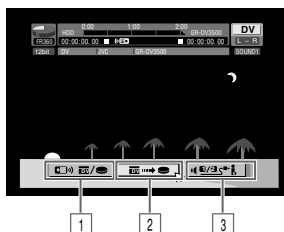

### 1 Remote control switch

To switch between the devices operable by the remote control unit. The unit is operable when the remote icon ( ) displayed faces to the left, while the DV device is operable when the remote icon is facing to the right.

### 2 Auto capture button

Select to start or pause the dubbing. If **ENTER** is pressed when the DV device is in the pause condition, preroll editing\* where it is possible to dub with a start time that is highly accurate will be activated. When the DV device cannot be operated from the unit (such as in camera mode), proceed with normal recording.

- Do not start dubbing at the portion with no time code ("--:--:--").

\* Preroll editing refers to the playback after the DV tape is slightly rewind. (For DV devices that do not support the -1x speed, the rewinding time may be longer.)

### 3 Sound monitor switch

For selecting the desired sound format for dubbing.

- Connect a camcorder or DV equipment to the [DV IN/OUT] connector on the unit's front panel.

- Press **DV/HDD/DVD** on the unit repeatedly; or press **HDD** or **DVD** on the remote control to select the recording deck.
  - When dubbing to a DVD disc, load a recordable disc on this unit.
- Press **INPUT SELECT +/-** on the remote control or **INPUT SELECT** on the unit to set the channel to "DV".
- Press **ON SCREEN**.
  - The on-screen display for DV dubbing appears.
- Press **selection keys** to select ( ), then press **ENTER** to display the remote icon (facing to the right) for the DV equipment.
- Press **REC MODE** repeatedly to set the recording mode. For DV deck, press **REC MODE** on the remote control to set the recording mode.
  - Each time you press **REC MODE**, the recording mode changes as follows:  
DV<sup>\*1</sup> → XP → SP → LP → EP → FR (60-360<sup>\*2</sup>, 420, 480) → (Back to the beginning)
  - <sup>\*1</sup> Selectable when dubbing to the HDD deck.
  - <sup>\*2</sup> The value is selectable from 1 to 6 hours in 5 minutes interval by pressing <|> repeatedly after selecting "FR60-FR360". To change the value in 30 minutes interval, press and hold <|>.
- Locate the point from where you want to start dubbing, then stop or pause playback by pressing the following buttons on the remote control: >, >>, <<, ■, ||.
  - To play back in slow speed (1/10 of the normal speed), press || to pause playback, then press << or >>.
  - To play back frame-by-frame, press || to pause playback, then press || repeatedly. Each press of || advances a frame.
  - To change the playback direction, press << or >>.

- Press **selection keys** to select ( ), then press **ENTER** repeatedly until the desired sound track appears on the TV screen.

### SOUND1:

Select this to record the original stereo sound played back on the connected DV equipment.

### SOUND2:

Select this to record the dubbed stereo sound played back on the connected DV equipment.

### MIX:

Select this to record the sound of both "SOUND1" and "SOUND2".

- Note that this selection is not available when the source programme is recorded in 16BIT (48 kHz) mode.

- Press **selection keys** to select ( ), then press **ENTER**. The dubbing starts.

- Playback on the external DV equipment and recording on the unit should start simultaneously.
- To pause dubbing, press **selection keys** to select ( ), then press **ENTER**. Both the unit and the external DV equipment pause dubbing. Pressing || on the unit also works the same way.

- Press **selection keys** to select ( ), then press **ENTER**. Then press ■. The DV equipment stops.

- Press **selection keys** to select ( ), then press **ENTER**.

- Press ■ twice on the remote control to stop dubbing.
  - Both the unit and the external DV equipment stop dubbing.

### NOTES:

- To create chapters (marks) automatically, set "DV AUTO CHAPTERING" to "ON". (pg. 58)
- Dubbing copyright guarded programmes is not possible.
- Original DV information such as the recording date and time are not recorded.
- The superimposed indication during the operation or dubbing is not recorded.
- If the dubbing is paused while the channel is set to "DV", you cannot switch channels.



**When you dub from DV equipment other than a camcorder**

- 1 Perform steps 1 – 4.
- 2 Locate the point from where you want to start dubbing, then stop on the DV equipment.
  - If you pause the DV equipment in this step, a few second's still picture will be recorded at the beginning of the recorded programme.
- 3 Set the input mode to "DV INPUT" on the DV equipment.
  - If you select an input mode other than "DV INPUT", unwanted pictures may be recorded at the beginning of the recorded programme.
- 4 Perform steps 9 – 12.

**To skip unwanted part of the source picture**

Press **ENTER** to stop both equipment, then press **selection keys** to select .

Locate the point where you want to restart dubbing by pressing **▶**, **▶▶**, or **◀◀**, then press **■**.

Press **selection keys** to select , then press **ENTER** to restart dubbing.

**Recording Mode**

MPEG2 format is used as recording format. As a guide for picture quality, the "bps" unit is used to represent how much data can be recorded per second. The larger this value is, the better the picture quality becomes but more capacity is required for the recording. Select XP or SP for programmes where quick movement occurs, such as sports programmes, and LP or EP for talk shows, etc. with relatively less movement.

The recording modes for a 4.7 GB disc are set as follows:

Recording mode		Recording amount (approx.)	Maximum recording time (approx.)
XP		10 Mbps	1 hour
SP		5 Mbps	2 hours
LP		2.5 Mbps	4 hours
EP		1.6 Mbps	6 hours
FR	60-360	The amount varies depending on the selected time.	1 – 6 hours
	420		7 hours
	480		8 hours

- For details on FR mode, refer to "Free Rate Function" on the right column.

The recording modes for the HDD are set as follows:

Recording mode	Maximum recording time (approx.)
DV	18 hours
XP	53 hours
SP	109 hours
LP	218 hours
EP	328 hours
FR480	473 hours

- For details on FR mode, refer to "Free Rate Function".

**NOTE:**

The maximum recording time stated in the above table are the approximate time under unused condition.

**Free Rate Function**

To record the entire programme, the unit automatically sets the appropriate recording mode depending on the combination of the total time of the programme to be recorded and either the remaining disc space or the specified recording time (from 60 minutes to 480 minutes).

**■ To record the entire programme within the actual remaining disc space (DVD deck only)**

Select "FR (JUST)" in a recording mode selection procedure.

- Note that this function is available only when dubbing from HDD to DVD (see pg. 44).

**■ To record the entire programme by specifying the desired recording time**

Select "FR60–FR360", "FR420" or "FR480" in a recording mode selection procedure.

**■ To record a 25-min. long programme five times on the same DVD disc for example**

Be sure to set the recording mode to "FR125" to fit the total recording time to the whole disc space.

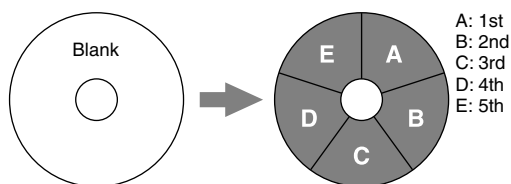

When the same programme is recorded in SP mode instead of in "FR125", the 5th programme cannot be recorded.

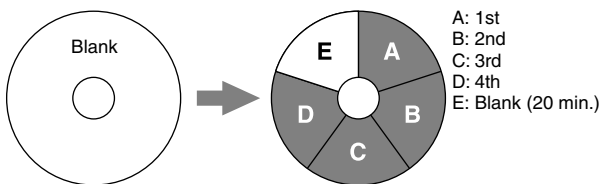

**NOTES:**

- The maximum recording time of FR (JUST) mode is the same as the recording time of FR480 mode. When dubbing a long programme in FR (JUST) mode on a disc whose remaining time is short, it is recommended to check the disc remaining time in FR480 mode to see if the remaining time is enough for the programme.
- In order to ensure that the recording fits on the disc, this feature may leave a slight non-recorded section at the end of the disc.
- There may be some noise and sound disturbance at the point on the disc where the unit switches the mode.

## Edit From A Camcorder

You can use a camcorder as the source player and your unit as the recording deck. If your camcorder has a DV IN/OUT connector, you can use the camcorder as the recording deck and your unit as the source player.

### 1 If the camcorder has no S-VIDEO output connector:

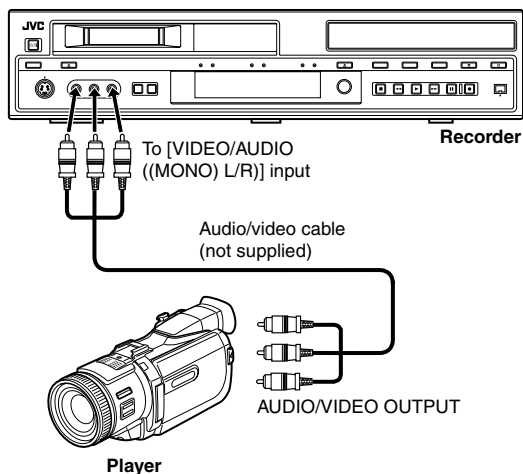

### 2 If the camcorder has an S-VIDEO output connector:

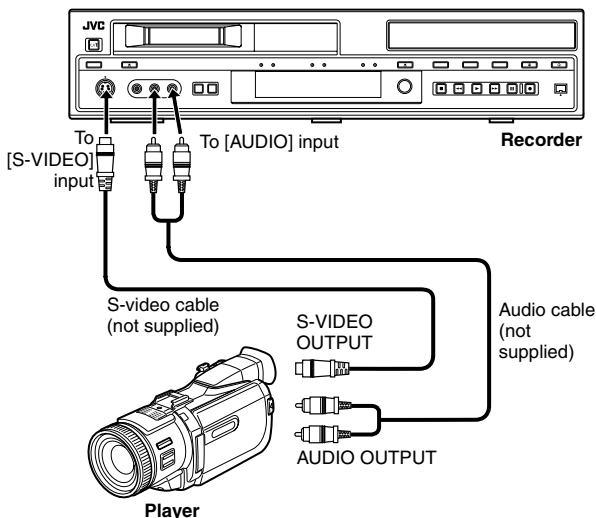

### 3 If the camcorder has a DV IN/OUT connector:

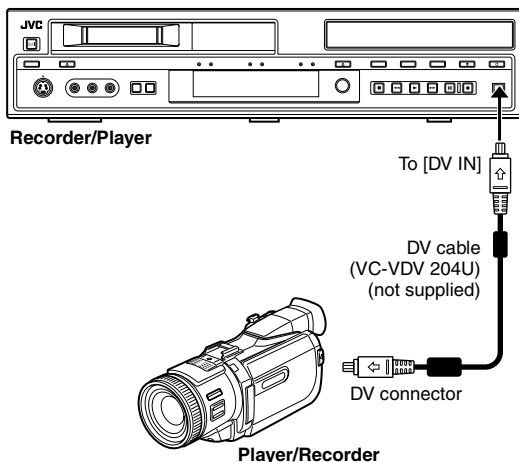

- Slide the TV/DVD switch to DVD.

#### 1 Make connections.

- If the camcorder has no S-VIDEO output connector:
  - connect the camcorder's AUDIO/VIDEO OUTPUT connectors to the unit's [VIDEO/AUDIO ((MONO) L/R)] input connectors on the front panel.
  - When using a monaural camcorder, connect its AUDIO OUT connector to the [AUDIO-L] input connector on your unit.
- If the camcorder has an S-VIDEO output connector:
  - connect the camcorder's AUDIO OUT and S-VIDEO OUT connectors to the unit's [AUDIO] and [S-VIDEO] input connectors on the front panel.
- If the camcorder has a DV IN/OUT connector:
  - connect the camcorder's DV IN/OUT connector to the unit's [DV IN/OUT] connector.
  - When using your unit as the source player, refer to the camcorder's instruction manual for the recording procedure.

- Press **DV/HDD/DVD** on the unit repeatedly to select the recording deck.

- Press **INPUT SELECT +/-** on the remote control or **INPUT SELECT** on the unit to select "F-1" or "DV".

- Set "F-1 INPUT" to "VIDEO" for the [VIDEO] input connector, or "S-VIDEO" for the [S-VIDEO] input connector, depending on the connector being used. (pg. 59)

- Press **REC MODE** repeatedly to set the recording mode. For DV deck, press **REC MODE** on the remote control to set the recording mode.

- Start playback on the camcorder slightly before the actual point from where you wish to start dubbing.

- Press **●** on the unit to start recording. Or while holding **●**, press **▶** on the remote control. The dubbing starts.

- Press **■** on the unit, then stop playback on the camcorder.

#### NOTES:

- All necessary cables can be obtained from your dealer.
- Refer to the camcorder's instruction manual for operating procedure.
- The quality of dubbed picture becomes poorer than that of the original.
- When you are editing through the [DV IN/OUT] connector, the unit will stop if the player begins playing a blank portion of tape or the signal is interrupted.
- When connecting the unit to a device equipped with a DV input connector, be sure to use the optional DV cable (VC-VDV 204U).
- To edit through the [DV IN/OUT] connector using the HDD or DVD deck, refer to "DV Dubbing (HDD & DVD Deck Only)" (pg. 48).
- When using your unit as the recording deck, chapters (marks) can be automatically created. Set "DV AUTO CHAPTERING" to "ON". (pg. 58)

# Edit To Or From Another Recorder

You can use your unit as the source player or as the recording deck.

**NOTES:**

- When using another recorder as the recording deck, refer to its instruction manual.
- It is not possible to dub copy-protected contents. An error message will appear on the TV screen.

**1 When using your unit as the source player**

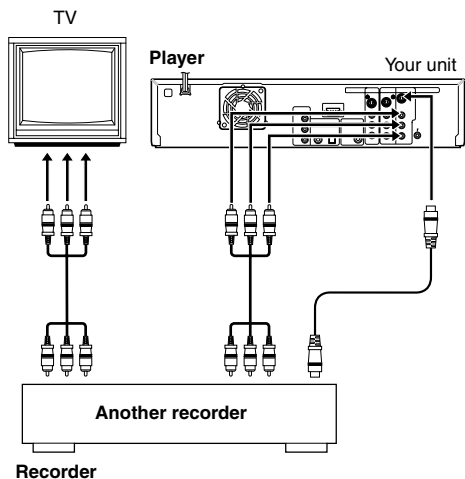

**2 When using your unit as the recording deck**

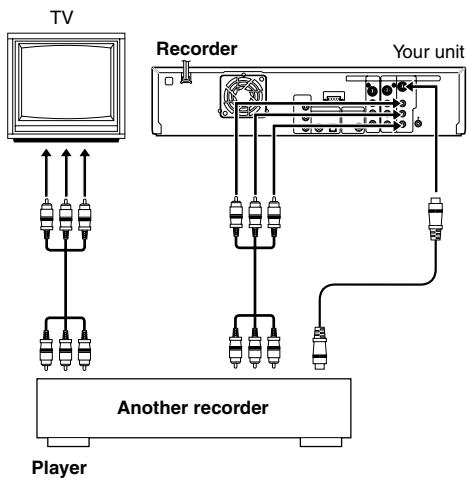

- Slide the TV/DVD switch to DVD.

**1** Make connections.

- 1 When using your unit as the source player:
    - connect its [S-VIDEO/VIDEO/AUDIO OUTPUT] connectors to the input connectors on another recorder.
  - 2 When using your unit as the recording deck:
    - connect its [S-VIDEO/VIDEO/AUDIO INPUT] connectors on the front or rear panel to the output connectors on another recorder.
- When connecting to another recorder with S-video connector, set “L-1 INPUT” or “F-1 INPUT” to “S-VIDEO”.

**2** Press **INPUT SELECT +/-** on the remote control or **INPUT SELECT** on the unit to select the external input.

- Select “F-1” when the source player is connected to the unit’s [VIDEO/AUDIO] or [S-VIDEO/AUDIO] input connectors on the front panel, and select “L-1” when it is connected to the unit’s [VIDEO/AUDIO] or [S-VIDEO/AUDIO] input connectors on the rear panel.

**3** Press **REC MODE** repeatedly to set the recording mode.

**4** Engage the Play mode on the source player.

**5** Engage the Record mode on the recording deck.

**6** Stop recording on the recording deck, then stop playback on the source player.

**NOTES:**

- All necessary cables can be obtained from your dealer.
- When you use this unit as the source player for editing, be sure to set “SUPERIMPOSE” to “OFF” before starting. (pg. 58)

## Dubbing DV Format Contents To A DV Device (HDD Deck Only)

You can dub programmes recorded in DV mode on the HDD deck to a camcorder or DV equipment.

### NOTE:

When connecting the unit to a device equipped with a DV input connector, be sure to use the optional DV cable (VC-VDV 204U).

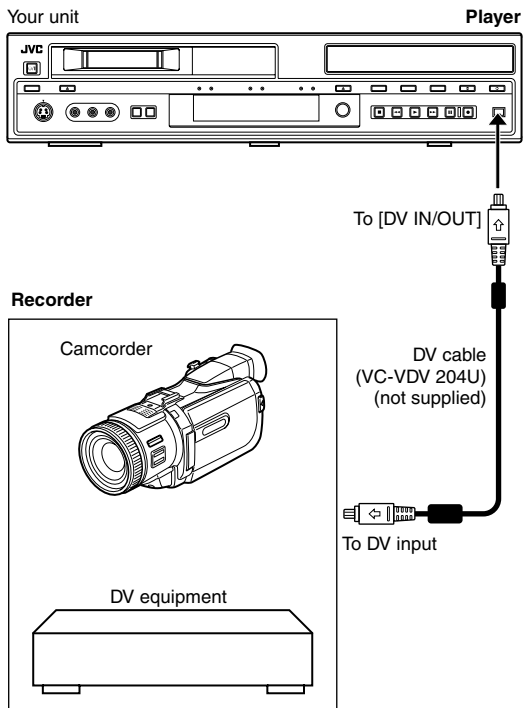

- 1 Connect the camcorder or DV equipment's DV input connector to the unit's [DV IN/OUT] connector.
- 2 Press **DV/HDD/DVD** on the unit repeatedly or **HDD** on the remote so that the HDD lamp lights up on the unit.
- 3 Press **INPUT SELECT +/-** on the remote control or **INPUT SELECT** on the unit to select "DV".
- 4 Set the camcorder or DV equipment's input channel to DV.
- 5 Select and play back the programme (DV mode) from the Library Database Navigation.
- 6 Start recording on the camcorder or DV equipment.
- 7 When dubbing is completed, stop recording on the camcorder or DV equipment, then stop playback on the HDD deck.

### NOTES:

- The channel of this unit must be set to "DV" in order to output the images (DV mode).
- Images other than those recorded in DV mode will not be output.

## Digital Audio Dubbing

You can dub selected audio from a DVD or Audio CD disc to a digital audio device.

However, it is not possible to dub copy-protected discs.

- Turn on the TV and select the AV mode.
- Slide the **TV/DVD** switch to **DVD**.

**Example: Dubbing to an MD**

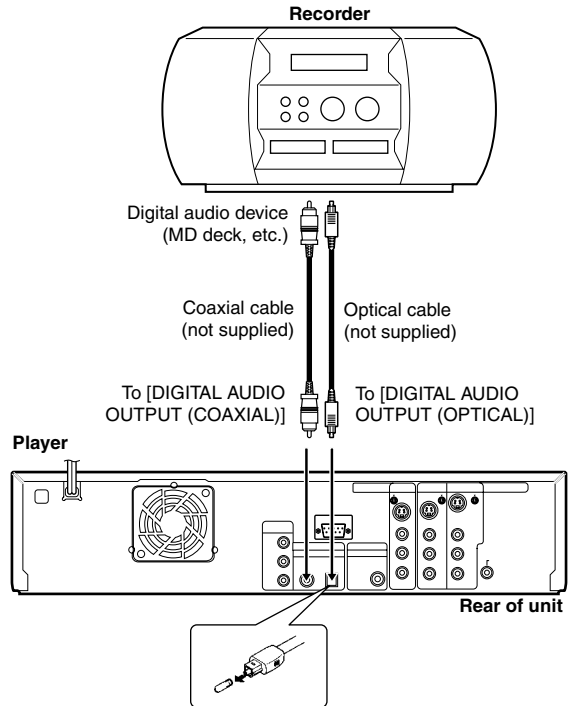

### Note for connection:

Remove the protection cap from the optical cable.

- 1 Connect the unit and a digital audio device using either an optional optical cable or an optional coaxial cable.
- 2 Place a disc on the unit and load an MD on the connected digital audio device.
- 3 Select the audio to be dubbed.
- 4 Start playback slightly before the actual point from where you wish to start dubbing.
- 5 Press **II** to pause playback.
- 6 Select the input mode on the connected digital audio device.
- 7 Press **▶** to start playback on the unit.
- 8 Start recording on the digital audio device.
- 9 Stop recording on the digital audio device. Then press **■** to stop playback on the unit.

### NOTE:

There may be a discrepancy of several seconds between where you intend editing to start, and where it actually starts.

## Audio Dubbing (DV Deck Only)

This function allows you to record new audio, without erasing the original audio, on a DV tape that was recorded with "DV AUDIO REC" set to "12BIT" (pg. 59).

### ATTENTION:

You cannot perform Audio Dubbing on a tape that was recorded with "DV AUDIO REC" set to "16BIT" (pg. 59), on a tape that was recorded at the "LP" speed, or on a blank tape.

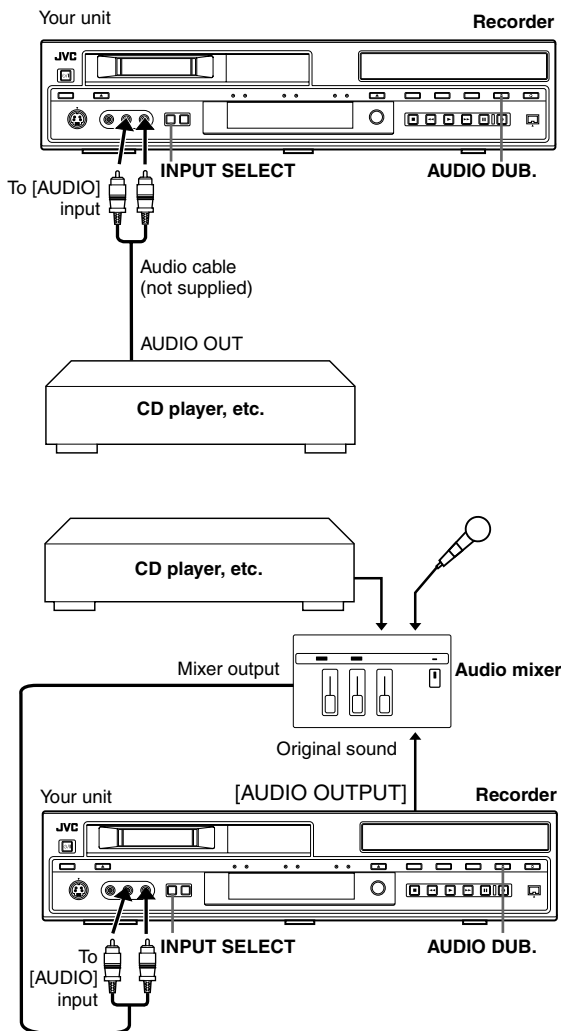

- Slide the TV/DVD switch to DVD.

- 1 Connect an audio device to the unit's [AUDIO] input connectors on the front panel.
  - When using a monaural audio device, connect its AUDIO OUT connector to the [AUDIO-L] input connector on your unit.
- 2 Load a Mini DV cassette with the erase protection switch set to "REC".
- 3 Press DV/HDD/DVD on the unit repeatedly or DV on the remote so that the DV lamp lights up on the unit.
- 4 Press INPUT SELECT +/- on the remote control or INPUT SELECT on the unit to select "F-1".
- 5 Start playback slightly before the actual point from where you wish to start dubbing.
- 6 Press II to pause playback.
- 7 Press AUDIO DUB. to engage the audio dubbing mode.
  - Your unit enters the Audio Dubbing Pause mode.
  - To perform Audio Dubbing with audio mixing, press AUDIO to select "L R" at this point. When using the DV deck as the recording deck, also make sure that "AUDIO MODE" is set to "SOUND1" (pg. 59).
    - \* Audio Dubbing with audio mixing is not possible if you are using a monaural audio component, or if you don't have an audio mixer.
- 8 Engage the audio device's playback, then press ► to start the tape in the unit. Audio dubbing starts at this point.
  - To stop dubbing temporarily, press II. Press ► to resume dubbing.
- 9 Press ■ on the unit, then stop playback on the audio device to end the audio dubbing.

### NOTES:

- When monitoring the audio dubbed sound on the DV deck, set "AUDIO MODE" to "SOUND2" (pg. 59).
- When playing back an audio dubbed Mini DV tape on the DV deck, set "AUDIO MODE" to "SOUND2" (pg. 59).
- Audio dubbing is not possible using the [DV IN/OUT] connector.
- Audio dubbing is not possible on a blank portion of the tape.

## Insert Editing (DV Deck Only)

Insert Editing replaces the pictures with new ones, while the audio soundtrack remains unchanged. For Insert Editing, use your unit as the recording deck.

### ATTENTION:

Insert Editing is not possible with a Mini DV cassette recorded in LP mode.

#### 1 If the player has no S-VIDEO output connector:

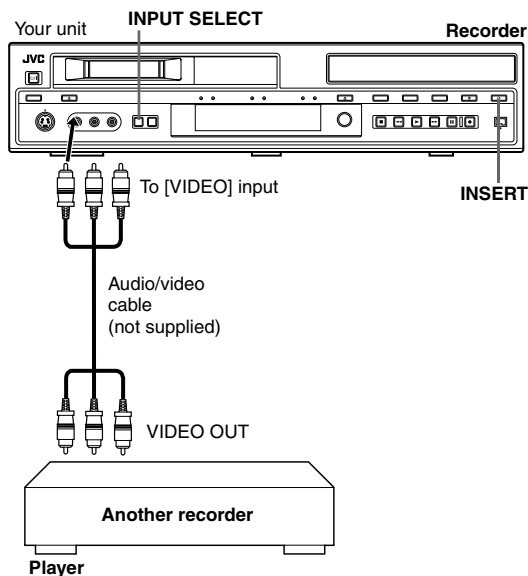

#### 2 If the player has an S-VIDEO output connector:

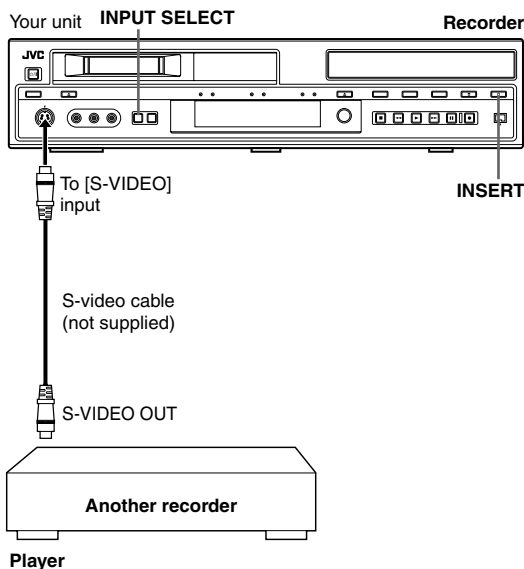

- Slide the TV/DVD switch to DVD.

#### 1 Make connections.

- 1 If the player has no S-VIDEO output connector:
  - connect the player's VIDEO OUT connector to your unit's [VIDEO] input connector on the front panel.
- 2 If the player has an S-VIDEO output connector:
  - connect the player's S-VIDEO OUT connector to your unit's [S-VIDEO] input connector on the front panel.

#### 2 Load a Mini DV cassette with the erase protection switch set to "REC".

#### 3 Press DV/HDD/DVD on the unit repeatedly or DV on the remote so that the DV lamp lights up on the unit.

#### 4 Press INPUT SELECT +/- on the remote control or INPUT SELECT on the unit to select "F-1".

#### 5 Press <Left>, <Right> and <Stop> to determine the edit-in point (the beginning of the segment to be replaced).

- Be sure to engage the Still mode at the edit-in point.

#### 6 Press INSERT to engage the insert editing mode.

- Your unit enters the Insert Pause mode.
- The TV screen changes from the still picture to the input source you are going to record.

#### 7 Load the source cassette and play back the segment that is to be inserted. When you reach the start of the section of the source tape that you wish to insert, press <Right> to start the tape in your unit. Insert editing begins at this point.

#### 8 Press <Stop> to stop recording on the DV deck to end insert editing.

#### NOTES:

- All necessary cables can be obtained from your dealer.
- Insert Editing cannot be performed on a Mini DV cassette that has had its erase protection switch set to "SAVE".
- When Insert Editing is performed on a tape that has been recorded on another video recorder, the inserted portion may appear distorted.
- A small portion of the recording which precedes an insert edit may become erased.
- Insert Editing is not possible using the [DV IN/OUT] connector.
- Insert Editing is not possible on a blank portion of the tape.

# Remote Control Functions

## Remote Control 1/2/3/4 Code Switching

The remote control is capable of controlling four JVC video units independently. Each of the units can respond to one of the four codes (1, 2, 3 or 4). The remote control is preset to send code 3 signals because your unit is initially set to respond to code 3 signals. You can easily modify your unit to respond to code 1, 2 or 4 signals.

- Slide the **TV/DVD** switch to **DVD**.

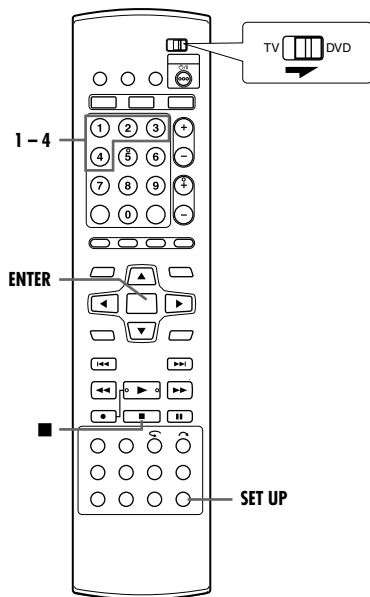
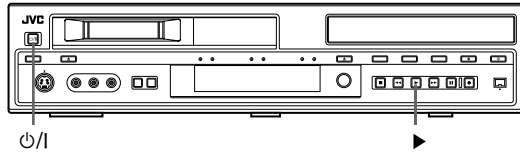

- Keep pressing **SET UP** down during step 1.
- 1 Press the **number key** "1" for 1, "2" for 2, "3" for 3 or "4" for 4 to change the remote control code, then press **ENTER**.
  - 2 Press **⏻** on the unit to turn off the unit.
  - 3 Press **▶** on the unit for over 5 seconds while the unit is turned off. The current code appears on the front display panel.
  - 4 Press **■** on the remote control to change the unit's code. The new code blinks on the front display panel for approximately 5 seconds, and is applied to the unit.

## TV Multi-Brand Remote Control

Your remote control can operate the basic functions of your TV set. In addition to JVC TVs, other manufacturer's TVs can also be controlled.

- Turn off the TV using its remote control.
- Slide the **TV/DVD** switch to **TV**.

### IMPORTANT:

Although the provided remote control unit is compatible with JVC televisions, as well as many other models, it may not work with your TV, or in some instances, may have limited function capability.

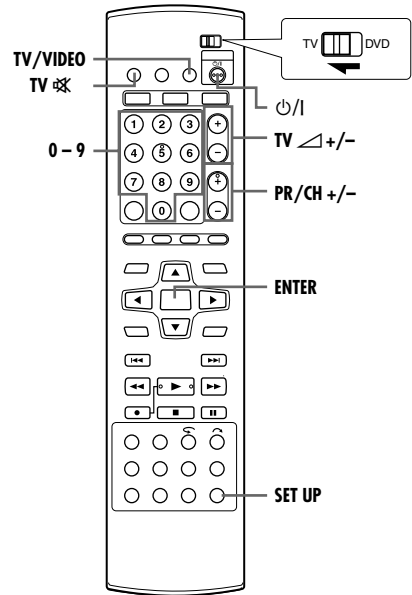

- Keep pressing **SET UP** down during step 1.
- 1 Enter your TV's brand code using the **number keys**, then press **ENTER**.
  - 2 Press **⏻/I** on the unit's remote control to turn on the TV and try operations (see step 3).
    - Once you have set the remote control to operate the TV, you do not have to repeat this step until you replace your remote control's batteries.
    - Some brands of TVs have more than one code. If the TV does not function with one code, try entering another.
  - 3 Press the corresponding buttons to operate the TV: **⏻/I**, **TV/VIDEO**, **PR/CH +/-**, **TV ⏻ +/-**, **TV ⏻**, **number keys**.
    - For some brands of TVs, you must press **ENTER** after having pressed the **number keys**.

BRAND NAME	CODE
JVC	01, 23, 24, 25
FERGUSON	27
FINLUX	30
FUNAI	32
LG/GOLDSTAR	18
GRUNDIG	19
HITACHI	10
ITT	28
MITSUBISHI	03
MIVAR	29
NEC	20
NOKIA	31
PANASONIC	04, 11
PHILIPS	02
RCA	05
SAMSUNG	12, 33, 34, 35
SANYO	13, 16
SHARP	06
SONY	07
THOMSON	26
TOSHIBA	08, 14

## Connecting To A Dolby Digital Decoder Or An Amplifier With Built-in DTS

These instructions enable you to connect your unit to a Dolby Digital Decoder or an amplifier with built-in DTS.

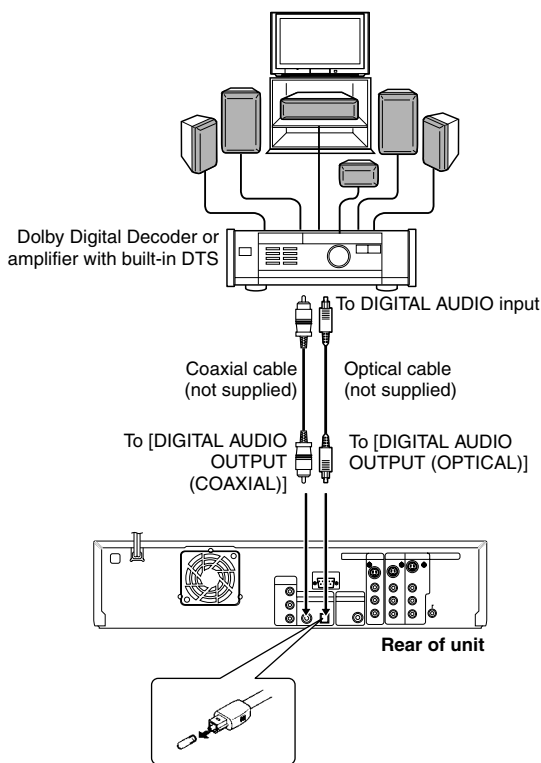

1 Connect the unit and a Dolby Digital Decoder or an amplifier with built-in DTS using either an optional optical cable or an optional coaxial cable.

### NOTES:

- For Dolby Digital sound, set "DIGITAL AUDIO OUT" to "DOLBY DIGITAL/PCM". (pg. 57)
- For DTS sound, set "DIGITAL AUDIO OUT" to "STREAM/PCM". (pg. 57)

### CAUTIONS:

- This unit has a dynamic range of more than 110 dB with regards to its Hi-Fi audio capability. It is recommended that you check the maximum level if you are going to listen to the Hi-Fi audio signals through a stereo amplifier. A sudden surge in the input level to the speakers may damage them.
- Some speakers and televisions are specially shielded to prevent television interference. If both are of the non-shielded type, do not place the speakers adjacent to the TV set as this can adversely affect the playback picture.

### When you can't switch the audio channel of a bilingual programme

When the unit is connected with a digital audio device using an optional optical cable and "DIGITAL AUDIO OUT" is set to "DOLBY DIGITAL/PCM", it is not possible to switch the audio channel of a bilingual programme recorded on a DVD-RAM or DVD-R/RW (VR mode) disc. In this case, perform the following steps using the remote control to switch "DIGITAL AUDIO OUT" from "DOLBY DIGITAL/PCM" to "PCM ONLY".

- 1 Press **SET UP** to access the Main Menu screen.
- 2 Press **selection keys** to select "DVD VIDEO SET UP", then press **▽**.
- 3 Press **selection keys** to select "AUDIO OUTPUT", then press **▽**.
- 4 Press **selection keys** to select "DIGITAL AUDIO OUT", then press **ENTER**.
- 5 Press **selection keys** to select "PCM ONLY", then press **ENTER**. (pg. 57)
- 6 Press **SET UP** to complete the setting.
- 7 Press **AUDIO** to select the desired audio channel.



## Mode Set

- Turn on the unit.
- Turn on the TV and select the AV mode.
- Slide the **TV/DVD** switch to **DVD**.

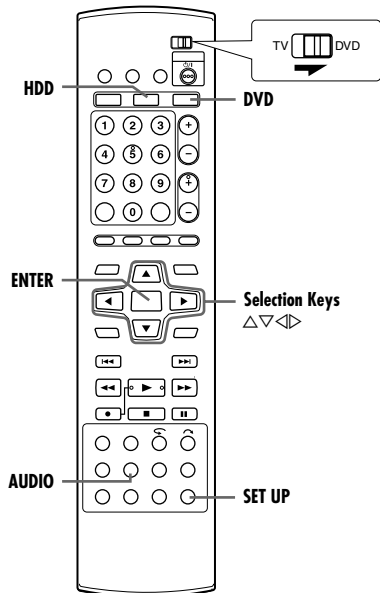

Various modes of this unit are categorised into menus nested in 2 levels shown in the following table. To change the settings of these modes, find the desired mode in the menu (for details on each menu, see pages 57 through 59), then follow the procedure below.

<b>DVD VIDEO SET UP</b>	LANGUAGE SET (pg. 18) AUDIO OUTPUT (See right column) DISC PLAY SET UP (pg. 58)
<b>HDD/DVD SET UP</b>	HDD SET UP (pg. 58) DVD SET UP (pg. 58, 61) DISC SET UP (pg. 60, 61) COMMON SET UP (pg. 58)
<b>FUNCTION SET UP</b>	REC/PLAY SET UP (pg. 58) DISPLAY SET (pg. 58) VIDEO IN/OUT (pg. 19)
<b>INITIAL SET UP</b>	MENU BACKGROUND (pg. 63) CLOCK SET (pg. 17)
<b>DV SET UP</b>	(pg. 59)

- The procedure below shows how to set the desired option of the "JUMP TIME" mode as an example.

- 1 Press **HDD** or **DVD** so that the HDD or DVD lamp lights up on the unit.
- 2 Press **SET UP** to access the Main Menu screen.
- 3 Press **selection keys** to select "FUNCTION SET UP", then press  $\nabla$ .
- 4 Press **selection keys** to select "REC/PLAY SET UP", then press  $\nabla$ .
- 5 Press **selection keys** to select "JUMP TIME", then press **ENTER**.
- 6 Press **selection keys** to select the desired option, then press **ENTER**.
- 7 Press **SET UP** to complete the setting.

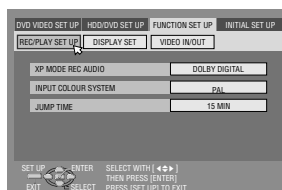

\* The **boldface** settings below indicate the settings at your purchase.

## AUDIO OUTPUT

### ■ DIGITAL AUDIO OUT — DOLBY DIGITAL/PCM / STREAM/PCM / PCM ONLY

Set to the appropriate mode according to the type of the device connected to [DIGITAL AUDIO OUTPUT] connector.

#### DOLBY DIGITAL/PCM:

Select this when you connect the digital input connector of a Dolby Digital Decoder or an amplifier with a built-in Dolby Digital Decoder.

#### STREAM/PCM:

Select this when you connect the digital input connector of an amplifier with a built-in DTS, Dolby Digital, or MPEG multichannel decoder.

#### PCM ONLY:

Select this when you connect the linear PCM digital input of other audio equipment (amplifier, MD or DAT deck, etc.).

#### NOTES:

- This setting also functions when HDD is active.
- If you watch or play back a title which contains multiple audio languages, select "PCM ONLY" in advance and choose main or sub audio with **AUDIO**.

### ■ ANALOG AUDIO OUT — STEREO / DOLBY SURROUND

Select the appropriate setting to accommodate the unit to the connected A/V equipment. This function takes effect when a DVD VIDEO disc is played back.

#### STEREO:

Select this when listening to conventional two-channel stereo audio with the unit's [AUDIO OUTPUT] connectors connected to a stereo amplifier/receiver or TV set, or in case you want to record the audio from a DVD VIDEO disc to a Mini Disc, etc.

#### DOLBY SURROUND:

Select this when listening to multichannel surround audio with the unit's [AUDIO OUTPUT] connectors connected to an amplifier/receiver with a built-in surround decoder or a surround decoder.

### ■ D. RANGE CONTROL — NORMAL / WIDE RANGE / TV MODE

The dynamic range (the difference between the loudest sound and the quietest one) can be compressed during playback of a programme encoded in Dolby Digital format.

This function takes effect when a DVD VIDEO disc recorded in Dolby Digital format is played back at low or middle volume.

#### NORMAL:

Normally select this setting to activate this function.

#### WIDE RANGE:

Select this to deactivate this function when you enjoy wide dynamic range programme.

#### TV MODE:

Select this when you hear the sound through the TV's speaker(s).

#### NOTES:

- This function has no effect on programmes other than those recorded in Dolby Digital format.
- This function does not work when Simulated Surround Effect is activated. (pg. 27)
- The effect of "NORMAL" and "WIDE RANGE" may not be different depending on discs.

### ■ OUTPUT LEVEL — STANDARD / LOW

You can lower the output level of analogue audio to accommodate the unit to the connected A/V equipment.

#### STANDARD:

Normally select this setting.

#### LOW:

The output level of analogue audio is lowered.

**DISC PLAY SET UP****RESUME** — OFF / ON / DISC RESUME

When this function is set to "ON" or "DISC RESUME", you can use the resume function. (☞ pg. 22)

OFF:

You cannot use the resume function.

ON:

You can start playback from the resume point of the placed disc.

DISC RESUME:

The unit retains a memory of the resume points of the last 30 discs played back, even though they have been ejected.

**NOTE:**

"DISC RESUME" setting works on DVD VIDEO, VCD, SVCD and already finalised DVD-R/DVD-RW (video mode) discs. For other types of discs, the function under "ON" setting will be applied even if "RESUME" is set to "DISC RESUME".

**HDD SET UP****LIVE MEMORY** — OFF / 30 MIN / 1 HR / 3 HR

When this function is set to "30 MIN", "1 HR" or "3 HR", you can apply the selected time length to "Temporary recording for Live Memory (HDD deck only)" (☞ pg. 35).

**DVD SET UP****SAVE AS LIBRARY** — OFF / ON

When this function is set to "ON", the recording information is automatically stored in the library. For details, refer to "Navigate Library Information" (☞ pg. 42).

**CONTINUOUS PLAY** — OFF / ON

When this function is set to "ON", multiple titles on a disc are played back continuously one after another.

**VIDEO MODE RECORDING ASPECT** — PRIORITIZE 4:3 / PRIORITIZE 16:9

This is the setting for the aspect ratio used when you dub titles to DVD discs in video mode. If the titles you want to dub are recorded in both 16:9 and 4:3, you must select one aspect ratio.

**PRIORITIZE 4:3:**

If you select "PRIORITIZE 4:3", even a title recorded in 16:9 is dubbed in 4:3.

**PRIORITIZE 16:9:**

If you select "PRIORITIZE 16:9", even a title recorded in 4:3 is dubbed in 16:9.

**MP3&WMA / JPEG** — MP3&WMA / JPEG

You can select files to play back, when both MP3&WMA files and JPEG files are recorded on a disc.

**MP3&WMA:**

Select this to play back MP3/WMA files.

**JPEG:**

Select this to play back JPEG files.

**COMMON SET UP****DV AUTO CHAPTERING** — OFF / ON

When this function is set to "ON", you can create chapters (marks) when dubbing from the DV deck or via the DV input terminal connecting the external DV camcorder.

OFF:

Do not create chapters (marks).

ON:

Create chapters (marks).

**NOTE:**

Marks cannot be created for direct recording to the DVD in Video mode. Record to the HDD, then dub to the DVD.

**DV 12-BIT AUDIO** — SOUND1 / SOUND2 / MIX

You can select the desired sound mode when playing back a programme recorded on the HDD in DV mode.

**SOUND1:**

Original recorded sound.

**SOUND2:**

Post-recorded sound.

**MIX:**

Original recorded and post-recorded sound.

**MOTION INDEX** — OFF / ON

When this function is set to "ON", you can set the picture on the top left corner of the Library Database Navigation screen or the Editing screen to that of the selected title.

**REC/PLAY SET UP****XP MODE REC AUDIO** — DOLBY DIGITAL / LINEAR PCM

You can select the audio format when you record a title in XP mode. When this function is set to "LINEAR PCM", you can obtain a high-quality audio sound.

**DOLBY DIGITAL:**

To record in Dolby Digital format.

**LINEAR PCM:**

To record in Linear PCM format.

**INPUT COLOUR SYSTEM** — PAL / SECAM

You can play back PAL discs, or record PAL and SECAM signals on this unit. Select the appropriate colour system.

**PAL:**

To record PAL signals.

**SECAM:**

To record SECAM signals.

**JUMP TIME** — 15 MIN / 30 MIN / 1 HR

You can locate a scene ahead of or behind the currently viewed one by jumping a selected time interval during playback (or Live Memory Playback). For details, refer to "Jump Search" (☞ pg. 22, 30).

**DISPLAY SET****SUPERIMPOSE** — OFF / ON / AUTO

When this function is set to "AUTO", various operational indicators appear on the TV screen. Messages appear in the selected language. (☞ pg. 18)

OFF:

To turn off superimposed indications.

ON:

To turn on superimposed indications.

**AUTO:**

To superimpose operational indications for approximately five seconds just after the corresponding operation.

**NOTES:**

- When you use this unit as the source player for editing, be sure to set "SUPERIMPOSE" to "OFF" before starting. (☞ pg. 51)
- When you select "AUTO", during playback, the operation mode indicators may be disturbed depending on the type of disc being used.

**DIMMER (DURING POWER ON)** — BRIGHT / DIMMED

You can change the brightness of the front display panel.

**BRIGHT:**

Normally select this.

**DIMMED:**

To dim the front display panel.

**■ DIMMER (DURING POWER OFF) — OFF / ON**

You can select to light up or turn off the light of the front display panel when the unit is off.

**OFF:**

To turn off the light of the front display panel when the unit is off.

**ON:**

To light up the front display panel when the unit is off.

**■ QUICK STARTUP — OFF / ON**

When this function is set to "ON", operations such as playback can be performed more quickly upon turning on the unit than when set to "OFF". However, the power consumption during standby increases.

**OFF:**

To disable the quick startup function.

**ON:**

Operations can be performed quickly after turning on the unit.

**■ ON SCREEN LANGUAGE**

This unit offers you the choice to view on-screen messages in 11 different languages.

For details, refer to "On-screen Language Set" (pg. 18).

**VIDEO IN/OUT****■ MONITOR TYPE — 4:3LB / 4:3PS / 16:9AUTO / 16:9FIX**

You can select the monitor type depending on the TV used when you play back DVD VIDEO discs recorded for wide-screen TVs. For details, refer to "Monitor Set" (pg. 19).

**■ F-1 INPUT — VIDEO / S-VIDEO**

Select the appropriate mode depending on the connector (F-1) being used on the front panel.

**VIDEO:**

To use the [VIDEO] input connector on the front panel.

**S-VIDEO:**

To use the [S-VIDEO] input connector on the front panel.

**■ L-1 INPUT — VIDEO / S-VIDEO**

Select the appropriate mode depending on the connector (L-1) being used on the rear panel.

**VIDEO:**

To use the [VIDEO INPUT] connector on the rear panel.

**S-VIDEO:**

To use the [S-VIDEO INPUT] connector on the rear panel.

**NOTE:**

To display the "DV SET UP" menu, press **SET UP** while in the DV deck mode.

**DV SET UP****■ DV AUDIO REC — 12BIT / 16BIT**

This is the setting for sound mode before recording on a Mini DV tape.

**12BIT:**

Enables Audio Dubbing later.

**16BIT:**

Audio Dubbing is not possible but the recorded sound quality is higher than "12BIT".

**■ AUDIO MODE — SOUND1 / SOUND2 / MIX**

You can select the desired sound mode when playing back an audio dubbed Mini DV tape.

**SOUND1:**

Original recorded sound.

**SOUND2:**

Audio dubbed sound.

**MIX:**

Original recorded sound and audio-dubbed sound.

**NOTES:**

- When "AUDIO MODE" is set to "MIX", both the main and sub audio will be audible for bilingual tapes.
- To select only the main audio or only the sub audio of bilingual tapes, set "AUDIO MODE" to "SOUND1".

## Format A Disc (DVD Deck Only)



Some DVD-RAM/RW discs are unformatted. Format the disc when you use an unformatted disc or you want to delete all recordings and data on the disc. To use a DVD-R disc in VR mode, format the new disc in VR mode. (It will be in Video mode when not formatted.)

### ATTENTION:

- When a disc is formatted, all recordings and data are erased. It is impossible to restore them.
- Never turn off the unit or disconnect the mains power cord while “NOW FORMATTING...” is displayed on the TV screen.
- DVD-R discs can only be formatted once.

- Turn on the unit.
- Turn on the TV and select the AV mode.
- Slide the **TV/DVD** switch to **DVD**.
- Load a DVD-RAM/R/RW disc to format.

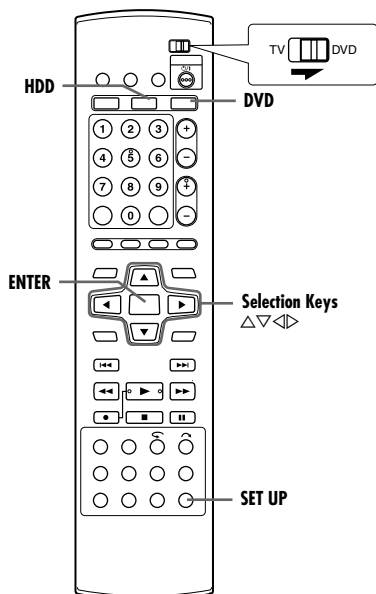

## Format A DVD-RAM Disc

- 1 Press **HDD** or **DVD** so that the HDD or DVD lamp lights up on the unit.
- 2 Press **SET UP** to access the Main Menu screen.
- 3 Press **selection keys** to select “HDD/DVD SET UP”, then press  $\nabla$ .
- 4 Press **selection keys** to select “DISC SET UP”, then press  $\nabla$ .
- 5 Press **selection keys** to select “FORMAT”, then press **ENTER**. Press **selection keys** to select “EXECUTE”, then press **ENTER**.
- 6 Press **selection keys** to select “EXECUTE”, then press **ENTER**.

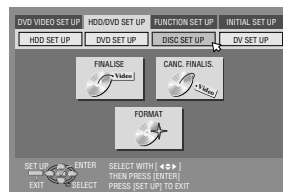

## Format A DVD-RW Disc

- 1 Perform steps 1 – 4 of “Format A DVD-RAM Disc” as above before continuing.
- 2 Press **selection keys** to select “FORMAT”, then press **ENTER**. Press **selection keys** to choose “VR MODE” or “VIDEO MODE”, then press **ENTER**.

“VR MODE”:

To be chosen when you want to record, erase, or edit data on the disc repeatedly.

“VIDEO MODE”:

To be chosen when you want to erase all the data on the disc once played back to record new data, or play back the disc on other DVD players.

- 3 Press **selection keys** to select “EXECUTE”, then press **ENTER**.

### NOTES:

- It is impossible to format Version 1.0 DVD-RW discs in Video mode.
- All the titles on a disc will be deleted once the disc is formatted even if they are protected titles. (pg. 38)

## Format A DVD-R Disc

- 1 Perform steps 1 – 4 of “Format A DVD-RAM Disc” as above before continuing.
- 2 Press **selection keys** to select “FORMAT”, then press **ENTER**. Press **selection keys** to select “EXECUTE”, then press **ENTER**.

## Finalise A Disc (DVD Deck Only)



Finalising DVD-R/RW discs recorded on this unit makes it possible for the discs to be played back on other DVD players. DVD-RW discs are finalised in the mode that the discs were formatted, enabling playback on compatible DVD players. Title names input in the Library Database Navigation are registered as title names in the DVD menu. (pg. 37)

- Turn on the unit.
- Turn on the TV and select the AV mode.
- Slide the TV/DVD switch to DVD.
- Load a DVD-R/RW disc to finalise.

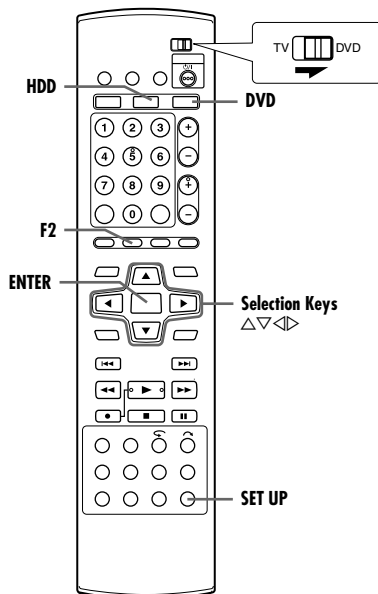

### Before finalising

- It is possible to record on a blank space.
- It is possible to enter title names. (pg. 37)
- It is possible to delete titles. (pg. 38)
- It is impossible to overwrite recorded areas of DVD-R discs.
- Available recording capacity does not increase even if a recorded title is deleted from a DVD-R disc.
- It is impossible to record or edit DVD-R/RW discs recorded on other devices even if they have not been finalised.

### After finalising (For DVD-R/RW (Video mode) discs)

- Video and audio that have been recorded by then are recorded in conformity to the DVD Video standard, enabling you to play back the discs as DVD VIDEO discs.
- Although DVD-R/RW discs finalised on this unit become playable on DVD players compatible with DVD-R/RW discs, some discs still may not play, for which JVC cannot take responsibility.
- Marked points marked before finalising will be deleted, and titles will be divided automatically into "chapters" approximately every 5 minutes. (pg. 23)
- Depending on the DVD players and DVD-R/RW discs used, and on the conditions of recording, it may not be possible to play back the discs. In this case, play back the discs on this unit.
- Additional recordings become impossible.

## Finalise A DVD-R/RW Disc

- 1 Press **HDD** or **DVD** so that the HDD or DVD lamp lights up on the unit.
- 2 Press **SET UP** to access the Main Menu screen.
  - Alternatively, you can press **F2** to access the "DISC SET UP" screen directly. For details, refer to "Direct Access To "DISC SET UP" Screen" (pg. 62).
- 3 Press **selection keys** to select "HDD/DVD SET UP", then press **▽**.
  - If you want to change the "DISC TYPE" setting, proceed to step 4. Otherwise, proceed to step 7 for disc finalisation.
- 4 Press **selection keys** to select "DVD SET UP", then press **▽**.
- 5 Press **selection keys** to select "DISC TYPE", then press **ENTER**.
- 6 Press **selection keys** to select the desired option, then press **ENTER**.
- 7 Press **selection keys** to select "DISC SET UP", then press **▽**.
- 8 Press **selection keys** to select "FINALISE", then press **ENTER**.
  - For DVD-R/RW (Video mode) discs, the background selection screen will appear. To finalise using the current background (with a check mark "✓" superimposed on it), press **ENTER**. To choose a new background, press **selection keys** to select the desired background from a selection of 18 backgrounds, then press **ENTER**. You can use your own created backgrounds instead of those available on this unit. Refer to "User-Customisable Background And Text Colour" (pg. 63). After selecting a background, you can preview the final result before finalising the disc. Refer to "Previewing the background effect" (pg. 64).
- 9 Press **selection keys** to select "OK", then press **ENTER**.
- 10 Upon completing finalisation, "COMPLETED" appears on the TV screen. Press **ENTER** to end.
- 11 Press **SET UP** to return to the normal screen.

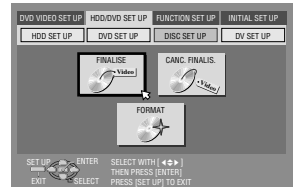

\* The **boldface** settings below indicate the settings at your purchase.

### ■ DISC TYPE — MANUAL START / MENU STOP / AUTO REPEAT

You can set the operation method of a DVD-R/RW (Video mode) disc when finalising the disc on this unit.

#### MANUAL START:

When the DVD disc is loaded, the disc will stop after it has been read. To play back the disc, press **▶**.

#### MENU STOP:

When the DVD disc is loaded, the disc will be played back automatically after it has been read. Playback will stop when the disc menu is displayed.

#### AUTO REPEAT:

When the DVD disc is loaded, the disc will be played back automatically after it has been read. The disc will be played repeatedly.

## Cancel The Finalisation Of A DVD-RW Disc

- 1 Load a DVD-RW disc to cancel the disc finalisation, and perform steps 1 – 2 of “Finalise A DVD-R/RW Disc” (pg. 61) before continuing.
- 2 Press **selection keys** to select “HDD/DVD SET UP”, then press  $\nabla$ .
- 3 Press **selection keys** to select “DISC SET UP”, then press  $\nabla$ .
- 4 Press **selection keys** to select “CANC. FINALIS.”, then press **ENTER**.
- 5 Press **selection keys** to select “OK”, then press **ENTER**.
- 6 Upon completing cancellation of finalisation, “CANCELLATION COMPLETED” appears on the TV screen. Press **ENTER** to end.
- 7 Press **SET UP** to return to the normal screen.
  - When the disc finalisation is cancelled, the mode in which the disc was formatted is restored, making the disc recordable. (pg. 7, 60)

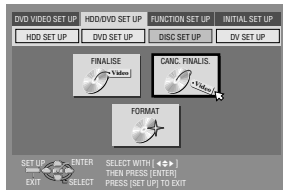

### NOTE:

It is not possible to cancel the finalisation of a DVD-R disc.

## Direct Access To “DISC SET UP” Screen

When you wish to finalise or cancel the finalisation of a disc, besides accessing the “DISC SET UP” screen through the **SET UP** button, you can also use the **F2** button on the remote control. This **F2** button enables you to access the “DISC SET UP” screen directly after loading the disc.

### To finalise a disc

- 1 Load the disc.
- 2 Press **HDD** or **DVD** so that the HDD or DVD lamp lights up on the unit.
- 3 Press **F2** to access the “DISC SET UP” screen.
  - The screen in step 8 of “Finalise A DVD-R/RW Disc” (pg. 61) appears.
- 4 Perform steps 8 – 11 of “Finalise A DVD-R/RW Disc” (pg. 61) to finalise the disc.

### To cancel finalisation

- 1 Perform steps 1 – 3 of “To finalise a disc” above.
  - The screen in step 4 of “Cancel The Finalisation Of A DVD-RW Disc” on the left column appears.
- 2 Perform steps 4 – 7 of “Cancel The Finalisation Of A DVD-RW Disc” on the left column to cancel finalisation of the disc.

### NOTES:

- The direct access (**F2**) function works only when in the HDD or DVD deck mode, on the condition that the Main Menu, Editing, Library Database Navigation or Dubbing screen is not displayed.
- The direct access (**F2**) function will not work in the following cases, and an operation prohibition mark “⊘” appears on the TV screen.
  - During DVD recording or playback.
  - Disc is not loaded.
  - A playback-only disc is loaded.
  - Disc reading is in progress.
  - Disc information acquisition failure when DVD-RAM is loaded.
- When this unit is in the DV deck mode or when dubbing is in progress, the direct access (**F2**) function will also not work. However, “⊘” will not be displayed.

## User-Customisable Background And Text Colour

This function allows you to replace the original backgrounds available on this unit with your own created backgrounds. Up to 18 backgrounds can be replaced. Besides the background, you can also change the text colour to improve the visibility of the text on a dark background. You can make use of the font data provided.

- Turn on the unit.
- Turn on the TV and select the AV mode.
- Slide the TV/DVD switch to DVD.
- Load a UDF2.0 DVD-RAM or CD-R/RW disc to update.

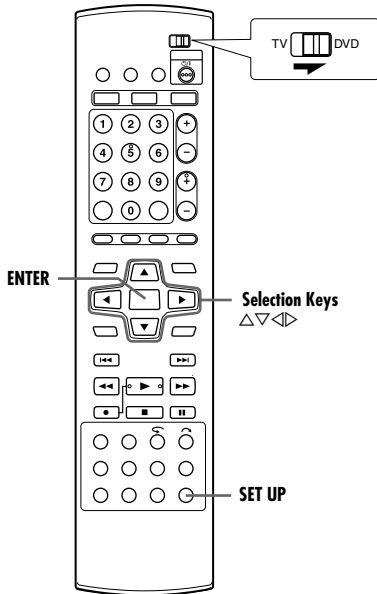

### Usable image format, text format and disc

- Usable image format
  - File name: User01.bmp ~ User18.bmp  
(Case-insensitive. Maximum: 18 images.)
  - Size: 720x576
  - Mode: RGB (24Bit)

The file names do not have to be sequentially numbered.
- Usable text format
  - File name: Text01.bmp ~ Text18.bmp
  - Size: 362x126 (recommended)
  - Mode: INDEX (4Bit)
- Usable disc
 

Use a UDF2.0 DVD-RAM or CD-R/RW disc that consists of the above stated bitmap files in the root directory. The CD-R/RW disc used for updating must be written in the disc-at-once mode with the ISO9660 (or Joliet) format. Files in an added session written with multisession cannot be used for updating.

After updating has been completed, the backgrounds will be arranged in the sequence as illustrated. The file names will not be displayed on the TV screen.

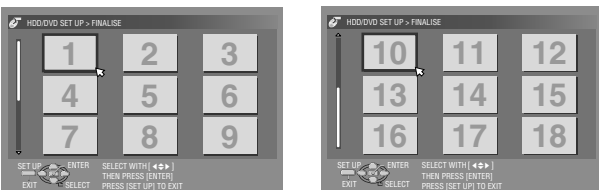

1: User01.bmp ~ 18: User18.bmp

## Updating Backgrounds And Text Colour

- 1 Press **SET UP** to access the Main Menu screen.
- 2 Press **selection keys** to select "INITIAL SET UP", then press **▽**.
- 3 Press **selection keys** to select "MENU BACKGROUND", then press **▽**.
- 4 Press **selection keys** to select "UPDATE", then press **ENTER**.
  - An error message will appear if the disc is not loaded; playback or recording in progress on the DVD deck; disc other than UDF2.0 DVD-RAM or CD-R/RW is loaded, or when a blank CD-R/RW is loaded.
- 5 Press **selection keys** to select "OK", then press **ENTER**.
- 6 Upon completion, the updating result appears on the TV screen. Press **ENTER** to end.
  - The disc is automatically ejected.
- 7 Press **SET UP** to return to the normal screen.

### NOTES:

- While updating, the number of files successfully and unsuccessfully updated is displayed on the TV screen.
- The unsuccessful updates may be due to the following.
  - Files cannot be converted due to incorrect file name, size or format.
  - Files cannot be copied or written due to HDD error.
- This unit will not display any warning message regarding incorrect file format.

## Restoring Original Backgrounds And Text Colour

All user-customised backgrounds and/or text colour will be erased and the original backgrounds and text colour are restored.

- 1 Perform steps 1 – 3 of "Updating Backgrounds And Text Colour" above.
- 2 Press **selection keys** to select "DEFAULT", then press **ENTER**.
- 3 Press **selection keys** to select "OK", then press **ENTER**.
- 4 Upon completion, "FINISHED" appears on the TV screen. Press **ENTER** to end.
- 5 Press **SET UP** to return to the normal screen.

### Background and text colour

You can choose to customise the background or text colour or both. To customise both the background and text colour, the disc used for update must contain both the image and text data. To customise either the background or text colour, the disc should contain only the respective data.

The text data corresponds to the image data; Text01.bmp to User01.bmp and Text18.bmp to User18.bmp.

### Example:

If Text01.bmp is set to yellow colour and User01.bmp is selected as the background, the disc name (if any) and all the title names will be displayed in yellow.

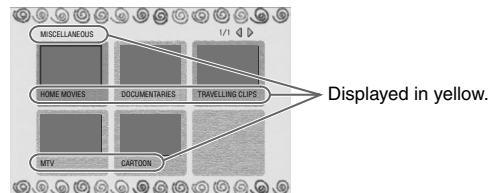

## Setting The Background And Text Colour

You can select a desired background from the 18 original backgrounds or the backgrounds and/or text colours that you have created (pg. 63), and set it as the default background to be used during finalisation (pg. 44, 61).

- Turn on the unit.
- Turn on the TV and select the AV mode.
- Slide the TV/DVD switch to DVD.

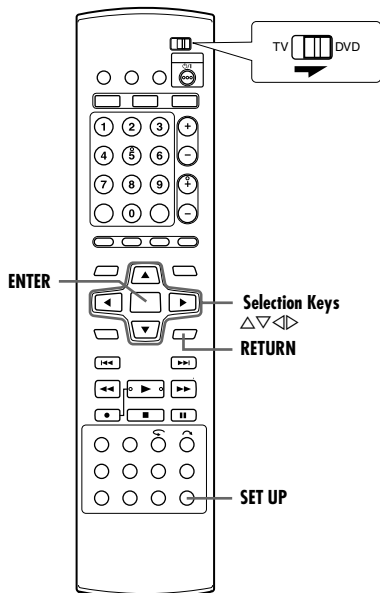

## Registering Default Background And Text Colour

- 1 Press **SET UP** to access the Main Menu screen.
- 2 Press **selection keys** to select "INITIAL SET UP", then press  $\nabla$ .
- 3 Press **selection keys** to select "MENU BACKGROUND", then press  $\nabla$ .
- 4 Press **selection keys** to select "REGISTER", then press **ENTER**.
  - The background selection screen appears. The current background selected is indicated by a check mark "✓" superimposed on it.
  - To return to the previous screen, press **RETURN**.
- 5 Press **selection keys** to select the desired background, then press **ENTER**.
  - The "✓" mark is superimposed on the newly selected background.
  - A preview screen of the selected background will be displayed for approximately 2 seconds.
  - The selected background will be used as the default background for finalisation.
- 6 Press **SET UP** to return to the normal screen.

### NOTE:

When you update the backgrounds/text colour or restore the original backgrounds/text colour, the default setting registered in the above procedures will be cleared.

### Previewing the background effect

This unit allows you to preview the effect of the background and/or text colour you have selected before proceeding with finalisation. This preview function is only possible when finalising a DVD-R/RW (Video mode) disc.

After selecting a background in step 8 of "Finalise A DVD-R/RW Disc" (pg. 61):

- 1 Press **selection keys** to select "PREVIEW", then press **ENTER**.
  - A preview screen of the final result of your selected background will appear.
  - To exit the preview screen, press **ENTER**.
  - To preview again, press **selection keys** to select "RECONFIRM", then press **ENTER**.
- 2 Press **selection keys** to select "OK", then press **ENTER** to continue with finalisation.
- 3 Proceed to perform steps 9 – 11 of "Finalise A DVD-R/RW Disc" (pg. 61) to complete finalisation.



## Scan Mode Set (HDD & DVD Deck Only)

If you connect the unit and TV with Component Video Connection (see pg. 16), you can select the scan mode from two modes: Interlaced scan mode which is used in the conventional TV system, and Progressive scan mode which enables reproduction of higher-quality images.

### Interlaced scan

In the conventional video system, a picture is shown on the display monitor in two halves. The Interlaced scan system places lines of the second half of the picture in-between lines of the first half of the picture.

### Progressive scan

Progressive scan displays all the horizontal lines of a picture at one time, as a single frame. This system can convert the interlaced video from DVD into progressive format for connection to a progressive display. It dramatically increases the vertical resolution.

#### ATTENTION:

Your TV needs to be compatible with PAL Progressive.

- Turn on the unit.
- Turn on the TV and select the AV mode.
- Slide the TV/DVD switch to DVD.

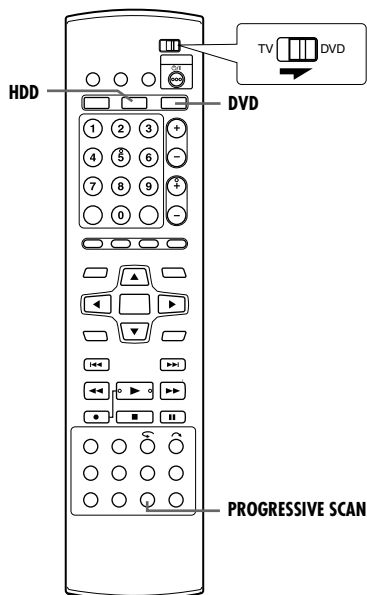

**1** Press **HDD** or **DVD** so that the HDD or DVD lamp lights up on the unit.

**2** Press **PROGRESSIVE SCAN** for 3 or more seconds.

- Video output indicator (P) lights on the front display panel if Progressive scan mode has been established. (see pg. 12)
- Each press of **PROGRESSIVE SCAN** for 3 or more seconds switches the scan mode.

#### NOTES:

- Interlaced scan mode is the setting at your purchase.
- Interlaced scan mode might be suitable depending on video material.
- Scan mode cannot be set while menu screen is displayed.
- When the Progressive scan mode is engaged, no video signal is output from [S-VIDEO OUTPUT] connector and [VIDEO/AUDIO OUTPUT] connectors.

## Tray Lock (DVD Deck Only)

You can lock the disc tray to prohibit the unwanted disc ejection by children.

- Turn off the unit.

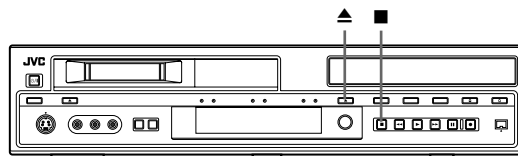

### To lock tray

While the unit is turned off, press and hold ■, then press ▲ on the unit. "LOCK" appears on the front display panel and the disc tray is locked.

### To unlock tray

While the unit is turned off, press and hold ■, then press ▲ on the unit. "UNLOCK" appears on the front display panel.

## Mode Lock

During playback or recording, press and hold **F1** for more than 5 seconds. "LOCK" appears on the front display panel.

- No buttons will function and playback and recording will not be interrupted.
- When the unit is in the stop mode, all buttons will not function except ● and ▶.

To cancel Mode Lock, press and hold **F1** again for more than 5 seconds.

#### NOTE:

It is also possible to use Mode Lock during Repeat Playback (see pg. 25).

## Last Function Memory

When the power plug is disconnected from unit or when power failure occurs, your settings for the following functions are kept in the memory. These settings will resume when the unit is turned on again.

- Input selection (channel or auxiliary input; L-1, F-1 or DV)
- Recorder selection (The last selected deck is memorised.)
- Recording mode (see pg. 48)
- Mode settings (see pg. 57 – 59)

Before requesting service for a problem, use this chart and see if you can solve the trouble yourself. Small problems are often easily solved, and this can save you the trouble of sending your unit off for repair.

## Initialising (DVD Deck Only)

### Malfunction occurs on the unit.

- Press  $\odot$ /I to turn off the unit, press and hold  $\odot$ /I, then press ■ for two seconds or more.

## General

### No power is supplied to the unit.

- The AC power plug is disconnected from the mains outlet.
- Connect the AC power plug to the mains outlet securely. (☞ pg. 16)

### The remote control does not work properly.

- Remove the batteries, wait for 5 minutes or more, then load the batteries again.
- The setting of the remote control code is inappropriate.
- Set the same remote control code (1, 2, 3, or 4) on both the unit and the remote control. (☞ pg. 55)
- The batteries are discharged.
- Replace the dead batteries with new ones. The remote control code will revert back to its default setting "3". If you had change the remote control code prior to replacing the batteries, you need to set the code again. (☞ pg. 55)

### Dubbing from the external equipment is not possible.

- The source (another video recorder, camcorder) has not been properly connected.
- Confirm that the source is properly connected.
- All necessary power switches have not been turned on.
- Confirm that all units' power switches are turned on.
- The setting of the input channel position is inappropriate.
- Select the input channel position ("F-1" or "L-1") that corresponds to the input terminal connected to the external equipment. (☞ pg. 51)

### The on-screen display superimposed on the programme played back/received on this unit is recorded when you dub the programme to an external recording equipment.

- Set "SUPERIMPOSE" to "OFF". (☞ pg. 58)

### The unit does not operate.

- There are cases when the operation is prohibited on the disc.
- Lightning or static electricity may cause malfunction of the unit.
- Press  $\odot$ /I to turn the power off, then press the button again to turn the power on.

### The remote control of a JVC TV will not operate the unit.

- The setting of the remote control code is inappropriate.
- To operate the unit using a JVC TV remote control, set the remote control code of the unit to "1" (Default: "3"). (☞ pg. 55)

## Playback (DVD Deck)

### The DVD deck cannot be operated.

- The DVD deck is not selected.
- Press **DV/HDD/DVD** on the unit repeatedly or **DVD** on the remote control so that the DVD lamp lights up on the unit.

### Images do not appear on the TV screen.

- The TV receiver's channel selector is not set to the AV mode.
- Set the TV to its AV mode.

- When interlace scanned programme is played back, progressive scan mode is selected.
- Press and hold **PROGRESSIVE SCAN** until **P** disappears from the front display panel. (☞ pg. 65)

### Playback does not start or stop immediately after playback is started by pressing ►.

On the front display panel, "NO DISC" appears.

- The disc is loaded upside down.
- Place the disc on the disc tray with the playback surface facing down. (☞ pg. 8)
- A disc not being compatible with the unit is loaded.
- Load a playable disc on the unit. (☞ pg. 5)
- A dirty disc is loaded.
- Clean the disc. (☞ pg. 9)
- Defective disc is loaded.
- Replace the warped or scratched disc with a normal one.

### Images are blurred or distorted when you start High-Speed Search.

- Images are blurred or distorted at the point where the playback speed changes and this is not a malfunction of the unit.

### Playback does not start.

- Playback does not start for approximately 30 seconds after recording is stopped and this is not a malfunction of the unit.

## Playback (HDD Deck)

### The HDD deck cannot be operated.

- The HDD deck is not selected.
- Press **DV/HDD/DVD** on the unit repeatedly or **HDD** on the remote so that the HDD lamp lights up on the unit.

## Playback (DV Deck)

### The DV deck cannot be operated.

- The DV deck is not selected.
- Press **DV/HDD/DVD** on the unit repeatedly or **DV** on the remote control so that the DV lamp lights up on the unit.

### The tape will not rewind or fast-forward.

- The tape is already fully rewound or fast-forwarded.
- Check the cassette.

### The playback picture does not appear while the tape is running.

- The TV is not set to the AV mode.
- Set the TV to the AV mode.

### Noise appears during visual search.

- This is normal.

### The playback picture is blurred or interrupted while TV broadcasts are clear or "USE CLEANING CASSETTE" message appears on the screen.

- The video heads may be dirty.
- Use a dry cleaning cassette M-DV12CL, or consult your JVC dealer.

## Recording (DVD Deck)

### Recording cannot be made.

- No disc or a disc not being compatible with the unit is loaded.
- Load a recordable disc on the unit. (☞ pg. 5)
- The disc loaded is not formatted.
- Format the disc. (☞ pg. 60)

- A finalised DVD-R disc is loaded.
- Recording cannot be made on finalised discs. Load a recordable disc on the unit.
- The disc is full or does not have enough space for the title to be recorded.
- Clear unnecessary titles on the disc or load a blank disc. (pg. 38)
- The DVD-RAM disc loaded has had its protect tab slid to the protect position.
- Release the protect tab. (pg. 8)

## Recording (HDD Deck)

### Camcorder recording is not possible.

- The camcorder has not been properly connected.
- Confirm that the camcorder is properly connected.
- The input mode is not correct.
- Set the input mode to "F-1". (pg. 50)

## Recording (DV Deck)

### During recording, the tape does not run. The DV recording lamp lights up on the unit.

- The unit is in the Record Pause mode.
- Press ► to resume recording.

### Recording cannot be done.

- There is no cassette loaded, or the cassette loaded has had its erase protection switch set to "SAVE".
- Insert a Mini DV cassette, or set the erase protection switch set to "REC".

### Camcorder recording is not possible.

- The camcorder has not been properly connected.
- Confirm that the camcorder is properly connected.
- The input mode is not correct.
- Set the input mode to "F-1" or "DV".

### The tape is automatically rewound, then the unit is shut off.

- The end of the tape was reached during recording.
- The programme may not have been recorded in its entirety. Next time make sure you have enough time on the tape to record the entire programme.

### Audio dubbing is not possible.

- "DV AUDIO REC" had been set to "16BIT" at the original recording.
- Set "DV AUDIO REC" to "12BIT" at the original recording.
- The tape speed had been set to LP at the original recording.
- Set the tape speed to SP at the original recording.

### Monitoring the audio dubbed sound is not possible during audio dubbing.

- This is normal. Monitor the sound using the connected devices.

## Other Problems

### The image of the programme appears distorted on the TV screen.

#### For basic connection

- Press **PROGRESSIVE SCAN** for 3 or more seconds so that the Video output indicator (P) lights off on the front display panel.

#### For component video connection

- Press **PROGRESSIVE SCAN** for 3 or more seconds so that the Video output indicator (P) lights up on the front display panel.

### Whistling or howling is heard from the TV during camcorder recording.

- The camcorder's microphone is too close to the TV.
- Position the camcorder so its microphone is away from the TV.
- The TV's volume is too high.
- Turn the TV's volume down.

### The AV input cannot be changed.

- Recording or RetroActive Recording\* is in progress.
- Press **II** to pause recording, change the AV input, then press ► to resume recording.
- \* HDD deck only.

### Malfunction occurs and the unit cannot be power off.

- Reset the unit by disconnecting the AC power plug from the AC outlet and connect again.

### Buttons and controls do not function at all.

- Mode Lock is activated.
- Press and hold **F1** for more than 5 seconds to cancel Mode Lock. Or disconnect the power cord and connect again.

**On-screen Message (HDD & DVD Deck Only)****DISC NOT REGISTERED IN THE LIBRARY  
REGISTER DISC?**

- A disc that is not registered in the library has been inserted. Register the disc as necessary. (pg. 42)

**TITLE MEMORY IS FULL, UNABLE TO RECORD  
DELETE UNWANTED TITLE**

- Recording and/or editing cannot be performed.
- The number of titles exceeds 99.
- The number of play lists exceeds 99.

**DISC NOT LOADED**

- Operation has been attempted when a disc is not loaded, or loaded upside down. (pg. 8)

**DISC NOT RECORDABLE  
INSERT RECORDABLE DISC**

- When a playback-only disc or a finalised disc is loaded, ● has been pressed. (pg. 5)

**REGION CODE ERROR  
CHECK DISC**

- A disc loaded cannot be played back on this unit since the region number of the disc does not match that of the unit. (pg. 6)

**UNREADABLE DISC  
CHECK THE DISC**

- When an incompatible disc is loaded, ► has been pressed. (pg. 6)

**COULD NOT FORMAT THE DISC  
CHECK THE DISC**

- Formatting is not complete since the disc may be dirty or damaged. Take out the disc, clean it and retry. (pg. 9, 60)

**CAN NOT FINALISE THIS DISC**

- Finalising is not complete since the disc may be dirty or damaged. Take out the disc, clean it and retry. (pg. 9, 61)

**CAN NOT CANCEL FINALISATION OF THIS DISC**

- Cancelling disc finalisation is not complete since the disc may be dirty or damaged. Take out the disc, clean it and retry. (pg. 9, 62)

**PRESS [■] AGAIN TO STOP RECORDING**

- During Live Memory playback, ■ has been pressed. (pg. 34).

**COPY PROHIBITED  
CAN NOT RECORD**

- An attempt has been made to record copy-protected contents.
- An attempt has been made to record copy-once contents on a disc that is not CPRM compatible.

**THE i.LINK DEVICE THAT YOU HAVE CONNECTED IS NOT  
RECOGNIZED  
MAKE SURE THAT THE DEVICE IS CONNECTED PROPERLY  
AND POWERED ON**

- An attempt has been made to start DV dubbing when a digital video camera is not properly connected to the unit.
- Check the connection. (pg. 48)

## Language Code List

AA	Afar	IN	Indonesian	RU	Russian
AB	Abkhazian	IS	Icelandic	RW	Kinyarwanda
AF	Afrikaans	IW	Hebrew	SA	Sanskrit
AM	Ameharic	JI	Yiddish	SD	Sindhi
AR	Arabic	JW	Javanese	SG	Sangho
AS	Assamese	KA	Georgian	SH	Serbo-Croatian
AY	Aymara	KK	Kazakh	SI	Singhalese
AZ	Azerbaijani	KL	Greenlandic	SK	Slovak
BA	Bashkir	KM	Cambodian	SL	Slovenian
BE	Byelorussian	KN	Kannada	SM	Samoan
BG	Bulgarian	KO	Korean (KOR)	SN	Shona
BH	Bihari	KS	Kashmiri	SO	Somali
BI	Bislama	KU	Kurdish	SQ	Albanian
BN	Bengali, Bangla	KY	Kirghiz	SR	Serbian
BO	Tibetan	LA	Latin	SS	Siswati
BR	Breton	LN	Lingala	ST	Sesotho
CA	Catalan	LO	Laothian	SU	Sundanese
CO	Corsican	LT	Lithuanian	SW	Swahili
CS	Czech	LV	Latvian, Lettish	TA	Tamil
CY	Welsh	MG	Malagasy	TE	Telugu
DZ	Bhutani	MI	Maori	TG	Tajik
EL	Greek	MK	Macedonian	TH	Thai
EO	Esperanto	ML	Malayalam	TI	Tigrinya
ET	Estonian	MN	Mongolian	TK	Turkmen
EU	Basque	MO	Moldavian	TL	Tagalog
FA	Persian	MR	Marathi	TN	Setswana
FJ	Fiji	MS	Malay (MAY)	TO	Tonga
FO	Faroese	MT	Maltese	TR	Turkish
FY	Frisian	MY	Burmese	TS	Tsonga
GA	Irish	NA	Nauru	TT	Tatar
GD	Scots Gaelic	NE	Nepali	TW	Twi
GL	Galician	OC	Occitan	UK	Ukrainian
GN	Guarani	OM	(Afan) Oromo	UR	Urdu
GU	Gujarati	OR	Oriya	UZ	Uzbek
HA	Hausa	PA	Panjabi	VI	Vietnamese
HI	Hindi	PL	Polish	VO	Volapuk
HR	Croatian	PS	Pashto, Pushto	WO	Wolof
HU	Hungarian	PT	Portuguese	XH	Xhosa
HY	Armenian	QU	Quechua	YO	Yoruba
IA	Interlingua	RM	Rhaeto-Romance	ZH	Chinese
IE	Interlingue	RN	Kirundi	ZU	Zulu
IK	Inupiak	RO	Rumanian		

## RS-232C Interface – Command Table –

Lower Order → Higher Order ↓	0	1	2	3	4	5	6	7	8	9	A	B	C	D	E	F
0		Complete	Error	Cassette Out		Not Target					ACK	NAK				
1																
2																
3											Play					Stop
4			CueUp with Data													Still
5							Clear									
6	Chapter Sense	Title Sense														
7																
8	Chapter Search	Title Search													Date Preset	Clock Preset
9	Finalise	Cancel-Disc Finalisation	DiscErase	TOP MENU	MENU	NEXT CHAPTER	PREV CHAPTER	Setup	SET	UP	DOWN	RIGHT	LEFT	Next Title	Prev Title	Remote Data
A	Standby On	Standby Off		Eject								FF	REW	Fwd Field Step	Rev Field Step	
B			CueUp with Data			Fwd Shtl	Rev Shtl		Select Preset	Select Sense					Date Data Sense	ClockData Sense
C											Rec	Rec Pause				
D								Status Sense	Tc Data Sense	CTL Data Sense				JVCStatus Sense		
E																
F	Command Target										Rec/Dub Request	Vtr Ind				

## RS-232C Interface – Specifications –

### • 9PIN D-Sub

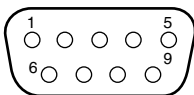

PIN No.	Signal	Operation	Direction of signal
2	RxD	Receive data	HDD/DVD ← PC
3	TxD	Transmit data	HDD/DVD → PC
5	GND	Signal grounding	

Mode : Non-synchronous  
 Character length : 8 bits  
 Parity check : Odd  
 Start bit : 1  
 Stop bit : 1  
 Data rate : 9600bps  
 Bit configuration

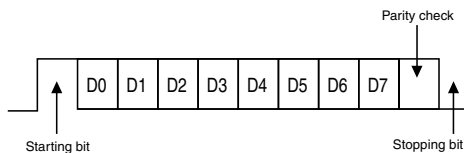

### NOTES:

- When using the Serial Command Connector, the cable to be used should be a RS-232C interface cable (straight type).
- It takes about 10 seconds for the communication to be established after turning on the unit.
- During command transmission, a minimum interval of 50 mm/second is required between each command.

## RS-232C Interface – Command –

### • Operation Commands

Commands for operating functions such as PLAY and REC on the HDD/DVD/Mini DV deck.

Command	Description
3A	Plays the selected deck.
3F	Stops the selected deck. Resume will be cleared when this is pressed while in the Stop mode. (HDD/DVD Deck) Rec Request will be cleared.
42 or B2	For cueing the desired position on the tape. (Mini DV Deck) See page 72 for data format.
4F	Switches the selected deck to the Still mode.
80	Searches the specified chapter and starts playback from the beginning. (HDD/DVD Deck) See page 72 for data format.
81	Searches the specified title under "ORIGINAL" or in the "PLAY LIST" by its number and starts playback from the beginning. (HDD/DVD Deck) See page 73 for data format.
8E	For setting the date. See page 73 for data format.
8F	For setting the time. See page 73 for data format.
90	Finalises the disc. (HDD/DVD Deck)
91	Cancels disc finalisation. (HDD/DVD Deck)
92	For erasing rewritable discs.
93	Displays/Closes the top menu of a disc. (DVD Deck)
94	Displays/Closes the disc menu. (DVD Deck)
95	Advances to the next chapter. Functions like the ►►  button on the remote control. (HDD/DVD Deck)
96	Returns to the previous chapter. Functions like the  ◄◄ button on the remote control. (HDD/DVD Deck)
97	Displays/Closes the Main Menu, Editing, Library Database Navigation or Dubbing screen. 97 → 30: Closes the screen. 97 → 31: Displays the Main Menu screen. 97 → 32: Displays the Library Database Navigation screen. (HDD/DVD Deck) 97 → 35: Displays the Editing screen. (HDD/DVD Deck) 97 → 37: Displays the Dubbing screen.
98	Functions as a confirmation key.
99	Functions as an up key.
9A	Functions as a down key.
9B	Functions as a right key.
9C	Functions as a left key.
9D	Advances to the next title. Functions like the ►►  button on the remote control. (DVD Deck)
9E	Returns to the previous title. Functions like the  ◄◄ button on the remote control. (DVD Deck)
9F	Issues the same codes as the wired remote control via RS-232C. See page 74 for the remote control codes.
A0	Power On
A1	Power Off
A3	Eject: HDD/DVD Deck: Opens/Closes tray. Mini DV Deck: Removes cassette.
AB	FF: HDD/DVD Deck: Functions only during playback. Activates forward search. For details on the search speed for HDD and DVD deck, refer to "Variable Speed Search" on pages 29 and 21 respectively. Mini DV Deck: Fast forward. Search Fwd during playback. For details on the search speed, refer to "Variable Speed Search" (pg. 32).

Command	Description
AC	REW: HDD/DVD Deck: Functions only during playback. Activates reverse search. For details on the search speed for HDD and DVD deck, refer to "Variable Speed Search" on pages 29 and 21 respectively. Mini DV Deck: Rewind. Search Rev during playback. For details on the search speed, refer to "Variable Speed Search" (pg. 32).
AD	Functions as a key for advancing (FWD) a frame. When this command is received during still mode, the unit advances the still picture by one frame (or field) in the FWD direction.
AE	Functions as a key for reversing (REV) a frame. When this command is received during still mode, the unit reverses the still picture by one frame (or field) in the REV direction.
B5	Fwd Shtl: Functions only during playback. Activates forward search. B5 → 30: STILL B5 → 31: FWD SLOW at a slow speed. B5 → 33: FWD SLOW at a fast speed. B5 → 35: 1x B5 → 36: FWD SEARCH at a fast speed. B5 → 37: FWD SEARCH at a faster speed. B5 → 38: FWD SEARCH at the fastest speed.
B6	Rev Shtl: Functions only during playback. Activates reverse search. B6 → 30: STILL B6 → 31: REV SLOW at a slow speed. B6 → 33: REV SLOW at a fast speed. B6 → 35: -1x B6 → 36: REV SEARCH at a fast speed. B6 → 37: REV SEARCH at a faster speed. B6 → 38: REV SEARCH at the fastest speed.
B8	For setting the input/output, recording mode, audio language selection and subtitle selection. See pages 75 - 77 for data format.
CA	Rec: Starts recording at the selected deck when a Rec Request is received.
CB	Rec Pause: Switches the selected deck to the Rec Pause mode when a Rec Request is received. (Mini DV/DVD Deck)
F0	Command Target: F0 → 30: For selecting Mini DV deck. F0 → 34: For selecting HDD deck. F0 → 38: For selecting DVD deck.
FA	Rec Request: For issuing approval for recording. This can be cleared using STOP.

## 42 or B2: CueUp with Data

	1st Byte	2nd Byte	3rd Byte	4th Byte	5th Byte	6th Byte	7th Byte	8th Byte
Cue Position	Hr (Tens)	Hr (Ones)	Min (Tens)	Min (Ones)	Sec (Tens)	Sec (Ones)	Frame (Tens)	Frame (Ones)
ASCII codes (30 - 39)	3*	3*	3*	3*	3*	3*	3*	3*
E.g. (01:23:45:15)	30	31	32	33	34	35	31	35

E.g.: When setting the desired position at the 15th frame at 1 hr 23 min 45 sec.

## 80: Chapter Search

	1st Byte	2nd Byte	3rd Byte
Chapter Search	Hundreds	Tens	Ones
ASCII codes (30 - 39)	3*	3*	3*
E.g. (012)	30	31	32

E.g.: When searching the 12th chapter.



## 81: Title Search under "ORIGINAL"

	1st Byte	2nd Byte	3rd Byte	4th Byte
Title Search (ORIGINAL)	30	Hundreds	Tens	Ones
ASCII codes (30 - 39)	30	3*	3*	3*
E.g. (345)	30	33	34	35

E.g.: When searching the 345th title, as indicated by the title number on the top right corner of the index, under "ORIGINAL". (pg. 36)

## 81: Title Search in "PLAY LIST"

	1st Byte	2nd Byte	3rd Byte	4th Byte
Title Search (PLAY LIST)	38	Hundreds	Tens	Ones
ASCII codes (30 - 39)	38	3*	3*	3*
E.g. (028)	38	30	32	38

E.g.: When searching the 28th play list, as indicated by the play list number on the top right corner of the index, in the "PLAY LIST". (pg. 41)

## 8E: Date Preset

	1st Byte	2nd Byte	3rd Byte	4th Byte	5th Byte	6th Byte
Date Preset	Mth (Tens)	Mth (Ones)	Day (Tens)	Day (Ones)	Yr (Tens)	Yr (Ones)
ASCII code (30 - 39)	3*	3*	3*	3*	3*	3*
E.g. (01.17.2006)	30	31	31	37	30	36

E.g.: When setting the date to January 17 2006.

## 8F: Clock Preset

	1st Byte	2nd Byte	3rd Byte	4th Byte	5th Byte	6th Byte
Clock Preset	Hr (Tens)	Hr (Ones)	Min (Tens)	Min (Ones)	Sec (Tens)	Sec (Ones)
ASCII code (30 - 39)	3*	3*	3*	3*	3*	3*
E.g. (12:34:56)	31	32	33	34	35	36

E.g.: When setting the time to 12 hrs 34 min and 56 sec.

## 9F: Remote Data

The remote control codes for controlling the VTR (similar to wired remote control) via RS-232C is as shown in the following table. The codes apply to all three DV, HDD and DVD deck unless otherwise stated.

Code	Items	Remarks	Code	Items	Remarks
03	STOP		8F	TOP MENU	DVD Deck only
04	EJECT	DV Deck only	90	MEMORY	HDD/DVD Deck only
06	F.F/SPEED+		96	CM SKIP	
07	REW/SPEED-		97	iLINK	DV Deck only
0B	POWER ON/OFF	"QUICK STARTUP" must be set to "ON" for the power on function to work. (☞ pg. 59)	AF	REV FRAME	
0C	PLAY		B0	-SLOW D	
0D	PAUSE/STILL		B1	SHUTTLE-C	
0E	JUMP+	HDD/DVD Deck only	B2	SHUTTLE-B	
0F	JUMP-		B3	SHUTTLE-A	
14	FWD SKIP		B4	SHUTTLE-2	
15	REV SKIP		B5	SHUTTLE-1	
17	AUDIO		B6	-SLOW B	
18	CH - (PR-)		B7	-SLOW C	
19	CH + (PR+)		B8	+SLOW C	
20	TEN KEY 0 (AUX)		B9	+SLOW B	
21	TEN KEY 1	HDD/DVD Deck only	BA	SHUTTLE +1	
22	TEN KEY 2		BB	SHUTTLE +2	
23	TEN KEY 3		BC	SHUTTLE +A	
24	TEN KEY 4		BD	SHUTTLE +B	
25	TEN KEY 5		BE	SHUTTLE +C	
26	TEN KEY 6		BF	+SLOW D	
27	TEN KEY 7		C0	ANGLE/LIVE CHECK	ANGLE (DVD Deck only) LIVE CHECK (HDD/DVD Deck only)
28	TEN KEY 8		C4	SUBTITLE	DVD Deck only
29	TEN KEY 9	CC	REC		
31	REC MODE (SP/LP/EP...)		CD	REC PAUSE	
32	DVD DECK		D4	RETURN	
33	CH-0 (AUX)		D6	DV/HDD/DVD	
34	DUBBING		D8	JOG-1	HDD/DVD Deck only
36	CANCEL	HDD/DVD Deck only	D9	JOG-1/6	
37	SET UP		DA	JOG +1/6	
38	DISPLAY SELECT		DB	JOG +1	
3C	OK/ENTER		DC	INSTANT REPLAY	
3E	ON SCREEN		DD	EDIT	HDD/DVD Deck only
43	DV DECK		E0	NAVIGATION	
44	HDD DECK		E1	L1 Y/C INPUT SELECT	DV Deck only
4C	A.DUB	DV Deck only	E2	L1 COMPOSITE INPUT SELECT	
7C	SP		E6	OUTPUT SELECT ALL	
7D	LP		E7	OUTPUT SELECT DV	
80	CUSOR 0°	Moves the arrow in the index list (☞ pg. 36) to the right.	E8	OUTPUT SELECT ALL/DV	
81	MENU	DVD Deck only	E9	ON AIR	HDD/DVD Deck only
82	CUSOR 90°	Moves the arrow in the index list (☞ pg. 36) up.	EC	F-1 Y/C INPUT SELECT	DV Deck only
84	CUSOR 180°	Moves the arrow in the index list (☞ pg. 36) to the left.	ED	FWD FRAME	
86	CUSOR 270°	Moves the arrow in the index list (☞ pg. 36) down.	EE	F-1 COMPOSITE INPUT SELECT	DV Deck only
87	OPEN/CLOSE	DVD Deck only	F2	MODE LOCK	
8E	PROGRESSIVE	HDD/DVD Deck only	F3	FINALISE	HDD/DVD Deck only

## B8: Input/Output Selection

		1st Byte	2nd Byte
External input selection	L-1 VIDEO	30	31
	L-1 S-VIDEO	30	39
	F-1 VIDEO	30	35
	F-1 S-VIDEO	30	3D
	DV	30	34
Output selection	Common output	32	30
	Mandatory DV output	32	38

## B8: Recording Mode Selection

	1st Byte	2nd Byte		1st Byte	2nd Byte		1st Byte	2nd Byte
XP	34	30	FR150	34	93	FR265	34	AA
SP	34	31	FR155	34	94	FR270	34	AB
LP	34	32	FR160	34	95	FR275	34	AC
EP	34	33	FR165	34	96	FR280	34	AD
DV	34	38	FR170	34	97	FR285	34	AE
FR60	34	81	FR175	34	98	FR290	34	AF
FR65	34	82	FR180	34	99	FR295	34	B0
FR70	34	83	FR185	34	9A	FR300	34	B1
FR75	34	84	FR190	34	9B	FR305	34	B2
FR80	34	85	FR195	34	9C	FR310	34	B3
FR85	34	86	FR200	34	9D	FR315	34	B4
FR90	34	87	FR205	34	9E	FR320	34	B5
FR95	34	88	FR210	34	9F	FR325	34	B6
FR100	34	89	FR215	34	A0	FR330	34	B7
FR105	34	8A	FR220	34	A1	FR335	34	B8
FR110	34	8B	FR225	34	A2	FR340	34	B9
FR115	34	8C	FR230	34	A3	FR345	34	BA
FR120	34	8D	FR235	34	A4	FR350	34	BB
FR125	34	8E	FR240	34	A5	FR355	34	BC
FR130	34	8F	FR245	34	A6	FR360	34	BD
FR135	34	90	FR250	34	A7	FR420	34	C9
FR140	34	91	FR255	34	A8	FR480	34	D5
FR145	34	92	FR260	34	A9			

## B8: Audio Language Selection

	1st Byte	2nd Byte		1st Byte	2nd Byte		1st Byte	2nd Byte
JAPANESE	39	11	HI	39	3F	RM	39	6D
ENGLISH	39	12	HR	39	40	RN	39	6E
GERMAN	39	13	HU	39	41	RO	39	6F
FRENCH	39	14	HY	39	42	RU	39	70
ITALIAN	39	15	IA	39	43	RW	39	71
SPANISH	39	16	IE	39	44	SA	39	72
DUTCH	39	17	IK	39	45	SD	39	73
SWEDISH	39	18	IN	39	46	SG	39	74
NORWEGIAN	39	19	IS	39	47	SH	39	75
FINNISH	39	1A	IW	39	48	SI	39	76
DANISH	39	1B	JI	39	49	SK	39	77
AA	39	1C	JW	39	4A	SL	39	78
AB	39	1D	KA	39	4B	SM	39	79
AF	39	1E	KK	39	4C	SN	39	7A
AM	39	1F	KL	39	4D	SO	39	7B
AR	39	20	KM	39	4E	SQ	39	7C
AS	39	21	KN	39	4F	SR	39	7D
AY	39	22	KO	39	50	SS	39	7E
AZ	39	23	KS	39	51	ST	39	7F
BA	39	24	KU	39	52	SU	39	80
BE	39	25	KY	39	53	SW	39	81
BG	39	26	LA	39	54	TA	39	82
BH	39	27	LN	39	55	TE	39	83
BI	39	28	LO	39	56	TG	39	84
BN	39	29	LT	39	57	TH	39	85
BO	39	2A	LV	39	58	TI	39	86
BR	39	2B	MG	39	59	TK	39	87
CA	39	2C	MI	39	5A	TL	39	88
CO	39	2D	MK	39	5B	TN	39	89
CS	39	2E	ML	39	5C	TO	39	8A
CY	39	2F	MN	39	5D	TR	39	8B
DZ	39	30	MO	39	5E	TS	39	8C
EL	39	31	MR	39	5F	TT	39	8D
EO	39	32	MS	39	60	TW	39	8E
ET	39	33	MT	39	61	UK	39	8F
EU	39	34	MY	39	62	UR	39	90
FA	39	35	NA	39	63	UZ	39	91
FJ	39	36	NE	39	64	VI	39	92
FO	39	37	OC	39	65	VO	39	93
FY	39	38	OM	39	66	WO	39	94
GA	39	39	OR	39	67	XH	39	95
GD	39	3A	PA	39	68	YO	39	96
GL	39	3B	PL	39	69	ZH	39	97
GN	39	3C	PS	39	6A	ZU	39	98
GU	39	3D	PT	39	6B			
HA	39	3E	QU	39	6C			

## B8: Subtitle Selection

	1st Byte	2nd Byte		1st Byte	2nd Byte		1st Byte	2nd Byte
OFF	3C	10	HA	3C	3E	QU	3C	6C
JAPANESE	3C	11	HI	3C	3F	RM	3C	6D
ENGLISH	3C	12	HR	3C	40	RN	3C	6E
GERMAN	3C	13	HU	3C	41	RO	3C	6F
FRENCH	3C	14	HY	3C	42	RU	3C	70
ITALIAN	3C	15	IA	3C	43	RW	3C	71
SPANISH	3C	16	IE	3C	44	SA	3C	72
DUTCH	3C	17	IK	3C	45	SD	3C	73
SWEDISH	3C	18	IN	3C	46	SG	3C	74
NORWEGIAN	3C	19	IS	3C	47	SH	3C	75
FINNISH	3C	1A	IW	3C	48	SI	3C	76
DANISH	3C	1B	JI	3C	49	SK	3C	77
AA	3C	1C	JW	3C	4A	SL	3C	78
AB	3C	1D	KA	3C	4B	SM	3C	79
AF	3C	1E	KK	3C	4C	SN	3C	7A
AM	3C	1F	KL	3C	4D	SO	3C	7B
AR	3C	20	KM	3C	4E	SQ	3C	7C
AS	3C	21	KN	3C	4F	SR	3C	7D
AY	3C	22	KO	3C	50	SS	3C	7E
AZ	3C	23	KS	3C	51	ST	3C	7F
BA	3C	24	KU	3C	52	SU	3C	80
BE	3C	25	KY	3C	53	SW	3C	81
BG	3C	26	LA	3C	54	TA	3C	82
BH	3C	27	LN	3C	55	TE	3C	83
BI	3C	28	LO	3C	56	TG	3C	84
BN	3C	29	LT	3C	57	TH	3C	85
BO	3C	2A	LV	3C	58	TI	3C	86
BR	3C	2B	MG	3C	59	TK	3C	87
CA	3C	2C	MI	3C	5A	TL	3C	88
CO	3C	2D	MK	3C	5B	TN	3C	89
CS	3C	2E	ML	3C	5C	TO	3C	8A
CY	3C	2F	MN	3C	5D	TR	3C	8B
DZ	3C	30	MO	3C	5E	TS	3C	8C
EL	3C	31	MR	3C	5F	TT	3C	8D
EO	3C	32	MS	3C	60	TW	3C	8E
ET	3C	33	MT	3C	61	UK	3C	8F
EU	3C	34	MY	3C	62	UR	3C	90
FA	3C	35	NA	3C	63	UZ	3C	91
FJ	3C	36	NE	3C	64	VI	3C	92
FO	3C	37	OC	3C	65	VO	3C	93
FY	3C	38	OM	3C	66	WO	3C	94
GA	3C	39	OR	3C	67	XH	3C	95
GD	3C	3A	PA	3C	68	YO	3C	96
GL	3C	3B	PL	3C	69	ZH	3C	97
GN	3C	3C	PS	3C	6A	ZU	3C	98
GU	3C	3D	PT	3C	6B			

### ● System Commands

Commands relating to RS-232C control system.

Command	Description
01	Complete: Issued by the VTR upon completing all specified operations by commands such as CueUp with Data.
02	Error: Issued by the VTR when receiving invalid commands in the context. In such cases, commands that are sent will not be accepted. However, a return command will be issued but only to the Status Sense. To clear the Error status, perform command 56 (Clear).
05	Not Target: Issued by the VTR when specified operations by commands such as CueUp with Data cannot be completed properly.
0A	ACK: A return command issued when a defined command is received.
0B	NAK: A return command issued when an undefined or possibly nonexistent command is received.
56	Clear: Clears the Error status.
FB	VTR Ind: A command for checking whether the connected device is a VTR.

### ● Response Commands

Commands for acquiring information such as deck status.

Command	Description
03	Cassette Out: Issued by the Mini DV deck when the cassette is ejected after ejecting is performed.
60	Chapter Sense: For acquiring the current chapter number.* (HDD/DVD Deck)
61	Title/Track Sense: For acquiring the current title number under "ORIGINAL" or in the "PLAY LIST".* (HDD/DVD Deck)
B9	Select Sense: For acquiring the status of the inputs, outputs, recording mode, audio language selection and subtitle selection.*
BE	Date Sense: For acquiring the currently configured year, month and day.*
BF	Time Sense: For acquiring the currently configured hour, minute and second.*
D7	Status Sense: For acquiring the deck information.*
D8	TC Data Sense: For acquiring the total remaining time in the current recording mode when there is a media in the selected deck.*
D9	CTL Data Sense: For acquiring the lapse counter when there is a media in the selected deck.*
DD	JVC Status Sense: Returns data from the unit.*

\* See pages 79 - 81 for data format.

#### Chapter Sense

	1st Byte	2nd Byte	3rd Byte
Chapter Sense	Hundreds	Tens	Ones
60	3*	3*	3*
E.g. (012)	30	31	32

E.g.: When the current chapter is the 12th chapter.

## Title/Track Sense under "ORIGINAL"

	1st Byte	2nd Byte	3rd Byte	4th Byte
Title/Track Sense (ORIGINAL)	30	Hundreds	Tens	Ones
61	30	3*	3*	3*
E.g. (345)	30	33	34	35

E.g.: When the current title under "ORIGINAL" is the 345th title.

## Title/Track Sense in "PLAY LIST"

	1st Byte	2nd Byte	3rd Byte	4th Byte
Title/Track Sense (PLAY LIST)	38	Hundreds	Tens	Ones
61	38	3*	3*	3*
E.g. (028)	38	30	32	38

E.g.: When the current title under "PLAY LIST" is the 28th title.

## Select Sense

	1st Byte	2nd Byte	3rd Byte	4th Byte	5th Byte
Select Sense	External input selection	Output selection	Recording mode selection	Audio language selection	Subtitle selection
B9	3*	3*	**	**	**
E.g. (3930311213)	39	30	31	12	13

E.g.: When the selection status of the VTR is as follows:

External input selection → L-1 S-VIDEO

Output selection → Common output

Recording mode selection → SP

Audio language selection → ENGLISH

Subtitle selection → GERMAN

For response data for B9, see data format for B8 (Select Preset) on pages 75 - 77.

## Date Data Sense

For acquiring the currently configured year, month and day in ASCII codes.

	1st Byte	2nd Byte	3rd Byte	4th Byte	5th Byte	6th Byte
Date Sense	Mth (Tens)	Mth (Ones)	Day (Tens)	Day (Ones)	Yr (Tens)	Yr (Ones)
BE	3*	3*	3*	3*	3*	3*
E.g. (01.17.2006)	30	31	31	37	30	36

When the current date is not set, the value is fixed as "—" (0x2D).

## Time Data Sense

For acquiring the currently configured hour, minute and second in ASCII codes.

	1st Byte	2nd Byte	3rd Byte	4th Byte	5th Byte	6th Byte
Time Sense	Hr (Tens)	Hr (Ones)	Min (Tens)	Min (Ones)	Sec (Tens)	Sec (Ones)
BF	3*	3*	3*	3*	3*	3*
E.g. (12:34:56)	31	32	33	34	35	36

When the current time is not set, the value is fixed as "—" (0x2D).

Status Data Sense

D7 STATUS SENSE	1byte			2byte		3byte	
	DV	HDD	DVD	DV	HDD/DVD	DV	HDD/DVD
bit7	0 (Fixed)	1 (Fixed)	1 (Fixed)	Video EE	Video EE	0 (Fixed)	0 (Fixed)
bit6	0 (Fixed)	0 (Fixed)	1 (Fixed)	Audio EE	Audio EE	0 (Fixed)	0 (Fixed)
bit5	0 (Fixed)	0 (Fixed)	0 (Fixed)	0 (Fixed)	0 (Fixed)	0 (Fixed)	0 (Fixed)
bit4	Record Forbidden	Record Forbidden	Record Forbidden	0 (Fixed)	0 (Fixed)	0 (Fixed)	0 (Fixed)
bit3	Cassette Not Inserted	Disc Not Inserted	Disc Not Inserted	Occurrence of abnormality in VTR	Occurrence of abnormality in VTR	0 (Fixed)	0 (Fixed)
bit2	0 (Fixed)	0 (Fixed)	0 (Fixed)	0 (Fixed)	0 (Fixed)	0 (Fixed)	During Repeat Playback (Including PAUSE)
bit1	0 (Fixed)	0 (Fixed)	0 (Fixed)	Start sensor	0 (Fixed)	During CueUp	0 (Fixed)
bit0	RS-232C command error status. Clear using 56 (Clear).	RS-232C command error status. Clear using 56 (Clear).	RS-232C command error status. Clear using 56 (Clear).	End sensor	0 (Fixed)	0 (Fixed)	0 (Fixed)

D7 STATUS SENSE	4byte		5byte	
	DV	HDD/DVD	DV	HDD/DVD
bit7	During PLAY	During PLAY	During PAUSE (Set to 1 simultaneously with "During PLAY" in STILL mode, set to 1 simultaneously with "During REC" in REC PAUSE mode.)	During PAUSE (Set to 1 simultaneously with "During PLAY" in STILL mode, set to 1 simultaneously with "During REC" in REC PAUSE mode.)
bit6	During FF	0 (Fixed)	0 (Fixed)	0 (Fixed)
bit5	During REW	0 (Fixed)	During Reverse Shuttle Search (Excluding STILL)	During Reverse Shuttle Search (Excluding STILL)
bit4	During STOP	During STOP	During Forward Shuttle Search (Excluding STILL)	During Forward Shuttle Search (Excluding STILL)
bit3	During STANDBY (Unit Power Off)	During STANDBY (Unit Power Off)	SPEED CODE 3	SPEED CODE 3
bit2	During CASSETTE EJECT	0 (Fixed)	SPEED CODE 2	SPEED CODE 2
bit1	During REC	During REC	SPEED CODE 1	SPEED CODE 1
bit0	During Audio Dub	0 (Fixed)	SPEED CODE 0	SPEED CODE 0

TC Data Sense

For acquiring the remaining time in the current recording mode in hours, minutes and seconds for HDD/DVD, and hours and minutes for Mini DV.

	1st Byte	2nd Byte	3rd Byte	4th Byte	5th Byte	6th Byte	7th Byte	8th Byte
TC Data Sense	Hr (Tens)	Hr (Ones)	Min (Tens)	Min (Ones)	Sec (Tens)	Sec (Ones)	Frame (Tens)	Frame (Ones)
D8	3*	3*	3*	3*	3*	3*	3*	3*
E.g. (01:23:45)	30	31	32	33	34	35	30	30

E.g.: When remaining time is 1 hr 23 min 45 sec.

Mini DV (hr and min only)

HDD/DVD (hr, min and sec only)

Frame is fixed as 0.



## CTL Data Sense

For acquiring lapse counter of selected deck in hours, minutes and seconds.

	1st Byte	2nd Byte	3rd Byte	4th Byte	5th Byte	6th Byte	7th Byte	8th Byte
CTL Data Sense	Hr (Tens)	Hr (Ones)	Min (Tens)	Min (Ones)	Sec (Tens)	Sec (Ones)	Frame (Tens)	Frame (Ones)
D9	3*	3*	3*	3*	3*	3*	3*	3*
E.g. (01:23:45)	30	31	32	33	34	35	30	30

E.g.: When time lapse counter is 1 hr 23 min 45 sec.

## JVC Status Sense

DD JVC SENSE	1byte		2byte		3byte		4byte	
	DV	HDD/DVD	DV	HDD/DVD	DV	HDD/DVD	DV	HDD/DVD
bit7	1 (Fixed)	1 (Fixed)	0 (Fixed)	0 (Fixed)	1 (Fixed)	1 (Fixed)	1 (Fixed)	1 (Fixed)
bit6	0 (Fixed)	0 (Fixed)	0 (Fixed)	0 (Fixed)	0 (Fixed)	0 (Fixed)	1 (Fixed)	1 (Fixed)
bit5	0 (Fixed)	0 (Fixed)	1 (Fixed)	1 (Fixed)	0 (Fixed)	0 (Fixed)	0 (Fixed)	0 (Fixed)
bit4	During Playback of LP Recorded Tape	0 (Fixed)	0 (Fixed)	0 (Fixed)	0 (Fixed)	0 (Fixed)	0 (Fixed)	0 (Fixed)
bit3	0 (Fixed)	0 (Fixed)	0 (Fixed)	Refer to the DISC TYPE table below.	0 (Fixed)	0 (Fixed)	During dubbing (Including PAUSE)	During dubbing (Including PAUSE)
bit2	0 (Fixed)	0 (Fixed)	0 (Fixed)		During Audio Dub (Including PAUSE)	0 (Fixed)	0 (Fixed)	0 (Fixed)
bit1	0 (Fixed)	0 (Fixed)	1 (Fixed)		During Insert (Including PAUSE)	0 (Fixed)	0 (Fixed)	0 (Fixed)
bit0	1 (Fixed)	1 (Fixed)	0 (Fixed)		During dubbing (Including PAUSE)	During dubbing (Including PAUSE)	0 (Fixed)	0 (Fixed)

## DISC TYPE

	bit3	bit2	bit1	bit0
DVD	0	0	0	0
DVD-RAM	0	0	0	1
DVD-R	0	0	1	0
DVD-RW	0	0	1	1
DVD+R	0	0	0	0
DVD+RW	0	0	0	0
VCD	0	1	1	0
CD	0	1	1	1
...	...	...	...	...
No disc	1	1	1	1

**GENERAL****Power requirement**AC 220 V - 240 V $\sim$ , 50 Hz/60 Hz**Power consumption**

Power on: 42 W

Power off: 5 W

**Laser specification**

For CD

Wavelength: 770 to 810 nm

Output: 0.4 mW

For DVD

Wavelength: 653 to 663 nm

Output: 1.0 mW

**Temperature**

Operating: 5°C to 35°C

Storage: -20°C to 60°C

**Operating position**

Horizontal only

**Dimensions (WxHxD)**

435 mm x 96 mm x 372 mm

**Weight**

5.8 kg

**Input/Output**Video input: 0.5 - 2.0 V<sub>p-p</sub>, 75  $\Omega$  (pin jack)Video output: 1 V<sub>p-p</sub>, 75  $\Omega$  (BNC)

Audio input:

-8 dB, 50 k $\Omega$  (pin jack)

Corresponding to mono (left)

Audio output: -8 dB, 1 k $\Omega$  (pin jack)

S-video input:

Y: 0.8 - 1.2 V<sub>p-p</sub>, 75  $\Omega$ C: 0.2 - 0.4 V<sub>p-p</sub>, 75  $\Omega$ 

S-video output:

Y: 1.0 V<sub>p-p</sub>, 75  $\Omega$ C: 0.3 V<sub>p-p</sub>, 75  $\Omega$ 

DV: 4-pin for DV IN/OUT

Remote Input:  $\varnothing$ 3.5 mm Jack

Serial Command: D-SUB 9-PIN

Component video output:

Y: 1.0 V<sub>p-p</sub>, 75  $\Omega$ C<sub>B</sub>/C<sub>R</sub>, P<sub>B</sub>/P<sub>R</sub>: 0.7 V<sub>p-p</sub>, 75  $\Omega$ 

Corresponding to copy protection

Digital audio output:

Optical, Coaxial

Corresponding to Dolby Digital and DTS Digital Surround

Bit stream

Selectable in digital audio output setting menu

**VIDEO/AUDIO (DVD Deck)****Recording time**

Maximum 8 hours (with 4.7 GB disc)

(XP): Approx. 1 hour

(SP): Approx. 2 hours

(LP): Approx. 4 hours

(EP): Approx. 6 hours

(FR): Approx. 1 hour - 8 hours

**Audio recording system**

Dolby Digital (2 ch)

Linear PCM (XP mode only)

**Video recording compression system**

MPEG2 (CBR/VBR)

**VIDEO/AUDIO (HDD Deck)****Video recording compression system**

MPEG2 (VBR)

**Audio recording system**

Dolby Digital (2 ch)

Linear PCM (DV/XP mode)

**Recording time**

Maximum 473 hours (with 250 GB HDD)

(DV): Approx. 18 hours

(XP): Approx. 53 hours

(SP): Approx. 109 hours

(LP): Approx. 218 hours

(EP): Approx. 328 hours

(FR): Approx. 473 hours

**VIDEO/AUDIO (DV Deck)****Signal system**

PAL colour signal, 625 lines/50 fields

**Recording system**

Digital Component Recording

**Format**

DV format (SD mode)

**Cassette**

Mini DV Cassette

**Maximum recording time**

(SP): 80 min. with M-DV80ME cassette

(LP): 120 min. with M-DV80ME cassette

**Audio recording system**

PCM 48 kHz, 16 bit (2 ch)/

32 kHz, 12 bit (4 ch)

Specifications shown are for SP mode unless otherwise specified.

**ACCESSORIES****Provided accessories**

Audio/Video cable,

Infrared remote control unit,

"R6" battery x 2

E.&amp; O.E. Design and specifications subject to change without notice.

**ATTENTION:**

This unit contains microcomputers. External electronic noise or interference could cause malfunctioning. In such cases, switch the unit off and unplug the mains power cord. Then plug it in again and turn the unit on. Take out the disc. After checking the disc, operate the unit as usual.

<b>A</b>		<b>P</b>	
A-B Repeat Playback .....	26	Pan&Scan .....	19
Accidental erasure prevention .....	31	Play List Editing .....	40
Adjusting The Picture Quality .....	27	Playback Control (PBC) .....	24
Angle Selection .....	23	Programme Playback .....	28
Audio Channel Selection .....	24	Progressive scan .....	65
Audio Language/Sound Selection .....	24		
Auto Full Repeat Playback .....	61	<b>R</b>	
<b>B</b>		Random Playback .....	28
Basic Playback .....	20, 29, 31	Recordable/Playable Discs .....	5
<b>D</b>		Recording Medium And Format .....	7
Disc menu .....	21	Recording Mode .....	49
Disc Resume .....	58	Region Number .....	6
Discs For Playback Only .....	6	Register Disc .....	42
DV Native Format Recording to HDD .....	46	Repeat Playback .....	25
DVCAM .....	31	Resume Function .....	22
DVD menu .....	21	Resuming Playback .....	35
<b>F</b>		RetroActive Recording .....	35
File Structure Of Discs .....	7	RS-232C Interface .....	11, 70
Free Rate Function .....	49	<b>S</b>	
<b>I</b>		Select The Switching Interval Of The Slide Show .....	28
Instant Replay .....	22, 30, 32, 35	Setting The Progressive Mode .....	28
Interlaced scan .....	65	Simulated Surround Effect .....	27
<b>J</b>		Simultaneous Recording and Playback .....	35
Jump Search .....	22, 30	Skip Search .....	22, 29, 32
<b>L</b>		Slow Motion .....	21, 29, 32
Language Code List .....	69	Soundtrack Selection .....	32
Last Function Memory .....	65	Still Picture/Frame-By-Frame Playback .....	21, 29, 32
Letter Box .....	19	Subtitle Selection .....	24
Live Memory Playback .....	33	<b>T</b>	
<b>M</b>		Temporary Recording .....	35
Marking Positions To Play Back Again Later .....	23, 30	Time Code .....	32
Menu/Audio/Subtitle Language Set .....	18	Time Search .....	27
Mode Lock .....	65	Top menu .....	21
<b>N</b>		Tray Lock .....	65
Next Function Memory .....	32	<b>U</b>	
<b>O</b>		Unplayable Discs .....	6
On-screen Bar .....	25	Usable cassettes .....	31
On-screen Language Set .....	18	User-Customisable Background And Text Colour .....	63
		<b>V</b>	
		Variable Speed Search .....	21, 29, 32



**EN**

SR-DVM700ER

---

**JVC**

## Free Manuals Download Website

<http://myh66.com>

<http://usermanuals.us>

<http://www.somanuals.com>

<http://www.4manuals.cc>

<http://www.manual-lib.com>

<http://www.404manual.com>

<http://www.luxmanual.com>

<http://aubethermostatmanual.com>

Golf course search by state

<http://golfingnear.com>

Email search by domain

<http://emailbydomain.com>

Auto manuals search

<http://auto.somanuals.com>

TV manuals search

<http://tv.somanuals.com>