

# JVC



## DVD PLAYER

# XV-501BK



## INSTRUCTIONS

Introduction	2
Preliminary knowledge	5
Getting started	15
Basic operations	25
DVD VIDEO operations	33
Setting and adjustment	49
Audio CD operations	61
Video CD operations	73
Additional information	89

### For Customer Use:

Enter below the Model No. and Serial No. which are located on the rear, bottom or side of the cabinet. Retain this information for future reference.

Model No. \_\_\_\_\_

Serial No. \_\_\_\_\_

LET0145-001B

[J]

## Warnings, Cautions and Others

### Mises en garde, précautions et indications diverses

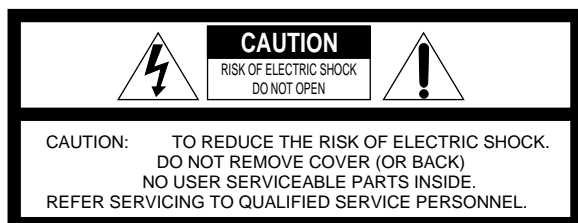

The lightning flash with arrowhead symbol, within an equilateral triangle is intended to alert the user to the presence of uninsulated "dangerous voltage" within the product's enclosure that may be of sufficient magnitude to constitute a risk of electric shock to persons.



The exclamation point within an equilateral triangle is intended to alert the user to the presence of important operating and maintenance (servicing) instructions in the literature accompanying the appliance.

#### For U.S.A.

This equipment has been tested and found to comply with the limits for a Class B digital device, pursuant to part 15 of the FCC Rules. These limits are designed to provide reasonable protection against harmful interference in a residential installation.

This equipment generates, uses and can radiate radio frequency energy and, if not installed and used in accordance with the instructions, may cause harmful interference to radio communications. However, there is no guarantee that interference will not occur in a particular installation. If this equipment does cause harmful interference to radio or television reception, which can be determined by turning the equipment off and on, the user is encouraged to try to correct the interference by one or more of the following measures:

- Reorient or relocate the receiving antenna.
- Increase the separation between the equipment and receiver.
- Connect the equipment into an outlet on a circuit different from that to which the receiver is connected.
- Consult the dealer or an experienced radio/TV technician for help.

**WARNING: TO REDUCE THE RISK OF FIRE OR ELECTRIC SHOCK, DO NOT EXPOSE THIS APPLIANCE TO RAIN OR MOISTURE.**

#### For Canada/pour le Canada

**CAUTION:** TO PREVENT ELECTRIC SHOCK, MATCH WIDE BLADE OF PLUG TO WIDE SLOT, FULLY INSERT

**ATTENTION:** POUR EVITER LES CHOCs ELECTRIQUES, INTRODUIRE LA LAME LA PLUS LARGE DE LA FICHE DANS LA BORNE CORRESPONDANTE DE LA PRISE ET POUSSER JUSQU'AU FOND

#### For Canada/pour le Canada

THIS DIGITAL APPARATUS DOES NOT EXCEED THE CLASS B LIMITS FOR RADIO NOISE EMISSIONS FROM DIGITAL APPARATUS AS SET OUT IN THE INTERFERENCE-CAUSING EQUIPMENT STANDARD ENTITLED "DIGITAL APPARATUS", ICES-003 OF THE DEPARTMENT OF COMMUNICATIONS.

CET APPAREIL NUMERIQUE RESPECTE LES LIMITES DE BRUITS RADIOELECTRIQUES APPLICABLES AUX APPAREILS NUMERIQUES DE CLASSE B PRESCRITES DANS LA NORME SUR LE MATERIEL BROUILLEUR: "APPAREILS NUMERIQUES", NMB-003 EDICTEE PAR LE MINISTRE DES COMMUNICATIONS.

#### CAUTION

To reduce the risk of electrical shocks, fire, etc.:

1. Do not remove screws, covers or cabinet.
2. Do not expose this appliance to rain or moisture.

#### ATTENTION

Afin d'éviter tout risque d'électrocution, d'incendie, etc.:

1. Ne pas enlever les vis ni les panneaux et ne pas ouvrir le coffret de l'appareil.
2. Ne pas exposer l'appareil à la pluie ni à l'humidité.

#### Caution — POWER switch!

Disconnect the mains plug to shut the power off completely. The POWER switch in any position does not disconnect the mains line. The power can be remote controlled.

#### Attention — Commutateur POWER!

Déconnecter la fiche de secteur pour couper complètement le courant. Le commutateur POWER ne coupe jamais complètement la ligne de secteur, quelle que soit sa position. Le courant peut être télécommandé.

### IMPORTANT FOR LASER PRODUCTS IMPORTANT POUR LES PRODUITS LASER

#### REPRODUCTION OF LABELS REPRODUCTION DES ETIQUETTES

WARNING LABEL, PLACED INSIDE THE UNIT  
ETIQUETTE D'AVERTISSEMENT PLACÉE À L'INTERIEUR DE L'APPAREIL

CAUTION	- LASER RADIATION WHEN OPEN. DO NOT STARE INTO BEAM.
ATTENTION	- RAYONNEMENT LASER EN CAS D'OUVERTURE. NE PAS REGARDER DANS LE FAISCEAU.
VORSICHT	- LASERSTRAHLUNG, WENN ABDECKUNG GEÖFFNET. NICHT IN DEN STRAHL BLICKEN.
ADVARSEL	- LASERSTRÅLING VED ÅBNING. SE IKKE IND I STRÅLEN.
ADVARSEL	- LASERSTRÅLING NÅR DEKSEL ÅPNES. STIR IKKE INN I STRÅLEN.
VARNING	- LASERSTRÅLNING NÅR DENNA DEL ÄR ÖPPNAD. STRÅR EJ IN I STRÅLEN.
VARO!	- AVATTAESSA OLET ALTTIINA LASERSÄTELYLLE. ÄLÄ TUJOTA SÄTEESSEEN.
注意	- 当打开这里会出现激光， 请不要直视激光。
注意	- ここを開くとレーザー光が出ます。 レーザー光をのぞき込まないでください。

1. CLASS 1 LASER PRODUCT
2. **DANGER:** Visible laser radiation when open and interlock failed or defeated. Avoid direct exposure to beam.
3. **CAUTION:** Do not open the top cover. There are no user serviceable parts inside the Unit; leave all servicing to qualified service personnel.
  1. PRODUIT LASER CLASSE 1
  2. **ATTENTION:** Radiation laser visible quand l'appareil est ouvert ou que le verrouillage est en panne ou désactivé. Eviter une exposition directe au rayon.
  3. **ATTENTION:** Ne pas ouvrir le couvercle du dessus. Il n'y a aucune pièce utilisable à l'intérieur. Laisser à un personnel qualifié le soin de réparer votre appareil.

# Supplied accessories

- Audio/video cable (x 1)

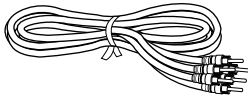

- S-video cable (x 1)



- AV compulink cord (x 1)

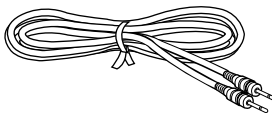

- Remote Control Unit (x 1)

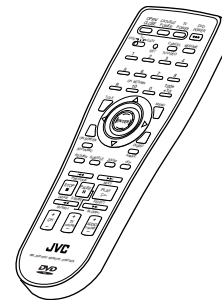

- R6P(SUM-3)/AA(15F) batteries (x 2)

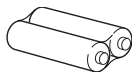

- Instructions (x 1)

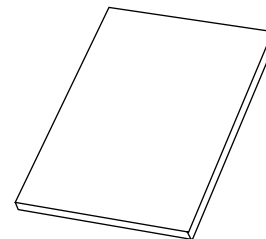

This product incorporates copyright protection technology that is protected by method claims of certain U.S. patents and other intellectual property rights owned by Macrovision Corporation and other rights owners. Use of this copyright protection technology must be authorized by Macrovision Corporation, and is intended for home and other limited viewing uses only unless otherwise authorized by Macrovision Corporation. Reverse engineering or disassembly is prohibited.

Manufactured under license from Dolby Laboratories. "Dolby" and double-D symbol are trademarks of Dolby Laboratories. Confidential Unpublished Works.

© 1992-1997 Dolby Laboratories, Inc. All rights reserved.

Manufactured under license from Digital Theater Systems, Inc. US Pat. No. 5,451,942 and other world-wide patents issued and pending. "DTS", "DTS Digital Surround", are trademarks of Digital Theater System, Inc.

© 1996 Digital Theater Systems, Inc. All Rights Reserved.

# Table of contents

## Introduction

Page 2

- Features**
- Using the instructions**
- Notes on care and handling**

## Preliminary Knowledge

Page 5

- Names of parts and controls**
  - Front panel ..... 6
  - Display window ..... 7
  - Rear panel ..... 7
  - Remote control unit ..... 8
- Display information**
  - On-screen displays ..... 10
  - To prevent the monitor from burning out – **SCREEN SAVER** ..... 12
  - On-screen guide icons ..... 12
- Preliminary knowledge about discs**
  - Playable disc types ..... 13
  - Disc construction ..... 14

## Getting started

Page 15

- Connections**
  - Before making any connections ..... 16
  - To connect to a TV, monitor, or projector with the audio input and video input jacks ..... 16
  - To connect to a TV, monitor, or projector with the component video input jacks ..... 17
  - To connect to an audio amplifier or receiver ..... 18
  - To connect to audio equipment with a digital input ..... 19
- Turn on the unit**
  - To connect the power cord ..... 20
  - To install batteries in the remote control unit ..... 21
  - To turn on/off the unit ..... 22
- Using the remote control unit**
  - To use the remote control unit for TV operation ..... 23
  - To use the remote control unit for CATV converter or satellite tuner operation .... 24

## Basic operations

Page 25

- Before operation**
  - To turn on your TV and the unit ..... 26
  - To select the source you want to operate ..... 26
- Inserting and removing discs**
  - To insert or remove discs ..... 27
- Playing back a DVD VIDEO or CD disc**
  - To playback a disc from the beginning ..... 28
  - To stop playback completely ..... 28
  - To stop playback temporarily ..... 29
  - To advance or reverse play rapidly while monitoring ..... 29
  - To locate the beginning of the scene or song ..... 29
- Resuming Playback**
  - To store the point where you want to resume playback from – **RESUME** ..... 30
  - To resume playback from the stored point – **RESUME** ..... 30
- Adjusting the surround sound**
  - To simulate the surround sound – **3D PHONIC** ..... 31
- Summary of basic operations** ..... 32

## DVD VIDEO operations

Page 33

Playing a specific scene on a DVD disc .....	34
Playing in slow-motion .....	40
Playing a scene close-up .....	41
Repeat playback .....	42
Viewing from multiple angles .....	44
Changing the language and sound .....	46
Adjusting the picture to suit the preferences .....	48

## Setting and adjustment

Page 49

Selecting preferences .....	50
Limiting playback by children .....	58

## Audio CD operations

Page 61

Playing a specific track on a disc .....	62
Changing the track order .....	65
Repeat playback .....	67
Sampling all tracks .....	69
Checking the elapsed time or remaining time .....	70
Information about CD TEXT .....	71

## Video CD operations

Page 73

Playing a specific scene on a Video CD .....	74
Playing in slow-motion .....	79
Playing a scene close-up .....	80
Changing the track order .....	81
Repeat playback .....	83
Sampling all tracks .....	85
Adjusting the picture and sound to suit preferences .....	86
Checking the total disc time .....	88

## Additional information

Page 89

Care and handling of discs .....	90
Troubleshooting .....	91
AV COMPU LINK remote control system .....	92
Specifications .....	94
Table of languages and their abbreviations .....	95

# Features

## Picture functions

- **Strobe function**  
The unit can display a list of still pictures on the TV screen.
- **Digest function**  
You can select the desired title from the opening scenes displayed on the TV screen.
- **Angle function\***  
You can enjoy variety of scene angles.
- **Zoom function**  
You can view scenes close-up.
- **VFP function**  
You can change the picture quality.
- **Parental lock\***  
When a movie which includes violent scenes is played back, the scenes are cut or replayed with other scenes so as not to be viewed by children.

## Compatible with a variety of sound formats

- **High quality digital sound**  
You can enjoy high quality sound with Dolby Digital, or Linear-PCM.
- **Surround function\***  
The unit is compatible with Dolby Digital Surround and DTS surround.
- **3D PHONIC function**  
You can enjoy surround sound with your 2 ch system.

## Other functions

- **Multi-language subtitles and sound\***  
You can select the subtitle or sound language.
- **Multi-disc player**  
You can also enjoy Audio CD discs and Video CD discs.
- **Operation from the on-screen display**  
You can operate the unit from the on-screen display.

Functions with (\*) mark only work on a DVD disc that is compatible with each function.

# Using the instructions

The instructions basically explain operations as follows:

The number indicates the procedural step.

The on-screen display displayed during the operation.

You can operate from the front panel.

You can operate with the remote control unit.

Short cuts:  
Procedures that you can shorten.

Hints:  
Other convenient procedures.

The buttons used in steps are shown as illustrations.

Note:  
Additional supplemental remarks







## Changing the language and sound

You can choose the sub-title or audio language from among the languages included on a disc and select the sound from a variety of sounds included on a disc.

**To select the subtitle language [SUBTITLE]**

■ During playback

- 1** Press  .  
The on-screen display appears on the TV screen.
- 2** Use  to move  to [SUBTITLE].
- 3** Use  to select the desired subtitle.

Each time you use , the subtitle changes.

Example:

1/3 ENGLISH

↓

2/3 FRENCH

↓

3/3 SPANISH

↓

-/3 (off)

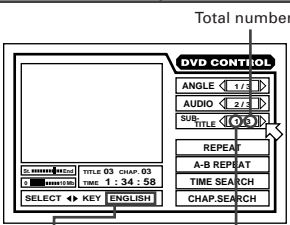

Total number

Selected subtitle number

Selected subtitle

**NOTE**

- When  appears on the TV screen:  
You cannot select the subtitle.

46

# Notes on care and handling

## Important cautions

### Installation of the unit

- Select a place which is level, dry and neither too hot nor too cold (between 5°C and 35°C, 41°F and 95°F).
- Leave sufficient distance between the unit and a TV.
- Do not use the player in a place subject to vibrations.

### Power cord

- Do not handle the power cord with wet hands!
- A small amount of power (2 watts) is always consumed while the power cord is connected to the wall outlet.
- When unplugging the player from the wall outlet, always pull the plug, not the power cord.

### To prevent malfunction of the unit

- There are no user serviceable parts inside. If anything goes wrong, unplug the power cord and consult your dealer.
- Do not insert any metallic object into the unit.
- Do not use any non-standard shaped disc available on the market, because it may damage the unit.
- Do not use a disc with tape, seals, or paste on it, because damage to the unit may result.

### Note about copyright laws

- Please check the copyright laws in your country to record from DVD VIDEO, Audio CD, Video CD discs. Recording of copyrighted material may infringe copyright laws.

### Note about the copyguard system

- The DVD VIDEO disc is protected by the copyguard system. When you connect the unit to your VCR directly, the copyguard system activates and the picture may not be played back correctly.

## Safety precautions

### Avoid moisture, water and dust

Do not place your player in moist or dusty places.

### Avoid high temperatures

Do not expose the unit to direct sunlight or place it near a heating device.

### When you're away

When away on travel or otherwise for an extended period of time, remove the plug from the wall outlet.

### Do not insert foreign objects into the unit

Do not insert wires, hairpins, coins, etc. into the unit.

### Do not block the vents

Blocking the vents may damage the unit.

### Care of the cabinet

When cleaning the unit, use a soft cloth and follow the relevant instructions on the use of chemically-coated cloths. Do not use benzene, thinner or other organic solvents and disinfectants. These may cause deformation or discoloring.

### If water gets inside the unit

Turn off the power switch and remove the plug from the wall outlet, then call the store where you made your purchase. Using the unit in this state may cause a fire or electrical shock.



# Preliminary knowledge

This chapter explains names of parts and controls of the unit and information about discs and displays. For successful operation, read this chapter before set-up and operation of the unit.

## Table of contents of this chapter

■ <b>Names of parts and controls</b>	
Front panel .....	6
Display window .....	7
Rear panel .....	7
Remote control unit .....	8
■ <b>Display information</b>	
On-screen displays .....	10
To prevent the monitor from burning out – <b>SCREEN SAVER</b> .....	12
On-screen guide icons .....	12
■ <b>Preliminary knowledge about discs</b>	
Playable disc types .....	13
Disc terms .....	14

# Names of parts and controls

Refer to the corresponding pages indicated in ( ) for details.

## Front panel

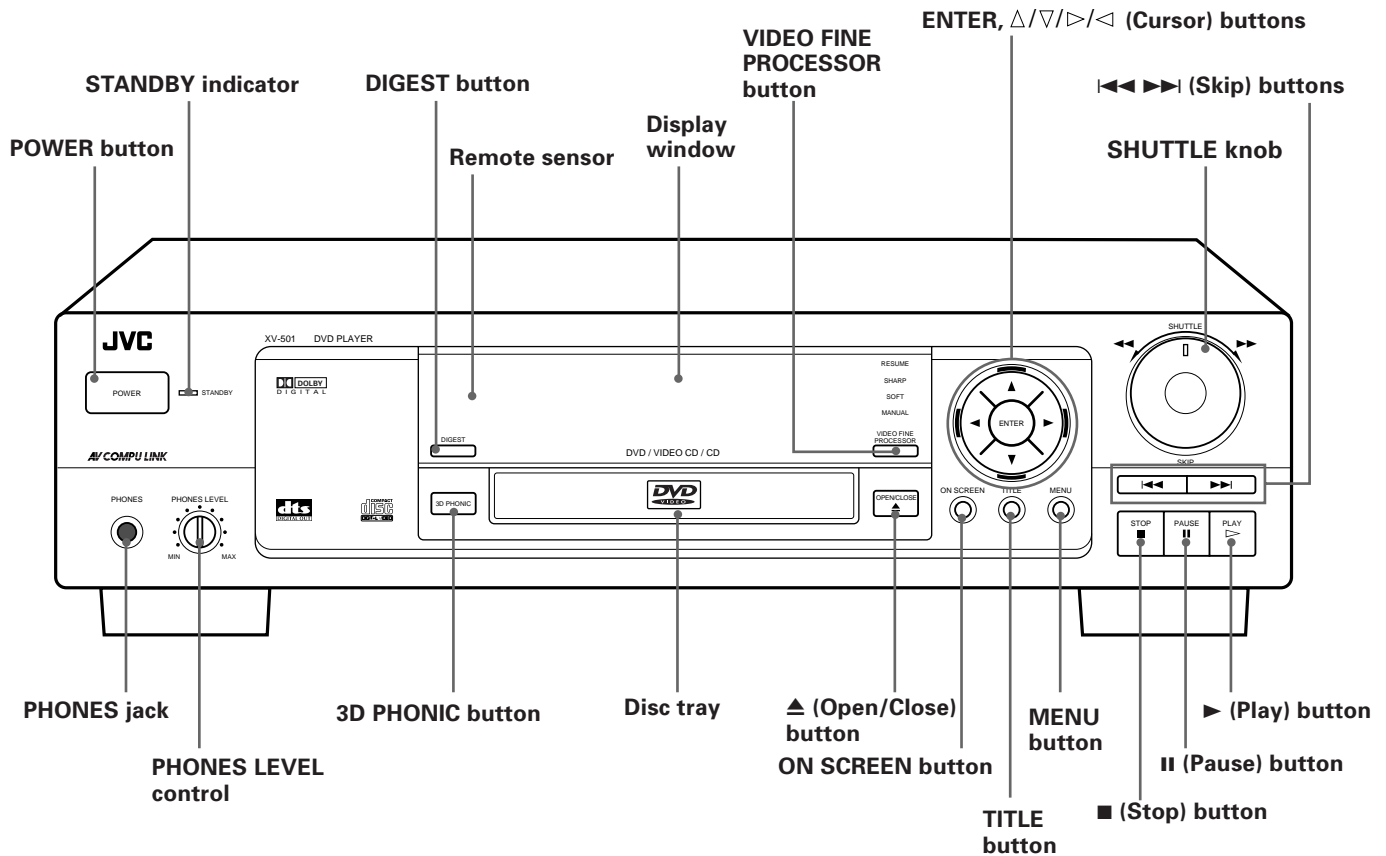

### 3D PHONIC button (31)

Get a simulated surround effect.

### Disc tray (27)

Used to load discs.

### Display window

Indicates the current status of the unit.

### DIGEST button (39, 78)

Display beginning scenes of each title, chapter, or track on the TV screen.

### ENTER button

Executes a selected item in a menu or on-screen display.

### MENU button (34)

Displays a menu of DVD on the TV screen or monitor.

### ON SCREEN button (10)

Displays an on-screen display of the unit on the TV screen or monitor.

### PHONES jack

Connection jack for headphones.

### PHONES LEVEL control

Adjusts the volume level of headphones connected to the PHONES jack.

### POWER button (22)

Turns the unit on or off (standby).

### Remote sensor

Receives the signal from the remote control unit.

### SHUTTLE knob (29, 40, 79)

Performs fast forward/backward and slow motion playback.

### STANDBY indicator

Lights when the power cord is connected and the unit is on standby. When the unit is turned on, the STANDBY indicator goes off.

### TITLE button (34)

Displays a title menu of DVD on the TV screen or monitor.

### VIDEO FINE PROCESSOR button (48, 86)

Change the picture quality.

### $\Delta/\nabla/\triangleright/\triangleleft$ (Cursor) buttons

Selects an item in on-screen displays or menus.

### $\blacktriangle$ (Open/Close) button (27)

Opens and closes the disc tray.

### $\blacktriangleright$ (Play) button (28)

Starts playback. Also, used as a SELECT button for PBC of Video CDs.

### $\parallel$ (Pause) button (29)

Pauses during playback.

### $\blacktriangleleft\blacktriangleright$ (Skip) buttons (29, 62, 75)

Performs skip or previous/next.

### $\blacksquare$ (Stop) button (28)

Stops playback.

## Display window

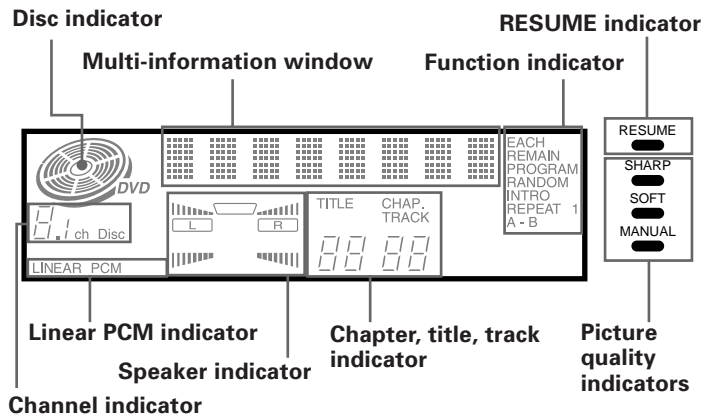

### Channel indicator

Displays number of channels in the currently selected audio playback format.

### Chapter, title, track indicator

Displays chapter, title, or track number.

### Disc indicator

Lights when a disc is in the unit. "DVD" also appears when a DVD disc is in the unit.

### Function indicator

Activated function indicators light up.

### Multi-information window

Displays time, text, and additional information.

### Picture quality indicators

Selected indicator of the picture quality lights up.

### RESUME indicator

Lights when a point to be resumed from is stored.

### Linear PCM indicator

Lights only when the playback disc contains linear PCM data.

### Speaker indicator

Lights during disc playback. When the 3D PHONIC function is ON, also lights.

## Rear panel

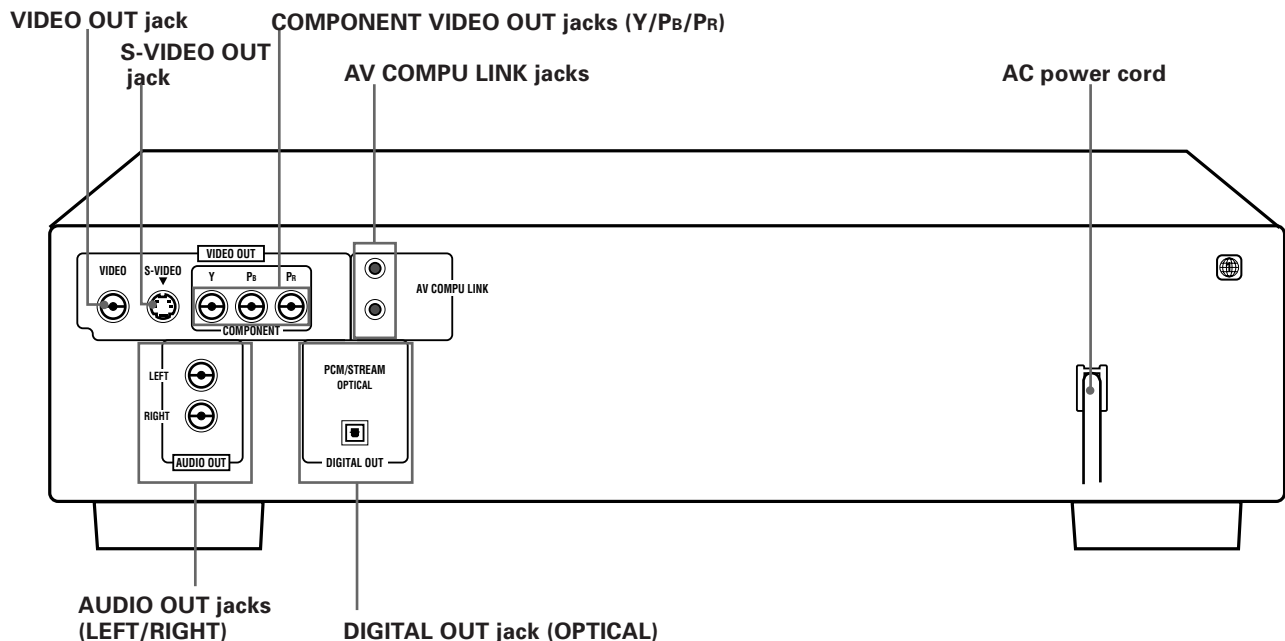

### AC power cord (20)

Connects to the wall outlet.

### AUDIO OUT jacks (LEFT/RIGHT) (16, 17, 18, 19)

Outputs stereo analog audio signals.

### AV COMPU LINK jacks (92)

Connects with other JVC equipment supporting the AV CompuLink function to facilitate integrated operations.

### COMPONENT VIDEO OUT jacks (Y/Pb/Pr) (17)

Outputs component video signals.

### DIGITAL OUT jack (OPTICAL) (19)

Outputs digital audio signals. Only an optical connector is provided.

### S-VIDEO OUT jack (16)

Outputs an S-video signal.

### VIDEO OUT jack (16)

Outputs a composite video signal.

## Remote control unit

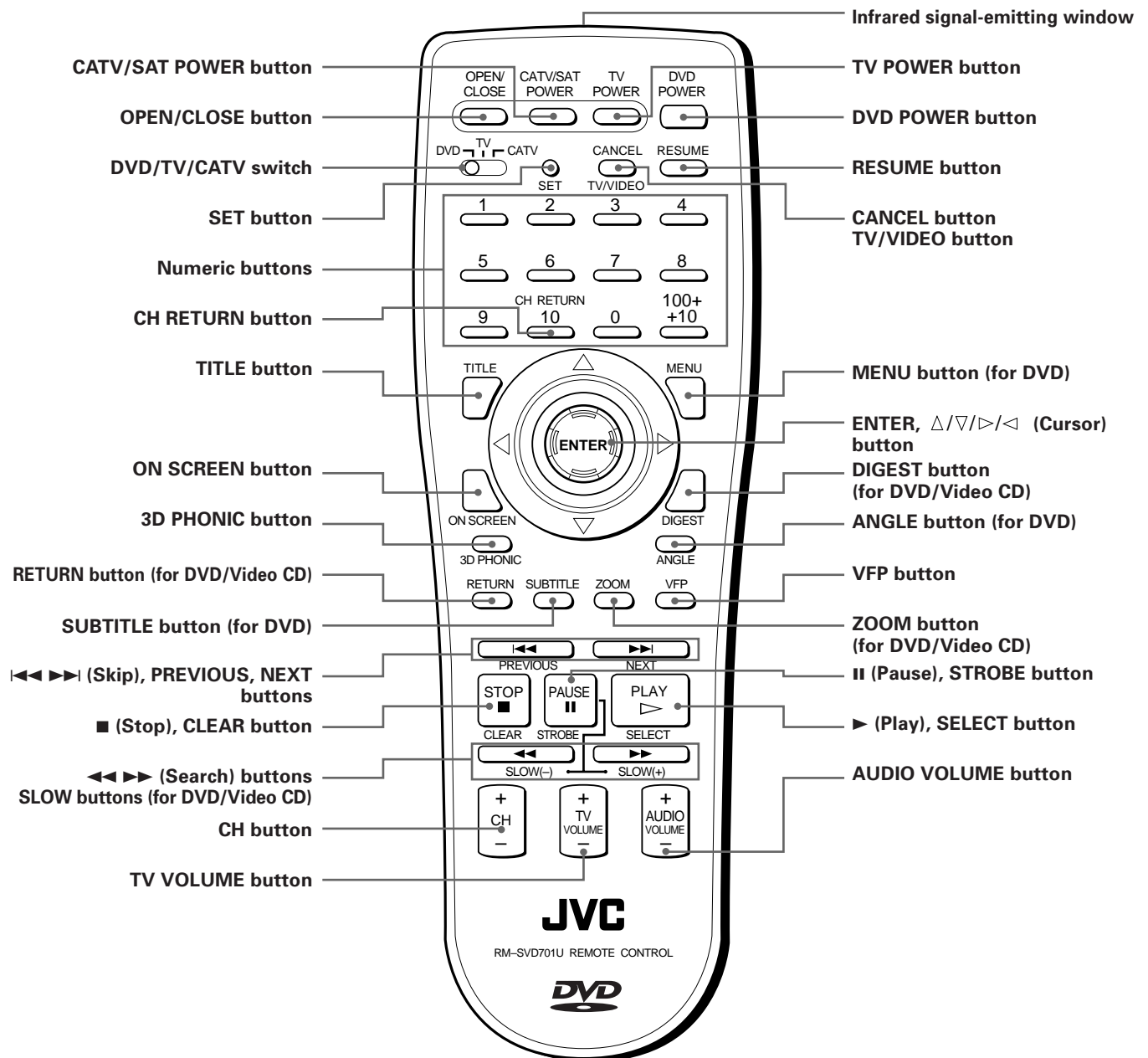

**3D PHONIC button (31)**

Produces a simulated surround effect.

**ANGLE button (for DVD) (44)**

Changes camera angles during playback of a DVD containing multiple camera angles.

**AUDIO VOLUME button (28)**

Adjusts the volume of a JVC AV amplifier or receiver.

**CANCEL button (65)**

Cancels the previous settings.

**CATV/SAT POWER button (24)**

Turns the CATV converter or satellite tuner on or off.

**CH button (23, 24)**

Changes the channels of TV or CATV converter/satellite tuner.

**CH RETURN button (23)**

Returns to the previous channel (only valid for JVC TVs).

**CLEAR button**

Clears the selected item.

**DIGEST button (for DVD/Video CD) (39, 78)**

Display beginning scenes of each title, chapter, or track on the TV screen.

**DVD/TV/CATV switch (23, 26)**

Selects the function of the numeric buttons to control the corresponding device.

**DVD POWER button (22)**

Turns the unit on or off (standby).

**ENTER,  $\Delta/\nabla/\triangleright/\triangleleft$  (Cursor) button**

Executes a selected item in a menu or on-screen display when pressing the button. Selects an item in the on-screen display or title menus or menus of DVD when tilting.

**Infrared signal-emitting window**

Point this window toward the remote sensor on the front panel when pressing buttons.

**MENU button (for DVD) (34)**

Displays a menu of DVD on the TV screen or monitor.

**NEXT button (for DVD/Video CD) (29)**

Performs "next" operation.

**Numeric buttons (32)**

Depending on the selection of the DVD/TV/CATV switch, they are used for entering a title, track or chapter number, or selecting a TV channel.

**ON SCREEN button (10)**

Displays an on-screen display of the player on the TV screen or monitor.

**OPEN/CLOSE button (27)**

Opens and closes the disc tray.

**PREVIOUS button (for DVD/Video CD) (29)**

Performs "previous" operation.

**RESUME button (30)**

Stores the location to resume playback from later.

**RETURN button (for DVD/Video CD)**

Returns to the previous menu.

**SELECT button (for Video CD)**

Selects the item.

**SET button (23)**

Used to set the manufacturer's code for operating another manufacturer's TV, CATV or satellite tuner from the remote control unit.

**SLOW button (for DVD/Video CD) (40, 79)**

Starts slow-motion playback.

**STROBE button (for DVD/Video CD) (40)**

Displays 9 still pictures on the TV screen.

**SUBTITLE button (for DVD) (46)**

Turns subtitles on or off.

**TITLE button (34)**

Displays a title menu of DVD on the TV screen or monitor. Switches the display in the display window (for Audio CD).

**TV/VIDEO button**

Switches input of the TV (either TV or VIDEO).

**TV VOLUME button (23, 28)**

Adjusts the TV volume.

**TV POWER button (23)**

Turns the TV on or off.

**VFP button (48, 86)**

Changes the picture quality.

**ZOOM button (for DVD/Video CD) (41, 80)**

Scene in a close-up view.

**II (Pause) button (29)**

Pauses during playback.

**▶ (Play) button (28)**

Starts playback.

**◀◀▶▶ (Search) buttons (29)**

Performs fast forward/backward playback operations.

**◀◀▶▶ (Skip) buttons (29, 62)**

Performs skipping.

**■ (Stop) button (28)**

Stops playback.











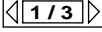

# Display information

The unit provides several on-screen displays and on-screen guide icons to help you operate the unit.

## On-screen displays

The unit provides several on-screen displays as shown below for choosing preferences for initial settings and functions which are not frequently used.

### Basic operations in on-screen display

- With an item like , you can change the setting by placing  on .
-  - type item works when you place  on the item and press .
- In the message box,  indicates the operation to be done.
- Numbers are entered using  to , .
- Some functions become effective by pressing  after specifying necessary entries.
- Pressing  again exits the on-screen display.



### Opening display

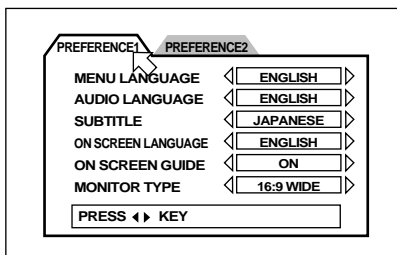

Appears when the unit turns on.



### Preference displays (see page 50)

You can set preferences on these display.

#### To display the Preference display

- 1 Press  to stop the unit.  
If the current disc is not a DVD disc, you have to remove the disc from the tray.
- 2 Press .

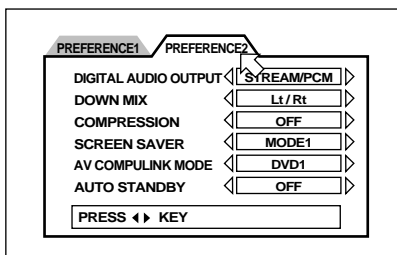

### Parental Lock on-screen display (see page 58)

You can set the parental lock from this display.

#### To display the Parental Lock on-screen display

Press  while holding down .

The Parental Lock on-screen display appears on the TV screen.

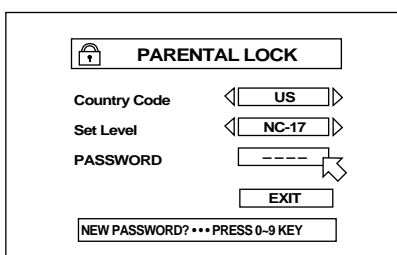

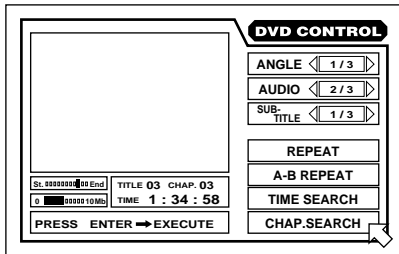

### The DVD on-screen display during playback

You can select and set various function for DVD playback from this display.

#### To display the DVD on-screen display

During DVD playback, press .

Current relative position the title  
(St: start, End: end).  
Current title number  
Current chapter number



Transmission rate  
Elapsed time from the beginning of the current title

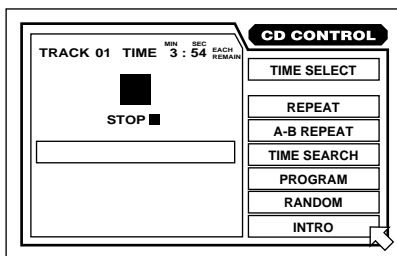

### The CD on-screen display

You can select and set various function for Audio CD or Video CD (during stop mode) playback from this display.

#### To display the CD on-screen display

Insert a CD disc and press .

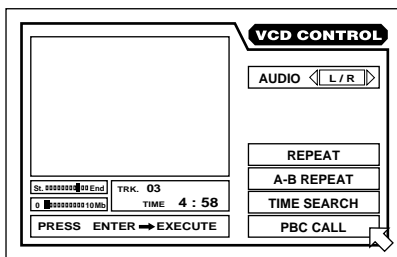

### The Video CD on-screen display during playback

You can select and set various function for Video CD playback on this display.

#### To display the Video CD on-screen display

During Video CD playback, press .

Current relative position of the track  
(St: start, End: end).  
Current track number



Transmission rate  
Elapsed time from the beginning of the current track

## To prevent the monitor from burning out [SCREEN SAVER]

A television monitor screen may be burned out if a static picture is displayed for a long time. To prevent this, the unit automatically activates the screen saver function if a static picture, such as an on-screen display or menu, is displayed for over 5 minutes.

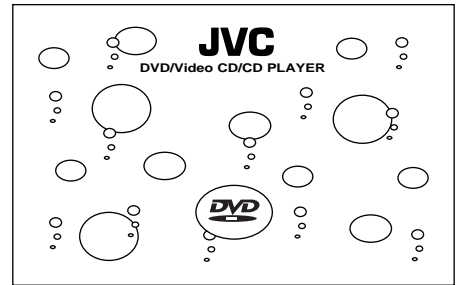

- Pressing any button on the unit or the remote control unit will release the screen saver function and return to the previous display.
- You can select one of several screen saver pictures available (see page 56).

## On-screen guide icons

During DVD playback, you may see icons displayed over the picture. These have the following meanings.



: Displayed at the beginning of a scene recorded from multiple angles. (See page 44.)





: Displayed at the beginning of a scene recorded with multiple audio languages. (See page 47.)



: Displayed at the beginning of a scene recorded with multiple subtitle language. (See page 46.)

You can set the unit not to display on-screen icons above via the preference settings described on page 53.

### About invalid operation icon

When you press a button, if the unit does not accept its operation,  appears on your television screen. Operations are occasionally unacceptable even if  is not displayed.





Note that some operations may not be accepted. For example, some discs may not allow fast forward, fast backward or slow-motion playback.



# Preliminary knowledge about discs

## Playable disc types

Playable and non-playback disc types are as follows:

Playable discs	Non-playable discs
DVD VIDEO 	DVD-ROM
Video CD  	DVD-RAM
	DVD Audio
Audio CD 	DVD-R
	DVD-RW
	CD-G
	CD-R
	CD-ROM
	PHOTO CD
	CD-RW
	CD-EXTRA

### Notes on DVD VIDEO discs

- DVD players and DVD discs have their own Region Code numbers. This player only can play back DVD discs whose Region Code numbers includes "1".  
Examples of playable DVD discs:



- This unit is designed to use the NTSC system. The unit cannot playback the disc recorded on the PAL system.
- Playing back discs listed as "Non-playable discs" in the table above may generate noise and damage speakers

## Disc construction

In general, a disc comprises of "units" which separate recorded audio and/or video materials.

In the case of a DVD disc, "titles" and "chapters" are the "units." a disc comprises "titles," and each title may be divided into some "chapters." Each title has an independent content, while each chapter in the same title has continuity. For example, if a disc contains some movies, each movie may have its own title number, and each movie may be divided into some chapters. In a karaoke disc, each song usually has its own title number and does not have chapters. In the case of an audio or video CD, "tracks" are the "units". Each song usually has a track number. Also, some track may be divided into "indexes". Each "unit" described above has a continuous number, which helps you to find the desired position in a disc.

(Example: DVD disc)

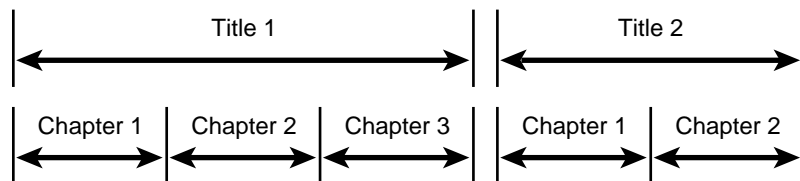

(Example: audio CD/video CD)

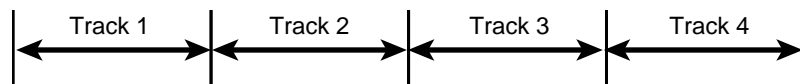

In the case of a video CD with PBC (Playback Control) function, there is another "unit" called "scene" in addition to "tracks". Each menu screen, motion or still picture is an independent scene. Each "scene" also has a continuous number

# Getting started

Before you can enjoy DVD VIDEO, Audio CD, and Video CD playback, you have to prepare the unit. This chapter explains how to get started, including connecting to a variety of components, turning on the unit, and using the remote control unit.

## Table of contents of this chapter

■ <b>Connections</b>	
Before making any connections .....	16
To connect to a TV, monitor, or projector with the audio input and video input jacks .....	16
To connect to a TV, monitor, or projector with the component video input jacks .....	17
To connect to an audio amplifier or receiver .....	18
To connect to audio equipment with a digital input .....	19
■ <b>Turn on the unit</b>	
To connect the power cord .....	20
To install batteries in the remote control unit .....	21
To turn on/off the unit .....	22
■ <b>Using the remote control unit</b>	
To use the remote control unit for TV operation .....	23
To use the remote control unit for CATV converter or satellite tuner operation .....	24

# Connections

Before using the unit, you have to connect the unit to a TV or amplifier. By connecting to an amplifier which has a digital terminal or Dolby digital capability, you can enhance the sound quality.

## Before making any connections

- **Do not connect the AC power cord until all other connections have been made.**
- Since different components often have different terminal names, carefully read the instructions supplied with the component you wish to connect.

## To connect to a TV, monitor, or projector with the audio input and video input jacks

You can enjoy using the unit by simply connecting it to a television set. To hear improved audio sound quality, connect the audio outputs to your audio equipment. (See the following pages.)

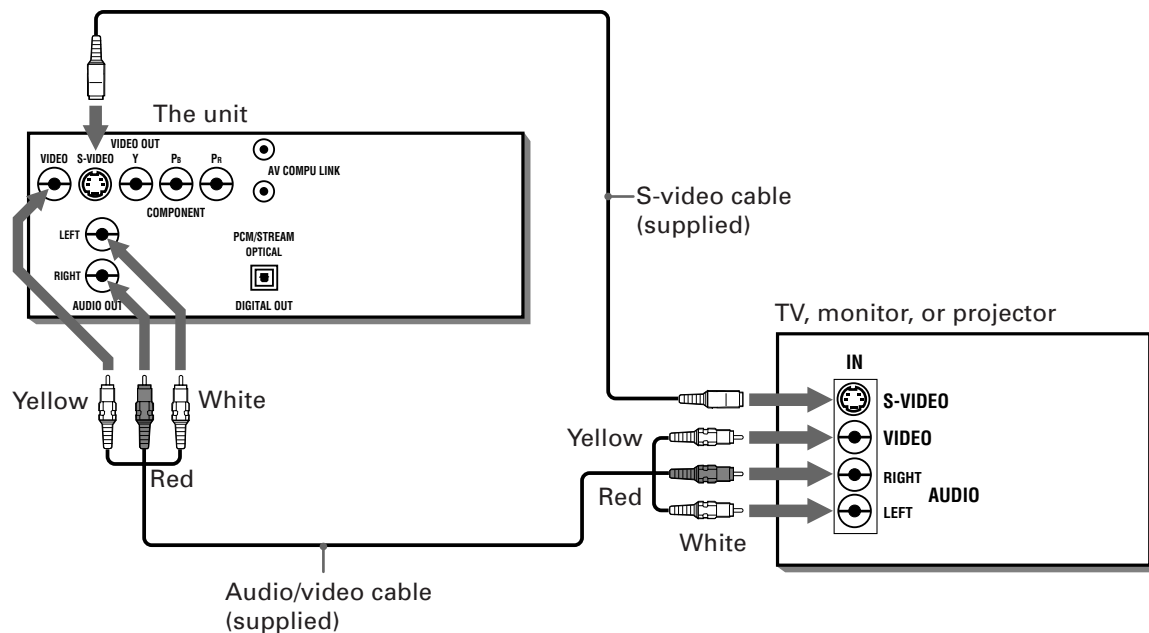

Connect the unit to a television set equipped with stereo audio input and video input jacks using the supplied audio/video cables.

- If your television set has a monaural audio input instead of stereo, you need to use an optional audio cable which converts stereo audio output to monaural.
- If your television set has an S-video input, you should to connect it with the S-VIDEO output of the unit using the supplied S-video cable in addition to the (standard) video connection to get better picture quality.

### NOTE

- **Connect VIDEO OUT of the unit to the video input of a television set. Connecting VIDEO OUT of the unit to a TV via a VCR may cause a monitor problem when playing back a copy-protected disc.**

## To connect to a TV, monitor, or projector with the component video input jacks

You can enjoy high picture quality by connecting the unit's COMPONENT VIDEO OUT jacks to the COMPONENT VIDEO IN jacks of your TV, monitor, or projector with the video cables.

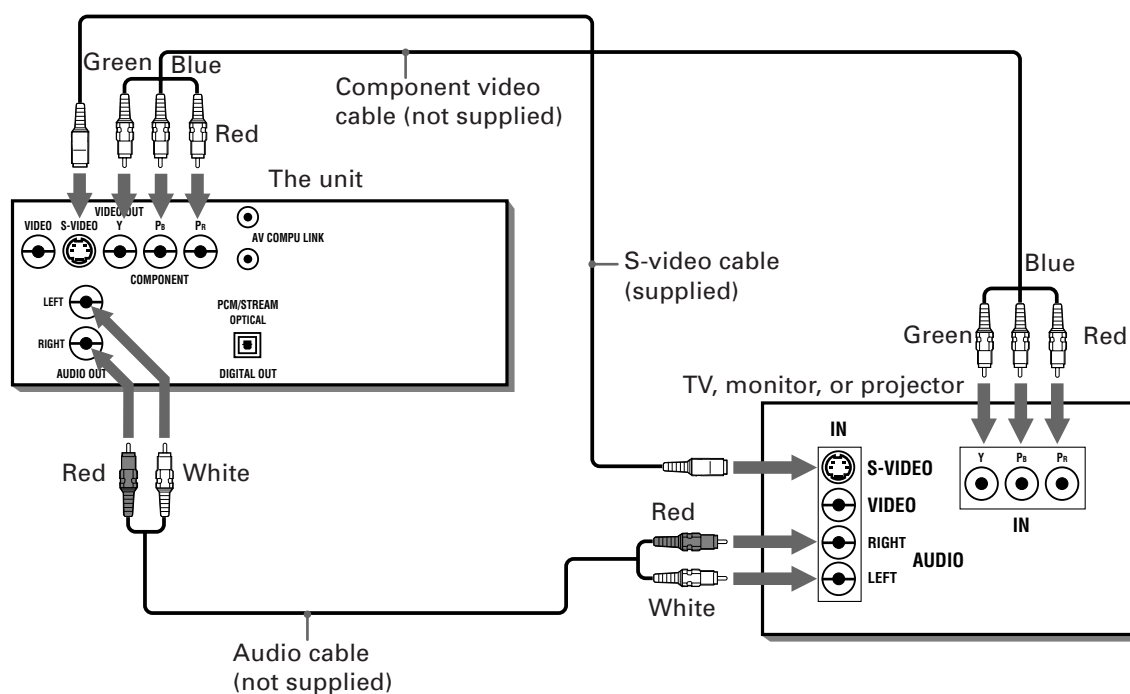

- Connect "Y" to "Y," "PB" to "PB," "PR" to "PR."

### NOTES

- When the component video input jacks of the other source is of the BNC type, use an adapter to convert a pin jack to a BNC jack (optional).
- If you do not connect the unit with the S-video cable, some functions of your TV may not work.

## To connect to an audio amplifier or receiver

### Connection to an audio amplifier or receiver

You can enjoy high-quality audio by connecting the unit's audio outputs to your amplifier or receiver.

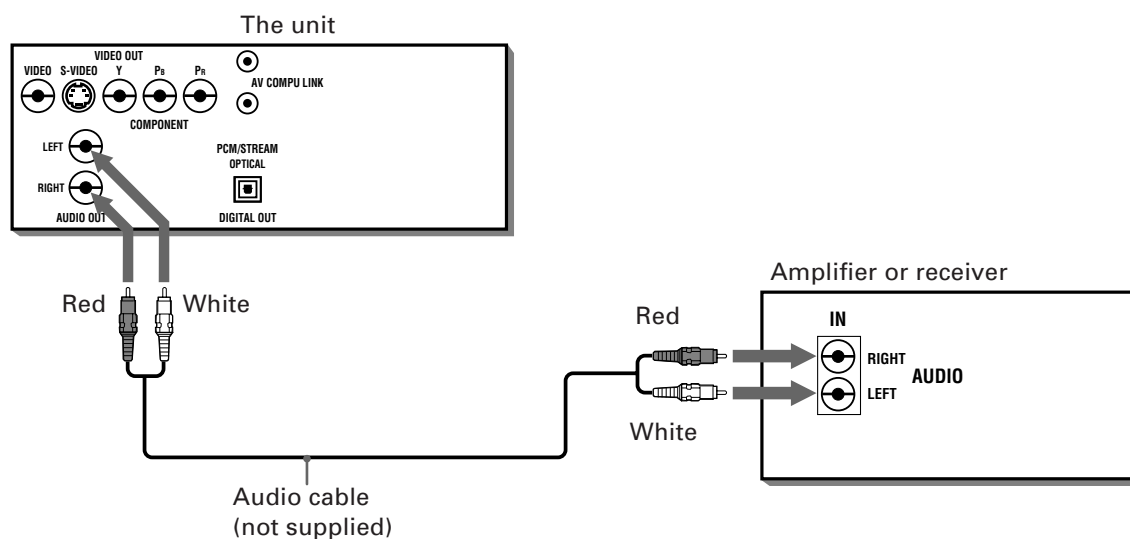

- Connect the unit's AUDIO OUT to any line-level inputs (such as AUX, DVD, CD, etc.) of an audio amplifier or receiver.

## To connect to audio equipment with a digital input

### Connection to an amplifier/receiver with digital input, Dolby Digital decoder/amplifier with built-in Dolby Digital decoder, or an amplifier with built-in DTS and Dolby Digital decoder

You can enhance the sound quality by connecting the unit's DIGITAL OUT (optical) with the digital input of an amplifier, DAT or MD by using a digital cable. The digital stereo audio signal from a disc is directly transferred. And, if you connect with a Dolby Digital decoder or an amplifier with built-in Dolby Digital decoder by using an optional digital cable, you can enjoy high-quality audio and surround sound. The unit also is compatible with the DTS function. When you make a digital connection, leave the 2 channel analog audio connection as it is. Otherwise, depending on the disc type, no audio may be reproduced.

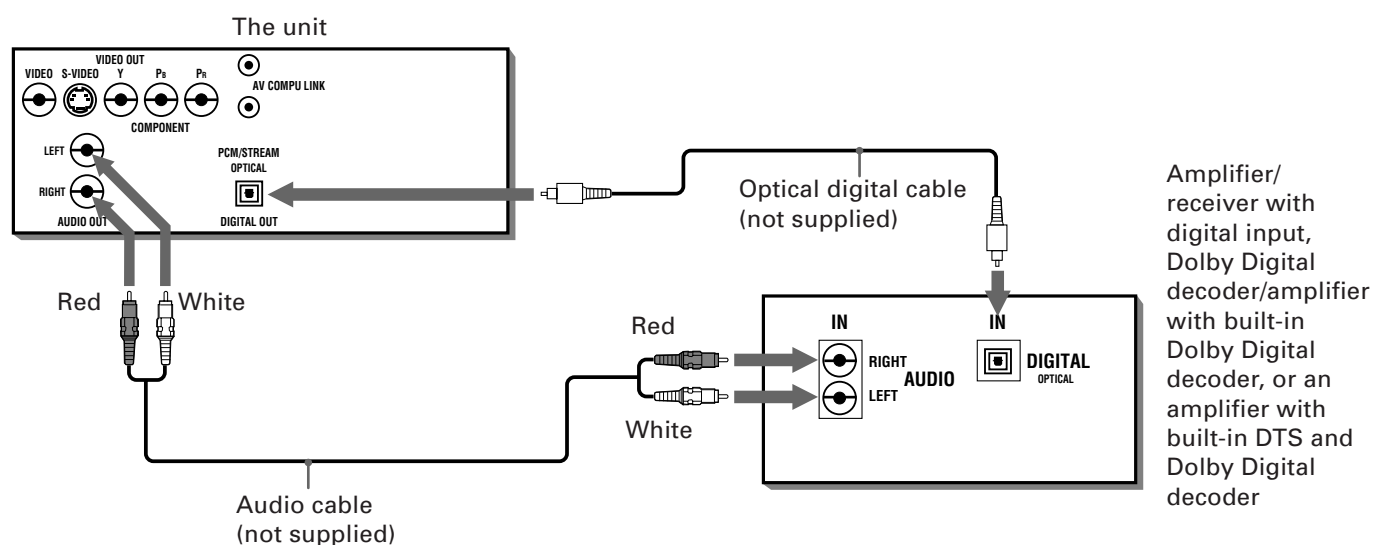

- For digital connection, connect the unit's DIGITAL OUT (optical) to the digital input of a Dolby Digital decoder or an amplifier with built-in Dolby Digital decoder using an optional digital cable.

#### NOTES

- When you connect the audio equipment with a digital input, before using, change the "DIGITAL AUDIO OUTPUT" setting in the "PREFERENCE 2" on-screen display according to the connected audio equipment with a digital input. When the "DIGITAL AUDIO OUTPUT" setting is not set correctly, loud noise may be played back from speakers, and it cause of the breakdown of your speakers. See "DIGITAL AUDIO OUTPUT" on page 54.
- With this connection, the unit's settings for COMPRESSION, and DOWN MIX are invalid. Settings for these items must be made from the decoder.

# Turn on the unit

---

## To connect the power cord

When all the connections have been made, insert the power plug into the wall outlet firmly. The STANDBY indicator lights and setup is completed.

### **Warning**

- Disconnect the power cord if you are not going to use the unit for a long time.
- Disconnect the power cord before cleaning the unit.
- Disconnect the power cord before moving the unit.
- Do not connect or disconnect the power cord with wet hands.
- Do not pull the power cord when disconnecting it, as this may damage the cord and cause fire, electric shock, or other accidents.

### **Caution**

- Do not damage, remodel, twist, or pull the power cord, as this may cause fire, electric shock, or other accidents.
- Contact a dealer and get a new power cord if the cord is damaged. A damaged cord may cause fire, electric shock, or other accidents.
- Do not put anything heavy or the unit on the power cord, as this may cause fire, electric shock, or other accidents.



## To install batteries in the remote control unit

The battery compartment is located on the back of the remote control unit.

- 1 Press down on the point shown by the arrow at the top of the compartment cover, and pull up the cover to open the compartment.

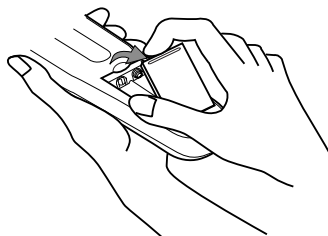

- 2 Place the two accessory R6P (SUM-3)/AA(15F) batteries in the remote control according to the polarity markings ("+" and "-") inside the compartment and on the batteries.

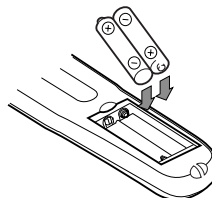

- 3 Place the cover over the compartment, and press down lightly.

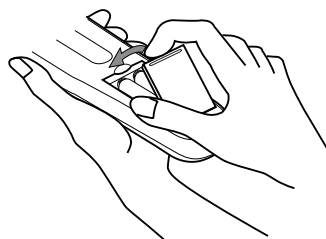

- The batteries will last about six months with normal use. If the functions of the remote control become erratic, replace the batteries. See "Precautions for the safe use of batteries" below for more information.

### Precautions for the safe use of batteries

Observe the following precautions for the safe use of batteries. If they are used improperly, their life will be shortened, they may burst or their contents may leak.

#### Precaution

- Remove the batteries from the remote control if it is not going to be used for a long period of time.
- Remove dead batteries and dispose of them properly.
- Never leave dead batteries lying around, take them apart, mix them with other refuse, or throw them into an incinerator.
- Never touch liquid that has leaked out of a battery.
- Do not mix new and old batteries, or batteries of different types, when replacing them.

## To turn on/off the unit

Press  on the front panel or press  on the remote control unit.

POWER

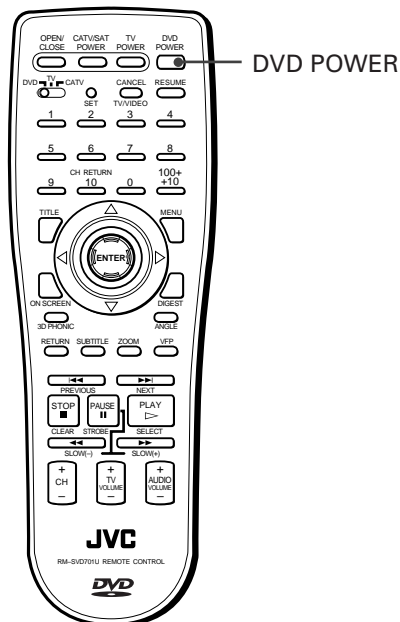
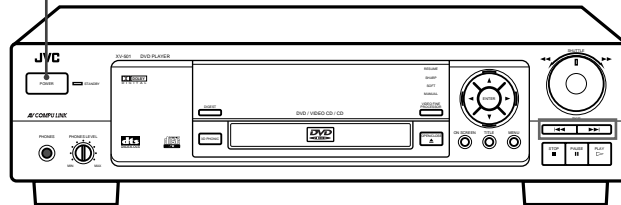

### NOTE

- Even if you press **POWER** to turn off the unit, the unit is not disconnected from the AC power source as long as it is connected to the wall outlet. This state is called the **standby mode**. In this state, the unit is designed to consume a very small quantity of power.









# Using the remote control unit

You can operate the unit with the remote control unit, and you can also operate your TV or other components with the remote control unit.

## To use the remote control unit for TV operation

You can operate a JVC TV with the remote control unit. To operate another manufacturer's TV, you have to change the remote control signal. Also refer to the manual supplied with your TV.







### Changing the remote control signal

- 1 Set  on the remote control unit to TV.
- 2 Press and hold , then press . Do not release . Keep holding  until the next step is completed.
- 3 Holding , enter the manufacturer's code (two digits) using  to . See the lists on the right to find the manufacturer's code.
- 4 Release .

The following buttons can be used for operating the TV (with  set to TV):

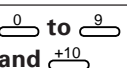
### Manufacturer code list

No.	Manufacturer
01	JVC
02	MAGNAVOX
03	mitsubishi
04	PANASONIC
05	RCA
06	SHARP
07	SONY
08	TOSHIBA
09	ZENITH
10	HITACHI
11	PANASONIC
12	SAMSUNG
13	SANYO
14	SANYO
15	SAMSUNG

	Turns the TV on or off.
	Changes the TV channels.
	Adjusts the TV volume.
	Selects the TV channels.  will function as the ENTER button if your TV requires pressing the ENTER button after selecting a channel number.
	You can switch input mode (either TV or VIDEO).
	Returns to the previous channel. (only valid for JVC TVs)

- 5 Try to operate your TV by pressing . If your TV turns on or off, you have entered the correct code.









### NOTE

- If there is more than one code listed for your brand of TV, try each one until the correct one is entered.



## To use the remote control unit for CATV converter or satellite tuner operation

You can operate the CATV converter or satellite tuner with the remote control unit. To operate them, you have to change the remote control signal. Also refer to the manual supplied with them.

### Changing the remote control signal

- 1 Set  on the remote control unit to CATV.
- 2 Press and hold , then press . Do not release . Keep holding  until the next step is completed.
- 3 Holding , enter the manufacturer's code (two digits) using  to . See the lists on the right to find the manufacturer's code.
- 4 Release .

The following buttons can be used for operating the CATV converter or satellite tuner (with  set to CATV):

	Turns the CATV converter or satellite tuner on or off.
	Changes the channels.
	Selects the TV channels.

- 5 Try to operate the CATV converter or satellite tuner by pressing . If the CATV converter or satellite tuner turns on or off, you have entered the correct code.

### Manufacturer's code list

No.	Manufacturer
01	GI JERROLD
02	GI JERROLD
03	GI JERROLD
04	GI JERROLD
05	GI JERROLD
06	GI JERROLD
07	GI JERROLD
08	GI JERROLD
09	SCIENTIFIC ATRANTA
10	SCIENTIFIC ATRANTA
11	ZENITH
12	ZENITH
13	PIONEER
14	PIONEER
15	HAMLIN/REGAL
16	HAMLIN/REGAL
17	HAMLIN/REGAL
18	HAMLIN/REGAL
19	OAK/SIGMA
20	OAK/SIGMA
21	OAK/SIGMA
22	TOCOM
23	TOCOM
24	RCA/PANASONIC
25	RCA/PANASONIC
26	RCA/PANASONIC
27	RCA(SAT)
28	SONY(SAT)

### NOTE

- If there is more than one code listed for your brand of the CATV converter or satellite tuner, try each one until the correct one is entered.

# Basic operations

This chapter explains how to perform basic common DVD, Audio CD and Video CD playback operations.  
 For more advanced operations, see page 33 for DVD operations, page 61 for Audio CD, page 73 for Video CD.

## Table of contents of this chapter

- **Before operation**
  - To turn on your TV and the unit ..... 26
  - To select the source you want to operate ..... 26
- **Inserting and removing discs**
  - To insert or remove discs ..... 27
- **Playing back a DVD VIDEO or CD disc**
  - To playback a disc from the beginning ..... 28
  - To stop playback completely ..... 28
  - To stop playback temporarily ..... 29
  - To advance or reverse play rapidly while monitoring ..... 29
  - To locate the beginning of the scene or song ..... 29
- **Resuming Playback**
  - To store the point where you want to resume playback from – **RESUME** ..... 30
  - To resume playback from the stored point – **RESUME** ..... 30
- **Adjusting the surround sound**
  - To simulate the surround sound – **3D PHONIC** ..... 31
- **Summary of basic operations** ..... 32

Introduction

Preliminary knowledge

Getting started

Basic operations

DVD VIDEO operations

Setting and adjustment

Audio CD operations

Video CD operations

Additional information

# Before operation



## To turn on your TV and the unit

To operate your TV from the remote control unit, you have to set the remote control unit to operate your TV (see page 23).

**1** Press  to turn on your TV.

**2** Press  to turn on the unit.



## To select the source you want to operate

You can operate the unit with the remote control unit and operate some functions of your TV or the CATV unit.



You can adjust the volume level, select the TV channel, and change the input source of your TV from the remote control unit.

- To operate the unit, set  on the remote control unit to DVD.

To operate the unit, point the remote control unit at the remote sensor of the unit.

- To operate the TV, set  on the remote control unit to TV.

To operate the TV, point the remote control unit at the remote sensor of the TV.

- To operate the CATV unit, set  on the remote control unit to CATV.

To operate the CATV unit, point the remote control unit at the remote sensor of CATV unit.

# Inserting and removing discs



## To insert or remove discs

**1** Press  to open the disc tray.



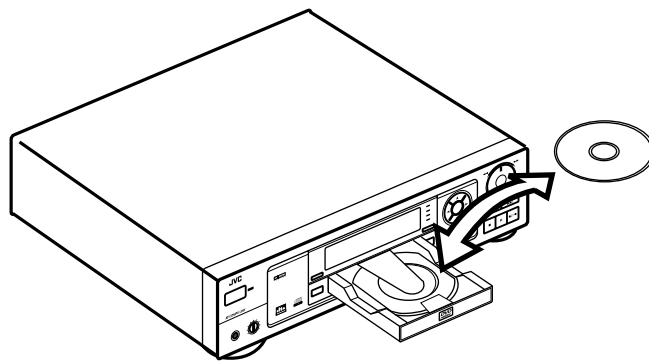





**2** Place the disc in the tray.



**3** Press  to close the disc tray.

### Hints

You can also insert and remove the disc from the on-screen display.

1. Use  to move  to , then press  to open the disc tray.
2. Place or remove the disc.
3. Use  to move  to , then press  to close the disc tray.

### Information about the opening display

When you insert a DVD VIDEO disc



When you insert an Audio CD disc

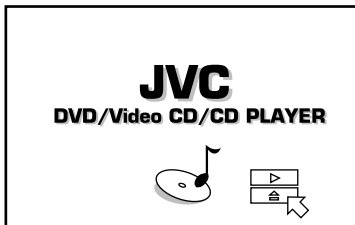

When you insert a Video CD disc

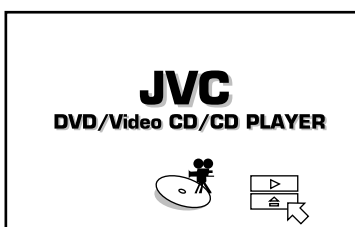

### NOTES

- The unit can playback DVD VIDEO, Audio CD, and Video CD discs only. Do not load other disc types. For details, see page 13.
- When loading a disc in the tray, be sure to position the disc inside the recess. Otherwise, the disc may be damaged when the tray is closed, and the disc may not be removed from the unit.

# Playing back a DVD VIDEO or CD disc

Now, you can play a DVD VIDEO or a CD disc. First, let's enjoy simple playback according to following procedure.



## To playback a disc from the beginning

### Short cuts

Press .

The unit starts playback from the beginning.



When you play a Video CD disc with PBC function or DVD disc, the menu display may appear on the TV screen. In this case, you can operate some functions such as playback from the selected one by viewing the menu displayed on the TV screen.

For the operation using the menu of DVD, see page 34.

For the operation using the menu of Video CD, see page 74.

1 Use to move to , then press .



■ The unit starts playback from the beginning.

### To adjusting the volume level

#### • For TV

Press to increase the volume, and to decrease the volume.

#### • For JVC amplifier

Press to increase the volume, and to decrease the volume.

#### • For other amplifier or receiver

Adjust the volume level of the connected amplifier or receiver. See the instructions of the amplifier or receiver.

#### • For headphones

To increase the volume, turn to the right. To decrease the volume, turn to the left.



## To stop playback completely

1 Press .

■ The unit stops playback.





## To stop playback temporarily

1 Press .

- The unit pauses playback. To continue playback, press .



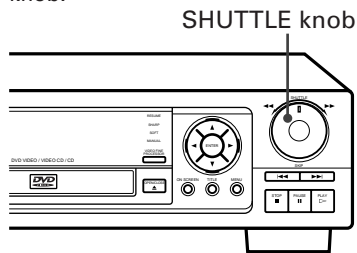

You can also advance or reverse play rapidly with the SHUTTLE knob on the front panel. To advance play rapidly, turn the shuttle knob to the right and hold, and to reverse play rapidly, turn the shuttle knob to the left and hold. When you release the shuttle knob, the unit returns to normal playback. The playback speed changes according to the amount you turn the shuttle knob.



## To advance or reverse play rapidly while monitoring

- During playback

1 Press  or .



Press  to advance playback rapidly, and  to reverse playback rapidly. Each time you press the button, advance playback or reverse playback speed increases. To return to the normal playback, press .



## To locate the beginning of the scene or song

- During playback

1 Press  or .

Press  to locate the beginning of the current chapter, title, or track, and press  to locate the beginning of the next chapter, title, or track.

The unit locates the beginning of the track when you play a Video CD disc without the PBC function or Audio CD disc. When you play a video CD disc with the PBC function or DVD VIDEO disc, the unit may locate anywhere, but mostly it locates on the beginning of the title or chapter or track.

# Resuming playback

The unit stores the position on a disc you want to interrupt playback at, and resumes playback from that position later.



## To store the point where you want to resume playback from [RESUME]



- During playback

1 Press .

The unit stores the current playback position of the disc, and the RESUME indicator on the front panel lights.

The last stored memory overrides the previous memory.



You can store the position on a disc you want to interrupt playback at by pressing  instead of .



## To resume playback from the stored point [RESUME]

- During stop mode

1 Press .

The unit starts playback from the stored position.



The unit also starts resume playback by pressing  during standby mode.

### NOTES

- **When you resume playback during playback of a Video CD disc with PBC function, the unit may resume playback from a point slightly earlier than the point you stored.**
- **To clear the memory**  
Take out the disc from the unit.

# Adjusting the surround sound

You can select the simulated surround effect depending on the disc contents. If you connect the unit to your stereo system, you can enhance sound quality and produce a greater surround effect.



## To simulate the surround sound [3D PHONIC]

■ During playback

1 Press .

2 Within 10 seconds, select the desired effect mode by pressing .

Each time you press , the effect mode changes as follows:

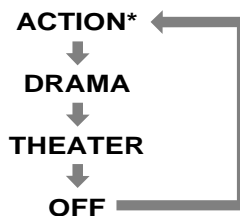

Selected effect mode

\* When you play the DVD disc recorded in Dolby Digital and contains more than 3 channel sound, ACTION does not appear.

3 Press to adjust the effect level.



Effect level

### Hints









To erase the 3D PHONIC screen, press . The 3D PHONIC screen disappears if there are no operations for more than 10 seconds.





### NOTES

- The sound effect (3D PHONIC) is possible only on discs which are recorded in DOLBY SURROUND or DOLBY DIGITAL. However, some DOLBY SU<sup>TM</sup>RRROUND or DOLBY DIGITAL discs do not contain the rear sound signal, in this case, the setting can be changed but the sound effect cannot be obtained.
- You can change the setting of the discs which do not contain the rear sound signal, but the sound effect cannot be obtained.
- The sound effect is not possible, and will not work even if set when the unit outputs the DTS or Dolby Digital bitstream signal from the DIGITAL OUT jack.
- The sound effect will not be set or operate, even if is pressed, on the sound of DVD discs recorded in Linear PCM.
- When you set the 3D PHONIC function to on, the DOWN MIX and COMPRESSION setting in the PREFERENCE display are disabled.

# Summary of basic operations

The basic operation and buttons for basic operation are shown in table below:

To	Press
Turn on/off the unit	DVD POWER 
Play	PLAY 
Stop	STOP 
Pause	PAUSE 
Advance or reverse play rapidly while monitoring	 /  or turn the shuttle knob and hold.
Locate the beginning of the scene or song	 /  until it clicks.

To	Press
Turn on your TV	TV POWER 
Adjust the volume of your TV	+ TV VOLUME - 
Move the cursor on the TV screen	
Decide the cursor position	ENTER 

## How to use numeric buttons

The numeric buttons are used to select a track or title number.

**To use  to ,  (described as "press  to , ").**

1. Set  to DVD.
2. Select the desired track or title number.

- **To select a number between 1 and 10**





Press the corresponding button for the number.





- **To select a number higher than 10**

Use .

Example :

To select 13       → 





To select 34       →  →  → 





To select 40       →  →  → 

**To use  to  (usually used for time search and described as "press  to ").**





1. Set  to DVD.
2. Select the time.





Example (for DVD VIDEO):

1 hour 20 minutes       →  →  →  → 

3 minutes 20 seconds       →  →  →  → 

Example (for Audio CD/Video CD):

3 minutes 20 seconds       →  →  → 

65 minutes 30seconds       →  →  → 

# DVD VIDEO operations

This chapter explains all the functions of the player for playing back DVD discs. You can enjoy DVD in various ways such as selecting the subtitle and audio languages, viewing from multiple angle, some of which only DVD can offer.

## Table of contents of this chapter

■ <b>Playing a specific scene on a DVD disc</b>	
To locate a desired scene from the menu .....	34
To locate a desired scene by specifying the title number .....	35
To locate a desired scene by specifying the chapter number – <b>CHAP. SEARCH</b> .....	36
To locate a desired scene by specifying the time – <b>TIME SEARCH</b> .....	37
To locate a desired scene by watching the opening scene digest display – <b>DIGEST</b> .....	39
■ <b>Playing in slow-motion</b>	
To display still pictures – <b>STROBE</b> .....	40
To playback in slow-motion – <b>SLOW</b> .....	40
■ <b>Playing a scene close-up</b>	
To playback a scene close-up – <b>ZOOM</b> .....	41
■ <b>Repeat playback</b>	
To repeat a title or chapter – <b>REPEAT</b> .....	42
To repeat a desired part – <b>A-B REPEAT</b> .....	43
■ <b>Viewing from multiple angles</b>	
To select a scene angle from the normal screen – <b>ANGLE</b> .....	44
To select a scene angle from the on-screen display – <b>ANGLE</b> .....	44
To select a scene angle from the angle list display – <b>ANGLE</b> .....	45
■ <b>Changing the language and sound</b>	
To select the subtitle language – <b>SUBTITLE</b> .....	46
To change the audio language or sound selection – <b>AUDIO</b> .....	47
■ <b>Adjusting the picture to suit preferences</b>	
To adjust the picture quality – <b>VFP</b> .....	48

# Playing a specific scene on a DVD disc

You can play a from a selected scene. You can locate the desired scene on a DVD disc by selecting the title, chapter number, or time. You can also select it from the menu recorded on a DVD disc.



## To locate the desired scene from the menu

DVD discs generally have their own menus which show the disc contents. These menus contain various items such as titles of a movie, names of songs, or artist informations, and displayed on the TV screen. You can locate the desired scene by using the menu.

- Insert the DVD disc.

### 1 Press or .

The menu appears on the TV screen.

Example

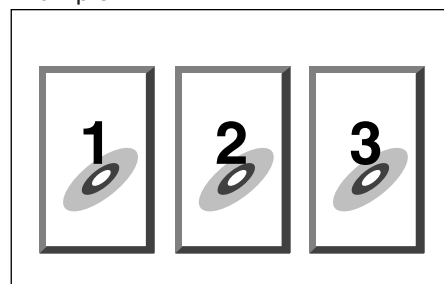



### 2 Use to select the desired item, then press .

- The unit starts playback of the selected item.







About  and 

A DVD disc which contains more than one title may have the menu like as a list of the title. In this case, the menu appears on the TV screen by pressing . On the other hand, a DVD disc which contains only one title may have the menu. In this case, the menu appears on the TV screen by pressing .



With some discs, you can select the item by entering the corresponding number using the numeric buttons, causing the unit to automatically start playback.

### NOTES

- When  appears on the TV screen by pressing  in step 1: The disc does not have the menu such as a list of the title.
- When  appears on the TV screen by pressing  in step 1: The disc does not have the menu.



## To locate the desired scene by specifying the title number

Each title is usually assigned a title number on DVD discs. You can play the desired title by selecting the title number.

- During stop mode

### 1 Use $\text{1}$ to $\text{10}$ , $\text{+10}$ to select the desired title number.

The selected title number appears in the display window on the front panel.

Example:

To select title number 8: Press  $\text{8}$ .

To select title number 37: Press  $\text{+10}$ ,  $\text{+10}$ ,  $\text{+10}$ ,  $\text{7}$ .

- The unit begins playback from the selected title.

#### NOTE

- When  $\text{⊘}$  is displayed in the TV screen

The title you have selected is not contained in the disc.







## To locate the desired scene by specifying the time [TIME SEARCH]

If the DVD disc contains time information, elapsed time appears on the TV screen. You can play the desired scene by selecting the time from the on-screen display.

■ During playback

1 Press .

The on-screen display appears on the TV screen.

2 Use to move to [TIME SEARCH], then press .

<GO TO> appears in the message area.

The color of [TIME SEARCH] changes.

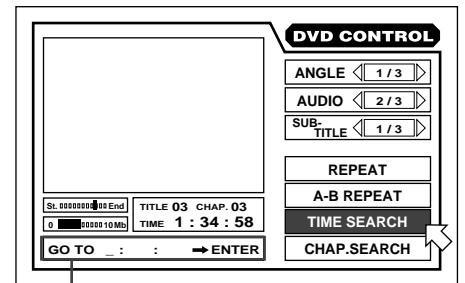

Message area

3 Use to to select the time (hour, minute, and second) then press .

Example 1:

To playback from the 1 hour point.

GO TO \_ : \_ :

Press .

GO TO 1 : \_ :

Press .

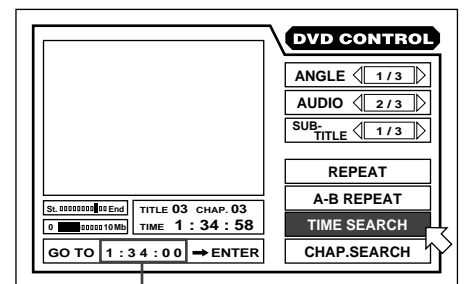

Selected time



and are not used in this function.

### Short cuts

After pressing **4**, press



You can input the time by pressing **ENTER** without pressing **0** twice to input the second position.

Example 2:

To select playback from 2 hour 34 minutes:

GO TO \_ : \_ :

Press **2**.

GO TO 2 : \_ :

Press **3**.

GO TO 2 : 3 \_ :

Press **4**.

GO TO 2 : 3 4 : \_

Press **0**.

GO TO 2 : 3 4 : 0

Press **0**.

GO TO 2 : 3 4 : 00

Press **ENTER**

- The unit starts playback from the selected time.

### NOTES

- **When you make a mistake in step 3:**

Move the cursor to the mistaken value, then press the correct value to re-select the value.

GO TO 2 : 3 5 : \_

Press **←**

GO TO 2 : 3 5 :

Press **4**.

GO TO 2 : 3 4 : \_

- **When  appears in the TV screen in step 2:**

The time you select is not contained on the disc, or time search does not work on the disc.

- **To return to the regular display:**

Press **ON SCREEN**.



## To locate a desired scene by watching the opening scene digest display [DIGEST]

The unit can display the opening scene of each title. You can select a desired title from the opening scenes displayed on the TV screen.

### ■ During stop mode





When you press  during playback, the unit displays the opening scene of each chapter and you can select the desired chapter. In this case, opening scenes are displayed from chapter 1.

### 1 Press .

The opening scene of each title appears on the TV screen.  
The up to nine opening scenes are displayed.



### 2 Use to select the desired title.

When you want to check more scenes, press . Additional scenes appear on the TV screen.  
When you want to return to previous scenes, press .





Selected title

### 3 Press .

■ The unit begins playback from the selected title.





- When the selected title is in the lower right-hand corner of the screen, press  to check next scenes.
- When the selected title is in the upper left-hand corner of the screen, press  to return to previous scenes.

# Playing in slow-motion

The unit can display a list of the still pictures, and playback a disc in slow-motion. You can view video in more detail using these functions.



During this function, when you press , next nine still pictures appear on the TV screen and playback pauses. When you press , nine still pictures continuously appear on the TV screen.

## To display still pictures [STROBE]

■ During playback

1 Press  at the point you want to view like as a continuous photograph.

2 Press and hold  for more than 1 seconds.

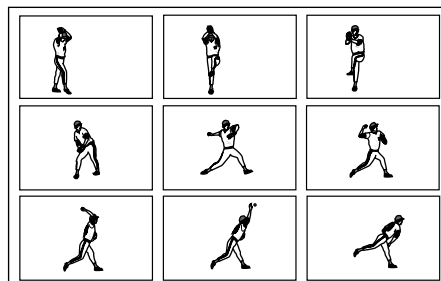

The nine still pictures appear on the TV screen and playback pauses.



### To cancel strobe play

Press and hold  more than 1 second.



You can enjoy advancing the picture frame-by-frame by pressing  during pause. Each time you press , the picture advances one frame.





You can also use the SHUTTLE knob for slow-motion play.

1. Press  to pause playback.
2. Turn the SHUTTLE knob to the right to play in slow-motion, and turn the SHUTTLE knob to the left to play in slow-motion in reverse. You can adjust the playback speed by turning the SHUTTLE knob.

## To playback in slow-motion [SLOW]

■ During playback

1 Press , then press  or .

To play in slow-motion, press , and to play in slow motion in reverse, press . First, the unit play the slowest speed, and each time you press these buttons, the playback speed increases. To return to normal playback, press .

### To pause slow-motion play

Press .

### NOTES

- **To cancel slow-motion play**  
Press .
- **The sound is muted during slow-motion play.**

# Playing a scene close-up

The unit can zoom in a part of the scene. You can view any part of the scene close-up.



## To playback a scene close-up [ZOOM]

■ During playback or pause

### 1 Press .

[ZOOM] appears on the TV screen.

The unit zooms in to the center part of the scene to produce a double-sized image.

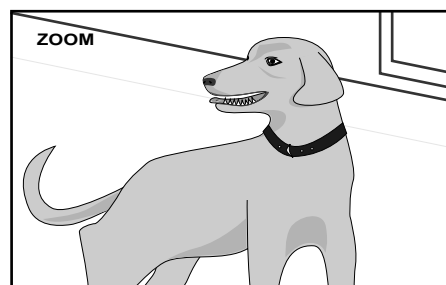
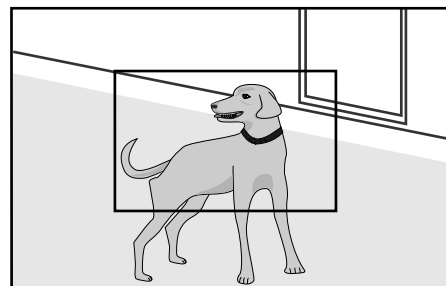

### 2 Use to move the zoomed-in scene.

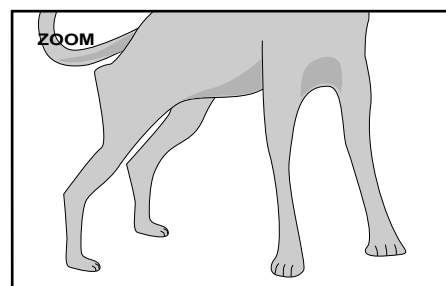

### To pause zoom play

Press .

To resume zoom play, press .

#### NOTE

- To cancel zoom play  
Press .

# Repeat playback

The unit can repeat playback of the current title or current chapter and you can also select the desired part for repeat playback.



## To repeat a title or chapter [REPEAT]

- During playback

**1** Press .

The on-screen display appears on the TV screen.

**2** Use to move to [REPEAT], then press .

Each time you press , the repeat mode changes as follows:

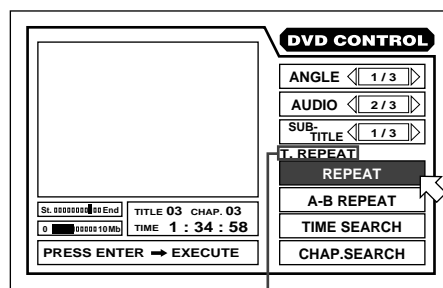
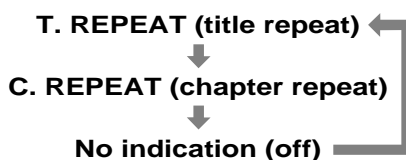

Selected repeat mode appears on the TV screen.

- The current title or chapter will be repeated.

### NOTES

- **To turn off the on screen display**  
Press .
- **To cancel repeat playback**  
Move to [REPEAT] in the on screen display and press repeatedly until [REPEAT] returns to its original color.
- **If appears when pressing ENTER in step 2**  
You cannot repeat the title because of the disc contents.



## To repeat a desired part [A-B REPEAT]

■ During playback

**1** Press .

The on-screen display appears on the TV screen.

**2** Use to move to [A-B REPEAT], then press at the beginning of the part you want to repeat (point A).

The color of "A-B REPEAT" changes.

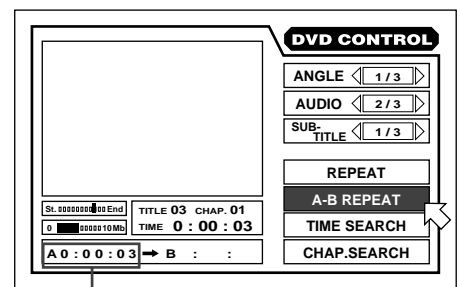

Point A

**3** Press at the end of the part you want to repeat (point B).

The unit locates "A" and starts repeat playback between "A" and "B."

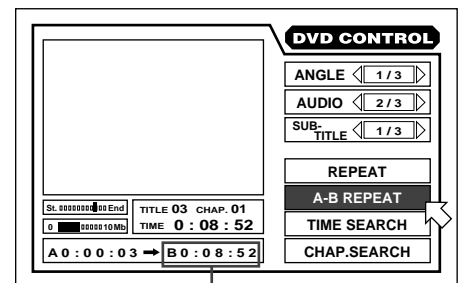

Point B

■ The selected portion will be repeated.

### NOTES

- **To turn off the on screen display**  
Press .
- **To cancel A-B repeat playback**  
Move to [A-B REPEAT] in the on screen display and press until [A-B REPEAT] returns to its original color.
- **If appears when pressing ENTER in step 2**  
You cannot repeat the selected portion because of the disc contents.

# Viewing from multiple angles

You can enjoy a variety of scene angles if the DVD disc contains "multi angle" parts, where multiple cameras were used to shoot the same scene from different angles. You can select one of these viewing angles from the normal screen or on-screen display.



## To select a scene angle from the normal screen [ANGLE]

■ During playback

1 Press .

2 Press or to select the desired angle.

Each time you press or , the scene changes.



## To select a scene angle from the on-screen display [ANGLE]

■ During playback

1 Press .

The on-screen display appears on the TV screen.

2 Use to move to [ANGLE].

The total number of recorded angles

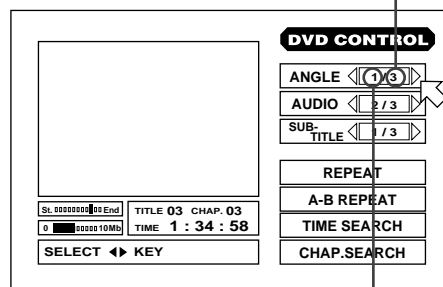

The current angle number

3 Use to select the desired angle number.

Example:

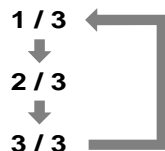

### NOTES

- **To turn off the on screen display**  
Press .
- **When appears on the TV screen**  
The current scene is not recorded from multiple angles.





## To select a scene angle from the angle list display [ANGLE]

■ During playback

**1** Press and hold  for more than 1 seconds.

Up to eight angle scenes recorded on a disc appear on the TV screen.

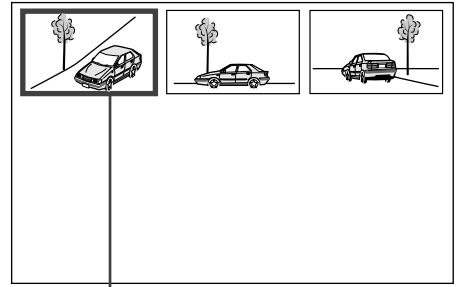

The selected scene angle

**2** Use  to select desired angle.

**3** Press .

■ The selected angle appears on the TV screen.

### NOTE

- When  appears on the TV screen in step 1:  
The current scene is not recorded from multiple angles.

# Changing the language and sound

You can choose the sub-title or audio language from among the languages included on a disc and select the sound from a variety of sounds included on a disc.



## Short cuts

Press and select the desired subtitle by using .



You can turn ON/OFF the subtitle by pressing . Each time you press , the ON/OFF status is switched. When the subtitle function is ON, the subtitle language appears on the TV screen.



When you select the language, if the abbreviation appears on the TV screen, select the abbreviation corresponding to the desired language. For details on abbreviations, see page 95.

## To select the subtitle language [SUBTITLE]

■ During playback

**1** Press .

The on-screen display appears on the TV screen.

**2** Use to move to [SUBTITLE].

**3** Use to select the desired subtitle.

Each time you use , the subtitle changes.

Example:

```

1/3 ENGLISH
↓
2/3 FRENCH
↓
3/3 SPANISH
↓
- /3 (off)
  
```

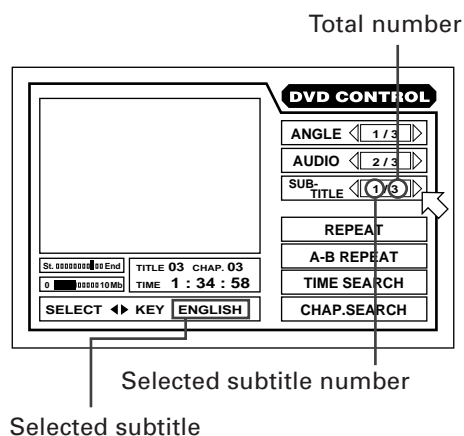

### NOTE

- When appears on the TV screen: You cannot select the subtitle.



## To change the audio language or sound selection [AUDIO]

■ During playback

**1** Press .

The on-screen display appears on the TV screen.

**2** Use to move to [AUDIO].

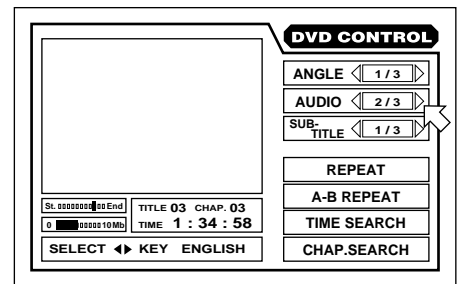

**3** Use to select desired audio language or sound.

Each time you use , the audio language or sound changes.

Example:

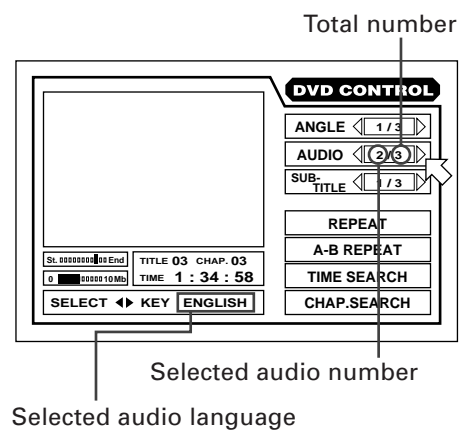
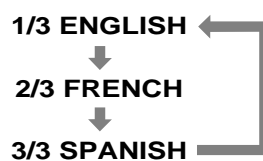

### NOTE

- When appears on the TV screen: You cannot select the audio or sound because the disc contains only one of audio language or sound selection (1/1 appears on the display).

# Adjusting the picture to suit preferences

You can adjust the picture quality depending on the disc contents.



## To adjust the picture quality [VFP]

■ During playback

1 Press or on the front panel.

2 Within 10 seconds, select the desired picture quality by pressing or on the front panel.

Each time you press the button, the picture quality changes as follows:

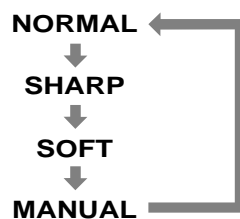

The selected picture quality tab lights up in yellow.

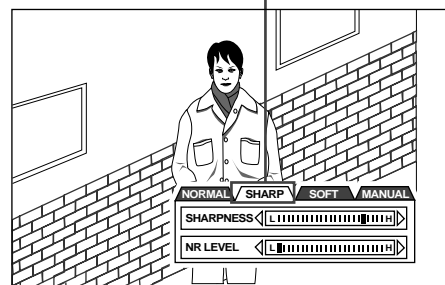

If you select [MANUAL], you can adjust the level of picture sharpness and noise reduction.

1. Use to select SHARPNESS or NR LEVEL.
2. Use to adjust the level.

### NOTES

- To erase the VFP screen, press .
- The VFP screen disappears if there are no operations for more than 10 seconds.

# Setting and adjustment

This chapter explains unit settings for playing back DVD discs. You can change the initial settings in various ways, for example, selecting the subtitle and audio language, type of monitor, and the cutting out violent scenes with the Parental lock function in order not to be viewed by children .

## Table of contents of this chapter

■ <b>Selecting preferences</b>	
How to set preferences on the "PREFERENCE" display .....	50
To set the language and display preference items .....	51
To set other preference items .....	54
■ <b>Limiting playback by children</b>	
To set Parental Lock for the first time – <b>PARENTAL LOCK</b> .....	58
To change the settings – <b>PARENTAL LOCK</b> .....	59
To temporarily release the Parental lock – <b>PARENTAL LOCK</b> .....	60

# Selecting preferences

You can set various preferences for DVD playback via the "PREFERENCE" display.



## How to set preferences on the "PREFERENCE" display

**1** Press to stop the unit.

If the current disc is not a DVD disc, you have to remove the disc from the tray before setting up.



For details of each setting, see the following pages:

### PREFERENCE 1

MENU LANGUAGE (51)  
AUDIO LANGUAGE (51)  
SUBTITLE (52)  
ON SCREEN LANGUAGE (52)  
ON SCREEN GUIDE (53)  
MONITOR TYPE (53)

### PREFERENCE 2

DIGITAL AUDIO OUTPUT (54)  
DOWN MIX (55)  
COMPRESSION (55)  
SCREEN SAVER (56)  
AV COMPULINK MODE (57)  
AUTO STANDBY (57)

**2** Press .

The "PREFERENCE" display appears on the TV screen.

The "PREFERENCE" display consists of two pages. To turn the page, move to the desired tab using .

### Preference 1

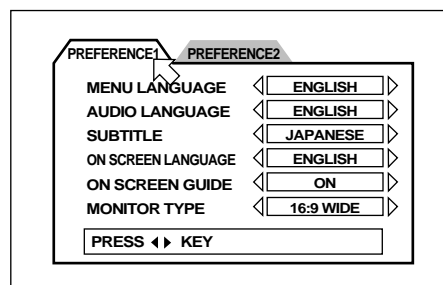

### Preference 2

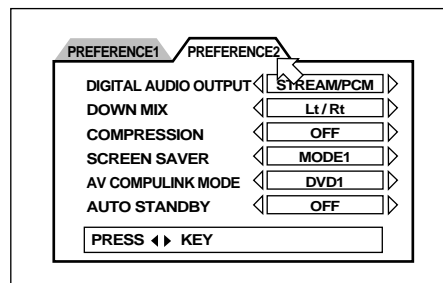

**3** Move to select the item you want to set by using

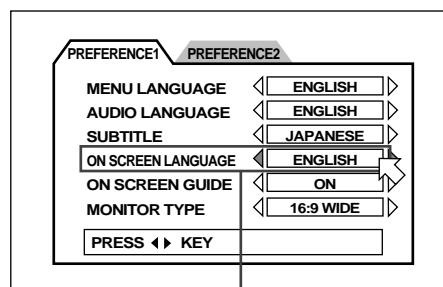

Selected item



To return to the normal screen,

press .

**4** Press to select the setting you want.

## To set the language and display preference items

The PREFERENCE 1 can be set as follows:

### MENU LANGUAGE

You can select a default “display” language to be displayed if it is contained on the disc.

Each time you press , the language setting changes in the following order:

**ENGLISH → SPANISH → FRENCH → CHINESE → GERMAN → ITALIAN → JAPANESE → language code from AA to ZU** (See “Table of languages and their abbreviations” on page 95.)

Pressing  changes the language setting in the reverse order of the above.

\* If the selected language is not recorded, the disc’s default display language is displayed.

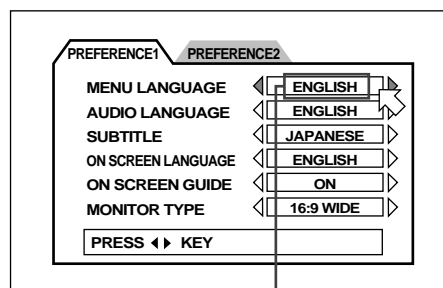

Selected language

### AUDIO LANGUAGE

You can select the default audio language to be played if it is contained on the disc.

Each time you press , the language setting changes in the following order:

**ENGLISH → SPANISH → FRENCH → CHINESE → GERMAN → ITALIAN → JAPANESE → language code from AA to ZU** (See “Table of languages and their abbreviations” on page 95.)

Pressing  changes the language setting in the reverse order of the above.

\* If the selected language is not recorded, the disc’s default audio language is played.

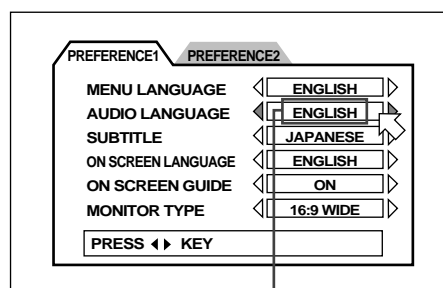

Selected language

### SUBTITLE

You can select the default subtitle language to be displayed when it is contained on a playback disc.

Each time you press , the language setting changes in the following order:

**ENGLISH → SPANISH → FRENCH → CHINESE → GERMAN → ITALIAN → JAPANESE → language code from AA to ZU** (See "Table of languages and their abbreviations" on page 95.)

Pressing  changes the language setting in the reverse order of the above.

\* If the selected language is not recorded, the disc's default subtitle language is displayed.

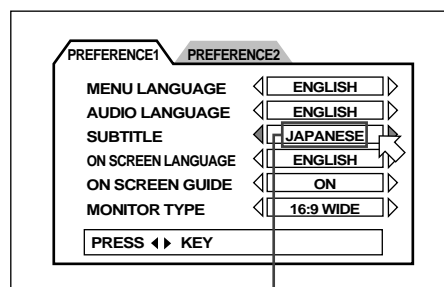

Selected language

### ON SCREEN LANGUAGE

You can select the on screen display language to be displayed.

Each time you press , the language setting changes as follows:

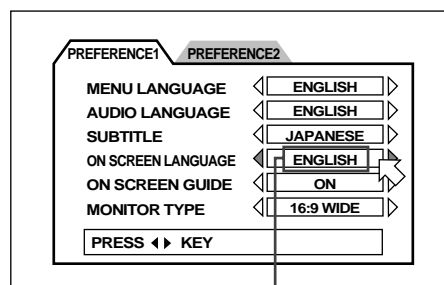
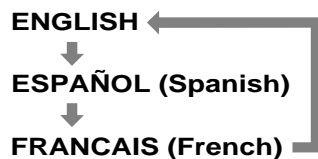

Selected language

English	ON SCREEN LANGUAGE < ENGLISH >
Spanish	IDIOMA EN PANTALLA < ESPAÑOL >
French	LANGUE D'ECRAN < FRANCAIS >



## ON SCREEN GUIDE

The unit can display "on screen guide" icons or characters on the picture, which show what is happening to the disc or the unit.

- **ON**  
The guide display turns on.
- **OFF**  
The guide display turns off.

Examples of "On-screen guide" icons or characters to be off:

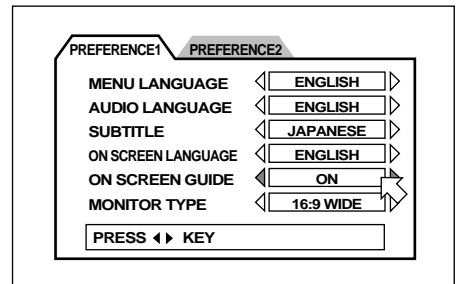

## MONITOR TYPE

You can select the monitor type to match your TV when you playback DVD discs recorded for wide screen televisions.

- **4:3 LB**  (Letter Box Conversion)  
When you connect a normal TV to the unit.  
When you play a wide picture recorded on a DVD VIDEO, the picture is displayed with bands across the upper and lower portions of the screen.
- **4:3 PS**  (Pan scan Conversion)  
When you connect a normal TV to the unit.  
When you play a wide picture recorded on a DVD VIDEO, a portion of the picture is automatically cut off from the left and right sides of the image. According to the disc, it is prohibited to playback on this mode. In this case, the picture is played back like as the picture on 4:3 LB  mode.
- **16:9 WIDE** (Wide Television screen)  
When you connect a wide-screen TV to the unit.

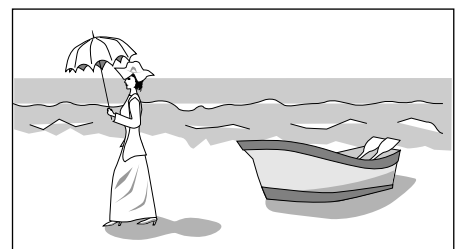
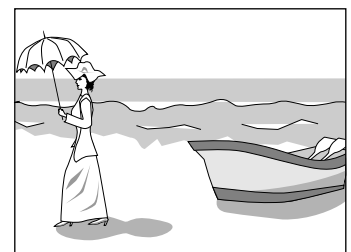
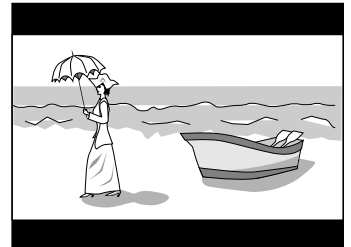

## To set other preference items

The PREFERENCE 2 can be set as follows:

### DIGITAL AUDIO OUTPUT

To connect the unit's digital output to an external amplifier or receiver equipped with a digital input, this item must be set correctly.

- **PCM ONLY:**

When you connect the DIGITAL OUT jack of the unit and the linear PCM digital input of an audio equipment.

- **STREAM/PCM:**

When you connect to the Dolby digital input of an amplifier with built-in DTS and Dolby Digital decoder.

- **DOLBY DIGITAL/PCM:**

When you connect to the Dolby digital input of a Dolby Digital decoder, an amplifier with built-in Dolby Digital decoder

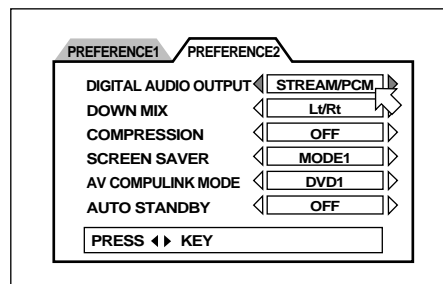

The following chart shows the relationship between types of playback discs and output signals.

Playback discs	Output		
	STREAM/PCM	DOLBY DIGITAL/PCM	PCM ONLY
DVD with 48-kHz, 16-bit linear PCM	48-kHz, 16-bit linear PCM	←	←
DVD with 48-kHz, 20/24-bit linear PCM	48-kHz, 20-bit linear PCM	←	←
DVD with 96-kHz, linear PCM	No output	←	←
DVD with DTS	DTS bitstream	No output	No output
DVD with Dolby Digital	Dolby Digital bitstream	Dolby Digital bitstream	48-kHz, 16-bit linear PCM
DVD with MPEG audio	MPEG bitstream	48-kHz, 16-bit linear PCM	48-kHz, 16-bit linear PCM
Video CD	44.1-kHz, 16-bit linear PCM	←	←
Audio CD	44.1-kHz, 16-bit linear PCM	←	←
Audio CD with DTS	DTS bitstream	←	←

### NOTES

- When you play a CD disc with DTS, unnecessary audio signal output from the AUDIO OUT (analog) jack. Adjust the volume level of an amplifier connected to the AUDIO OUT jack of the unit to minimum.
- When you do not connect the unit to the DTS decoder, a CD disc with DTS cannot be played back. Do not play a CD disc with DTS when the unit is connected to the DIGITAL jack other than it of the DTS decoder. If you do so, loud noise may be played back from speakers, and it cause of the breakdown of your speakers.

## DOWN MIX

By setting DOWN MIX correctly, you can get the optimum stereo mix for your audio system from DVD discs recorded with Dolby Digital surround multichannel audio.

- **Lt/Rt:**

You can monitor the unit's audio output signals via an amplifier with built-in Dolby Pro Logic Decoder.

- **L0/R0:**

You can monitor the unit's audio output signals via a TV, an amplifier with no built-in Dolby Pro Logic Decoder, or the unit's headphone jack. Also for recording DVD audio output to a cassette tape, MD, etc.

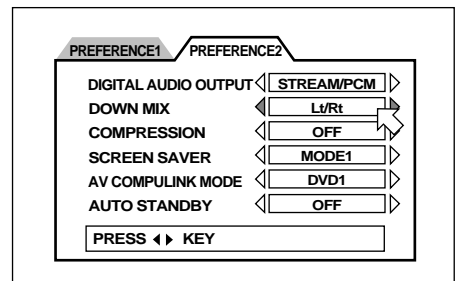

## COMPRESSION

You can compress the dynamic range of the sound if you need. Using this function, you can listen to sound in small volume easily.

- **ON**

Audio is played back with the dynamic range compressed.

- **OFF**

Audio is played back as it was recorded.

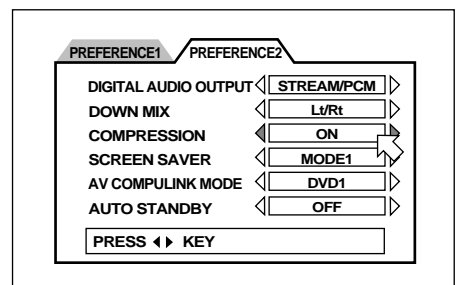

### NOTES

- The compression function works only when playing back the disc recorded on DOLBY DIGITAL 1 CH or 2CH. The setting is not effective on other discs.
- The compression function does not work when the 3D PHONIC function is activated.
- The downmix function does not work when the 3D PHONIC function is activated.

## SCREEN SAVER

A television monitor screen may be burned out if a static picture is displayed for a long time. To prevent this, the unit automatically activates the screen saver function if a static picture, such as an on-screen display or menu, is displayed for over 5 minutes.

- **MODE 1**  
The picture is scrolled.
- **MODE 2**  
The picture is not scrolled.
- **DIMMER**  
The picture gets dark.
- **OFF**  
The screen saver function is off.

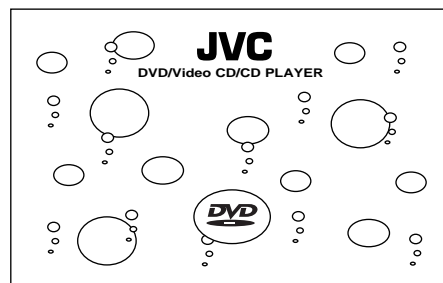
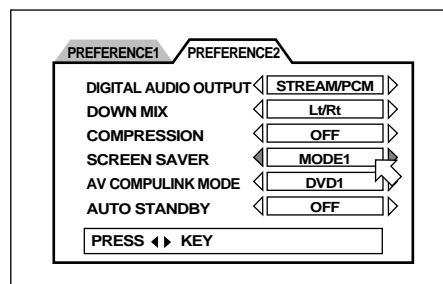

### NOTES

- When "SCREEN SAVER" is set to "DIMMER," the display window on the front panel also gets dark. To return to normal brightness, set "SCREEN SAVER" to a different mode.
- The monitor screen of a projector or projection TV is easily to burned out if a static picture is displayed for a long time. Be careful not to allow the monitor screen to be burned out when you set the screen saver mode to OFF.
- The TV screen may be noisy when you set the screen saver mode to MODE 1. In this case, set to the other mode.

## AV COMPULINK MODE

If you use the AV Compulink system, you must set this item correctly.

Select from the three options: “**DVD1**,” “**DVD2**” and “**DVD3**” according to the equipment to be connected.

See page 92.

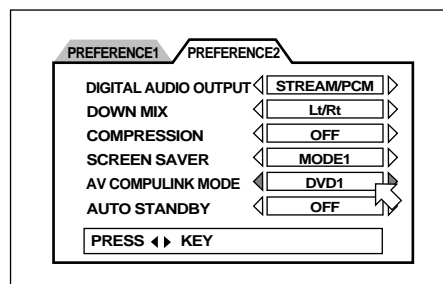

## AUTO STANDBY

When the unit is not operated or in stop mode for more than 30 minutes or 60 minutes, the unit enters standby mode automatically.

- **60**  
Time is set to 60 minutes.
- **30**  
Time is set to 30 minutes.
- **OFF**  
The auto standby function is off.

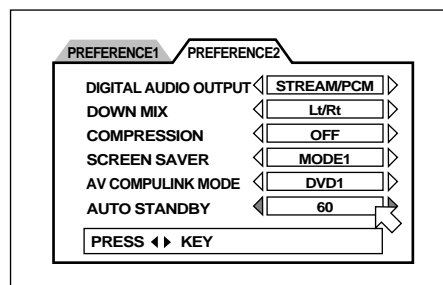





## To change the settings [PARENTAL LOCK]

- 1** Press while holding down .

If the current disc is not a DVD disc, you have to remove the disc from the tray before setting up.

The Parental Lock on-screen display appears on the TV screen.

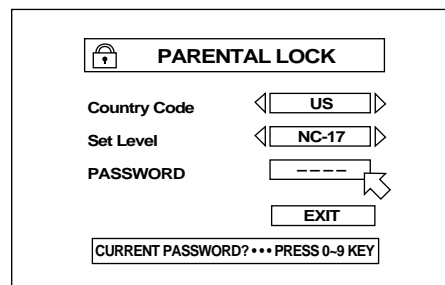

- 2** Enter your current 4-digit password using to and press .

If you enter the wrong password, <WRONG ENTRY.....> appears on the TV screen, and you cannot go to next step.

- 3** Use to move to [Set Level], then use to select the parental lock level.

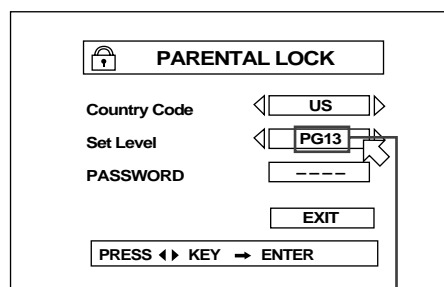

Selected level

- 4** Press .

- 5** Enter your new 4-digit password using to and press .

■ The new setting is effective.

### NOTES

- When you enter the wrong password more than 3 times in step 2 above, moves to <EXIT> automatically and does not work.
- If you forget your password in step 2 Enter "8888."



## To temporarily release the Parental lock [PARENTAL LOCK]

When you set the parental level strictly, some discs may not be played back at all. When you insert such a disc and try to play it, the Parental Lock on-screen display appears on the TV screen, and the unit will ask you whether you want the parental lock to be released temporarily or not.

- 1 Use the to select [YES] or [NO], then press .

If you select [NO], the parental Lock on-screen display disappears from the TV screen.

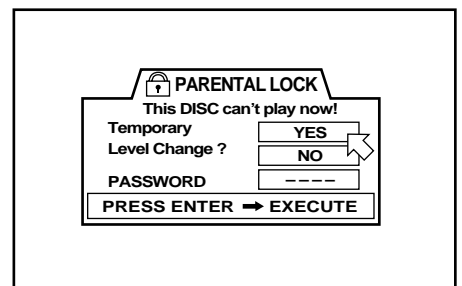

- 2 Enter your 4-digit password using to .

If you enter the wrong password, "WRONG! RETRY..." appears on the TV screen, and you cannot go to next step.

- The Parental lock is released, and the unit starts playback.

### NOTE



- When you enter the wrong password more than 3 times in step 2 above, moves to <NO> automatically and does not work.



# Audio CD operations

This chapter explains all the unit functions for playing back Audio CD discs. You can enjoy Audio CDs in various ways such as listening to only the desired track, changing the track order, and repeating tracks.

## Table of contents of this chapter

■ <b>Playing a specific track on a disc</b>	
To locate the desired track using  or  .....	62
To locate the desired track directly .....	62
To locate the desired position by specifying the time – <b>TIME SEARCH</b> .....	63
■ <b>Changing the track order</b>	
To playback in the desired order – <b>PROGRAM</b> .....	65
To playback tracks in random order – <b>RANDOM</b> .....	66
■ <b>Repeat playback</b>	
To repeat a current track or all tracks – <b>REPEAT</b> .....	67
To repeat a desired part – <b>A-B REPEAT</b> .....	68
■ <b>Sampling all tracks</b>	
To playback only the beginning of each track – <b>INTRO</b> .....	69
■ <b>Checking the elapsed time or remaining time</b>	
To select the time display mode – <b>TIME SELECT</b> .....	70
■ <b>Information about CD TEXT</b> .....	71

# Playing a specific track on a disc

You can play a specific track on a disc by selecting the track number or time. You can select it from the on-screen display on the TV screen, or using remote control.





You can display the desired track number on the TV screen. In this case, press  to display the Audio CD on-screen display, then select the desired track.

## To locate a desired track using or

■ During playback

### 1 Press or .

- To skip to a succeeding track, press  once or repeatedly until the desired track appears in the display.
- To skip to beginning of the current track, press  once.
- To skip to a preceding track, press  repeatedly until the desired track appears in the display.

Display window



Selected track number







## To locate a desired track directly



■ During playback or stop mode

### 1 Select a desired track number using to , .

Example:

To select track number 8: Press .

To select track number 37: Press  >  >  > .

To select track number 15: Press  > .

Display window



Selected track number

■ The unit starts playback from the selected track.



## To locate a desired position by specifying the time [TIME SEARCH]

You can playback a disc from the desired position by specifying the elapsed time from the beginning of the disc.

**1** Press .

The on-screen display appears on the TV screen.

**2** Use to move to [TIME SEARCH] and press



The color of "TIME SEARCH" changes.

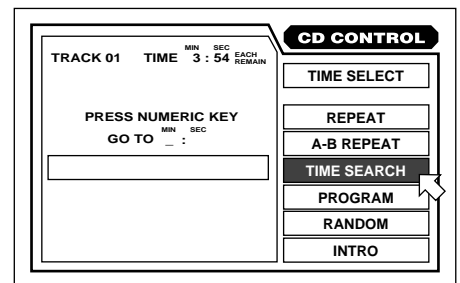

**3** Use to to select the time (minute and second) then press .

Example:

To playback from 2 minutes 34 seconds.

GO TO \_ :

Press .

GO TO 0\_ :

Press .

GO TO 02 : \_

Press .

GO TO 02 : 3 \_

Press .

GO TO 02 : 3 4

Press .

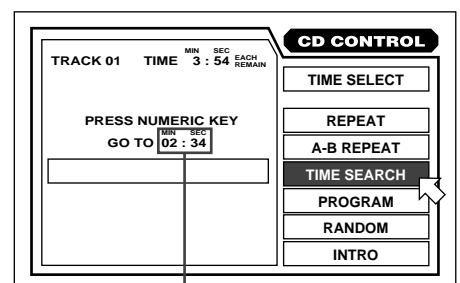

Selected time



and are not used for this function.

■ The unit starts playback from the selected time.

**NOTES****● When you make a mistake in step 3:**

Move the cursor to the mistaken value, then press the correct value to re-select the value.

GO TO 02 : \_

Press 

GO TO 02 :

Press 

GO TO 04 : \_

**● When  appears in the TV screen in step 3:**

The time you selected is not contained on the disc, or time search does not work on the disc.

# Changing the track order

You can listen to CD tracks in the desired order, or in random order. You can program up to 16 tracks.



## To playback in the desired order [PROGRAM]

By creating a program, you can enjoy listening to your favorite tracks in any order.

■ During stop only

**1** Press .

The on screen display appears on the TV screen.

**2** Use to move to [PROGRAM] and press .

The color of "PROGRAM" changes.

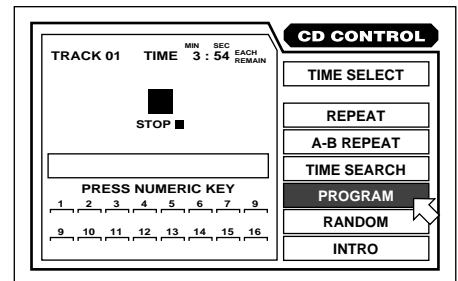

**3** Select the tracks in the desired order using to , .

Up to 16 tracks can be programmed. You may select the same track more than once.

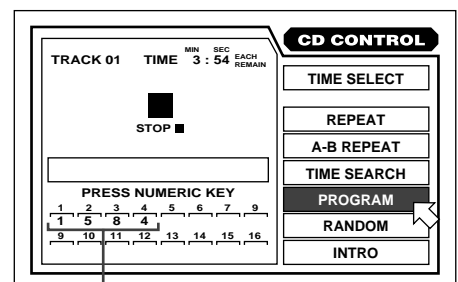

Selected track number

**4** Press to start program play.



When all of the programmed tracks have finished playback, the unit stops but the program remains.

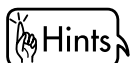

You can program tracks during program playback.

### NOTES

- **When you make a mistake in step 3:**  
Press . The last track programmed is erased.
- **To clear program play**  
Press to stop playback, then press again. All the programmed tracks are erased.
- **To quit the program play**  
Move to [PROGRAM] in the display using and press . "PROGRAM" returns to its original color.



## To playback tracks in random order [RANDOM]

The unit can play tracks in random order.

### ■ During stop mode

**1** Press .

The on screen display appears on the TV screen.

**2** Use to move to [RANDOM].

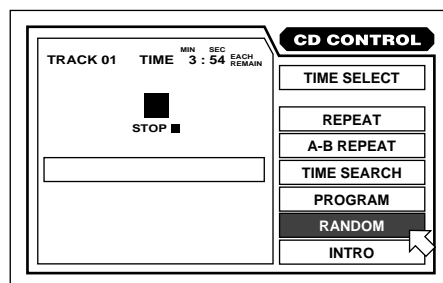

**3** Press .

The color of "RANDOM" changes.

### ■ Random play begins.



- When all tracks have been played once, random play ends.
- The same track will not be played back more than once during random play.

### NOTES

- **To stop random play**  
Press .
- **To quit random play**  
Move to [RANDOM], then press . "RANDOM" returns to its original color.

# Repeat playback

The unit can repeat playback of all tracks or the current track and you can also select a desired section for repeat playback.



## To repeat a current track or all tracks [REPEAT]

■ During playback

1 Press .

The on-screen display appears on the TV screen.

2 Use to move to [REPEAT].

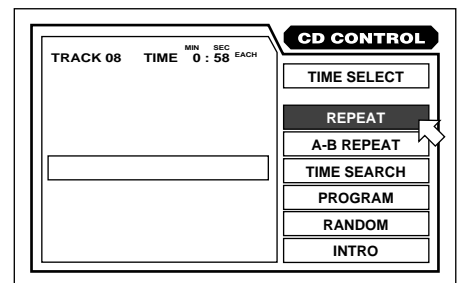

3 Press .

Each time you press , the repeat mode changes as follows:

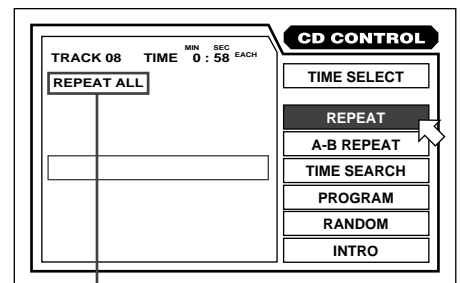
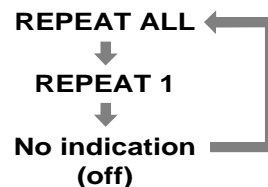

Selected repeat mode

### REPEAT ALL:

All the tracks are played repeatedly.

### REPEAT 1:

The current track is played repeatedly.

■ The current track or all the tracks is/are played repeatedly.

## NOTES

- **To quit repeat playback**  
Press . The unit stops but remains in repeat play mode.
- **To cancel repeat playback**  
Move to [REPEAT] in the on screen display and press repeatedly until [REPEAT] returns to its original color.



## To repeat a desired part [A-B REPEAT]

■ During playback

1 Press .

The on-screen display appears on the TV screen.

2 Use to move to [A-B REPEAT], then press at the beginning of the part you want to repeat (point A).

The color of "A-B REPEAT" changes.

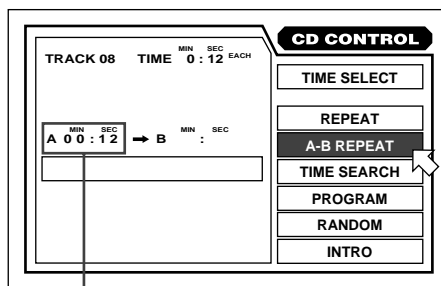

Point A

3 Press at the end of the part you want to repeat (point B).

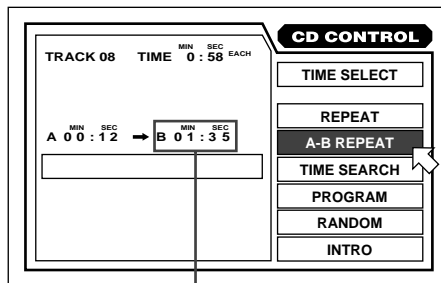

Point B

■ The unit locates "A" and starts repeat playback between "A" and "B."

### NOTE

- **To cancel A-B repeat playback**  
Move to [A-B REPEAT] in the on screen display and press until [A-B REPEAT] returns to its original color.



# Sampling all tracks

You can sample the tracks by listening to a short segment of each track in order. The unit plays the first 10 seconds of each track.



## To playback only the beginning of each track [INTRO]

■ During stop

1 Press ON SCREEN.

The on-screen display appears on the TV screen.



- When all tracks have been played once, INTRO scan stops.

2 Use to move to [INTRO].

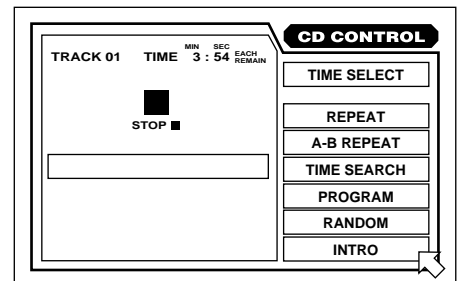

3 Press .

The color of "INTRO" changes.

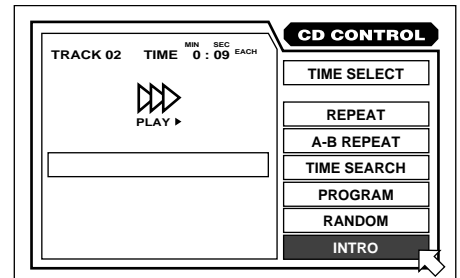

■ The first 10 seconds of each track on a disc are played back in numerical order from the first track.

### NOTE

- **To stop INTRO scan**  
Press or move to [INTRO], then press .

# Checking the elapsed time or remaining time

You can check the elapsed time of the current track or entire disc, and check remaining time of the current track or entire disc from the on-screen display on the TV screen or the display window on the front panel.



## To select the time display mode [TIME SELECT]

You can choose the time mode in the display on the front panel and in the on-screen display.

■ During playback

1 Press .

The on-screen display appears on the TV screen.

2 Use to move to [TIME SELECT].

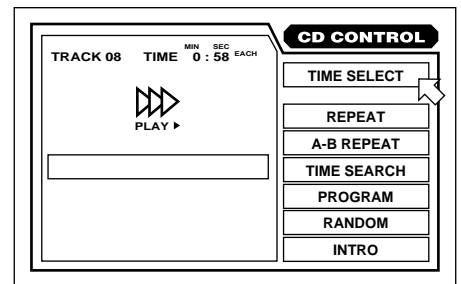

3 Press .

Each time you press , the time mode changes as follows:

### EACH

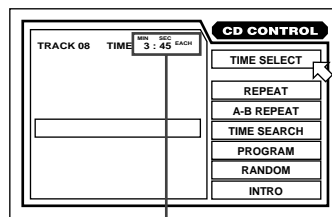

Elapsed time of the current track

### EACH REMAIN

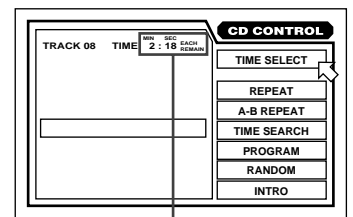

Remaining time of the current track

### TOTAL REMAIN

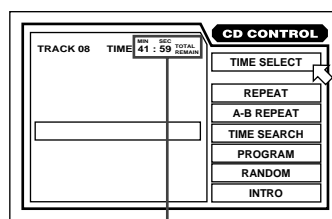

Total remaining time of the disc

### TOTAL

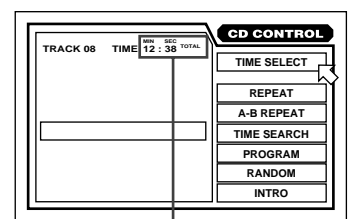

Total elapsed time of the disc



When you select the time mode during stop mode, the time mode changes as follows:

**EACH (0:00)**



**EACH REMAIN**

Recorded time of the current track



**TOTAL (0:00)**



**TOTAL REMAIN**

Total recorded time of the disc

# Information about CD TEXT

The unit is compatible with the CD TEXT function. CD TEXT discs have information, such as the album title, artist names, and track names. If the played disc is a CD TEXT disc, CD text data appears on the TV screen.

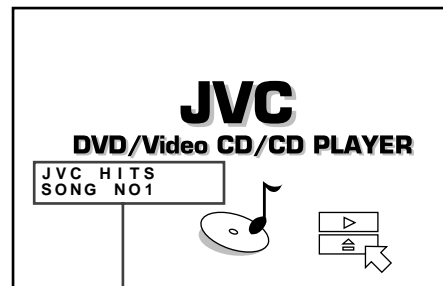

CD TEXT

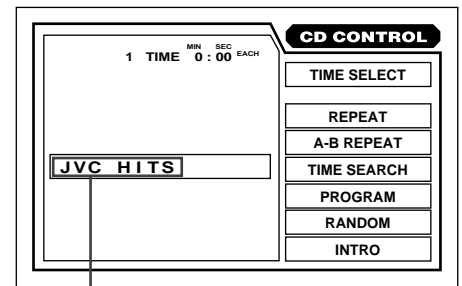

CD TEXT



CD TEXT data also appears in the display window. In this case, each time you press , CD TEXT data and time appears alternately.

## NOTES



- The album title, artist names, or track names may not be displayed with some CD TEXT discs.
- When you insert a CD TEXT disc which contains many tracks, the time until the unit is ready for playback is longer than usual. The time is necessary for the unit to read the CD TEXT information, and this is not a malfunction.



# Video CD operations

This chapter explains all the functions of the unit for playing back Video CD discs. You can also enjoy Video CDs in various ways such as enjoying only a desired track, changing the track order, and repeating track playback.

## Table of contents of this chapter

■ <b>Playing a specific scene on a Video CD</b>	
To use the menu of the Video CD recorded on PBC .....	74
To locate a desired track using  or  .....	75
To locate a desired track directly .....	75
To locate a desired position by specifying the time – <b>TIME SEARCH</b> .....	76
To locate a desired scene by watching the opening scene digest display – <b>DIGEST</b> .....	78
■ <b>Playing in slow-motion</b>	
To display still pictures – <b>STROBE</b> .....	79
To playback in slow-motion – <b>SLOW</b> .....	79
■ <b>Playing a scene close-up</b>	
To playback a scene close-up – <b>ZOOM</b> .....	80
■ <b>Changing the track order</b>	
To playback in the desired order – <b>PROGRAM</b> .....	81
To playback tracks in random order – <b>RANDOM</b> .....	82
■ <b>Repeat playback</b>	
To repeat a current track or all tracks – <b>REPEAT</b> .....	83
To repeat a desired part – <b>A-B REPEAT</b> .....	84
■ <b>Sampling all tracks</b>	
To playback only the beginning of each track – <b>INTRO</b> .....	85
■ <b>Adjusting the picture and sound to suit preferences</b>	
To adjust the picture quality – <b>VFP</b> .....	86
To change the audio channel – <b>AUDIO</b> .....	87
■ <b>Checking the total disc time</b>	
To select the time display mode – <b>TIME SELECT</b> .....	88

# Playing a specific scene on a Video CD

You can play a specific scene on a Video CD disc by selecting the time, the track number, the opening scene digest display, or the item on the menu displayed on the TV screen.



## To use the menu of the Video CD recorded on PBC

Some Video CD discs are compatible with the PBC function. PBC is an abbreviation of "PlayBack Control." Video CD disc recorded on PBC have own menus such as the list of the songs of the disc and items recorded in a disc. You can also locate the specific scene by using the menu.

■ When the menu appears on the TV screen during playback with PBC



When you play a Video CD disc using the PBC function, "PBC" appears in the display window on the front panel. When the PBC function is not activate, Press , then press to activate the PBC function. You can also operate from the on-screen display as follows:

1. Press .
2. Use to move to [PBC CALL], then press .



When you want to set to off the PBC function, press the numeric buttons to play a disc. See page 75.

- 1 Use to , to select the desired number of the item.

Example:

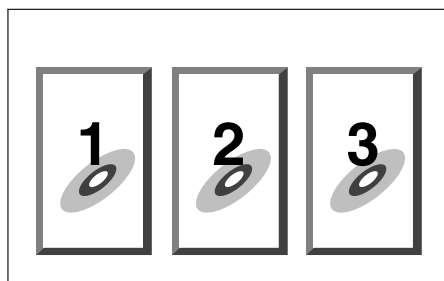

Playback starts from the selected item.

You can return to the menu by pressing .

When "NEXT" or "PREVIOUS" appears on the TV screen, the unit generally work as:

- succeeding to the next page by pressing .
- return to the previous page by pressing .



\*The method of the operation is different depending on the disc.



## To locate a desired track using or

- During playback without the PBC function

**1** Press  or .

- To skip to succeeding tracks, press  once or repeatedly until the desired track appears in the display.
- To skip to beginning of the current track, press  once.
- To skip to preceding tracks, press  repeatedly until the desired track appears in the display.

### NOTE

- This function does not work when playback with the PBC function.



## To locate a desired track directly

- During playback without the PBC function or stop mode

**1** Select a desired track number using  to , .

Example:

To select track number 8: Press .

To select track number 37: Press  ,  ,  , .

- The unit starts playback from the selected track.

### NOTE

- This function does not work when playback with the PBC function.



## To locate a desired position by specifying the time [TIME SEARCH]

You can playback a disc from the desired position by specifying the elapsed time from the beginning of the disc.

■ During playback without the PBC function

**1** Press .

The on-screen display appears on the TV screen.

**2** Use to move to [TIME SEARCH] and press .

The color of "TIME SEARCH" changes.

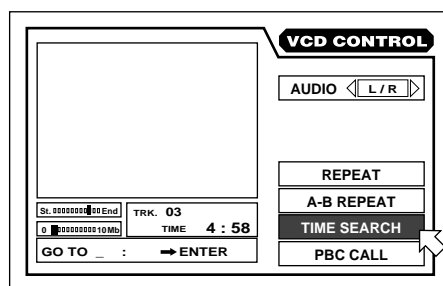

and are not used in this function.

**3** Use to to select the time (minute and second) then press .

Example:

To select playback from 2 minutes 34 seconds.

GO TO \_ :  
Press .

GO TO 0\_ :  
Press .

GO TO 02 : \_  
Press .

GO TO 02 : 3\_  
Press .

GO TO 02 : 34

Press .

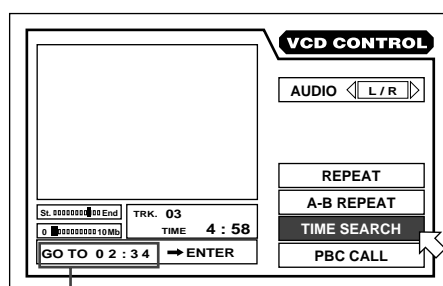

Selected time

■ The unit starts playback from the selected time.



**NOTES****● When you make a mistake in step 3:**

Move the cursor to the mistaken value, then press the correct value to re-select the value.

GO TO 02 : \_

Press 

GO TO 02 :

Press 

GO TO 04 : \_

**● When  appears in the TV screen in step 2:**

The time you selected is not contained on the disc, or time search does not work for the part you selected. When you play a Video CD disc with the PBC function, there is a part where time search does not work.

**● To return to the regular display:**

Press  and the on-screen display will return to the regular display.

**● The time search function does not work during PBC playback.**



## To locate a desired scene by watching the opening scene digest display [DIGEST]

The unit can display the opening scene of each track. You can select a desired track from the opening scenes displayed on the TV screen.

- During stop mode or playback without PBC function



### 1 Press .

The opening scene of each track appears on the TV screen.

Up to nine opening scenes are displayed.



### Hints

- When the selected track is in the lower right-hand corner of the screen, press  to check next scenes.
- When the selected track is in the upper left-hand corner of the screen, press  to return to previous scenes.

### 2 Use to select the desired track.

When you want to check more scenes, press . Additional scenes appear on the TV screen.

When you want to return to previous scenes, press .



Selected track



### 3 Press .

- The unit begins playback from the selected track.

# Playing in slow-motion

The unit can display a list of the still pictures, and playback a disc in slow-motion. You can view video in more detail using these functions.



During this function, when you press , next nine still pictures appear on the TV screen and playback pauses. When you press , nine still pictures continuously appear on the TV screen.

## To display still pictures [STROBE]

■ During playback

**1** Press  at the point you want to view like as a continuous photograph.

**2** Press and hold  for more than 1 seconds.

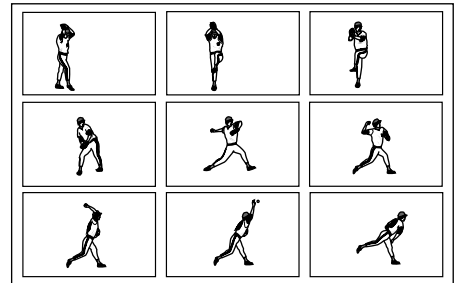

The nine still pictures appear on the TV screen and playback pauses.



### To cancel strobe play

Press and hold  more than 1 second.



You can enjoy advancing the picture frame-by-frame by pressing  during pause. Each time you press , the picture advances one frame.





You can also use the SHUTTLE knob for slow-motion play.

1. Press  to pause playback.
2. Turn the SHUTTLE knob to the right to play in slow-motion. You can adjust the playback speed by turning the SHUTTLE knob.

## To playback in slow-motion [SLOW]

■ During playback

**1** Press , then press .

The unit play the slowest speed, and each time you press , the playback speed increases. To return to normal playback, press .

### To pause slow-motion play

Press .

### NOTES

- The sound is muted during slow-motion play.
- To cancel slow-motion play  
Press .
- Reverse slow playback is not possible on a Video CD disc.

# Playing a scene close-up

The unit can zoom in a part of the scene. You can view any part of the scene close-up.



## To playback a scene close-up [ZOOM]

■ During playback or pause

### 1 Press .

[ZOOM] appears on the TV screen.  
The unit zooms in to the center part of the scene to produce a double-sized image.

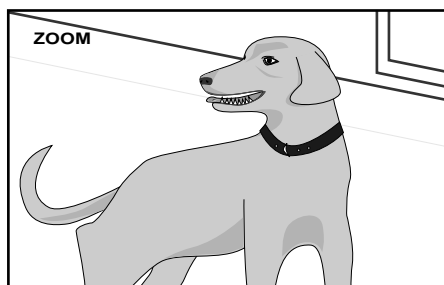
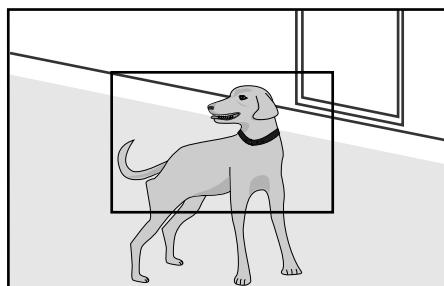

### 2 Use to move the zoomed-in scene.

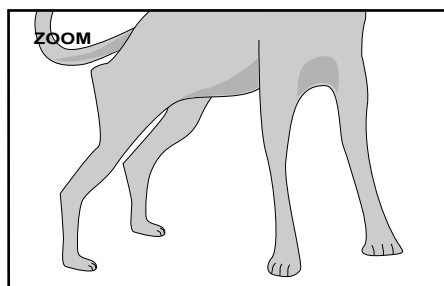

### To pause zoom play

Press .

To resume zoom play, press .

#### NOTE

- To cancel zoom play  
Press .

# Changing the track order

You can play tracks on a Video CD in the desired order or in random order.



## To playback in the desired order [PROGRAM]

By creating a program, you can enjoy listening to your favorite tracks in any order.

■ During stop mode only

**1** Press .

The on screen display appears on the TV screen.

**2** Use to move to [PROGRAM] and press .

The color of "PROGRAM" changes.

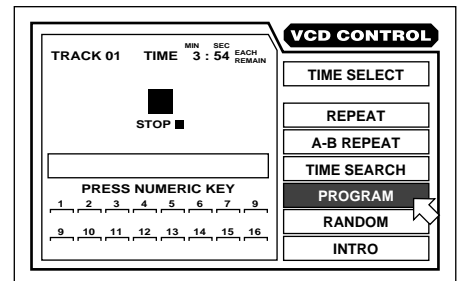

**3** Select the tracks in the desired order using to , .

Up to 16 tracks can be programmed. You may select the same track more than once.

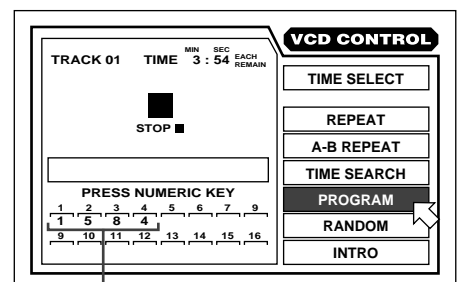

Selected track number

**4** Press to start program play.



When all of the programmed tracks have finished playback, the unit stops but the program remains.

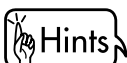

You can program tracks during playback.

### NOTES

- **When you make a mistake in step 3:**  
Press . The last track programmed is erased.
- **To clear program play**  
Press to stop playback, then press again. All the programmed tracks are erased.
- **To quit the program play**  
Move to [PROGRAM] in the display using and press . "PROGRAM" returns to its original color.



## To playback tracks in random order [RANDOM]

The unit can play tracks in random order.

### ■ During stop

**1** Press .

The on screen display appears on the TV screen.

**2** Use to move to [RANDOM].

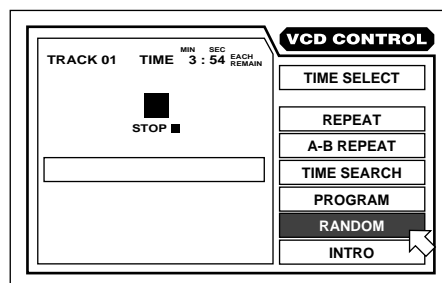

**3** Press .

### ■ Random play begins.



- When all tracks have been played once, random play ends.
- The same track will not be played back more than once during random play.

### NOTE

- **To stop random play**  
Press .

# Repeat playback

The unit can repeat playback the current title or current chapter and you can also select a desired part for repeat playback.



## To repeat a current track or all tracks [REPEAT]

■ During playback without PBC function

1 Press .

The on-screen display appears on the TV screen.

2 Use to move to [REPEAT].

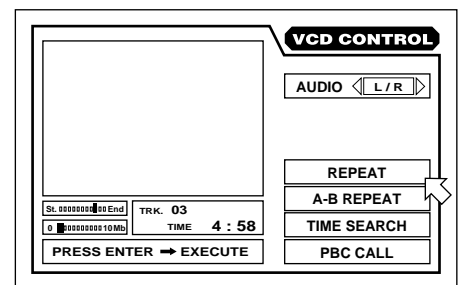

3 Press .

Each time you press , the repeat mode changes as follows:

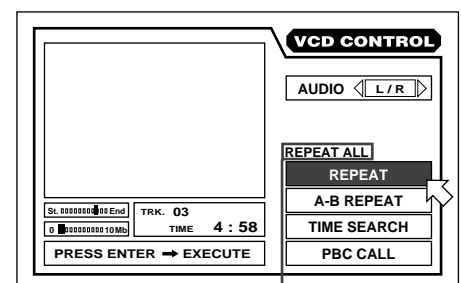
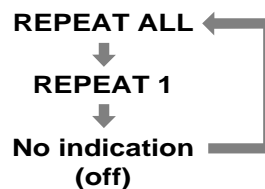

Selected repeat mode

### REPEAT ALL:

All the tracks are played repeatedly.

### REPEAT 1:

The current track is played repeatedly.

■ The current track or all tracks is/are played repeatedly.

## NOTES

- Repeat play function cannot be used during playback with PBC function. To use this function, press to stop playback and then specify any track number by using the numeric buttons.
- To turn off the on-screen display  
Press .
- To quit repeat playback  
Press . The unit stops but remains in repeat play mode.
- To cancel repeat playback  
Move to [REPEAT] in the on screen display and press repeatedly until [REPEAT] returns to its original color.



## To repeat a desired part [A-B REPEAT]

■ During playback

**1** Press .

The on-screen display appears on the TV screen.

**2** Use to move to [A-B REPEAT], then press at the beginning of the part you want to repeat (point A).

The color of "A-B REPEAT" changes.

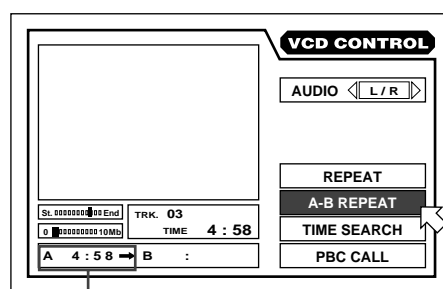

Point A

**3** Press at the end of the part you want to repeat (point B).

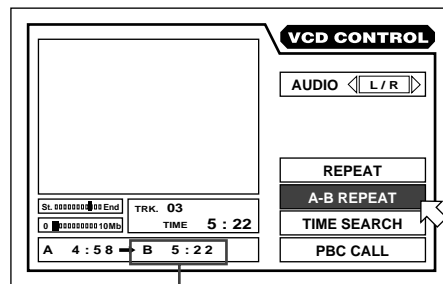

Point B

■ The unit locates "A" and starts repeat playback between "A" and "B."

### NOTES

- **To turn off the on-screen display**

Press .

- **To cancel A-B repeat**

Move to [A-B REPEAT] in the on screen display and press until [A-B REPEAT] returns to its original color.



# Sampling all tracks

You can sample the tracks by listening to a short segment of each track in order. The unit plays the first 10 seconds of each track.



## To playback only the beginning of each track [INTRO]

■ During stop mode

**1** Press .

The on-screen display appears on the TV screen.



When all tracks have been played once, INTRO scan quits.

**2** Use to move to [INTRO].

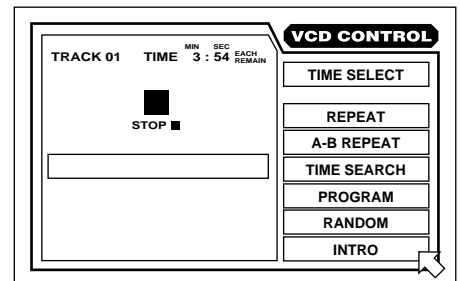

**3** Press .

■ The first 10 seconds of each track on a disc are played back in numerical order from the first track.

### NOTE

- To stop INTRO scan  
Press .

# Adjusting the picture and sound to suit preferences

You can change the picture quality and select the preferred audio channel.



## To adjust the picture quality [VFP]

■ During playback

**1** Press or on the front panel.

**2** Within 10 seconds, select the desired picture quality by pressing or on the front panel.

Each time you press the button, the picture quality changes as follows:

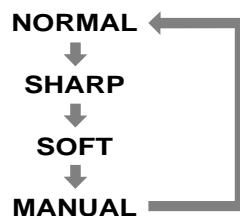

The selected of the picture quality tab lights up in yellow.

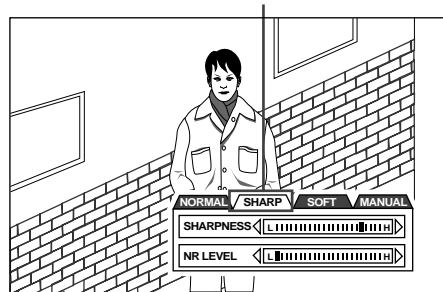

### Hints

If you select [MANUAL], you can adjust the level of sharpness of the picture and noise reduction.

1. Use to select SHARPNESS or NR LEVEL.
2. Use to adjust the level.

### NOTES

- To erase the VFP screen, press .
- The VFP screen disappears if there are no operations for more than 10 seconds.



## To change the audio channel [AUDIO]

In some karaoke discs, one of the audio channels includes a vocal while the other does not. With such discs, you can choose to enjoy karaoke without the vocal or with the vocal by selecting the audio channel to be played back.

### ■ During playback

**1** Press .

The on-screen display appears on the TV screen.

**2** Use to move to [AUDIO].

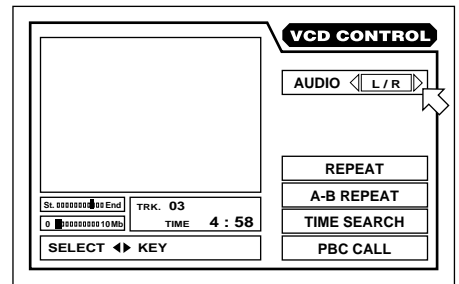

**3** Select the audio channel(s) to be played back using .

**L/R:** You hear normal stereo playback.

**L:** You hear the L (Left) channel signal played back from both the left and right speakers.

**R:** You hear the R (Right) channel signal played back from both the left and right speakers.

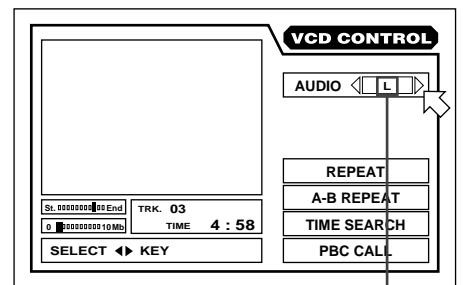

Selected audio channel

### NOTE

- **To turn off the on-screen display**  
Press .

# Checking the total disc time

You can check the total and each time from the on screen display on the TV screen or display window on the front panel.



## To select the time display mode [TIME SELECT]

■ During stop mode

**1** Press .

The on-screen display appears on the TV screen.

**2** Use to move to [TIME SELECT].

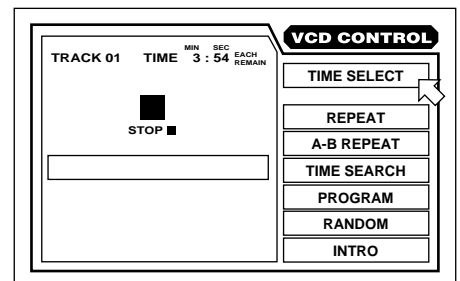

When you press repeatedly until [EACH REMAIN] appears on the TV screen, the recorded time of the displayed track appears on the TV screen. You can change the track by pressing

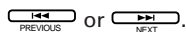

**3** Press until [TOTAL REMAIN] appears on the TV screen.

Total disc time appears on the TV screen.

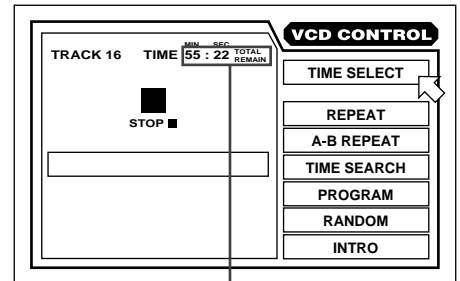

Total disc time of the disc

# Additional information

This chapter explains additional information about the unit such as troubleshooting or how to take care of discs. Read this chapter as necessary.

## Table of contents of this chapter

■ Care and handling of discs .....	90
■ Troubleshooting .....	91
■ AV COMPU LINK remote control system	
Connection and setup .....	92
Operation .....	93
■ Specifications .....	94
■ Table of languages and their abbreviations .....	95

# Care and handling of discs

## How to handle discs

When handling a disc, do not touch the surface of the disc.

Since discs are made of plastic, they are easily damaged. If a disc gets dirty, dusty, scratched or warped, the images and sound will not be picked up correctly, and such a disc may cause the player to malfunction.

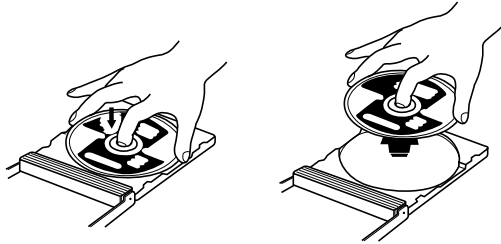

## Even on label side

Do not damage the label side, stick paper to or use any adhesive on its surface.

## Storage

Make sure that discs are kept in their cases. If discs are piled on top of one another without their protective cases, they can be damaged. Do not put discs in a location where they may be exposed to direct sunlight, or in a place where the humidity or temperature is high. Avoid leaving discs in your car!

## Maintenance of discs

If there are fingerprints or other dirt adhering to a disc, wipe with a soft dry cloth, moving from the center outwards. If a disc is difficult to clean, wipe with a cloth moistened with water. Never use record cleaners, petrol, alcohol or any anti-static agents.

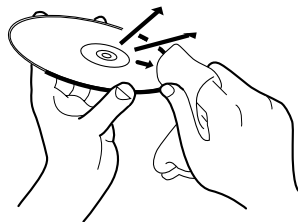

### CAUTION

Sometimes during play noise or images may be garbled. This is sometimes due to the disc. (It may not be up to industry standards.)

These symptoms are caused by the discs, not by the malfunction of the unit.

# Troubleshooting

What appears to be a malfunction may not always be serious. Please go through the following list before requesting service.

Symptom	Possible case	Remedy
Power does not come on.	Power plug is not inserted securely.	Plug in securely.
Remote control does not work.	Too far from the unit.	Come closer to the unit.
	The tip of the remote unit is not pointed in the right direction.	Point the infrared light-emitting window toward the remote sensor on the front panel.
	Batteries are exhausted.	Replace the batteries with new ones.
	Battery polarity is incorrect.	Take out the batteries and insert them again in the correct direction.
No picture is displayed on the monitor.	Connection of video cable is incorrect.	Connect the cable correctly.
	Input selection of TV is incorrect.	Select correctly.
	Disc is not playable.	Use a playable disc. (See page 13.)
Picture is noisy.	The unit is connected to a VCR directly and the copyguard function is activated.	Connect the unit so that the picture signal flow directly to the TV.
No audio is reproduced.	Connection to stereo system is incorrect.	Check connections.
	Input selection of amplifier is incorrect.	Select correctly.
	The unit is connected only using DIGITAL OUT jack.	Connect the unit using AUDIO OUT jack also.
No sound from headphones.	PHONES LEVEL is too low.	Adjust the PHONES LEVEL.
Sound is distorted or noise is generated.	Disc is dirty.	Wipe the disc surface.
Picture is garbled.	The screen saver mode is set to MODE 1, and the screen saver function is activated.	Set the screen saver mode to the other mode.
Picture does not fit with the television screen.	MONITOR TYPE is not correctly set.	Select monitor type correctly. (See page 53).
	Television is not correctly set.	Set the television correctly.
Operation is not possible	Microcomputer malfunctions due to lightning or static electricity.	Turn off the power and unplug the power cord, then connect the power cord again.
	Moisture condensation occurs by a sudden change of temperature or humidity.	Turn off the power, then turn it on a few hours later.

# AV COMPU LINK remote control system

When you buy a separate TV, VCR, DVD player, receiver, or other components and connect them to each other, you have to operate each component individually. JVC's AV COMPU LINK remote control system meets the demand for a system made up of single components and has the ease of operation of a single unit.

## Connection and Setup

- Using the AV COMPU LINK cable, connect the AV COMPU LINK terminals of each component to one another.

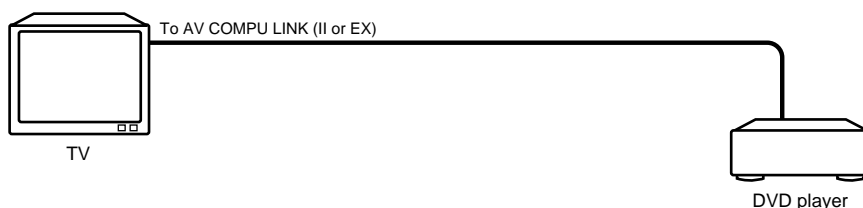

- If you connect a DVD player with a television via AV COMPU LINK, set the DVD player's AV COMPU LINK setting as follows.

- When connecting with VIDEO-1 input terminal of the television: DVD2
- When connecting with VIDEO-2 input terminal of the television: DVD3

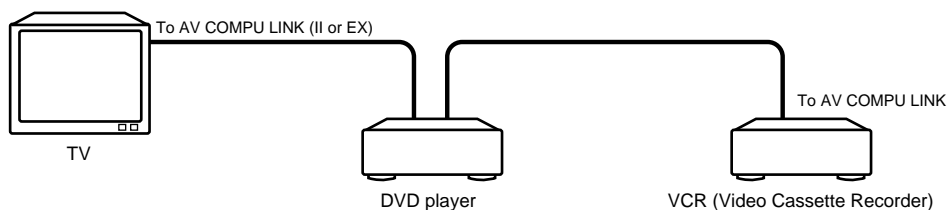

- If you connect a DVD player with a television and VCR via AV COMPU LINK, set the VCR's Remote Control Code and DVD player's AV COMPU LINK setting as follows.

- When connecting with VIDEO-1 input terminal of the television:  
DVD player's AV COMPU LINK setting: DVD2  
VCR's Remote Control Code: B
- When connecting with VIDEO-2 input terminal of the television:  
DVD player's AV COMPU LINK setting: DVD3  
VCR's Remote Control Code: A

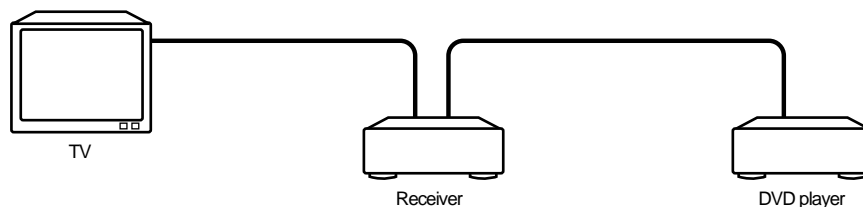

- If you connect a DVD player with a television and receiver via AV COMPU LINK, set the DVD player's AV COMPU LINK setting to DVD1.
- The DVD player's AV COMPU LINK setting is operated in the "PREFERENCE" display. See page 57 for operation.
- About the connection between the TV and the Receiver, refer to Receiver's Instructions.



**Notes for connection**

- If you connect a DVD player with a receiver via AV COMPU LINK in a system including a Dolby digital decoder, some functions may not be performed automatically.
- The AV COMPU LINK terminal on some televisions indicates "II". Do not connect the terminal indicating "II" with the AV COMPU LINK terminal on a receiver. If connected, the system will not work correctly.
- Connect the AUDIO OUT jacks of the DVD player to the audio input jacks of a receiver indicating "DVD". Otherwise, the system will not work correctly.
- There is no description about connections to a DVD player in the instruction manual of a television or VCR. But a television or VCR with AV COMPU LINK terminals indicating "II" or "EX" can be connected to a DVD player.

## Operation

You can enjoy pictures and/or sound by just putting a source component (which plays back the pictures and/or sound such as a DVD player or VCR) into play mode. You do not have to operate the TV and receiver including not having to perform power switching.

**1** Turn on the main power of the television.

**2** Insert a disc into the source component.

**3** Press ► of the source component.

The following actions are performed automatically:

- Turning on the power for the television.
- Setting the source of the television to the external input (VIDEO-1 or VIDEO-2).
- Turning on the power for the receiver.
- Setting the source of the receiver to the component which has just started playback.

# Specifications

## General

Readable discs: DVD VIDEO, Audio CD, Video CD  
 Video format: NTSC color

## Other

Power requirements: AC 120V ~ , 60Hz  
 Power consumption: 26 W (POWER ON), 2 W (STANDBY mode)  
 Mass: 4.5 kg (10.0 lbs)  
 Dimensions (W x H x D): 435 x 112 x 335 mm  
 17-3/16 x 4-7/16 x 13-1/4 inch

## Video output

COMPONENT (pin jack): Y Output: 1.0 Vp-p (75 ohms)  
 PB/PR Output: 0.7 Vp-p (75 ohms)  
 VIDEO OUT (pin jack): 1.0 Vp-p (75 ohms)  
 S-VIDEO OUT (S jack): Y Output: 1.0 Vp-p (75 ohms)  
 C Output: 286 mVp-p (75 ohms)  
 Horizontal resolution: 500 Lines  
 Signal to noise ratio: 65 dB

## Audio output

ANALOG OUT (pin jack): 2.0 Vrms (10 k ohms)  
 DIGITAL OUT (optical): - 21 to -15 dBm (Peak)

## Audio characteristics

Frequency response: CD (sampling frequency 44.1 kHz): 2 Hz to 20 kHz  
 DVD (sampling frequency 48 kHz): 2 Hz to 22 kHz  
 DVD (sampling frequency 96 kHz): 2 Hz to 44 kHz  
 Dynamic range: 16 bit: More than 98 dB  
 20 bit: More than 106 dB  
 24 bit: More than 106 dB  
 Wow and flutter: Unmeasurable (less than  $\pm 0.002\%$ )  
 Total harmonic distortion: Less than 0.002%

\* Specifications and appearance subject to change without prior notice.

# Table of languages and their abbreviations

When you select the subtitle language or sound, the languages shown below are displayed as abbreviations. To select the desired language, select the abbreviation corresponding the language you want to.

AA	Afar
AB	Abkhazian
AF	Afrikaans
AM	Ameharic
AR	Arabic
AS	Assamese
AY	Aymara
AZ	Azerbaijani
BA	Bashkir
BE	Byelorussian
BG	Bulgarian
BH	Bihari
BI	Bislama
BN	Bengali, Bangla
BO	Tibetan
BR	Breton
CA	Catalan
CO	Corsican
CS	Czech
CY	Welsh
DA	Danish
DZ	Bhutani
EL	Greek
EO	Esperanto
ET	Estonian
EU	Basque
FA	Persian
FI	Finnish
FJ	Fiji
FO	Faroese
FY	Frisian
GA	Irish
GD	Scots Gaelic
GL	Galician
GN	Guarani
GU	Gujarati
HA	Hausa
HI	Hindi
HR	Croatian
HU	Hungarian
HY	Armenian
IA	Interlingua
IE	Interlingue

IK	Inupiak
IN	Indonesian
IS	Icelandic
IW	Hebrew
JI	Yiddish
JW	Javanese
KA	Georgian
KK	Kazakh
KL	Greenlandic
KM	Cambodian
KN	Kannada
KO	Korean (KOR)
KS	Kashmiri
KU	Kurdish
KY	Kirghiz
LA	Latin
LN	Lingala
LO	Laothian
LT	Lithuanian
LV	Latvian, Lettish
MG	Malagasy
MI	Maori
MK	Macedonian
ML	Malayalam
MN	Mongolian
MO	Moldavian
MR	Marathi
MS	Malay (MAY)
MT	Maltese
MY	Burmese
NA	Nauru
NE	Nepali
NL	Dutch
NO	Norwegian
OC	Occitan
OM	(Afan) Oromo
OR	Oriya
PA	Panjabi
PL	Polish
PS	Pashto, Pushto
PT	Portuguese
QU	Quechua
RM	Rhaeto-Romance

RN	Kirundi
RO	Rumanian
RU	Russian
RW	Kinyarwanda
SA	Sanskrit
SD	Sindhi
SG	Sangho
SH	Serbo-Croatian
SI	Singhalese
SK	Slovak
SL	Slovenian
SM	Samoan
SN	Shona
SO	Somali
SQ	Albanian
SR	Serbian
SS	Siswati
ST	Sesotho
SU	Sundanese
SV	Swedish
SW	Swahili
TA	Tamil
TE	Telugu
TG	Tajik
TH	Thai
TI	Tigrinya
TK	Turkmen
TL	Tagalog
TN	Setswana
TO	Tonga
TR	Turkish
TS	Tsonga
TT	Tatar
TW	Twi
UK	Ukrainian
UR	Urdu
UZ	Uzbek
VI	Vietnamese
VO	Volapuk
WO	Wolof
XH	Xhosa
YO	Yoruba
ZU	Zulu

# Country code list for parental lock

This list is used for the parental Lock operation. For details, see page 58.

AD	Andorra
AE	United Arab Emirates
AF	Afghanistan
AG	Antigua and Barbuda
AI	Anguilla
AL	Albania
AM	Armenia
AN	Netherlands Antilles
AO	Angola
AQ	Antarctica
AR	Argentina
AS	American Samoa
AT	Austria
AU	Australia
AW	Aruba
AZ	Azerbaijan
BA	Bosnia and Herzegovina
BB	Barbados
BD	Bangladesh
BE	Belgium
BF	Burkina Faso
BG	Bulgaria
BH	Bahrain
BI	Burundi
BJ	Benin
BM	Bermuda
BN	Brunei Darussalam
BO	Bolivia
BR	Brazil
BS	Bahamas
BT	Bhutan
BV	Bouvet Island
BW	Botswana
BY	Belarus
BZ	Belize
CA	Canada
CC	Cocos (Keeling) Islands
CF	Central African Republic
CG	Congo
CH	Switzerland
CI	Côte d'Ivoire
CK	Cook Islands
CL	Chile

CM	Cameroon
CN	China
CO	Colombia
CR	Costa Rica
CU	Cuba
CV	Cape Verde
CX	Christmas Island
CY	Cyprus
CZ	Czech Republic
DE	Germany
DJ	Djibouti
DK	Denmark
DM	Dominica
DO	Dominican Republic
DZ	Algeria
EC	Ecuador
EE	Estonia
EG	Egypt
EH	Western Sahara
ER	Eritrea
ES	Spain
ET	Ethiopia
FI	Finland
FJ	Fiji
FK	Falkland Islands (Malvinas)
FM	Micronesia (Federated States of)
FO	Faroe Islands
FR	France
FX	France, Metropolitan
GA	Gabon
GB	United Kingdom
GD	Grenada
GE	Georgia
GF	French Guiana
GH	Ghana
GI	Gibraltar
GL	Greenland
GM	Gambia
GN	Guinea
GP	Guadeloupe
GQ	Equatorial Guinea

GR	Greece
GS	South Georgia and the South Sandwich Islands
GT	Guatemala
GU	Guam
GW	Guinea-Bissau
GY	Guyana
HK	Hong Kong
HM	Heard Island and McDonald Islands
HN	Honduras
HR	Croatia
HT	Haiti
HU	Hungary
ID	Indonesia
IE	Ireland
IL	Israel
IN	India
IO	British Indian Ocean Territory
IQ	Iraq
IR	Iran (Islamic Republic of)
IS	Iceland
IT	Italy
JM	Jamaica
JO	Jordan
JP	Japan
KE	Kenya
KG	Kyrgyzstan
KH	Cambodia
KI	Kiribati
KM	Comoros
KN	Saint Kitts and Nevis
KP	Korea, Democratic People's Republic of
KR	Korea, Republic of
KW	Kuwait
KY	Cayman Islands
KZ	Kazakhstan
LA	Lao People's Democratic Republic
LB	Lebanon
LC	Saint Lucia

LI	Liechtenstein
LK	Sri Lanka
LR	Liberia
LS	Lesotho
LT	Lithuania
LU	Luxembourg
LV	Latvia
LY	Libyan Arab Jamahiriya
MA	Morocco
MC	Monaco
MD	Moldova, Republic of
MG	Madagascar
MH	Marshall Islands
ML	Mali
MM	Myanmar
MN	Mongolia
MO	Macau
MP	Northern Mariana Islands
MQ	Martinique
MR	Mauritania
MS	Montserrat
MT	Malta
MU	Mauritius
MV	Maldives
MW	Malawi
MX	Mexico
MY	Malaysia
MZ	Mozambique
NA	Namibia
NC	New Caledonia
NE	Niger
NF	Norfolk Island
NG	Nigeria
NI	Nicaragua
NL	Netherlands
NO	Norway
NP	Nepal
NR	Nauru
NU	Niue
NZ	New Zealand
OM	Oman
PA	Panama

PE	Peru
PF	French Polynesia
PG	Papua New Guinea
PH	Philippines
PK	Pakistan
PL	Poland
PM	Saint Pierre and Miquelon
PN	Pitcairn
PR	Puerto Rico
PT	Portugal
PW	Palau
PY	Paraguay
QA	Qatar
RE	Réunion
RO	Romania
RU	Russian Federation
RW	Rwanda
SA	Saudi Arabia
SB	Solomon Islands
SC	Seychelles
SD	Sudan
SE	Sweden
SG	Singapore
SH	Saint Helena
SI	Slovenia
SJ	Svalbard and Jan Mayen
SK	Slovakia
SL	Sierra Leone
SM	San Marino
SN	Senegal
SO	Somalia
SR	Suriname
ST	Sao Tome and Principe
SV	El Salvador
SY	Syrian Arab Republic
SZ	Swaziland
TC	Turks and Caicos Islands
TD	Chad
TF	French Southern Territories
TG	Togo
TH	Thailand

TJ	Tajikistan
TK	Tokelau
TM	Turkmenistan
TN	Tunisia
TO	Tonga
TP	East Timor
TR	Turkey
TT	Trinidad and Tobago
TV	Tuvalu
TW	Taiwan, Province of China
TZ	Tanzania, United Republic of
UA	Ukraine
UG	Uganda
UM	United States Minor Outlying Islands
US	United States
UY	Uruguay
UZ	Uzbekistan
VA	Vatican City State (Holy See)
VC	Saint Vincent and the Grenadines
VE	Venezuela
VG	Virgin Islands (British)
VI	Virgin Islands (U.S.)
VN	Viet Nam
VU	Vanuatu
WF	Wallis and Futuna Islands
WS	Samoa
YE	Yemen
YT	Mayotte
YU	Yugoslavia
ZA	South Africa
ZM	Zambia
ZR	Zaire
ZW	Zimbabwe

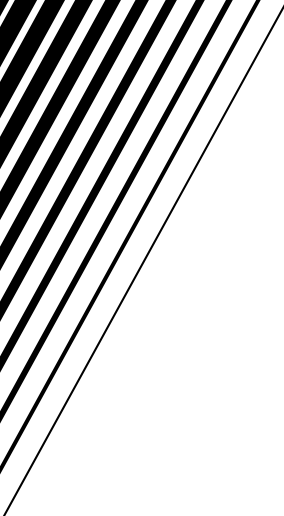

**JVC**  
VICTOR COMPANY OF JAPAN, LIMITED

## Free Manuals Download Website

<http://myh66.com>

<http://usermanuals.us>

<http://www.somanuals.com>

<http://www.4manuals.cc>

<http://www.manual-lib.com>

<http://www.404manual.com>

<http://www.luxmanual.com>

<http://aubethermostatmanual.com>

Golf course search by state

<http://golfingnear.com>

Email search by domain

<http://emailbydomain.com>

Auto manuals search

<http://auto.somanuals.com>

TV manuals search

<http://tv.somanuals.com>