

JVC



DVD PLAYER

XV-515GD

Introduction	1
Preliminary knowledge	4
Getting started	12
Basic operations	17
Advanced operations	20
Setting and adjustment	34
Additional information	39

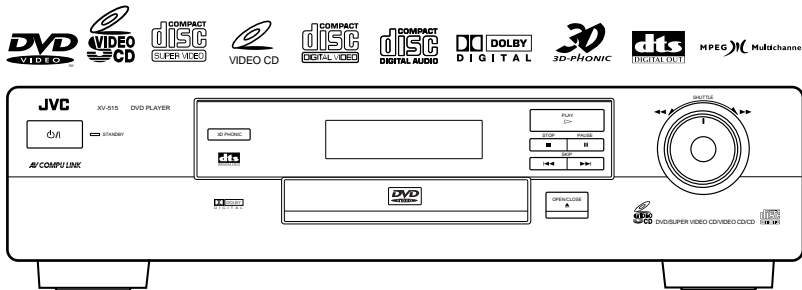
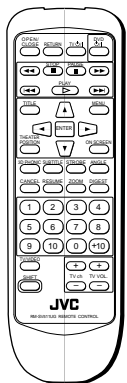

INSTRUCTIONS

For Customer Use:

Enter below the Model No. and Serial No. which are located on the rear, bottom or side of the cabinet. Retain this information for future reference.

Model No. _____

Serial No. _____

LVT0336-014A
[UX, 3U, 4U, US, A, UT, UB]

Warnings, Cautions and Others

CAUTION

To reduce the risk of electrical shocks, fire, etc.:

1. Do not remove screws, covers or cabinet.
2. Do not expose this appliance to rain or moisture.

Caution — button!

Disconnect the mains plug to shut the power off completely. The  button in any position does not disconnect the mains line. The power can be remote controlled.

IMPORTANT FOR LASER PRODUCTS

REPRODUCTION OF LABELS

① CLASSIFICATION LABEL, PLACED ON REAR ENCLOSURE

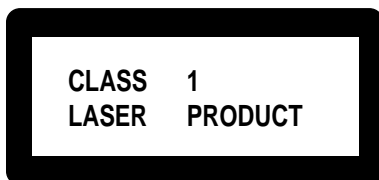

② WARNING LABEL, PLACED INSIDE THE UNIT

CAUTION	-LASER RADIATION WHEN OPEN. DO NOT STARE INTO BEAM.
ATTENTION	- RAYONNEMENT LASER EN CAS D'OUVERTURE. NE PAS REGARDER DANS LE FAISCEAU.
VORSICHT	-LASERSTRAHLUNG, WENN ABDECKUNG GEÖFFNET. NICHT IN DEN STRAHL BLICKEN.
ADVARSEL	-LASERSTRÅLING VED ÅBNING. SE IKKE IND I STRÅLEN.
ADVARSEL	-LASERSTRÅLING NÅR DEKSEL ÅPNES. STIRR IKKE INN I STRÅLEN.
VARNING	-LASERSTRÅLNING NÅR DENNA DEL ÄR ÖPPNAD. STRÅRA EJ IN I STRÅLEN.
VARO!	-AVATTAESSA OLET ALTTIINA LASERSATEILYLLE. ÄLÄ TUJOTA SÄTEESEEN.
注意	- 当打开这里会出现激光, 请不要直视激光。
注意	- ここを開くとレーザー光が出ます。 レーザー光をのぞきまなしないでください。

1. CLASS 1 LASER PRODUCT
2. **DANGER:**Visible laser radiation when open and interlock failed or defeated. Avoid direct exposure to beam.
3. **CAUTION:** Do not open the top cover. There are no user serviceable parts inside the Unit; leave all servicing to qualified service personnel.

Caution: Proper Ventilation

To avoid risk of electric shock and fire and to protect from damage.

Locate the apparatus as follows:

- Front: No obstructions open spacing.
Sides: No obstructions in 3 cm from the sides.
Top: No obstructions in 5 cm from the top.
Back: No obstructions in 15 cm from the back
Bottom: No obstructions, place on the level surface.

Features

Picture functions

- **Strobe function**
The unit can display nine continuous still pictures on the TV screen.
- **Digest function**
You can select the desired title from the opening scenes displayed on the TV screen.
- **Angle function***
You can select a desired angle from multiple camera angles recorded on the DVD disc.
- **Zoom function**
You can view scenes close-up.
- **Parental lock***
You can restrict the playback of DVD discs with scenes which you do not want your child to see, such as adult or violent films.
- **Theater position**
You can select the picture character according to the lighting of your room.

Audio functions

- **High quality digital sound**
You can enjoy high quality sound with Dolby Digital, MPEG Audio or Linear-PCM.
- **Surround function***
The unit is compatible with Dolby Digital surround, DTS surround and MPEG Multichannel. (DTS surround and MPEG multichannel are available for digital output only.)
- **3D Phonic function**
You can enjoy surround sound with your 2-channel system.

Other functions

- **Multi-language subtitles and sound***
You can select a subtitle or sound language from those recorded on the DVD disc.
- **Multi-disc playback**
You can enjoy Audio CD, Video CD and SVCD discs, as well as DVD discs.
- **Operation from the on-screen display**
User-friendly on-screen displays allow you to operate the unit easily.

Functions with (*) mark only work on a DVD disc that is compatible with each function.

Supplied accessories

- Audio/video cable (x 1)

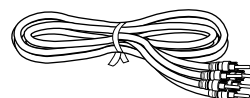

- S-video cable (x 1)



- AV compulink cord (x 1)

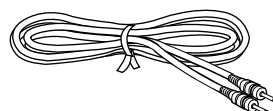

- Remote Control Unit (x 1)

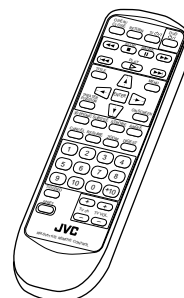

- R6P(SUM-3)/AA(15F) batteries (x 2)

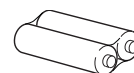

- Instruction manual (x 1)

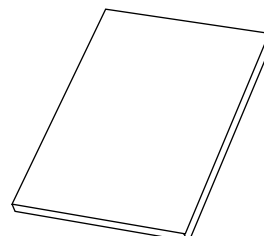

About this instruction manual

This instruction manual basically explains operations as follows:

To display still pictures [STROBE]

DVD

Video CD

Super VCD

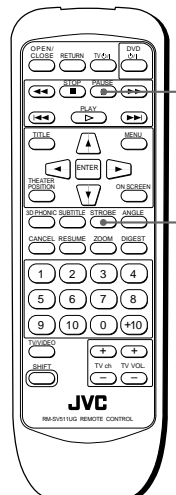









■ During playback

1 At the point you want to view as continuous photographs, press **PAUSE**.

The unit pauses playback.

2 Press **STROBE**.

Nine continuous still pictures appear on the TV screen.

Hints

- Pressing **PAUSE** when the nine still pictures appear advances to the next nine still pictures.
- To cancel strobe play
Press **STROBE**.

NOTES

- Pressing and holding **PAUSE** for more than 1 second also activates the Strobe function.
- If you press **STROBE** during playback, nine still pictures also appear but they advance in realtime.

The number indicates the procedural step.

These symbols indicate the types of discs which the operation can be used for.

The number indicates the following procedural step(s) in which the button(s) is(are) used. You may also use the corresponding buttons on the front panel of the unit if available.

Other convenient procedures, etc.

The names of buttons on the remote control unit (or on the front panel of the unit) are all given in uppercase letters.

Additional supplemental remarks

Notes on handling

Important cautions

Installation of the unit

- Select a place which is level, dry and neither too hot nor too cold (between 5°C and 35°C, 41°F and 95°F).
- Leave sufficient distance between the unit and the TV.
- Do not use the player in a place subject to vibrations.

Power cord

- Do not handle the power cord with wet hands!
- A small amount of power (2 watts) is always consumed while the power cord is connected to the wall outlet.
- When unplugging the player from the wall outlet, always pull the plug, not the power cord.

To prevent malfunction of the unit

- There are no user-serviceable parts inside. If anything goes wrong, unplug the power cord and consult your dealer.
- Do not insert any metallic object into the unit.
- Do not use any non-standard shape disc available on the market, because it may damage the unit.
- Do not use a disc with tape, seals, or paste on it, because damage to the unit may result.

Note about copyright laws

- Please check the copyright laws in your country before recording from DVD VIDEO, Audio CD, Video CD and SVCD discs. Recording of copyrighted material may infringe copyright laws.

Note about the copyguard system

- The DVD VIDEO disc is protected by the copyguard system. When you connect the unit to your VCR directly, the copyguard system activates and the picture may not be played back correctly.

Safety precautions

Avoid moisture, water and dust

Do not place your player in moist or dusty places.

Avoid high temperatures

Do not expose the unit to direct sunlight or place it near a heating device.

When you're away

When away on travel or otherwise for an extended period of time, remove the plug from the wall outlet.

Do not insert foreign objects into the unit

Do not insert wires, hairpins, coins, etc. into the unit.

Do not block the vents

Blocking the vents may damage the unit.

Care of the cabinet

When cleaning the unit, use a soft cloth and follow the relevant instructions on the use of chemically-coated cloths. Do not use benzene, thinner or other organic solvents and disinfectants. These may cause deformation or discoloring.

If water gets inside the unit

Turn off the power switch and remove the plug from the wall outlet, then call the store where you made your purchase. Using the unit in this state may cause a fire or electrical shock.

This product incorporates copyright protection technology that is protected by method claims of certain U.S. patents and other intellectual property rights owned by Macrovision Corporation and other rights owners. Use of this copyright protection technology must be authorized by Macrovision Corporation, and is intended for home and other limited viewing uses only unless otherwise authorized by Macrovision Corporation. Reverse engineering or disassembly is prohibited.

Manufactured under license from Dolby Laboratories. "Dolby" and double-D symbol are trademarks of Dolby Laboratories.

Confidential Unpublished Works.

© 1992-1997 Dolby Laboratories, Inc. All rights reserved.

Manufactured under license from Digital Theater Systems, Inc. US Pat. No. 5,451,942 and other world-wide patents issued and pending. "DTS", "DTS Digital Surround", are trademarks of Digital Theater System, Inc.

© 1996 Digital Theater Systems, Inc. All Rights Reserved.

Names of parts and controls

Refer to the corresponding pages indicated in () for details.

Front panel

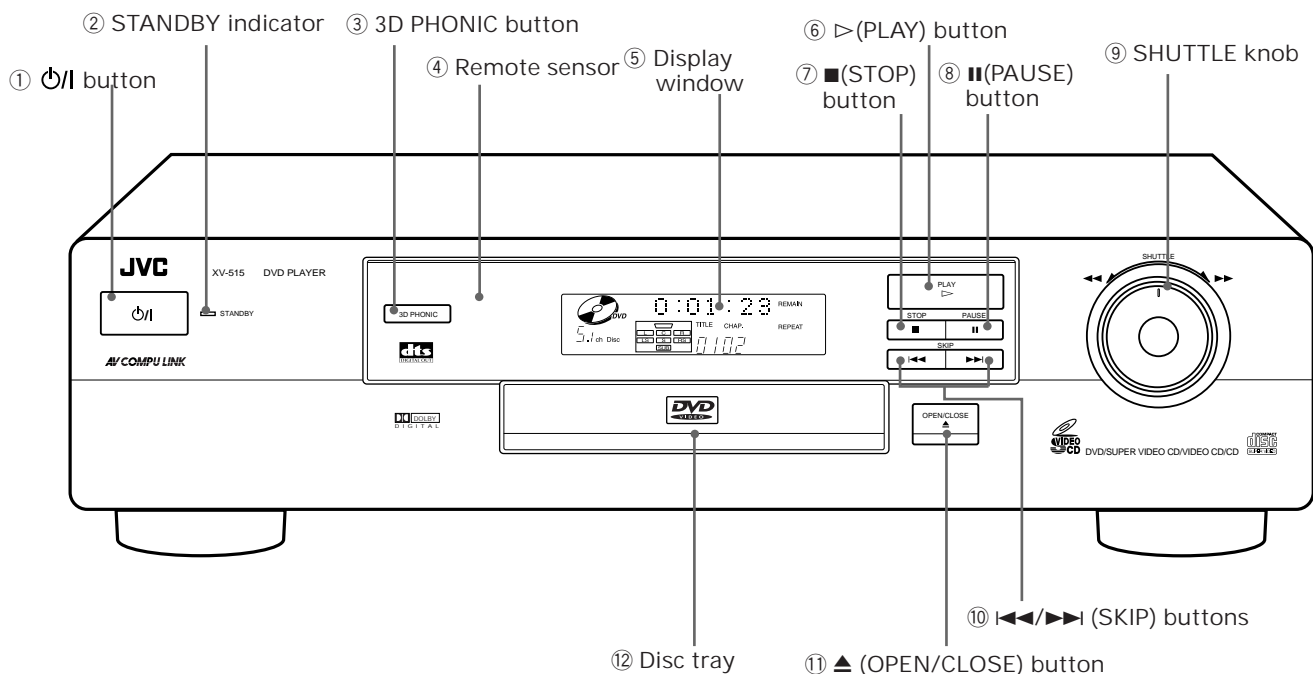

- | | |
|--|---|
| <p>① ⏻/⏻ button (17)
Turns the unit on or off (standby).</p> <p>② STANDBY indicator
Lights when the power cord is connected and the unit is on standby. When the unit is turned on, the STANDBY indicator goes off.</p> <p>③ 3D PHONIC button (32)
Produces a simulated surround effect.</p> <p>④ Remote sensor
Receives the signal from the remote control unit.</p> <p>⑤ Display window
Indicates the current status of the unit.</p> <p>⑥ ▶ (PLAY) button (18)
Starts playback. Also, used as a SELECT button for PBC of Video CDs.</p> | <p>⑦ ■ (STOP) button (18)
Stops playback.</p> <p>⑧ ⏸ (PAUSE) button (18)
Pauses playback.</p> <p>⑨ SHUTTLE knob (18)
Performs rapid advance/reverse playback operations. Also used for slow-motion playback of a picture (for DVD/SVCD/Video CD).</p> <p>⑩ ⏮/⏭ (SKIP) buttons (19)
Perform skipping a chapter, title or track. Also used for the page selection of a menu screen (for DVD).</p> <p>⑪ ⏏ (OPEN/CLOSE) button (17)
Opens and closes the disc tray.</p> <p>⑫ Disc tray (17)
Used to load discs.</p> |
|--|---|

Display window

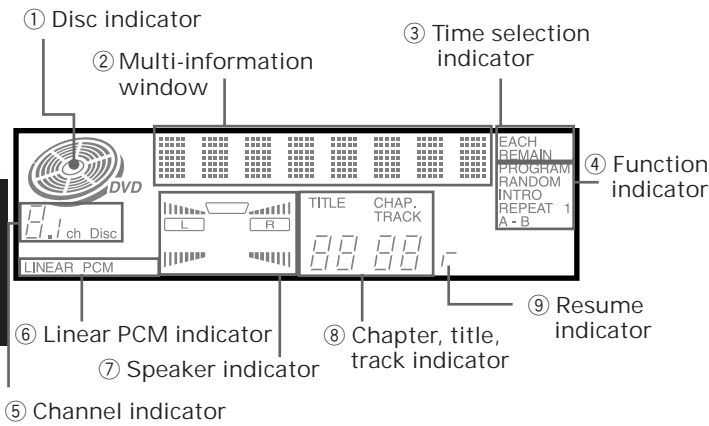

- ① Disc indicator
Lights when a disc is in the unit. "DVD" also appears when a DVD disc is in the unit.
- ② Multi-information window
Displays time and status information.
- ③ Time selection indicator
Shows what the time information in the Multi-information window means.
- ④ Function indicator
Activated function indicators light up.
- ⑤ Channel indicator
Displays number of channels in the currently selected audio playback format.
- ⑥ Linear PCM indicator
Lights only when the playback disc contains linear PCM data. This indicator also lights while an Audio CD is placed in the unit.
- ⑦ Speaker indicator
Lights during disc playback. lights when signals are output from the video output jacks. When the 3D PHONIC function is ON, also lights.
- ⑧ Chapter, title, track indicator
Displays chapter, title, or track number.
- ⑨ Resume indicator
Lights when the "RESUME" position is stored.

Rear panel

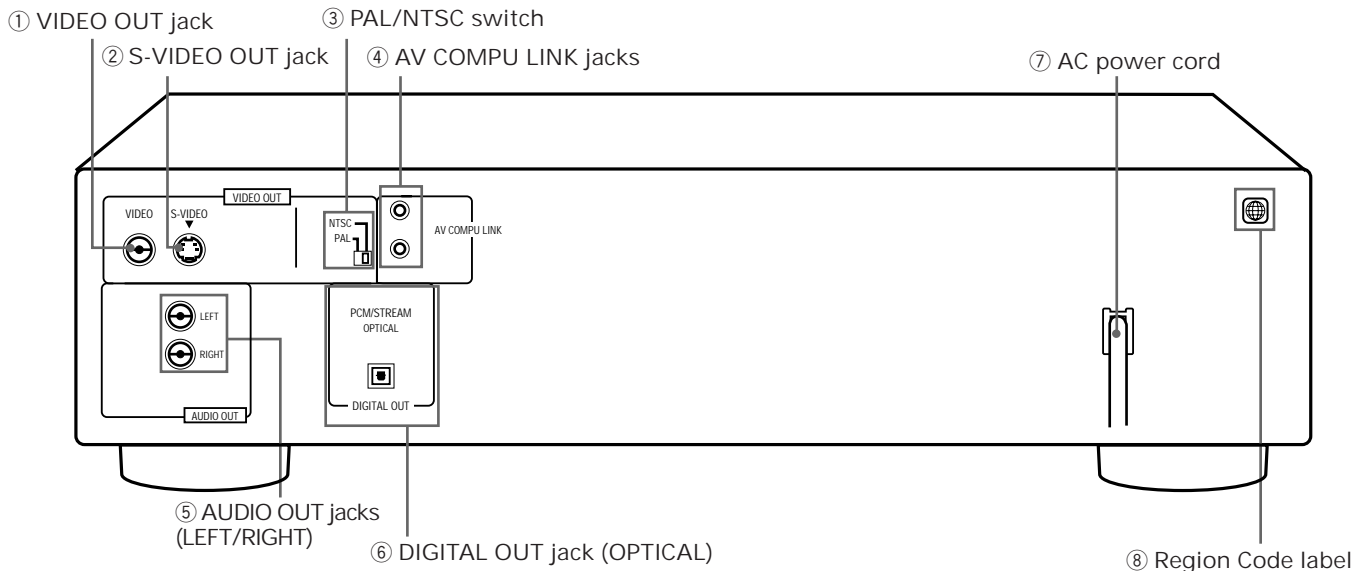

- ① VIDEO OUT jack (12)
Outputs a composite video signal.
- ② S-VIDEO OUT jack (12)
Outputs an S-video signal.
- ③ PAL/NTSC switch (12)
Selects PAL or NTSC according to the color system of your TV.
- ④ AV COMPU LINK jacks (39)
Connects with other JVC equipment supporting the AV Compulink function to facilitate integrated operations.
- ⑤ AUDIO OUT jacks (LEFT/RIGHT) (12)
Output stereo analog audio signals.
- ⑥ DIGITAL OUT jack (OPTICAL) (13)
Output digital audio signals. Only an optical connector is provided.
- ⑦ AC power cord (14)
Connects to the wall outlet.
- ⑧ Region Code label (11)
Shows Region Code number.

Remote control unit

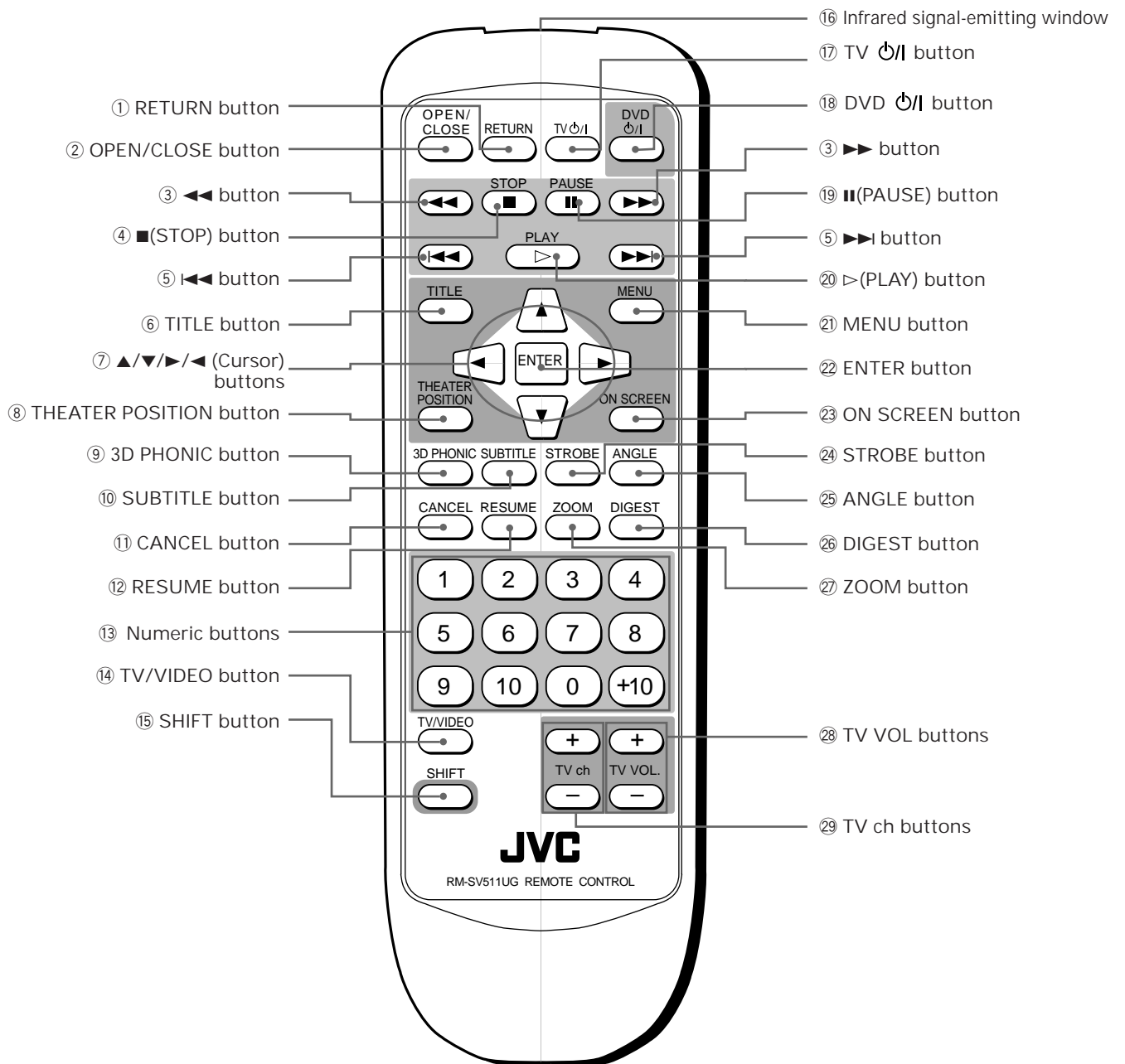

Preliminary Knowledge

- ① RETURN button (for DVD/Video CD/SVCD) (20)
Returns to the previous menu.
- ② OPEN/CLOSE button (17)
Opens and closes the disc tray.
- ③ ◀▶ buttons (18)
Perform rapid advance/reverse playback operations.
Also used for slow-motion playback of a picture (for DVD/Video CD/SVCD).
- ④ ■ (STOP) button (18)
Stops playback.
Also used to erase all the programmed tracks for the program play (for Audio CD/Video CD/SVCD).
- ⑤ ◀▶▶▶ buttons (19)
Perform skipping a chapter, title or track.
Also used for the page selection of a menu screen (for DVD/Video CD/SVCD).
- ⑥ TITLE button (20)
Displays a title menu of DVD on the TV screen or monitor.
- ⑦ ▲/▼/▶/◀ (Cursor) buttons
Used to select an item from a menu or on-screen display, or to change the setting of an item in the on-screen display, etc.
- ⑧ THEATER POSITION button (32)
Selects a picture character from 4 settings.
- ⑨ 3D PHONIC button (32)
Produces a simulated surround effect.
- ⑩ SUBTITLE button (for DVD/SVCD) (30)
Turns subtitles on or off.
- ⑪ CANCEL button (26)
Cancels the previous settings.
- ⑫ RESUME button (19)
Stores the location to resume playback from later.
- ⑬ Numeric buttons (10)
Mainly used to select a title/track number, or a TV channel.
Also used to enter a time for the Time search and a chapter number for the Chapter search.
- ⑭ TV/VIDEO button (16)
Switches the TV input mode.
- ⑮ SHIFT button (16)
When pressing and holding this button, the numeric keys (0 - 9) select the TV channels. Also used to display the PARENTAL LOCK display.
- ⑯ Infrared signal-emitting window
Point this window toward the remote sensor on the front panel when pressing buttons.
- ⑰ TV ⏻ button (16)
Turns the TV on or off.
- ⑱ DVD ⏻ button (17)
Turns the unit on or off (standby).
- ⑲ || (PAUSE) button (18)
Pauses playback.
- ⑳ ▷ (PLAY) button (18)
Starts playback.
Also used as a SELECT button for PBC of Video CDs/SVCDs.
- ㉑ MENU button (for DVD) (20)
Displays a DVD menu on the TV screen or monitor.
- ㉒ ENTER button
Executes the selected item in a menu or on-screen display when pressing the button.
- ㉓ ON SCREEN button (8)
Displays an on-screen display of the unit on the TV screen or monitor.
- ㉔ STROBE button (for DVD/Video CD/SVCD) (24)
Displays nine continuous still pictures.
- ㉕ ANGLE button (for DVD) (29)
Changes camera angles during playback of a DVD containing multiple camera angles.
- ㉖ DIGEST button (for DVD/Video CD/SVCD) (23)
Displays beginning scenes of each title, chapter, or track on the TV screen.
- ㉗ ZOOM button (for DVD/Video CD/SVCD) (25)
Zoom-in for a close-up view of the scene.
- ㉘ TV VOL buttons (16)
Adjust the TV volume.
- ㉙ TV ch buttons (16)
Change the TV channels.

Operational Principles

On-screen displays

The unit provides several on-screen displays as shown below for choosing preferences for initial settings and functions which are not frequently used.

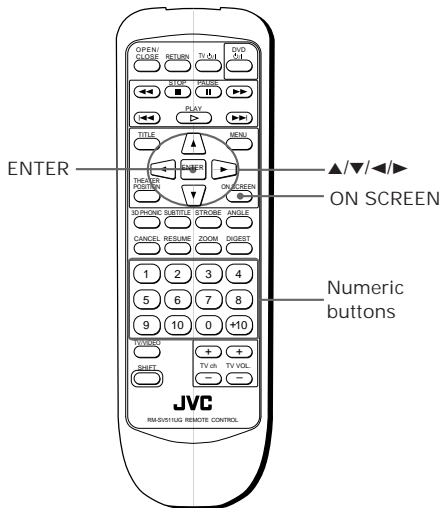

To access on-screen displays

Press ON SCREEN. (Note that operation for accessing the "PARENTAL LOCK" on-screen display is different.) Depending on the type of disc inserted (or "no disc") and the unit's mode, "the" proper on-screen display is accessed.

Basic operations in on-screen displays

- A cursor appears at the on-screen display. You can move the cursor using ▲/▼/▶/◀ cursor buttons to select items you want to work with.
- With an item like **1/3**, you can change the setting by using the ◀▶ cursor buttons when the cursor is on the item.
- **REPEAT** - type item works when you place the cursor on the item and press ENTER.
- In the message box, the operation to be performed is displayed according to the item pointed by the cursor.
- Numbers are entered using the numeric buttons.
- Some functions become effective by pressing ENTER after specifying necessary entries.
- Pressing ON SCREEN again exits the on-screen display.

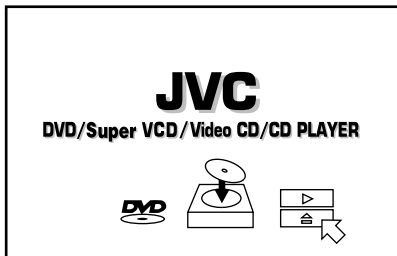

Opening display

An opening display appears automatically (without pressing the ON SCREEN button) in some conditions.

The display shown on the left appears when the unit turns on with no disc inserted.

One of the similar displays shown below appears when a corresponding disc is set and stopped. For an Audio CD, the opening display does not disappear even during playback.

for DVD

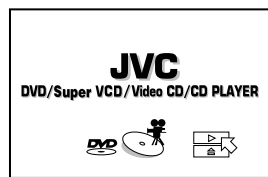

for Audio CD

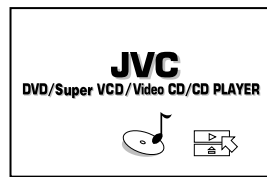

for Video CD/SVCD

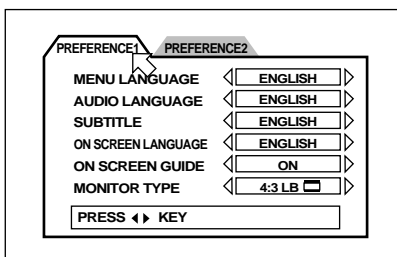
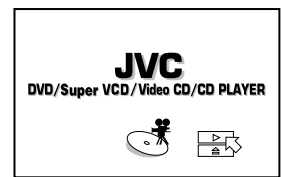

PREFERENCE (1, 2) displays (see page 34)

You can set preferences on these displays.

To display the PREFERENCE display

When a DVD disc is set and stopped or no disc is inserted, press ON SCREEN.

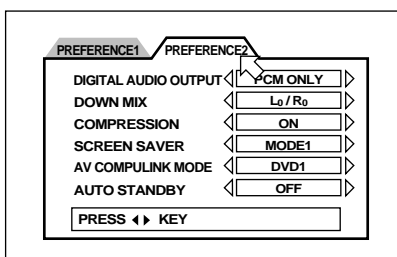

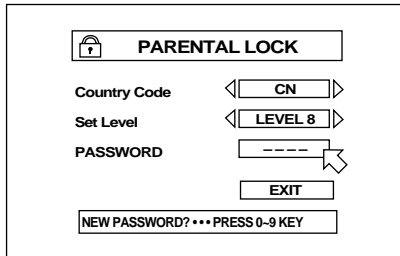

PARENTAL LOCK display (see page 37)

You can set the parental lock from this display.

To display the PARENTAL LOCK display

Press ENTER while holding down SHIFT.

The Parental Lock on-screen display appears on the TV screen.

(for DVD)

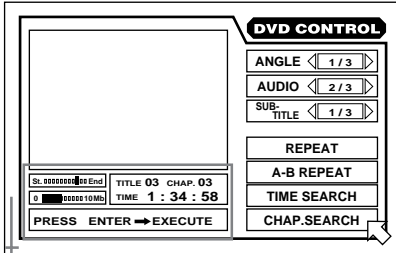

DVD CONTROL display

You can select and set various functions for DVD playback from this display. This display appears only during DVD playback.

To display the DVD CONTROL display

During DVD playback, press ON SCREEN.

Current relative position of the title (St: start, End: end) Current title number Current chapter number



Transmission rate Elapsed time from the beginning of the current title

(for Audio CD)

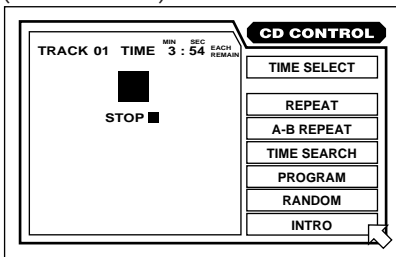

CD CONTROL display

You can select and set various functions for Audio CD playback from this display.

To display the CD CONTROL display

Whenever an Audio CD is inserted, press ON SCREEN.

(for Video CD)

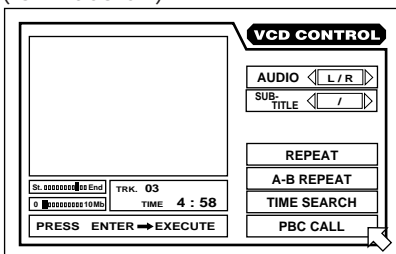

VCD CONTROL display (for Video CD and SVCD)

When a Video CD or SVCD disc is stopped, a display similar to the CD CONTROL display shown above appears.

During Video CD playback, the display shown on the left appears. During SVCD playback, the display shown on the left-bottom appears.

To display the VCD CONTROL display

When a Video CD is inserted, press ON SCREEN.

(for SVCD)

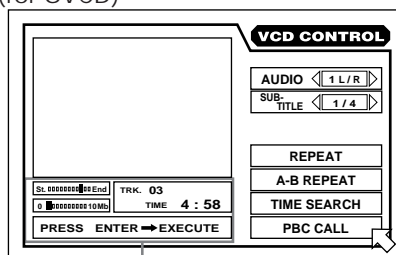

Current relative position of the track (St: start, End: end) Current track number



Transmission rate Elapsed time from the beginning of the current track

To prevent the monitor from burning out [SCREEN SAVER]

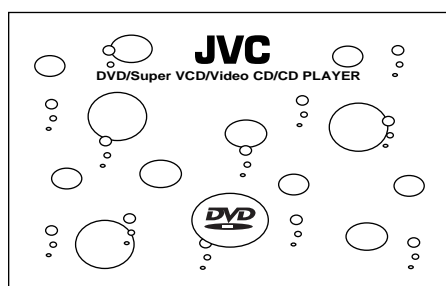

A television monitor screen may be burned out if a static picture is displayed for a long time. To prevent this, the unit automatically activates the screen saver function if a static picture, such as an on-screen display or menu, is displayed for over 5 minutes.

- Pressing any button on the unit or the remote control unit will release the screen saver function and return to the previous display.
- You can select one of several screen saver modes available (see page 36).

On-screen guide icons

During DVD playback, you may see icons displayed over the picture. These have the following meanings.



: Displayed at the beginning of a scene recorded from multiple angles. (See page 29.)





: Displayed at the beginning of a scene recorded with multiple audio languages. (See page 31.)



: Displayed at the beginning of a scene recorded with multiple subtitle languages. (See page 30.)

You can set the unit not to display on-screen icons above via the preference settings described on page 35.

About invalid operation icon

When you press a button, if the unit does not accept its operation,  appears on your television screen. Operations are occasionally unacceptable even if  is not displayed.

Note that some operations may not be accepted. For example, some discs may not allow rapid advance/reverse or slow-motion playback.

How to use numeric buttons

To select a track/title number

- To select a number between 1 and 10
Press the corresponding button for the number.
- To select a number higher than 10
Use the +10 button.

Examples:

To select 13 +10 → 3

To select 34 +10 → +10 → +10 → 4

To select 40 +10 → +10 → +10 → 10

To enter a time or chapter number

The method for entering a time for Time search or chapter number for Chapter search is different from above. See the corresponding sections in this manual for the details.

To select a TV channel.







Press the corresponding numeric buttons (between 0 and 9) while holding down the SHIFT button.

About discs

Playable disc types

Playable and non-playable disc types are as follows:

Playable discs

DVD VIDEO 	Video CD  	SVCD  	Audio CD 
--	---	--	---

The DVD Logo is a trademark.

- DVD players and DVD discs have their own Region Code numbers. This unit only can play back DVD discs whose Region Code numbers include the unit's Region Code, which is indicated on the region code symbol on the rear panel.

Examples of playable DVD discs if the unit's Region Code is "2":



Non-playable discs

DVD-ROM, DVD-RAM, DVD Audio, DVD-R, DVD-RW, CD-R, CD-ROM, PHOTO CD, CD-RW, CD-EXTRA, CD-G, CD-TEXT

- Playing back discs listed as "Non-playable discs" in the table above may generate noise and damage speakers.
- This unit can play back audio recorded in CD-G, CD-EXTRA and CD-TEXT discs.

NOTE

- With some DVD and Video CD discs, you may not be able to control them according to the instructions described in this manual, because of the contents of the disc.

Disc structure

A DVD disc is comprised of "titles," while an Audio CD, Video CD or SVCD is comprised of "tracks." Each title may be divided into some "chapters." For example, if a DVD disc contains some movies, each movie may have its own title number, and each movie may be divided into some chapters. In a DVD karaoke disc, each song usually has its own title number and does not have chapters. In general, each title has independent content, while each chapter in the same title has continuity.

(Example: DVD disc)

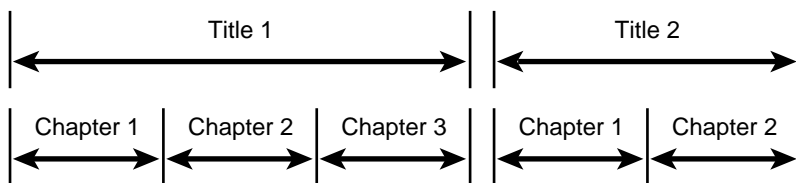

(Example: Audio CD/Video CD/SVCD)

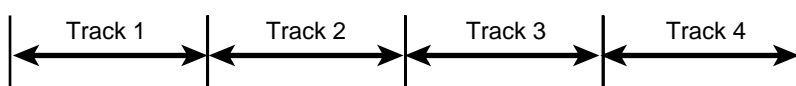

Connections

*In the following description, "TV" may be substituted with "monitor" or "projector."

*Before using the unit, you have to connect the unit to a TV and/or amplifier.

Before making any connections

- Do not connect the AC power cord until all other connections have been made.
- Since different components often have different terminal names, carefully read the instructions supplied with the component you are going to connect.

To connect to a TV

You can enjoy using the unit by simply connecting it to a TV. To improve audio sound quality, connect the audio outputs to your separate audio equipment. (See the following pages.)

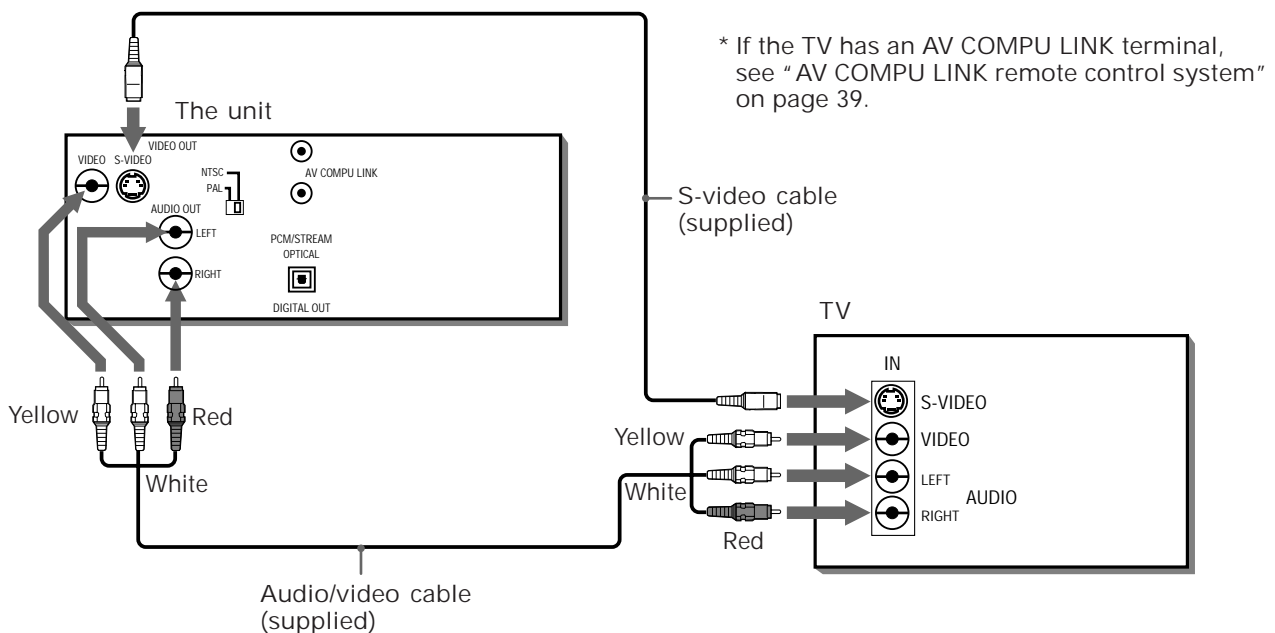

Connect the unit to a TV equipped with stereo audio input and video input jacks using the supplied audio/video cables.

- If your TV has a monaural audio input instead of stereo, you need to use an optional audio cable which converts stereo audio output to monaural.
- If your TV has an S-video input, you should connect it with the S-VIDEO output of the unit using the supplied S-video cable in addition to the (standard) video connection to get better picture quality.

The unit is compatible with the PAL and NTSC color systems. Set the PAL/NTSC switch on the rear panel to match the color system of your TV. Make sure that the color system of the DVD/Video CD/SVCD disc labeled on the package matches your TV.

NOTE

- Connect VIDEO OUT of the unit directly to the video input of your TV. Connecting VIDEO OUT of the unit to a TV via a VCR may cause a monitor problem when playing back a copy-protected disc.

To connect to an audio amplifier or receiver

You can enjoy high-quality audio by connecting the unit's audio output to your amplifier or receiver.

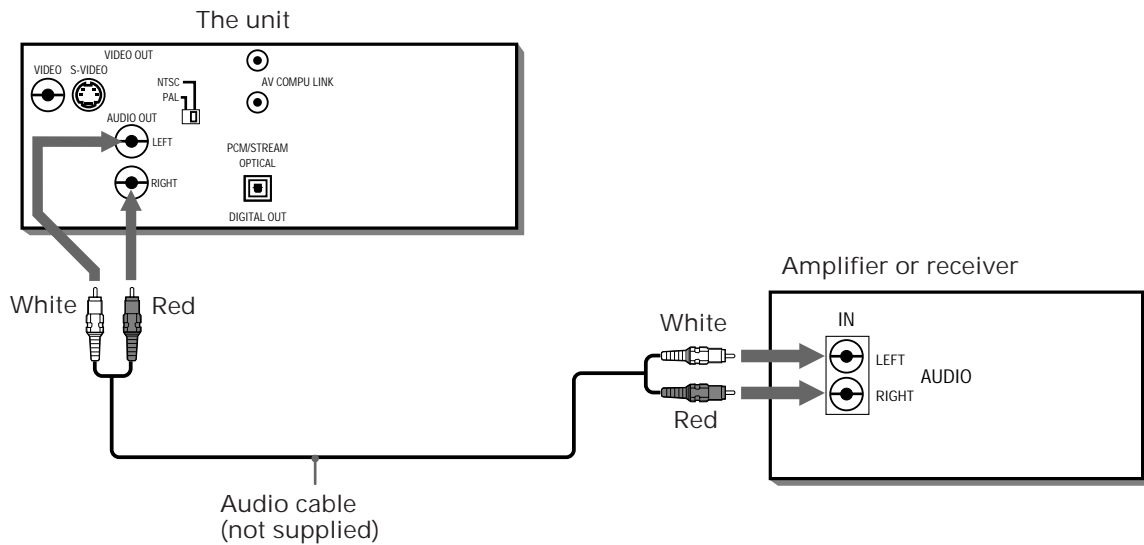

- Connect the unit's AUDIO OUT to any line-level inputs (such as AUX, DVD, CD, etc.) of an audio amplifier or receiver.

To connect to audio equipment with a digital input

You can enhance the sound quality by connecting the unit's DIGITAL OUT (optical) to the digital input of an amplifier, DAT or MD by using an optional digital cable. The digital stereo audio signal from a disc is directly transferred. If you connect the unit to a Dolby Digital, DTS or MPEG multichannel decoder or an amplifier with a built-in decoder by using an optional digital cable, you can enjoy high-quality surround sound.

When you make the digital connection, also make the analog connection, because, depending on the disc type, no audio may be reproduced from the DIGITAL OUT.

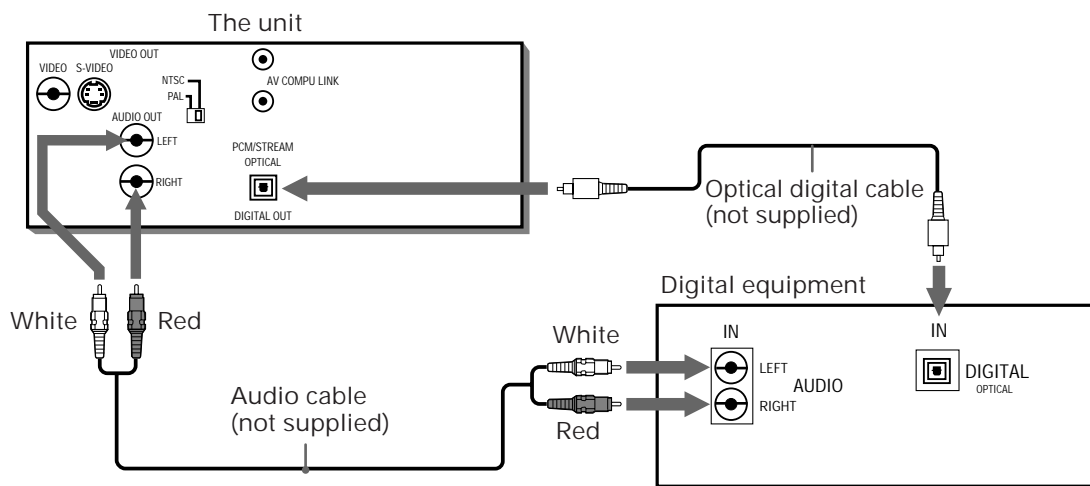

- For digital connection, connect the unit's DIGITAL OUT (optical) to the digital input of an audio equipment using an optional digital cable.

NOTES

- When you connect the unit's DIGITAL OUT to digital audio equipment, before using, make the "DIGITAL AUDIO OUTPUT" setting in the "PREFERENCE 2" on-screen display correctly according to the connected audio equipment. If the "DIGITAL AUDIO OUTPUT" is not set correctly, loud noise may be generated from speakers, causing damage to your speakers. See "DIGITAL AUDIO OUTPUT" on page 35.
- With the digital connection, the unit's settings for COMPRESSION and DOWN MIX are invalid. Settings for these items must be made from the decoder.

To connect the power cord

When all the connections have been made, insert the power plug into the wall outlet firmly. The STANDBY indicator lights and setup is completed.

Warning

- Disconnect the power cord if you are not going to use the unit for a long time.
- Disconnect the power cord before cleaning the unit.
- Disconnect the power cord before moving the unit.
- Do not connect or disconnect the power cord with wet hands.
- Do not pull the power cord when disconnecting it, as this may damage the cord and cause fire, electric shock, or other accidents.

Caution

- Do not damage, alter, twist, or pull the power cord, as this may cause fire, electric shock, or other accidents.
- Contact a dealer and get a new power cord if the cord is damaged. A damaged cord may cause fire, electric shock, or other accidents.
- Do not put anything heavy, or the unit, on the power cord, as this may cause fire, electric shock, or other accidents.

Using the remote control unit

Using the remote control, you can operate not only all the functions of the unit but also basic functions of your TV.

To install batteries in the remote control unit

The battery compartment is located on the back of the remote control unit.

- 1 Press down on the point shown by the arrow at the top of the compartment cover, and pull up the cover to open the compartment.

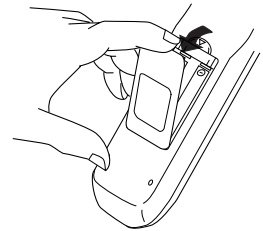

- 2 Place the two accessory R6P (SUM-3)/AA(15F) batteries in the remote control according to the polarity markings ("+" and "-") inside the compartment and on the batteries.

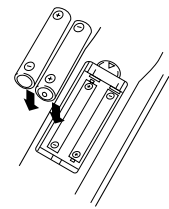

- 3 Place the cover over the compartment, and press down lightly.

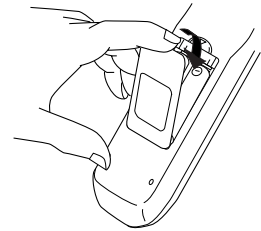

- The batteries will last about six months with normal use. If the functions of the remote control become erratic, replace the batteries. See below for more information.

Precautions for the safe use of batteries

Observe the following precautions for the safe use of batteries. If they are used improperly their life will be shortened, they may burst or their contents may leak.

Precaution

- Remove the batteries from the remote control if it is not going to be used for a long period of time.
- Remove dead batteries and dispose of them properly.
- Never leave dead batteries lying around, take them apart, mix them with other refuse, or throw them into an incinerator.
- Never touch liquid that has leaked out of a battery.
- Do not mix new and old batteries, or batteries of different types, when replacing them.

To use the remote control unit for TV operation

You can operate your TV from the remote control unit.

Setting the remote control signal for operating your TV.

- 1 Holding down TV/VIDEO, enter the manufacturer code of your TV listed below by using the numeric buttons (0 - 9). Do not release TV/VIDEO. Keep holding it until the next step is completed.

Manufacturer code list

No.	Manufacturer
01	JVC
02	PANASONIC
03	SONY
04	SHARP
05	TOSHIBA/BEIJING/CHANGHONG
06	MITSUBISHI/CHANGHONG
07	HITACHI
08	SANYO
09	FUNAI
10	AIWA
11	DAEWOO
12	SAMSUNG
13	LG (GOLDSTAR)
14	THOMSON
15	FERGUSON
16	PHILIPS/TCL/CHANGHONG
17	GRUNDIG





No.	Manufacturer
18	JTT
19	MIVER
20	FINLUX
21	NOKIA
22	NEC
23	JINXING/PEONY
24	PEONY
25	PEONY/CHANGHONG
26	KONKA
27	PEIJIN/NOBLEX
28	TCL

Example:

To enter the manufacturer code "01":
Press "0" then "1."

- 2 Press STOP while holding down TV/VIDEO.

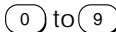
The following buttons can be used for operating the TV:

	Turns the TV on or off.
	Changes the TV channels.
	Adjusts the TV volume.
	Selects the TV channels (while holding down the SHIFT button). *For some TVs, pressing "+10" while holding down SHIFT functions as the "RETURN," and pressing "10" while holding down SHIFT functions as the "- / - -" button.
	Switches input mode (either TV or VIDEO).

- 3 Try to operate your TV by pressing TV . If your TV turns on or off, you have successfully set the control signal.

NOTE

- The remote control unit is initially set for operating a JVC TV.
- If there is more than one code listed for the manufacturer of your TV, try them one by one until you succeed.

Basic operations

In the following description, the buttons on the remote control unit are used, however, you may use the corresponding buttons on the front panel of the unit if available.

Turning on/off the unit

* Make sure that the PAL/NTSC switch on the rear panel is correctly set to match your TV.

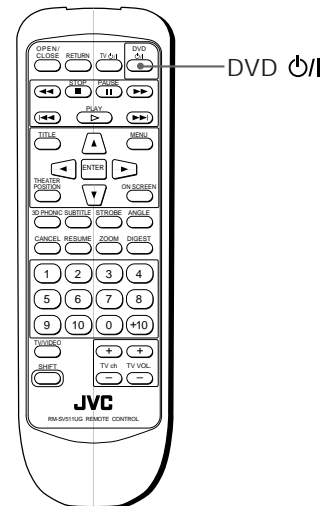
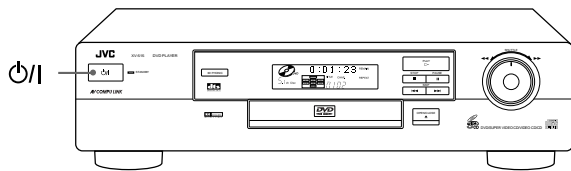

Press  on the front panel or press DVD  on the remote control unit.



Hints

- You can turn on the unit by pressing the PLAY button on the front panel or the Remote control unit. In this operation, the unit starts playback when the disc is set. If no disc is set, the disc tray opens.
- You can also turn on the unit by pressing the OPEN/CLOSE button on the front panel or the remote control unit. In this case, the disc tray opens.

NOTE

- Even if you press the  or DVD  button to turn off the unit, the unit is not disconnected from the AC power source as long as it is connected to the wall outlet. This state is called the standby mode. In this state, the unit is designed to consume a very small quantity of power.

Inserting and removing discs

- 1 Press OPEN/CLOSE to open the disc tray.
- 2 Place the disc in the tray.

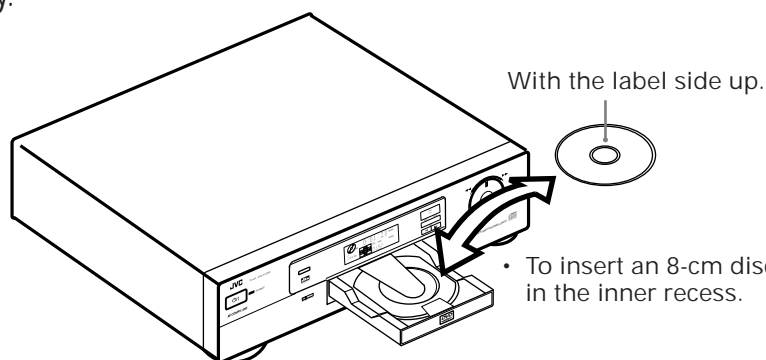

With the label side up.

- To insert an 8-cm disc, place it in the inner recess.

- 3 Press OPEN/CLOSE to close the disc tray.

Hints

You can also open and close the disc tray from the opening on-screen display.

Use CURSOR /▼ to move  to , then press ENTER to open or close the disc tray.

NOTES

- The unit can playback DVD, Audio CD, Video CD and SVCD discs only. Do not load other disc types. For details about playable disc types, see page 11.
- When loading a disc in the tray, be sure to position the disc inside the recess. Otherwise, the disc may be damaged when the tray is closed, and the disc may not be removed from the unit.
- Do not use any stabilizer when playing back a disc.

Basic playback

Now you can play a disc. First, let's enjoy simple playback according to following procedure.

To play a disc from the beginning

DVD Audio CD Video CD Super VCD

Press PLAY.

The unit starts playback from the beginning.

NOTES

- With Video CD and SVCD discs with PBC control or some DVD discs, the menu display may appear on the TV screen after pressing PLAY. In such a case, select an item to be played back from the menu.
For operation using a menu, see page 20.
- With some DVD discs, the unit starts playback automatically after inserting the disc.

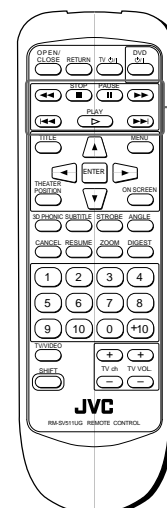

Basic control buttons

To stop playback completely

DVD Audio CD Video CD Super VCD

Press STOP.

The unit stops playback.

To stop playback temporarily

DVD Audio CD Video CD Super VCD

Press PAUSE.

The unit pauses playback. To continue playback, press PLAY.

To advance or reverse play rapidly while monitoring

DVD Audio CD Video CD Super VCD

■ During playback

From the remote control unit

Press ►► or ◀◀.

Pressing ►► advances playback rapidly, while pressing ◀◀ reverses playback rapidly. Each time you press the button, advance or reverse playback speed increases. To return to normal playback, press PLAY.

From the front panel

Use the SHUTTLE knob.

To advance playback rapidly, turn the shuttle knob to the right and hold, and to reverse play rapidly, turn the shuttle knob to the left and hold. When you release the shuttle knob, the unit returns to normal playback. The playback speed changes according to the amount you turn the shuttle knob.

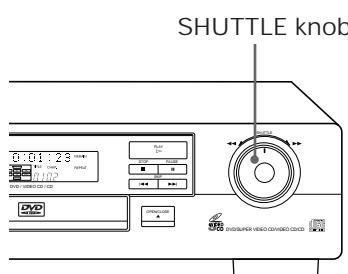

To locate the beginning of the scene or song

DVD Audio CD Video CD Super VCD

■ During playback

Press ►► or ◀◀.

Press ◀◀ to locate the beginning of the current chapter, title, or track, and press ►► to locate the beginning of the next chapter, title, or track.

NOTE

When you play a Video CD or SVCD disc with the PBC function or a DVD disc, the unit may locate a different place, but it will generally locate the beginning of the title or chapter or track.

Resuming playback

The unit stores the position on a disc where you want to interrupt playback at, and resumes playback from that position later.

To store the point you want to resume playback from

DVD Audio CD Video CD Super VCD

■ During playback

Press RESUME.

The unit stores the current playback position of the disc, and the Resume indicator in the display window on the front panel lights.

The last stored memory overrides the previous memory.

Display window



Resume indicator

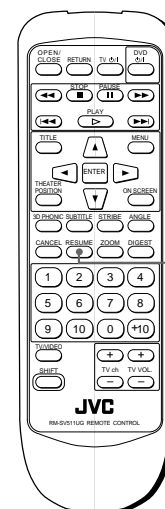

RESUME

Hints

Instead of pressing RESUME, you can also store the current position on a disc by pressing DVD (on the remote control unit) or (on the front panel of the unit) during playback.

To resume playback from the stored point

DVD Audio CD Video CD Super VCD

■ While stopped.

Press RESUME.

The unit resumes playback from the stored position.

- To clear the memory
Take out the disc from the unit.

Hints

The unit will also resume playback by pressing RESUME during standby mode.

NOTE

- When you press RESUME during playback of a Video CD or SVCD disc with PBC function, the unit may resume playback from a point slightly earlier than the resume point you stored.

Playing from a specific position on a disc

You can play a disc from the selected track, title or chapter, or from the specified time.

To locate a desired scene from the DVD menu



DVD discs generally have their own menus which show the disc contents. These menus contain various items such as titles of a movie, names of songs, or artist information, and display them on the TV screen. You can locate a desired scene by using the menu.

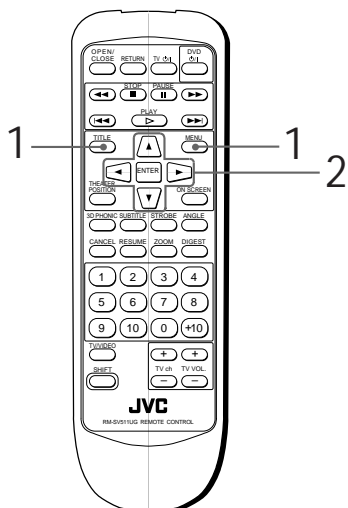

■ Insert the DVD disc.

1 Press MENU or TITLE.

The menu appears on the TV screen.



About menu

Normally, a DVD disc which contains more than one title may have a "title" menu which lists the titles. In this case, the menu appears on the TV screen by pressing the TITLE button. Some DVD discs may also have a different menu which appears by pressing the MENU button.

See the instructions of each DVD disc for its particular menu.

Example

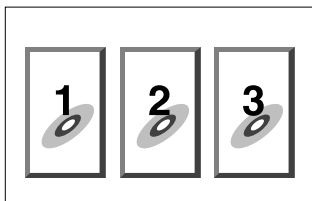

2 Use CURSOR $\leftarrow/\rightarrow/\uparrow/\downarrow$ to select a desired item, then press ENTER.

The unit starts playback of the selected item.



With some discs, you can also select items by entering the corresponding number using the numeric buttons, which may cause the unit to automatically start playback.

NOTES

- When \odot appears on the TV screen by pressing TITLE in step 1:
The disc does not have a menu listing the titles.
- When \odot appears on the TV screen by pressing MENU in step 1:
The disc does not have a menu.

To locate a desired scene from the menu of the Video CD with PBC



Some Video CD and SVCD discs are compatible with the PBC function. PBC is an abbreviation of "PlayBack Control." A Video CD or SVCD disc recorded with PBC has its own menus such as a list of the songs of the disc and items recorded on the disc. You can also locate the specific scene by using the menu.

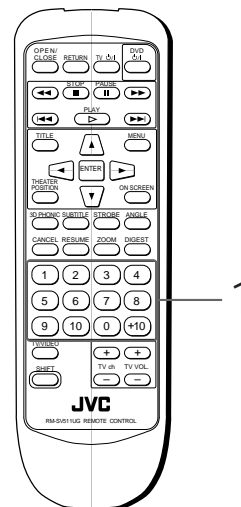

■ When the menu appears on the TV screen during playback with PBC

1 Use the numeric buttons to select the desired number of the item.

Example:

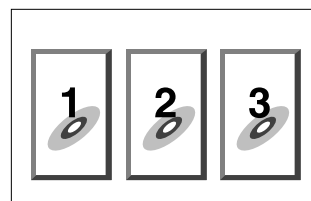

- See page 10 for details about how to use the numeric buttons.

Playback starts from the selected item.

You can return to the menu by pressing RETURN.

When "NEXT" or "PREVIOUS" appears on the TV screen, the unit generally works as follows:

- Pressing \blacktriangleright turns to the next page.
- Pressing \blacktriangleleft returns to the previous page.

* The method of the operation is different depending on the disc.

Hints

- To activate the PBC function when a PBC-compatible Video CD or SVCD disc is being played back without the PBC function, press STOP then press PLAY.
- You can also activate the PBC function using the on-screen display as follows.
 1. Press ON SCREEN.
 2. Use the ▲/▼ buttons to move  to [PBC CALL], then press ENTER.

Hints

If you want to playback a PBC-compatible Video CD or SVCD disc without activating the PBC function, start playback by using the numeric buttons instead of the PLAY button. See the next paragraph.

To locate a desired scene or track directly



You can play the desired scene or track by specifying the title (for DVDs) or track (for CDs).

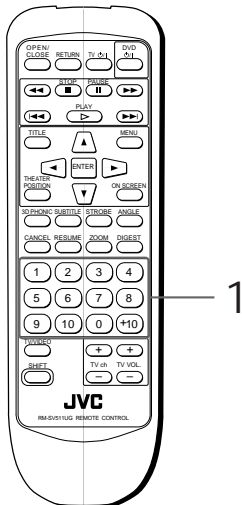

- For DVD: While stopped
- For Audio CD: During playback or while stopped
- For Video CD/SVCD: During playback without PBC function or while stopped

1 Use the numeric buttons to select the desired title or track number.

- See page 10 for details about how to use the numeric buttons.

The selected title or track number appears in the display window on the front panel.

Display window



Selected title or track number

The unit starts playback from the selected title or track.

Hints

You can also see the selected title or track number on the on-screen display.

NOTES

- When  appears on the TV screen. The title or track you have selected is not contained in the disc.
- This function does not work during Video CD/SVCD playback with PBC function

To locate a desired chapter or track using

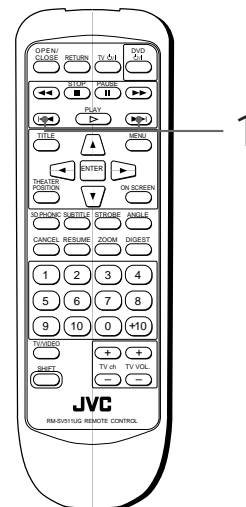
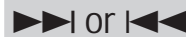



- For DVD: During playback
- For Audio CD: During playback or while stopped
- For Video CD/SVCD: During playback without PBC function

Display window



Selected track number

1 Press  or .

- To skip to a succeeding track, press  once or repeatedly until the desired track appears in the display.
- To skip to beginning of the current track, press  once.
- To skip to a preceding track, press  repeatedly until the desired track appears in the display.

NOTES

- This function may not work with some DVD discs.
- This function does not work during Video CD/SVCD playback with PBC function

To locate a desired scene by specifying the chapter number [CHAP. SEARCH]



If the current title of a DVD disc being played is divided into chapters, you can skip to a desired chapter by specifying the chapter number using the on-screen display.

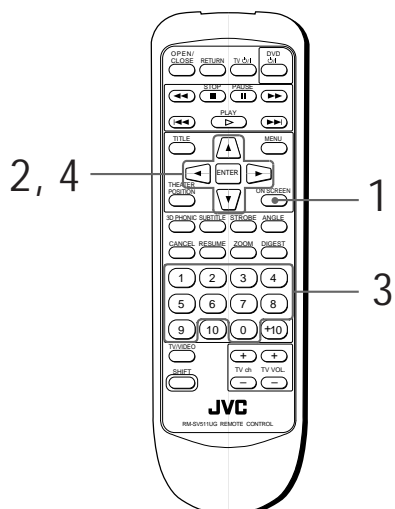

■ During playback

- 1 Press ON SCREEN.
The on-screen display appears on the TV screen.
- 2 Use CURSOR ▲/▼ to move to [CHAP. SEARCH], then press ENTER.

"GO TO CHAPTER" appears in the message area.
The color of [CHAP. SEARCH] changes.

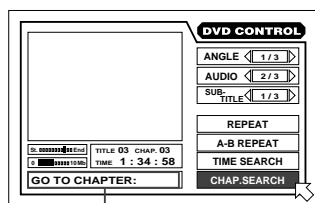

Message area

- 3 Use the numeric buttons (0 ~ 9) to enter the desired chapter number.
The selected chapter number appears in the message area.
- 4 Press ENTER.
The unit starts playback from the selected chapter.



The "10" and "+10" buttons are not used in this function.

Example:

- To select chapter number 8: Press "8" → ENTER.
- To select chapter number 37: Press "3" → "7" → ENTER.

NOTES

- When the chapter number is incorrect in step 3: Overwrite the incorrect number with the correct number.
- When is displayed in the TV screen in step 4: The chapter you have selected is not contained in the disc, or chapter search does not work on the disc.
- With some discs, the unit automatically starts searching for the chapter after entering the chapter number in step 3.
- To return to the regular display: Press ON SCREEN.

To locate a desired position by specifying the time [TIME SEARCH]



You can play a disc from the the desired position by specifying the elapsed time from the beginning of the disc using the TIME SEARCH function.
Note that some DVD discs do not contain time information, and the TIME SEARCH function cannot be used.

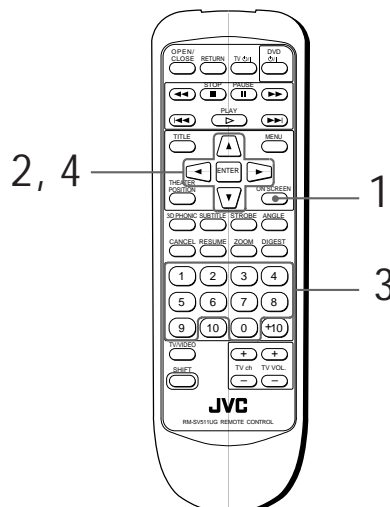

- For DVD: During playback
- For Audio CD: During playback or while stopped
- For Video CD/SVCD: During playback without PBC function

- 1 Press ON SCREEN.
The on-screen display appears on the TV screen.
- 2 Use CURSOR ▲/▼ to move to [TIME SEARCH], then press ENTER.
"GO TO" appears in the message area.
The color of [TIME SEARCH] changes.
- 3 Use the numeric buttons (0 ~ 9) to enter the time.
The specified time appears in the message area.
- 4 Press ENTER.
The unit starts playback from the selected time.

(for DVD)

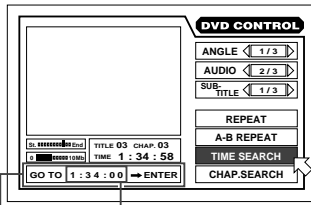

Message Selected time area

(for Audio CD)

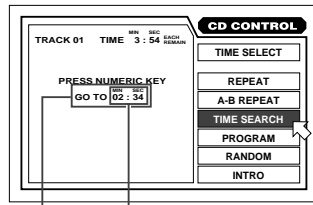

Message Selected time area

(for Video CD)

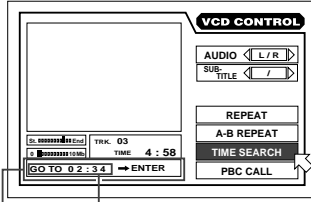

Message Selected time area

(for SVCD)

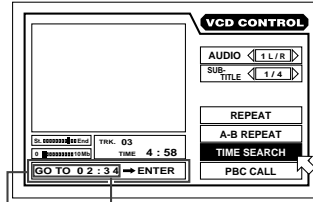

Message Selected time area

Hints

- "10" and "+10" buttons are not used in this function.
- You can specify the time in hour/minute/second format for DVD discs, and in minute/second format for Audio, Video CD and SVCD discs.

Example (for DVD):

To playback from 2(H):34(M):00(S)

GO TO _ : _ :
 ↓ Press "2".
GO TO 2 : _ :
 ↓ Press "3".
GO TO 2 : 3 _ :
 ↓ Press "4".
GO TO 2 : 3 4 : _
 ↓
 Press ENTER.

You do not have to press "0" to enter the trailing zeros (for the last two digits in the example above). Of course, it is possible to enter them.

- When you make a mistake
 Move the cursor to the incorrect value, then press the correct value to re-select the value.

GO TO 2 : 3 5 : _
 ↓ Press CURSOR ◀.
GO TO 2 : 3 5 :
 ↓ Press "4".
GO TO 2 : 3 4 : _

NOTES

- When  appears on the TV screen in step 2:
 The time you have selected is not contained on the disc, or the time search function does not work on the disc.
 Also note that the time search function does not work during Video CD/SVCD playback with the PBC function.
- To return to the regular display:
 Press ON SCREEN .

To locate a desired scene from the opening scene digest display [DIGEST]



The unit can display the opening scene of each title on a DVD or each track of a Video CD/SVCD. You can select a desired title or track from the opening scenes displayed on the TV screen.

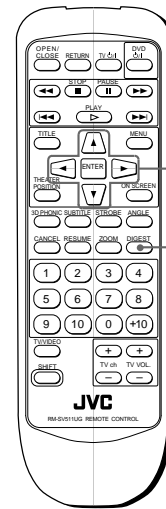

- For DVD: While stopped
- For Video CD/SVCD: While stopped or during playback without PBC function.

1 Press DIGEST.

The opening scene of each title or track appears on the TV screen.

Up to nine opening scenes are displayed.



2 Use CURSOR ◀/▶/▲/▼ to select the desired title or track.

When the disc contains more than 9 titles or tracks, the digest screen will have more than one page. In this case, pressing ▶▶ advances to the next page, while pressing ◀◀ returns to the previous page.

Hints

- When the selected title or track is in the lower right-hand corner of the screen, pressing CURSOR ▶ advances to the next page.
- When the selected title or track is in the upper left-hand corner of the screen, pressing CURSOR ◀ returns to the previous page.



Selected title

3 Press ENTER.

The unit starts playback from the selected title or track.

Hints

When you press DIGEST during DVD playback, the unit displays the opening scene of each chapter and you can select the desired chapter. In this case, opening scenes are displayed from chapter 1. The operation for selecting a chapter is the same as mentioned above.

NOTE

- With some discs, depending on the contents, it may take some time until all the scenes appear on the screen.

Special picture playback

The unit provides special picture playback functions including Frame-by-frame, Strobe, Slow-motion and Zoom.

To advance a still picture frame-by-frame

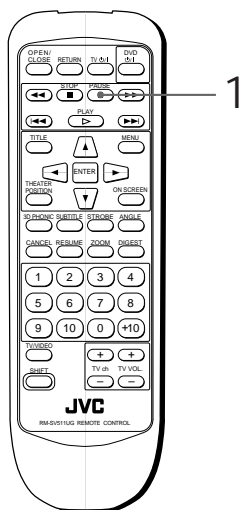

■ While paused (still)

1 Press PAUSE.

Each time you press PAUSE, the still picture advances to the next frame.

Pressing PLAY returns to the normal playback mode.

To display still pictures [STROBE]

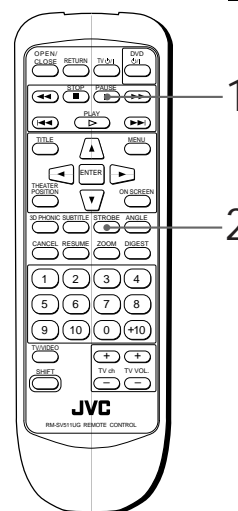

■ During playback

1 At the point you want to view as continuous photographs, press PAUSE.

The unit pauses playback.

2 Press STROBE.

Nine continuous still pictures appear on the TV screen.

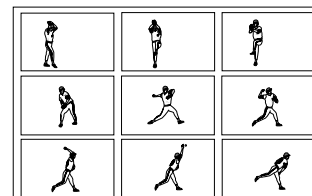

Hints

- Pressing PAUSE when the nine still pictures appear advances to the next nine still pictures.
- To cancel strobe play Press STROBE.

NOTES

- Pressing and holding PAUSE for more than 1 second also activates the Strobe function.
- If you press STROBE during playback, nine still pictures also appear but they advance in realtime.

To playback in slow-motion [SLOW]

DVD Video CD Super VCD

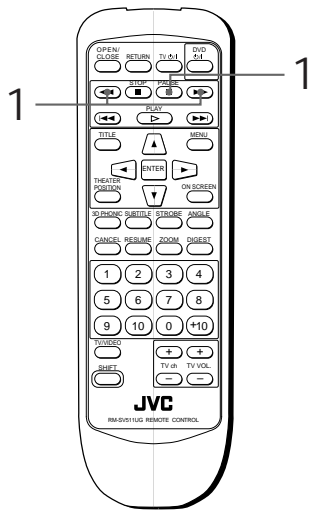

■ During playback

From the remote control unit

1 Press PAUSE, then press ►► or ◄◄.

To play forward slow-motion, press ►►, and to play reverse slow-motion (for DVD discs only), press ◄◄. First, the unit plays the slowest speed (1/32), and each time you press these buttons, the playback speed increases.

From the front panel

1 Press PAUSE, then use the SHUTTLE knob.

To play forward slow-motion, turn the SHUTTLE knob to the right. To play reverse slow-motion (for DVD discs only), turn it to the left. The more you turn the knob, the more the slow-motion speed increases.

- To return to normal playback
Press PLAY.
- To pause slow-motion playback
Press PAUSE.

NOTES

- The sound is muted during slow-motion playback.
- Reverse slow-motion playback is not possible for a Video CD/SVCD.

To zoom a scene [ZOOM]

DVD Video CD Super VCD

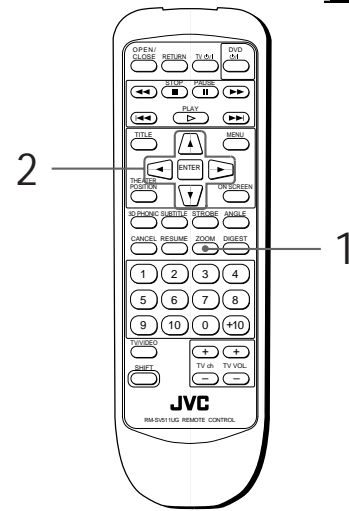

■ During playback or while paused

1 Press ZOOM.

"ZOOM" appears on the TV screen.

The unit zooms in to the center part of the scene to produce a double-sized image.

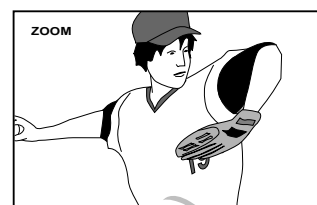
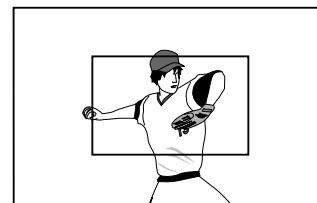

2 Use CURSOR ◀/▶/▲/▼ to move the zoomed-in scene.

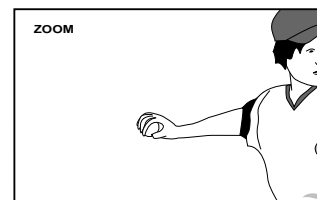

- To pause zoom play
Press PAUSE.
To resume zoom play, press PLAY.
- To return to normal playback
Press ZOOM.

NOTE

- During Zoom play, the picture may be garbled or noisy.

Changing the track order

You can play tracks on a Audio CD, Video CD or SVCD in the desired order or in random order.

To playback in the desired order [PROGRAM]



By programming tracks, you can play tracks in any order.

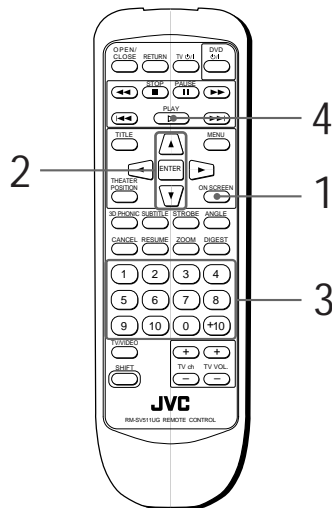

■ While stopped

- 1 Press ON SCREEN.
The on-screen display appears on the TV screen.
- 2 Use CURSOR ▲/▼ to move [PROGRAM] and press ENTER.
The color of [PROGRAM] changes.

(for Audio CD)

(for Video CD/SVCD)

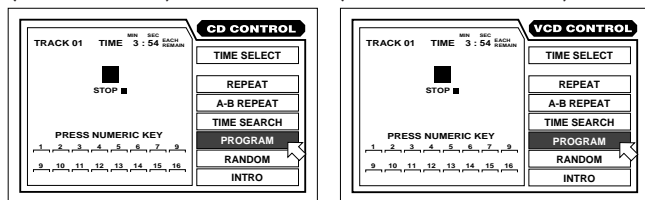

- 3 Select the tracks in the desired order using the numeric buttons.
Up to 16 tracks can be programmed. You may select the same track more than once.

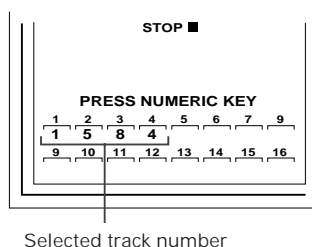

- When you make a mistake
Press CANCEL. The last track programmed is erased.

4 Press PLAY to start program play.

When all of the programmed tracks have finished playback, the unit stops but the program remains.

- To clear the program
Press STOP to stop playback, then press STOP again. All the programmed tracks are erased.
- To quit program playback
Press ENTER when [PROGRAM] points [PROGRAM]. [PROGRAM] returns to its original color.

(When playing back a Video CD or SVCD, you have to press STOP and then press ON SCREEN to display the on-screen display.)

To playback tracks in random order [RANDOM]

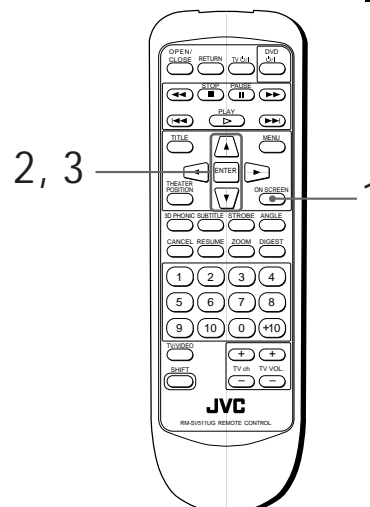

You can play tracks in random order.

■ While stopped

- 1 Press ON SCREEN.
The on-screen display appears on the TV screen.
- 2 Use CURSOR ▲/▼ to move [RANDOM].

(for Audio CD)

(for Video CD/SVCD)

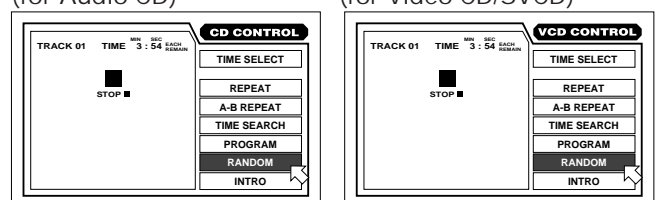

3 Press ENTER.

The color of [RANDOM] changes.

Random play begins.



- When all tracks have been played once, random play ends.
- The same track will not be played back more than once during random play.
- To quit random playback
Press STOP. The unit stops playback and quits random mode.



During Audio CD playback, pressing ENTER when points [RANDOM] quits random mode and continues playback in the normal order.

Repeat playback

You can repeat playback of the current title or chapter (for DVD), or current or all tracks (for Audio/Video CD/SVCD). You can also repeat playback of a desired part.

To repeat a current title, chapter or track, or all tracks [REPEAT]

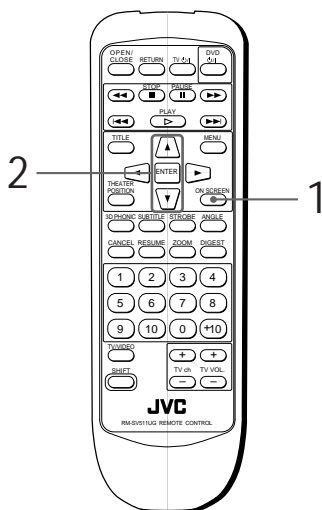

- For DVD, Audio CD: During playback
- For Video CD/SVCD: During playback without PBC function

1 Press ON SCREEN.

The on-screen display appears on the TV screen.

2 Use CURSOR ▲/▼ to move to [REPEAT], then press ENTER.

Each time you press ENTER, the repeat mode changes as follows:

- for DVD
The current title or chapter will be repeated.

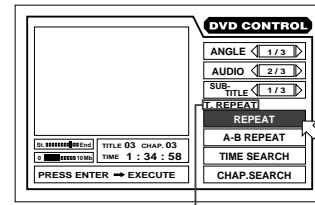

The selected repeat mode appears on the TV screen.

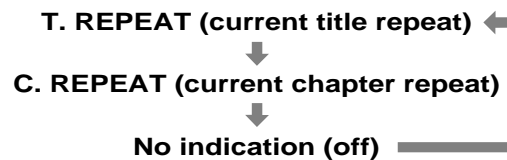

- for Audio CD/Video CD/SVCD
The current track or all tracks is/are played repeatedly.

(for Audio CD)

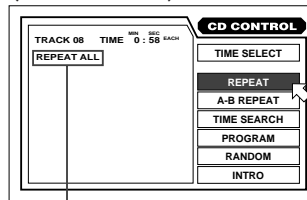

Selected repeat mode

(for Video CD)

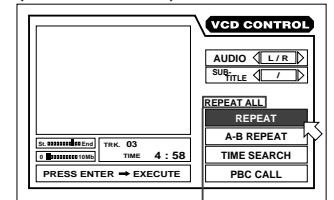

Selected repeat mode

(for SVCD)

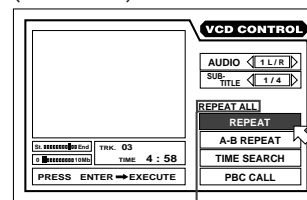

Selected repeat mode

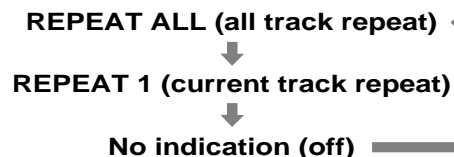

- To stop repeat playback
Press STOP.
When a DVD disc is set, the unit stops playback and quits repeat mode.
When an Audio, Video CD or SVCD is set, the unit stops playback but remains in repeat mode.
- To quit repeat playback
When points [REPEAT], press ENTER repeatedly until [REPEAT] returns to its original color.

NOTES

- Repeat play function cannot be used during Video CD/SVCD playback with PBC function.
- To turn off the on-screen display
Press ON SCREEN.
- If appears when pressing ENTER in step 2 during DVD/SVCD playback
You cannot repeat the title or chapter because of the disc contents.

To repeat a desired part [A-B REPEAT]

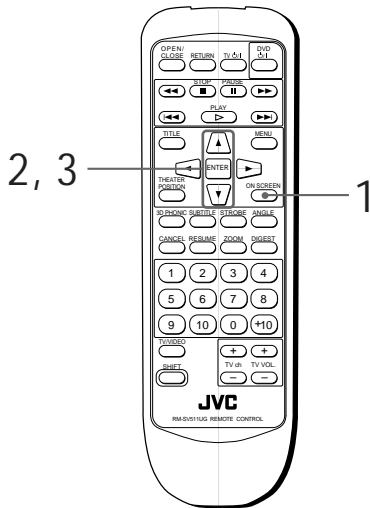

■ During playback

- 1 Press ON SCREEN.
The on-screen display appears on the TV screen.
- 2 Use CURSOR ▲/▼ to move to [A-B REPEAT], then press ENTER at the beginning of the part you want to repeat (point A).
The color of [A-B REPEAT] changes.
- 3 Press ENTER at the end of the part you want to repeat (point B).
The unit locates "A" and starts repeat playback between "A" and "B."

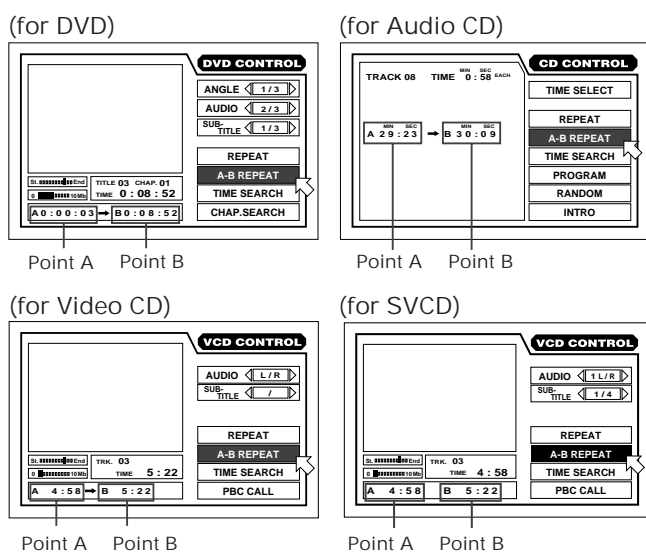

- To quit A-B repeat playback
Press STOP. The unit stops playback and quits A-B repeat mode.



During playback, pressing ENTER when points [A-B REPEAT] quits A-B repeat mode and continues playback.

NOTES

- To turn off the on-screen display
Press ON SCREEN.
- If appears when pressing ENTER in step 2 during DVD playback
You cannot repeat the selected portion because of the disc contents.

Sampling all tracks

You can sample the tracks of an Audio CD, Video CD or SVCD by playing back only the beginning 10 seconds of each track in order.

To playback only the beginning of each track [INTRO]

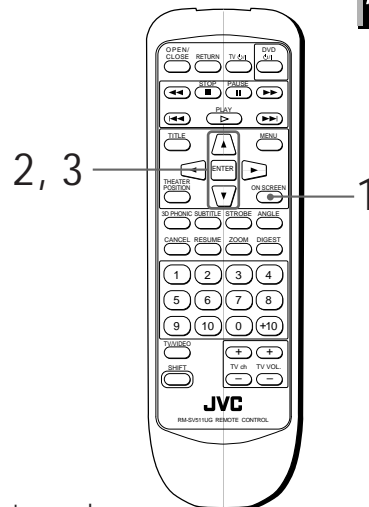

■ While stopped

- 1 Press ON SCREEN.
The on-screen display appears on the TV screen.
- 2 Use CURSOR ▲/▼ to move to [INTRO].
(for Audio CD) (for Video CD/SVCD)

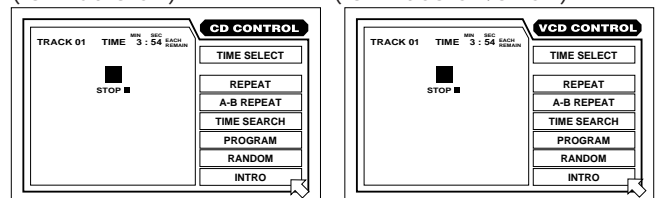

- 3 Press ENTER.
The first 10 seconds of each track on a disc are played back in numerical order from the first track.
When all tracks have been played once, INTRO scan mode quits.
- To quit INTRO scan
Press STOP. The unit stops and quits INTRO scan mode.



During Audio CD playback, pressing ENTER when points [INTRO] quits INTRO scan mode and continues playback.

Viewing from multiple angles

You can enjoy a variety of scene angles if the DVD disc contains "multi-angle" parts, where multiple cameras were used to shoot the same scene from different angles. You can select one of these viewing angles from the normal screen or on-screen display.



At the beginning of "multi-angle" parts, appears on the TV screen.

To select a scene angle from the normal screen [ANGLE]

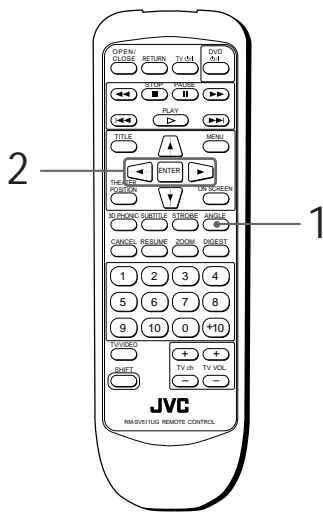

■ During playback

- 1 Press ANGLE.
- 2 Press ANGLE or CURSOR to select the desired angle.
Each time you press ANGLE or CURSOR , the angle changes.

To select a scene angle from the on-screen display [ANGLE]

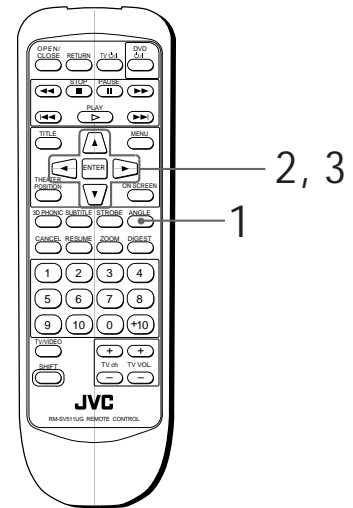

■ During playback

- 1 Press ON SCREEN.
The on-screen display appears on the TV screen.
- 2 Use CURSOR to move to [ANGLE].

The total number of recorded angles

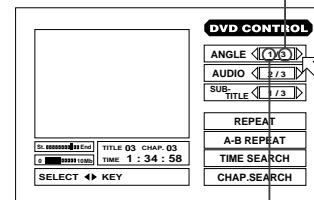

The current angle number

- 3 Use CURSOR to select the desired angle number.

Example:

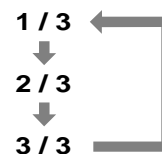

NOTES

- To turn off the on-screen display
Press ON SCREEN.
- When appears on the TV screen
The current scene is not recorded from multiple angles.

To select a scene angle from the angle list display [ANGLE]

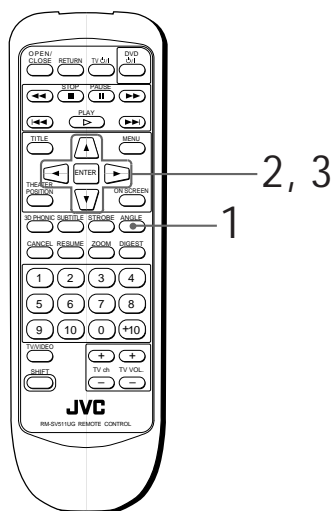

■ During playback

- 1 Press and hold ANGLE for more than 1 second.

Up to nine camera angles recorded on a disc appear on the TV screen.

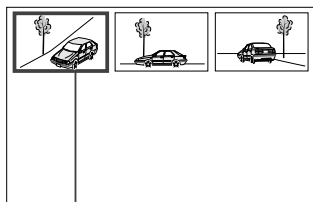

The selected camera angle

- 2 Use CURSOR $\blacktriangle/\blacktriangledown/\blacktriangleleft/\blacktriangleright$ to select the desired angle.
- 3 Press ENTER.

■ The selected angle appears on the TV screen.

NOTES

- When appears on the TV screen in step 1: The current scene is not recorded from multiple angles.
- During the operation above, audio is muted.

Changing the language and sound

For DVD and SVCD discs, you can select the subtitle language, as well as the audio language/sound included on a disc.

For Video CD discs, you can select the audio channel(s).

To select the subtitle language [SUBTITLE]



■ During playback

Using SUBTITLE button

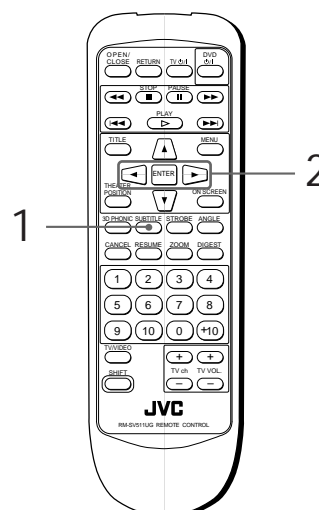

- 1 Press SUBTITLE.
- 2 Use CURSOR $\blacktriangleleft/\blacktriangleright$ to select the desired subtitle.

Using on-screen display

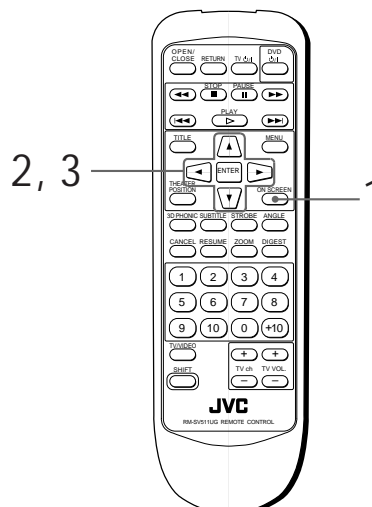

1 Press ON SCREEN.

The on-screen display appears on the TV screen.

2 Use CURSOR ▲/▼ to move to [SUBTITLE].

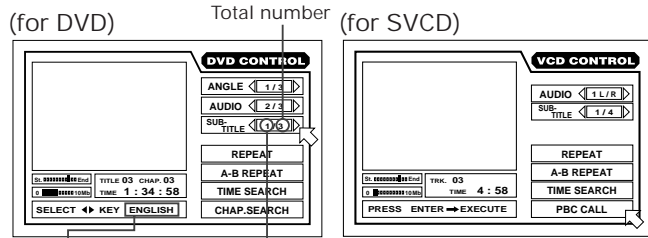

Total number

Selected subtitle

3 Use CURSOR ◀/▶ to select the desired subtitle.

- For DVD

Pressing CURSOR ◀/▶ cycles among the subtitles recorded on the disc.

Example:

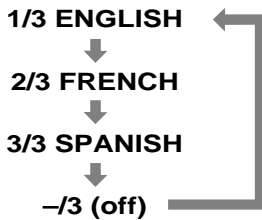

NOTES

- The selected language may be abbreviated on the TV screen. See "Appendix A: Table of languages and their abbreviations" in this manual.
- When a circle with a slash appears on the TV screen: You cannot select the subtitle.

- For SVCD

Pressing CURSOR ◀/▶ cycles among four subtitle channels as follows regardless of whether the subtitles are recorded or not.

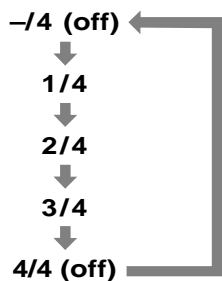

NOTES

- An SVCD disc can have up to four subtitles.
- If no subtitle is recorded on the channel selected, no subtitle appears on the TV screen.

To change the audio language or sound [AUDIO]



By AUDIO selection, you can choose the audio language of movies or choose to enjoy karaoke without the vocal or with the vocal.

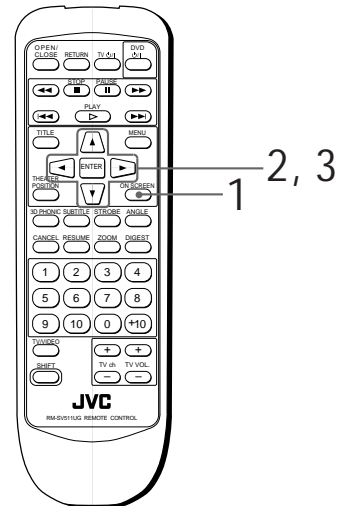

- During playback

1 Press ON SCREEN.

The on-screen display appears on the TV screen.

2 Use CURSOR ▲/▼ to move to [AUDIO].

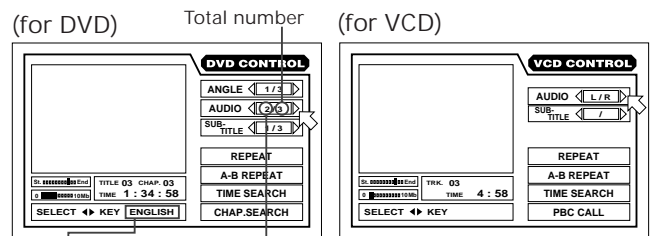

Total number

Selected audio number

Selected audio language

(for SVCD)

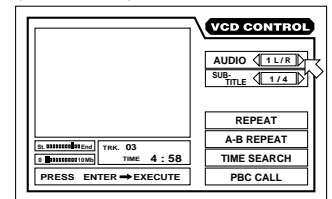

3 Use CURSOR ◀/▶ to select the desired audio language or sound.

- For DVD

Pressing CURSOR ◀/▶ cycles among the audio languages or sounds recorded on the disc.



NOTE

- When a circle with a slash appears on the TV screen: You cannot select the audio.

- For Video CD
Pressing CURSOR ◀▶ cycles among the audio channels as follows.

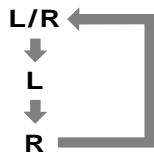

- For SVCD
Pressing CURSOR ◀▶ cycles among the audio channels as follows.

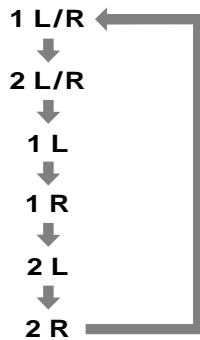

- To turn off the on-screen display
Press ON SCREEN.

NOTES

- An SVCD disc has a pair of stereo channels; Sound 1 and Sound 2. In the above options, "1" indicates "Sound 1", while "2" indicates "Sound 2".
- Some SVCD discs may not contain audio on Sound 2. When playing back such a disc, no audio is reproduced by selecting "2 L/R", "2 L" or "2 R" above.

Selecting the picture character

You can select the quality of the image from among four options (OFF, 1, 2 and 3) according to the type of programming, picture tone or personal preferences.

To select the picture character [THEATER POSITION]

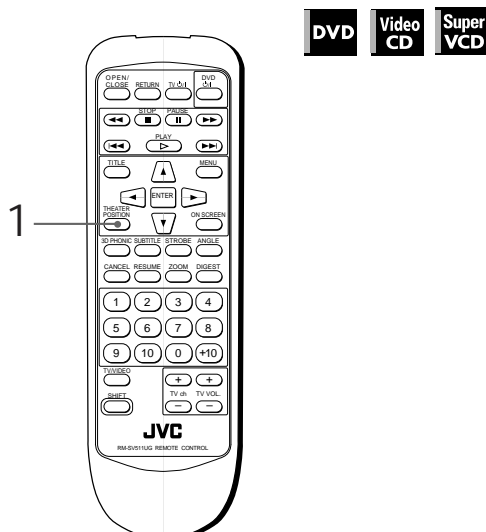

■ During playback

- 1 Press THEATER POSITION to select the desired picture character.

Each time you press the button, the picture character changes as follows:

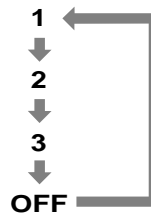

"Off" is the normal position. Selecting a higher number tones down the picture character.

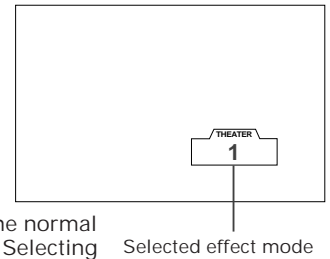

Selected effect mode

Enjoying virtual surround sound

Using the 3D Phonic function, you can get a simulated surround effect from your stereo system.

To simulate surround sound [3D PHONIC]

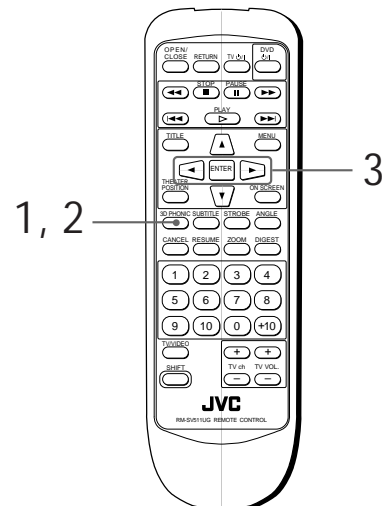

Advanced operations

■ During playback

- 1 Press 3D PHONIC.
- 2 Select the desired effect mode by pressing 3D PHONIC.

Each time you press 3D PHONIC, the effect mode changes as follows:

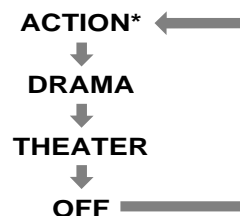

Selected effect mode

* When you play a DVD disc recorded in Dolby Digital which contains more than 2 channels, ACTION does not appear.

3 Press CURSOR ◀▶ to adjust the effect level.

You can adjust the effect level in 5 level.

Toward L:

Reduces the effect.

Toward H:

Enhances the effect.

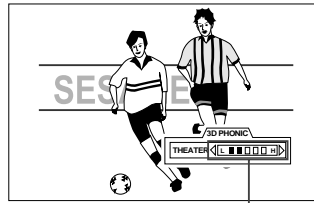

Effect level

Hints

To turn off the 3D PHONIC screen, press ENTER. The 3D PHONIC screen disappears if no operations are made for more than 10 seconds.

NOTES

- The 3D phonic function works correctly when playing back discs recorded in the Dolby Surround or Dolby Digital 5.1-CH format. It also works when playing back discs other than those above, but does not provide the correct effect.
- The 3D Phonic function does not affect the DTS or Dolby Digital bitstream signal from the DIGITAL OUT jack.
- The sound effect will not be set or operate, even if 3D PHONIC is pressed, for the sound of DVD discs recorded in Linear PCM.
- When you set the 3D PHONIC function to on, the DOWN MIX and COMPRESSION setting in the PREFERENCE 2 display are disabled.

Checking the disc time

You can choose the time display mode for an Audio or Video CD disc in the display on the front panel and in the on-screen display.

To select the time display mode [TIME SELECT]

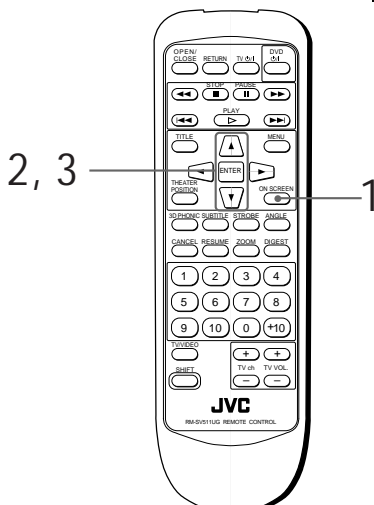

- For Audio CD: During playback or while stopped
- For Video CD/SVCD: While stopped

1 Press ON SCREEN.

The on-screen display appears on the TV screen.

2 Use CURSOR ▲/▼ to move to [TIME SELECT].

(for Audio CD)

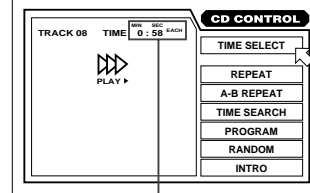

Time display

(for Video CD/SVCD)

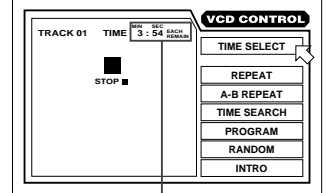

Time display

3 Press ENTER.

Each time you press ENTER, the time mode changes as follows:

- During playback (for Audio CD)

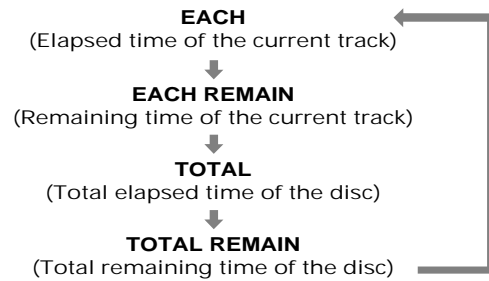

- While stopped

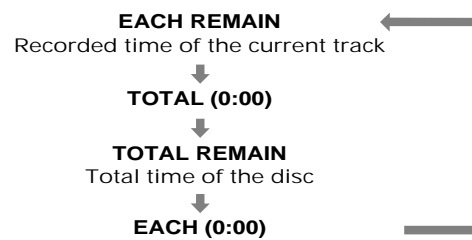

Hints

When you select "EACH REMAIN" while stopped, you can change the track by pressing ◀▶.

Selecting preferences

You can set various preferences for playback via the "PREFERENCE" display.

How to set preferences on the "PREFERENCE" display

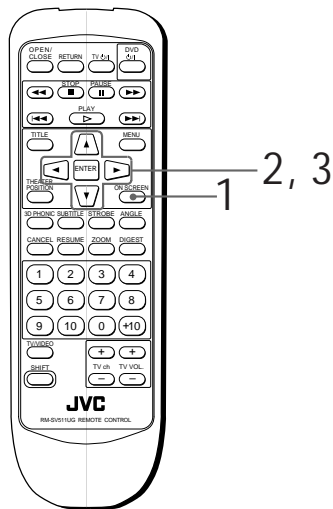

- 1 While a DVD disc is stopped or no disc is inserted, press ON SCREEN.

The "PREFERENCE" display appears on the TV screen.

The "PREFERENCE" display consists of two pages. To turn the page, move to the desired tab using CURSOR .

Preference 1

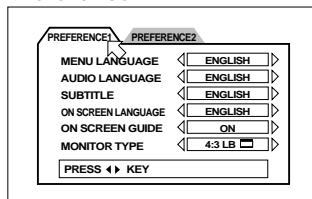

Preference 2

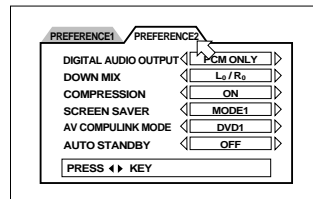

- 2 Move to select the item you want to set by using CURSOR .

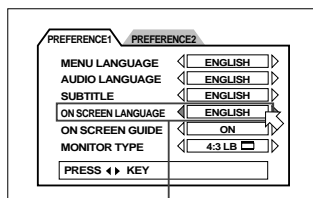

Selected item

- 3 Press CURSOR to select the setting you want.

- To return to the normal screen, press ON SCREEN.
- For details about each setting, see the following paragraphs.

To set the language and display preference items

PREFERENCE 1 can be set as follows:

MENU LANGUAGE

You can select a default "display" language to be displayed if it is contained on the disc.

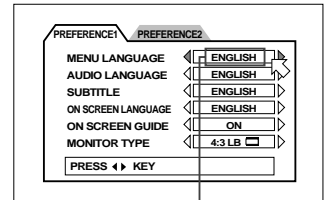

Selected language

Each time you press CURSOR , the language setting changes in the following order:

ENGLISH → SPANISH → FRENCH → CHINESE → GERMAN → ITALIAN → JAPANESE → language code from AA to ZU
(See "Table of languages and their abbreviations" at the end of this manual.)

Pressing CURSOR changes the language setting in the reverse order of the above.

- * If the selected language is not recorded, the disc's default display language is displayed.

AUDIO LANGUAGE

You can select the default audio language to be played if it is contained on the disc.

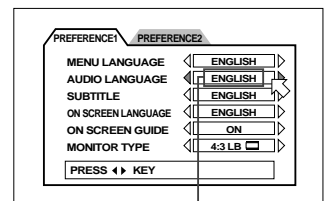

Selected language

Each time you press CURSOR , the language setting changes in the following order:

ENGLISH → SPANISH → FRENCH → CHINESE → GERMAN → ITALIAN → JAPANESE → language code from AA to ZU
(See "Table of languages and their abbreviations" at the end of this manual.)

Pressing CURSOR changes the language setting in the reverse order of the above.

- * If the selected language is not recorded, the disc's default audio language is played.

SUBTITLE

You can select the default subtitle language to be displayed when it is contained on a playback disc.

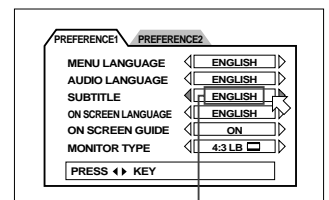

Selected language

Each time you press CURSOR , the language setting changes in the following order:

ENGLISH → SPANISH → FRENCH → CHINESE → GERMAN → ITALIAN → JAPANESE → language code from AA to ZU
(See "Table of languages and their abbreviations" at the end of this manual.)

Pressing CURSOR ◀ changes the language setting in the reverse order of the above.

* If the selected language is not recorded, the disc's default subtitle language is displayed.

ON SCREEN LANGUAGE

You can select the on-screen display language to be displayed.

Each time you press CURSOR ◀/▶, the language setting changes as follows:

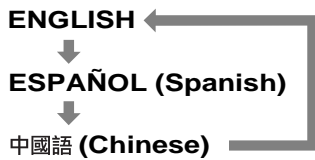

English	ON SCREEN LANGUAGE ◀ ENGLISH ▶
Spanish	IDIOMA EN PANTALLA ◀ ESPAÑOL ▶
Chinese	字幕語言 ◀ 中國語 ▶

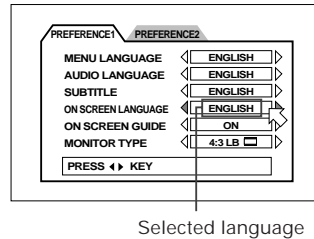

ON SCREEN GUIDE

The unit can display "on-screen guide" icons or characters on the picture, which show what is happening to the disc or the unit.

- ON
The guide display turns on.
- OFF
The guide display turns off.

Examples of "on-screen guide" icons or characters:

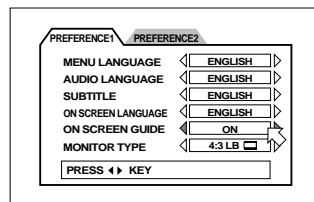

MONITOR TYPE

You can select the monitor type to match your TV when you playback DVD discs recorded for wide screen televisions.

- 4:3 LB (Letter Box Conversion)
When you connect a normal TV to the unit.

When you play a wide picture recorded on a DVD disc, the picture is displayed with bands across the upper and lower portions of the screen.



- 4:3 PS (Pan scan Conversion)
When you connect a normal TV to the unit.

When you play a wide picture recorded on a DVD disc, a portion of the picture is automatically cut off from the left and right sides of the image.

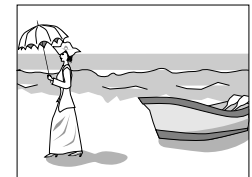

Depending on the disc, it may not be possible to playback in this mode. In this case, the picture is played back as in 4:3 LB mode.

- 16:9 WIDE (Wide Television screen)
When you connect a wide-screen TV to the unit.

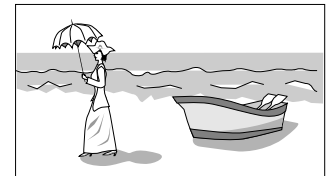

To set other preference items

PREFERENCE 2 can be set as follows:

DIGITAL AUDIO OUTPUT

To connect the unit's digital output to an external device equipped with a digital input, this item must be set correctly.

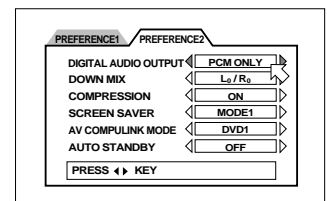

- PCM ONLY:
When you connect the DIGITAL OUT jack of the unit with the linear PCM digital input of other audio equipment.
- STREAM/PCM:
When you connect to the digital input of an amplifier with built-in DTS, Dolby Digital, and MPEG audio decoder.
- DOLBY DIGITAL/PCM:
When you connect to the digital input of a Dolby Digital decoder, or an amplifier with built-in Dolby Digital decoder

The following chart shows the relationship between types of playback discs and output signals.

Playback discs	Output		
	STREAM/PCM	DOLBY DIGITAL/PCM	PCM ONLY
DVD with 48-kHz, 16-bit linear PCM	48-kHz, 16-bit linear PCM	←	←
DVD with 48-kHz, 20/24-bit linear PCM	48-kHz, 20-bit linear PCM	←	←
DVD with 96-kHz, linear PCM	No output	←	←
DVD with DTS	DTS bitstream	No output	←
DVD with Dolby Digital	Dolby Digital bitstream	←	48-kHz, 16-bit linear PCM
DVD with MPEG audio	MPEG bitstream	48-kHz, 16-bit linear PCM	←
Video CD SVCD	44.1-kHz, 16-bit linear PCM	←	←
Audio CD	44.1-kHz, 16-bit linear PCM	←	←
Audio CD with DTS	DTS bitstream	←	←

NOTES

- The unit does not provide the DTS decoding function.
- When playing a DVD or Audio CD disc with DTS, use a DTS decoder to get correct signals from your speakers. Never use the unit's analog output jacks, which output incorrect signals that may damage your speakers.
If you connect the analog outputs and digital outputs simultaneously, be sure to select the source of the amplifier correctly, or set the level control of the amplifier connected to the analog outputs to minimum.

DOWN MIX

By setting DOWN MIX correctly, you can get the optimum stereo mix for your audio system from DVD discs recorded with Dolby Digital surround multichannel audio.

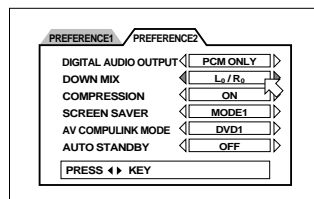

- Lt/Rt (Dolby Digital disc only):
For monitoring the unit's 2-channel audio output signals via a Dolby Pro Logic decoder.
- Lo/Ro:
For monitoring the unit's 2-channel audio output signals via a TV or an amplifier with no built-in Dolby Pro Logic decoder. Also for recording DVD audio to a cassette tape, MD, etc.

NOTE

- The Down mix function does not work when the 3D PHONIC function is activated.

COMPRESSION

You can compress the dynamic range of the sound if needed. Using this function, you can listen to sound at low volumes easily.

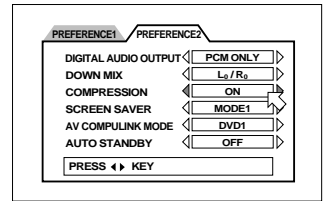

- ON
Audio is played back with the dynamic range compressed.
- OFF
Audio is played back as it was recorded.

NOTES

- The Compression function works only when playing back a disc recorded with DOLBY DIGITAL 1CH or 2CH. The setting is not effective for other discs.
- The Compression function does not work when the 3D PHONIC function is activated.

SCREEN SAVER

A television monitor screen may be burned out if a static picture is displayed for a long time. To prevent this, the unit automatically activates the screen saver function if a static picture, such as an on-screen display or menu, is displayed for over 5 minutes.

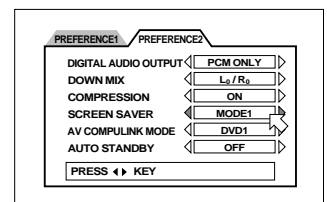

- MODE 1
The "screen saver" picture appears and scrolls.
- MODE 2
The "screen saver" picture appears and does not scroll.
- DIMMER
The current picture gets dark.
- OFF
The screen saver function is off.

NOTES

- When the screen saver mode is set to DIMMER, the display window on the front panel also gets dark (FL Dimmer). To return to normal brightness, set to another mode.
- The monitor screen of a projector or projection TV is easily burned out if a static picture is displayed for a long time. Be careful not to allow the monitor screen to be burned out when you set the screen saver mode to OFF.
- The TV screen may be garbled when you set the screen saver mode to MODE 1. In this case, set to another mode.

AV COMPULINK MODE

If you use the AV Compulink system, you must set this item correctly.

Select from the three options: "DVD1," "DVD2" and "DVD3" according to the equipment to be connected.
See page 39.

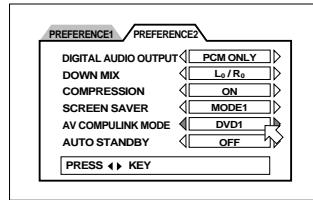

AUTO STANDBY

When the unit is in stop mode for more than 30 minutes or 60 minutes, the unit enters standby mode automatically.

- 60
Time is set to 60 minutes.
- 30
Time is set to 30 minutes.
- OFF
The auto standby function is off.

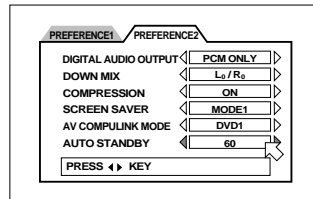

- 2 Use CURSOR ▲/▼ to move to [Country Code], then use CURSOR ◀/▶ to select the country code and press ENTER.

The country code whose standards were applied to rate the DVD video disc should be selected.

See "Appendix B: Country code list for parental lock."

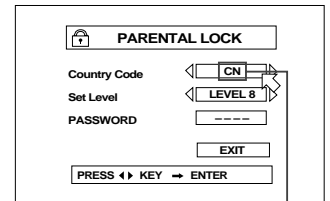

Country code

- 3 Use CURSOR ▲/▼ to move to [Set Level], then use CURSOR ◀/▶ to select the parental lock level.

Each time you press CURSOR ▶, the parental level changes between LEVEL 1 and LEVEL 8.

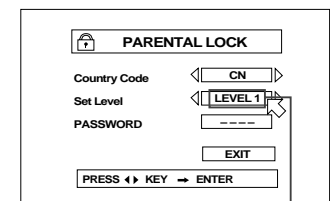

Selected level



"LEVEL 1" is the lowest level.
Discs rated higher than the level you selected are restricted.

Limiting playback by children

This function restricts playback of DVD discs which contain violent (and other) scenes according to the level set by the user. For example, if a movie which includes violent scenes supports the parental lock feature, such scenes which you do not want to let children view can be cut or replaced with other scenes.

- 4 Press ENTER.
- 5 Enter your 4-digit password using the numeric buttons (0 to 9) and press ENTER.

To set Parental Lock for the first time [PARENTAL LOCK]

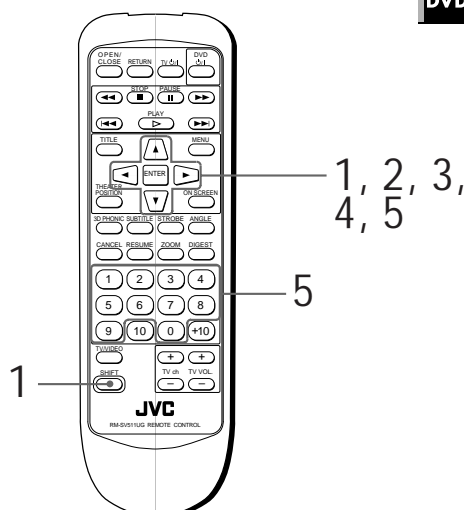

■ While a DVD disc is stopped or no disc is inserted

- 1 Press ENTER while holding down SHIFT.
The Parental Lock on-screen display appears on the TV screen.

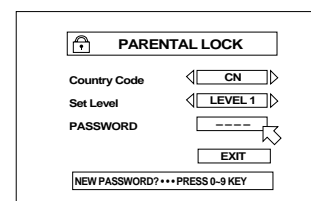

The parental level and password are set.

To change the settings [PARENTAL LOCK]

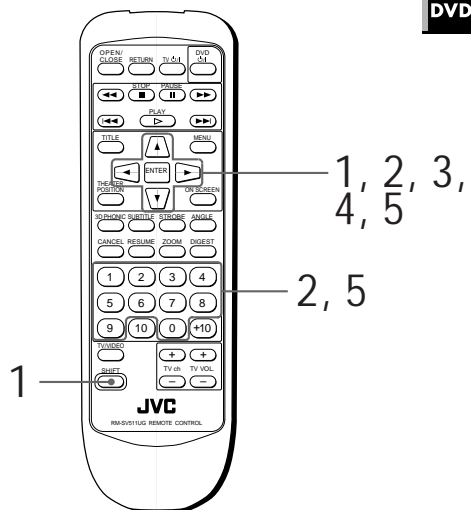

DVD

To temporarily release the Parental lock [PARENTAL LOCK]

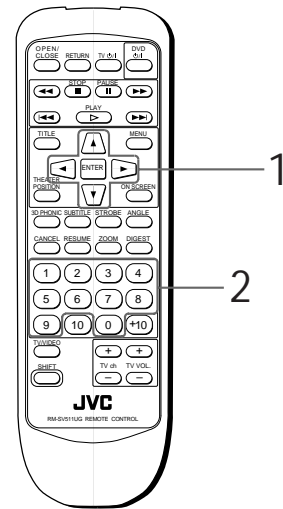

DVD

■ While a DVD disc is stopped or no disc is inserted

1 Press ENTER while holding down SHIFT.

The Parental Lock on-screen display appears on the TV screen.

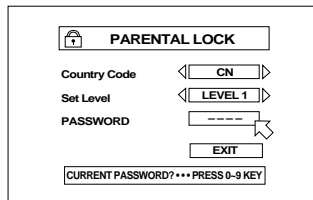

2 Enter your current 4-digit password using the numeric buttons (0 to 9) and press ENTER.

If you enter the wrong password, "WRONG! RETRY....." appears on the TV screen, and you cannot go to next step.

3 Use CURSOR ▲/▼ to move to [Set Level], then use CURSOR ◀/▶ to select the parental lock level.

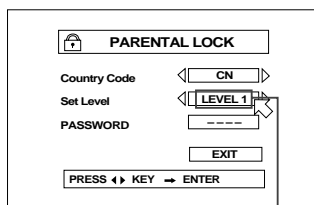

Selected level

4 Press ENTER.

5 Enter your new 4-digit password using the numeric buttons (0 to 9) and press ENTER.

The new setting is effective.

NOTES

- When you enter the wrong password more than 3 times in step 2 above, the cursor moves to [EXIT] automatically and CURSOR ▲/▼ does not work.
- If you forget your password in step 2 Enter "8888."

When you set the parental level strictly, some discs may not be played back at all. When you insert such a disc and try to play it, the Parental Lock on-screen display appears on the TV screen, and the unit will ask you whether you want the parental lock to be temporarily released or not.

1 Use the CURSOR ▲/▼ to move to [Temporary], then use CURSOR ◀/▶ to select [YES] or [NO], then press ENTER.

If you select [YES], the cursor moves to the PASSWORD field.

When selecting [NO], press OPEN/CLOSE to remove the disc.

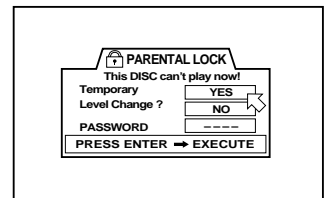

2 Enter your 4-digit password using the numeric buttons (0 to 9).

If you enter the wrong password, <WRONG! RETRY...> appears on the TV screen, and you cannot go to next step.

The Parental lock is released, and the unit starts playback.

NOTE

- When you enter the wrong password more than 3 times in step 2 above, the cursor moves to [NO] automatically and CURSOR ▲/▼ does not work.

AV COMPU LINK remote control system

When you buy a separate TV, VCR, DVD player, receiver, or other components and connect them to each other, you have to operate each component individually. JVC's AV COMPU LINK remote control system meets the demand for a system made up of single components and has the ease of operation of a single unit.

Connection and setup

Using the AV COMPU LINK cable, connect the AV COMPU LINK terminals of each component to one another.

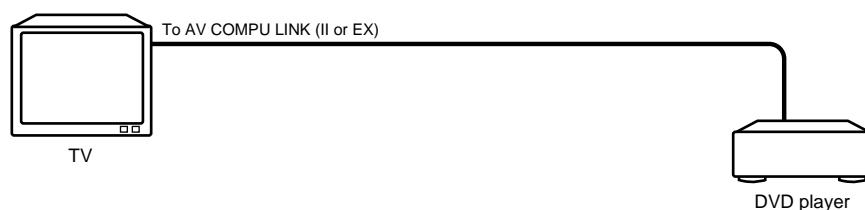

- If you connect a DVD player with a television via AV COMPU LINK, set the DVD player's AV COMPU LINK setting as follows.
 - When connecting with VIDEO-1 input terminal of the television: DVD2
 - When connecting with VIDEO-2 input terminal of the television: DVD3

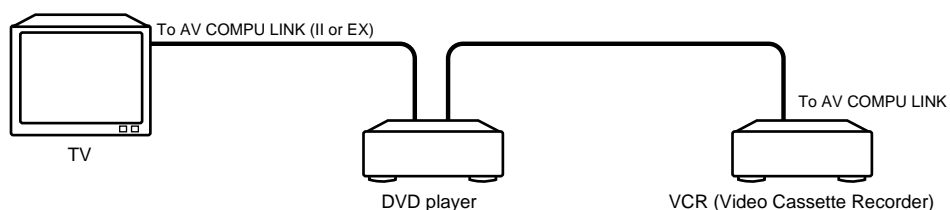

- If you connect a DVD player with a television and VCR via AV COMPU LINK, set the VCR's Remote Control Code and DVD player's AV COMPU LINK setting as follows.
 - When connecting with VIDEO-1 input terminal of the television:
 - DVD player's AV COMPU LINK setting: DVD2
 - VCR's Remote Control Code: B
 - When connecting with VIDEO-2 input terminal of the television:
 - DVD player's AV COMPU LINK setting: DVD3
 - VCR's Remote Control Code: A

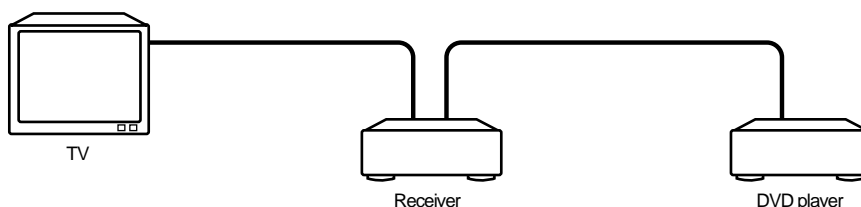

- If you connect a DVD player with a television and receiver via AV COMPU LINK, set the DVD player's AV COMPU LINK setting to DVD1.
 - The DVD player's AV COMPU LINK setting is operated in the "PREFERENCE" display. See page 37 for operation.
 - About the connection between the TV and the Receiver, refer to Receiver's Instructions.

Notes for connection

- If you connect a DVD player with a receiver via AV COMPU LINK in a system including a Dolby digital decoder, some functions may not be performed automatically.
- The AV COMPU LINK terminal on some televisions indicates "II". Do not connect the terminal indicating "II" with the AV COMPU LINK terminal on a receiver. If connected, the system will not work correctly.
- Connect the AUDIO OUT jacks of the DVD player to the audio input jacks of a receiver indicating "DVD". Otherwise, the system will not work correctly.
- There is no description about connections to a DVD player in the instruction manual of a television or VCR. But a television or VCR with AV COMPU LINK terminals indicating "II" or "EX" can be connected to a DVD player.

Operation

You can enjoy pictures and/or sound by just putting a source component (which plays back the pictures and/or sound such as a DVD player or VCR) into play mode. You do not have to operate the TV and receiver including not having to perform power switching.

- 1 Turn on the main power of the television.
- 2 Insert a disc into the source component.
- 3 Press ► of the source component.

The following actions are performed automatically:

- Turning on the power for the television.
- Setting the source of the television to the external input (VIDEO-1 or VIDEO-2).
- Turning on the power for the receiver.
- Setting the source of the receiver to the component which has started playback.

Care and handling of discs

How to handle discs

When handling a disc, do not touch the surface of the disc. Since discs are made of plastic, they are easily damaged. If a disc gets dirty, dusty, scratched or warped, the images and sound will not be picked up correctly, and such a disc may cause the player to malfunction.

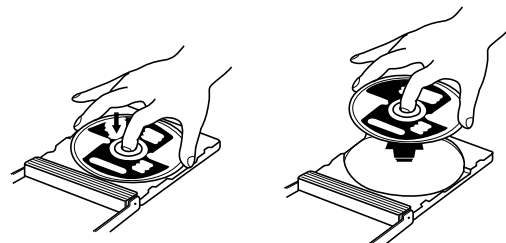

Label side

Do not damage the label side, stick paper to or use any adhesive on its surface.

Storage

Make sure that discs are kept in their cases. If discs are piled on top of one another without their protective cases, they can be damaged. Do not put discs in a location where they may be exposed to direct sunlight, or in a place where the humidity or temperature is high. Avoid leaving discs in your car!

Maintenance of discs

If there are fingerprints or other dirt adhering to a disc, wipe with a soft dry cloth, moving from the center outwards. If a disc is difficult to clean, wipe with a cloth moistened with water. Never use record cleaners, petrol, alcohol or any anti-static agents.



CAUTION

Sometimes during play noise or images may be garbled. This is sometimes due to the disc. (It may not be up to industry standards.)

These symptoms are caused by the discs, not by the malfunction of the unit.

Troubleshooting

What appears to be a malfunction may not always be serious. Please go through the following list before requesting service.

Symptom	Possible case	Remedy
Power does not come on.	Power plug is not inserted securely.	Plug in securely.
Remote control does not work.	Too far from the unit.	Move closer to the unit.
	The tip of the remote unit is not pointed in the right direction.	Point the infrared light-emitting window toward the remote sensor on the front panel.
	Batteries are exhausted.	Replace the batteries with new ones.
	Battery polarity is incorrect.	Take out the batteries and insert them again in the correct direction.
No picture is displayed on the monitor.	Connection of video cable is incorrect.	Connect the cable correctly.
	Input selection of TV is incorrect.	Select correctly.
	Disc is not playable.	Use a playable disc. (See page 11.)
Picture is noisy.	The unit is connected to a VCR directly and the copyguard function is activated.	Connect the unit so that the picture signal flows directly to the TV.
No audio is reproduced.	Connection is incorrect.	Check the connections.
	Input selection of amplifier is incorrect.	Select correctly.
No audio is reproduced when playing back a DVD disc recorded with 96-kHz, linear PCM audio.	The audio signal derives from the unit's DIGITAL OUT.	Use the AUDIO OUT when playing back such discs.
Sound is distorted or noise is generated.	Disc is dirty.	Wipe the disc surface.
Picture is garbled.	The screen saver mode is set to MODE 1, and the screen saver function is activated.	Set the screen saver mode to the other mode.
Picture does not fit the television screen.	MONITOR TYPE is not correctly set.	Select monitor type correctly. (See page 35.)
	Television is not correctly set.	Set the television correctly.
Operation is not possible.	Microcomputer malfunctions due to lightning or static electricity.	Turn off the power and unplug the power cord, then connect the power cord again.
	Moisture condensation occurs by a sudden change of temperature or humidity.	Turn off the power, then turn it on a few hours later.

Specifications

General

Readable discs: DVD VIDEO, Audio CD, Video CD, SVCD
 Video format: PAL/NTSC selectable

Other

Power requirements: AC 110-240 V \sim , 50/60 Hz
 Power consumption: 21 W (POWER ON), 2 W (STANDBY mode)
 Mass: 4.3 kg (9.5 lbs)
 Dimensions (W x H x D): 435 x 112 x 338 mm
 17-3/16 x 4-7/16 x 13-5/16 inch

Video output

VIDEO OUT (pin jack): 1.0 Vp-p (75 ohms)
 S-VIDEO OUT (S jack): Y Output: 1.0 Vp-p (75 ohms)
 C Output: 286 mVp-p (75 ohms)
 Horizontal resolution: 500 Lines
 Signal to noise ratio: 65 dB

Audio output

ANALOG OUT (pin jack): 2.0 Vrms (10 k ohms)
 DIGITAL OUT (optical): - 21 to -15 dBm (peak)

Audio characteristics

Frequency response: CD (sampling frequency 44.1 kHz): 2 Hz to 20 kHz
 DVD (sampling frequency 48 kHz): 2 Hz to 22 kHz
 DVD (sampling frequency 96 kHz): 2 Hz to 44 kHz
 Dynamic range: 16 bit: More than 100 dB
 20 bit: More than 108 dB
 24 bit: More than 108 dB
 Wow and flutter: Unmeasurable (less than \pm 0.002%)
 Total harmonic distortion: Less than 0.002%

* Specifications and appearance subject to change without prior notice.

Appendix A: Table of languages and their abbreviations

When you select the subtitle language or sound, the languages shown below are displayed as abbreviations. To select the desired language, select the abbreviation corresponding the language you want to.

AA	Afar
AB	Abkhazian
AF	Afrikaans
AM	Ameharic
AR	Arabic
AS	Assamese
AY	Aymara
AZ	Azerbaijani
BA	Bashkir
BE	Byelorussian
BG	Bulgarian
BH	Bihari
BI	Bislama
BN	Bengali, Bangla
BO	Tibetan
BR	Breton
CA	Catalan
CO	Corsican
CS	Czech
CY	Welsh
DA	Danish
DZ	Bhutani
EL	Greek
EO	Esperanto
ET	Estonian
EU	Basque
FA	Persian
FI	Finnish
FJ	Fiji
FO	Faroese
FY	Frisian
GA	Irish
GD	Scots Gaelic
GL	Galician
GN	Guarani
GU	Gujarati
HA	Hausa
HI	Hindi
HR	Croatian
HU	Hungarian
HY	Armenian
IA	Interlingua
IE	Interlingue

IK	Inupiak
IN	Indonesian
IS	Icelandic
IW	Hebrew
JI	Yiddish
JW	Javanese
KA	Georgian
KK	Kazakh
KL	Greenlandic
KM	Cambodian
KN	Kannada
KO	Korean (KOR)
KS	Kashmiri
KU	Kurdish
KY	Kirghiz
LA	Latin
LN	Lingala
LO	Laothian
LT	Lithuanian
LV	Latvian, Lettish
MG	Malagasy
MI	Maori
MK	Macedonian
ML	Malayalam
MN	Mongolian
MO	Moldavian
MR	Marathi
MS	Malay (MAY)
MT	Maltese
MY	Burmese
NA	Nauru
NE	Nepali
NL	Dutch
NO	Norwegian
OC	Occitan
OM	(Afan) Oromo
OR	Oriya
PA	Panjabi
PL	Polish
PS	Pashto, Pushto
PT	Portuguese
QU	Quechua
RM	Rhaeto-Romance

RN	Kirundi
RO	Rumanian
RU	Russian
RW	Kinyarwanda
SA	Sanskrit
SD	Sindhi
SG	Sangho
SH	Serbo-Croatian
SI	Singhalese
SK	Slovak
SL	Slovenian
SM	Samoan
SN	Shona
SO	Somali
SQ	Albanian
SR	Serbian
SS	Siswati
ST	Sesotho
SU	Sundanese
SV	Swedish
SW	Swahili
TA	Tamil
TE	Telugu
TG	Tajik
TH	Thai
TI	Tigrinya
TK	Turkmen
TL	Tagalog
TN	Setswana
TO	Tonga
TR	Turkish
TS	Tsonga
TT	Tatar
TW	Twi
UK	Ukrainian
UR	Urdu
UZ	Uzbek
VI	Vietnamese
VO	Volapuk
WO	Wolof
XH	Xhosa
YO	Yoruba
ZU	Zulu

Appendix B: Country code list for parental lock

This list is used for the parental Lock operation. For details, see page 37.

AD	Andorra
AE	United Arab Emirates
AF	Afghanistan
AG	Antigua and Barbuda
AI	Anguilla
AL	Albania
AM	Armenia
AN	Netherlands Antilles
AO	Angola
AQ	Antarctica
AR	Argentina
AS	American Samoa
AT	Austria
AU	Australia
AW	Aruba
AZ	Azerbaijan
BA	Bosnia and Herzegovina
BB	Barbados
BD	Bangladesh
BE	Belgium
BF	Burkina Faso
BG	Bulgaria
BH	Bahrain
BI	Burundi
BJ	Benin
BM	Bermuda
BN	Brunei Darussalam
BO	Bolivia
BR	Brazil
BS	Bahamas
BT	Bhutan
BV	Bouvet Island
BW	Botswana
BY	Belarus
BZ	Belize
CA	Canada
CC	Cocos (Keeling) Islands
CF	Central African Republic
CG	Congo
CH	Switzerland
CI	Côte d'Ivoire
CK	Cook Islands
CL	Chile
CM	Cameroon
CN	China
CO	Colombia
CR	Costa Rica
CU	Cuba
CV	Cape Verde
CX	Christmas Island
CY	Cyprus
CZ	Czech Republic
DE	Germany
DJ	Djibouti
DK	Denmark
DM	Dominica
DO	Dominican Republic
DZ	Algeria
EC	Ecuador
EE	Estonia
EG	Egypt
EH	Western Sahara
ER	Eritrea

ES	Spain
ET	Ethiopia
FI	Finland
FJ	Fiji
FK	Falkland Islands (Malvinas)
FM	Micronesia (Federated States of)
FO	Faroe Islands
FR	France
FX	France, Metropolitan
GA	Gabon
GB	United Kingdom
GD	Grenada
GE	Georgia
GF	French Guiana
GH	Ghana
GI	Gibraltar
GL	Greenland
GM	Gambia
GN	Guinea
GP	Guadeloupe
GQ	Equatorial Guinea
GR	Greece
GS	South Georgia and the South Sandwich Islands
GT	Guatemala
GU	Guam
GW	Guinea-Bissau
GY	Guyana
HK	Hong Kong
HM	Heard Island and McDonald Islands
HN	Honduras
HR	Croatia
HT	Haiti
HU	Hungary
ID	Indonesia
IE	Ireland
IL	Israel
IN	India
IO	British Indian Ocean Territory
IQ	Iraq
IR	Iran (Islamic Republic of)
IS	Iceland
IT	Italy
JM	Jamaica
JO	Jordan
JP	Japan
KE	Kenya
KG	Kyrgyzstan
KH	Cambodia
KI	Kiribati
KM	Comoros
KN	Saint Kitts and Nevis
KP	Korea, Democratic People's Republic of
KR	Korea, Republic of
KW	Kuwait
KY	Cayman Islands
KZ	Kazakhstan
LA	Lao People's Democratic Republic

LB	Lebanon
LC	Saint Lucia
LI	Liechtenstein
LK	Sri Lanka
LR	Liberia
LS	Lesotho
LT	Lithuania
LU	Luxembourg
LV	Latvia
LY	Libyan Arab Jamahiriya
MA	Morocco
MC	Monaco
MD	Moldova, Republic of
MG	Madagascar
MH	Marshall Islands
ML	Mali
MM	Myanmar
MN	Mongolia
MO	Macau
MP	Northern Mariana Islands
MQ	Martinique
MR	Mauritania
MS	Montserrat
MT	Malta
MU	Mauritius
MV	Maldives
MW	Malawi
MX	Mexico
MY	Malaysia
MZ	Mozambique
NA	Namibia
NC	New Caledonia
NE	Niger
NF	Norfolk Island
NG	Nigeria
NI	Nicaragua
NL	Netherlands
NO	Norway
NP	Nepal
NR	Nauru
NU	Niue
NZ	New Zealand
OM	Oman
PA	Panama
PE	Peru
PF	French Polynesia
PG	Papua New Guinea
PH	Philippines
PK	Pakistan
PL	Poland
PM	Saint Pierre and Miquelon
PN	Pitcairn
PR	Puerto Rico
PT	Portugal
PW	Palau
PY	Paraguay
QA	Qatar
RE	Réunion
RO	Romania
RU	Russian Federation
RW	Rwanda

SA	Saudi Arabia
SB	Solomon Islands
SC	Seychelles
SD	Sudan
SE	Sweden
SG	Singapore
SH	Saint Helena
SI	Slovenia
SJ	Svalbard and Jan Mayen
SK	Slovakia
SL	Sierra Leone
SM	San Marino
SN	Senegal
SO	Somalia
SR	Suriname
ST	Sao Tome and Principe
SV	El Salvador
SY	Syrian Arab Republic
SZ	Swaziland
TC	Turks and Caicos Islands
TD	Chad
TF	French Southern Territories
TG	Togo
TH	Thailand
TJ	Tajikistan
TK	Tokelau
TM	Turkmenistan
TN	Tunisia
TO	Tonga
TP	East Timor
TR	Turkey
TT	Trinidad and Tobago
TV	Tuvalu
TW	Taiwan, Province of China
TZ	Tanzania, United Republic of
UA	Ukraine
UG	Uganda
UM	United States Minor Outlying Islands
US	United States
UY	Uruguay
UZ	Uzbekistan
VA	Vatican City State (Holy See)
VC	Saint Vincent and the Grenadines
VE	Venezuela
VG	Virgin Islands (British)
VI	Virgin Islands (U.S.)
VN	Vietnam
VU	Vanuatu
WF	Wallis and Futuna Islands
WS	Samoa
YE	Yemen
YT	Mayotte
YU	Yugoslavia
ZA	South Africa
ZM	Zambia
ZR	Zaire
ZW	Zimbabwe

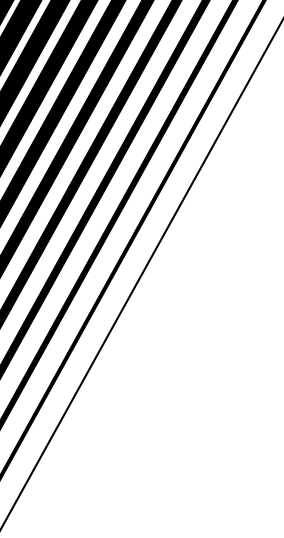

JVC
VICTOR COMPANY OF JAPAN, LIMITED

Free Manuals Download Website

<http://myh66.com>

<http://usermanuals.us>

<http://www.somanuals.com>

<http://www.4manuals.cc>

<http://www.manual-lib.com>

<http://www.404manual.com>

<http://www.luxmanual.com>

<http://aubethermostatmanual.com>

Golf course search by state

<http://golfingnear.com>

Email search by domain

<http://emailbydomain.com>

Auto manuals search

<http://auto.somanuals.com>

TV manuals search

<http://tv.somanuals.com>