

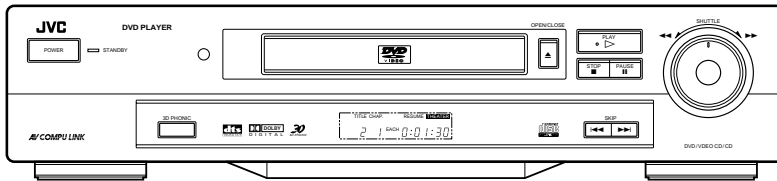

DVD VIDEO PLAYER

XV-521BK



Introduction	1
Preliminary knowledge	4
Getting started	12
Basic operations	17
Advanced operations	20
Initial settings	35
Additional information	41

INSTRUCTIONS

For Customer Use:

Enter below the Model No. and Serial No. which are located on the rear, bottom or side of the cabinet. Retain this information for future reference.

Model No. _____

Serial No. _____

LVT0435-011A

[1U]

Warnings, Cautions and Others Mises en garde, précautions et indications diverses

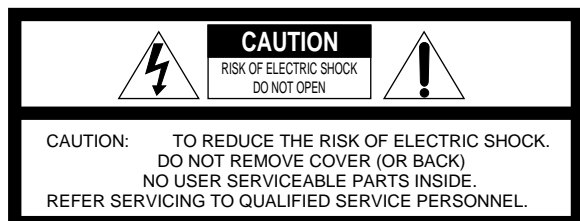

The lightning flash with arrowhead symbol, within an equilateral triangle is intended to alert the user to the presence of uninsulated "dangerous voltage" within the product's enclosure that may be of sufficient magnitude to constitute a risk of electric shock to persons.



The exclamation point within an equilateral triangle is intended to alert the user to the presence of important operating and maintenance (servicing) instructions in the literature accompanying the appliance.

For U.S.A.

This equipment has been tested and found to comply with the limits for a Class B digital device, pursuant to part 15 of the FCC Rules. These limits are designed to provide reasonable protection against harmful interference in a residential installation.

This equipment generates, uses and can radiate radio frequency energy and, if not installed and used in accordance with the instructions, may cause harmful interference to radio communications. However, there is no guarantee that interference will not occur in a particular installation. If this equipment does cause harmful interference to radio or television reception, which can be determined by turning the equipment off and on, the user is encouraged to try to correct the interference by one or more of the following measures:

Reorient or relocate the receiving antenna.

Increase the separation between the equipment and receiver.

Connect the equipment into an outlet on a circuit different from that to which the receiver is connected.

Consult the dealer or an experienced radio/TV technician for help.

WARNING: TO REDUCE THE RISK OF FIRE OR ELECTRIC SHOCK, DO NOT EXPOSE THIS APPLIANCE TO RAIN OR MOISTURE.

For Canada/pour le Canada

CAUTION: TO PREVENT ELECTRIC SHOCK, MATCH WIDE BLADE OF PLUG TO WIDE SLOT, FULLY INSERT

ATTENTION: POUR EVITER LES CHOCS ELECTRIQUES, INTRODUIRE LA LAME LA PLUS LARGE DE LA FICHE DANS LA BORNE CORRESPONDANTE DE LA PRISE ET POUSSER JUSQU'AU FOND

For Canada/pour le Canada

THIS DIGITAL APPARATUS DOES NOT EXCEED THE CLASS B LIMITS FOR RADIO NOISE EMISSIONS FROM DIGITAL APPARATUS AS SET OUT IN THE INTERFERENCE-CAUSING EQUIPMENT STANDARD ENTITLED "DIGITAL APPARATUS", ICES-003 OF THE DEPARTMENT OF COMMUNICATIONS.

CET APPAREIL NUMERIQUE RESPECTE LES LIMITES DE BRUITS RADIOELECTRIQUES APPLICABLES AUX APPAREILS NUMERIQUE DE CLASSE B PRESCRITES DANS LA NORME SUR LE MATERIEL BROUILLEUR: "APPAREILS NUMERIQUE", NMB-003 EDICTEE PAR LE MINISTRE DES COMMUNICATIONS.

CAUTION

To reduce the risk of electrical shocks, fire, etc.:

1. Do not remove screws, covers or cabinet.
2. Do not expose this appliance to rain or moisture.

ATTENTION

Afin d'éviter tout risque d'électrocution, d'incendie, etc.:

1. Ne pas enlever les vis ni les panneaux et ne pas ouvrir le coffret de l'appareil.
2. Ne pas exposer l'appareil à la pluie ni à l'humidité.

Caution — POWER switch!

Disconnect the mains plug to shut the power off completely. The POWER switch in any position does not disconnect the mains line. The power can be remote controlled.

Attention — Commutateur POWER!

Déconnecter la fiche de secteur pour couper complètement le courant. Le commutateur POWER ne coupe jamais complètement la ligne de secteur, quelle que soit sa position. Le courant peut être télécommandé.

IMPORTANT FOR LASER PRODUCTS IMPORTANT POUR LES PRODUITS LASER

1. CLASS 1 LASER PRODUCT
 2. **DANGER:** Visible laser radiation when open and interlock failed or defeated. Avoid direct exposure to beam.
 3. **CAUTION:** Do not open the top cover. There are no user serviceable parts inside the Unit; leave all servicing to qualified service personnel.
1. PRODUIT LASER CLASSE 1
 2. **ATTENTION:** Radiation laser visible quand l'appareil est ouvert ou que le verrouillage est en panne ou désactivé. Eviter une exposition directe au rayon.
 3. **ATTENTION:** Ne pas ouvrir le couvercle du dessus. Il n'y a aucune pièce utilisable à l'intérieur. Laisser à un personnel qualifié le soin de réparer votre appareil.

Table of contents

Introduction	Page 1	
Features	1	
Supplied accessories	1	
About this instruction manual	2	
Notes on handling	3	
Preliminary knowledge	Page 4	
Names of parts and controls		
Front panel	4	
Remote control unit	5	
Display window	7	
Rear panel	7	
Operational Principles		
On-screen displays	8	
To prevent the monitor from burning out [SCREEN SAVER]	9	
On-screen guide icons	10	
How to use numeric buttons	10	
About discs		
Playable disc types	11	
Disc structure	11	
Getting started	Page 12	
Connections		
Before making any connections	12	
To connect to a TV	12	
To connect to a TV with the component video input jacks	13	
To connect to an audio amplifier or receiver	13	
To connect to audio equipment with a digital input	14	
To connect the power cord	14	
Using the remote control unit		
To install batteries in the remote control unit	15	
To use the remote control unit for TV operation	16	
To control the volume of a JVC's amplifier or receiver	16	
Basic operations	Page 17	
Turning on/off the unit	17	
Inserting and removing discs	17	
Basic playback		
To start playback	18	
To stop playback completely	18	
To stop playback temporarily	18	
To advance or reverse playback rapidly while monitoring	18	
To locate the beginning of the scene or song	19	
To resume playback		
To memorize the interrupted position	19	
To resume playback	19	
Advanced operations	Page 20	
Playing from a specific position on a disc		
To locate a desired scene from the DVD menu	20	
To locate a desired scene from the menu of the Video CD with PBC	20	
To locate a desired selection using the numeric buttons	21	
		To locate a desired selection using ◀◀ or ▶▶
		To locate a desired scene by specifying the chapter number [CHAP. SEARCH]
		To locate a desired position in the current title or track [TIME SEARCH]
		To locate a desired scene from the digest display [DIGEST]
		Special picture playback
		To advance a still picture frame-by-frame
		To display still pictures [STROBE]
		To playback in slow-motion [SLOW]
		To zoom a scene [ZOOM]
		Changing the playback order
		To playback in the desired order [PROGRAM]
		To playback in random order [RANDOM]
		Repeat playback
		To repeat the current selection or all disc contents [REPEAT]
		To repeat a desired part [A-B REPEAT]
		Selecting a scene angle of DVD VIDEO
		To select a scene angle from the normal screen [ANGLE]
		To select a scene angle from the angle list display [ANGLE]
		Changing the language and sound
		To select the subtitle language [SUBTITLE]
		To change the audio language or sound [AUDIO]
		Selecting the picture character
		To select the picture character [THEATER POSITION]
		Enjoying virtual surround sound
		To simulate surround sound [3D PHONIC]
		Checking the status
		To check the disc/time information
		To check the DVD function status
		Initial settings
		Page 35
		Selecting preferences
		How to set preferences
		LANGUAGE page
		AUDIO page
		DISPLAY page
		SYSTEM page
		Limiting playback by children
		To set Parental Lock for the first time [PARENTAL LOCK]
		To change the settings [PARENTAL LOCK]
		To temporarily release the Parental lock [PARENTAL LOCK]
		Additional information
		Page 41
		AV COMPU LINK remote control system
		Connection and setup
		Operation
		Care and handling of discs
		Troubleshooting
		Specifications
		Table of languages and their abbreviations
		Appendix A
		Country code list for parental lock
		Appendix B

Features

Picture functions

- **Strobe function**
The unit can display nine continuous still pictures on the TV screen.
- **Digest function**
You can select the desired title from the opening scenes displayed on the TV screen.
- **Angle function***
You can select a desired angle from multiple camera angles recorded on the DVD VIDEO disc.
- **Zoom function**
You can view scenes close-up.
- **Parental lock***
You can restrict the playback of DVD VIDEO discs with scenes which you do not want children to see, such as adult or violent films.
- **Theater position**
You can select the picture character according to the lighting of your room.

Audio functions

- **High quality digital sound**
You can enjoy high quality sound with Dolby Digital or Linear-PCM.
- **Surround function***
The unit is compatible with Dolby Digital surround and DTS surround.
(DTS surround is available for digital output only.)
- **3D Phonic function**
You can enjoy surround sound with your 2-channel system.

Other functions

- **Multi-language subtitles and sound***
You can select a subtitle or sound language from those recorded on the DVD VIDEO disc.
- **Multi-disc playback**
You can enjoy Audio CD discs and Video CD discs, as well as DVD VIDEO discs.
- **Operation from the on-screen display**
User-friendly on-screen displays allow you to operate the unit easily.

Functions with (*) mark only work on a DVD VIDEO disc that is compatible with each function.

Supplied accessories

- Audio/video cable (x 1)

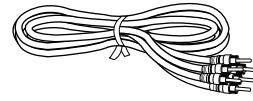

- S-video cable (x 1)



- AV compulink cord (x 1)

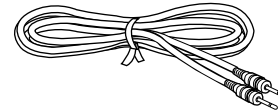

- Remote Control Unit (x 1)

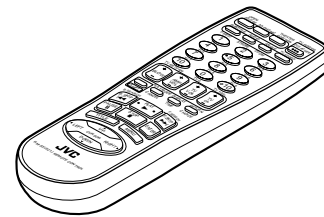

- R6P(SUM-3)/AA(15F) batteries (x 2)

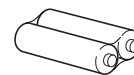

- Instruction manual (x 1)

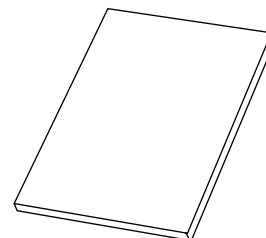

- AC power cord (x 1)

- AC plug adapter (x 1)

About this instruction manual

This instruction manual basically explains operations as follows:

To playback in random order [RANDOM]



These symbols indicate the types of discs which the operation can be used for.

You can play titles or tracks in random order by using the Random function.

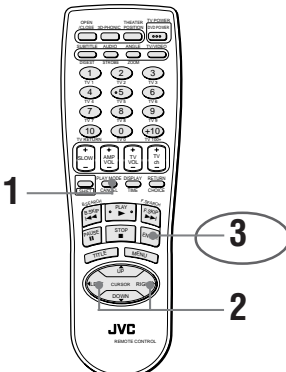



1 points to the PLAY MODE - CANCEL button, 2 points to the CURSOR buttons, and 3 points to the ENTER button.

The number indicates the following procedural step(s) in which the button(s) is(are) used. You may also use the corresponding buttons on the front panel of the unit if available.

■ While stopped

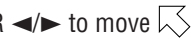
1 Press **PLAY MODE - CANCEL**.
The play mode menu appears on the TV screen.

2 Use **CURSOR**  to move  to **[RANDOM]**.

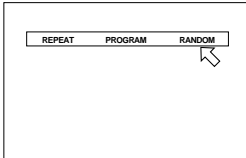

The "RANDOM" indicator appears in the display window on the front panel.

3 Press **ENTER**.
The unit starts random playback.
After playing all titles/tracks of the disc, random playback ends.

 **Hints**
The same title or track will not be played back more than once during random play.

- **To stop/quit random playback in the middle**
Press **STOP** to stop playback. The unit is still in random playback mode, so pressing **PLAY** starts random playback again.
To quit random playback, press **STOP** again while stopped. The "RANDOM" indicator in the display window turns off.

NOTE
Some DVD VIDEO discs may not be played back correctly in random mode.

The number indicates the procedural step.

Other convenient procedures, etc.

Additional supplemental remarks

The names of buttons on the remote control unit (or on the front panel of the unit) are all given in uppercase letters.

Notes on handling

Important cautions

Installation of the unit

- Select a place which is level, dry and neither too hot nor too cold (between 5°C and 35°C, 41°F and 95°F).
- Leave sufficient distance between the unit and the TV.
- Do not use the player in a place subject to vibrations.

Power cord

- Do not handle the power cord with wet hands!
- A small amount of power (3.0 watts) is always consumed while the power cord is connected to the wall outlet.
- When unplugging the player from the wall outlet, always pull the plug, not the power cord.

To prevent malfunction of the unit

- There are no user-serviceable parts inside. If anything goes wrong, unplug the power cord and consult your dealer.
- Do not insert any metallic object into the unit.
- Do not use any non-standard shape disc available on the market, because it may damage the unit.
- Do not use a disc with tape, seals, or paste on it, because damage to the unit may result.

Note about copyright laws

- Please check the copyright laws in your country before recording from DVD VIDEO, Audio CD, and Video CD discs. Recording of copyrighted material may infringe copyright laws.

Note about the copyguard system

- The DVD VIDEO disc is protected by the copyguard system. When you connect the unit to your VCR directly, the copyguard system activates and the picture may not be played back correctly.

Safety precautions

Avoid moisture, water and dust

Do not place the unit in moist or dusty places.

Avoid high temperatures

Do not expose the unit to direct sunlight or place it near a heating device.

When you're away

When away on travel or otherwise for an extended period of time, remove the plug from the wall outlet.

Do not insert foreign objects into the unit

Do not insert wires, hairpins, coins, etc. into the unit.

Do not block the vents

Blocking the vents may damage the unit.

Care of the cabinet

When cleaning the unit, use a soft cloth and follow the relevant instructions on the use of chemically-coated cloths. Do not use benzene, thinner or other organic solvents and disinfectants. These may cause deformation or discoloring.

If water gets inside the unit

Turn off the power switch and remove the plug from the wall outlet, then call the store where you made your purchase. Using the unit in this state may cause a fire or electrical shock.

This product incorporates copyright protection technology that is protected by method claims of certain U.S. patents and other intellectual property rights owned by Macrovision Corporation and other rights owners. Use of this copyright protection technology must be authorized by Macrovision Corporation, and is intended for home and other limited viewing uses only unless otherwise authorized by Macrovision Corporation. Reverse engineering or disassembly is prohibited.

Manufactured under license from Dolby Laboratories. "Dolby" and double-D symbol are trademarks of Dolby Laboratories.

Confidential Unpublished Works.

© 1992-1997 Dolby Laboratories, Inc. All rights reserved.

Manufactured under license from Digital Theater Systems, Inc. US Pat. No. 5,451,942 and other world-wide patents issued and pending. "DTS", "DTS Digital Surround", are trademarks of Digital Theater Systems, Inc.

© 1996 Digital Theater Systems, Inc. All Rights Reserved.

Names of parts and controls

Refer to the corresponding pages indicated in () for details.

Front panel

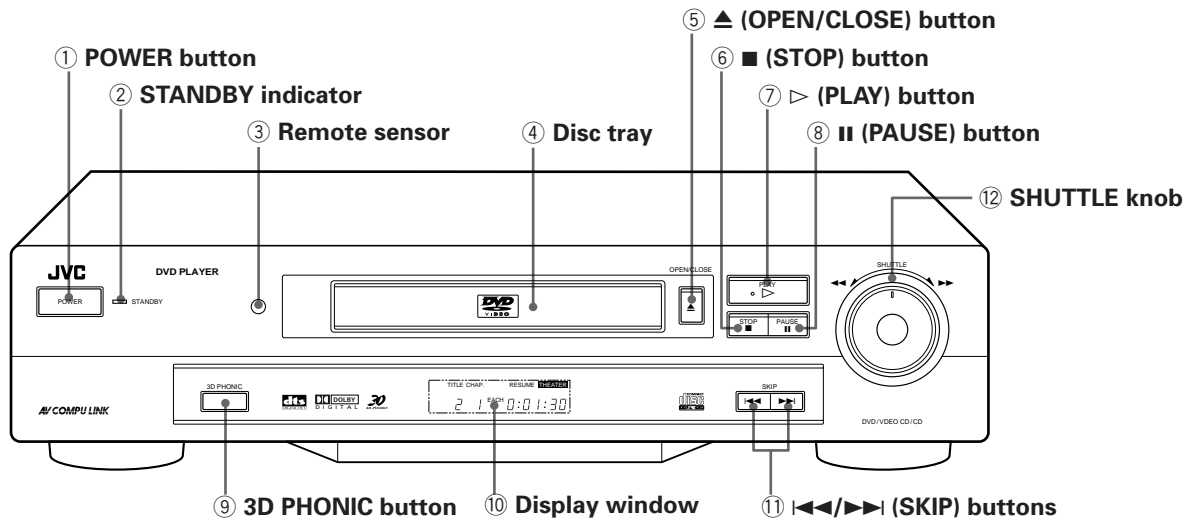

① **POWER button (17)**

Turns the unit on or off (standby).

② **STANDBY indicator**

Lights when the power cord is connected and the unit is on standby. When the unit is turned on, the STANDBY indicator goes off.

③ **Remote sensor**

Receives the signal from the remote control unit.

④ **Disc tray (17)**

Used to load a disc.

⑤ **▲ (OPEN/CLOSE) button (17)**

Used to open and close the disc tray.

⑥ **■ (STOP) button (18)**

Stops playback.
Also used to erase all programmed tracks for the program play.

⑦ **▷ (PLAY) button (18)**

Starts playback. Also, used as a SELECT button for the PBC of Video CDs.

⑧ **|| (PAUSE) button (18)**

Pauses playback.

⑨ **3D PHONIC button (32)**

Produces a simulated surround effect.

⑩ **Display window**

Indicates the current status of the unit.

⑪ **◀◀/▶▶ (SKIP) buttons (19, 21)**

Used to skip a chapter, title or track.
Also, used for the page selection of a menu screen (for DVD VIDEO/Video CD).
Holding down ◀◀ or ▶▶ during playback reverses or advances playback rapidly.

⑫ **SHUTTLE knob (19, 25)**

Performs rapid advance/reverse playback operations.
Also used for slow-motion playback of a picture (for DVD VIDEO/Video CD).

Remote control unit

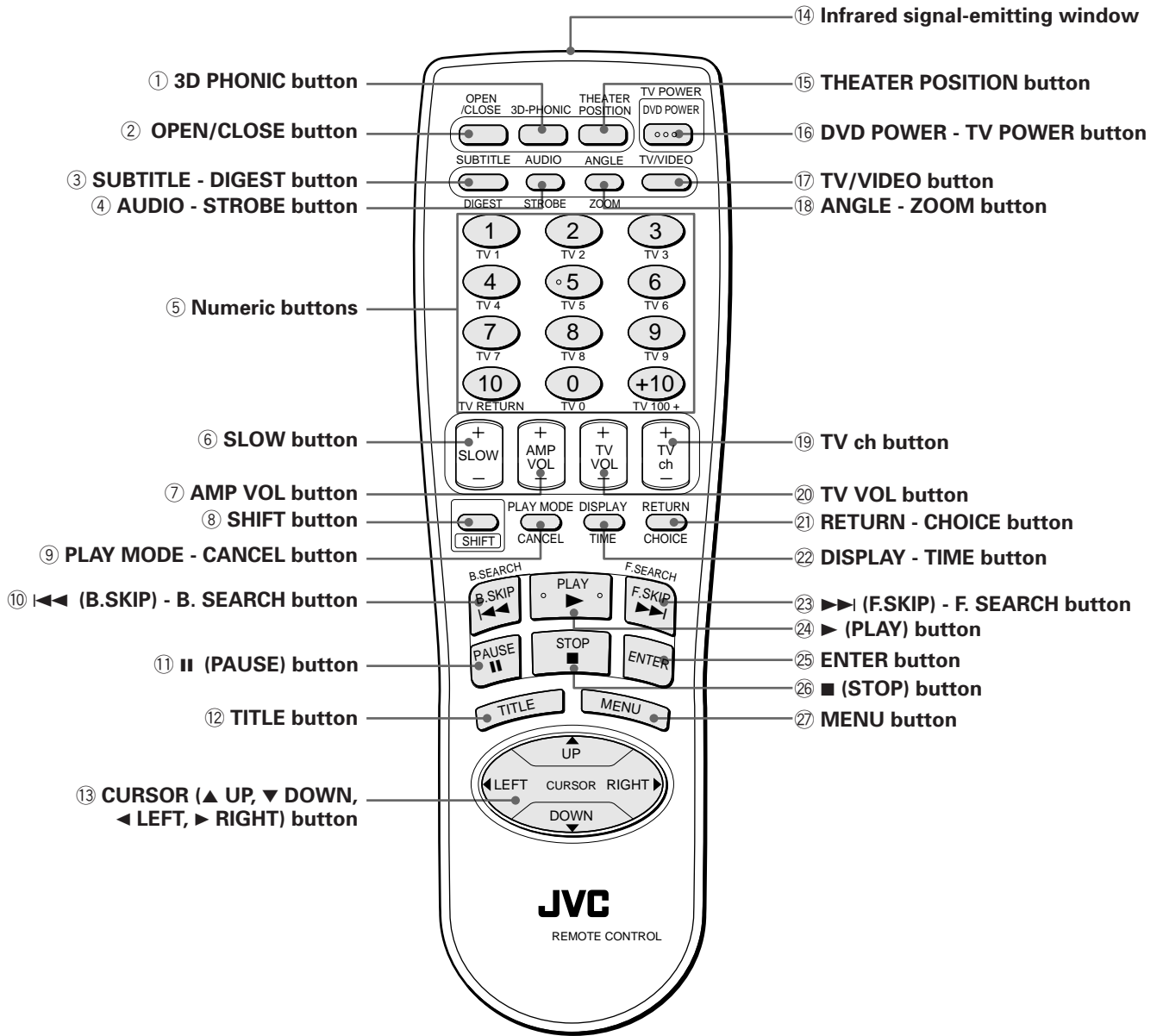

- ① **3D PHONIC button (32)**
Produces a simulated surround effect.
- ② **OPEN/CLOSE button (17)**
Opens and closes the disc tray.
- ③ **SUBTITLE - DIGEST button (23, 31)**
Used to display the subtitle selection display on the TV screen, as well as used to turn the subtitle on or off (for DVD VIDEO).
Pressing this button while holding down the SHIFT button displays beginning scenes of each title, chapter or track on the TV screen (for DVD VIDEO/Video CD).
- ④ **AUDIO - STROBE button (24, 31)**
Selects the audio (for DVD VIDEO/Video CD). Pressing this button while holding down the SHIFT button displays nine continuous still pictures (for DVD VIDEO/Video CD).
- ⑤ **Numeric buttons (10, 16)**
Used to select a title or track number, as well as used to enter a time for the Time search and a chapter number for the Chapter search.
Also used to select a TV channel in conjunction with the SHIFT button.
- ⑥ **SLOW button (25)**
Used for slow-motion playback of a picture (for DVD VIDEO/Video CD).
- ⑦ **AMP VOL button (16)**
Used to control the volume of a JVC audio amplifier/receiver.
- ⑧ **SHIFT button**
Used together with other buttons for activating their second functions.
- ⑨ **PLAY MODE - CANCEL button (27)**
Displays an on-screen display for controlling the advanced playback functions. Pressing this button while holding down the SHIFT button cancels the last selection of the program.
- ⑩ **◀◀ (B.SKIP) - B. SEARCH button (19, 21, 23)**
Skips back a chapter, title or track. Also used for the page selection of a menu screen (for DVD VIDEO/Video CD).
Holding down this button during playback reverses playback rapidly.
Pressing the button while holding down the SHIFT button during playback also reverses playback rapidly. If you press the button while holding down the SHIFT button during rapid reverse playback, the speed increases.
- ⑪ **⏸ (PAUSE) button (18)**
Pauses playback.
- ⑫ **TITLE button (20)**
Displays the title menu of a DVD VIDEO disc on the TV screen.
- ⑬ **CURSOR (▲ UP, ▼ DOWN, ◀ LEFT, ▶ RIGHT) buttons**
Used to select an item from a menu or on-screen display, or to change the setting of an item in the on-screen display.
- ⑭ **Infrared signal-emitting window**
Point this window toward the remote sensor on the front panel when pressing buttons.
- ⑮ **THEATER POSITION button (32)**
Selects a picture character from 4 options (for DVD VIDEO/Video CD).
- ⑯ **DVD POWER - TV POWER button (17)**
Turns the unit on or off (standby). Pressing this button while holding down the SHIFT button turns the TV on or off.
- ⑰ **TV/VIDEO button (16)**
Switches the TV input mode.
- ⑱ **ANGLE - ZOOM button (26, 30)**
Changes camera angles during playback of a DVD VIDEO disc containing multiple camera angles. Pressing this button while holding down the SHIFT button zooms in the picture (for DVD VIDEO/Video CD).
- ⑲ **TV ch button (16)**
Changes the TV channels.
- ⑳ **TV VOL button (16)**
Adjusts the TV volume.
- ㉑ **RETURN - CHOICE button (20, 35)**
Returns to the previous menu (for DVD VIDEO/Video CD).
Pressing this button while holding down the SHIFT button displays Preference on-screen display on the TV screen.
- ㉒ **DISPLAY - TIME button (33, 34)**
Displays the status information (only for DVD disc) or the time information (for any disc types). When the time information appears, pressing this button while holding the SHIFT button changes the time mode.
- ㉓ **▶▶ (F.SKIP) - F. SEARCH button (19, 21, 23)**
Skips forward a chapter, title or track. Also used for the page selection of a menu screen (for DVD VIDEO/Video CD).
Holding down this button during playback advances playback rapidly.
Pressing the button while holding down the SHIFT button during playback also advances playback rapidly. If you press the button while holding down the SHIFT button during rapid advance playback, the speed increases.
- ㉔ **▶ (PLAY) button (18)**
Starts playback. Also used as a SELECT button for PBC of Video CDs.
- ㉕ **ENTER button**
Executes the selected item in a menu or on-screen display.
- ㉖ **■ (STOP) button (18)**
Stops playback.
Also used to erase all the programmed tracks for the program play.
- ㉗ **MENU button (20)**
Displays a DVD menu on the TV screen.

Display window

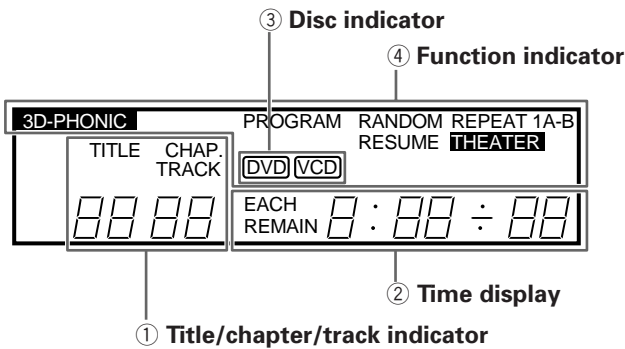

- ① **Title/chapter/track indicator**
Displays title/chapter, or track number.
- ② **Time display**
Shows the cumulative or remaining time of the track or disc, or the total disc time.
- ③ **Disc indicator**
Indicates the type of the disc set in the tray. When a DVD VIDEO or Video CD disc is set, "DVD" or "VCD" is indicated. When an Audio CD is set, there is no indication.
- ④ **Function indicator**
Activated function indicators light up.

Rear panel

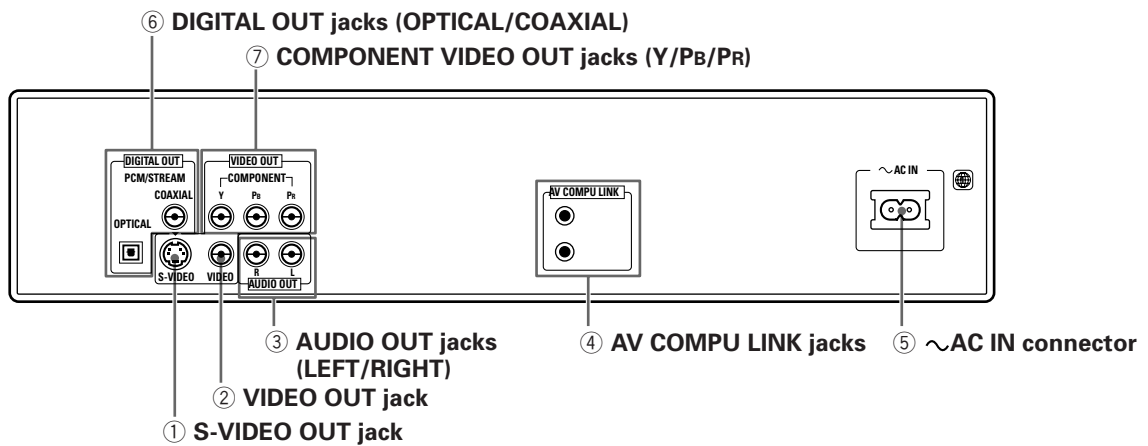

- ① **S-VIDEO OUT jack (12)**
Outputs an S-video signal.
- ② **VIDEO OUT jack (12)**
Outputs a composite video signal.
- ③ **AUDIO OUT jacks (L/R) (12)**
Output stereo analog audio signals.
- ④ **AV COMPU LINK jacks (41)**
Connect with other JVC equipment supporting the AV Compulink function to facilitate integrated operations.
- ⑤ **~ AC IN connector (14)**
Connects to the wall outlet using the supplied AC power cord.
- ⑥ **DIGITAL OUT jacks (14)**
Output digital audio signals. You must select the signal type correctly according to the external device connected to via the Preference display.
- ⑦ **COMPONENT VIDEO OUT jacks (Y/Pb/Pr) (13)**
Output component video signals.

Operational Principles

On-screen displays

The unit provides several on-screen displays. With some displays, you can set or select preferences or functions, while the others are display-only.

Opening displays

The Opening display appears automatically in some conditions. At the bottom, the following information are indicated depending on the unit's status.

- NOW READING: The unit is now reading the disc information (TOC).
- REGION CODE ERROR!: The DVD VIDEO disc loaded cannot be played because the region code of the disc does not match the unit.
- OPEN: The disc tray is now opening.
- CLOSE: The disc tray is now closing.

Opening display



Preference displays

When the unit is stopped, pressing the RETURN-CHOICE button while holding the SHIFT button accesses the preference display for setting the preferences.

There are four pages: LANGUAGE, AUDIO, DISPLAY and SYSTEM as shown in the right. See page 35 for detailed information.

LANGUAGE

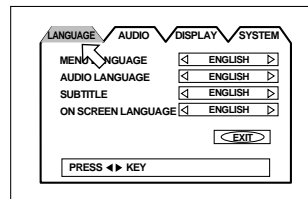

AUDIO

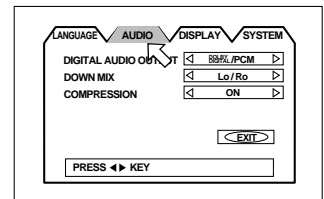

DISPLAY

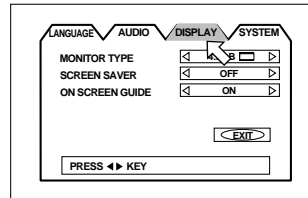

SYSTEM

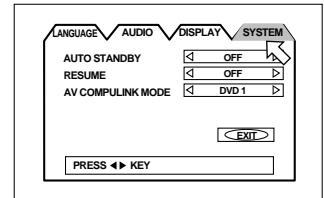

PARENTAL LOCK displays

When no disc is inserted or a DVD VIDEO disc is stopped, pressing the ENTER button while holding down the SHIFT button accesses the PARENTAL LOCK display in which you can set the level for limiting playback.

See page 39 for detailed information.

PARENTAL LOCK

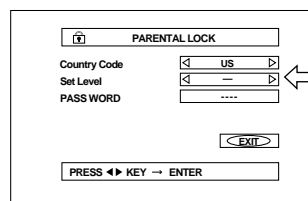

Play mode displays

Pressing the PLAY MODE button accesses the play mode display in which you can control playback functions. Different displays appear depending on the disc type and the unit's status.

While stopped

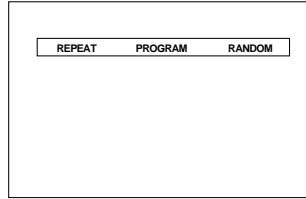

During DVD VIDEO playback

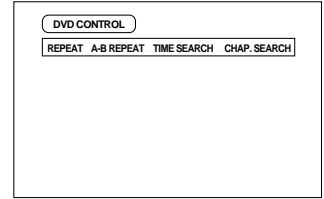

During Audio CD playback

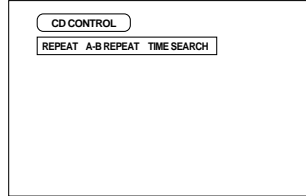

During Video CD playback

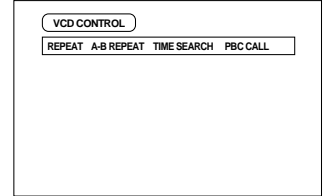

Status displays

Pressing the DISPLAY-TIME button during playback accesses the status display. For a DVD VIDEO disc, pressing the DISPLAY-TIME button toggles between the DVD VIDEO function status display, and the disc/time display and off. For a Video CD or Audio CD disc, pressing the DISPLAY-TIME button switches the disc/time display on and off.

DVD VIDEO function status

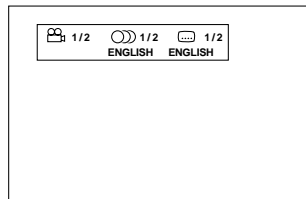

Disc/time (DVD VIDEO)

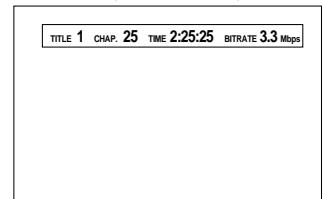

Disc/time (Audio CD/Video CD without PBC)

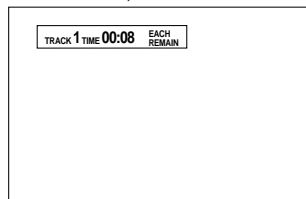

Disc/time (Video CD with PBC)

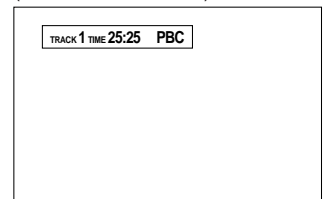

To prevent the monitor from burning out [SCREEN SAVER]

A television monitor screen may be burned out if a static picture is displayed for a long time. To prevent this, the unit automatically activates the screen saver function if a static picture, such as an on-screen display or menu, is displayed for over 5 minutes.

- Pressing any button on the unit or the remote control unit will release the screen saver function and return to the previous display.
- You can select one of several screen saver modes available (see page 37).
- The screen saver function is not activated during Audio CD playback or after stopping Audio CD playback.

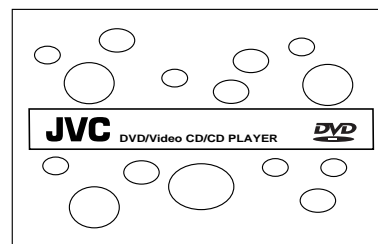

On-screen guide icons

During DVD playback, you may see icons displayed over the picture. These have the following meanings.



: Displayed at the beginning of a scene recorded from multiple angles. (See page 30.)





: Displayed at the beginning of a scene recorded with multiple audio languages. (See page 31.)



: Displayed at the beginning of a scene recorded with multiple subtitle languages. (See page 31.)

You can set the unit not to display on-screen icons above via the preference settings described on page 38.

About invalid operation icon

When you press a button, if the unit does not accept its operation,  appears on your television screen. Operations are occasionally unacceptable even if  is not displayed.

Note that some operations may not be accepted. For example, some discs may not allow rapid advance/reverse or slow-motion playback.

How to use numeric buttons

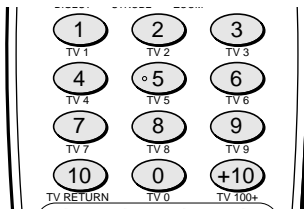

To select a track/title number

- **To select a number between 1 and 10**
Press the corresponding button for the number.
- **To select a number higher than 10**
Use the +10 button.

Examples:

To select 13 +10 → 3

To select 34 +10 → +10 → +10 → 4

To select 40 +10 → +10 → +10 → 10

To enter a time or chapter number

The method for entering a time for Time search or chapter number for Chapter search is different from above. See the corresponding sections in this manual for the details.

To select a TV channel.





Press the corresponding numeric buttons (between 0 and 9) while holding down the SHIFT button.

About discs

Playable disc types

Playable and non-playable disc types are as follows:

Playable discs

DVD VIDEO 	Video CD  	Audio CD 	CD-R CD-RW
--	---	--	---------------

The DVD VIDEO Logo is a trademark.

- CD-R and CD-RW discs recorded with the audio CD format can be played back, though some may not be played back because of the disc characteristics or recording condition.
- DVD VIDEO players and DVD VIDEO discs have their own Region Code numbers. This unit only can play back DVD VIDEO discs whose Region Code numbers include "1".

Examples of playable DVD VIDEO discs:



This unit accommodates the NTSC television system and can playback discs recorded with the NTSC system. Note that the unit cannot playback discs recorded with the PAL system.

Non-playable discs

DVD-ROM, DVD-RAM, DVD AUDIO, DVD-R, DVD-RW, CD-ROM, PHOTO CD, CD-EXTRA, CD-G, CD-TEXT

- Playing back discs listed as "Non-playable discs" above may generate noise and damage speakers.
- This unit can play back audio recorded in CD-G, CD-EXTRA and CD-TEXT discs.

Disc structure

A DVD VIDEO disc is comprised of "titles," while an Audio CD, Video CD is comprised of "tracks." Each title may be divided into some "chapters." For example, if a DVD VIDEO disc contains some movies, each movie may have its own title number, and each movie may be divided into some chapters. In a DVD VIDEO karaoke disc, each song usually has its own title number and does not have chapters. In general, each title has independent content, while each chapter in the same title has continuity.

(Example: DVD VIDEO disc)

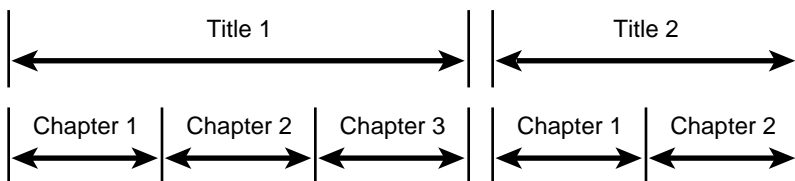

(Example: Audio CD/Video CD)

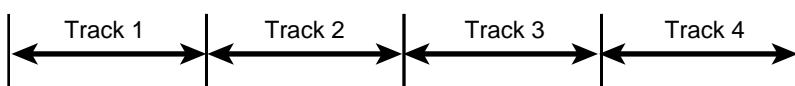

Connections

*In the following description, "TV" may be substituted with "monitor" or "projector."

*Before using the unit, you have to connect the unit to a TV and/or amplifier.

Before making any connections

- Do not connect the AC power cord until all other connections have been made.
- Since different components often have different terminal names, carefully read the instructions supplied with the component you are going to connect.

To connect to a TV

You can enjoy using the unit by simply connecting it to a TV. To improve audio sound quality, connect the audio outputs to your separate audio equipment. (See the following pages.)

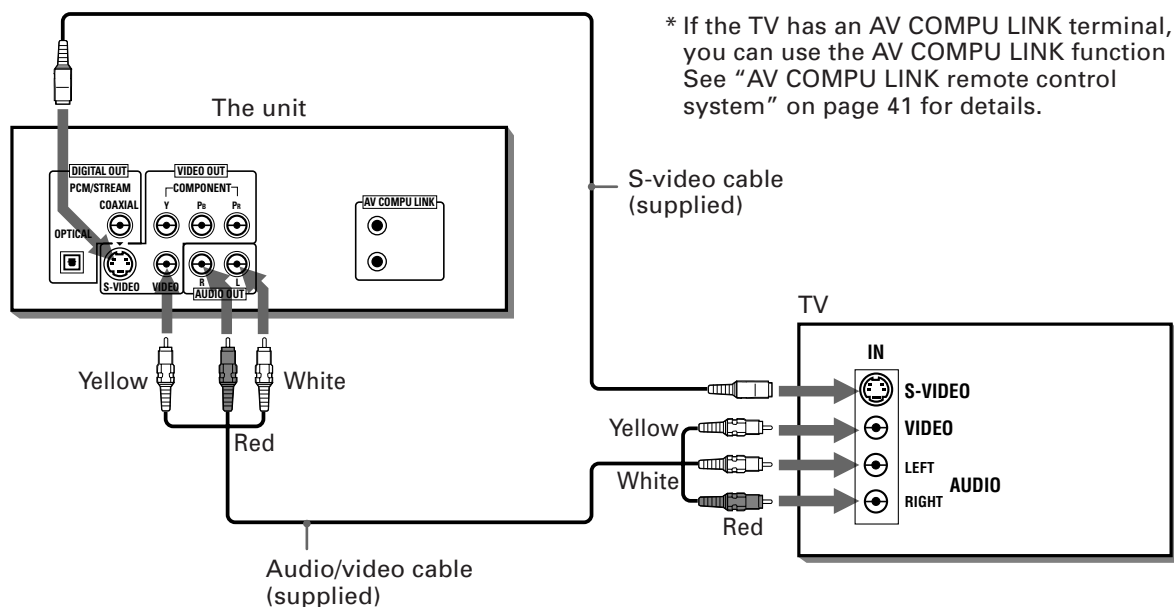

Connect the unit to a TV equipped with stereo audio input and video input jacks using the supplied audio/video cables.

- If your TV has a monaural audio input instead of stereo, you need to use an optional audio cable which converts stereo audio output to monaural.
- If your TV has an S-video input, you should connect it with the S-VIDEO output of the unit using the supplied S-video cable in addition to the (standard) video connection to get better picture quality.

NOTES

- Connect VIDEO OUT of the unit directly to the video input of your TV. Connecting VIDEO OUT of the unit to a TV via a VCR may cause a monitor problem when playing back a copy-protected disc.
- Connect the unit to an NTSC television. Do not connect the unit to a PAL television.

To connect to a TV with the component video input jacks

You can enjoy high picture quality by connecting the unit's COMPONENT VIDEO OUT jacks to the COMPONENT VIDEO IN jacks of your TV with the video cables.

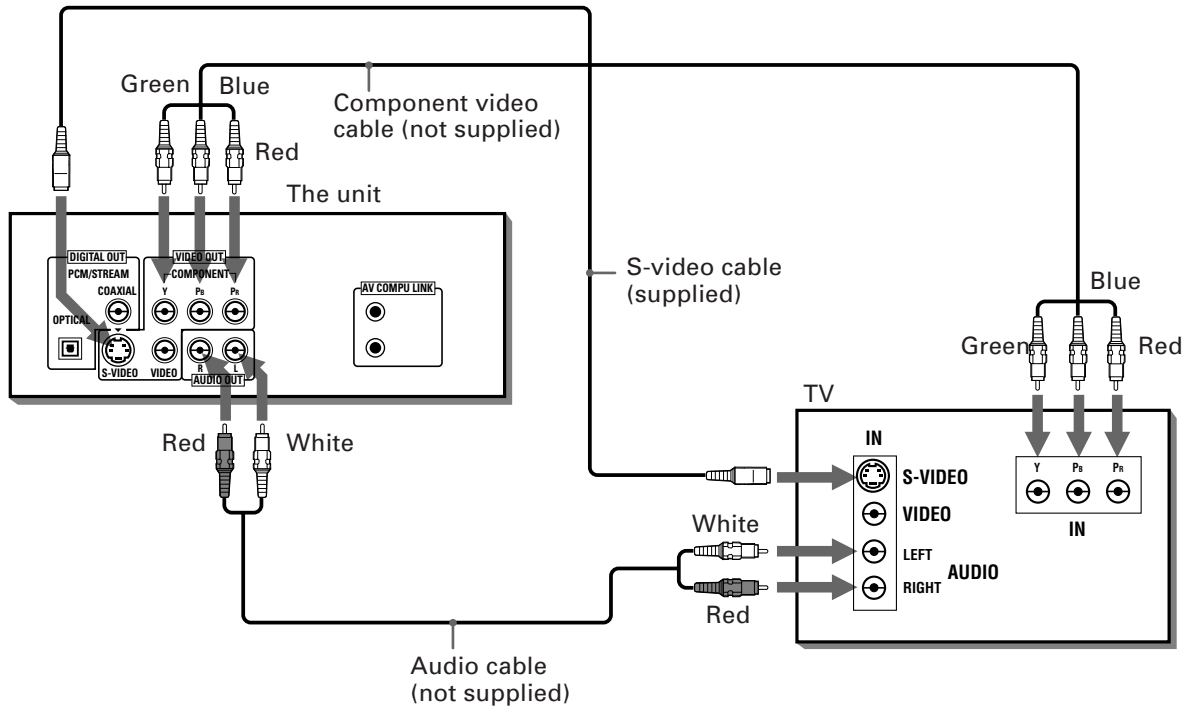

- Connect "Y" to "Y," "PB" to "PB," and "PR" to "PR" correctly.

NOTES

- When the component video input jacks of the TV are of the BNC type, use an adapter to convert the pin jacks to BNC jacks (optional).
- If you do not connect the unit with the S-video cable, some functions of your TV may not work.
- Connect the unit to an NTSC television. Do not connect the unit to a PAL television.

To connect to an audio amplifier or receiver

You can enjoy high-quality audio by connecting the unit's audio output to your amplifier or receiver.

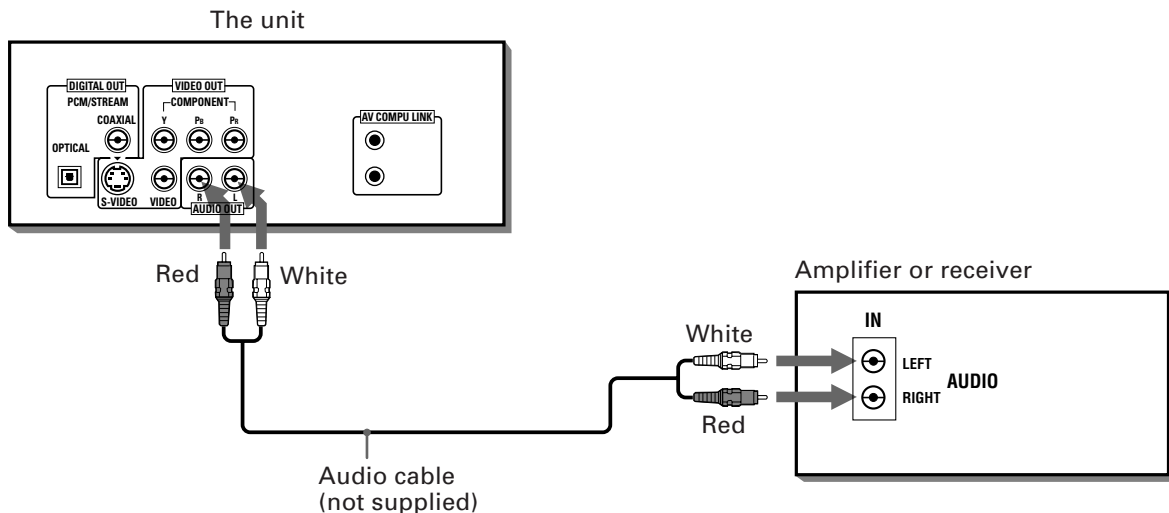

- Connect the unit's AUDIO OUT to any line-level inputs (such as AUX, DVD, CD, etc.) of an audio amplifier or receiver.

To connect to audio equipment with a digital input

You can enhance the sound quality by connecting the unit's DIGITAL OUT to the digital input of an amplifier, DAT or MD by using an optional digital cable. The digital audio signal from a disc is directly transferred. If you connect the unit to a Dolby Digital or DTS decoder or an amplifier with a built-in decoder by using an optional digital cable, you can enjoy high-quality surround sound.

When you make the digital connection, also make the analog connection, because, depending on the disc type, no audio may be reproduced from the DIGITAL OUT.

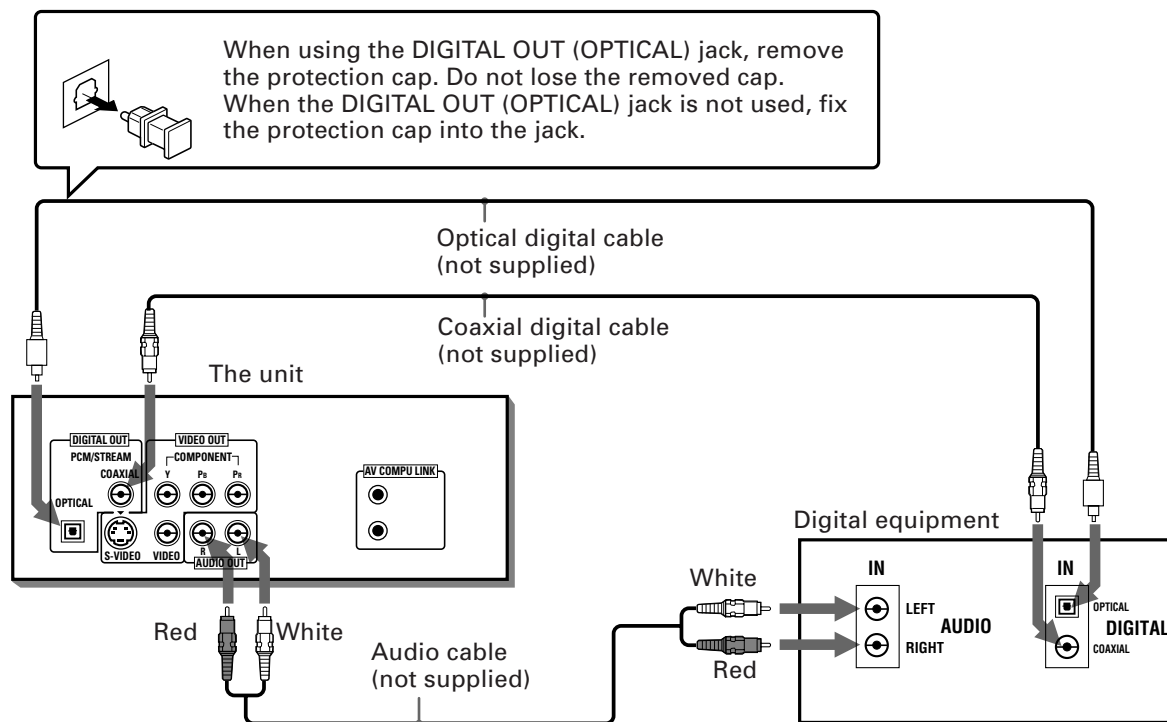

NOTES

- When you connect the unit's DIGITAL OUT to digital audio equipment, before using, make the "DIGITAL AUDIO OUTPUT" setting in the "AUDIO" page of the preference display correctly according to the connected audio equipment. If the "DIGITAL AUDIO OUTPUT" is not set correctly, loud noise may be generated from speakers, causing damage to your speakers. See "DIGITAL AUDIO OUTPUT" on page 36.
- With the digital connection, the unit's settings for COMPRESSION and DOWN MIX in the AUDIO page of the preference display are invalid. Settings for these items must be made from the decoder.

To connect the power cord

When all the audio/video connections have been made, insert the smaller plug of the supplied AC power cord to the unit's AC IN connector, then insert the other end to the wall outlet. Make sure that plugs are inserted firmly. The STANDBY indicator lights and setup is completed.

Warning

- Disconnect the power cord if you are not going to use the unit for a long time.
- Disconnect the power cord before cleaning the unit.
- Disconnect the power cord before moving the unit.
- Do not connect or disconnect the power cord with wet hands.
- Do not pull the power cord when disconnecting it, as this may damage the cord and cause fire, electric shock, or other accidents.

Caution

- Do not damage, alter, twist, or pull the power cord, as this may cause fire, electric shock, or other accidents.
- To prevent any accidents or damages caused by an unsuitable AC power cord, only use the supplied power cord. If the cord is damaged, contact a dealer and get the new power cord.
- Do not put anything heavy, or the unit, on the power cord, as this may cause fire, electric shock, or other accidents.

Using the remote control unit

Using the remote control, you can operate not only all the functions of the unit but also basic functions of your TV.

To install batteries in the remote control unit

The battery compartment is located on the back of the remote control unit.

- 1 Press down on the point shown by the arrow at the top of the compartment cover, and pull up the cover to open the compartment.

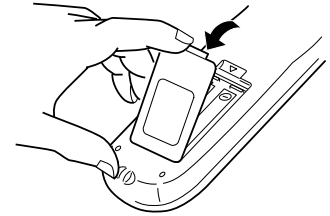

- 2 Place the two accessory R6P (SUM-3)/AA(15F) batteries in the remote control according to the polarity markings ("+" and "-") inside the compartment and on the batteries.

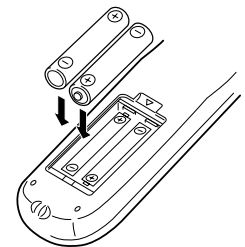

- 3 Place the cover over the compartment, and press down lightly.

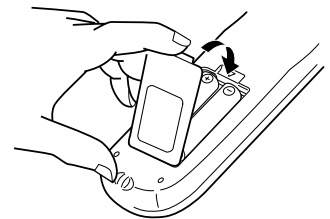

- The batteries will last about six months with normal use. If the functions of the remote control become erratic, replace the batteries. See below for more information.

Precautions for the safe use of batteries

Observe the following precautions for the safe use of batteries. If they are used improperly their life will be shortened, they may burst or their contents may leak.

Precaution

- Remove the batteries from the remote control if it is not going to be used for a long period of time.
- Remove dead batteries and dispose of them properly.
- Never leave dead batteries lying around, take them apart, mix them with other refuse, or throw them into an incinerator.
- Never touch liquid that has leaked out of a battery.
- Do not mix new and old batteries, or batteries of different types, when replacing them.

To use the remote control unit for TV operation

You can operate your TV from the remote control unit.

Setting the remote control signal for operating your TV.

- 1 Holding down TV/VIDEO, enter the manufacturer code of your TV listed below by using the numeric buttons (0 - 9). Do not release TV/VIDEO. Keep holding it until the next step is completed.

Manufacturer code list

No.	Manufacturer
01	JVC
02	MAGNAVOX
03	mitsubishi
04	PANASONIC
05	RCA
06	SHARP
07	SONY
08	TOSHIBA
09	ZENITH









No.	Manufacturer
10	HITACHI
11	PANASONIC
12	SAMSUNG
13	SANYO
14	SANYO
15	SAMSUNG

Example:

To enter the manufacturer code "01":
Press "0" then "1."

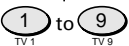
- 2 Press ■ (STOP) while holding down TV/VIDEO.

The following buttons can be used for operating the TV:

 + 	Turns the TV on or off.
	Changes the TV channels.
	Adjusts the TV volume.
 +  + 	Selects the TV channels. *For some TVs, pressing "+10" while holding down SHIFT functions as the "100+." "+10" functions as the ENTER button if your TV requires pressing the ENTER button after selecting a channel number.
 + 	Returns to the previously selected channel (only valid for JVC TVs).
	Switches input mode (either TV or VIDEO).

- 3 Try to operate your TV by pressing DVD POWER - TV POWER while holding SHIFT. If your TV turns on or off, you have successfully set the control signal.

NOTES

- The remote control unit is initially set for operating a JVC TV.
- If there is more than one code listed for the manufacturer of your TV, try them one by one until you succeed.

To control the volume of a JVC's amplifier or receiver

You can control the volume of a JVC's amplifier or receiver by using the AMP VOL button on the remote control unit.



Basic operations

In the following description, the buttons on the remote control unit are mainly used, however, you may use the corresponding buttons on the front panel of the unit if available.

Turning on/off the unit

Press POWER on the front panel or press DVD POWER - TV POWER on the remote control unit.

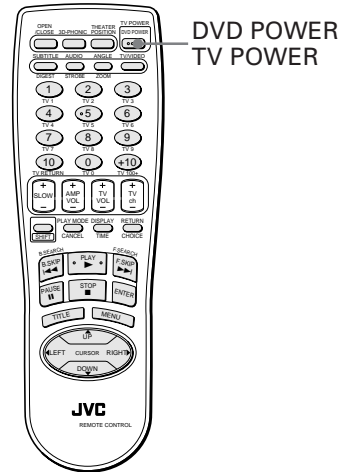
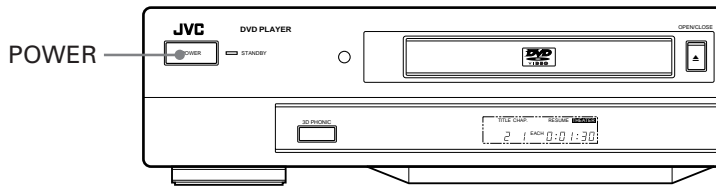

Hints

- You can turn on the unit by pressing the PLAY button on the front panel or the remote control unit. In this operation, the unit starts playback if the disc is set in the disc tray. If no disc is set, the disc tray opens.
- You can also turn on the unit by pressing the OPEN/CLOSE button on the front panel or the remote control unit. In this case, the disc tray opens.

NOTE

Even if you press the POWER or DVD POWER - TV POWER button to turn off the unit, the unit is not disconnected from the AC power source as long as it is connected to the wall outlet. This state is called the standby mode. In this state, the unit is designed to consume a very small quantity of power.

Inserting and removing discs

- 1 Press OPEN/CLOSE to open the disc tray.
- 2 Place the disc in the tray.

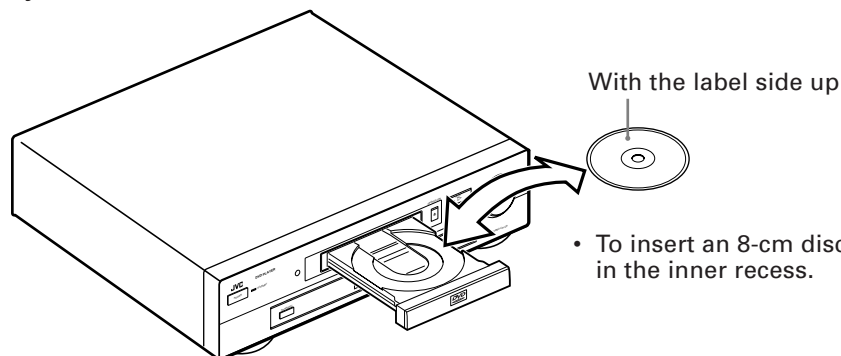

- 3 Press OPEN/CLOSE to close the disc tray.

NOTES

- The unit can playback DVD VIDEO, Audio CD, and Video CD discs only. Do not load other disc types. For details about playable disc types, see page 11.
- When loading a disc in the tray, be sure to position the disc inside the recess. Otherwise, the disc may be damaged when the tray is closed, and the disc may not be removed from the unit.

Basic playback

Now you can play a disc. First, let's enjoy simple playback according to following procedure.

To start playback

DVD VIDEO Audio CD Video CD

Press PLAY.

The unit starts playback from the beginning.

NOTES

- During playback, the display window shows the title/chapter or track number being played.
 - With Video CD discs with PBC control or some DVD discs, the menu display may appear on the TV screen after starting playback. In such a case, select an item to be played back from the menu.
- For operation using a menu, see page 20.
- With some DVD discs, the unit starts playback automatically after inserting the disc.

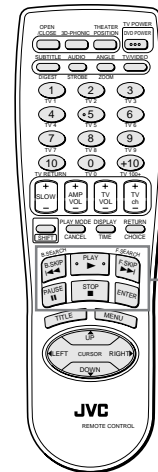

Basic control buttons

To stop playback completely

DVD VIDEO Audio CD Video CD

Press STOP.

The unit stops playback.

To stop playback temporarily

DVD VIDEO Audio CD Video CD

Press PAUSE.

The unit pauses playback. To continue playback, press PLAY.

To advance or reverse playback rapidly while monitoring

DVD VIDEO Audio CD Video CD

■ During playback

From the remote control unit

Hold down **⏮** or **⏭**.

Holding down **⏭** advances playback rapidly, while holding down **⏮** reverses playback at 5 times the normal speed.

Releasing the button returns the unit to normal playback.

or

Press **⏮** or **⏭** while holding down the SHIFT button.

Each press of **⏮** or **⏭** while holding down the SHIFT button increases the playback speed from 2x to 60x the normal speed.

Pressing PLAY returns the unit to normal playback.

From the front panel

Use the SHUTTLE knob.

To advance playback rapidly, turn the shuttle knob to the right and hold, and to reverse play rapidly, turn the shuttle knob to the left and hold. By releasing the shuttle knob, the unit returns to normal playback. The playback speed changes according to the amount you turn the shuttle knob.



Holding down the **⏮** or **⏭** button on the front panel also advances or reverses playback rapidly.

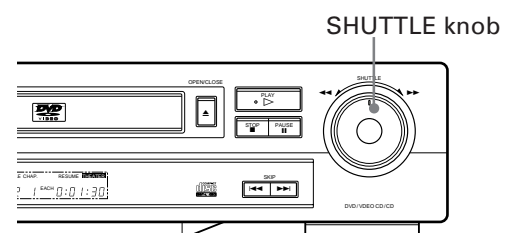

To locate the beginning of the scene or song



■ During playback

Press **⏮** or **⏭**.

Press **⏮** to locate the beginning of the current chapter, title, or track, and press **⏭** to locate the beginning of the next chapter, title, or track.

NOTE

When you play a Video CD disc with the PBC function or a DVD VIDEO disc, the unit may locate a different place, but it will generally locate the beginning of the title or chapter or track.

To resume playback

The unit can memorize the position on a disc where you interrupt playback, and resume playback from that position next time you press PLAY.

To memorize the interrupted position



- 1 Set the RESUME setting on the SYSTEM page of the preference display to ON.
(See page 38 for details about how to set.)
- 2 At the position you want to interrupt playback, press STOP, or press DVD POWER - TV POWER on the remote control or POWER on the front panel.

The unit memorizes the interrupted position, while [RESUME] lights in the display window.



If you interrupt playback by pressing STOP in step 2 above and then turn off the power, the memory is not cleared.

To resume playback



■ While the disc you interrupt playback last time is still in the disc tray.

Press PLAY.

The unit starts playback from the position where you interrupted playback last time.

● To clear the resume position memory

Operate one of the followings:

- * Take out the disc from the tray
- * Press STOP while stopped
- * Turn on the unit by pressing DVD POWER - TV POWER (on the remote control) or POWER (on the front panel).

NOTES

- Do not press POWER (on the front panel) or DVD POWER - TV POWER (on the remote control) to turn on the unit if you want to resume playback, which will clear the resume position memory.
- The resume function does not work with Audio CD discs.
- The resume function does not work if RESUME on the SYSTEM page of the preference display is set to OFF.
- In the case of a Video CD disc with PBC function, the unit may resume playback from a point slightly earlier than the resume point you stored.
- The resume function does not work in the program or random mode.

Playing from a specific position on a disc

You can play a disc from the selected track, title or chapter, or from the specified time.

To locate a desired scene from the DVD menu



DVD VIDEO discs generally have their own menus which show the disc contents. These menus contain various items such as titles of a movie, names of songs, or artist information, and display them on the TV screen. You can locate a desired scene by using the menu.

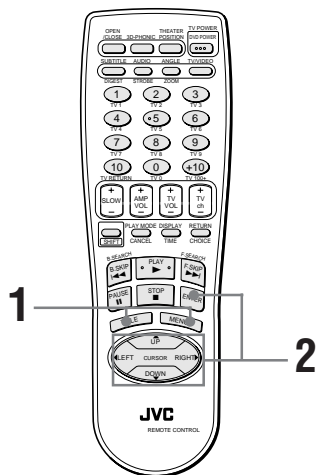

■ Whenever a DVD VIDEO disc is loaded

1 Press MENU or TITLE.

The menu appears on the TV screen.



About menu

Normally, a DVD VIDEO disc which contains more than one title may have a "title" menu which lists the titles. In this case, the menu appears on the TV screen by pressing the TITLE button. Some DVD VIDEO discs may also have a different menu which appears by pressing the MENU button.

See the instructions of each DVD VIDEO disc for its particular menu.

2 Use CURSOR ◀/▶/▲/▼ to select a desired item, then press ENTER.

The unit starts playback of the selected item.



With some discs, you can also select items by entering the corresponding number using the numeric buttons, which may cause the unit to automatically start playback.

Example

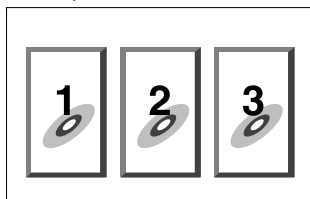

NOTES

- When appears on the TV screen by pressing TITLE in step 1:
The disc does not have a menu listing the titles.
- When appears on the TV screen by pressing MENU in step 1:
The disc does not have a menu
- The menu button does not work while stopped.

To locate a desired scene from the menu of the Video CD with PBC



Some Video CD discs are compatible with the PBC function. PBC is an abbreviation of "PlayBack Control." A Video CD disc recorded with PBC has its own menus, such as a list of the songs of the disc and items recorded on the disc. You can also locate a specific scene by using the menu.

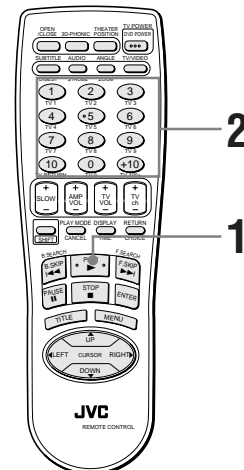

■ When a Video CD disc with PBC is stopped

1 Press PLAY.

A disc menu appears on the TV screen (The PBC function is activated).

Example:

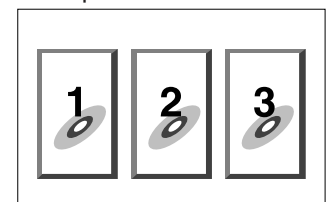

"Pbc" is indicated in the display window on the front panel.

2 Use the numeric buttons to select the desired number of the item.

- See page 10 for details about how to use the numeric buttons.

Playback starts from the selected item.

You can return to the menu by pressing RETURN - CHOICE.

When "NEXT" or "PREVIOUS" appears on the TV screen, the unit generally works as follows:

- Pressing ►► advances to the next page.
- Pressing ◀◀ returns to the previous page.
- * The method of the operation is different depending on the disc.

Hints

- To activate the PBC function when a PBC-compatible Video CD disc is being played back without the PBC function, press STOP then press PLAY.
- You can also activate the PBC function using the play mode menu display as follows.
 1. Press PLAY MODE - CANCEL.
 2. Use the CURSOR ◀▶ to move  to [PBC CALL], then press ENTER.
- If you want to playback a PBC-compatible Video CD disc without activating the PBC function, start playback by using the numeric buttons instead of the PLAY button. See the next paragraph.

To locate a desired selection using the numeric buttons

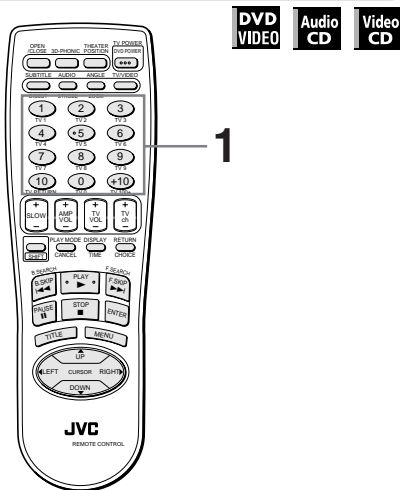

You can play a desired title (DVD VIDEO) or track (Audio CD/Video CD) by specifying the number.

- For DVD VIDEO: While stopped
- For Audio CD: Whenever an Audio CD disc is loaded
- For Video CD: During playback without PBC function or while stopped

1 Use the numeric buttons to specify the desired title or track number.

The unit starts playback from the selected title or track.

- See page 10 for details about how to use the numeric buttons.

The selected title or track number appears in the display window on the front panel.

Display window

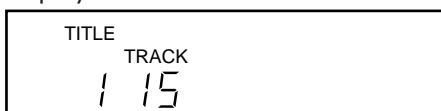

NOTES

- When  appears on the TV screen. The title or track you have specified is not contained in the disc.
- This function does not work during Video CD playback with PBC function

To locate a desired selection using ◀◀ or ►►

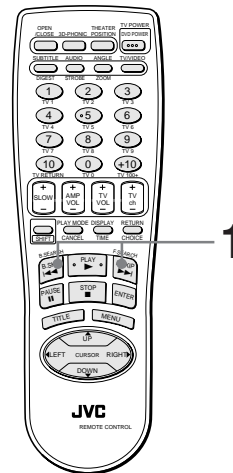

- For DVD VIDEO: During playback
- For Audio CD: During playback
- For Video CD: During playback without PBC function

1 Press ◀◀ or ►►.

With an Audio CD or Video CD, pressing the button skips a track. With a DVD VIDEO disc, pressing the button skips a chapter or title depending on the disc configuration.

The selection number appears in the display window on the front panel.

- To locate a subsequent selection, press ►► once or repeatedly until the desired selection number appears in the display.
- To locate to beginning of the current selection, press ◀◀ once.
- To locate a former selection, press ◀◀ repeatedly until the desired selection number appears in the display.

NOTES

- This function may not work with some DVD VIDEO discs.
- This function does not work during Video CD playback with PBC function

To locate a desired scene by specifying the chapter number [CHAP. SEARCH]



If the current title of a DVD VIDEO disc being played is divided into chapters, you can skip to a desired chapter by specifying the chapter number using the on-screen display.

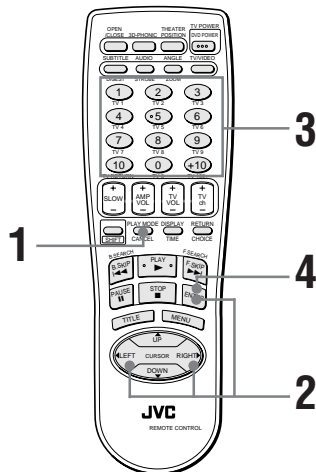

■ During DVD VIDEO playback

1 Press PLAY MODE - CANCEL.

The DVD play mode menu appears on the TV screen.

2 Use CURSOR \leftarrow/\rightarrow to move \leftarrow to [CHAP. SEARCH], then press ENTER.

"GO TO CHAPTER =" appears under the menu.

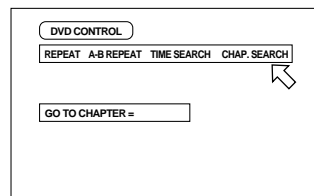

3 Use the numeric buttons (0 ~ 9) to enter the desired chapter number.

Example:

To select chapter number 8:

Press "8" → ENTER.

To select chapter number 37:

Press "3" → "7" → ENTER.

4 Press ENTER.

The unit starts playback from the selected chapter.



The "10" and "+10" buttons are not used in this function.

NOTES

- When the chapter number is incorrect in step 3:
Overwrite the incorrect number with the correct number.
- When \odot is displayed in the TV screen in step 4:
The chapter you have selected is not contained in the disc, or chapter search does not work on the disc.
- With some discs, the unit automatically starts searching for the chapter after entering the chapter number in step 3.
- To turn off the play mode menu:
Press PLAY MODE.

To locate a desired position in the current title or track [TIME SEARCH]



You can play a disc from the desired position by specifying the elapsed time from the beginning of the current title or track using the TIME SEARCH function. Note that some DVD VIDEO discs do not contain time information, and the TIME SEARCH function cannot be used.

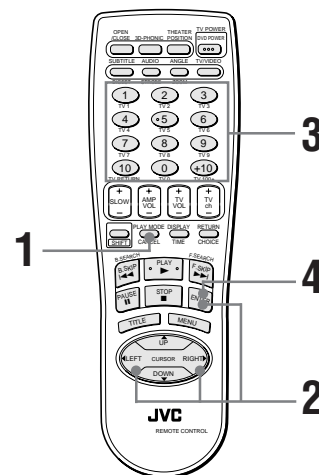

■ For DVD VIDEO: During playback

For Audio CD: During playback

For Video CD: During playback without PBC function

1 Press PLAY MODE - CANCEL.

The play mode menu appears on the TV screen.

2 Use CURSOR \leftarrow/\rightarrow to move \leftarrow to [TIME SEARCH], then press ENTER.

"GO TO" appears under the menu.

3 Use the numeric buttons (0 ~ 9) to enter the time.

You can specify the elapsed time of the current title or track to set the location which you want to playback from.

4 Press ENTER.

The unit starts playback from the specified time.

(for DVD VIDEO)

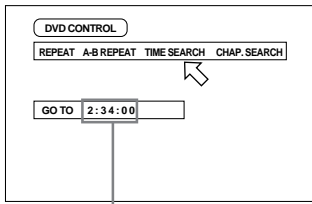

Selected time

(for Audio CD)

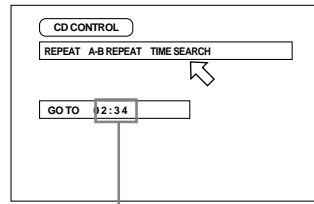

Selected time

Hints

- "10" and "+10" buttons are not used in this function.
- You can specify the time in hour/minute/second format for DVD VIDEO discs, and in minute/second format for Audio and Video CD discs.

(for Video CD)

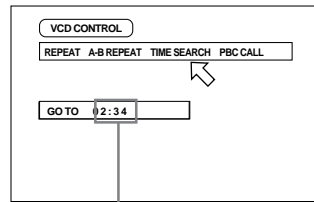

Selected time

Example (for DVD VIDEO):
To playback from 2(H):34(M):00(S)

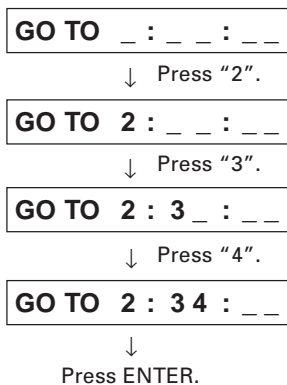

You do not have to press "0" to enter the trailing zeros (for the last two digits in the example above). Of course, it is possible to enter them.

• When you make a mistake

Move the cursor to the incorrect value, then press the correct button to re-select the value.

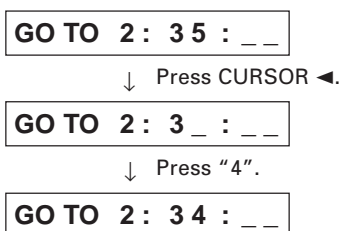

NOTES

- **When appears on the TV screen in step 2:**
The time you have selected is not contained on the disc, or the time search function does not work on the disc.
Also note that the time search function does not work during Video CD playback with the PBC function.
- **To turn off the play mode menu:**
Press PLAY MODE.
- **The TIME SEARCH function cannot be used during program playback.**

To locate a desired scene from the digest display [DIGEST]



The unit can display the opening scene of each title or chapter on a DVD VIDEO or each track of a Video CD. You can select a desired scene from those displayed on the TV screen.

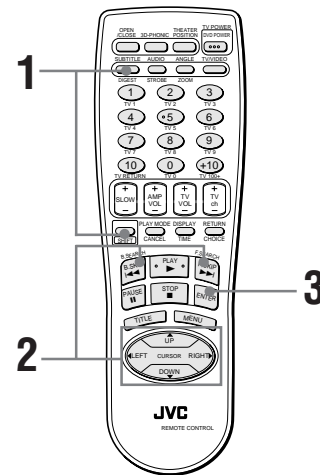

- For DVD VIDEO: While stopped or during playback
- For Video CD: While stopped or during playback without PBC function.

1 Press SUBTITLE - DIGEST while holding down SHIFT.

Up to nine opening scenes are displayed.

- While a DVD VIDEO disc is stopped:
The opening scene of each title appears on the TV screen.
- During DVD VIDEO disc playback:
The opening scene of each chapter in the current title appears on the TV screen.
- When a Video CD disc is loaded:
The opening scene of each track appears on the TV screen .

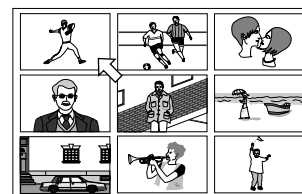

2 Use CURSOR to select the desired scene.

The selected scene is indicated by .

If there are more than 9 scenes, the digest screen will have more than one page. In this case, pressing advances to the next page, while pressing returns to the previous page.



Selected scene

Hints

- When the lower right scene is selected, pressing CURSOR ► advances to the next page if available. Similarly, when the upper left scene is selected, pressing CURSOR ◀ returns to the previous page (if available).
- When there are more than one digest page, after pressing SUBTITLE - DIGEST while holding down SHIFT, pressing ► before all 9 scenes of the first page appear on the TV screen will advance to the next page. Similarly, pressing ◀ before all the scenes of the second or latter page appear on the TV screen will return to the previous page.

3 Press ENTER.

The unit starts playback from the selected title or track.

NOTE

With some discs, depending on the contents, it may take some time until all the scenes appear on the screen.

Special picture playback

The unit provides special picture playback functions including Frame-by-frame, Strobe, Slow-motion and Zoom.

To advance a still picture frame-by-frame

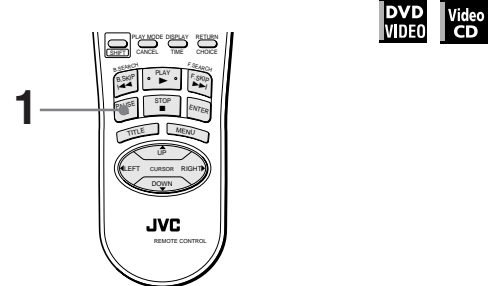

■ While paused (still)

1 Press PAUSE.

Each time you press PAUSE, the still picture advances to the next frame.

Pressing PLAY returns to the normal playback mode.

To display still pictures [STROBE]

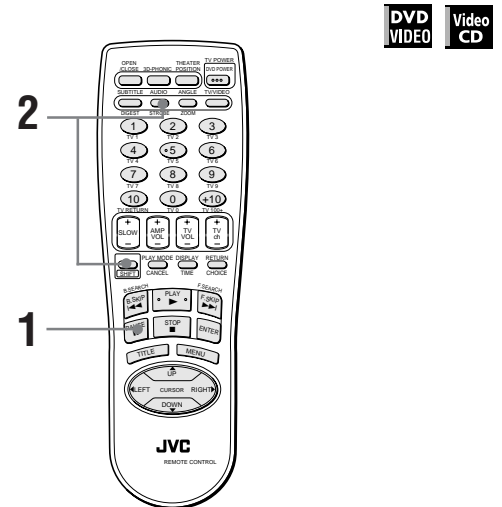

■ During playback

1 At the point you want to view as continuous photographs, press PAUSE.

The unit pauses playback.

2 Press AUDIO - STROBE while holding down SHIFT.

Nine continuous still pictures appear on the TV screen.

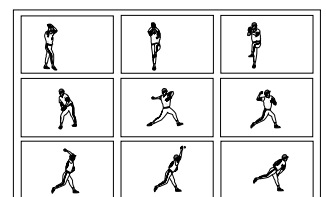

Hints

- Pressing PAUSE when the nine still pictures appear will advance to the next nine still pictures.

- **To cancel strobe play**
Press AUDIO - STROBE while holding down SHIFT.

NOTES

- Pressing and holding PAUSE for more than 1 second also activates the Strobe function.
- If you press AUDIO - STROBE while holding down SHIFT during playback, nine still pictures also appear but they advance in realtime.

- **To return to normal playback**
Press PLAY.

- **To pause slow-motion playback**
Press PAUSE.

NOTES

- The sound is muted during slow-motion playback.
- Reverse slow-motion playback is not possible for a Video CD.

To playback in slow-motion [SLOW]



■ During playback

From the remote control unit

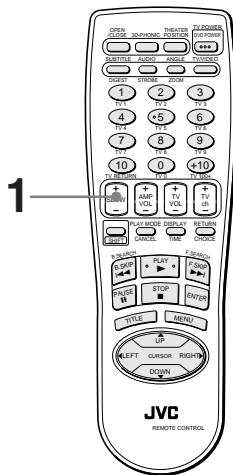

1 Press SLOW.

To play forward slow-motion, press SLOW "+", and to play reverse slow-motion (for DVD VIDEO discs only), press SLOW "-". First, the unit plays the slowest speed, and each time you press the button, the playback speed increases.

From the front panel

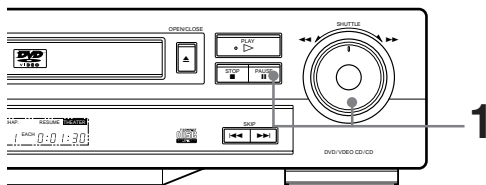

1 Press PAUSE, then use the SHUTTLE knob.

To play forward slow-motion, turn the SHUTTLE knob to the right. To play reverse slow-motion (for DVD VIDEO discs only), turn it to the left. The more you turn the knob, the more the slow-motion speed increases.

To zoom a scene [ZOOM]

DVD VIDEO Video CD

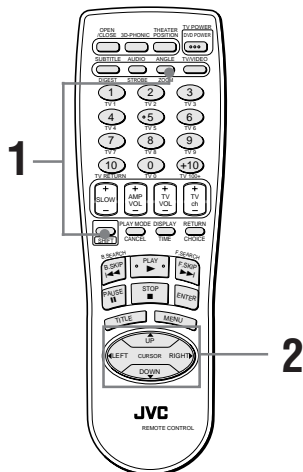

■ During playback or while paused

- 1 Press ANGLE - ZOOM while holding down SHIFT.

"ZOOM" appears on the TV screen.

The unit zooms in to the center part of the scene to produce a double-sized image.

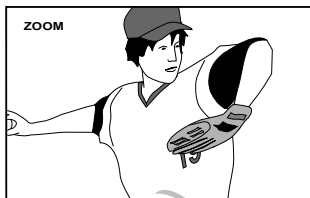
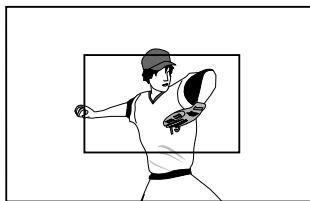

- 2 Use CURSOR $\leftarrow/\rightarrow/\uparrow/\downarrow$ to move the zoomed-in scene.

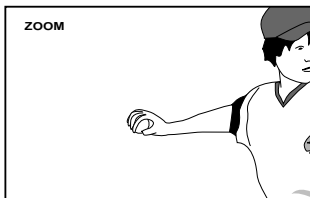

• **To pause zoom play**

Press PAUSE.

To resume zoom play, press PLAY.

• **To return to normal playback**

Press ANGLE - ZOOM while holding down SHIFT.

NOTE

During Zoom play, the picture may be garbled or noisy.

Changing the playback order

You can play titles or tracks in the desired order or in random order.

To playback in the desired order [PROGRAM]

DVD VIDEO Audio CD Video CD

You can play titles or tracks in the desired order by using the Program function.

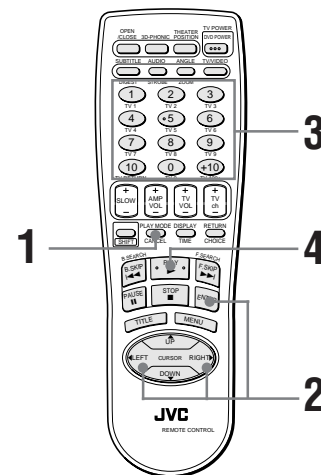

■ While stopped

- 1 Press PLAY MODE - CANCEL.

The play mode menu appears on the TV screen.

- 2 Use CURSOR \leftarrow/\rightarrow to move \swarrow to [PROGRAM] and press ENTER.

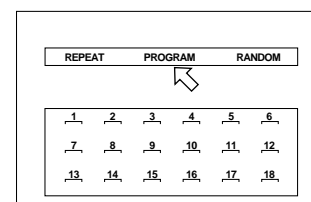

The program table appears under the menu bar (as shown above).

The "PROGRAM" indicator appears in the display window on the front panel.

- 3 Select the titles or tracks in the desired order using the numeric buttons.

See page 10 for details about how to use the numeric buttons.

Up to 18 titles or tracks can be programmed. You may select the same title or track more than once.

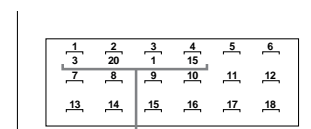

The programmed title/track number is shown under each program number.

- **When you specify a wrong selection**
Press PLAY MODE - CANCEL while holding down the SHIFT. The last selection programmed is erased.
- **To clear the program**
Press STOP.

4 Press PLAY to start program play.

When all of the programmed titles/tracks have finished playback, the unit stops but the program remains.

NOTES

- Some DVD VIDEO discs may not be played back correctly in program mode.
- During program playback, pressing ►► skip to the next selection of the program. Pressing ◀◀ returns to the beginning of the current selection, however, you cannot skip back to the previous selection.
- By pressing PLAY MODE - CANCEL during program playback, the program table is displayed on the TV screen and the current program number is indicated in yellow.

- **To quit program playback**
Press STOP and press STOP again.
The "PROGRAM" indicator in the display window turns off and the program is cleared.



While stopped and the play mode menu is displayed on the TV screen, by moving ◀ to [PROGRAM] and pressing ENTER, the program mode quits. Note that the program remains.

To playback in random order [RANDOM]



You can play titles or tracks in random order by using the Random function.

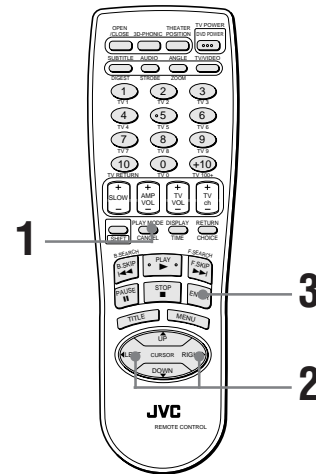

■ While stopped

- 1 Press PLAY MODE - CANCEL.
The play mode menu appears on the TV screen.
- 2 Use CURSOR ◀/▶ to move ◀ to [RANDOM].

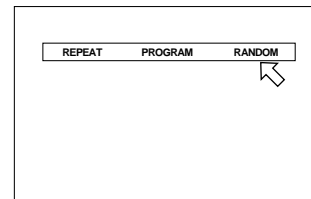

The "RANDOM" indicator appears in the display window on the front panel.

- 3 Press ENTER.
The unit starts random playback.
After playing all titles/tracks of the disc, random playback ends.



The same title or track will not be played back more than once during random play.

- **To stop/quit random playback in the middle**
Press STOP to stop playback. The unit is still in random playback mode, so pressing PLAY starts random playback again.
To quit random playback, press STOP again while stopped. The "RANDOM" indicator in the display window turns off.

NOTE

Some DVD VIDEO discs may not be played back correctly in random mode.

Repeat playback

You can repeat playback of the current selection or all disc contents. You can also repeat playback of a desired part.

To repeat the current selection or all disc contents [REPEAT]

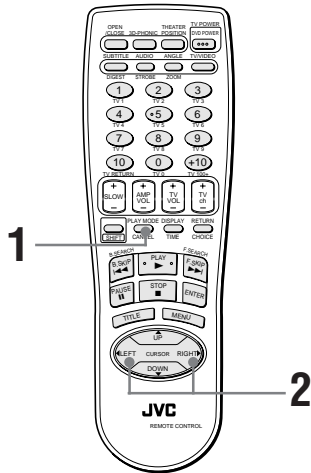

■ In any condition except Video CD playback with PBC

1 Press PLAY MODE - CANCEL.

The play mode menu appears on the TV screen.

2 Use CURSOR ◀▶ to move to [REPEAT], then press ENTER.

Each time you press ENTER, the repeat mode changes as follows:

• For DVD VIDEO

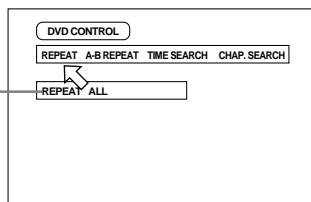

The selected repeat mode appears on the TV screen.

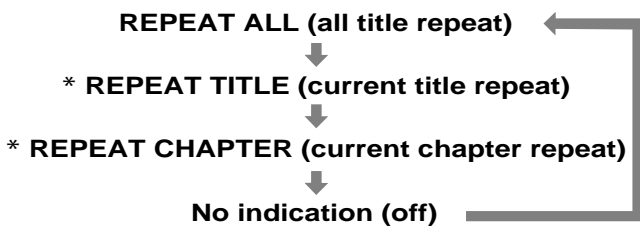

* While stopped, you cannot select REPEAT TITLE or REPEAT CHAPTER.

• For Audio/Video CD

(for Audio CD)

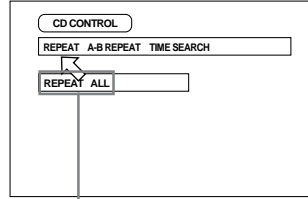

Selected repeat mode

(for Video CD)

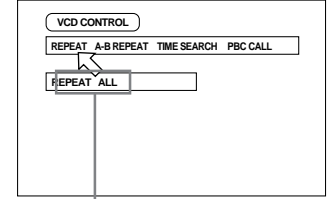

Selected repeat mode

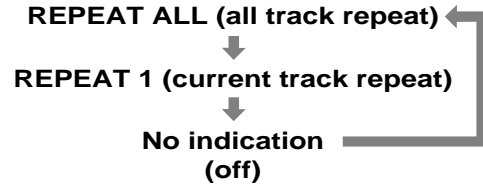

• To stop repeat playback

Press STOP.



- If you press STOP in REPEAT ALL mode, the unit stops playback but remains in the mode.
- If you press STOP in REPEAT1, TITLE REPEAT or CHAPTER REPEAT mode, the unit stops playback and quits the mode.

• To quit repeat playback

With the cursor pointed at [REPEAT], press ENTER repeatedly until the mode is set to off.

NOTES

- Some DVD VIDEO discs do not allow the title repeat or/and chapter repeat.
- Some DVD VIDEO discs automatically stops playback in the middle of the disc.
- Repeat playback function cannot be used during Video CD playback with PBC function.
- To turn off the play mode menu display
Press PLAY MODE - CANCEL.

To repeat a desired part [A-B REPEAT]

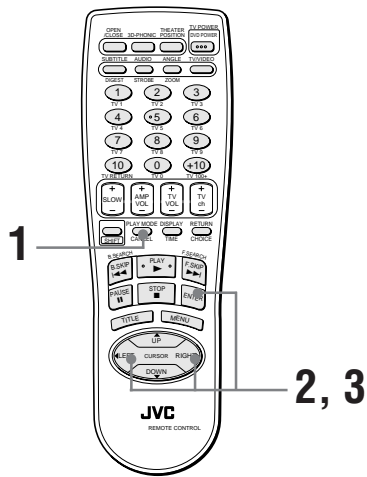

To quit A-B repeat playback

Press STOP. The unit stops playback and quits the A-B repeat mode.

Hints

- During playback, pressing ENTER when is pointed at [A-B REPEAT] quits the A-B repeat mode and continues playback.
- You can also quit the A-B repeat mode by pressing or .

NOTES

- **To turn off the play mode menu**
Press PLAY MODE - CANCEL.
- **If appears when pressing ENTER in step 2 during DVD playback**
You cannot repeat the selected portion because of the disc contents.
- **The A-B REPEAT function cannot be used during program playback.**

■ During playback

1 Press PLAY MODE - CANCEL.

The play mode menu appears on the TV screen.

2 Use CURSOR to move to [A-B REPEAT], then press ENTER at the beginning of the part you want to repeat (point A).

Make sure that REPEAT mode is off. If any one of the REPEAT modes is selected, you cannot move to [A-B REPEAT].

3 Press ENTER at the end of the part you want to repeat (point B).

The unit locates "A" and starts repeat playback between "A" and "B."

(for DVD VIDEO)

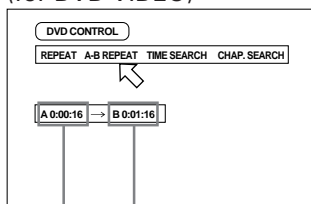

Point A Point B

(for Audio CD)

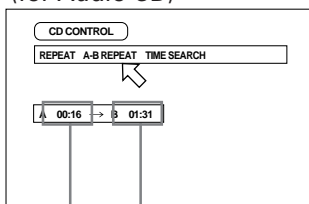

Point A Point B

(for Video CD)

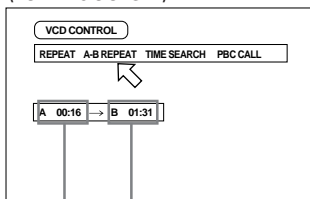

Point A Point B

Selecting a scene angle of DVD VIDEO

You can enjoy a variety of scene angles if the DVD VIDEO disc contains "multi-angle" parts, where multiple cameras were used to shoot the same scene from different angles.



At the beginning of "multi-angle" parts, appears on the TV screen.

To select a scene angle from the normal screen [ANGLE]

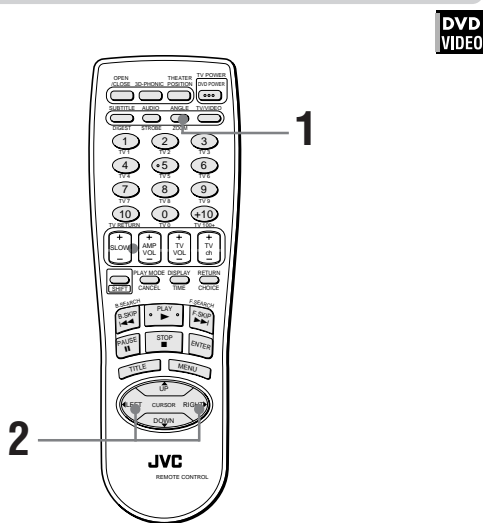

■ During DVD VIDEO playback

1 Press ANGLE - ZOOM.

The Angle selection display appears on the TV screen.

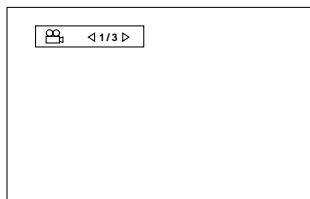

2 Press ANGLE - ZOOM or CURSOR ◀/▶ to select the desired angle.

Each time you press ANGLE or CURSOR ◀/▶, the angle changes.

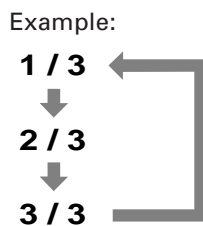

NOTES

- The Angle selection display will automatically disappear if you do not change the angle for 10 seconds.
- To turn off the Angle selection display manually, press ENTER.
- When appears on the TV screen The current scene is not recorded from multiple angles.

To select a scene angle from the angle list display [ANGLE]

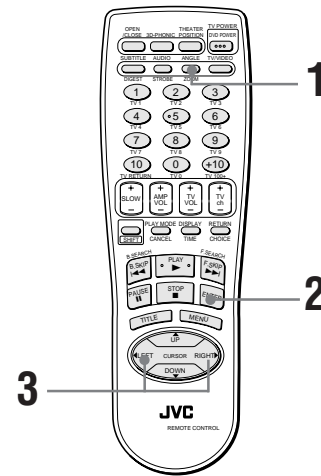

■ During DVD VIDEO playback

1 Press and hold ANGLE - ZOOM for more than 1 second.

Up to nine camera angles recorded on a disc appear on the TV screen.

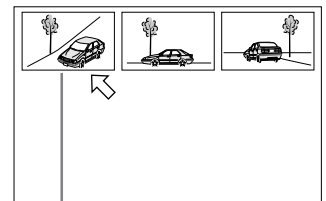

The selected camera angle

2 Use CURSOR ▲/▼/◀/▶ to select the desired angle.

3 Press ENTER.

■ The selected angle appears on the TV screen.

NOTES

- When appears on the TV screen in step 1: The current scene is not recorded from multiple angles.
- During the operation above, audio is muted.

Changing the language and sound

For DVD VIDEO discs, you can select the subtitle language, as well as the audio language/sound included on a disc.
For Video CD discs, you can select the audio channel(s).

To select the subtitle language [SUBTITLE]

■ During DVD VIDEO playback

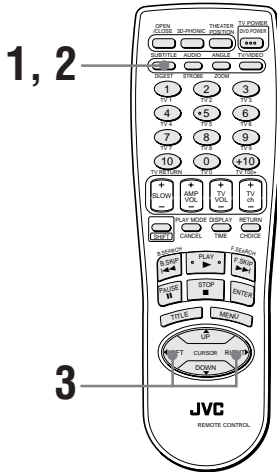

1 Press SUBTITLE.

The Subtitle selection display appears on the TV screen.

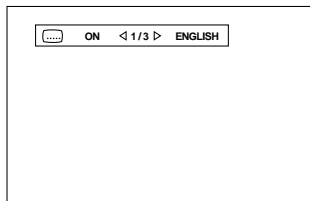

2 To turn the subtitle on and off, press SUBTITLE.

3 To select the desired subtitle language, press CURSOR <Left/Right>.

Each time you press CURSOR <Left/Right>, the subtitle language changes.

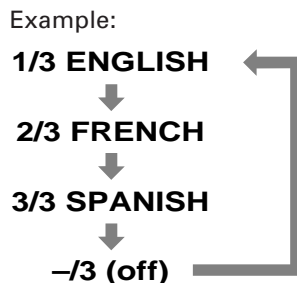

NOTES

- For DVD VIDEO, the selected language may be abbreviated on the TV screen. See "Appendix A: Table of languages and their abbreviations" at the end of this manual.
- The Subtitle selection display will automatically disappear if you do not change the subtitle for 10 seconds.
- To turn off the Subtitle selection display manually, press ENTER.
- When appears on the TV screen: You cannot select the subtitle.

To change the audio language or sound [AUDIO]



By AUDIO selection, you can choose the audio language of movies or choose to enjoy karaoke with or without the vocal.

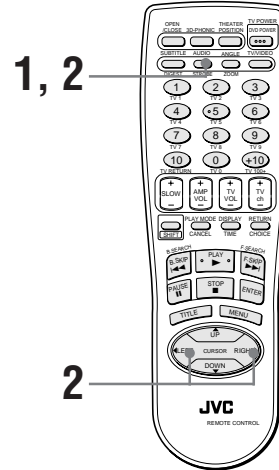

■ During playback

1 Press AUDIO - STROBE.

The Audio selection display appears on the TV screen.

(DVD VIDEO)

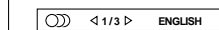

(Video CD)

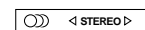

2 Press AUDIO - STROBE or CURSOR <Left/Right> to select the desired audio.

• For DVD VIDEO

Each time you press AUDIO - STROBE or CURSOR <Left/Right>, the audio language or sound changes.

Example:

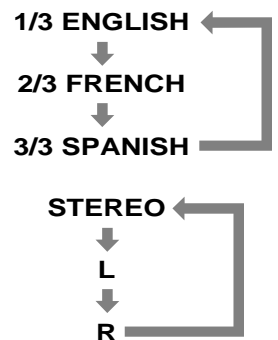

• For Video CD

Each time you press AUDIO - STROBE or CURSOR <Left/Right>, the playback audio changes as follows.

NOTES

- For DVD VIDEO, the selected language may be abbreviated on the TV screen. See "Appendix A: Table of languages and their abbreviations" at the end of this manual.
- The Audio selection display will automatically disappear if you do not change the audio for 10 seconds.
- To turn off the Audio selection display manually, press ENTER.
- When appears on the TV screen (for a DVD VIDEO disc): You cannot select the audio.

Selecting the picture character

You can select the quality of the image from among four options (OFF, 1, 2 and 3) according to the type of programming, picture tone or personal preferences.

To select the picture character [THEATER POSITION]

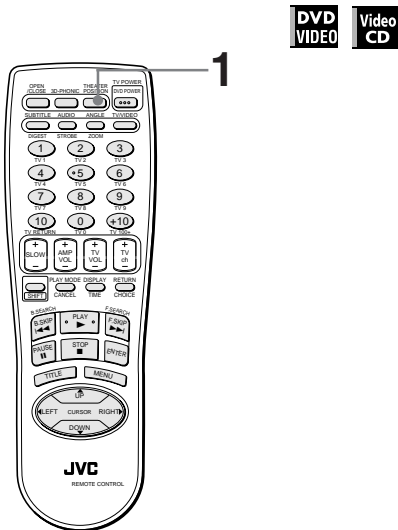

■ During playback

- 1 Press THEATER POSITION to select the desired picture character.

Each time you press the button, the picture character changes as follows:



Selected picture character

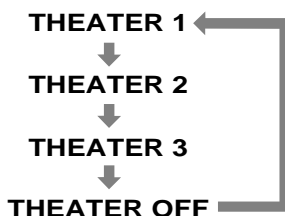

"THEATER OFF" is the normal position. Selecting a higher number tones down the picture character.

Enjoying virtual surround sound

Using the 3D Phonic function, you can get a simulated surround effect from your stereo system.

To simulate surround sound [3D PHONIC]

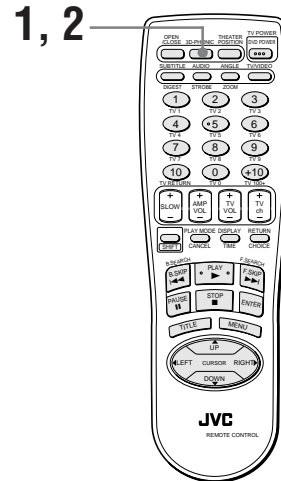

■ During playback

- 1 Press 3D PHONIC.
- 2 Select the desired effect mode by pressing 3D PHONIC.

Each time you press 3D PHONIC, the effect mode changes as follows:



Selected effect mode



- **ACTION:**
Suitable for action movies and sports programs in which sounds dynamically move.
- **DRAMA:**
Natural and warm sound. You can enjoy movies in a relaxed mood.
- **THEATER:**
You can enjoy sound effects like in a major theater in Hollywood.

* When you play a DVD VIDEO disc recorded in Dolby Digital which contains more than 2 channels, ACTION does not appear.

NOTES

- With a Video CD disc, if the AUDIO setting is set to L or R, you cannot activate the 3D Phonic function (i.e. the 3D Phonic mode is fixed to OFF).

Conversely, when the 3D Phonic function is active, changing the AUDIO setting to L or R from STEREO cancels the 3D Phonic function.

- The 3D phonic function works correctly when playing back discs recorded in the Dolby Surround or Dolby Digital 5.1-CH format.

It also works when playing back discs other than those above, but does not provide the correct effect.

- The 3D Phonic function does not affect the DTS or Dolby Digital bitstream signal from the DIGITAL OUT jack.

- The sound effect will not be set or operate, even if 3D PHONIC is pressed, for the sound of DVD VIDEO discs recorded in Linear PCM.

- When you set the 3D PHONIC function to on, the DOWN MIX and COMPRESSION settings in the AUDIO page of the preference display are disabled.

Checking the status

You can check the disc/time information, as well as the DVD functions, of the disc.

To check the disc/time information

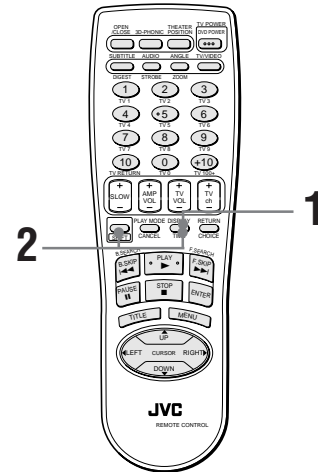

■ During playback

- 1 Press DISPLAY - TIME once for a Audio CD or Video CD disc, or twice for a DVD VIDEO disc.

The disc/time display appears on the TV screen.



During playback of a DVD VIDEO disc, pressing DISPLAY - TIME while holding down SHIFT directly turns on the disc/time display.

(for DVD VIDEO)

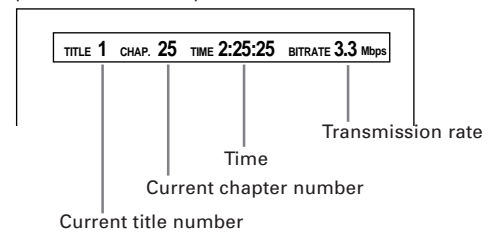

(for Audio CD or Video CD playing without PBC)

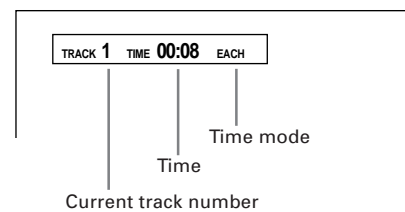

(for Video CD playing with PBC)

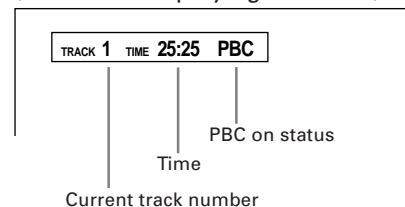

- 2** To change the time display mode (only for Audio CD or Video CD without PBC), press DISPLAY - TIME while holding down SHIFT.

The time display mode cycles as below.

(for Audio CD)

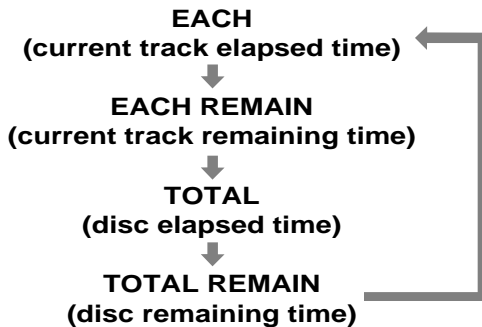

(for Video CD without PBC)



The selected time information is displayed on the TV screen, as well as in the front panel display window.

■ While stopped

You can check the total disc time and current (selected) track time of an Audio CD/Video CD only from the front panel display window.

- 1** Press DISPLAY - TIME while holding down SHIFT.

When EACH and REMAIN are indicated, the current (selected) track time appears. When only REMAIN is indicated, the total disc time appears.



You can change the current (selected) track by pressing ◀◀ or ▶▶.

- **To turn off the disc/time display**
Press DISPLAY-TIME.

To check the DVD function status

DVD
VIDEO

- During DVD VIDEO playback

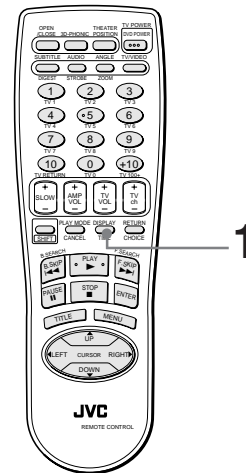

- 1** Press DISPLAY - TIME.

The DVD function status display appears on the TV screen.

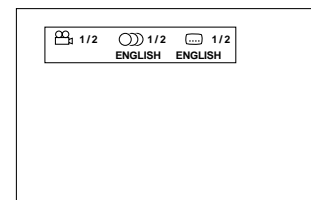

The current selections of the camera angle, audio language and subtitle language are displayed.

- **To turn off the DVD function status display**
Press DISPLAY-TIME twice.

Selecting preferences

You can set various preferences for playback via four dedicated displays.

How to set preferences

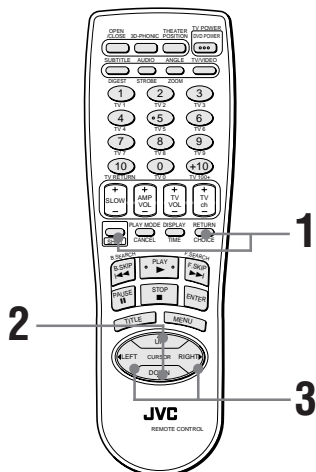

1 When a DVD or Video CD disc is stopped or no disc is inserted, press RETURN-CHOICE while holding down SHIFT.

One of the preference pages appears on the TV screen.

There are four preference pages: LANGUAGE, AUDIO, DISPLAY and SYSTEM. To turn the page, move to the desired tab using CURSOR /

3 Press CURSOR to select the setting you want.

- To turn off the preference display, press RETURN-CHOICE while holding down SHIFT, or move to [EXIT] and press ENTER.
- For details about each setting, see the following paragraphs:

LANGUAGE page

MENU LANGUAGE

You can select the default "display" language to be displayed if it is contained on the disc.

Each time you press CURSOR , the language setting changes in the following order:

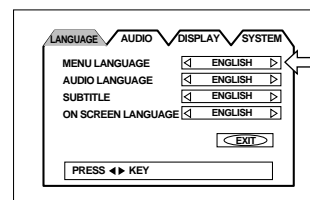

ENGLISH → SPANISH → FRENCH → CHINESE → GERMAN → ITALIAN → JAPANESE → language code from AA to ZU

(See "Table of languages and their abbreviations" at the end of this manual.)

Pressing CURSOR changes the language setting in the reverse order of the above.

- * If the selected language is not recorded, the disc's default display language will be displayed.

AUDIO LANGUAGE

You can select the default audio language to be played if it is contained on the disc.

Each time you press CURSOR , the language setting changes in the following order:

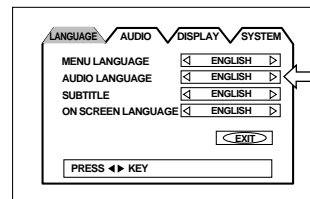

ENGLISH → SPANISH → FRENCH → CHINESE → GERMAN → ITALIAN → JAPANESE → language code from AA to ZU

(See "Table of languages and their abbreviations" at the end of this manual.)

Pressing CURSOR changes the language setting in the reverse order of the above.

- * If the selected language is not recorded, the disc's default audio language will be played.

LANGUAGE

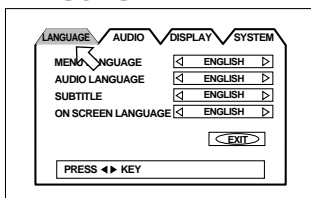

AUDIO

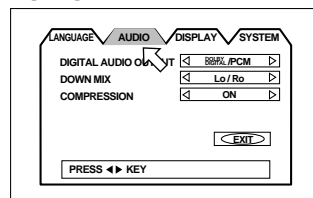

DISPLAY

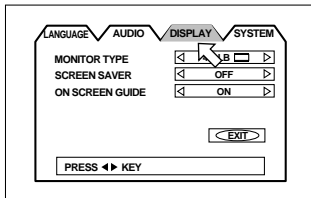

SYSTEM

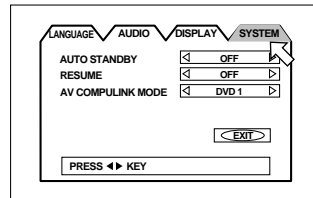

2 Move to select the item you want to set by using CURSOR .

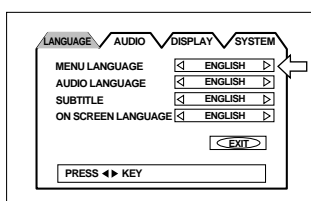

SUBTITLE

You can select the default subtitle language to be displayed if it is contained on the disc.

Each time you press CURSOR ►, the language setting changes in the following order:

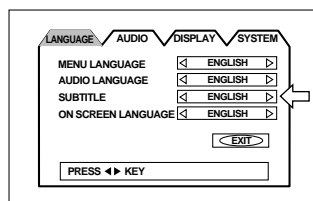

ENGLISH → SPANISH → FRENCH → CHINESE → GERMAN → ITALIAN → JAPANESE → language code from AA to ZU

(See "Table of languages and their abbreviations" at the end of this manual.)

Pressing CURSOR ◀ changes the language setting in the reverse order of the above.

* If the selected language is not recorded, the disc's default subtitle language will be displayed.

ON SCREEN LANGUAGE

You can select the on-screen display language to be displayed.

Each time you press CURSOR ►, the language setting changes as follows:

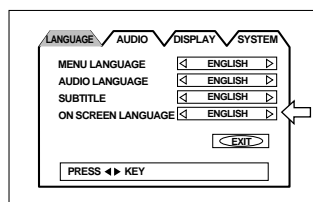

ENGLISH
↓
ESPAÑOL (Spanish)
↓
FRANCAIS (French)

English	ON SCREEN LANGUAGE ◀ ENGLISH ▶
Spanish	IDIOMA EN PANTALLA ◀ ESPAÑOL ▶
French	LANGUE D'ECRAN ◀ FRANCAIS ▶

Pressing CURSOR ◀ changes the language setting in the reverse order of the above.

AUDIO page

DIGITAL AUDIO OUTPUT

To connect the unit's digital output to an external device equipped with a digital input, this item must be set correctly.

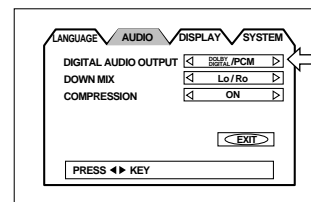

- PCM ONLY:**
When you connect the DIGITAL OUT jack of the unit to the linear PCM digital input of other audio equipment.
- STREAM/PCM:**
When you connect to the digital input of an amplifier to a built-in DTS, Dolby Digital, or MPEG multichannel decoder.
- DOLBY DIGITAL/PCM:**
When you connect to the digital input of a Dolby Digital decoder, or an amplifier with a built-in Dolby Digital decoder.

The following chart shows the relationship between types of playback discs and output signals.

Playback discs	Output		
	STREAM/PCM	DOLBY DIGITAL/PCM	PCM ONLY
DVD with 48-kHz, 16-bit linear PCM	48-kHz, 16-bit linear PCM	←	←
DVD with 48-kHz, 20/24-bit linear PCM	48-kHz, 20-bit linear PCM	←	←
DVD with 96-kHz, linear PCM	No output	←	←
DVD with DTS	DTS bitstream	No output	←
DVD with Dolby Digital	Dolby Digital bitstream	←	48-kHz, 16-bit linear PCM
DVD with MPEG multichannel	MPEG bitstream	48-kHz, 16-bit linear PCM	←
Video CD	44.1-kHz, 16-bit linear PCM	←	←
Audio CD	44.1-kHz, 16-bit linear PCM	←	←
Audio CD with DTS	DTS bitstream	←	←

NOTES

- The unit does not provide the DTS decoding function.
- When playing a DVD VIDEO or Audio CD disc with DTS, use a DTS decoder to get correct signals from your speakers. Never use the unit's analog output jacks, which output incorrect signals that may damage your speakers.

If you connect the analog outputs and digital outputs simultaneously, be sure to select the source of the amplifier correctly, or set the level control of the amplifier connected to the analog outputs to minimum.

DOWN MIX

To playback a DVD VIDEO disc recorded with surround multichannel audio correctly, the DOWN MIX setting must be properly made according to your audio system.

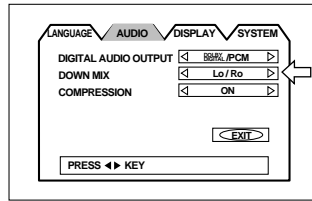

Note that this setting affects the output signal from the AUDIO (both DIGITAL and ANALOG) output jacks when playing back a DVD VIDEO disc recorded with surround multichannel audio.

- **Lt/Rt**

When you enjoy multichannel surround audio by connecting the unit's AUDIO output (normally, the DIGITAL output) to a surround decoder.

- **Lo/Ro**

When you enjoy conventional 2-channel stereo audio by connecting the unit's AUDIO output(s) to a stereo amplifier/receiver or television set, or when you duplicate audio of a DVD VIDEO disc recorded with surround audio to your MD, cassette, etc.

NOTE

The Down mix function does not work when the 3D PHONIC function is activated.

COMPRESSION

You can compress the dynamic range of the sound if needed. Using this function, you can listen to sound at low volumes easily.

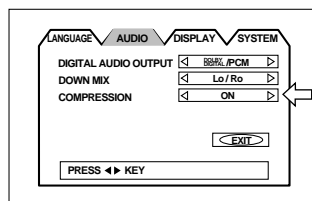

- **ON**

Audio is played back with the dynamic range compressed.

- **OFF**

Audio is played back as it was recorded.

NOTES

- The Compression function works only when playing back a disc recorded with DOLBY DIGITAL 1CH or 2CH. The setting is not effective for other discs.
- The Compression function does not work when the 3D PHONIC function is activated.

DISPLAY page

MONITOR TYPE

You can select the monitor type to match your TV when you playback DVD VIDEO discs recorded for wide screen televisions.

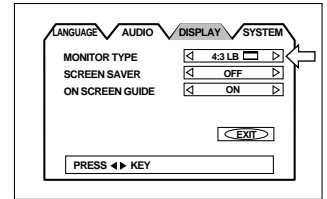

- **4:3 LB** (Letter Box Conversion)

When you connect a normal TV to the unit.

When you play a wide picture recorded on a DVD VIDEO disc, the picture is displayed with bands across the upper and lower portions of the screen.



- **4:3 PS** (Pan Scan Conversion)

When you connect a normal TV to the unit.

When you play a wide picture recorded on a DVD VIDEO disc, a portion of the picture is automatically cut off from the left and right sides of the image.

Depending on the disc, it may not be possible to playback in this mode. In that case, the picture is played back as in 4:3 LB mode.

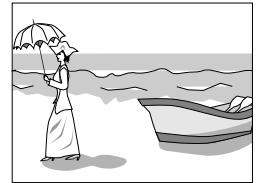

- **16:9 WIDE** (Wide Television screen)

When you connect a wide-screen TV to the unit.



SCREEN SAVER

A television monitor screen may be burned out if a static picture is displayed for a long time. To prevent this, the unit automatically activates the screen saver function if a static picture, such as an on-screen display or menu, is displayed for over 5 minutes.

- **MODE 1**

The current picture gets dark.

- **MODE 2**

The "screen saver" picture appears and its brightness changes.

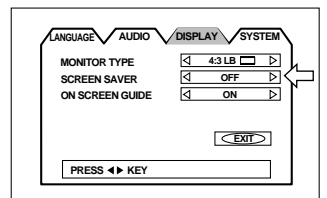

- **OFF**

The screen saver function is off.

NOTES

- The monitor screen of a projector or projection TV is easily burned out if the screen saver mode is set to OFF and a static picture is displayed for a long time.
- The screen saver function is not activated when the selected disc is an Audio CD.

ON SCREEN GUIDE

The unit can display “on-screen guide” icons or characters on the picture, which show what is happening to the disc or the unit.

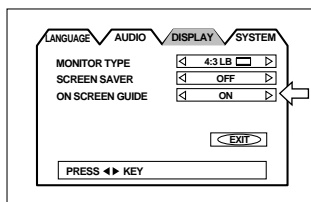

- **ON**

The on-screen guide will be displayed.

- **OFF**

The on-screen guide will not be displayed.

Examples of “on-screen guide” icons or characters:



SYSTEM page

AUTO STANDBY

When the unit is stopped for more than 30 minutes or 60 minutes, the unit enters standby mode automatically.

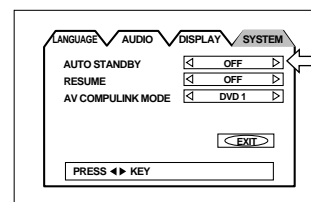

- **60**

Time is set to 60 minutes.

- **30**

Time is set to 30 minutes.

- **OFF**

The auto standby function is off.

RESUME

You can select the resume function to be on or off. See page 19.

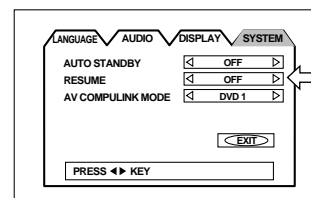

- **ON**

Pressing PLAY while stopped or on standby starts playback from the resume point if it is memorized.

- **OFF**

Pressing PLAY while stopped or on standby starts playback from the beginning of the disc.

AV COMPULINK MODE

If you use the AV Compulink system, you must set this item correctly. Select from the three options: “DVD1,” “DVD2” and “DVD3” according to the equipment to be connected. See page 41.

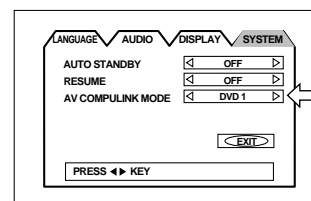

Limiting playback by children

This function restricts playback of DVD VIDEO discs which contain violent (and other) scenes according to the level set by the user. For example, if a movie which includes violent scenes supports the parental lock feature, such scenes which you do not want to let children view can be cut or replaced with other scenes.

To set Parental Lock for the first time [PARENTAL LOCK]

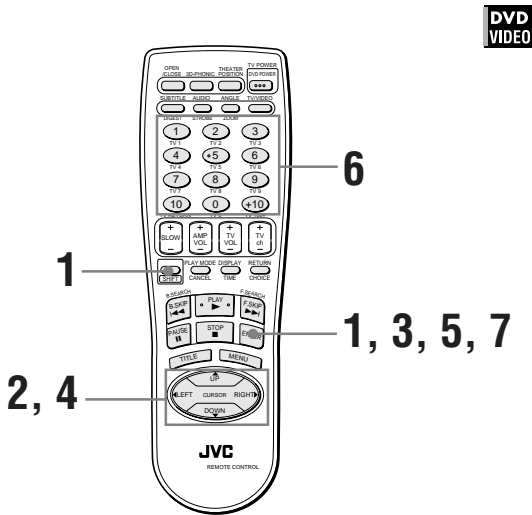

DVD VIDEO

■ While a DVD VIDEO disc is stopped or no disc is inserted

- 1 Press ENTER while holding down SHIFT. The Parental Lock on-screen display appears on the TV screen.
- 2 While points [Country Code], use CURSOR to select "US" for country code.

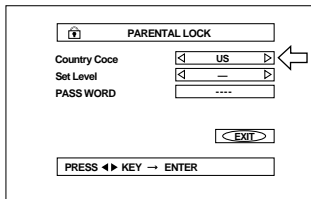

- 3 Press ENTER. moves to [Set Level].

- 4 While points [Set Level], use CURSOR to select the parental lock level.

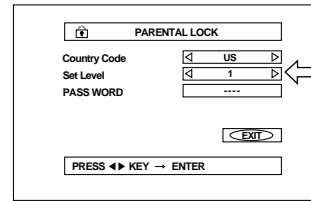

Each time you press CURSOR , the parental level changes as follows:

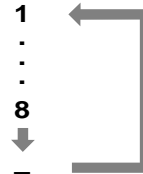

Hints

"1" is the strictest level. "-" means no restriction. Discs rated higher than the selected level are restricted.

- 5 Press ENTER. moves to [PASSWORD].
- 6 Enter your 4-digit password using the numeric buttons (0 to 9).

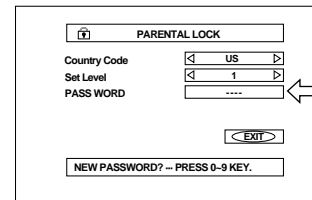

- 7 Press ENTER. The parental level and password are set. moves to [EXIT]. Pressing ENTER again returns to the opening display.

Hints

If you enter an undesired password in step 6 above, reenter the password before pressing ENTER.

To change the settings [PARENTAL LOCK]

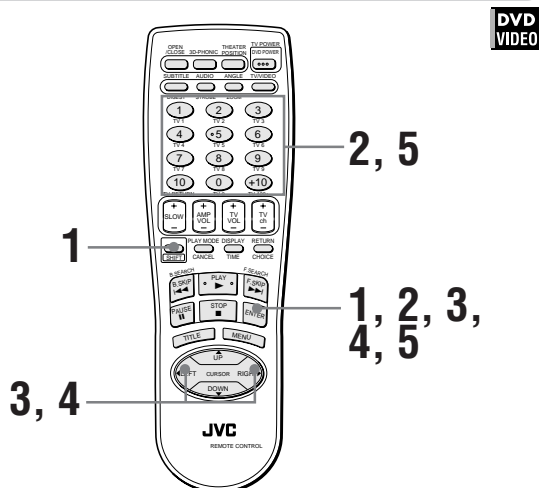

You can change the Parental lock settings later.

- While a DVD VIDEO disc is stopped or no disc is inserted

1 Press ENTER while holding down SHIFT.

The Parental Lock on-screen display appears on the TV screen.

← points [PASSWORD].

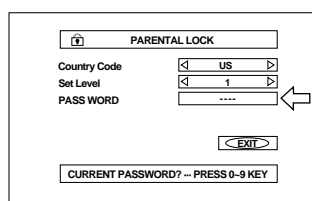

2 Enter your current 4-digit password using the numeric buttons (0 to 9) and press ENTER.

← moves to [Country Code] if you enter the correct password.

If you enter the wrong password, "WRONG! RETRY....." appears on the TV screen, and you cannot go to next step.

3 To change the country code, use CURSOR ▲/▼ to select the desired country code and press ENTER.

← moves to [Set Level].

When you change the country code, you must select the parental level.

4 To change the set level, use CURSOR ▲/▼ to select the desired level while ← points [Set Level], and then press ENTER.

← moves to [PASSWORD].

5 Enter the password using the numeric buttons (0 to 9) and press ENTER.

← moves to [EXIT].

The password entered in the above step becomes the new password. If you do not change the password, enter the same password as in the step 2.

Even if you want to change only the country code and/or parental level, do not forget to enter the password after changing the country code and/or parental level. Otherwise, the new country code and/or parental level will not become effective. Pressing ENTER again returns to the opening display.

NOTES

- When you enter the wrong password more than 3 times in step 2 above, ← moves to [EXIT] automatically and CURSOR ▲/▼ does not work.
- If you forget your password in step 2 Enter "8888."

To temporarily release the Parental lock [PARENTAL LOCK]

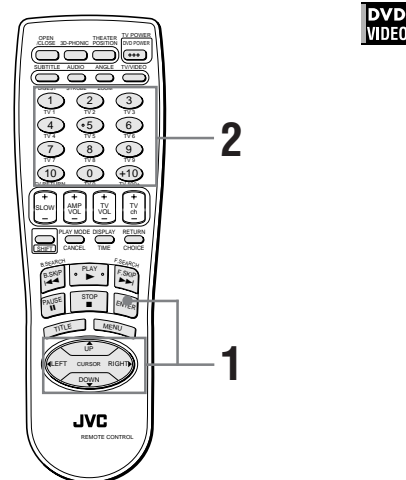

When you set the parental level strictly, some discs may not be played back at all. When you insert such a disc and try to play it, the following Parental Lock on-screen display appears on the TV screen, asking you whether you want the parental lock to be temporarily released or not.

1 Use the CURSOR ▲/▼ to move ← to [YES], then press ENTER.

← moves to the PASSWORD field.

When selecting [NO], press OPEN/CLOSE to remove the disc.

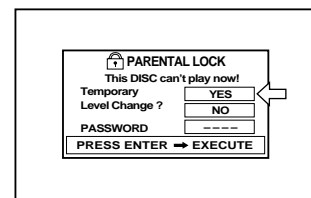

2 Enter your 4-digit password using the numeric buttons (0 to 9).

If you enter the wrong password, "WRONG! RETRY..." appears on the TV screen, and you cannot go to next step.

The Parental lock is released, and the unit starts playback.

NOTE

When you enter the wrong password more than 3 times in step 2 above, ← moves to [NO] automatically and CURSOR ▲/▼ do not work.

AV COMPU LINK remote control system

When you buy a separate TV, VCR, DVD player, receiver, or other component and connect them to each other, you have to operate each component individually. JVC's AV COMPU LINK remote control system meets the demands of a system made up of single components and has the ease of operation of a single unit.

AV COMPU LINK

Connection and setup

Using the AV COMPU LINK cable, connect the AV COMPU LINK terminals of each component to one another.

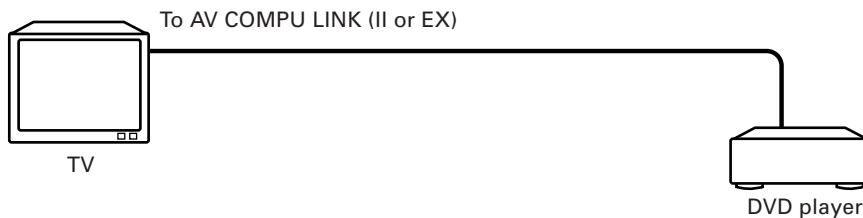

- If you connect a DVD player to a television via AV COMPU LINK, set the DVD player's AV COMPU LINK setting as follows.

- When connecting to VIDEO-1 input terminal of the television: DVD2
- When connecting to VIDEO-2 input terminal of the television: DVD3

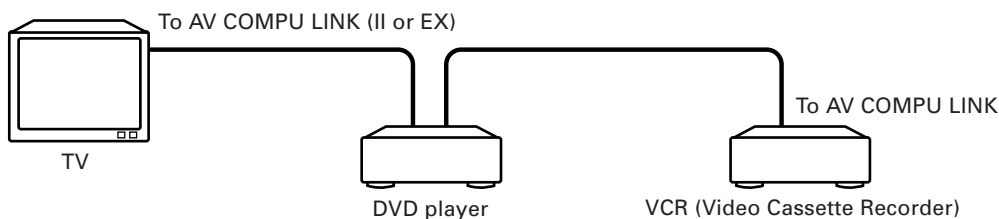

- If you connect a DVD player to a television and VCR via AV COMPU LINK, set the VCR's Remote Control Code and DVD player's AV COMPU LINK setting as follows.

- When connecting to VIDEO-1 input terminal of the television:
DVD player's AV COMPU LINK setting: DVD2
VCR's Remote Control Code: B
- When connecting to VIDEO-2 input terminal of the television:
DVD player's AV COMPU LINK setting: DVD3
VCR's Remote Control Code: A

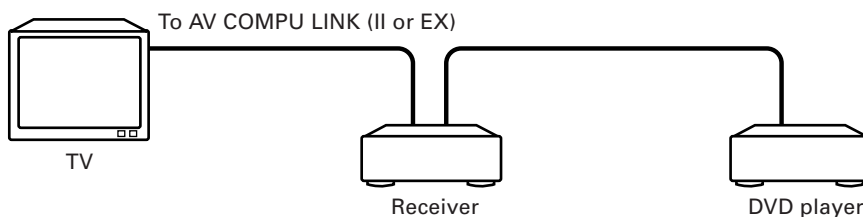

- If you connect a DVD player to a television and receiver via AV COMPU LINK, set the DVD player's AV COMPU LINK setting to DVD1.

- The DVD player's AV COMPU LINK setting is operated in the SYSTEM page of the preference display. See page 38 for operation.
- For information on the connection between the TV and the Receiver, refer to the Receiver's Instructions.

IMPORTANT!

If you connect the component video output to your TV:

- set the DVD player's AV COMPULINK setting to DVD1.
- make the video/audio connection between the DVD player and your receiver using the supplied audio/video cable, and do not make the S-VIDEO connection.

Notes for connection

- If you connect a DVD player to a receiver via AV COMPU LINK in a system including a Dolby digital decoder, some functions may not be performed automatically.
- The AV COMPU LINK terminal on some televisions indicates "II." Do not connect the terminal indicating "II" with the AV COMPU LINK terminal on a receiver. If connected, the system will not work correctly.
- Connect the AUDIO OUT jacks of the DVD player to the audio input jacks of a receiver that indicating "DVD." Otherwise, the system will not work correctly.
- There may be no description about connections to a DVD player in the instruction manual of a television or VCR. However a television or VCR with AV COMPU LINK terminals indicating "II" or "EX" can be connected to a DVD player.

Operation

You can enjoy pictures and/or sound by just putting a source component (which plays back the pictures and/or sound such as a DVD player or VCR) into play mode. You do not have to operate the TV and receiver including not having to perform power switching.

- 1 Turn on the main power of the television.
- 2 Insert a disc into the source component.
- 3 Press PLAY of the source component.

The following actions are performed automatically:

- Turning on the power for the television.
- Setting the source of the television to the external input (VIDEO-1 or VIDEO-2).
- Turning on the power for the receiver.
- Setting the source of the receiver to the component which has started playback.

Care and handling of discs

How to handle discs

When handling a disc, do not touch the surface of the disc. Since discs are made of plastic, they are easily damaged. If a disc gets dirty, dusty, scratched or warped, the images and sound will not be picked up correctly, and such a disc may cause the player to malfunction.

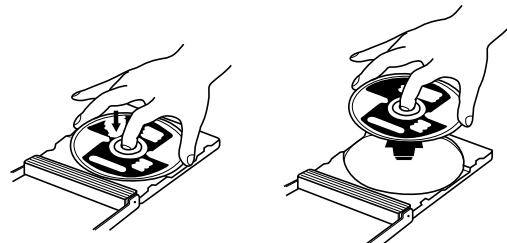

Label side

Do not damage the label side, stick paper to or use any adhesive on its surface.

Storage

Make sure that discs are kept in their cases. If discs are piled on top of one another without their protective cases, they can be damaged. Do not put discs in a location where they may be exposed to direct sunlight, or in a place where the humidity or temperature is high. Avoid leaving discs in your car!

Maintenance of discs

If there are fingerprints or other dirt adhering to a disc, wipe with a soft dry cloth, moving from the center outwards. If a disc is difficult to clean, wipe with a cloth moistened with water. Never use record cleaners, petrol, alcohol or any anti-static agents.

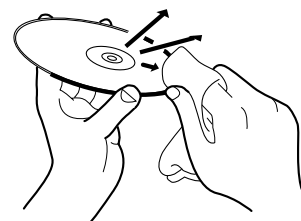

CAUTION

Sometimes during play noise or images may be garbled. This is sometimes due to the disc. (It may not be up to industry standards.)

These symptoms are caused by the discs, not by the malfunction of the unit.

Troubleshooting

What appears to be a malfunction may not always be serious. Please go through the following list before requesting service.

Symptom	Possible case	Remedy
Power does not come on.	Power plug is not inserted securely.	Plug in securely.
Remote control does not work.	Too far from the unit.	Move closer to the unit.
	The tip of the remote unit is not pointed in the right direction.	Point the infrared light-emitting window toward the remote sensor on the front panel.
	Batteries are exhausted.	Replace the batteries with new ones.
	Battery polarity is incorrect.	Take out the batteries and insert them again in the correct direction.
No picture is displayed on the monitor.	Connection of video cable is incorrect.	Connect the cable correctly.
	Input selection of TV is incorrect.	Select correctly.
	Disc is not playable.	Use a playable disc. (See page 11.)
Picture is noisy.	The unit is connected to a VCR directly and the copyguard function is activated.	Connect the unit so that the picture signal flows directly to the TV.
No audio is reproduced.	Connection is incorrect.	Check the connections.
	Input selection of amplifier is incorrect.	Select correctly.
No audio is reproduced when playing back a DVD disc recorded with 96-kHz, linear PCM audio.	The audio signal is derived from the unit's DIGITAL OUT.	Use the AUDIO OUT when playing back such discs.
Sound is distorted or noise is generated.	Disc is dirty.	Wipe the disc surface.
Picture does not fit the television screen.	MONITOR TYPE is not correctly set.	Select monitor type correctly. (See page 37.)
	Television is not correctly set.	Set the television correctly.
Operation is not possible.	Microcomputer malfunction due to lightning or static electricity.	Turn off the power and unplug the power cord, then connect the power cord again.
	Moisture condensation caused by a sudden change of temperature or humidity.	Turn off the power, then turn it on a few hours later.

Specifications

General

Readable discs: DVD VIDEO, Audio CD, Video CD
Video format: NTSC

Other

Power requirements: AC 110 V - 240 V \sim , 50 Hz/60 Hz
Power consumption: 17 W (POWER ON), 3.4 W (STANDBY mode)
Mass: 3.2 kg (7.1 lbs)
Dimensions (W x H x D): 435 mm x 95 mm x 297 mm
(17-3/16 inch x 3-3/4 inch x 11-3/4 inch)

Video output

COMPONENT (pin jacks): Y Output: 1.0 Vp-p (75 Ω)
PB/PR Output: 0.7 Vp-p (75 Ω)
VIDEO OUT (pin jack): 1.0 Vp-p (75 Ω)
S-VIDEO OUT (S jack): Y Output: 1.0 Vp-p (75 Ω)
C Output: 286 mVp-p (75 Ω)
Horizontal resolution: 500 Lines
Signal to noise ratio: 65 dB

Audio output

ANALOG OUT (pin jack): 2.0 Vrms (10 k Ω)
DIGITAL OUT: COAXIAL: 0.5 Vp-p (75 Ω termination)
OPTICAL: - 21 to -15 dBm (Peak)

Audio characteristics

Frequency response: CD (sampling frequency 44.1 kHz): 2 Hz to 20 kHz
DVD (sampling frequency 48 kHz): 2 Hz to 22 kHz
DVD (sampling frequency 96 kHz): 2 Hz to 44 kHz
Dynamic range: 16 bit: More than 98 dB
20 bit: More than 106 dB
24 bit: More than 106 dB
Wow and flutter: Unmeasurable (less than \pm 0.002%)
Total harmonic distortion: Less than 0.002%

* Specifications and appearance subject to change without prior notice.

Appendix A: Table of languages and their abbreviations

When you select the subtitle language or sound, the languages shown below are displayed as abbreviations. To select the desired language, select the abbreviation corresponding the language you want to.

AA	Afar
AB	Abkhazian
AF	Afrikaans
AM	Ameharic
AR	Arabic
AS	Assamese
AY	Aymara
AZ	Azerbaijani
BA	Bashkir
BE	Byelorussian
BG	Bulgarian
BH	Bihari
BI	Bislama
BN	Bengali, Bangla
BO	Tibetan
BR	Breton
CA	Catalan
CO	Corsican
CS	Czech
CY	Welsh
DA	Danish
DZ	Bhutani
EL	Greek
EO	Esperanto
ET	Estonian
EU	Basque
FA	Persian
FI	Finnish
FJ	Fiji
FO	Faroese
FY	Frisian
GA	Irish
GD	Scots Gaelic
GL	Galician
GN	Guarani
GU	Gujarati
HA	Hausa
HI	Hindi
HR	Croatian
HU	Hungarian
HY	Armenian
IA	Interlingua
IE	Interlingue

IK	Inupiak
IN	Indonesian
IS	Icelandic
IW	Hebrew
JL	Yiddish
JW	Javanese
KA	Georgian
KK	Kazakh
KL	Greenlandic
KM	Cambodian
KN	Kannada
KO	Korean (KOR)
KS	Kashmiri
KU	Kurdish
KY	Kirghiz
LA	Latin
LN	Lingala
LO	Laothian
LT	Lithuanian
LV	Latvian, Lettish
MG	Malagasy
MI	Maori
MK	Macedonian
ML	Malayalam
MN	Mongolian
MO	Moldavian
MR	Marathi
MS	Malay (MAY)
MT	Maltese
MY	Burmese
NA	Nauru
NE	Nepali
NL	Dutch
NO	Norwegian
OC	Occitan
OM	(Afan) Oromo
OR	Oriya
PA	Panjabi
PL	Polish
PS	Pashto, Pushto
PT	Portuguese
QU	Quechua
RM	Rhaeto-Romance

RN	Kirundi
RO	Rumanian
RU	Russian
RW	Kinyarwanda
SA	Sanskrit
SD	Sindhi
SG	Sangho
SH	Serbo-Croatian
SI	Singhalese
SK	Slovak
SL	Slovenian
SM	Samoan
SN	Shona
SO	Somali
SQ	Albanian
SR	Serbian
SS	Siswati
ST	Sesotho
SU	Sundanese
SV	Swedish
SW	Swahili
TA	Tamil
TE	Telugu
TG	Tajik
TH	Thai
TI	Tigrinya
TK	Turkmen
TL	Tagalog
TN	Setswana
TO	Tonga
TR	Turkish
TS	Tsonga
TT	Tatar
TW	Twi
UK	Ukrainian
UR	Urdu
UZ	Uzbek
VI	Vietnamese
VO	Volapuk
WO	Wolof
XH	Xhosa
YO	Yoruba
ZU	Zulu

Appendix B: Country code list for parental lock

This list is used for the parental Lock operation. For details, see page 39.

AD	Andorra
AE	United Arab Emirates
AF	Afghanistan
AG	Antigua and Barbuda
AI	Anguilla
AL	Albania
AM	Armenia
AN	Netherlands Antilles
AO	Angola
AQ	Antarctica
AR	Argentina
AS	American Samoa
AT	Austria
AU	Australia
AW	Aruba
AZ	Azerbaijan
BA	Bosnia and Herzegovina
BB	Barbados
BD	Bangladesh
BE	Belgium
BF	Burkina Faso
BG	Bulgaria
BH	Bahrain
BI	Burundi
BJ	Benin
BM	Bermuda
BN	Brunei Darussalam
BO	Bolivia
BR	Brazil
BS	Bahamas
BT	Bhutan
BV	Bouvet Island
BW	Botswana
BY	Belarus
BZ	Belize
CA	Canada
CC	Cocos (Keeling) Islands
CF	Central African Republic
CG	Congo
CH	Switzerland
CI	Côte d'Ivoire
CK	Cook Islands
CL	Chile
CM	Cameroon
CN	China
CO	Colombia
CR	Costa Rica
CU	Cuba
CV	Cape Verde
CX	Christmas Island
CY	Cyprus
CZ	Czech Republic
DE	Germany
DJ	Djibouti
DK	Denmark
DM	Dominica
DO	Dominican Republic
DZ	Algeria
EC	Ecuador
EE	Estonia
EG	Egypt
EH	Western Sahara
ER	Eritrea
ES	Spain
ET	Ethiopia
FI	Finland
FJ	Fiji
FK	Falkland Islands (Malvinas)
FM	Micronesia (Federated States of)
FO	Faroe Islands
FR	France
FX	France, Metropolitan
GA	Gabon
GB	United Kingdom
GD	Grenada
GE	Georgia
GF	French Guiana
GH	Ghana
GI	Gibraltar
GL	Greenland
GM	Gambia
GN	Guinea
GP	Guadeloupe
GQ	Equatorial Guinea
GR	Greece
GS	South Georgia and the South Sandwich Islands
GT	Guatemala
GU	Guam
GW	Guinea-Bissau
GY	Guyana
HK	Hong Kong
HM	Heard Island and McDonald Islands
HN	Honduras
HR	Croatia
HT	Haiti
HU	Hungary
ID	Indonesia
IE	Ireland
IL	Israel
IN	India
IO	British Indian Ocean Territory
IQ	Iraq
IR	Iran (Islamic Republic of)
IS	Iceland
IT	Italy
JM	Jamaica
JO	Jordan
JP	Japan
KE	Kenya
KG	Kyrgyzstan
KH	Cambodia
KI	Kiribati
KM	Comoros
KN	Saint Kitts and Nevis
KP	Korea, Democratic People's Republic of
KR	Korea, Republic of
KW	Kuwait
KY	Cayman Islands
KZ	Kazakhstan
LA	Lao People's Democratic Republic
LB	Lebanon
LC	Saint Lucia
LI	Liechtenstein
LK	Sri Lanka
LR	Liberia
LS	Lesotho
LT	Lithuania
LU	Luxembourg
LV	Latvia
LY	Libyan Arab Jamahiriya
MA	Morocco
MC	Monaco
MD	Moldova, Republic of
MG	Madagascar
MH	Marshall Islands
ML	Mali
MM	Myanmar
MN	Mongolia
MO	Macau
MP	Northern Mariana Islands
MQ	Martinique
MR	Mauritania
MS	Montserrat
MT	Malta
MU	Mauritius
MV	Maldives
MW	Malawi
MX	Mexico
MY	Malaysia
MZ	Mozambique
NA	Namibia
NC	New Caledonia
NE	Niger
NF	Norfolk Island
NG	Nigeria
NI	Nicaragua
NL	Netherlands
NO	Norway
NP	Nepal
NR	Nauru
NU	Niue
NZ	New Zealand
OM	Oman
PA	Panama
PE	Peru
PF	French Polynesia
PG	Papua New Guinea
PH	Philippines
PK	Pakistan
PL	Poland
PM	Saint Pierre and Miquelon
PN	Pitcairn
PR	Puerto Rico
PT	Portugal
PW	Palau
PY	Paraguay
QA	Qatar
RE	Réunion
RO	Romania
RU	Russian Federation
RW	Rwanda
SA	Saudi Arabia
SB	Solomon Islands
SC	Seychelles
SD	Sudan
SE	Sweden
SG	Singapore
SH	Saint Helena
SI	Slovenia
SJ	Svalbard and Jan Mayen
SK	Slovakia
SL	Sierra Leone
SM	San Marino
SN	Senegal
SO	Somalia
SR	Suriname
ST	Sao Tome and Principe
SV	El Salvador
SY	Syrian Arab Republic
SZ	Swaziland
TC	Turks and Caicos Islands
TD	Chad
TF	French Southern Territories
TG	Togo
TH	Thailand
TJ	Tajikistan
TK	Tokelau
TM	Turkmenistan
TN	Tunisia
TO	Tonga
TP	East Timor
TR	Turkey
TT	Trinidad and Tobago
TV	Tuvalu
TW	Taiwan, Province of China
TZ	Tanzania, United Republic of
UA	Ukraine
UG	Uganda
UM	United States Minor Outlying Islands
US	United States
UY	Uruguay
UZ	Uzbekistan
VA	Vatican City State (Holy See)
VC	Saint Vincent and the Grenadines
VE	Venezuela
VG	Virgin Islands (British)
VI	Virgin Islands (U.S.)
VN	Vietnam
VU	Vanuatu
WF	Wallis and Futuna Islands
WS	Samoa
YE	Yemen
YT	Mayotte
YU	Yugoslavia
ZA	South Africa
ZM	Zambia
ZR	Zaire
ZW	Zimbabwe

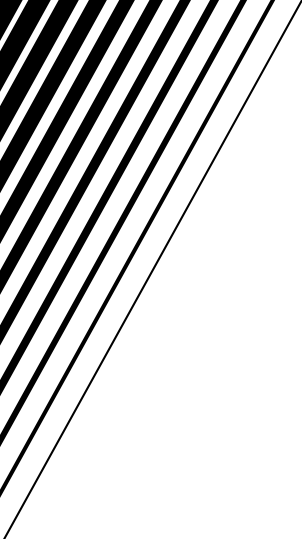

JVC
VICTOR COMPANY OF JAPAN, LIMITED

Free Manuals Download Website

<http://myh66.com>

<http://usermanuals.us>

<http://www.somanuals.com>

<http://www.4manuals.cc>

<http://www.manual-lib.com>

<http://www.404manual.com>

<http://www.luxmanual.com>

<http://aubethermostatmanual.com>

Golf course search by state

<http://golfingnear.com>

Email search by domain

<http://emailbydomain.com>

Auto manuals search

<http://auto.somanuals.com>

TV manuals search

<http://tv.somanuals.com>