

JVC



DVD PLAYER

XV-D701BK

Introduction	1
Preliminary knowledge	4
Getting started	12
Basic operations	20
Advanced operations	26
Setting and adjustment	50
Additional information	64

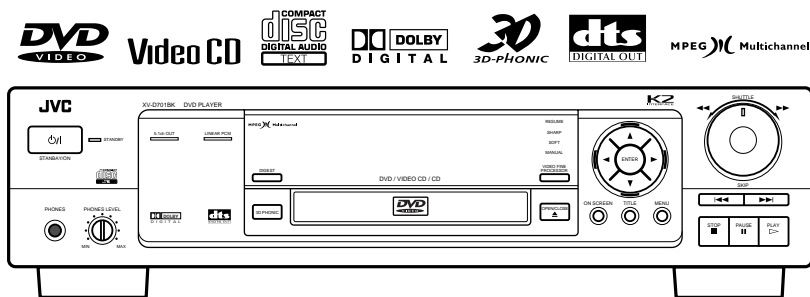

INSTRUCTIONS

For Customer Use:

Enter below the Model No. and Serial No. which are located on the rear, bottom or side of the cabinet. Retain this information for future reference.

Model No. _____

Serial No. _____

LET0141-003A
[B, E]

Table of contents

Introduction Page 2

Features

Notes on care and handling

Preliminary Knowledge Page 4

Names of parts and controls

Front panel	4
Display window	5
Rear panel	5
Remote control unit	6

Display information

On-screen displays	8
To prevent the monitor from burning out – SCREEN SAVER	10
On-screen guide icons	10

Preliminary knowledge about discs

Playable disc types	11
Disc construction	11

Getting started Page 12

Connections

Before making any connections	12
To connect to a TV, monitor, or projector with the audio input and video input jacks	12
To connect to a TV, monitor, or projector with the SCART connector	13
To connect to an audio amplifier or receiver	13
To connect to an amplifier/receiver equipped with 5.1-channel inputs	14
To connect to audio equipment with a digital input ...	15

Turn on the unit

To connect the power cord	16
To install batteries in the remote control unit	16
To turn on/off the unit	17

Using the remote control unit

To use the remote control unit for TV operation	18
To use the remote control unit for satellite tuner operation	19

Basic operations Page 20

Before operation

To turn on your TV and the unit	20
To select the source you want to operate	20

Inserting and removing discs

To insert or remove discs	21
---------------------------------	----

Playing a DVD VIDEO or CD disc

To play a disc from the beginning	22
To stop playback completely	22
To stop playback temporarily	23
To advance or reverse play rapidly while monitoring	23
To locate the beginning of the scene or song	23

Resuming Playback

To store the point where you want to resume playback from – RESUME	24
To resume playback from the stored point – RESUME	24

Summary of basic operations

Advanced operations Page 26

Playing from specific position on a disc

Playing in slow-motion

Playing a scene close-up

Changing the track order

Repeat playback

Sampling all tracks

Viewing from multiple angles

Changing the language and sound

Adjusting the picture to suit the preferences

Adjusting the surround sound

Checking the disc time

Information about CD TEXT

Setting and adjustment Page 50

Selecting preferences

Limiting playback by children

Additional information Page 64

Care and handling of discs

Troubleshooting

Specifications

Table of languages and their

abbreviations

Country code list for parental lock

Features

Picture functions

- **Strobe function**
The unit can display a list of still pictures on the TV screen.
- **Digest function**
You can select the desired title from the opening scenes displayed on the TV screen.
- **Angle function***
You can enjoy variety of scene angles.
- **Zoom function**
You can view scenes close-up.
- **VFP function**
You can change the picture quality.
- **Parental lock***
When a movie which includes violent scenes is played back, the scenes are cut or replayed with other scenes so as not to be viewed by children.

Compatible with a variety of sound formats

- **High quality digital sound**
You can enjoy high quality sound with Dolby Digital, MPEG Audio or Linear-PCM.
- **Surround function***
The unit is compatible with Dolby Digital Surround, DTS surround, and MPEG Multichannel (DTS surround is available for digital output only).
- **3D PHONIC function**
You can enjoy surround sound with your 2 channel system.

Other functions

- **Multi-language subtitles and sound***
You can select the subtitle or sound language.
- **Multi-disc player**
You can also enjoy Audio CD discs and Video CD discs.
- **Operation from the on-screen display**
You can operate the unit from the on-screen display.

Functions with (*) mark only work on a DVD disc that is compatible with each function.

Notes on care and handling

Important cautions

Installation of the unit

- Select a place which is level, dry and neither too hot nor too cold (between 5°C and 35°C, 41°F and 95°F).
- Leave sufficient distance between the unit and the TV.
- Do not use the player in a place subject to vibrations.

Power cord

- Do not handle the power cord with wet hands!
- A small amount of power (2 watts) is always consumed while the power cord is connected to the wall outlet.
- When unplugging the player from the wall outlet, always pull the plug, not the power cord.

To prevent malfunction of the unit

- There are no user-serviceable parts inside. If anything goes wrong, unplug the power cord and consult your dealer.
- Do not insert any metallic object into the unit.
- Do not use any non-standard shape disc available on the market, because it may damage the unit.
- Do not use a disc with tape, seals, or paste on it, because damage to the unit may result.

Note about copyright laws

- Please check the copyright laws in your country before recording from DVD VIDEO, Audio CD, and Video CD discs. Recording of copyrighted material may infringe copyright laws.

Note about the copyguard system

- The DVD VIDEO disc is protected by the copyguard system. When you connect the unit to your VCR directly, the copyguard system activates and the picture may not be played back correctly.

Safety precautions

Avoid moisture, water and dust

Do not place your player in moist or dusty places.

Avoid high temperatures

Do not expose the unit to direct sunlight or place it near a heating device.

When you're away

When away on travel or otherwise for an extended period of time, remove the plug from the wall outlet.

Do not insert foreign objects into the unit

Do not insert wires, hairpins, coins, etc. into the unit.

Do not block the vents

Blocking the vents may damage the unit.

Care of the cabinet

When cleaning the unit, use a soft cloth and follow the relevant instructions on the use of chemically-coated cloths. Do not use benzene, thinner or other organic solvents and disinfectants. These may cause deformation or discoloring.

If water gets inside the unit

Turn off the power switch and remove the plug from the wall outlet, then call the store where you made your purchase. Using the unit in this state may cause a fire or electrical shock.

This product incorporates copyright protection technology that is protected by method claims of certain U.S. patents and other intellectual property rights owned by Macrovision Corporation and other rights owners. Use of this copyright protection technology must be authorized by Macrovision Corporation, and is intended for home and other limited viewing uses only unless otherwise authorized by Macrovision Corporation. Reverse engineering or disassembly is prohibited.

Manufactured under license from Dolby Laboratories. "Dolby" and double-D symbol are trademarks of Dolby Laboratories.

Confidential Unpublished Works.

© 1992-1997 Dolby Laboratories, Inc. All rights reserved.

Manufactured under license from Digital Theater Systems, Inc. US Pat. No. 5,451,942 and other world-wide patents issued and pending. "DTS", "DTS Digital Surround", are trademarks of Digital Theater System, Inc.

© 1996 Digital Theater Systems, Inc. All Rights Reserved.

Names of parts and controls

Refer to the corresponding pages indicated in () for details.

Front panel

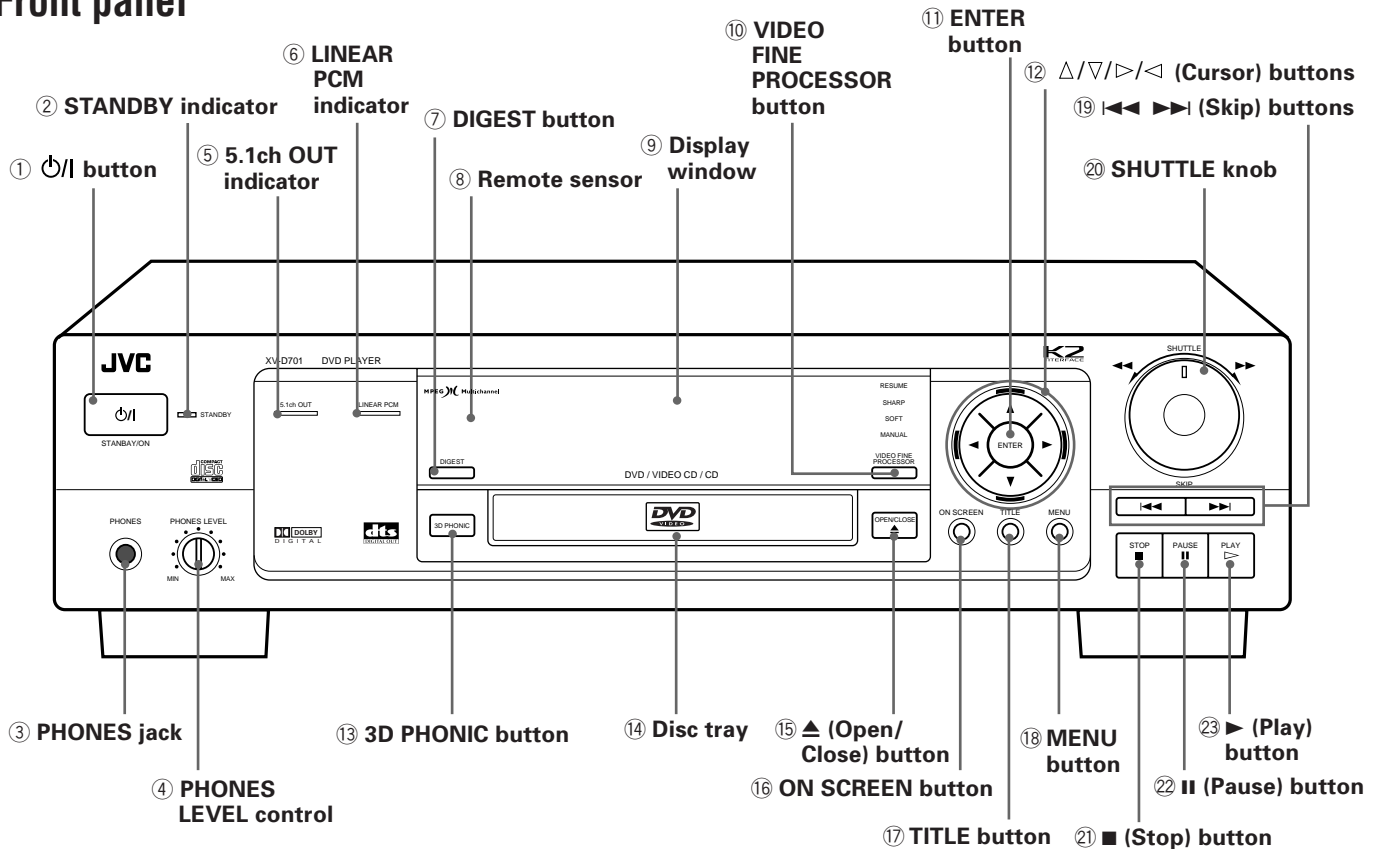

- ① **Power/Standby button (17)**
Turns the unit on or off (standby).
- ② **STANDBY indicator**
Lights when the power cord is connected and the unit is on standby. When the unit is turned on, the STANDBY indicator goes off.
- ③ **PHONES jack**
Connection jack for headphones.
- ④ **PHONES LEVEL control**
Adjusts the volume level of headphones connected to the PHONES jack.
- ⑤ **5.1ch OUT indicator**
Lights when 5.1 channel output signals are fed from the analog audio output jacks.
- ⑥ **LINEAR PCM indicator**
Lights when a Linear PCM audio disc is played back. This indicator also lights in stop mode for Audio CDs.
- ⑦ **DIGEST button (32)**
Displays beginning scenes of each title, chapter, or track on the TV screen.
- ⑧ **Remote sensor**
Receives the signal from the remote control unit.
- ⑨ **Display window**
Indicates the current status of the unit.
- ⑩ **VIDEO FINE PROCESSOR button (45)**
Change the picture quality.
- ⑪ **ENTER button**
Executes a selected item in a menu or on-screen display.
- ⑫ **Cursor buttons (12)**
Selects an item in on-screen displays or menus.
- ⑬ **3D PHONIC button (46)**
Produces a simulated surround effect.
- ⑭ **Disc tray (21)**
Used to load discs.
- ⑮ **Open/Close button (21)**
Opens and closes the disc tray.
- ⑯ **ON SCREEN button (8)**
Displays an on-screen display of the unit on the TV screen or monitor.
- ⑰ **TITLE button (26)**
Displays a title menu of DVD on the TV screen or monitor.
- ⑱ **MENU button (26)**
Displays a menu of DVD on the TV screen or monitor.
- ⑲ **SHUTTLE knob (23, 33)**
Performs fast forward/backward and slow motion playback.
- ⑳ **Skip buttons (23, 28)**
Performs skipping or previous/next operation.
- ㉑ **Stop button (22)**
Stops playback.
- ㉒ **Pause button (23)**
Pauses during playback.
- ㉓ **Play button (22)**
Starts playback. Also, used as a SELECT button for PBC of Video CDs.

Display window

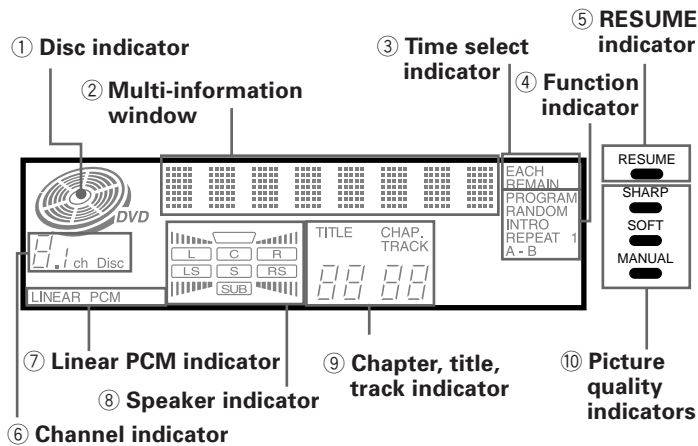

- ① **Disc indicator**
Lights when a disc is in the unit. "DVD" also appears when a DVD disc is in the unit.
- ② **Multi-information window**
Displays time, text, and additional information.
- ③ **Time select indicator**
Shows what the time information in the Multi-information window means.
- ④ **Function indicator**
Activated function indicators light up.
- ⑤ **RESUME indicator**
Lights when a point to be resumed from is stored.
- ⑥ **Channel indicator**
Displays number of channels in the currently selected audio playback format.
- ⑦ **Linear PCM indicator**
Lights only when the playback disc contains linear PCM data. This indicator also lights while an Audio CD is placed in the unit.
- ⑧ **Speaker indicator**
Lights during disc playback. The display shows all possible audio output channels contained in the 5.1ch. format. lights when signals are output from the corresponding audio output jacks. lights when signals are output from the video output jacks. When the 3D PHONIC function is ON, also lights.
- ⑨ **Chapter, title, track indicator**
Displays chapter, title, or track number.
- ⑩ **Picture quality indicators**
Selected indicator of the picture quality lights up.



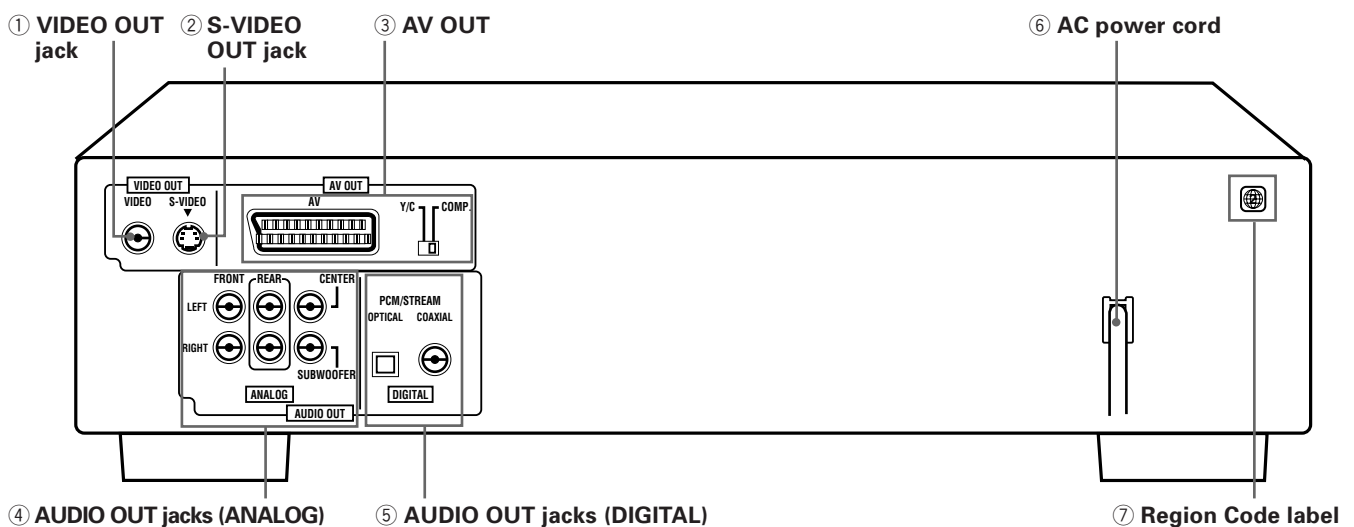





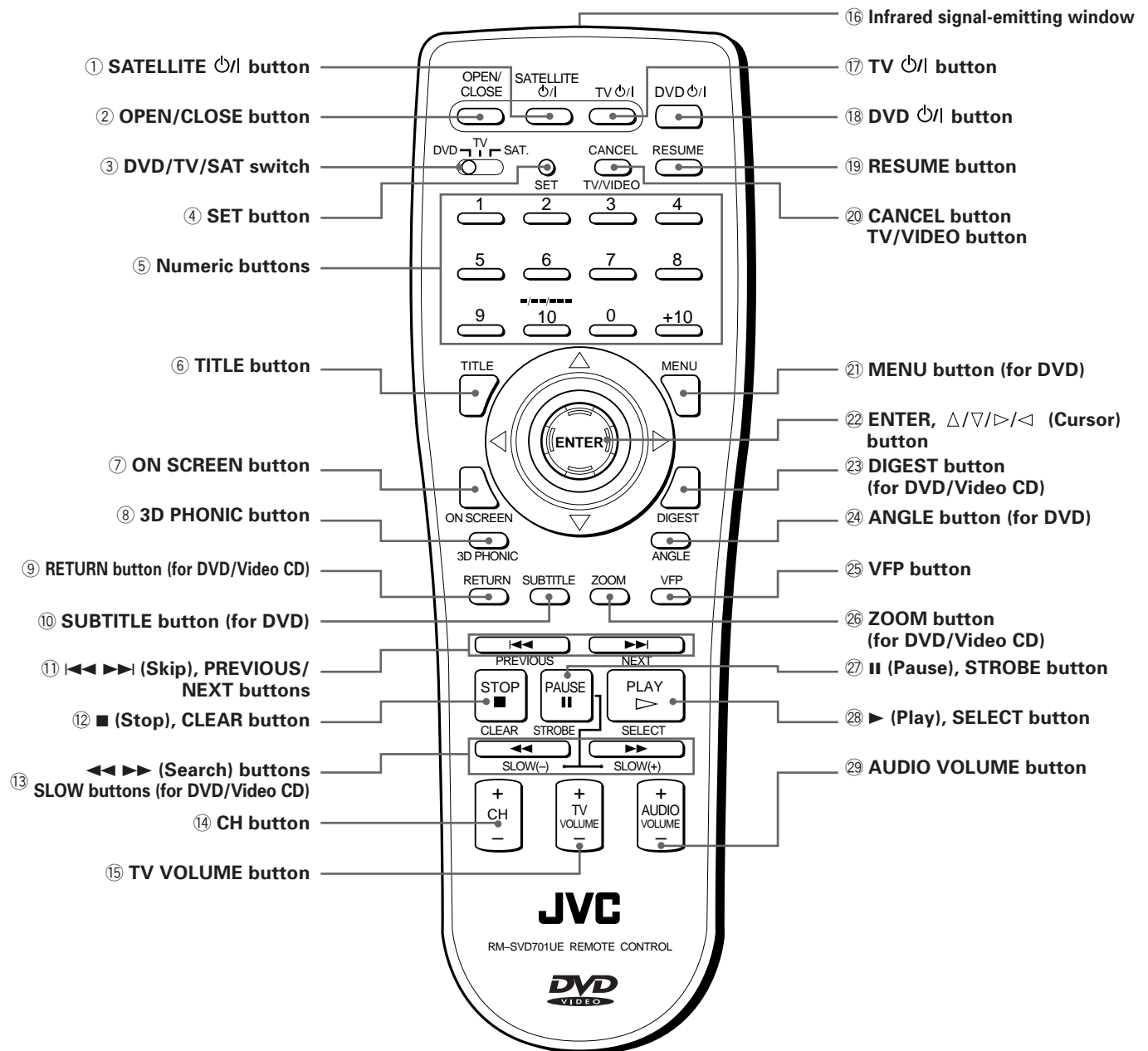





Rear panel



- ① **VIDEO OUT jack (12)**
Outputs a composite video signal.
- ② **S-VIDEO OUT jack (12)**
Outputs an S-video signal.
- ③ **AV OUT (13)**
Standard 21-pin SCART connectors (feed the video and audio signals). The video output signal is selected from composite (COMP) and Y/C by the COMP-Y/C switch. The audio signal is same as AUDIO OUT.
- ④ **AUDIO OUT jacks (ANALOG) (12, 13, 14, 15)**
FRONT (RIGHT and LEFT), REAR (RIGHT and LEFT), CENTER, and SUBWOOFER terminals output 5.1ch analog audio signals (Dolby Digital, MPEG Multichannel) FRONT terminals also OUTPUT Stereo analog audio signals.
- ⑤ **AUDIO OUT jack (DIGITAL) (15)**
Outputs digital audio signals. Both coaxial and optical connectors are provided.
- ⑥ **AC power cord (16)**
Connects to the wall outlet.
- ⑦ **Region Code label (11)**
Shows Region Code number.

Remote control unit



- ① **SATELLITE  button (19)**
Turns the satellite tuner on or off.
- ② **OPEN/CLOSE button (21)**
Opens and closes the disc tray.
- ③ **DVD/TV/SAT switch (18, 19, 20)**
Selects the function of the numeric buttons to control the corresponding device.
- ④ **SET button (18, 19)**
Used to set the manufacturer's code for operating another manufacturer's TV, satellite tuner from the remote control unit.
- ⑤ **Numeric buttons (18, 19, 25)**
Depending on the selection of the DVD/TV/SAT. switch, they are used for entering a title, track or chapter number, or selecting a TV channel.
- ⑥ **TITLE button (26)**
Displays a title menu of DVD on the TV screen or monitor. Switches the display in the display window (for Audio CD).
- ⑦ **ON SCREEN button (8, 50)**
Displays an on-screen display of the player on the TV screen or monitor.
- ⑧ **3D PHONIC button (46)**
Produces a simulated surround effect.
- ⑨ **RETURN button (for DVD/Video CD)**
Returns to the previous menu.
- ⑩ **SUBTITLE button (for DVD) (42)**
Turns subtitles on or off.
- ⑪ **  (Skip), PREVIOUS/NEXT (for DVD/Video CD) buttons (23, 26, 27)**
Performs skipping a chapter, title or track.
Also used for the page selection of a menu screen (for DVD/Video CD).
- ⑫ ** (Stop), CLEAR button (22)**
Stops playback.
Also used to erase all the programmed tracks for the program play (for Audio CD/Video CD).
- ⑬ **  (Search), SLOW (for DVD/Video CD) buttons (23, 33)**
Performs fast forward/backward playback operations.
Also used for slow-motion playback of a picture (for DVD/Video CD).
- ⑭ **CH button (18, 19)**
Changes the channels of TV or satellite tuner.
- ⑮ **TV VOLUME button (18, 22)**
Adjusts the TV volume.
- ⑯ **Infrared signal-emitting window**
Point this window toward the remote sensor on the front panel when pressing buttons.
- ⑰ **TV  button (18)**
Turns the TV on or off.
- ⑱ **DVD  button (17)**
Turns the unit on or off (standby).
- ⑲ **RESUME button (24)**
Stores the location to resume playback from later.
- ⑳ **CANCEL, TV/VIDEO button (18, 35)**
Cancels the previous settings.
Also used to switch the input mode of TV.
- ㉑ **MENU button (for DVD) (26)**
Displays a menu of DVD on the TV screen or monitor.
- ㉒ **ENTER,  /  /  /  (Cursor) button**
Executes a selected item in a menu or on-screen display when pressing the button. Selects an item in the on-screen display or title menus or menus of DVD when tilting.
- ㉓ **DIGEST button (for DVD/Video CD) (32)**
Displays beginning scenes of each title, chapter, or track on the TV screen.
- ㉔ **ANGLE button (for DVD) (40)**
Changes camera angles during playback of a DVD containing multiple camera angles.
- ㉕ **VFP button (45)**
Changes the picture quality.
- ㉖ **ZOOM button (for DVD/Video CD) (34)**
Scene in a close-up view.
- ㉗ ** (Pause), STROBE (for DVD/Video CD) button (23, 33)**
Pauses during playback.
Also used to display nine continuous still pictures (for DVD/Video CD).
- ㉘ ** (Play), SELECT button (22, 27)**
Starts playback.
Also used as a SELECT button in the PBC mode (for Video CD).
- ㉙ **AUDIO VOLUME button (22)**
Adjusts the volume of a JVC AV amplifier or receiver.

Display information

The unit provides several on-screen displays and on-screen guide icons to help you operate the unit.















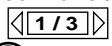

On-screen displays

The unit provides several on-screen displays as shown below for choosing preferences for initial settings and functions which are not frequently used.

To access on-screen displays

Press  (Note that operation for accessing the "PARENTAL LOCK" on screen displays is different.). Depending on the type of disc inserted (or "no disc") and the player's mode, a proper on-screen display is accessed.

Basic operations in on-screen displays

-  appears at the on-screen display. You can move  using .  is used to select items you want to work with.
- With an item like , you can change the setting by placing  on the item and press .
-  - type item works when you place  on the item and press .
- In the message box, the operation to be performed is displayed according to the item pointed by .
- Numbers are entered using  to , .
- Some functions become effective by pressing  after specifying necessary entries.
- Pressing  again exits the on-screen display.

Opening display



Appears when the unit turns on.



Preference (1 and 2) and Speaker setting displays (see page 50)

You can set preferences and speaker setting via these displays.

To display the Preference1/Preference 2/ Speaker setting display

- 1 Press  to stop the unit.
If the current disc is not a DVD disc, you have to remove the disc from the tray.
- 2 Press .

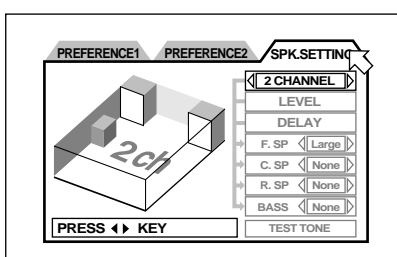
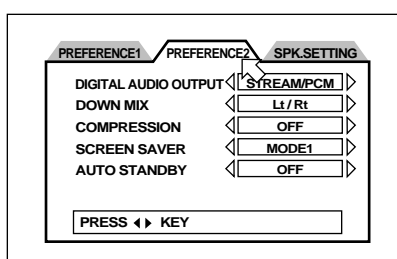
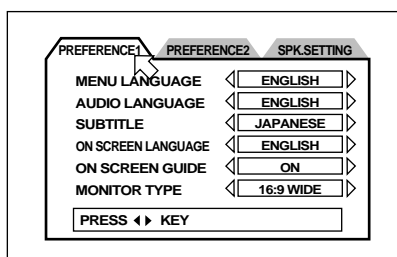

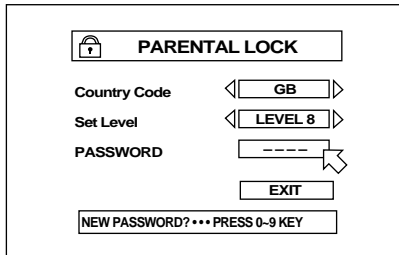

Parental Lock on-screen display (see page 61)

You can set the parental lock from this display.

To display the Parental Lock on-screen display

Press while holding down .

The Parental Lock on-screen display appears on the TV screen.

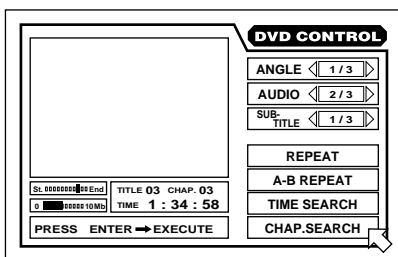

The DVD on-screen display during playback

You can select and set various function for DVD playback from this display.

To display the DVD on-screen display

During DVD playback, press .

Current relative position the title (St: start, End: end).
 Current title number
 Current chapter number



Transmission rate
 Elapsed time from the beginning of the current title

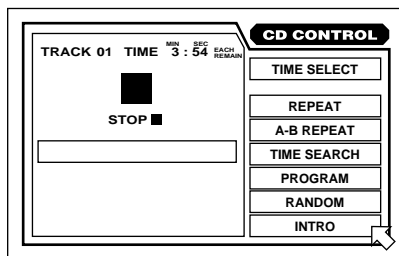

The CD on-screen display

You can select and set various function for Audio CD playback from this display.

To display the CD on-screen display

During Audio CD playback or stop mode, press .

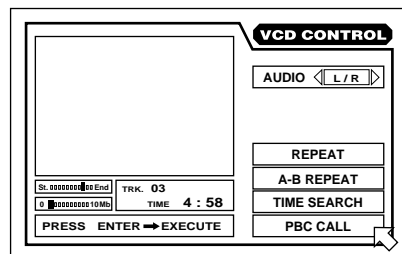

The Video CD on-screen display during playback

You can select and set various functions for Video CD playback on this display. When a Video CD disc is stopped, the same on-screen display which appears when an Audio CD disc is stopped appears.

To display the Video CD on-screen display

During Video CD playback or stop mode, press .

Current relative position of the track (St: start, End: end).
 Current track number



Transmission rate
 Elapsed time from the beginning of the current track

To prevent the monitor from burning out [SCREEN SAVER]

A television monitor screen may be burned out if a static picture is displayed for a long time. To prevent this, the unit automatically activates the screen saver function if a static picture, such as an on-screen display or menu, is displayed for over 5 minutes.

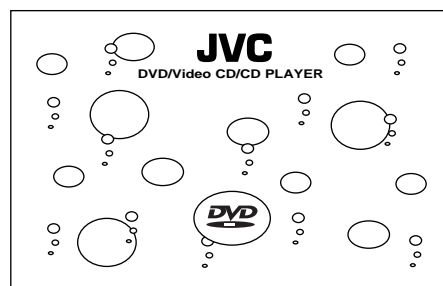

- Pressing any button on the unit or the remote control unit will release the screen saver function and return to the previous display.
- You can select one of several screen saver modes available (see page 56).
- When this function is set to "DIMMER", the display window on the panel always gets dark (FL Dimmer) in addition to the screen saver function (see page 56).

On-screen guide icons

During DVD playback, you may see icons displayed over the picture. These have the following meanings.



: Displayed at the beginning of a scene recorded from multiple angles. (See page 40.)





: Displayed at the beginning of a scene recorded with multiple audio languages. (See page 43.)



: Displayed at the beginning of a scene recorded with multiple subtitles language. (See page 42.)

You can set the unit not to display on-screen icons above via the preference settings described on page 53.

About invalid operation icon

When you press a button, if the unit does not accept its operation,  appears on your television screen. Operations are occasionally unacceptable even if  is not displayed.

Note that some operations may not be accepted. For example, some discs may not allow fast forward, fast backward or slow-motion playback.

Preliminary knowledge about discs

Playable disc types

Playable and non-playback disc types are as follows:

Playable discs					
DVD VIDEO	Video CD			Audio CD	
					
Non-playable discs					
DVD-ROM	DVD-RAM	DVD Audio	DVD-R	DVD-RW	CD-G
CD-R	CD-ROM	PHOTO CD	CD-RW	CD-EXTRA	

Notes on DVD VIDEO discs

- DVD players and DVD discs have their own Region Code numbers. This player only can play back DVD discs whose Region Code numbers include "2".
Examples of playable DVD discs:



- This player accommodates discs for the PAL system.
- Playing back discs listed as "Non-playable discs" in the table above may generate noise and damage speakers

Disc construction

A DVD disc is comprised of "titles", while an Audio CD or Video CD is comprised of "tracks." Each title may be divided into some "chapters." For example, if a DVD disc contains some movies, each movie may have its own title number, and each movie may be divided into some chapters. In a DVD karaoke disc, each song usually has its own title number and does not have chapters. In general, each title has independent content, while each chapter in the same title has continuity.

(Example: DVD disc)

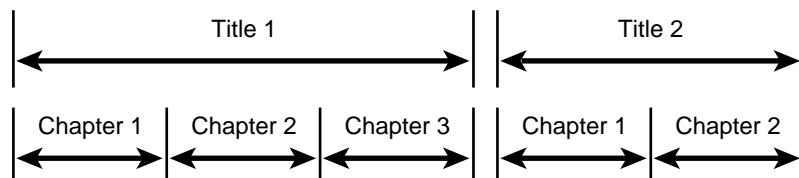

(Example: Audio CD/Video CD)

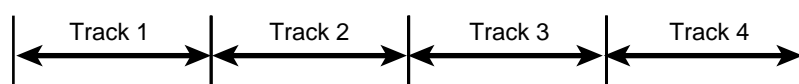

Connections

Before using the unit, you have to connect the unit to a TV or amplifier. By connecting to an amplifier which has a digital terminal or Dolby digital capability, you can enhance the sound quality.

Before making any connections

- Do not connect the AC power cord until all other connections have been made.
- Since different components often have different terminal names, carefully read the instructions supplied with the component you wish to connect.

To connect to a TV, monitor, or projector with the audio input and video input jacks

You can enjoy using the unit by simply connecting it to a television set. To hear improved audio sound quality, connect the audio outputs to your audio equipment. (See the following pages.)

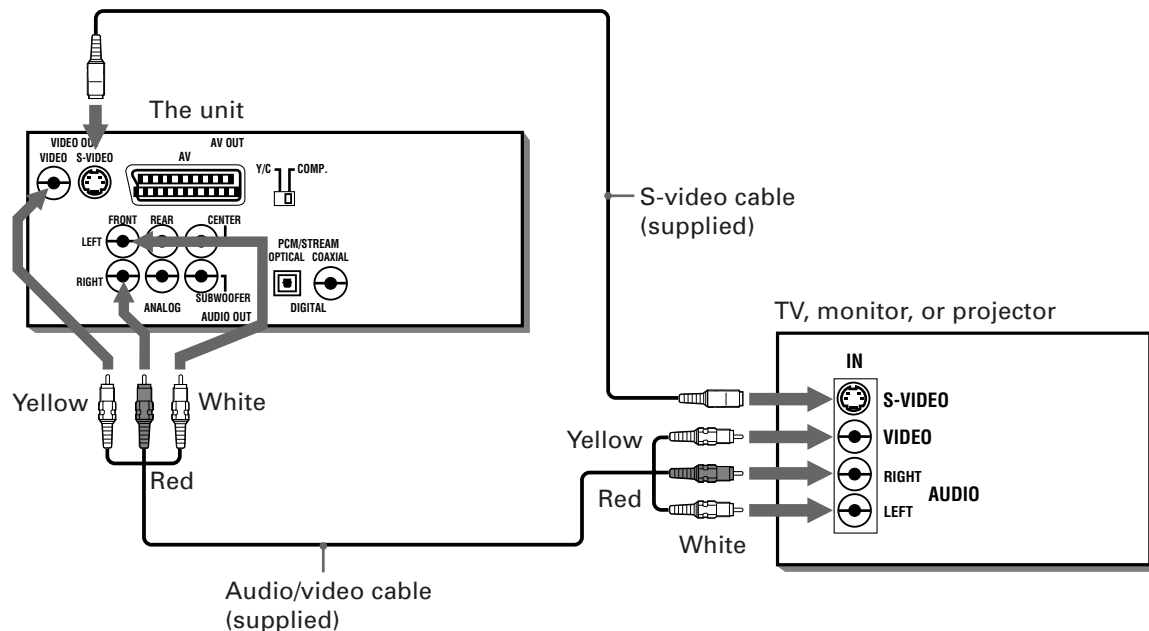

Connect the unit to a television set equipped with stereo audio input and video input jacks using the supplied audio/video cables.

- If your television set has a monaural audio input instead of stereo, you need to use an optional audio cable which converts stereo audio output to monaural.
- If your television set has an S-video input, you should connect it with the S-VIDEO output of the unit using the supplied S-video cable in addition to the (standard) video connection to get better picture quality.

NOTE

- Connect VIDEO OUT of the unit to the video input of a television set. Connecting VIDEO OUT of the unit to a TV via a VCR may cause a monitor problem when playing back a copy-protected disc.
- Do not connect the player to a NTSC system. Connect it to a PAL system.

To connect to a TV, monitor, or projector with the SCART connector

You can enjoy the unit by simply connecting it with your television set via a 21-pin SCART cable. To hear audio sound with better quality, connect the audio outputs with your audio equipment. (See the following pages.)

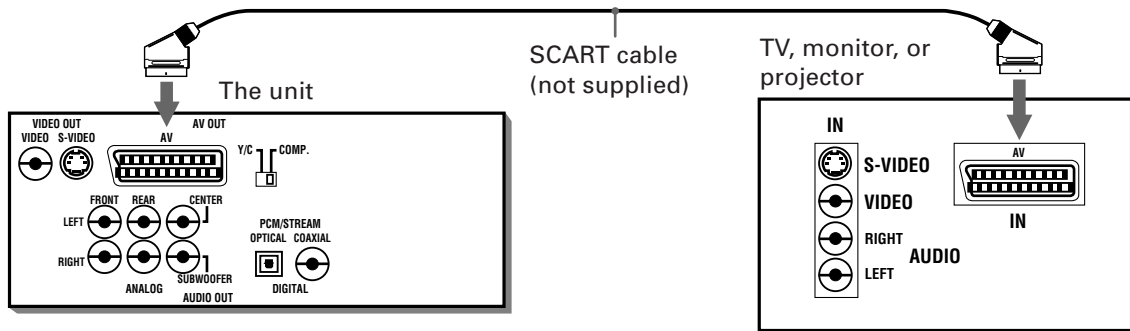

Connect the player's AV OUT connector with your TV's SCART connector using an optional SCART cable.

- If your TV's SCART connector is compatible only with the regular video signal, set the COMP.-Y/C switch to "COMP."
- If your TV's SCART connector is compatible with the Y/C signal, set this switch to "Y/C". You will enjoy better-quality pictures.

NOTES

- Be sure not to plug in the power cord until all other connections have been made.
- Do not connect the player with a NTSC television. Connect it with a PAL television.

To connect to an audio amplifier or receiver

Connection to an audio amplifier or receiver

You can enjoy high-quality audio by connecting the unit's audio outputs to your amplifier or receiver.

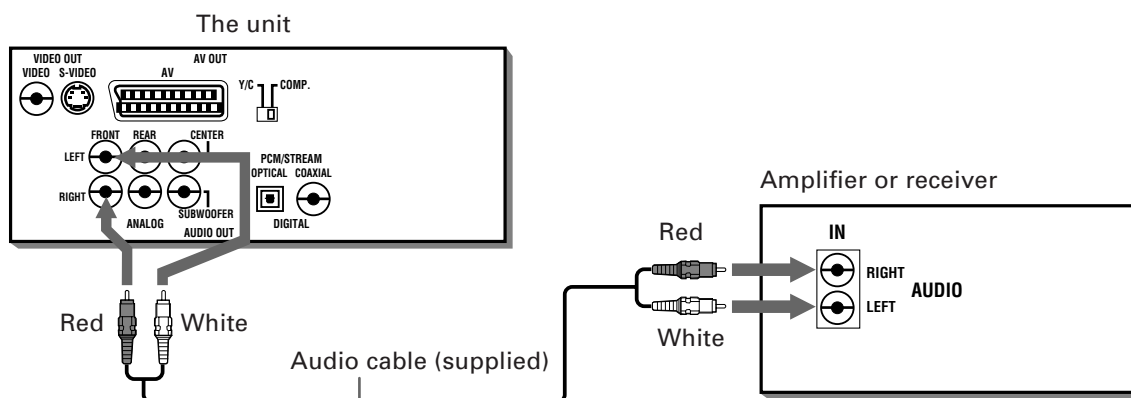

- Connect the unit's FRONT to any line-level inputs (such as AUX, DVD, CD, etc.) of an audio amplifier or receiver.

NOTE

- To playback a disc containing Dolby Digital 5.1-channel format with this connection, set the "DOWN MIX" in the "PREFERENCE 2" on screen display to "Lt/Rt" or "Lo/Ro" according to the connected amplifier or receiver. See "DOWN MIX" on page 55.

To connect to an amplifier/receiver equipped with 5.1-channel inputs

The Dolby Digital decoder and MPEG Multichannel decoder are built in the unit, so you can enjoy the Dolby digital and MPEG Multichannel surround sound without the need of an external decoder. Connect the unit's 5.1-channel outputs to the 5.1-channel inputs of an amplifier or receiver using the supplied audio cables.

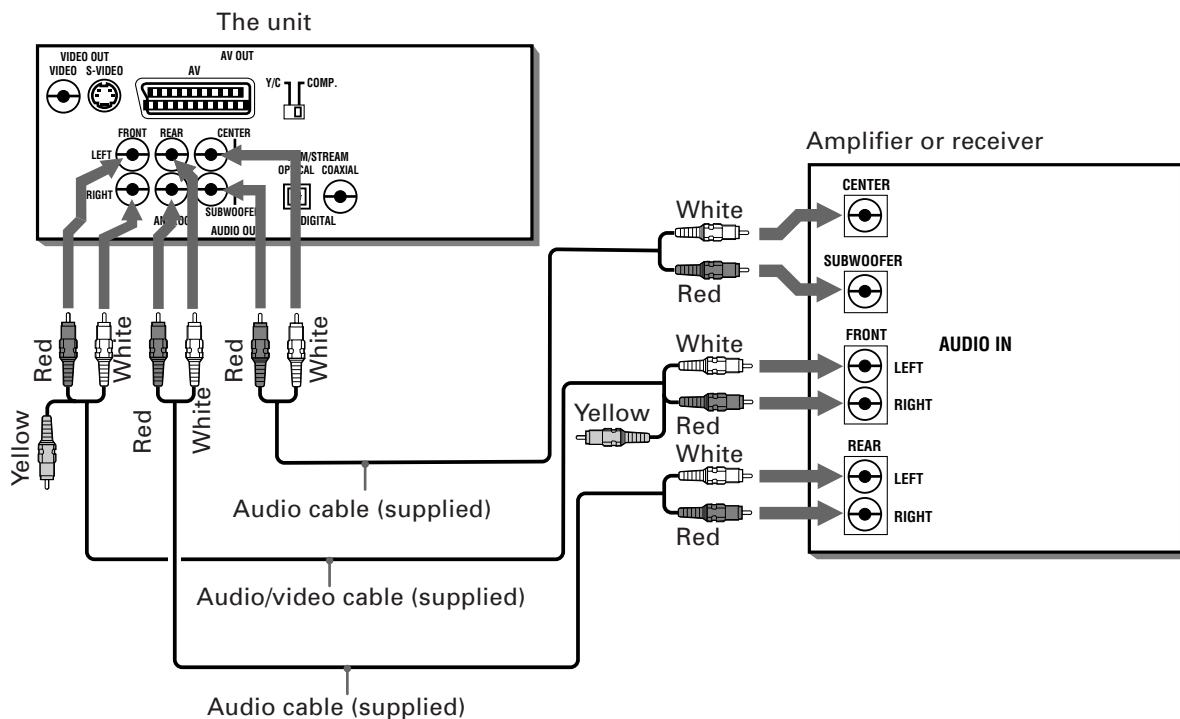

- Be sure to connect correctly between corresponding terminals. The order of the 5.1-channel terminals depend on units.
- An Audio/video cable is recommended for connection to the FRONT terminal (Yellow jack (for Video Signal) is not used in this connection).

NOTE

- When using the 5.1-channel outputs of the unit, set the "DOWN MIX" in the "PREFERENCE 2" on-screen display to "OFF" and select "5.1 CHANNEL" or "EXPERT" in the "SPK.SETTING" on-screen display. If the "EXPERT" is selected, you can control the audio output balance of the speakers (see pages 55 and 57).

To connect to audio equipment with a digital input

Connection to a stereo amplifier/receiver (or a recording device such as DAT and MD recorders) which provides digital stereo input(s), a Dolby Digital decoder (or an amplifier with built-in Dolby Digital decoder), a DTS decoder (or an amplifier with built-in DTS decoder), or an MPEG multichannel decoder (or an amplifier with built-in MPEG multichannel decoder).

You can enhance the sound quality by connecting the unit's DIGITAL OUT (coaxial or optical) to the digital input of an amplifier, DAT or MD recorder by using an optional digital cable. The digital stereo audio signal from a disc is directly transferred. If you connect to a Dolby Digital decoder (or an amplifier with built-in Dolby Digital decoder), a DTS decoder (or an amplifier with built-in DTS decoder), or an MPEG multichannel decoder (or an amplifier with built-in MPEG multichannel decoder) by using an optional digital cable (coaxial or optical), you can enjoy high-quality audio and surround sound. When you make a digital connection, leave the stereo analog audio connection as it is. Otherwise, depending on the disc type, no audio may be reproduced.

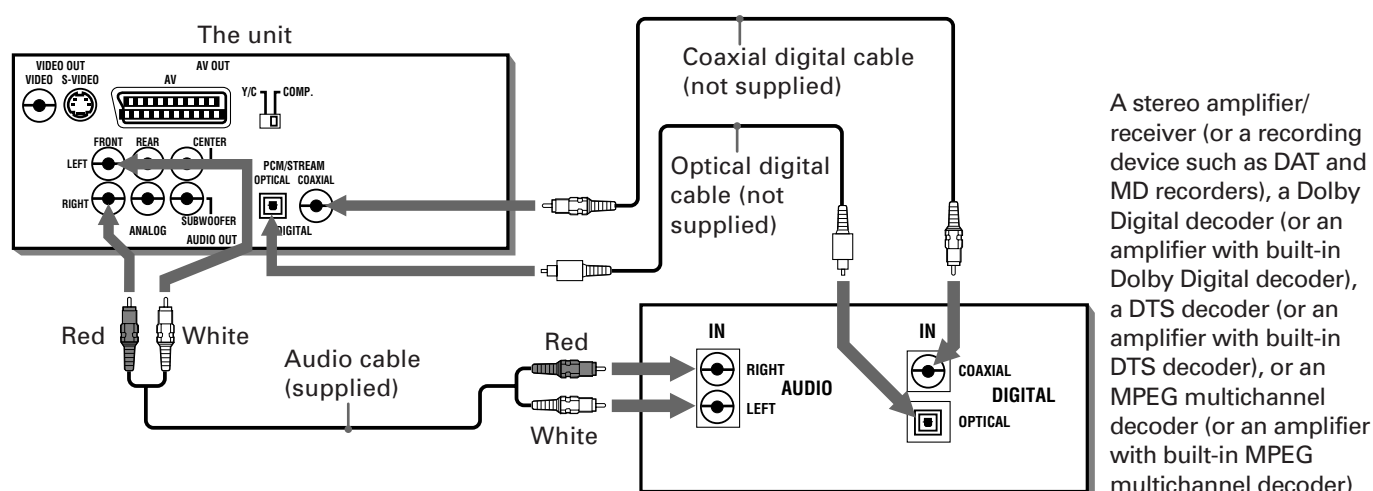

- For digital connection, connect the unit's DIGITAL out (coaxial or optical) to the digital input of a decoder or an amplifier with built-in Dolby Digital or DTS or MPEG Multichannel decoder using an optional digital cable.

NOTES

- **DTS (Digital Theater System)**
DTS is a newly-developed surround system which can handle more amount of data than Dolby Digital, providing better audio quality.
Though the number of audio channels is 5.1 which is same as Dolby Digital, DTS provides fat sound and better signal-to-noise ratio, thanks to the lower audio compression ratio format. It also provides wide dynamic range and better separation, resulting magnificent sound.
- **MPEG multichannel**
MPEG multichannel is a surround system format which can handle the augmentative 7.1-channel surround format, as well as the 5.1-channel format.
- When you connect the audio equipment with a digital input, before using, change the "DIGITAL AUDIO OUTPUT" setting in the "PREFERENCE 2" on-screen display according to the connected audio equipment with a digital input. When the "DIGITAL AUDIO OUTPUT" setting is not set correctly, loud noise may be played back from speakers, and it cause of the breakdown of your speakers. See "DIGITAL AUDIO OUTPUT" on page 54.
- With this connection, the unit's settings for "COMPRESSION" and "DOWN MIX" in the "PREFERENCE 2" on-screen display and the "SPK.SETTING" on screen display are invalid. Settings for these items must be made from the decoder.

Turn on the unit

To connect the power cord

When all the connections have been made, insert the power plug into the wall outlet firmly. The STANDBY indicator lights and setup is completed.

Warning

- Disconnect the power cord if you are not going to use the unit for a long time.
- Disconnect the power cord before cleaning the unit.
- Disconnect the power cord before moving the unit.
- Do not connect or disconnect the power cord with wet hands.
- Do not pull the power cord when disconnecting it, as this may damage the cord and cause fire, electric shock, or other accidents.

Caution

- Do not damage, remodel, twist, or pull the power cord, as this may cause fire, electric shock, or other accidents.
- Contact a dealer and get a new power cord if the cord is damaged. A damaged cord may cause fire, electric shock, or other accidents.
- Do not put anything heavy, or the unit, on the power cord, as this may cause fire, electric shock, or other accidents.

To install batteries in the remote control unit

The battery compartment is located on the back of the remote control unit.

- 1** Press down on the point shown by the arrow at the top of the compartment cover, and pull up the cover to open the compartment.

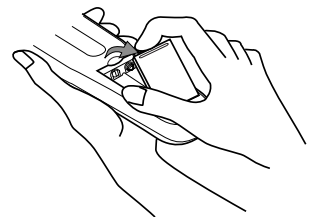

- 2** Place the two accessory R6P (SUM-3)/AA(15F) batteries in the remote control according to the polarity markings (“+” and “-”) inside the compartment and on the batteries.

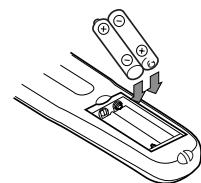

- 3** Place the cover over the compartment, and press down lightly.

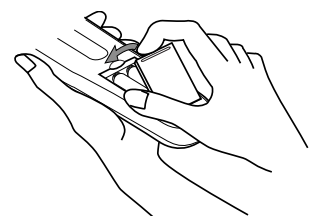

- The batteries will last about six months with normal use. If the functions of the remote control become erratic, replace the batteries. See “Precautions for the safe use of batteries” below for more information.

Precautions for the safe use of batteries

Observe the following precautions for the safe use of batteries. If they are used improperly, their life will be shortened, they may burst or their contents may leak.

Precaution

- Remove the batteries from the remote control if it is not going to be used for a long period of time.
- Remove dead batteries and dispose of them properly.
- Never leave dead batteries lying around, take them apart, mix them with other refuse, or throw them into an incinerator.
- Never touch liquid that has leaked out of a battery.
- Do not mix new and old batteries, or batteries of different types, when replacing them.



To turn on/off the unit

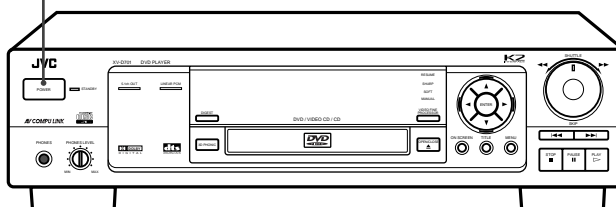

Press  on the front panel or press  on the remote control unit.

 button



Hints

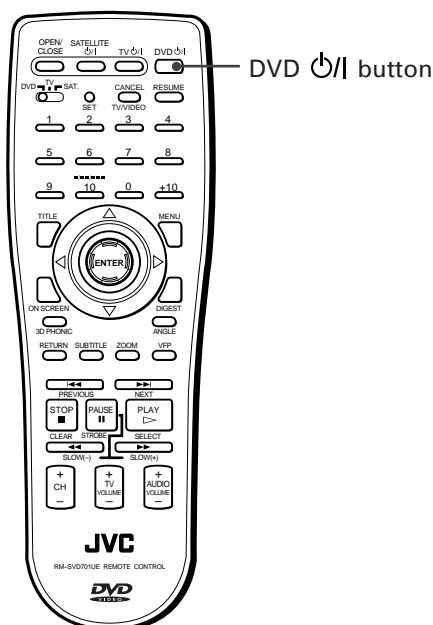

You can turn on the unit by pressing  on the front panel or  on the Remote control unit. In this operation, the unit starts playback when the disc is set. If not set, the disc tray opens.

You can also turn on the unit by pressing  on the front panel or  on the remote control unit. In this case, the disc tray opens.



DVD  button

NOTE

- Even if you press  or  to turn off the unit, the unit is not disconnected from the AC power source as long as it is connected to the wall outlet. This state is called the standby mode. In this state, the unit is designed to consume a very small quantity of power.









Using the remote control unit

You can operate the unit with the remote control unit, and you can also operate your TV or other components with the remote control unit.

To use the remote control unit for TV operation

You can operate a JVC TV with the remote control unit. To operate another manufacturer's TV, you have to change the remote control signal. Also refer to the manual supplied with your TV.









Changing the remote control signal

- 1 Set  on the remote control unit to TV.
- 2 Press and hold , then press . Do not release . Keep holding  until the next step is completed.
- 3 Holding , enter the manufacturer code (two digits) using  to . See the lists on the left to find the manufacturer code.
- 4 Release .

Manufacturer code list

No.	Manufacturer
01	JVC
02	JVC
03	JVC
04	JVC
05	BRANDT
05	NOROMENDE
05	SABA
05	TELEAVIA
05	TELEFUNKEN
05	THOMSON
06	FERGUSON
07	PHILIPS
08	BLAUPUNKT
08	GRUNDIG
09	SONY
10	PANASONIC
11	GRAETZ
11	ITT
11	LUXOR
11	SALORA
11	SELECO
12	MIVAR
13	HITACHI
14	TOSHIBA
15	MITSUBISHI
16	FINLUX
17	NOKIA
18	SHARP
19	SAMSUNG
20	FUNAI
21	GOLDSTAR
22	NEC

The following buttons can be used for operating the TV:

	Turns the TV on or off.
	Changes the TV channels. (with  set to TV only)
	Adjusts the TV volume.
	Selects the TV channels (with  set to TV only)
	You can switch input mode (either TV or VIDEO). (with  set to TV only)

- 5 Try to operate your TV by pressing . If your TV turns on or off, you have entered the correct code.









NOTE

- If there is more than one code listed for your brand of TV, try each one until the correct one is entered.



To use the remote control unit for satellite tuner operation

You can operate the satellite tuner with the remote control unit. To operate it, you have to change the remote control signal. Also refer to the manual supplied with it.

Changing the remote control signal

- 1 Set  on the remote control unit to SAT.
- 2 Press and hold , then press . Do not release . Keep holding  until the next step is completed.
- 3 Holding , enter the manufacturer's code (two digits) using  to . See the lists on the right to find the manufacturer's code.
- 4 Release .

The following buttons can be used for operating the satellite tuner (with  set to SAT.):

	Turns the satellite tuner on or off.
	Changes the channels.
	Selects the channels.

- 5 Try to operate the satellite tuner by pressing . If the satellite tuner turns on or off, you have entered the correct code.

Manufacturer's code list

No.	Manufacturer
01	AMSTRAD
02	AMSTRAD
03	AMSTRAD
04	RFT/ANKARO/QUADRAL/SKYMASTER
05	RFT
06	KATHREIN
07	KATHREIN
08	KATHREIN/MASPRO
09	KATHREIN/PHILIPS
10	NOKIA
11	NOKIA/GRUNDIG
12	GRUNDIG/SIEMENS
13	PAGE
14	TECHNISAT
15	WISI
16	WISI/RADIX
17	FUBA/SEG
18	FTE

NOTE

- If there is more than one code listed for your brand of the satellite tuner, try each one until the correct one is entered.

Before operation



To turn on your TV and the unit

To operate your TV from the remote control unit, you have to set the remote control unit to operate your TV (see page 18).

1 Press  to turn on your TV.

2 Press  to turn on the unit.



To select the source you want to operate

You can operate the unit with the remote control unit and operate some functions of your TV or the satellite tuner unit.

● To operate the unit, set  on the remote control unit to DVD.

To operate the unit, point the remote control unit at the remote sensor of the unit.

● To operate the TV, set  on the remote control unit to TV.

To operate the TV, point the remote control unit at the remote sensor of the TV.

● To operate the satellite tuner. unit, set  on the remote control unit to SAT.

To operate the satellite tuner. unit, point the remote control unit at the remote sensor of satellite tuner unit.



- You can adjust the volume level, select the TV channel, and change the input source of your TV from the remote control unit (see page 18).
- You can select the channel of your satellite tuner from the remote control unit (see page 19).

Inserting and removing discs



To insert or remove discs

1 Press to open the disc tray.

2 Place the disc in the tray.

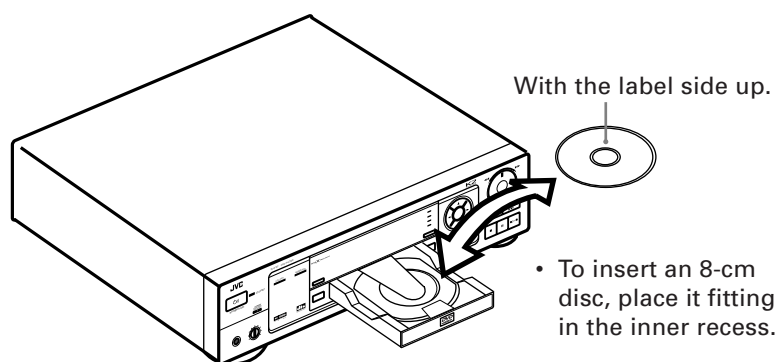

3 Press to close the disc tray.



You can also insert and remove the disc from the on-screen display.

1. Use to move to , then press to open the disc tray.

2. Place or remove the disc.

3. Use to move to , then press to close the disc tray.

Information about the opening display

When you insert a DVD VIDEO disc



When you insert an Audio CD disc

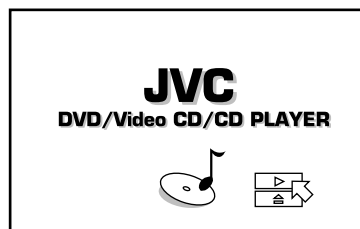

When you insert a Video CD disc

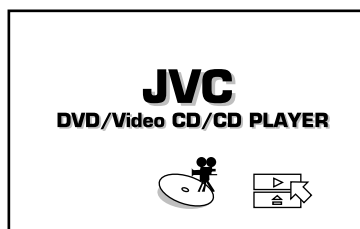

NOTES

- The unit can playback DVD VIDEO, Audio CD, and Video CD discs only. Do not load other disc types. For details, see page 11.
- When loading a disc in the tray, be sure to position the disc inside the recess. Otherwise, the disc may be damaged when the tray is closed, and the disc may not be removable from the unit.

Playing a DVD VIDEO or CD disc

Now you can play a DVD VIDEO or a CD disc. First, let's enjoy simple playback according to following procedure.



To play a disc from the beginning



Short cuts

Press .





The unit starts playback from the beginning.



When you play a Video CD disc with PBC function or DVD disc, the menu display may appear on the TV screen. In this case, you can operate some functions such as playback from the menu displayed on the TV screen.

For the operation using the menu of DVD, see page 26.







For the operation using the menu of Video CD, see page 27.

1 Use  to move  to , then press .



■ The unit starts playback from the beginning.

To adjusting the volume level

- **For TV**
Press  to increase the volume, and  to decrease the volume.
- **For a JVC amplifier**
Press  to increase the volume, and  to decrease the volume.
- **For other amplifier or receiver**
Adjust the volume level of the connected amplifier or receiver. See the instructions of the amplifier or receiver.
- **For headphones**
To increase the volume, turn  to the right. To decrease the volume, turn  to the left.



To stop playback completely



1 Press .

■ The unit stops playback.



To stop playback temporarily





1 Press .

- The unit pauses playback. To continue playback, press .





To advance or reverse play rapidly while monitoring



Keep pressing  or  to advance or reverse play rapidly. When you release the button, the unit returns to normal playback.

- During playback

1 Press  or .

Press  to advance playback rapidly, and  to reverse playback rapidly. Each time you press the button, advance playback or reverse playback speed increases. To return to the normal playback, press .

You can also advance or reverse play rapidly with the SHUTTLE knob on the front panel. To advance play rapidly, turn the shuttle knob to the right and hold, and to reverse play rapidly, turn the shuttle knob to the left and hold. When you release the shuttle knob, the unit returns to normal playback. The playback speed changes according to the amount you turn the shuttle knob.

SHUTTLE knob

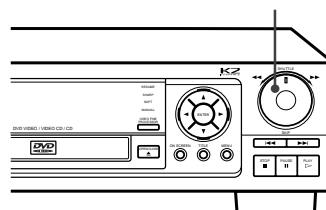



To locate the beginning of the scene or song



- During playback

1 Press  or .

Press  to locate the beginning of the current chapter, title, or track, and press  to locate the beginning of the next chapter, title, or track.

The unit locates the beginning of the track when you play a Video CD disc without the PBC function or Audio CD disc. When you play a Video CD disc with the PBC function or DVD VIDEO disc, the unit may locate different place, but mostly it locates on the beginning of the title or chapter or track.

Resuming playback

The unit stores the position on a disc where you want to interrupt playback at, and resumes playback from that position later.



To store the point where you want to resume playback from [RESUME]



You can store the position on a disc where you want to interrupt playback at by pressing instead of .

■ During playback

1 Press .

The unit stores the current playback position of the disc, and the RESUME indicator on the front panel lights.

The last stored memory overrides the previous memory.



To resume playback from the stored point [RESUME]



The unit also resumes playback by pressing during standby mode.

■ During stop mode

1 Press .









The unit resumes playback from the stored position.





NOTES

- **When you resume playback during playback of a Video CD disc with PBC function, the unit may resume playback from a point slightly earlier than the point you stored.**
- **To clear the memory**
Take out the disc from the unit.

Summary of basic operations

The basic operations and buttons for basic operations are shown in table below:

To	Press
Turn on/off the unit	DVD 
Play	
Stop	
Pause	
Advance or reverse play rapidly while monitoring	 /  or turn the shuttle knob and hold.
Locate the beginning of a scene or song	 /  until it clicks.

To	Press
Turn on your TV	TV 
Adjust the volume of your TV	
Move the cursor on the TV screen	
Decide the cursor position	

How to use numeric buttons

The numeric buttons are used to select a track or title number.

To use  to ,  (described as "press  to , ").

1. Set  to DVD.

2. Select a desired track or title number.

- **To select a number between 1 and 10**





Press the corresponding button for the number.





- **To select a number higher than 10**

Use .

Example :

To select 13  → 

To select 34  →  →  → 





To select 40  →  →  → 





To use  to  (usually used for time search and described as "press  to ").

1. Set  to DVD.





2. Select the time.





Example (for DVD VIDEO):

1 hour 20 minutes  →  →  →  → 

3 minutes 20 seconds  →  →  →  → 

Example (for Audio CD/Video CD):

3 minutes 20 seconds  →  →  → 

65 minutes 30 seconds  →  →  → 

Playing from specific position on a disc

You can play a disc from the selected track, title or chapter, or from the specified time.



To locate a desired scene from the menu



DVD

DVD discs generally have their own menus which show the disc contents. These menus contain various items such as titles of a movie, names of songs, or artist information, and display them on the TV screen. You can locate a desired scene by using the menu.

- Insert the DVD disc.



About and

A DVD disc which contains more than one title may have a menu which lists the title. In this case, the menu appears on the TV screen by pressing . On the other hand, a DVD disc which contains only one title may have a menu. In this case, the menu appears on the TV screen by pressing .

- 1 Press  or .

The menu appears on the TV screen.

Example

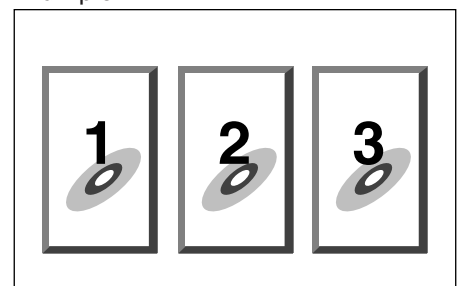





- 2 Use  to select a desired item, then press .

- The unit starts playback of the selected item.



With some discs, you can select items by entering the corresponding number using the numeric buttons, which causes the unit to automatically start playback.

NOTES

- When  appears on the TV screen by pressing  in step 1: The disc does not have a menu listing the titles.
- When  appears on the TV screen by pressing  in step 1: The disc does not have a menu.



To locate the desired scene from the menu of the Video CD with PBC



Some Video CD discs are compatible with the PBC function. PBC is an abbreviation of "PlayBack Control." Video CD disc recorded on PBC have own menus such as the list of the songs of the disc and items recorded in a disc. You can also locate the specific scene by using the menu.

- When the menu appears on the TV screen during playback with PBC



When you play a Video CD disc using the PBC function, "PBC" appears in the display window on the front panel. When the PBC function is not activated, press then press to activate the PBC function. You can also operate from the on-screen display as follows:

1. Press .
2. Use to move to [PBC CALL], then press .

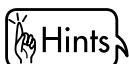

When you want to set the PBC function to off, press the numeric buttons to play a disc. See page 28.

- 1 Use to , to select the desired number of the item.

Example:

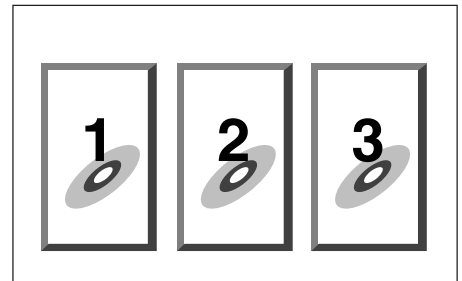

Playback starts from the selected item.

You can return to the menu by pressing .

When "NEXT" or "PREVIOUS" appears on the TV screen, the unit generally works as follows:

- succeeding to the next page by pressing .
- return to the previous page by pressing .

*The method of the operation is different depending on the disc.



To locate a desired scene or track directly



You can play the desired scene or track by specifying the title (for DVDs) or track (for CDs).

- For DVD: During stop mode
- For Audio CD: During playback or stop mode
- For Video CD: During playback without PBC function or stop mode

1 Use to , to select the desired title or track number.

The selected title or track number appears in the display window on the front panel.

Example:

To select title or track number 8: Press .

To select title or track number 37: Press , , , .

Display window

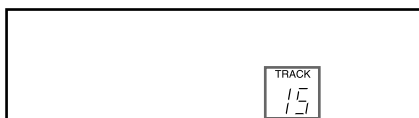

Selected title or track number

- The unit begins playback from the selected title or track.

NOTES

- When appears on the TV screen. The title or track you have selected is not contained in the disc.
- This function does not work during Video CD playback with PBC function



To locate a desired track using



- For Audio CD: During playback or stop mode
- For Video CD: During playback without PBC function

1 Press or .

Display window

- To skip to a succeeding track, press once or repeatedly until the desired track appears in the display.
- To skip to beginning of the current track, press once.
- To skip to a preceding track, press repeatedly until the desired track appears in the display.



Selected track number

NOTE

- This function does not work during Video CD playback with PBC function



You can display the desired title or track number on the TV screen. In this case, press to display the on-screen display.



To locate a desired scene by specifying the chapter number [CHAP. SEARCH]

DVD

Each chapter is usually assigned a chapter number on DVD discs (except Karaoke discs). You can play a desired chapter by selecting the chapter number from the on-screen display.

■ During playback

1 Press .

The on-screen display appears on the TV screen.

2 Use to move to [CHAP. SEARCH], then press .

<GO TO CHAPTER> appears in the message area.

The color of [CHAP. SEARCH] changes.

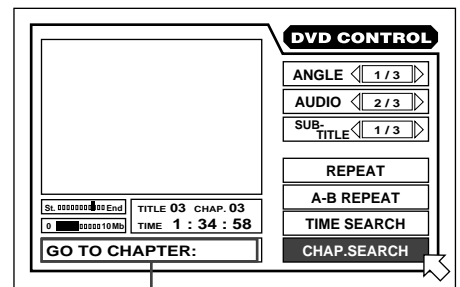

Message area

3 Use to to select the desired chapter number, then press .

Selected chapter number appears in the message area.

Example:

To select chapter number 8: Press > .

To select chapter number 37: Press > > .

■ The unit begins playback from the selected chapter.



and are not used in this function.

NOTES

- **When the chapter number is incorrect in step 3:**
Press to erase the number previously selected, and select the desired number using the numeric buttons.
- **When is displayed in the TV screen in step 3:**
The chapter you have selected is not contained in the disc, or chapter search does not work on the disc.
- **To return to the regular display:**
Press .



To locate the desired scene or position by specifying the time [TIME SEARCH]



You can play a disc from the the desired position by specifying the elapsed time from the beginning of the disc using the TIME SEARCH function.

Note that some DVD discs does not contains time information and you cannot use the TIME SEARCH function.

- For DVD, Audio CD: During playback
- For Video CD: During playback without PBC function

1 Press .

The on-screen display appears on the TV screen.

2 Use to move to [TIME SEARCH], then press .

<GO TO> appears in the message area.
The color of [TIME SEARCH] changes.

3 Use to to specify the time, then press .

Example 1 (for DVD):
To playback from the 1 hour point.

GO TO _ : _ :

↓ Press .

GO TO 1 : _ :

↓
Press .

(for DVD)

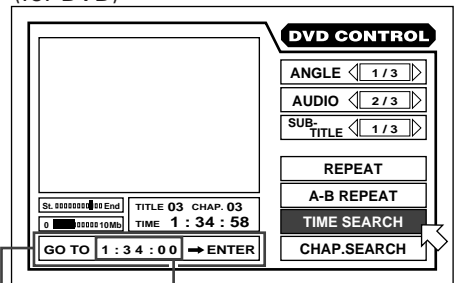

Message area Selected time

(for Audio CD)

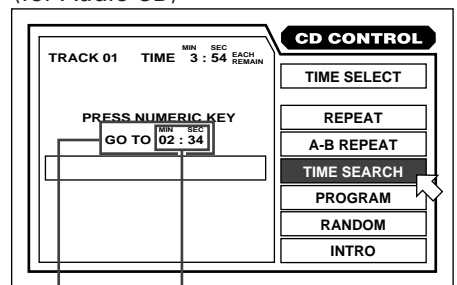

Message area Selected time

(for Video CD)

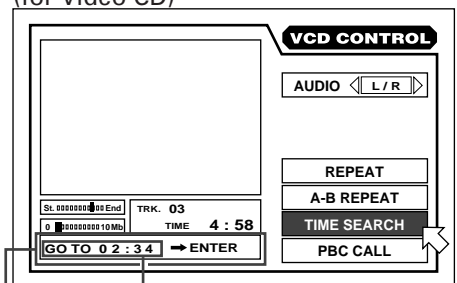

Message area Selected time



and are not used in this function.



You can specify the time in hour/minute/second for DVD discs, and in minute/second for Audio and Video CD discs.

Short cuts

After pressing 4, press



You can input the time by pressing ENTER without pressing 0 twice to input the second value.

Example 2 (for DVD):
To playback from 2 hour 34 minutes:

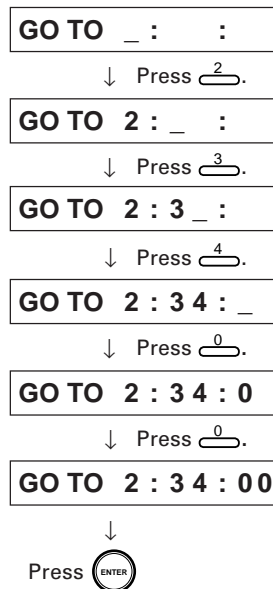

Example 3 (for Audio CD/Video CD):
To playback from 2 minutes 34 seconds.

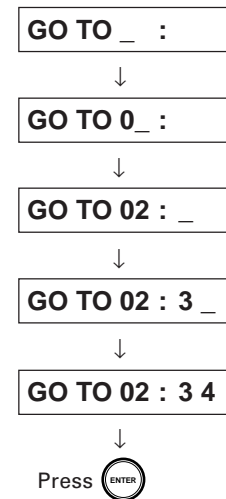

■ The unit starts playback from the selected time.

NOTES

● **When you make a mistake in step 3:**

Move the cursor to the incorrect value, then press the correct value to re-select the value.



● **When a crossed-out circle appears on the TV screen in step 2:**

The time you have selected is not contained on the disc, or the time search function does not work on the disc. When you play a Video CD disc with the PBC function, there are some sections where the time search function does not work.

● **To return to the regular display:**

Press .

● **The time search function does not work during Video CD playback with the PBC function**



To locate a desired scene by watching the opening scene digest display [DIGEST]



The unit can display the opening scene of each title of DVD or each track of Video CD. You can select a desired title or track from the opening scenes displayed on the TV screen.

- For DVD: During stop mode
- For Video CD: During stop mode or playback without PBC function





When you press  during DVD playback, the unit displays the opening scene of each chapter and you can select the desired chapter. In this case, opening scenes are displayed from chapter 1.

1 Press .

The opening scene of each title or track appears on the TV screen. Up to nine opening scenes are displayed.



2 Use to select the desired title.

When the disc contains more than 9 titles or tracks, the digest screen have more than one page. In this case, pressing  turns to the next page, while pressing  returns to the previous page.

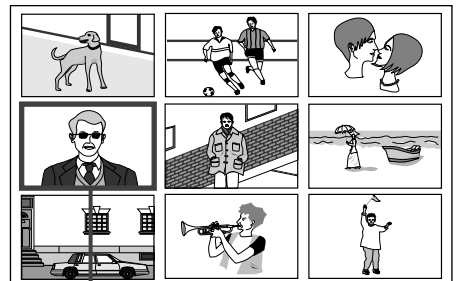



Selected title

3 Press .

- The unit begins playback from the selected title or track.



- When the selected title or track is in the lower right-hand corner of the screen, press  to check the additional scenes.
- When the selected title or track is in the upper left-hand corner of the screen, press  to return to previous scenes.



NOTES

- With some discs, depending on the contents, it may take some time until all the scenes appear on the screen.

Playing in slow-motion

The unit can display a list of the still pictures, and playback a disc in slow-motion. You can view video in more detail by using these functions.





During this function, when you press , the next nine still pictures appear on the TV screen and playback pauses. When you press , nine still pictures continuously appear on the TV screen.

To display still pictures [STROBE]



■ During playback

1 Press  at the point you want to view as a continuous photograph.

2 Press and hold  for more than 1 second.

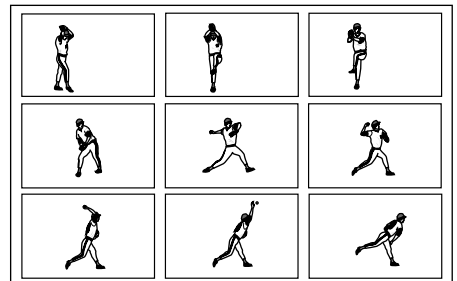

Nine still pictures appear on the TV screen and playback pauses.

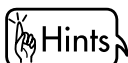

To cancel strobe play

Press and hold  for more than 1 second.



You can enjoy advancing the picture frame-by-frame by pressing  during pause. Each time you press , the picture advances one frame.



You can also use the SHUTTLE knob for slow-motion play.



1. Press  to pause playback.
2. Turn the SHUTTLE knob to the right to play in slow-motion. Turn the SHUTTLE knob to the left to play in slow-motion in reverse (DVD only). You can adjust the playback speed by turning the SHUTTLE knob.

To playback in slow-motion [SLOW]



■ During playback

1 Press , then press  or .

To play in slow-motion, press , and to play reverse slow-motion (DVD only), press . First, the unit plays the slowest speed, and each time you press these buttons, the playback speed increases. To return to normal playback, press .

To pause slow-motion play

Press .

NOTES

- **To cancel slow-motion play**
Press .
- **The sound is muted during slow-motion play.**
- **Reverse slow-motion playback is not possible for a Video CD.**

Playing a scene close-up

The unit can zoom in a part of the scene. You can view any part of the scene close-up.



To playback a scene close-up [ZOOM]



■ During playback or pause

1 Press .

[ZOOM] appears on the TV screen.
The unit zooms in to the center part of the scene to produce a double-sized image.

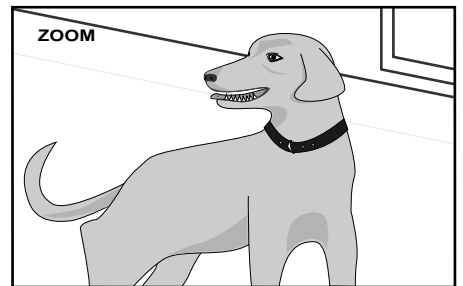
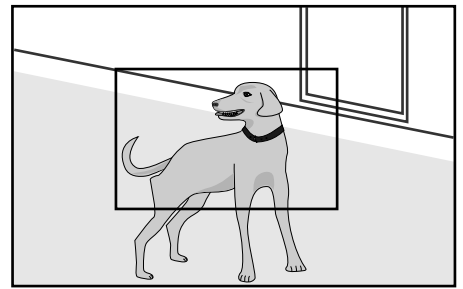

2 Use to move the zoomed-in scene.

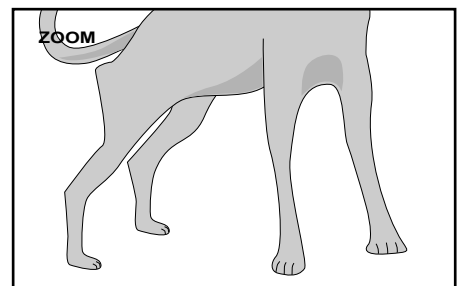

To pause zoom play

Press .

To resume zoom play, press .

NOTE

- **To cancel zoom play**
Press .
- **During zoom play, the picture may be garbled or noisy.**

Changing the track order

You can play tracks on a Audio CD or Video CD in the desired order or in random order.



To playback in the desired order [PROGRAM]



By creating a program, you can enjoy listening to your favorite tracks in any order.

■ During stop mode only

1 Press .

The on-screen display appears on the TV screen.

2 Use to move to [PROGRAM] and press .

The color of "PROGRAM" changes.

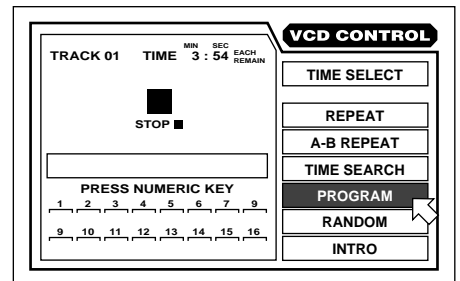

3 Select the tracks in the desired order using to , .

Up to 16 tracks can be programmed. You may select the same track more than once.

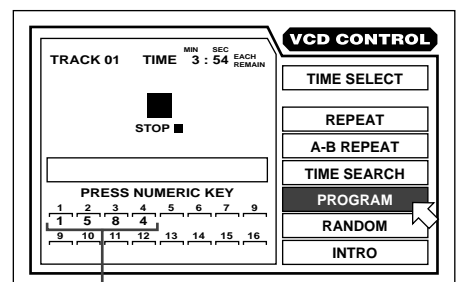

Selected track number

4 Press to start program play.



When all of the programmed tracks have finished playback, the unit stops but the program remains.



You can program tracks during playback.

NOTES

- **When you make a mistake in step 3:**
Press . The last track programmed is erased.
- **To clear program play**
Press to stop playback, then press again. All the programmed tracks are erased.
- **To quit program play**
Move to [PROGRAM] in the display using and press . "PROGRAM" returns to its original color.



To playback tracks in random order [RANDOM]



The unit can play tracks in random order.

■ During stop mode

1 Press .

The on-screen display appears on the TV screen.

2 Use to move to [RANDOM].

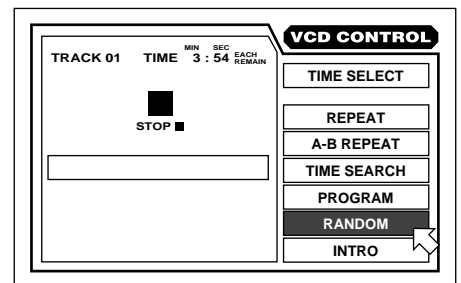

3 Press .

The color of "RANDOM" changes.

■ Random play begins.



- When all tracks have been played once, random play ends.
- The same track will not be played back more than once during random play.

NOTE

- **To stop random play**
Press .
- **To quit random play (Audio CD only)**
Move to [RANDOM], then press . "RANDOM" returns to its original color.

Repeat playback

The unit can repeat playback of the current title, chapter (for DVD) or all tracks or the current tracks (for Audio CD/Video CD) and you can also select the desired part for repeat playback.



To repeat a title, chapter, or current or all track [REPEAT]



- For DVD, Audio CD: During Playback
- For Video CD: During playback without PBC function

1 Press .

The on-screen display appears on the TV screen.

2 Use to move to [REPEAT], then press .

Each time you press , the repeat mode changes as follows:

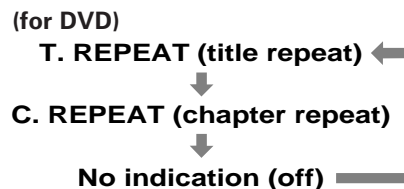

The current title or chapter will be repeated.

(for Audio CD/Video CD)

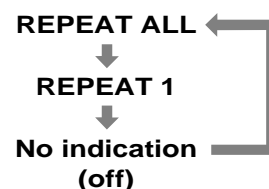

REPEAT ALL:
All the tracks are played repeatedly.

REPEAT 1:
The current track is played repeatedly.

The current track or all tracks is/are played repeatedly.

(for DVD)

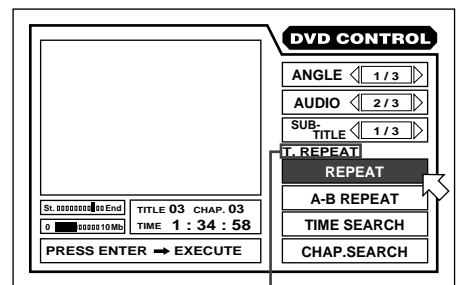

Selected repeat mode appears on the TV screen.

(for Audio CD)

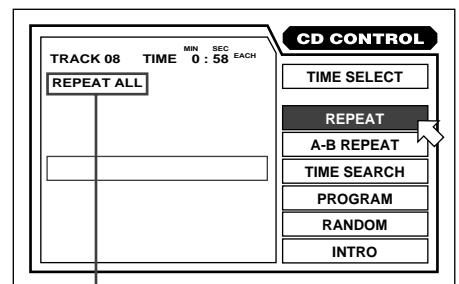

Selected repeat mode

(for Video CD)

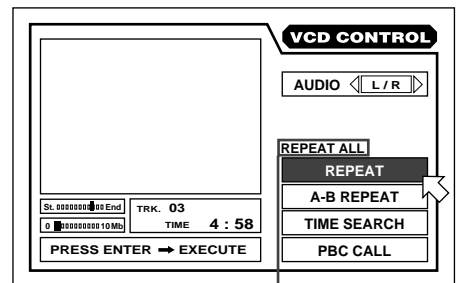

Selected repeat mode

NOTES

- Repeat play function cannot be used during Video CD playback with PBC function. To use this function, press to stop playback and then specify any track number by using the numeric buttons.
- To turn off the on-screen display
Press .
- To stop repeat playback during Audio CD or Video CD playback
Press . The unit stops but remains in repeat play mode.
- To quit repeat playback
Move to [REPEAT] in the on-screen display and press repeatedly until [REPEAT] returns to its original color.
You can also cancel repeat playback by pressing .
- If appears when pressing in step 2 during DVD playback
You cannot repeat the title or chapter because of the disc contents.



To repeat a desired part [A-B REPEAT]



- For DVD, Audio CD: During Playback
- For Video CD: During playback without PBC function

1 Press .

The on-screen display appears on the TV screen.

2 Use to move to [A-B REPEAT], then press at the beginning of the part you want to repeat (point A).

The color of "A-B REPEAT" changes.

3 Press at the end of the part you want to repeat (point B).

The unit locates "A" and starts repeat playback between "A" and "B."

- The selected portion will be repeated.

(for DVD)

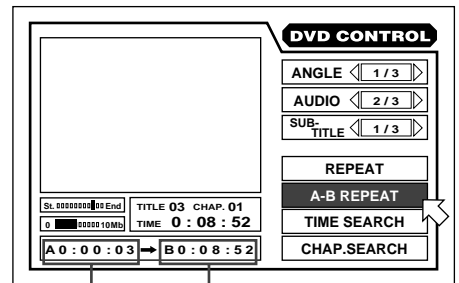

Point A Point B

(for Audio CD)

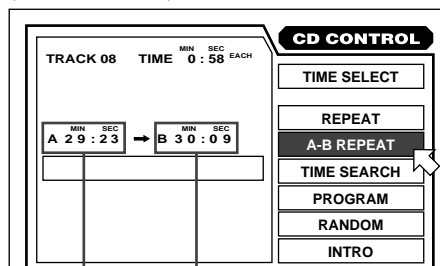

Point A Point B

(for Video CD)

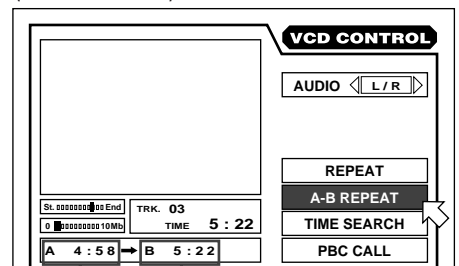

Point A Point B

NOTES

- **To turn off the on screen display**
Press .
- **To quit A-B repeat playback**
Move to [A-B REPEAT] in the on screen display and press until [A-B REPEAT] returns to its original color.
- **To stop A-B repeat playback**
Press .
- **If appears when pressing in step 2 during DVD playback**
You cannot repeat the selected portion because of the disc contents.

Sampling all tracks

You can sample the tracks of an Audio CD or Video CD by playing back to a short segment of each track in order. The unit plays the first 10 seconds of each track.



To playback only the beginning of each track [INTRO]



■ During stop mode

1 Press .

The on-screen display appears on the TV screen.



When all tracks have been played once, INTRO scan quits.

2 Use to move to [INTRO].

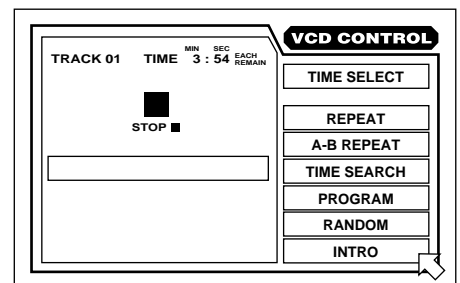

3 Press .

■ The first 10 seconds of each track on a disc are played back in numerical order from the first track.

NOTE

- **To quit INTRO scan (Audio CD only)**
Move to [INTRO], then press . "INTRO" returns to its original color.
- **To stop INTRO scan**
Press .

Viewing from multiple angles

You can enjoy a variety of scene angles if the DVD disc contains “multi angle” parts, where multiple cameras were used to shoot the same scene from different angles. You can select one of these viewing angles from the normal screen or on-screen display.



To select a scene angle from the normal screen [DVD] [ANGLE]

■ During playback

1 Press .

2 Press or to select the desired angle.

Each time you press or , the scene changes.



To select a scene angle from the on-screen display [DVD] [ANGLE]

■ During playback

1 Press .

The on-screen display appears on the TV screen.

2 Use to move to [ANGLE].

The total number of recorded angles

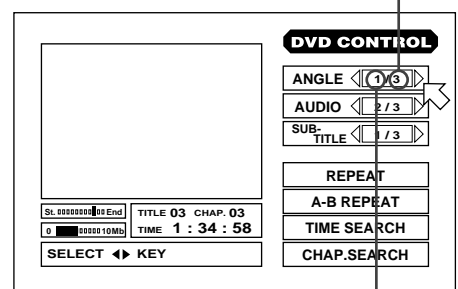

The current angle number

3 Use to select the desired angle number.

Example:

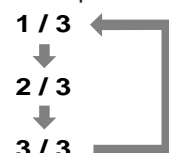

NOTES

- To turn off the on-screen display
Press .
- When appears on the TV screen
The current scene is not recorded from multiple angles.



To select a scene angle from the angle list display [ANGLE]

DVD

■ During playback

1 Press and hold  for more than 1 second.

Up to nine angle scenes recorded on a disc appear on the TV screen.

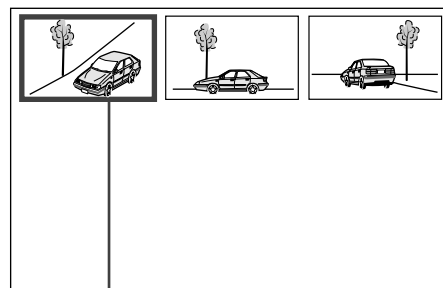

The selected scene angle

2 Use  to select desired angle.

3 Press .

■ The selected angle appears on the TV screen.

NOTE

- When  appears on the TV screen in step 1: The current scene is not recorded from multiple angles.

Changing the language and sound

You can choose the subtitle or audio language from the languages included on a disc and select the sound from a variety of sounds included on a DVD disc.



Short cuts

Press **SUBTITLE** and select the desired subtitle by using .



You can turn the subtitle ON/OFF by pressing **SUBTITLE**. Each time you press **SUBTITLE**, the ON/OFF status is switched. When the subtitle function is ON, the subtitle language appears on the TV screen.



When you select the language, if the abbreviation appears on the TV screen, select the abbreviation corresponding to the desired language. For details on abbreviations, see "Table of languages and their abbreviations" at the end of this instructions.

To select the subtitle language [SUBTITLE]

DVD

■ During playback

1 Press .

The on-screen display appears on the TV screen.

2 Use  to move  to [SUBTITLE].

3 Use  to select the desired subtitle.

Each time you use , the subtitle changes.

Example:

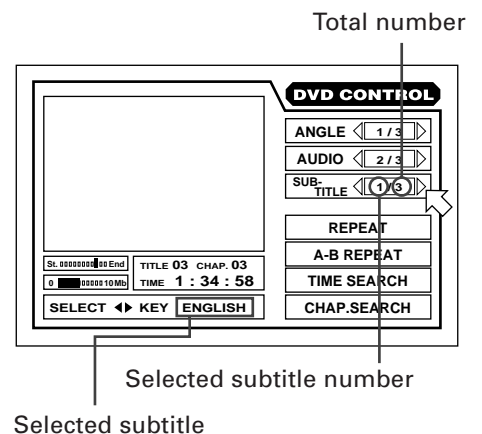
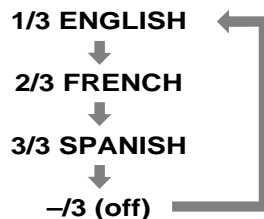

NOTE

- When  appears on the TV screen: You cannot select the subtitle.



To change the audio language or sound selection [AUDIO] DVD

■ During playback

1 Press .

The on-screen display appears on the TV screen.

2 Use to move to [AUDIO].

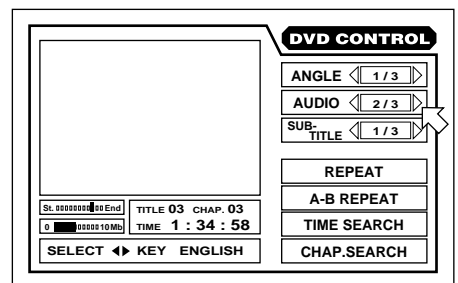

3 Use to select the desired audio language or sound.

Each time you use , the audio language or sound changes.

Example:

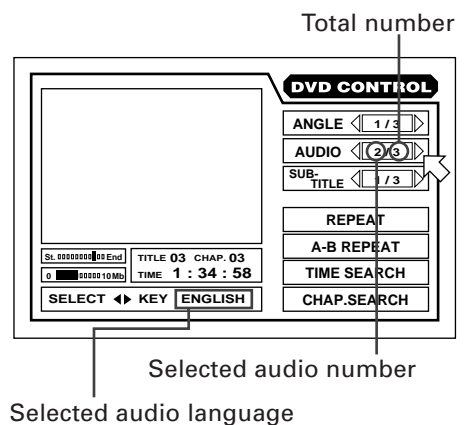
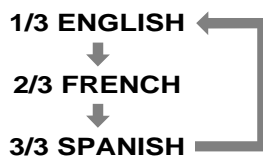

Selected audio language

NOTE

- When appears on the TV screen: You cannot select the audio or sound.



To change the audio channel [AUDIO]

Video CD

In some karaoke Video CDs, one of the audio channels includes a vocal while the other does not. With such discs, you can choose to enjoy karaoke without the vocal or with the vocal by selecting the audio channel to be played back.

■ During playback

1 Press .

The on-screen display appears on the TV screen.

2 Use to move to [AUDIO].

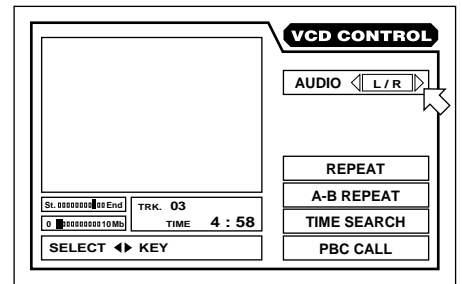

3 Select the audio channel(s) to be played back using .

- L/R:** You hear normal stereo playback.
- L:** You hear the L (Left) channel signal played back from both the left and right speakers.
- R:** You hear the R (Right) channel signal played back from both the left and right speakers.

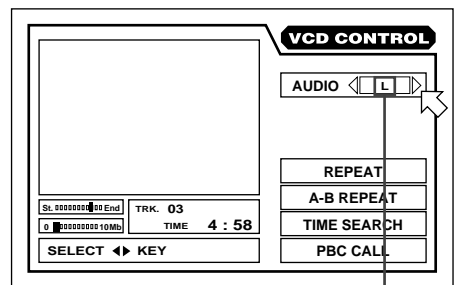

Selected audio channel

NOTE

- To turn off the on-screen display
Press .

Adjusting the picture to suit preferences

You can adjust the picture quality depending on the disc contents.



To adjust the picture quality [VFP]



■ During playback

1 Press or on the front panel.

2 Within 10 seconds, select the desired picture quality by pressing or on the front panel.

Each time you press the button, the picture quality changes as follows:

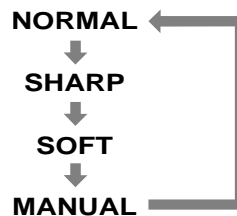

The selected picture quality tab lights up in yellow.

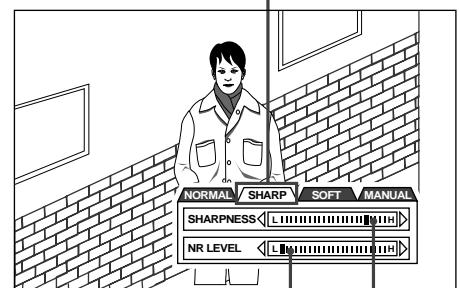

Adjusting bar



If you select [MANUAL], you can adjust the level of picture sharpness and noise reduction.

1. Use to select SHARPNESS or NR LEVEL.
2. Use to adjust the level.
Toward L: Reduce the effect.
Toward H: Enhance the effect.

NOTES

- To turn off the VFP screen, press .
- The VFP screen disappears if there are no operations for more than 10 seconds.

Adjusting the surround sound

You can select a simulated surround effect depending on the disc contents. If you connect the unit to your stereo system, you can enhance sound quality and produce a greater surround effect.



To simulate a surround sound [3D PHONIC]



■ During playback

1 Press .

2 Within 10 seconds, select the desired effect mode by pressing .

Each time you press , the effect mode changes as follows:

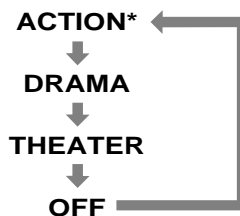

Selected effect mode

* When you play a DVD disc recorded in Dolby Digital which contains more than 3 channels, ACTION does not appear.

3 Press to adjust the effect level.

You can adjust the effect level in 5 level.

Toward L: Reduce the effect
Toward H: Enhance the effect



Effect level

Hints

To turn off the 3D PHONIC screen, press . The 3D PHONIC screen disappears if there are no operations for more than 10 seconds.

NOTES

- The sound effect (3D PHONIC) works correctly when playing back discs recorded with Dolby Surround, Dolby Digital 5.1-CH or MPEG Multichannel 5.1-CH format. It also works when playing back discs other than those above, but does not provide the correct effect.
- The sound effect is not possible, and will not work even if set when the unit outputs a DTS or Dolby Digital or MPEG bitstream signal from the DIGITAL OUT jack.
- The sound effect will not be set or operate, even if is pressed, on the sound of DVD discs recorded in Linear PCM.
- When you set the 3D PHONIC function to on, the DOWN MIX and COMPRESSION setting in the PREFERENCE 2 display and settings in the SPK.SETTING are disabled.

Checking the disc time

You can choose the displayed time mode for an audio or video CD disc in the display on the front panel and in the on-screen display.



To select the time display mode [TIME SELECT]

Audio CD

You can choose the time display mode for an Audio CDs in the display on the front panel and in the on-screen display.

■ During playback

1 Press .

The on-screen display appears on the TV screen.

2 Use to move to [TIME SELECT].

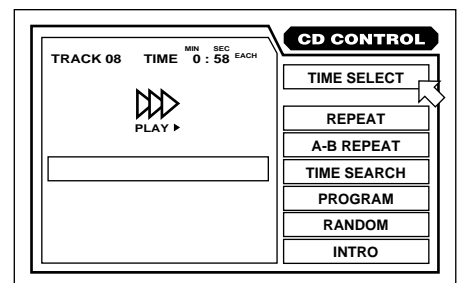

3 Press .

Each time you press , the time mode changes as follows:

EACH

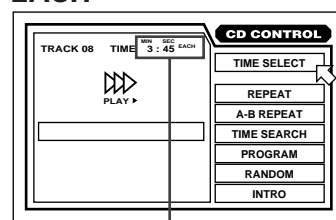

Elapsed time of the current track

EACH REMAIN

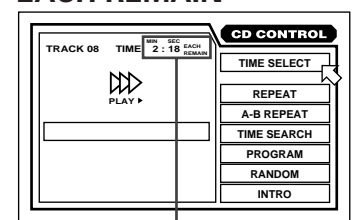

Remaining time of the current track

TOTAL REMAIN

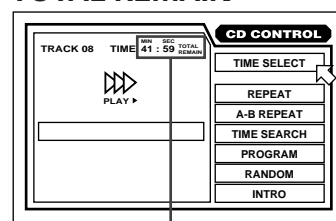

Total remaining time of the disc

TOTAL

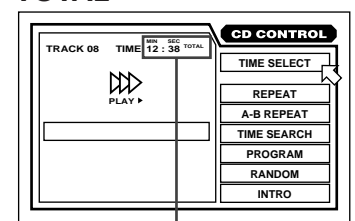

Total elapsed time of the disc



When you select the time mode during stop mode, the time mode changes as follows:

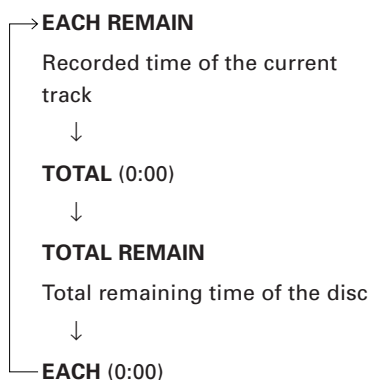



To select the time display mode [TIME SELECT]



You can check the total and each time of a Video CD from the on-screen display on the TV screen or display window on the front panel.

■ During stop mode

1 Press .

The on-screen display appears on the TV screen.

2 Use to move to [TIME SELECT].

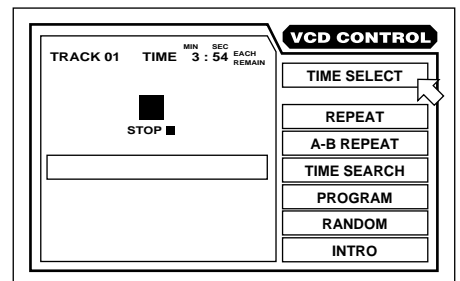

3 Press until [TOTAL REMAIN] appears on the TV screen.

Total disc time appears on the TV screen.

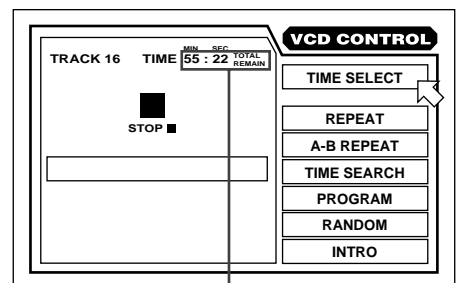

Total disc time of the disc



When you press repeatedly until [EACH REMAIN] appears on the TV screen, the recorded time of the displayed track appears on the TV screen. You can change the track by pressing

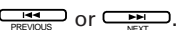

Information about CD TEXT

The unit is compatible with the CD TEXT function. CD TEXT discs have information, such as the album title, artist names, and track names. If the played disc is a CD TEXT disc, CD text data appears on the TV screen.

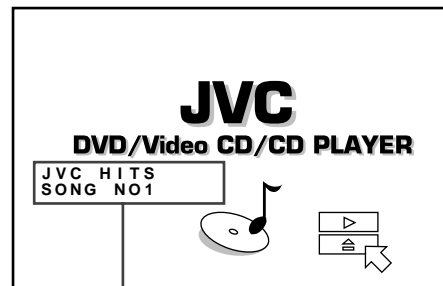

CD TEXT

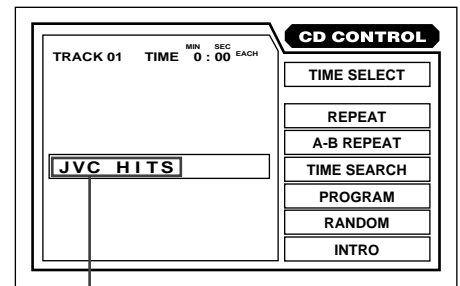

CD TEXT



CD TEXT data also appears in the display window. In this case, each time you press , CD TEXT data and time appears alternately.

What is CD TEXT?



CD TEXT, a new feature of audio CD discs, includes text information for such things as the album title, song titles, and artist names. In addition to audio information.

CD TEXT

NOTES

- The album title, artist names, or track names may not be displayed with some CD TEXT discs.
- When you insert a CD TEXT disc which contains many tracks, the time before the unit is ready for playback is longer than usual. The time is necessary for the unit to read the CD TEXT information, and this is not a malfunction.

Selecting preferences

You can set various preference for DVD via the Preference and Speaker setting display. Select desired items on the Preference 1, Preference 2 and Speaker setting displays, and set them appropriately.



How to set preferences on the "PREFERENCE1/2" and "SPK.SETTING" display

1 Press to stop the unit.

If the current disc is not a DVD disc, you have to remove the disc from the tray before setting up.



For details about each setting, see the following pages:

PREFERENCE 1

- MENU LANGUAGE (51)
- AUDIO LANGUAGE (51)
- SUBTITLE (52)
- ON SCREEN LANGUAGE (52)
- ON SCREEN GUIDE (53)
- MONITOR TYPE (53)

PREFERENCE 2

- DIGITAL AUDIO OUTPUT (54)
- DOWN MIX (55)
- COMPRESSION (55)
- SCREEN SAVER (56)
- AUTO STANDBY (56)

SPK.SETTING (57)

2 Press .

The on-screen display appears on the TV screen. The Preference 1, Preference 2 and Speaker setting displays are available. Use to move to the desired tab.

Preference 1

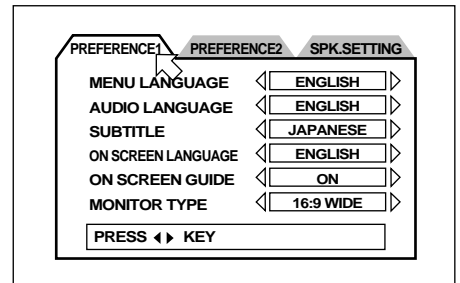

Preference 2

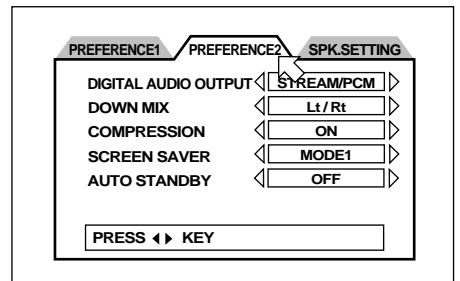

Speaker setting

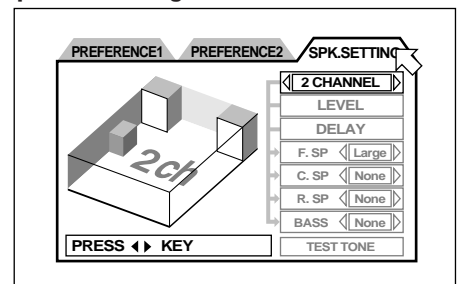

To return to the normal screen,

press .

3 Move to select the item you want to set by using .

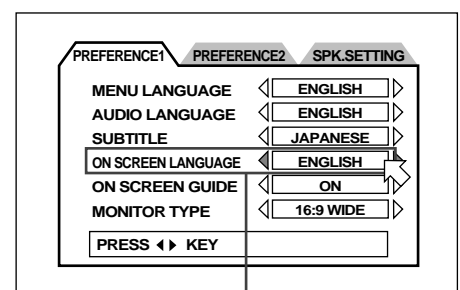

Selected item

4 Press to select the setting you want.

To set the language and display preference items

PREFERENCE 1 can be set as follows:

MENU LANGUAGE

You can select a default “display” language to be displayed if it is contained on the disc.

Each time you press , the language setting changes in the following order:

ENGLISH → SPANISH → FRENCH → CHINESE → GERMAN → ITALIAN → JAPANESE → language code from AA to ZU (See “Table of languages and their abbreviations” at the end of this instructions.)

Pressing  changes the language setting in the reverse order of the above.

* If the selected language is not recorded, the disc’s default display language is displayed.

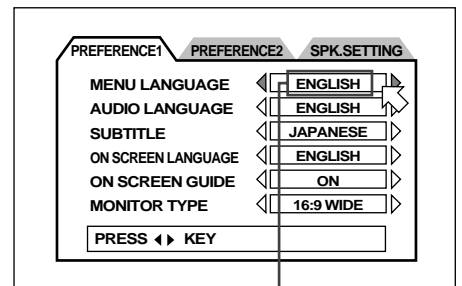

Selected language

AUDIO LANGUAGE

You can select the default audio language to be played if it is contained on the disc.

Each time you press , the language setting changes in the following order:

ENGLISH → SPANISH → FRENCH → CHINESE → GERMAN → ITALIAN → JAPANESE → language code from AA to ZU (See “Table of languages and their abbreviations” at the end of this instructions.)

Pressing  changes the language setting in the reverse order of the above.

* If the selected language is not recorded, the disc’s default audio language is played.

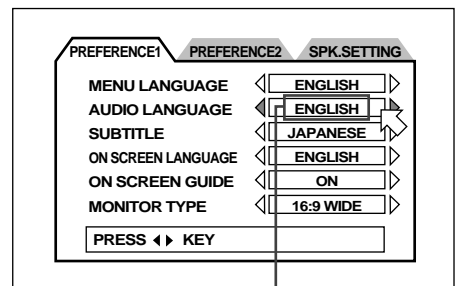

Selected language

SUBTITLE

You can select the default subtitle language to be displayed when it is contained on a playback disc.

Each time you press , the language setting changes in the following order:

ENGLISH → SPANISH → FRENCH → CHINESE → GERMAN → ITALIAN → JAPANESE → language code from AA to ZU (See "Table of languages and their abbreviations" at the end of this instructions.)

Pressing  changes the language setting in the reverse order of the above.

* If the selected language is not recorded, the disc's default subtitle language is displayed.

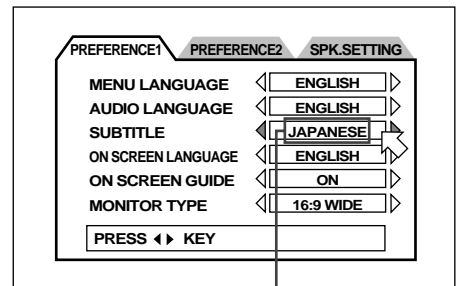

Selected language

ON SCREEN LANGUAGE

You can select the on-screen display language to be displayed.

Each time you press , the language setting changes as follows:

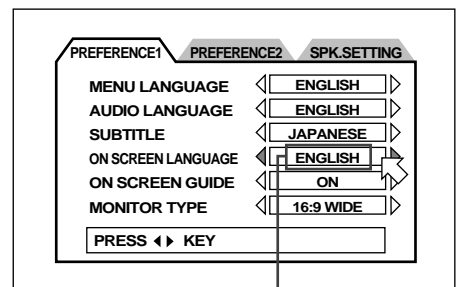
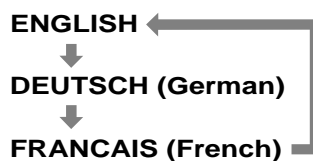

Selected language

English	ON SCREEN LANGUAGE < ENGLISH >
German	BILDSCHIRMMENOE-SPRACHE < DEUTSCH >
French	LANGUE D'ECRAN < FRANCAIS >

ON SCREEN GUIDE

The unit can display "on-screen guide" icons or characters on the picture, which show what is happening to the disc or the unit.

- **ON**
The guide display turns on.
- **OFF**
The guide display turns off.

Examples of "On-screen guide" icons or characters to be off:

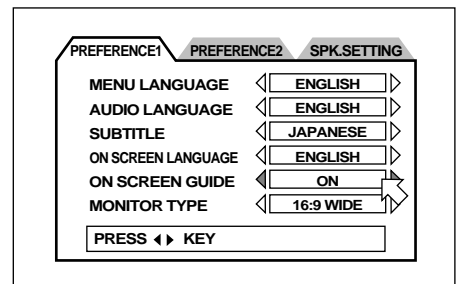

MONITOR TYPE

You can select the monitor type to match your TV when you playback DVD discs recorded for wide screen televisions.

- **4:3 LB** (Letter Box Conversion)
When you connect a normal TV to the unit.
When you play a wide picture recorded on a DVD VIDEO, the picture is displayed with bands across the upper and lower portions of the screen.
- **4:3 PS** (Pan scan Conversion)
When you connect a normal TV to the unit.
When you play a wide picture recorded on a DVD VIDEO, a portion of the picture is automatically cut off from the left and right sides of the image. According to the disc, it may not be possible to playback on this mode. In this case, the picture is played back as in 4:3 LB mode.
- **16:9 WIDE** (Wide Television screen)
When you connect a wide-screen TV to the unit.

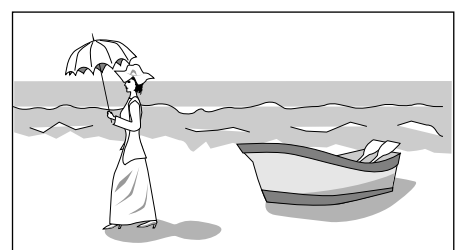
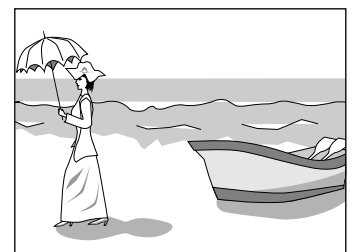

To set other preference items

PREFERENCE 2 can be set as follows:

DIGITAL AUDIO OUTPUT

To connect the unit's digital output to an external amplifier or receiver equipped with a digital input, this item must be set correctly.

- **PCM ONLY:**

When you connect the DIGITAL OUT jack of the unit and the linear PCM digital input of a piece of audio equipment.

- **STREAM/PCM:**

When you connect to the digital input of an amplifier with built-in DTS Dolby Digital, and MPEG Audio decoder.

- **DOLBY DIGITAL/PCM:**

When you connect to the digital input of a Dolby Digital decoder, or an amplifier with built-in Dolby Digital decoder

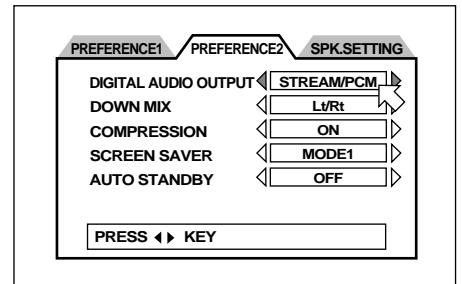

The following chart shows the relationship between types of playback discs and output signals.

Playback discs	Output		
	STREAM/PCM	DOLBY DIGITAL/PCM	PCM ONLY
DVD with 48-kHz, 16-bit linear PCM	48-kHz, 16-bit linear PCM	←	←
DVD with 48-kHz, 20/24-bit linear PCM	48-kHz, 20-bit linear PCM	←	←
DVD with 96-kHz, linear PCM	No output	←	←
DVD with DTS	DTS bitstream	No output	←
DVD with Dolby Digital	Dolby Digital bitstream	←	48-kHz, 16-bit linear PCM
DVD with MPEG audio	MPEG bitstream	48-kHz, 16-bit linear PCM	←
Video CD	44.1-kHz, 16-bit linear PCM	←	←
Audio CD	44.1-kHz, 16-bit linear PCM	←	←
Audio CD with DTS	DTS bitstream	←	←

NOTES

- The unit does not provide the DTS decoding function.
- When playing back an audio CD with DTS, only use a DTS decoder (or an amplifier with a built-in DTS decoder). Playing back such a disc outputs an incorrect signal from the analog output jacks, which may cause damage of speakers. If you connect the analog outputs and digital outputs simultaneously, be sure to select the source of the amplifier correctly, or set the level control of the amplifier connected to the analog outputs to minimum.

DOWN MIX

By setting DOWN MIX correctly, you can get the optimum stereo mix for your audio system from DVD discs recorded with Dolby Digital surround multichannel audio or MPEG Multichannel.

- **Lt/Rt (Dolby Digital disc only):**
You can monitor the unit's audio output signals via an amplifier with built-in Dolby Pro Logic Decoder.
- **L0/R0:**
You can monitor the unit's audio output signals via a TV, an amplifier with no built-in Dolby Pro Logic Decoder, or the unit's headphone jack. Also for recording DVD audio output to a cassette tape, MD, etc.
- **OFF**
When you monitor the unit's 5.1-channel audio output signals via an amplifier equipped with 5.1-channel inputs.

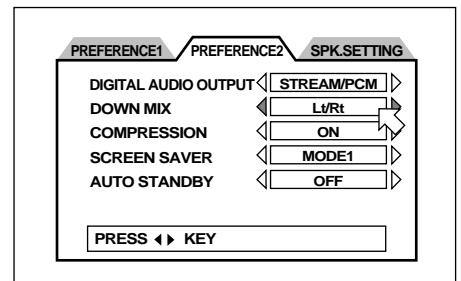

COMPRESSION

You can compress the dynamic range of the sound if you need. Using this function, you can listen to sound at low volumes easily.

- **ON**
Audio is played back with the dynamic range compressed.
- **OFF**
Audio is played back as it was recorded.

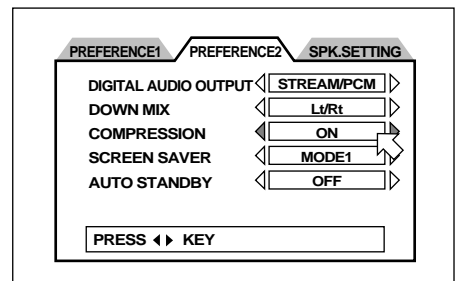

NOTES

- The compression function works only when playing back a disc recorded with DOLBY DIGITAL 1 CH or 2CH. The setting is not effective for other discs.
- The compression function is automatically set to ON when the downmix function is set to Lt/Rt or L0/R0.
- The compression function does not work when the 3D PHONIC function is activated.
- The downmix function does not work when the 3D PHONIC function is activated.

SCREEN SAVER

A television monitor screen may be burned out if a static picture is displayed for a long time. To prevent this, the unit automatically activates the screen saver function if a static picture, such as an on-screen display or menu, is displayed for over 5 minutes.

- **MODE 1**
The picture is scrolled.
- **MODE 2**
The picture is not scrolled.
- **DIMMER**
The picture gets dark.
- **OFF**
The screen saver function is off.

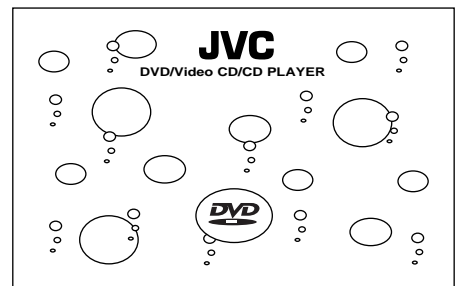
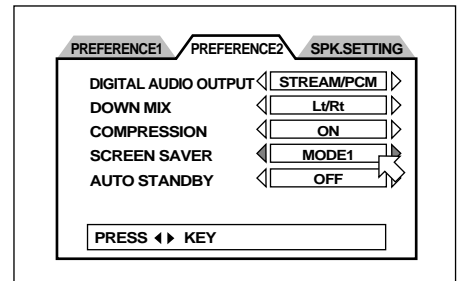

NOTES

- When the screen saver mode is set to DIMMER, the display window on the front panel also gets dark (FL Dimmer). To return to normal brightness, set to another mode.
- The monitor screen of a projector or projection TV is easily to burned out if a static picture is displayed for a long time. Be careful not to allow the monitor screen to be burned out when you set the screen saver mode to OFF.
- The TV screen may be garbled when you set the screen saver mode to MODE 1. In this case, set to another mode.

AUTO STANDBY

When the unit is in stop mode for more than 30 minutes or 60 minutes, the unit enters standby mode automatically.

- **60**
Time is set to 60 minutes.
- **30**
Time is set to 30 minutes.
- **OFF**
The auto standby function is off.

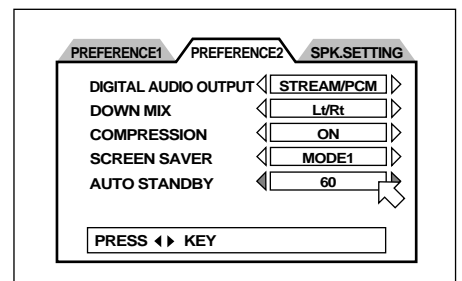



Speaker setting

You can make speaker setting according to your system. Normally, simply select "5.1 CHANNEL" or "2 CHANNEL". However, if you select "EXPERT", you can set various settings to match your speakers.

SPEAKER CHANNELS

You can select the speaker channels according to the speaker system connected to

- **2 CHANNEL**

When you connect to a 2-channel amplifier, or use 2 speakers.

- **5.1 CHANNEL**

When you connect to a 5.1-channel amplifier and use the front, rear, center and sub-woofer speakers.

- **EXPERT**

When you want to set the various settings to match your speakers. The following five setting items are available.

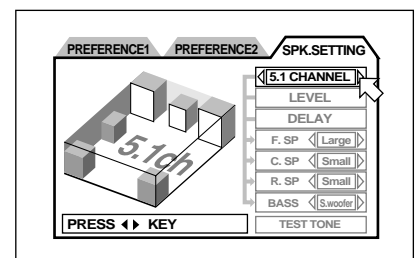

NOTES

- When selecting 5.1 CHANNEL or EXPERT, set DOWN MIX to OFF (see page 57).
- Dolby Digital LFE (Low Frequency Effect) signals are always fed from the SUBWOOFER output on the rear panel of the unit regardless of speaker setting.
- When playing back digital audio output signals of the unit using an external decoder, speaker setting above is invalid. Make setting of the external decoder properly.

1 Speaker size (available only when selecting EXPERT)

Sets the speaker size according to your speakers.

1 Select the speaker to be set using .

- **F.SP:** front speakers
- **C.SP:** center speaker
- **R.SP:** rear speakers

2 Select the size using .

- **Large:** large speaker(s) which can fully reproduce the low-frequency range.
- **Small:** small speaker(s) which can not fully reproduce the low-frequency range.
- **None:** No speaker(s) connected.

If you set the front speakers to "Small", you cannot set the other speakers to "Large".

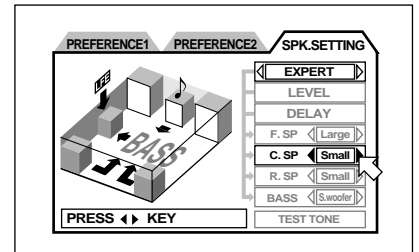

2 Bass redirect (available only when selecting EXPERT)

When you use small speakers which do not fully reproduce the low-frequency range, you can boost up the low-frequency signals of the sub-woofer or front speakers

1 Select [BASS] using .

2 Select Sub-woofer or L/R using .

- **S.woofer:** the low-frequency signals fed from the sub-woofer output are boosted up.
- **L/R:** the low-frequency signals fed from the front speaker output are boosted up.

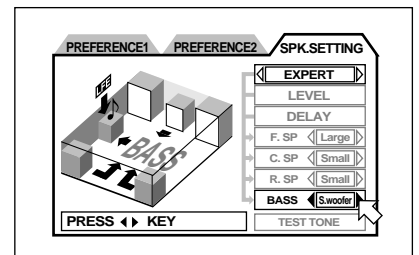

The "Bass redirect" setting is effective only when at least any one of the speaker sizes is set to "Small". If none of them is set to "Small", this setting is not activated ("None" appears in the setting field).

Please note that when playing back a Dolby Digital disc, LFE (Low Frequency Effect) signals are fed from the SUBWOOFER output even if "BASS" shows "None" or "L/R". So you may use a sub-woofer even in such case.

If the front speaker size is set to "Small", the Bass redirect setting is fixed to "S.woofer".

Hints

For the speaker(s) whose size is set to "None", Speaker level and Delay cannot be set ("—" appears in the setting field).

However, when playing back a Dolby Digital disc, LFE signal is output from SUBWOOFER output even if S. WOOFER shows "—", allowing to activate a sub-woofer connected. In such case, adjust the output level using the level control on the sub-woofer.

Hints

Delay of S.WOOFER cannot be set.

3 Speaker level (available only when selecting EXPERT)

You can adjust the output level of each speaker.

1 Select [LEVEL] using , then press . The color of "LEVEL" changes.

2 Select the desired speaker(s) to be set using .

- **F.SP:** front speakers. the level is fixed to 0db.
- **C.SP:** center speaker
- **R.SP:** rear speakers
- **S.WOOFER:** sub-woofer

The setting range is -6 db to +6 db in 1 db units.

3 Set the level using .

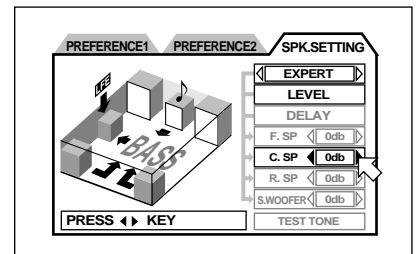

4 Delay (available only when selecting EXPERT)

You can adjust the delay time of each speakers.

1 Select [DELAY] using , then press . The color of "DELAY" changes.



2 Select the desired speaker(s) to be set using .

- **F.SP:** front speakers. the delay is fixed to 0ms.
- **C.SP:** center speaker (selectable from 0 to -5 mS in 1 mS units)
- **R.SP:** rear speakers (selectable from 0 mS, -5mS, -10 mS, and -15 mS)

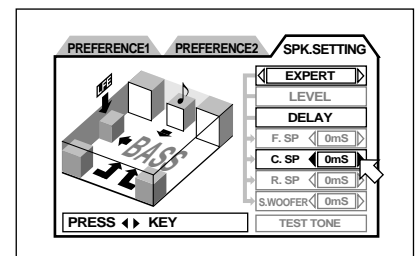
3 Set the delay time using .



NOTES

- **To exit the speaker level (or delay) setting mode**
Move  to [LEVEL] (or [DELAY]) in the on-screen display and press  until [LEVEL] (or [DELAY]) returns to its original color.



In Test tone mode, you hear pink noise, which includes all frequencies in the audible range, from the speakers. This is not a malfunction.



The test tone is not output from the SUBWOOFER output.

5 Test tone (available only while setting LEVEL or DELAY)

You can check the level or delay setting by monitoring the test tone.

1 Select [TEST TONE] using , then press .
The color of "TEST TONE" changes.

2 Select the desired speaker(s) using .

- **F.SP:** front speakers
- **C.SP:** center speaker
- **R.SP:** rear speakers

After selecting the Test tone, if you do not move the cursor, the test tone is output from each speaker one by one.

In Test tone mode, if you move down from "R.SP" position, the test tone continues to output from the rear speakers as long as is any position other than "F.SP" and "C.SP". Similarly, if you move up from "F.SP" position, the test tone continues to output from the front speakers as long as is any position other than "C.SP" and "R.SP".

3 Set the level or delay using again, if necessary.

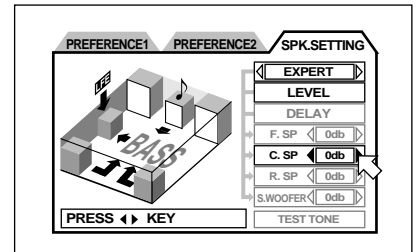

NOTES

- **To exit the test tone mode**
Move to [TEST TONE] in the on-screen display and press until [TEST TONE] returns to its original color.

Limiting playback by children

This function restricts playback of DVD discs which contain violent (and other) scenes according to the level set by the user. For example, if a movie which includes violent scenes supports the parental lock feature, such scenes which you do not want to let children view can be cut or replaced with other scenes.



To set Parental Lock for the first time [PARENTAL LOCK] DVD

1 Press while holding down .

If the current disc is not a DVD disc, you have to remove the disc from the tray before setting up.

The Parental Lock on-screen display appears on the TV screen.

(The parental lock function is only operated with the remote control unit.)

2 Use to select country code and press .

(See "Country code list for parental lock" at the end of this instructions.)

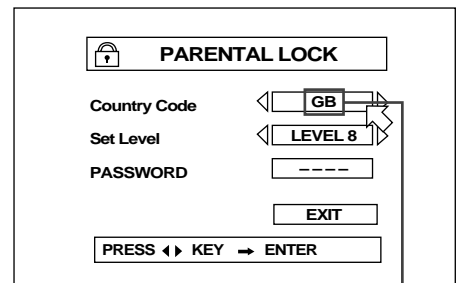

Country code



"LEVEL 1" is the strictest level.

3 Use to select the parental lock level.

Each time you press , the parental level changes from LEVEL 1 to LEVEL 8.

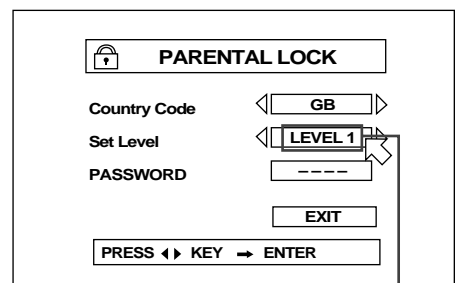

Selected level

4 Press .

5 Enter your 4-digit password using to and press .

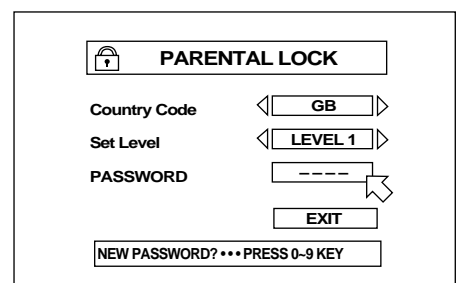

■ The parental level and password are set.



To change the settings [PARENTAL LOCK]

DVD

1 Press while holding down .

If the current disc is not a DVD disc, you have to remove the disc from the tray before setting up.

The Parental Lock on-screen display appears on the TV screen.

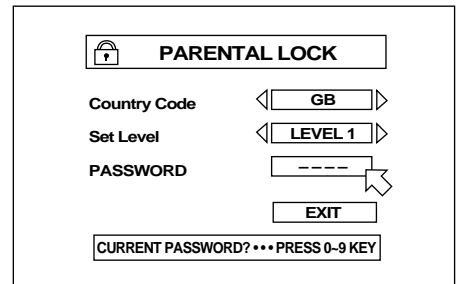

2 Enter your current 4-digit password using to and press .

If you enter the wrong password, <WRONG! RETRY.....> appears on the TV screen, and you cannot go to next step.

3 Use to move to [Set Level], then use to select the parental lock level.

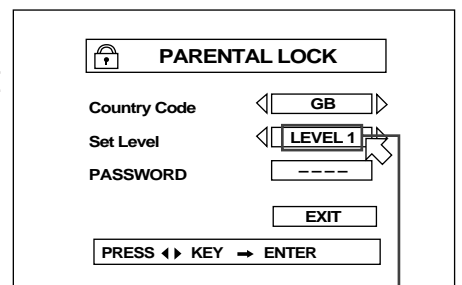

Selected level

4 Press .

5 Enter your new 4-digit password using to and press .

■ The new setting is effective.

NOTES

- When you enter the wrong password more than 3 times in step 2 above, moves to <EXIT> automatically and does not work.
- If you forget your password in step 2 Enter "8888."



To temporarily release the Parental lock [PARENTAL LOCK]

DVD

When you set the parental level strictly, some discs may not be played back at all. When you insert such a disc and try to play it, the Parental Lock on-screen display appears on the TV screen, and the unit will ask you whether you want the parental lock to be temporarily released or not.

1 Use the to select [YES] or [NO], then press .

If you select [YES], moves to the PASSWORD field.

When selecting [NO], press button to remove the disc.

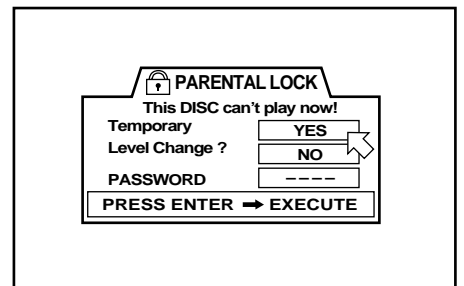

2 Enter your 4-digit password using to .

If you enter the wrong password, "WRONG! RETRY..." appears on the TV screen, and you cannot go to next step.

- The Parental lock is released, and the unit starts playback.

NOTE

- When you enter the wrong password more than 3 times in step 2 above, moves to <NO> automatically and does not work.

Care and handling of discs

How to handle discs

When handling a disc, do not touch the surface of the disc.

Since discs are made of plastic, they are easily damaged. If a disc gets dirty, dusty, scratched or warped, the images and sound will not be picked up correctly, and such a disc may cause the player to malfunction.

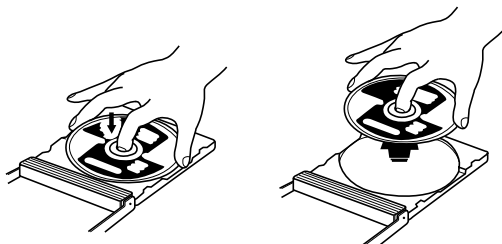

Even on label side

Do not damage the label side, stick paper to or use any adhesive on its surface.

Storage

Make sure that discs are kept in their cases. If discs are piled on top of one another without their protective cases, they can be damaged. Do not put discs in a location where they may be exposed to direct sunlight, or in a place where the humidity or temperature is high. Avoid leaving discs in your car!

Maintenance of discs

If there are fingerprints or other dirt adhering to a disc, wipe with a soft dry cloth, moving from the center outwards. If a disc is difficult to clean, wipe with a cloth moistened with water. Never use record cleaners, petrol, alcohol or any anti-static agents.

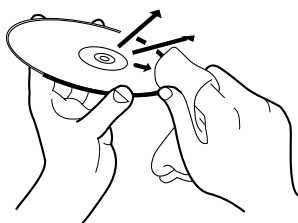

CAUTION

Sometimes during play noise or images may be garbled. This is sometimes due to the disc. (It may not be up to industry standards.)

These symptoms are caused by the discs, not by the malfunction of the unit.

Troubleshooting

What appears to be a malfunction may not always be serious. Please go through the following list before requesting service.

Symptom	Possible case	Remedy
Power does not come on.	Power plug is not inserted securely.	Plug in securely.
Remote control does not work.	Too far from the unit	Move closer to the unit.
	The tip of the remote unit is not pointed in the right direction.	Point the infrared light-emitting window toward the remote sensor on the front panel.
	Batteries are exhausted.	Replace the batteries with new ones.
	Battery polarity is incorrect.	Take out the batteries and insert them again in the correct direction.
No picture is displayed on the monitor.	Connection of video cable is incorrect.	Connect the cable correctly.
	Input selection of TV is incorrect.	Select correctly.
	Disc is not playable.	Use a playable disc. (See page 11.)
Picture is noisy.	The unit is connected to a VCR directly and the copyguard function is activated.	Connect the unit so that the picture signal flows directly to the TV.
No audio is reproduced.	Connection to stereo system is incorrect.	Check the connections.
	Input selection of amplifier is incorrect.	Select correctly.
	The unit is connected only using DIGITAL OUT jack.	Connect the unit using AUDIO OUT jack also.
No sound from headphones.	PHONES LEVEL is too low.	Adjust the PHONES LEVEL.
Sound is distorted or noise is generated.	Disc is dirty.	Wipe the disc surface.
Picture is garbled.	The screen saver mode is set to MODE 1, and the screen saver function is activated.	Set the screen saver mode to the other mode.
Picture does not fit the television screen.	MONITOR TYPE is not correctly set.	Select monitor type correctly. (See page 53).
	Television is not correctly set.	Set the television correctly.
Operation is not possible	Microcomputer malfunctions due to lightning or static electricity.	Turn off the power and unplug the power cord, then connect the power cord again.
	Moisture condensation occurs by a sudden change of temperature or humidity.	Turn off the power, then turn it on a few hours later.

Specifications

General

Readable discs: DVD VIDEO, Audio CD, Video CD
Video format: PAL

Other

Power requirements: AC 230V ~ , 50Hz
Power consumption: 28 W (POWER ON), 2 W (STANDBY mode)
Mass: 4.5 kg (10.0 lbs)
Dimensions (W x H x D): 435 x 112 x 335 mm
17-3/16 x 4-7/16 x 13-1/4 inch

Video output

VIDEO OUT (pin jack): 1.0 Vp-p (75 ohms)
S-VIDEO OUT (S jack): Y Output: 1.0 Vp-p (75 ohms)
C Output: 286 mVp-p (75 ohms)
Horizontal resolution: 500 Lines
Signal to noise ratio: 65 dB

Audio output

ANALOG OUT (pin jack):
FRONT 2.0 Vrms (10 k ohms)
REAR 2.0 Vrms (10 k ohms)
CENTER 2.0 Vrms (10 k ohms)
SUB WOOFER 1.0 Vrms (10 k ohms)
DIGITAL OUT:
OPTICAL - 21 to -15 dBm (Peak)
COAXIAL 0.5 Vp-p (75 ohms Terminate)

Audio characteristics

Frequency response: CD (sampling frequency 44.1 kHz): 2 Hz to 20 kHz
DVD (sampling frequency 48 kHz): 2 Hz to 22 kHz
DVD (sampling frequency 96 kHz): 2 Hz to 44 kHz
Dynamic range: 16 bit: More than 99 dB
20 bit: More than 108 dB
24 bit: More than 108 dB
Wow and flutter: Unmeasurable (less than $\pm 0.002\%$)
Total harmonic distortion: Less than 0.002%

Supplied accessories

Audio/video cable: 1
S-video cable: 1
Audio cable: 2
Remote Control Unit: 1
R6P(SUM-3)/AA(15F) batteries: 2
Instructions: 1

* Specifications and appearance are subject to change without prior notice.

Appendix A: Table of languages and their abbreviations

When you select the subtitle language or sound, the languages shown below are displayed as abbreviations. To select the desired language, select the abbreviation corresponding the language you want to.

AA	Afar
AB	Abkhazian
AF	Afrikaans
AM	Ameharic
AR	Arabic
AS	Assamese
AY	Aymara
AZ	Azerbaijani
BA	Bashkir
BE	Byelorussian
BG	Bulgarian
BH	Bihari
BI	Bislama
BN	Bengali, Bangla
BO	Tibetan
BR	Breton
CA	Catalan
CO	Corsican
CS	Czech
CY	Welsh
DA	Danish
DZ	Bhutani
EL	Greek
EO	Esperanto
ET	Estonian
EU	Basque
FA	Persian
FI	Finnish
FJ	Fiji
FO	Faroese
FY	Frisian
GA	Irish
GD	Scots Gaelic
GL	Galician
GN	Guarani
GU	Gujarati
HA	Hausa
HI	Hindi
HR	Croatian
HU	Hungarian
HY	Armenian
IA	Interlingua
IE	Interlingue

IK	Inupiak
IN	Indonesian
IS	Icelandic
IW	Hebrew
JI	Yiddish
JW	Javanese
KA	Georgian
KK	Kazakh
KL	Greenlandic
KM	Cambodian
KN	Kannada
KO	Korean (KOR)
KS	Kashmiri
KU	Kurdish
KY	Kirghiz
LA	Latin
LN	Lingala
LO	Laothian
LT	Lithuanian
LV	Latvian, Lettish
MG	Malagasy
MI	Maori
MK	Macedonian
ML	Malayalam
MN	Mongolian
MO	Moldavian
MR	Marathi
MS	Malay (MAY)
MT	Maltese
MY	Burmese
NA	Nauru
NE	Nepali
NL	Dutch
NO	Norwegian
OC	Occitan
OM	(Afan) Oromo
OR	Oriya
PA	Panjabi
PL	Polish
PS	Pashto, Pushto
PT	Portuguese
QU	Quechua
RM	Rhaeto-Romance

RN	Kirundi
RO	Rumanian
RU	Russian
RW	Kinyarwanda
SA	Sanskrit
SD	Sindhi
SG	Sangho
SH	Serbo-Croatian
SI	Singhalese
SK	Slovak
SL	Slovenian
SM	Samoan
SN	Shona
SO	Somali
SQ	Albanian
SR	Serbian
SS	Siswati
ST	Sesotho
SU	Sundanese
SV	Swedish
SW	Swahili
TA	Tamil
TE	Telugu
TG	Tajik
TH	Thai
TI	Tigrinya
TK	Turkmen
TL	Tagalog
TN	Setswana
TO	Tonga
TR	Turkish
TS	Tsonga
TT	Tatar
TW	Twi
UK	Ukrainian
UR	Urdu
UZ	Uzbek
VI	Vietnamese
VO	Volapuk
WO	Wolof
XH	Xhosa
YO	Yoruba
ZU	Zulu

Appendix B: Country code list for parental lock

This list is used for the parental Lock operation. For details, see page 61.

AD	Andorra
AE	United Arab Emirates
AF	Afghanistan
AG	Antigua and Barbuda
AI	Anguilla
AL	Albania
AM	Armenia
AN	Netherlands Antilles
AO	Angola
AQ	Antarctica
AR	Argentina
AS	American Samoa
AT	Austria
AU	Australia
AW	Aruba
AZ	Azerbaijan
BA	Bosnia and Herzegovina
BB	Barbados
BD	Bangladesh
BE	Belgium
BF	Burkina Faso
BG	Bulgaria
BH	Bahrain
BI	Burundi
BJ	Benin
BM	Bermuda
BN	Brunei Darussalam
BO	Bolivia
BR	Brazil
BS	Bahamas
BT	Bhutan
BV	Bouvet Island
BW	Botswana
BY	Belarus
BZ	Belize
CA	Canada
CC	Cocos (Keeling) Islands
CF	Central African Republic
CG	Congo
CH	Switzerland
CI	Côte d'Ivoire
CK	Cook Islands
CL	Chile

CM	Cameroon
CN	China
CO	Colombia
CR	Costa Rica
CU	Cuba
CV	Cape Verde
CX	Christmas Island
CY	Cyprus
CZ	Czech Republic
DE	Germany
DJ	Djibouti
DK	Denmark
DM	Dominica
DO	Dominican Republic
DZ	Algeria
EC	Ecuador
EE	Estonia
EG	Egypt
EH	Western Sahara
ER	Eritrea
ES	Spain
ET	Ethiopia
FI	Finland
FJ	Fiji
FK	Falkland Islands (Malvinas)
FM	Micronesia (Federated States of)
FO	Faroe Islands
FR	France
FX	France, Metropolitan
GA	Gabon
GB	United Kingdom
GD	Grenada
GE	Georgia
GF	French Guiana
GH	Ghana
GI	Gibraltar
GL	Greenland
GM	Gambia
GN	Guinea
GP	Guadeloupe
GQ	Equatorial Guinea

GR	Greece
GS	South Georgia and the South Sandwich Islands
GT	Guatemala
GU	Guam
GW	Guinea-Bissau
GY	Guyana
HK	Hong Kong
HM	Heard Island and McDonald Islands
HN	Honduras
HR	Croatia
HT	Haiti
HU	Hungary
ID	Indonesia
IE	Ireland
IL	Israel
IN	India
IO	British Indian Ocean Territory
IQ	Iraq
IR	Iran (Islamic Republic of)
IS	Iceland
IT	Italy
JM	Jamaica
JO	Jordan
JP	Japan
KE	Kenya
KG	Kyrgyzstan
KH	Cambodia
KI	Kiribati
KM	Comoros
KN	Saint Kitts and Nevis
KP	Korea, Democratic People's Republic of
KR	Korea, Republic of
KW	Kuwait
KY	Cayman Islands
KZ	Kazakhstan
LA	Lao People's Democratic Republic
LB	Lebanon
LC	Saint Lucia

LI	Liechtenstein
LK	Sri Lanka
LR	Liberia
LS	Lesotho
LT	Lithuania
LU	Luxembourg
LV	Latvia
LY	Libyan Arab Jamahiriya
MA	Morocco
MC	Monaco
MD	Moldova, Republic of
MG	Madagascar
MH	Marshall Islands
ML	Mali
MM	Myanmar
MN	Mongolia
MO	Macau
MP	Northern Mariana Islands
MQ	Martinique
MR	Mauritania
MS	Montserrat
MT	Malta
MU	Mauritius
MV	Maldives
MW	Malawi
MX	Mexico
MY	Malaysia
MZ	Mozambique
NA	Namibia
NC	New Caledonia
NE	Niger
NF	Norfolk Island
NG	Nigeria
NI	Nicaragua
NL	Netherlands
NO	Norway
NP	Nepal
NR	Nauru
NU	Niue
NZ	New Zealand
OM	Oman
PA	Panama

PE	Peru
PF	French Polynesia
PG	Papua New Guinea
PH	Philippines
PK	Pakistan
PL	Poland
PM	Saint Pierre and Miquelon
PN	Pitcairn
PR	Puerto Rico
PT	Portugal
PW	Palau
PY	Paraguay
QA	Qatar
RE	Réunion
RO	Romania
RU	Russian Federation
RW	Rwanda
SA	Saudi Arabia
SB	Solomon Islands
SC	Seychelles
SD	Sudan
SE	Sweden
SG	Singapore
SH	Saint Helena
SI	Slovenia
SJ	Svalbard and Jan Mayen
SK	Slovakia
SL	Sierra Leone
SM	San Marino
SN	Senegal
SO	Somalia
SR	Suriname
ST	Sao Tome and Principe
SV	El Salvador
SY	Syrian Arab Republic
SZ	Swaziland
TC	Turks and Caicos Islands
TD	Chad
TF	French Southern Territories
TG	Togo
TH	Thailand

TJ	Tajikistan
TK	Tokelau
TM	Turkmenistan
TN	Tunisia
TO	Tonga
TP	East Timor
TR	Turkey
TT	Trinidad and Tobago
TV	Tuvalu
TW	Taiwan, Province of China
TZ	Tanzania, United Republic of
UA	Ukraine
UG	Uganda
UM	United States Minor Outlying Islands
US	United States
UY	Uruguay
UZ	Uzbekistan
VA	Vatican City State (Holy See)
VC	Saint Vincent and the Grenadines
VE	Venezuela
VG	Virgin Islands (British)
VI	Virgin Islands (U.S.)
VN	Vietnam
VU	Vanuatu
WF	Wallis and Futuna Islands
WS	Samoa
YE	Yemen
YT	Mayotte
YU	Yugoslavia
ZA	South Africa
ZM	Zambia
ZR	Zaire
ZW	Zimbabwe

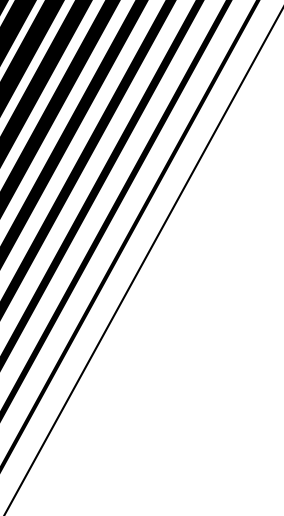

JVC
VICTOR COMPANY OF JAPAN, LIMITED

Free Manuals Download Website

<http://myh66.com>

<http://usermanuals.us>

<http://www.somanuals.com>

<http://www.4manuals.cc>

<http://www.manual-lib.com>

<http://www.404manual.com>

<http://www.luxmanual.com>

<http://aubethermostatmanual.com>

Golf course search by state

<http://golfingnear.com>

Email search by domain

<http://emailbydomain.com>

Auto manuals search

<http://auto.somanuals.com>

TV manuals search

<http://tv.somanuals.com>